

LOW-VOLUME ROADS ENGINEERING



Best Management Practices Field Guide



Gordon Keller
&
James Sherar

Low-Volume Roads Engineering

Best Management Practices Field Guide

By

Gordon Keller, PE

Geotechnical Engineer
USDA, Forest Service
Plumas National Forest, California

and

James Sherar, PE

Logging Engineer
USDA, Forest Service
National Forests of North Carolina



Produced for
US Agency for International Development (USAID)



In Cooperation with
USDA, Forest Service, International Programs
&
Conservation Management Institute,
Virginia Polytechnic Institute and State University



July 2003



Information contained in this document has been developed for the guidance of road builders, road managers, and resource specialists in most geographic areas to help build better, more cost-effective roads, and roads that minimize adverse environmental impacts and protect water quality. The U.S. Department of Agriculture (USDA) or U.S. Agency for International Development (USAID) assumes no responsibility for the interpretation or use of this information. The use of trade, firm, or corporation names is for the information and convenience of the reader. Such use does not constitute an official evaluation, conclusion, recommendation, endorsement, or approval of any product or service to the exclusion of others that may be suitable.

The U.S. Department of Agriculture and U.S. Agency for International Development prohibit discrimination in all their programs and activities on the basis of race, color, national origin, sex, religion, age, disability, political beliefs, sexual orientation, or marital or family status. (Not all prohibited bases apply to all programs.) Persons with disabilities who require alternative means for communication of program information (braille, large print, audiotape, etc.) should contact USDA's TARGET Center at (202)-720-2600 (voice and TDD).

To file a complaint of discrimination, write USDA, Director, Office of Civil Rights, Room 326-W, Whitten Building, 1400 Independence Avenue, SW, Washington, D.C. 20250-9410, or call (202) 720-5964 (voice and TDD). USDA is an equal opportunity provider and employer.



United States
Department of
Agriculture

Forest
Service

Plumas
National
Forest

159 Lawrence Street
P.O. Box 11500
Quincy, CA 95971-6025
(530) 283-2050

File 7100

Date: January 5, 2010

Subject: Low-Volume Roads Engineering Best Management Practices Field Guide

To: Interested Colleagues and Supporters

Enclosed is a copy of our final printed Low-Volume Roads Engineering Best Management Practices Field Guide. It has been recently published by Virginia Polytechnic Institute and State University. This BMP Field Guide is a companion document to our more comprehensive "Minimum Impact Low-Volume Roads Manual" that is currently being rewritten in English. Although this Guide was intended for international use, as the photos reflect, it was developed based upon a great deal of rural roads experience both domestically and internationally. Thus it has a wide application.

The basic objective of this Low-Volume Roads Engineering Best Management Practices Field Guide is to present a summary of "Do's and Don'ts" for road engineering, with Recommended Practices to Follow and Practices to Avoid. Use of this information will help protect water quality and reduce adverse environmental impacts. The recommendations are sound road engineering practices that can result in environmentally "friendly", storm resistant, cost-effective roads. This overview of important road design information should be particularly useful to road managers, inspectors, environmental regulators, program administrators, and resource specialists involved with roads. Also it will serve as a summary of good practices for road designers and builders.

We hope that this document will be very useful to the US Agency for International Development (USAID), US Forest Service, and other agencies and individuals involved with low-volume roads work. A 2 to 5-day training course on Minimum Impact Low-Volume Roads Engineering has also been developed around the contents of our manuals. We appreciate any thoughts or comments you may have on the application of this information, as well as support you can offer for this work.

Thank you for your interest in this project. A limited number of these manuals are currently available upon request. Additional copies may be printed in the future depending upon demand and funding support. Please call me at (530) 283-2050 or (530) 283-7747 or send E-mail to gkeller@fs.fed.us if you have comments or need additional information.

Respectfully,

/s/ Gordon Keller

GORDON KELLER, PE, GE
Geotechnical Engineer

ERRATA: The color quality on some photos in the printed Guide is much less clear than in the CD version. Also text was deleted from three captions during last-minute formatting. Photo 4.5 text should end with "...Use road surfacing materials as frequently as possible to reduce erosion and improve the roadbed structural support and rider comfort". Page 40, Fifth Bullet, should be Figure 7.11 vs 7.10. Photo 6.7 text should end with "...Note that the road is poorly located so close to the stream". Figure 7.2, upper figure, text is "a. Basic road surface drainage with outsloping, rolling grades, and reinforced dips". Photo 11.4 text should be "...(steeper than 1 1/2:1)". Chapter 11, mid-first paragraph should read "...cut slopes in most soils...about a 1:1 or 3/4:1...slope." Last, in Chapter 9-Fords, Page 95, the last Recommended Practice, "Constructing sharp vertical curves on fords..." should be a Practice to Avoid! Our apologies for the errors!



Good News! (updated January, 2010)

Our "Low-Volume Roads Engineering Best Management Practices Field Guide" is available, both in English and Spanish, on several Web sites. The primary site with both versions is the USDA, Forest Service International Programs website, under Sustainable Forestry Practices (in the Practitioner's Toolbox--scroll down to the bottom of the box for the Spanish version) at:

<http://www.fs.fed.us/global/topic/welcome.htm#8>

The Guide is also available at the Websites listed below.

ENGLISH VERSION

The Guide is available at the following EPA website:

<http://www.epa.gov/owow/nps/roadshwys.html>

Or a BLM website at:

http://www.blm.gov/bmp/Technical_Information.htm

Or the National Transportation Library at:

http://ntl.bts.gov/lib/24000/24600/24650/Index_BMP_Field_Guide.htm

Or the Forest Service Intranet site under SDTDC, Forest Management at:

http://fsweb.sdtc.wo.fs.fed.us/programs/fm/fy04/lvre/Index_BMP_Field_Guide.htm

SPANISH VERSION

Gunter Zietlow, working with the International Roads Federation, GTZ, and the Organization of American States, originally placed the draft Spanish version "Ingenieria de Caminos Rurales" on their website at: <http://zietlow.com/docs/Ingenieria%20de%20Caminos%20Rurales.pdf>

The updated draft Spanish version was translated by the Mexican Transportation Institute and is also on their Website:

<http://www.imt.mx/Espanol/Publicaciones/libros/lb4.pdf>

These sources really help facilitate access to and availability of these documents! Many thanks to all of you who have helped and been loyal supporters of this project for many years!

Gordon

LOW-VOLUME ROADS ENGINEERING

Best Management Practices Field Guide

FOREWORD

The Conservation Management Institute (CMI) in the College of Natural Resources at Virginia Tech is dedicated to helping apply sound scientific principles to the management of renewable natural resources around the world. Access is an important consideration in many settings — not only to facilitate utilization of natural resources, but also to enable people to reach markets for their products and health services. However, it is vital that roads constructed provide adequate access while following sound practices for environmental protection wherever possible. Improperly constructed roads can negatively impact everything from terrestrial plant populations and soil conservation efforts to water quality and populations of aquatic organisms in receiving waters.

This manual was originally published in Spanish as “Prácticas Mejoradas de Caminos Forestales” by the U.S. Agency for International Development (USAID) for use throughout Latin America, and has proven valuable in helping to protect forest-based resources. It became clear that the practical advice offered in this manual could be of value to resource managers throughout the world. So, to reach this broader audience and inspired by the original Spanish work, CMI and the USDA Forest Service have collaborated to produce this updated version in English. We hope that the materials presented here are useful to you.

This project grew from our collaboration with Gerald Bauer, of the US Forest Service, on natural resource education programs in Latin America. Mr. Bauer was a contributor to the original manual and found the publication in great demand. This collaboration exemplifies our involvement with USAID and the Forest Service on many natural resource projects. We encourage you to contact USFS or CMI if we can be of assistance in your conservation efforts. Finally, we acknowledge the notable efforts of Julie McClafferty of CMI, who was instrumental in preparing this manual for publication.

B. R. Murphy, PhD., Director, CMI (murphybr@vt.edu)

A.L. Hammett, PhD., Faculty Fellow, CMI and Coordinator of International Programs, College of Natural Resources (himal@vt.edu)

Gordon Keller, PE, Geotechnical Engineer, USFS (gkeller@fs.fed.us)

James Sherar, PE, Logging Engineer, USFS (jrs4trees@prodigy.net)

ACKNOWLEDGMENTS

A LARGE NUMBER OF INDIVIDUALS have been involved in the development of the Minimum Impact Low-Volume Roads Manual and this subsequent Low-Volume Roads Engineering Best Management Practices Field Guide. These individuals have had the vision and commitment to preserving and enhancing the quality of our environment, while also recognizing the need for good roads. Furthermore, they recognize the planning, design, maintenance, and overall management necessary to have good roads. **Funding for this project has principally been provided by the US Agency for International Development (USAID), the Global Bureau, and the Forestry Team, with contributions from the USDA, Forest Service, Office of International Programs, the Pacific Southwest Region, and the Plumas National Forest.**

The original Spanish version of this document was produced with the help of Ramon Alvarez, Roberto Medina, and Atilio Ortiz with USAID, Honduras. The authors are particularly grateful for the support of Jerry Bauer, Alex Moad, and Michelle Zweede with the International Programs office of the U.S. Forest Service; Jim Padgett and Nelson Hernandez from the Washington Office, USFS; Scott Lampman, Paul DesRosiers, and Mike Bengé with the U.S. Agency for International Development; and the steadfast support from our Plumas National Forest colleagues.

The drawings presented in this document come from a variety of sources, as indicated, and most have been redrawn or adapted with the artistic talent of Jim Balkovek, Illustrator, and Paul Karr, a retired Forest Service Engineer. Scanning, labeling, and computer manipulation of figures for this field guide have been accomplished with the skill and patience of Lori Reynolds of Reynolds Graphics in Quincy, California. Translation of portions of this Field Guide and the original Minimum Impact Low-Volume Roads Manual was skillfully accomplished by Alejandra Medina of the Virginia Tech Transportation Institute.

A sincere thanks to the many professionals and laymen who gave their time in reviewing and editing the document, as well as making valuable suggestions regarding the form and content of this Field Guide. Particular thanks to Jill Herrick, U.S. Forest Service, for her valuable contributions and assistance with editing this guide, assistance with the Definition of Terms and References, and overall content review, as well as to Michael Furniss, Charlie Carter, Jerry Short, Tim Dembosz, and Ozzie Cummins for their numerous suggestions and ideas on drainage and other issues. Thanks to Richard Wiest, author of “A Landowner’s Guide to Building Forest Access Roads”, for his inspiration and ideas on format and layout. Other individuals involved in review and editing include Leslie Lingley of Leslie Geological Services; Marty Mitchell of Clear Water West; Alfred Logie with the International Programs office of the Federal Highway Administration (FHWA); Mike Bengé and Eric Peterson with U. S. Agency for International Development; Dr John Metcalf from LSU/PIARC World Roads Association; Dr. Francis Greulich, Forest Engineer at the University of Washington; Dr. Allen Hathaway, Geologic Engineer at the University of Missouri-Rolla; David Orr, PE with the Cornell University Local Roads Program; Prof. Raymond Charles, University of West Indies; Art Klassen, Tropical Forestry Foundation; James

Schenck and Wilson Castaneda, Cooperative Housing Foundation-Guatemala; Harold Tarver with Africare; Wes Fisher with Tellus Institute; and Sandra Wilson-Musser, Corky Lazzarino, Armando Garza, Gary Campbell, Ken Heffner, Terry Benoit, Allen King, John Heibel, William Vischer, and Greg Watkins, U.S. Forest Service employees dedicated to watershed protection and building good roads.

Most of the photos used in this manual either belong to the authors, Gordon Keller and James Sherar, or to Jerry Bauer, co-author on the “Minimum Impact Low-Volume Roads” Manual. Others belong to individuals as indicated on the specific photo. The retaining wall photo on the cover was provided by Michael Burke.

Finally, the authors wish to give special thanks to Tom Hammett at Virginia Tech for his connections and facilitation of this project and Julie McClafferty of the Conservation Management Institute and Patty Fuller of Poplar Hill Studios in Blacksburg, Virginia, for their magic in layout and publication of this guide and making it look the way it does. Last, and by no means least, a big hug to our wives, Jeanette and Julie, and families for their patience and support during this project!

PREFACE

THE AUTHORS ARE GRATEFUL for the opportunity to develop this guide for the US Agency for International Development (USAID) with the cooperation of the USDA, the Forest Service, the Office of International Programs, and the International Programs Department at Virginia Polytechnic Institute and State University. The original development of this Roads Best Management Practices (BMP) Field Guide was funded by USAID/Honduras, in support of their Forestry Development Program (FDP) and their National Forestry School (ESNACIFOR). It has since been revised and expanded to be consistent with and complement the training manual titled “Minimum Impact Low-Volume Roads” for roads work in developing regions.

This Low-Volume Roads Engineering Best Management Practices Field Guide is intended to provide an overview of the key planning, location, design, construction, and maintenance aspects of roads that can cause adverse environmental impacts and to list key ways to prevent those impacts. **Best Management Practices** are general techniques or design practices that, when applied and adapted to fit site specific conditions, will prevent or reduce pollution and maintain water quality. BMPs for roads have been developed by many agencies since roads often have a major adverse impact on water quality, and most of those impacts are preventable with good engineering and management practices. Roads that are not well planned or located, not properly designed or constructed, not well maintained, or not made with durable materials often have negative effects on water quality and the environment.

This Guide presents many of those desirable practices. Fortunately, most of these “Best Management Practices” are also sound engineering practices and ones that are cost-effective by preventing failures and reducing maintenance needs and repair costs. Also keep in mind that “best” is relative and so appropriate practices depend to some degree upon the location or country, degree of need for improvements, and upon local laws and regulations. Best practices are also constantly evolving with time.

This guide tries to address most basic roads issues in as simple a manner as possible. Complex issues should be addressed by experienced engineers and specialists. Included are key “**DO’S**” (**RECOMMENDED PRACTICES**) and “**DON’TS**” (**PRACTICES TO AVOID**) in low-volume roads activities, along with some relevant basic design information. These fundamental practices apply to roads worldwide and for a wide range of road uses and standards. Often recommended practices have to be adapted to fit local conditions and available materials. Additional information on **how** to do the work is found in other **Selected References**, such as the “Minimum Impact Low-Volume Roads Manual”.

Most practices apply to a wide range of road standards, from native surfaced, single-lane roads to double-lane paved roads. Desirable general practices include good road planning and location, performing environmental analysis, recognizing the need for positive surface drainage, ensuring adequately

sized drainage crossing structures, using stable cut and fill slopes, using erosion control measures, developing good materials sources, and reclaiming sites once work has been completed.

Certain design practices, such as use of rolling dips, outsloped roads, or low-water stream crossings, are very cost-effective and practical but typically apply to low-volume, low-speed roads because of safety concerns, vertical alignment issues, or unacceptable traffic delays. Other issues, such as the use of log stringer bridges, are very desirable for stream crossings in developing regions to avoid driving through the water, yet their use is now discouraged by some agencies, such as the U.S. Forest Service, because of their short design life and potentially unpredictable performance. Thus the information presented herein must be considered in terms of local conditions, available materials, road standards, project or resource priorities, and then applied in a manner that is practical and safe.

Local rules, agency policies or regulations, or laws may conflict with some of this information or may include more specific information than that included herein. Thus, good judgment should be used in the application of the information presented in this guide, and local regulations and laws should be followed or modified as needed.

You may reproduce or copy any portion of this Guide. However, please acknowledge this Guide as the source of information.

Reproduction Of This Field Guide is Encouraged!

Disclaimer

This Field Guide does not constitute a standard, specification, or regulation from or bound on any professional group, agency, or political entity. It is intended only as a guide for good roads engineering and sound environmental management in developing countries based upon the professional judgment and experience of the authors.

LOW-VOLUME ROADS ENGINEERING

Best Management Practices Field Guide

TABLE OF CONTENTS

Foreword		iii
Acknowledgments		v
Preface		vii
Definition of Terms		xi
Chapter 1	Introduction	1
Chapter 2	Environmental Analysis	5
Chapter 3	Planning Issues and Special Applications	11
	Key Road Issues	
	Reducing Vulnerability of Roads to Natural Disasters	
	Streamside Management Zones	
	Timber Harvesting	
Chapter 4	Low-Volume Roads Engineering	21
	Road Planning	
	Road Location	
	Road Survey, Design, and Construction	
	Road Costs	
	Road Maintenance	
	Road Closure	
Chapter 5	Hydrology for Drainage Crossing Design	37
Chapter 6	Tools for Hydraulic and Road Design	43
Chapter 7	Drainage of Low-Volume Roads	53
	Roadway Surface Drainage Control	
	Control at Inlets and Outlets of Cross-Drains and Ditches	
	Natural Stream Crossings	
	Wet Areas and Meadow Crossings, Use of Underdrains	
Chapter 8	Culvert Use, Installation, and Sizing	75

Chapter 9	Fords and Low-Water Crossings	91
Chapter 10	Bridges	97
Chapter 11	Slope Stabilization and Stability of Cuts and Fills	103
Chapter 12	Roadway Materials and Material Sources	115
Chapter 13	Erosion Control	129
Chapter 14	Stabilization of Gullies	141
	Selected References	147

Definition of Terms

Arranged by Topic:

Section I	Road Components	ix
Section II	Road Structural Section and Materials	xii
Section III	Surface Drainage	xiii
Section IV	Culverts and Drainage Crossings	xv
Section V	Fords and Low Water Crossings	xvii
Section VI	Erosion Control	xviii
Section VII	Miscellaneous Terms	xx

I. ROAD COMPONENTS

Figure (I.1): Terms Used to Define Low-Volume Roads

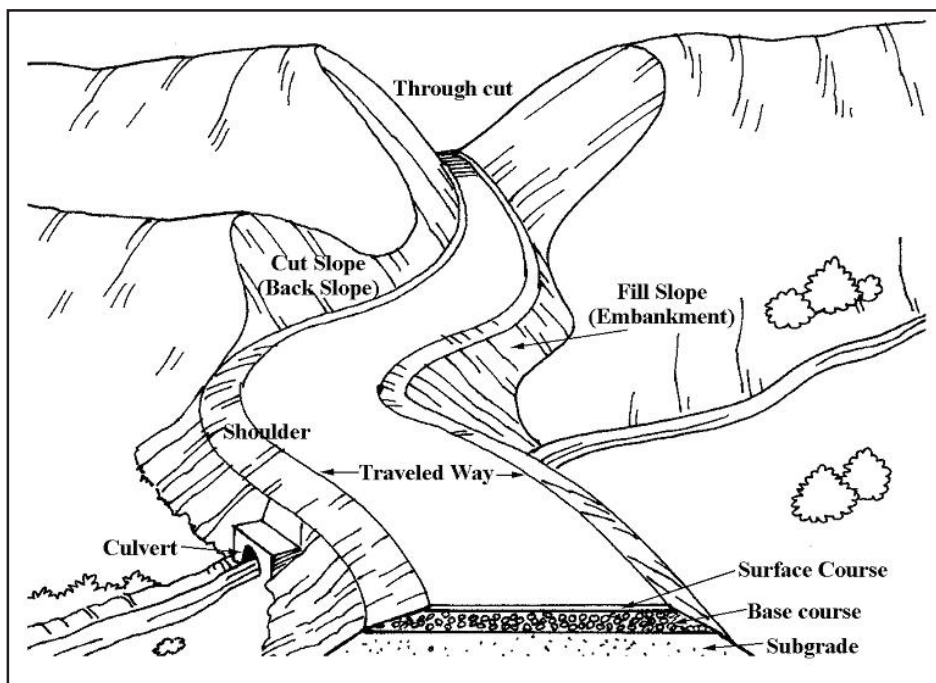
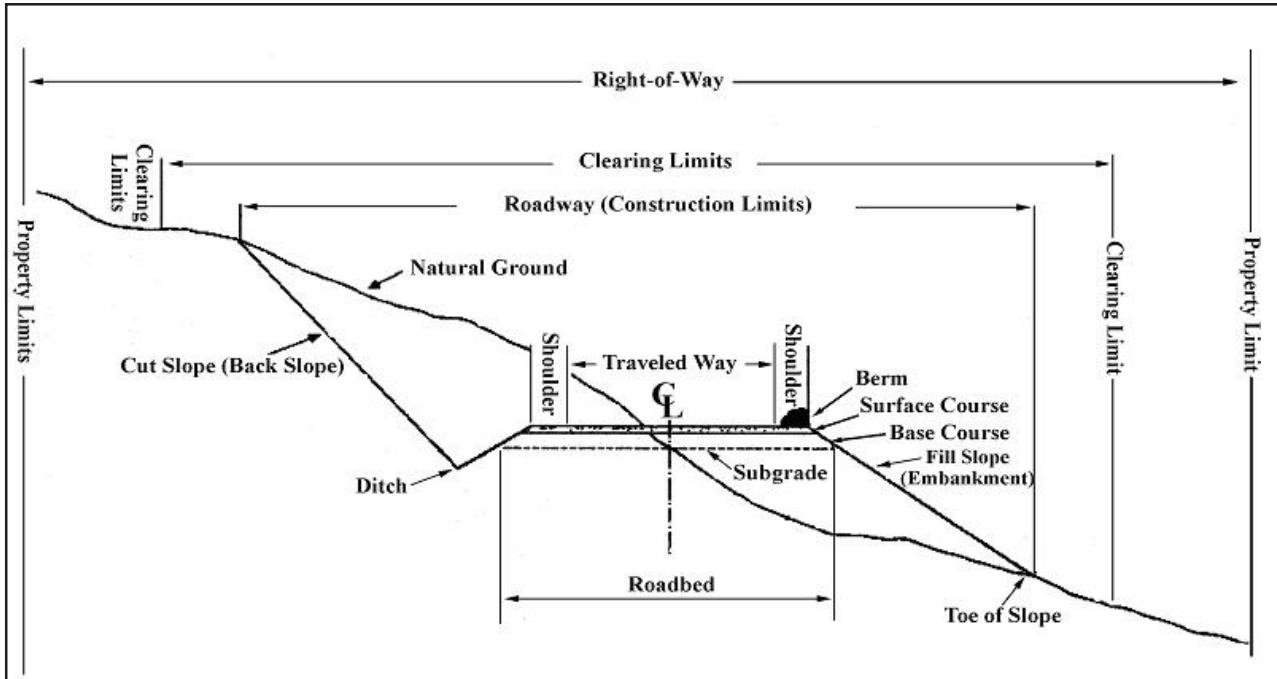


Figure (I.2) Terms Used to Define Low-Volume Roads (Cross-Section)



Base Course - See Section II below.

Berm - A ridge of rock, soil, or asphalt, typically along the outside edge of the road shoulder, used to control surface water. It directs surface runoff to specific locations where water can be removed from the road surface without causing erosion.

Buttress - A structure designed to resist lateral forces. It is typically constructed of large riprap rock, gabions, or drained soil to support the toe of a slope in an unstable area.

Cross-Section - A drawing depicting a section of the road sliced across the whole width of the road (See *Figure I.2* above). Can also apply to a stream, a slope, or a slide.

Cut Slope (Back Slope or Cut Bank) - The artificial face or slope cut into soil or rock along the inside edge of the road.

Cut-and-fill - A method of road construction in which a road is built by cutting into the hillside and spreading the spoil materials in adjacent low spots and as compacted or side-cast fill slope material along the route. A “**balanced cut-and-fill**” utilizes all of the “cut” material to generate the “fill”. In a balanced cut-and-fill design there is no excess waste material and there is no need for hauling additional fill material. Thus cost is minimized.

Ditch (Side Drain) - A channel or shallow canal along the road intended to collect water from the road and adjacent land for transport to a suitable point of disposal. It is commonly along the inside edge of the road. It also can be along the outside edge or along both sides of the road.

End Haul - The removal and transportation of excavated material off-site to a stable waste area (rather than placing the fill material near the location of excavation).

Embankment (Fill) - Excavated material placed on a prepared ground surface to construct the road subgrade and roadbed template.

Fill Slope (Embankment Slope) - The inclined slope extending from the outside edge of the road shoulder to the toe (bottom) of the fill. This is the surface formed where material is deposited to build the road.

Full Bench Cut and End Haul - A method of road construction in which a road is built entirely by cutting away the slope, and the excess material is hauled away (end hauled) to an off-site disposal area.

Grade (Gradient) - The slope of the road along its alignment. This slope is expressed in percent - the ratio of elevation change compared to distance traveled. For example, a +4% grade indicates a gain of 4 units of measure in elevation for every 100 units of measure traveled.

Low-Volume Road - A type of transportation system typically constructed to manage or extract resources from rural or undeveloped areas. These unique systems are designed to accommodate low traffic volumes with potentially extreme axle loads. They are commonly defined as having less than 400 ADT (Average Daily Traffic).

Natural Ground (Original Ground Level) - The natural ground surface of the terrain that existed prior to disturbance and/or road construction.

Plan View (Map View) - View seen when looking from the sky towards the ground. A drawing with this view is similar to what a bird would see when flying over a road.

Reinforced Fill - A fill that has been provided with tensile reinforcement through frictional contact with the surrounding soil for the purpose of greater stability and load carrying capacity. Reinforced fills are comprised of soil or rock material placed in layers with reinforcing elements to form slopes, walls, embankments, dams or other structures. The reinforcing elements range from simple vegetation to specialized products such as steel strips, steel grids, polymeric geogrids and geotextiles.

Retaining Structure - A structure designed to resist the lateral displacement of soil, water, or any other type of material. It is commonly used to support a roadway or gain road width on steep terrain. They are often constructed of gabions, reinforced concrete, timber cribs, or mechanically stabilized earth.

Right-of-Way (ROW) - The strip of land over which facilities such as roads, railroads, or power lines are built. Legally, it is an easement that grants the right to pass over the land of another.

Road Center Line - An imaginary line that runs longitudinally along the center of the road.

Roadbed - Width of the road used by vehicles including the shoulders, measured at the top of subgrade.

Roadway (Construction Limits or Formation Width) - Total horizontal width of land affected by the construction of the road, from the top of cut slope to the toe of fill or graded area.

Side-Cast Fill - Excavated material pushed on a prepared or unprepared slope next to the excavation to construct the roadbed. The material is usually not compacted.

Slope Ratio (Slope) - A way of expressing constructed slopes as a ratio of horizontal distance to vertical rise, such as 3:1 (3 m horizontal for every 1 m vertical rise or fall).

Shoulder - The paved or unpaved strip along the edge of the traveled way of the road. An inside shoulder is adjacent to the cut slope. An outside shoulder is adjacent to an embankment slope.

Subgrade - See Section II below.

Surface Course (Surfacing) - See Section II below.

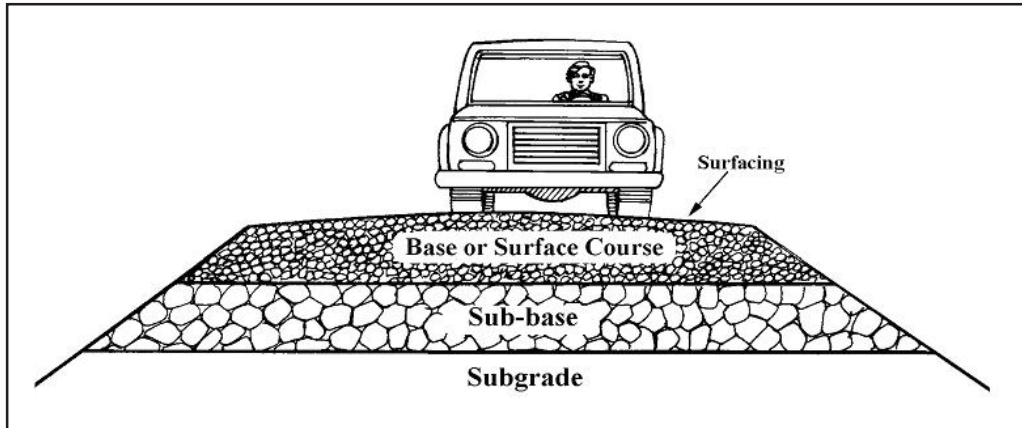
Traveled Way (Carriageway) - That portion of the road constructed for use by moving vehicles including traffic lanes and turnouts (excluding shoulders).

Through Cut - A road cut through a hill slope or, more commonly, a ridge, in which there is a cut slope on both sides of the road.

Through Fill - Opposite of a through cut, a through fill is a segment of road that is entirely composed of fill material, with fill slopes on both sides of the road.

II. ROAD STRUCTURAL SECTION AND MATERIALS

Figure (II): Road Structural Section



Base Course (Base) - This is the main load-spreading layer of the traveled way. Base course material normally consists of crushed stone or gravel or of gravelly soils, decomposed rock, sands and sandy clays stabilized with cement, lime or bitumen.

Borrow Pit (Borrow Site) - An area where excavation takes place to produce materials for earthwork, such as a fill material for embankments. It is typically a small area used to mine sand, gravel, rock, or soil without further processing.

Quarry - A site where stone, riprap, aggregate, and other construction materials are extracted. The material often has to be excavated with ripping or blasting, and the material typically needs to be processed by crushing or screening to produce the desired gradation of aggregate.

Raveling - A process where coarse material on the road surface comes loose and separated from the roadbed because of lack of binder or poor gradation of material. The term also applies to a slope where rock or coarse material comes loose and falls down the cut or fill slope.

Sub-Base - This is the secondary load-spreading layer underlying the base. It normally consists of a material that has lower strength and durability than that used in the base, e.g. unprocessed natural gravel, gravel/sand or gravel/sand/clay.

Subgrade - The surface of roadbed upon which sub base, base, or surface course are constructed. For roads without base course or surface course, this portion of the roadbed becomes the finished wearing surface. The subgrade is typically at the level of the in-place material.

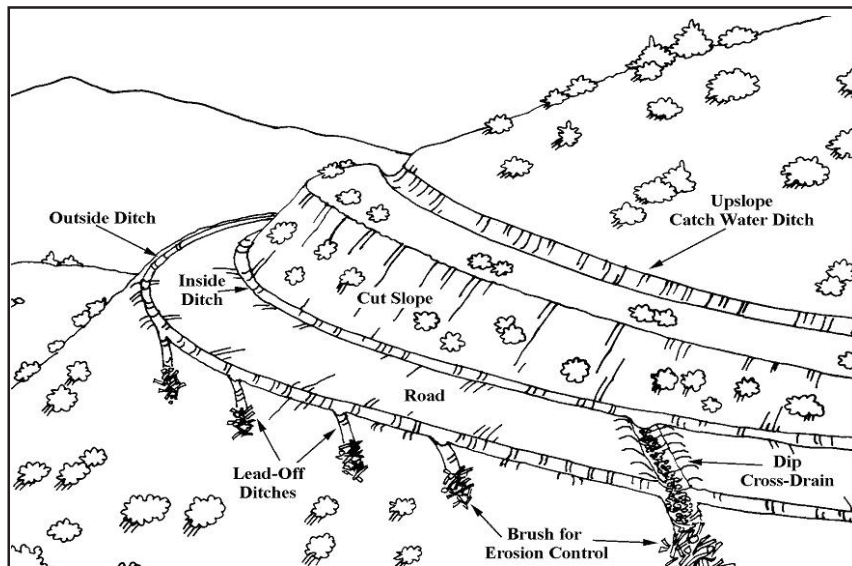
Surface Course (Surfacing) - The top layer of the road surface, also called the wearing course. Rock, cobblestone, crushed aggregate and paving, such as Bituminous Surface Treatments and Asphalt Concrete, are types of surfacing used to improve rider comfort, provide structural support, and weatherproof the road surface for wet season use.

Washboarding (Corrugations) - A series of ridges and depressions across the road caused in soil and aggregate road surfaces by the lack of surface cohesion. This is typically a result of the loss of fines in the road surface caused by dry conditions or poorly graded material. These conditions worsen with excessive vehicle speeds and high traffic volumes.

Wearing Course (Wearing Surface) –The top layer of the road surface that is driven upon. It should be durable, may have a high resistance to skidding, and it typically should be impervious to surface water. Wearing surfaces may be the native soil, aggregate, seal coats, or asphalt.

III. SURFACE DRAINAGE

Figure (III.1): Road Surface Drainage



Armor - Rocks or other material placed on headwalls, on soil, or in ditches to prevent water from eroding and undercutting or scouring the soil.

Catch Water Ditch (Intercept Drain) - A flat-bottomed excavation or ditch located above a cut slope that is designed to intercept, collect and drain away surface runoff water before it goes over the cut slope, to protect the cut slope and roadway from erosion.

Check Dam (Scour Check, or Dike) - A small dam constructed in a gully or ditch to decrease flow velocity, minimize channel scour, and to trap sediment.

Cross-Drain (X-Drain) - Installed or constructed structures such as culverts and rolling dips that move water from one side of the road to the other.

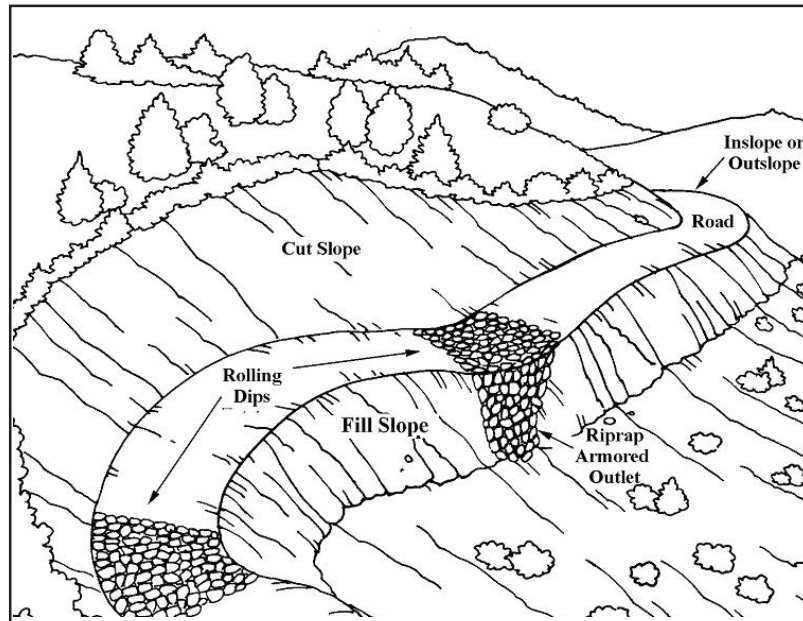
Crown - A crowned surface has the highest elevation at centerline (convex) and slopes down on both sides. Crown is used to facilitate draining water off a wide road surface.

Debris - Organic material, rocks and sediment (leaves, brush, wood, rocks, rubble, etc.) often mixed, that is undesirable (in a channel or drainage structure).

Drainage Structure - A structure installed to control, divert, or move water off or across a road, including but not limited to culverts, bridges, ditch drains, fords, and rolling dips.

French Drain (Underdrain) - A buried trench, filled with coarse aggregate, and typically placed in the ditch line along the road, which acts to drain subsurface water from a wet area and discharge it a safe and stable location. French drains may use variable sizes of rock but do not have a drain pipe in the bottom of the trench.

Figure (III.2): Rolling Grade with Rock-Armored Rolling Dips



Inside/Outside - Reference to a feature on the inside of the road, which is typically the cutslope (back slope) side of the road/ Reference to a feature on the outside of a road, typically on the fill slope side.

Inslope - The inside cross-slope of a road subgrade or surface, typically measured in percentage. Inslope is used to facilitate the draining of water from a road surface to an inside ditch. An insloped road has the highest point on the outside edge of the road and slopes downward to the ditch at the toe of the cut slope, along the inside edge of road.

Lead-Off Ditches (Turnouts, Outside Ditch, or Mitre Drains) - Excavations designed to divert water away from the ditch and roadway (at a point where this doesn't occur naturally) in order to reduce the volume and velocity of roadside ditch water.

Outslope - The outside cross-slope of a road subgrade or surface, typically measured in percentage. Outslope is used to facilitate the draining of water from a road directly off the outside edge of the road. An outsloped road has the highest point on the uphill or inside of the road and slopes down to the outside edge of the road and the fill slope.

Riprap - Well-graded, durable, large rock, ideally with fractured surfaces, sized to resist scour or movement by water and installed to prevent erosion of native soil material.

Rolling Dip (Dip, Broad-Based Dip) - A surface drainage structure, with a constructed break in the road grade, specifically designed to drain water from an inside ditch or across the road surface, while vehicles travel speed is somewhat reduced (see lower photo on the cover of this Guide).

Underdrain (Subsurface Drain) - A buried trench, filled with coarse aggregate, coarse sand, or gravel, and typically placed in the ditch line along the road, which acts to drain subsurface water from a wet area and discharge it a safe and stable location. Underdrains may use a uniform size of rock, be wrapped in geotextile, and have a perforated drain pipe in the bottom of the trench.

Waterbar - A frequently spaced, constructed drainage device, using soil mounds in the road surface, that interrupt the flow of water and that diverts water off the road surface. They may be drivable by high clearance vehicles or impassable.

IV. CULVERTS AND DRAINAGE CROSSINGS

Figure (IV.1): Culvert Components

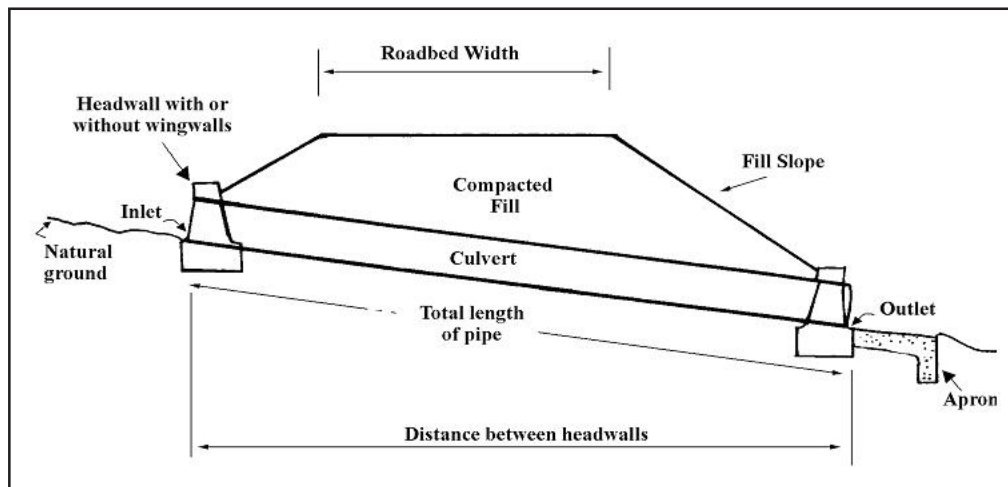
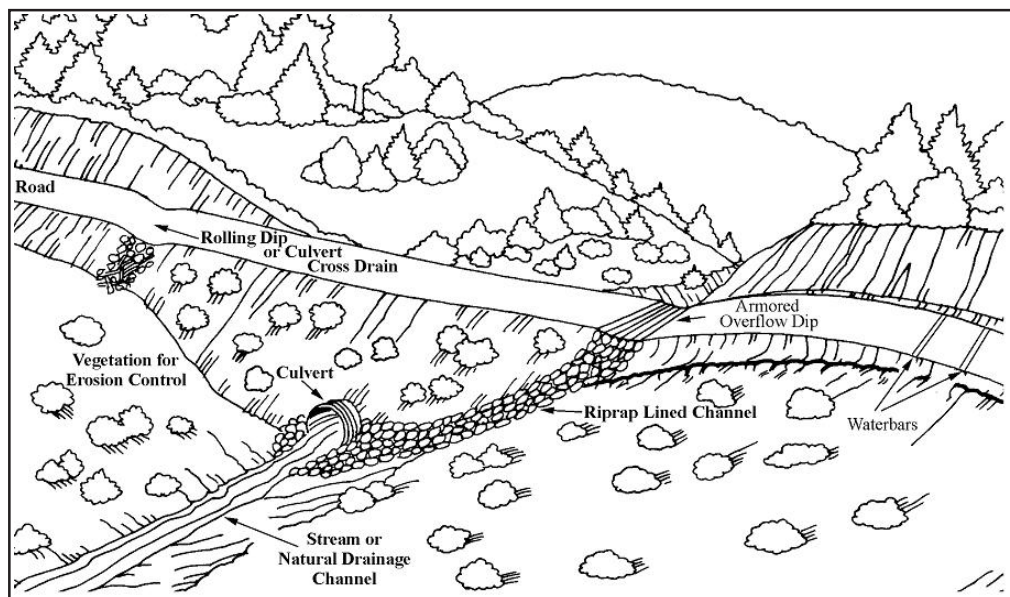


Figure (IV.2): Natural Drainage Crossing with a Culvert



Apron - An extension of the head wall structure built at ground or stream level and designed to protect the stream bottom from high flow velocities and to safely move water away from the drainage structure.

Bankfull Width (Ordinary High Water Width) - The surface width of the stream measured at the bankfull stage. This flow, on average, has a recurrence interval of about 1.5 years. The bankfull stage is the dominant channel-forming flow, and is typically identified as the normal upper limit of stream channel scour, below which perennial vegetation does not occur.

Bedload - Sediment or other material that slides, rolls, or bounces along the streambed or channel bottom due to flowing water.

Catch Basin - The excavated or constructed basin at the inlet of a culvert cross-drain pipe, used to store water and direct it into the culvert pipe.

Culvert - A drainage pipe, usually made of metal, concrete, or plastic, set beneath the road surface, to move water from the inside of the road to the outside of the road, or under the road. Culverts are used to drain ditches, springs, and streams that cross the road. The invert is the floor or the bottom of the structure at its entrance.

Drop Inlet - A masonry or concrete basin, or a vertical riser on a metal culvert inlet, usually of the same diameter as the culvert, and often slotted, to allow water to flow into the culvert as water flow rises around the outside. Drop inlets are often used on ditch relief culverts where sediment or debris would plug the pipe. A drop inlet also helps control the elevation of the ditch.

Flood Plain - A level or gently sloping area on either side of a river or stream active (main) channel that is submerged at times during high water or periods of flooding. Silt and sand are deposited and accumulate in this area along the main channel.

Freeboard - The additional height of a structure above design high water level to prevent overflow or overtopping. Also freeboard, at any given time, is the vertical distance between the water level and the bottom of the bridge slab, girders, or structure.

Headwall - A concrete, gabion, masonry, or timber wall built around the inlet or outlet of a drainage pipe or structure to increase inlet flow capacity, reduce risk of debris damage, retain the fill material and minimize scour around the structure.

High Water Mark - The line on a bank or shore established by the highest level of the water. This is usually identified by physical evidence such as a natural impression (small bench) on the bank, changes in the character of soil, destruction of most vegetation, or presence of litter and debris.

Inlet - The opening in a drainage structure or pipe where the water first enters the structure.

Metal End Section - A manufactured headwall/wing wall, usually made from the same type of metal as the culvert, to enhance inlet flow capacity.

Outlet - The opening in a drainage structure or pipe where the water leaves the structure. The outlet is usually lower than the inlet to ensure that water flows through the structure.

Outlet Protection - Devices or material, such as a headwall or riprap, placed at the outlet of pipes or drainage structures to dissipate the energy of flowing water, reduce its flow velocity, and prevent channel or bank scour.

Perennial Stream - A stream that typically has running water all year long.

Piping - The movement of fine soil under a pipe, embankment, or structure, caused by seepage forces and moving water, that can cause a structure to be undermined and fail.

Rootwad - The ball of tree roots and dirt that is pulled from the ground when a tree is uprooted.

Scour - Erosion or soil movement in a stream bed, stream bank, channel, or behind a structure, typically caused by increased water velocity or lack of protection.

Stream Barb (Jetty) - Typically low rock sills that project away from a stream bank and out into the stream channel to redirect flow away from an eroding bank.

Wing Walls - Masonry or concrete structures built onto the side of culvert inlet and outlet headwalls, designed to retain the roadway fill and direct water into and out of the drainage structure while protecting the road and fill from erosion.

V. FORDS AND LOW-WATER CROSSINGS

Figure (V.1) Simple Ford

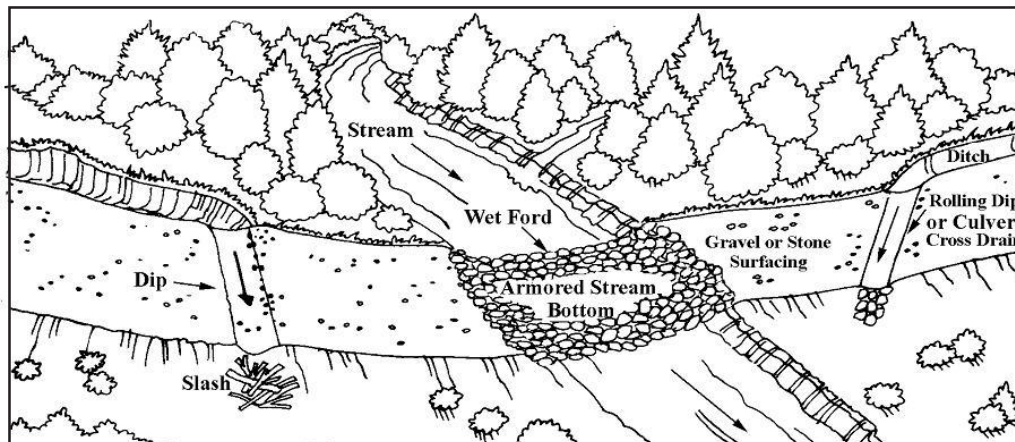
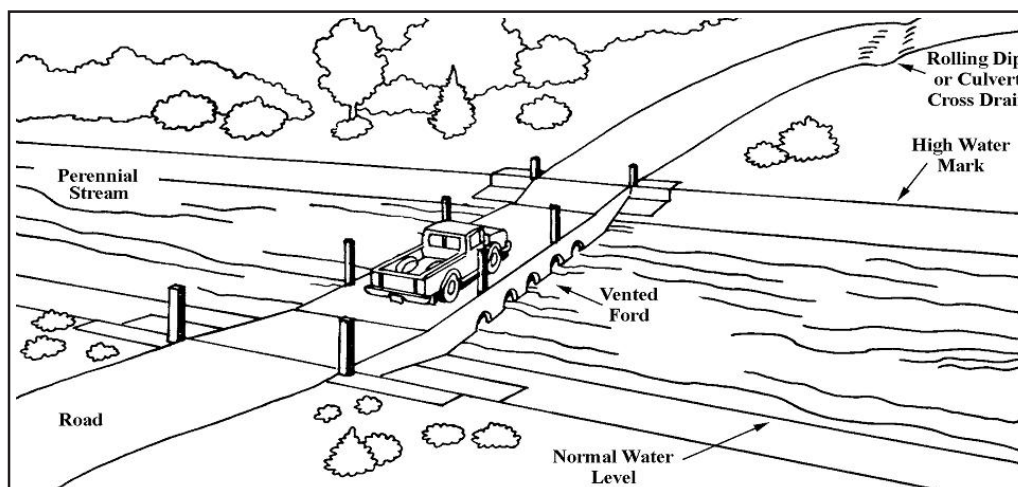


Figure (V.2) Improved, Vented Ford



Ford (Low-Water Crossing) (Drift); Simple - A rock or other hardened structure that is built across the bottom of a swale, gully, or stream channel that is usually dry, to allow improved vehicle passage during periods of low water or no flow.

Ford (Low-Water Crossing) (Drift); Improved - A masonry, concrete, gabion, or other hardened surface structure built across the bottom of an intermittent or live stream that improves vehicle passage during low flow periods and minimizes channel disturbance or sediment production.

Vented Ford - A structure designed to allow normal or low water flow in a stream channel or watercourse to pass safely through the structure (e.g., culverts) below a hardened or reinforced roadway surface. During periods of high water or flooding, the flow passes over the structure and typically prevents vehicle passage.

VI. EROSION CONTROL

Figure (VI.1): Use of Vegetation, Woody Material and Rock for Erosion Control

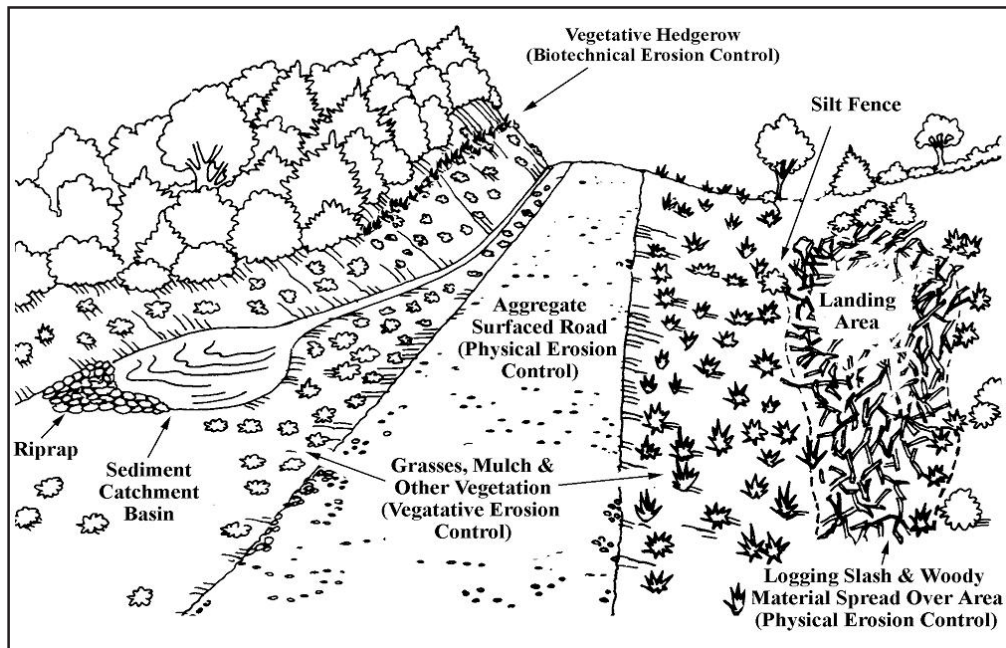
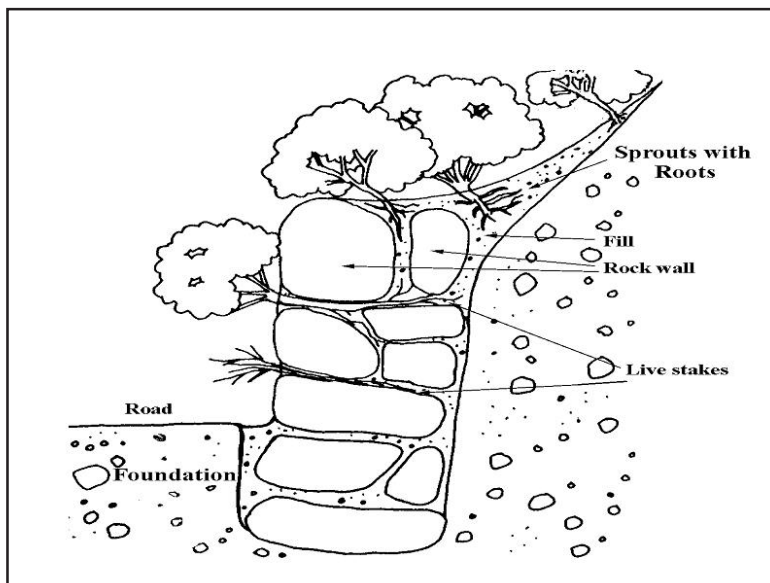


Figure (VI.2): Biotechnical Erosion Control Measures-A Wall with Live Stakes



Biotechnical Erosion Control - A combination of vegetative and structural measures used to prevent erosion or stabilize slopes and stream banks. The term “biotechnical” describes several methods of establishing vegetative cover by embedding a combination of live, dormant, and/or decaying plant materials into banks and shorelines in a structure-like manner or in conjunction with riprap or physical structures such as cribs or gabions.

Brush Barrier - A sediment control structure created using live brushy vegetation or slash piled at the toe of a fill slope, on contour along a slope, along the road, or at the outlet of culverts, leadoff ditches, dips, or water bars to trap sediment.

Brush Layers - The biotechnical practice of digging shallow terraces into the surface of a slope, laying in layers of a vegetative cuttings that will resprout, and backfilling (burying) the cuttings with soil. Cuttings are placed perpendicular to the slope contour.

Erosive Soils - Soils that are relatively prone to erosion and movement by rain drop impact and surface runoff. Fine granular, non-cohesive soils, such as fine sandy sand derived from decomposed granite, silts, or fine sands, are known to be very erosive.

Erosion - The process by which the surface of the earth is worn away and soil moved by the actions of wind or water in the form of raindrops, surface runoffs, and waves.

Erosion Control - The act of reducing or eliminating on-going erosion caused by raindrop impact, rilling, gulying, raveling, and other surface processes.

Erosion Prevention - Preventing erosion before it occurs. Erosion prevention is typically less expensive and more effective than erosion control. Erosion prevention is intended to protect a road, including its drainage structures, cut and fill slopes, and disturbed areas, and to protect water quality.

Live Stakes - Sections of woody plants that are cut into lengths (stakes) and placed or driven into the slope. The plant material is installed during the fall or spring when the original plant (and consequently cuttings from it) is dormant. The plant materials used for stakes are usually hardy species which will root from cuttings easily and eventually grow into mature woody shrubs that reinforce the soil structure of the slope.

Mulch - Material placed or spread on the surface of the ground to protect it from raindrop, rill, and gully erosion, and to retain moisture to promote the growth of vegetation. Mulches include cut vegetation, grasses, wood chips, rock, straw, wood fiber, and variety of other natural and synthetic materials and mats.

Mulching - Providing a loose covering on exposed soil areas using materials such as grass, straw, bark, or wood fibers to help control erosion and protect exposed soil.

Native Species - Occurring or living naturally in an area (indigenous), such as locally grown native plants.

Physical Erosion Control Measures - Non-vegetative measures used to control erosion, such as armoring the soil with riprap, building silt fences, using woven mats, using gabions, spreading or windrowing logging slash or woody material, etc., and controlling water with settlement ponds, armored drainage ditches, etc.

Scarification - The act of ripping or stripping the forest floor or a road surface and mixing it with mineral soil, typically with mechanical equipment, to loosen the soil, reduce compaction, and prepare the area for planting with grasses or trees.

Sedimentation (Sediment) - Soil, most commonly clay, silt and sand, which is eroded from the land or poorly constructed roads and reaches a stream or water course, commonly reducing water quality in rivers, streams and lakes.

Sediment Catchment Basin - A constructed basin designed to slow water velocity and trap sediment as it settles out of the water.

Slash - Any treetops, limbs, bark, abandoned forest products, windfalls or other debris left on the ground after timber or other forest products have been cut.

Silt Fence - A temporary barrier used to intercept sediment-laden runoff from slopes. It is typically made of porous geotextile material.

Vegetative Erosion Control Measures - The use of live cuttings or stakes, seed, sod, and transplants to establish vegetation (grass, brush, trees) for erosion control and slope protection work.

Vegetative Contour Hedgerow - Rows of trees and shrubs, typically planted on contour across slopes, that form a border and can provide erosion control protection against sheet flow, as well as provide food and cover for wildlife.

Vetiver Grass - Any of several varieties of a non-invasive, large bunch grass widely used for erosion control and moisture conservation. When planted as a contour hedgerow, it slows runoff and filters sediment. The curtain-like root system helps anchor soil and competes minimally with adjacent crop roots.

Wattles (Live Fascine) - Long bundles of brush or branch cuttings, bound together into sausage shaped structures, which are buried or staked on contour along a slope, preferably to sprout, and form a sediment trap or break up sheet flow on the slope.

Windrow - Logging debris and woody vegetation that has been piled in rows to trap sediment, as well as decompose or eventually be burned; the act of building windrows.

VII. MISCELLANEOUS TERMS

Angle of Repose - The maximum slope or angle at which a granular material, such as loose rock or soil, will stand and remain stable.

Best Management Practices (BMPs) - Practical guidelines that can be used to reduce the environmental impact of roads and forest management activities (such as the construction of roads, skid trails and log landings) and protect water quality. BMPs address the key planning, location, design, construction, and maintenance aspects of roads or other activities that can cause adverse environmental impacts and suggest methods to prevent those impacts.

Buffer Area - A designated zone along a stream or around a water body or area with sufficient width to minimize the entrance of forestry chemicals, sediment, or other pollution into the water body or protect the area.

Contour - Lines drawn on a plan that connect points having the same elevation. Contour lines represent an even value, with the contour interval being selected consistent with terrain, scale, and intended use of the plan. Contours are level.

Environmental Impact - An action or series of actions that have an effect on the environment. An Environmental Impact Assessment predicts and evaluates these effects, both positive and negative, and the conclusions are used as a tool in planning and decision-making.

Gabions - Baskets (usually made of wire) filled with rocks (or broken pieces of concrete) about 10-20 cm in size, used for building erosion control structures, weirs, bank protection, or retaining structures.

Geotextile (Filter Fabric) - Textile made from synthetic “plastic” fibers, usually non-biodegradable, to form a blanket-like product. Geotextiles can be woven or non-woven and have varying degrees of porosity, open area, and strength properties. They are used as moisture barriers, for separation or reinforcement of soils, filtration, and for drainage.

Habitat - The natural environment that forms a home for native plants and animals. For example, riverbanks are habitat for insects that are the primary source of food for many fish.

Logging (Harvesting) - Logging is the process of harvesting timber from trees. This includes felling, skidding, loading, and transporting forest products, particularly logs.

Landing (Log Deck) - Any place on or adjacent to the logging site where logs are assembled after being yarded, awaiting subsequent handling, loading, and transport. This is typically a relatively flat area, commonly about 20 to 50 meters in diameter.

Mitigation - The act of or a specific item used to reduce or eliminate an adverse environmental impact.

Native Soil - Natural, in-place or in-situ soil that has formed on site and has not been artificially imported to the site.

Reclamation (Rehabilitation) - Activities that reclaim, repair, or improve part or all of an existing road, borrow pit, or disturbed area and restore it to its original or some desired final condition.

Road Closure (Temporary) - Closing vehicular access to a road through the use of barricades such as gates, log barriers, earthen mounds, or other temporary structures. The end result is to restrict the use of the road for some period of time.

Road Decommissioning - Permanently closing a road through techniques that include blocking the entrance, scattering limbs and brush on the roadbed, replanting vegetation, adding waterbars, removing fills and culverts, or reestablishing natural drainage patterns. However the basic road shape, or template, is still in place. The end result is to terminate the function of the road and mitigate the adverse environmental impacts of the road.

Road Obliteration - A form of road closure that refills cut areas, removes fills and drainage structures, restores natural contours, revegetates the area, and ultimately attempts to restore the natural ground shape and condition. Thus, most adverse environmental impacts of the road are eliminated.

Road Management Objectives - Objectives that establish the intended purpose of an individual road based on management direction and access management objectives. Road management objectives contain design criteria, operation criteria, and maintenance criteria.

Skid Trail (Skidding) - A temporary, nonstructural pathway over forest soil used for dragging felled trees or logs to a log landing.

Streamside Management Zone (SMZ) - The land, together with the vegetation that grows there, immediately in contact with the stream and sufficiently close to have a major influence on the total ecological character and function of the stream. It is a buffer area along a stream where activities are limited or prohibited.

Upgrading - The process by which the standard of an existing road is improved or altered to allow for increased capacity and safe use by a greater volume of traffic.

Chapter 1

Introduction

"Ideas are a dime a dozen. People who put them into action are priceless."

-A. Einstein

RURAL, LOW-VOLUME, farm-to-market access roads, roads connecting communities, and roads for logging or mining are significant parts of any transportation system. They are necessary to serve the public in rural areas, to improve the flow of goods and services, to help promote development, public health and education, as well as to aid in land and resource management (*Photo 1.1*). At the same time, roads and disturbed areas can produce significant amounts of sediment (*Photo 1.2*). They can be one of the greatest adverse impacts on the local environment, on water quality, and on aquatic life. Roads can produce significant erosion, cause gullies, have an impact on groundwater, wildlife, and vegetation, impact social structure, degrade scenic values, waste limited funds, and take useful land out of production (*Photo 1.3*).

The basic objective of this guide is to help engineers, planners, environmental specialists, and road managers make good decisions, protect the environment, and build good low-volume roads. Key issues that should be addressed when planning a road project include changes or negative impacts to the area that a road can cause which may be significant, irreversible, or difficult to mitigate. The



Photo 1.1 A minimum impact rural road that is well drained, has a stable driving surface, stable slopes, and is satisfactory for the user.



Photo 1.2 A poorly drained road that has a rough driving surface for the users, it is a source of sediment, and it is relatively expensive to maintain.

long-term social, environmental, and fiscal cost effectiveness of a proposed road all need to be examined. Environmental analysis is a principal way to examine all aspects of a project, maximize its usefulness, and minimize problems. Emphasis should be placed on the use of an “Interdisciplinary Team” approach. Not all adverse impacts of roads can be avoided, but many can, and the negative and positive impacts of a road project should be weighed and evaluated.

Roads are necessary, but they must be constructed and maintained in such a way that negative environmental impacts are controlled or avoided. A well planned, located, designed, and constructed road will have minimum adverse impacts on the environment and will be cost effective in the long term with minimized maintenance and repair

costs. Controlling erosion and protecting water quality are essential to the quality of life, the health of the forest and woodland ecosystems, and to the long-term sustainability of rural resources. Vegetated areas such as woodlands and forests play a vital role in

producing, purifying, and maintaining clean water. Roads must protect water quality and the biotic environment that depends on it.

Best Management Practices or “BMPs” are those principals and engineering design practices that will protect water quality as well as the function of the road when properly applied. The Best Management Practices presented herein are a compilation of ideas and techniques that can be used in road management to reduce or eliminate many of the potential impacts from road operations and protect water quality. They represent good road design and construction practices that are cost effective in the long run by preventing failures, eliminating repair needs, and reducing maintenance.

The purpose of this manual is to present recommended practices for low-volume roads. A low-volume road is commonly defined as a road that has an average daily traffic



Photo 1.3 A problematic road because of roadcut failures. Instability problems cause road user delays, and high maintenance or repair costs.

The key objectives of
**BEST MANAGEMENT
PRACTICES**

Best Management Practices are designed to accomplish the following:

- Produce a safe, cost effective, environmentally friendly, and practical road design that is supported by and meets the needs of the users;
- Protect water quality and reduce sediment loading into water bodies;
- Avoid conflicts with land use;
- Protect sensitive areas and reduce ecosystem impacts;
- Maintain natural channels, natural stream flow, and maintain passage for aquatic organisms;
- Minimize ground and drainage channel disturbance;
- Control surface water on the road and stabilize the roadbed driving surface (*Photo 1.4*);
- Control erosion and protect exposed soil areas;
- Implement needed slope stabilization measures and reduce mass wasting;
- Avoid problematic areas; and
- Stormproof and extend the useful life of the road.

(ADT) of less than 400 vehicles per day, and usually has design speeds less than 80 kph (50 mph). The information in this manual is applicable to rural roads, and most of the information is applicable to all types of roads, although high standard roads are not the emphasis of this manual. Soil and water quality issues related to temperature, nutrients, chemical pollution, debris, quantity of flow, and so on are also beyond the scope of this manual, although there are many varied benefits from the application of these practices.

Each topic in this manual contains a problem statement that presents concerns, advantages, and potential impacts for that issue. **RECOMMENDED PRACTICES** and information on the proper or most desirable way to plan, locate, design, construct, and maintain roads are presented, along with drawings and tables. Finally, **PRACTICES TO AVOID** are listed to discourage poor and undesirable practices.

This manual offers the Best Management Practices associated with many aspects of roads management. The information presented in this manual should become an integral part of transportation planning and rural road design. Key to its use is the need to **hire and retain good, well-trained, and experienced engineers** in road agencies to evaluate problems, consider local conditions and resources, and implement or adapt these practices as appropriate.

*“Ideas are a dime a dozen.
People who put them into
action are priceless.”*

Obviously, some significant differences exist in roads needs and design details in varying geographic areas. At times, unique solutions are needed. Mountainous regions typically have steep slopes and cold region conditions; deserts have little moisture to support vegetative erosion control measures but have brief, intense rainfall; jungles often have poor soils and drainage problems; high valley regions have dissected, steep terrain and difficult drainage crossings, and so on. However, the basic planning, location, design and maintenance

concepts, and select BMPs apply to any area. Good planning and road location are needed in any area. Roadway drainage must be controlled and drainage crossings must be carefully selected and properly designed. All roads need stable slopes, use of good materials, and appropriately applied erosion control measures. Only some design details vary with specific geographic and climatic regions. Thus local experience and knowledge are so important in rural roads.

These BMPs are applicable to road construction practices in most field situations. However, BMPs should be selected (and may be modified) for site-specific conditions, with guidance from experienced engineers, managers, or other resource professionals. They must consider local or national regulations. Modifications should be researched, designed, and documented before being used. They should be monitored, and they should provide for equal or greater water quality protection.



Photo 1.4 A well designed, “minimum impact” road that has an appropriate standard for its use, and a stabilized cobblestone driving surface.

Chapter 2

Environmental Analysis

Involve all parties! Communicate, communicate, communicate!

ENVIRONMENTAL ANALYSIS (the EA Process) is a systematic, interdisciplinary process used to identify the purpose of a proposed action, develop practical alternatives to the proposed action, and predict potential environmental effects of the action. A few examples of proposed actions are road construction, logging, tree clearing for disease control, reforestation, building a hydroelectric dam, or developing a quarry. *Figure 2.1* shows some of the trade-offs and environmental impacts of low versus high standard roads.

A couple of the principal environmental laws applied today are, the National Environmental Policy Act (NEPA), established in the United States in 1964, and the US Agency for International Development (USAID) 216 Regulations, which dictate the environmental analysis process for USAID funded projects worldwide. Many other countries and agencies have environmental laws, regulations, and procedures that pattern these fundamental documents.

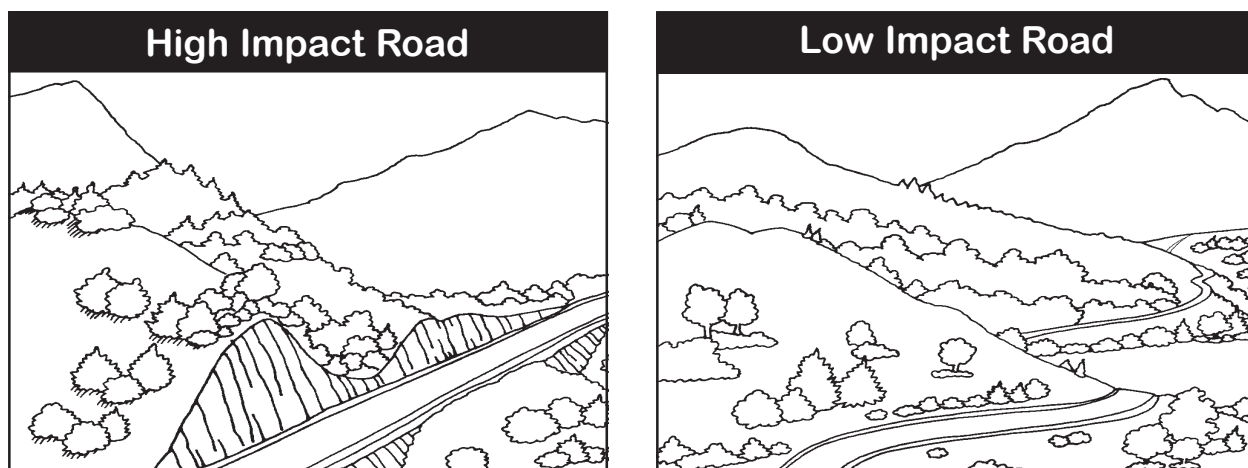


Figure 2.1 Low versus High Impact Roads: These figures show the reduced work and reduced environmental impacts from low standard roads that conform to the topography. The low standard road reduces cut and fill slope size, reduces earth work, visual impacts, and minimizes changes to natural drainage patterns. The high standard road can move a large volume of traffic rapidly and safely.



Photo 2.1 A well built road that helps serve the local population in a rural area, with minimum environmental damage.

An Environmental Analysis (EA) identifies problems, conflicts, or resource constraints that may affect the natural environment or the viability of a project. It also examines how a proposed action might affect people, their communities, and their livelihoods (*Photo 2.1*). The analysis should be conducted by an Interdisciplinary Team consisting of personnel with a range of skills and disciplines relevant to the project. Team members should include a team leader and may include engineers, geologists, biologists, archaeologists, and social workers. The EA process and findings are communicated to the various affected individuals and groups. At the same time, the interested public helps provide input and comment on the proposed project (*Photo 2.2*). The document produced as a result of the EA guides the decision maker toward a logical, rational, informed decision about the proposed action.

The EA process and Interdisciplinary Team studies can

reveal sound environmental, social, or economic reasons for improving a project. After predicting potential issues, the EA identifies measures to minimize problems and outlines ways to improve the project's feasibility. *Figures 2.2 a, b, & c* show examples of environmental mitigations that a designer can use to avoid potential impacts on wildlife, such as use of animal underpasses and culvert



Photo 2.2 A key aspect of the Environmental Analysis process is **communications** with the public and between Interdisciplinary Team members.

requirements for fish passage (*Photo 2.3*).

The EA process can provide many benefits to the road builder, local agencies, and the communities who will be affected by road construction and maintenance activities. The process and resulting reports are tools that road managers can use to guide their decisions, produce better road designs and maintenance plans, identify and avoid problems, and gain public support for their activities. An EA document can be long and complex for major, potentially high impact projects, or it may only be a few pages long for a simple road project. *Table 2.1* presents an eight-step process that is useful for doing Environmental Analysis.

Key benefits of EA for a road project can include the following:

- Reducing cost and time of project implementation;

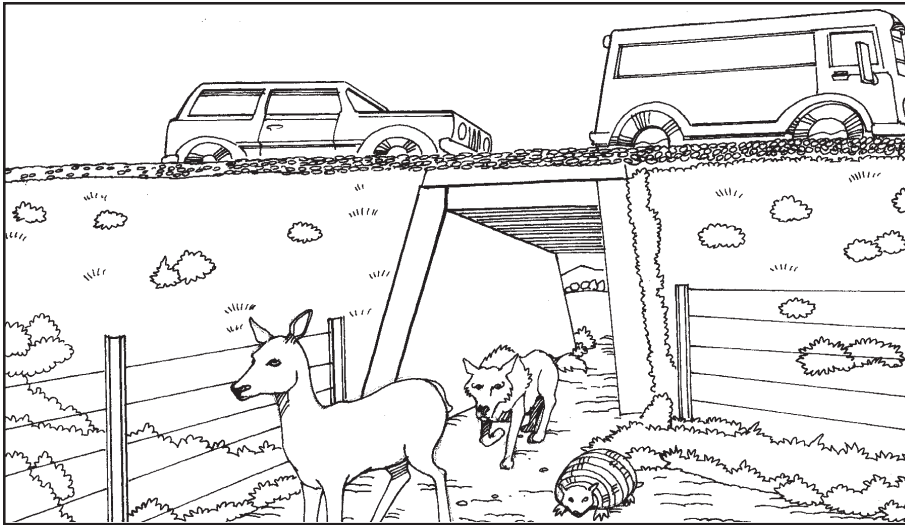


Figure 2.2a Example of an animal underpass used in road construction to minimize the impact of roads on wildlife migration. Underpasses allow for safe animal crossings and minimize road kill.

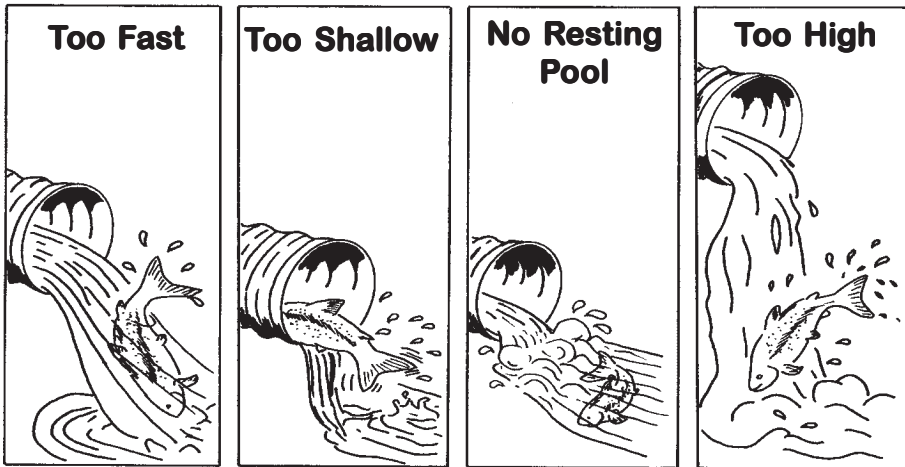


Figure 2.2b Poorly designed or installed culverts with “fish barriers” that prevent fish passage. (Redrawn from Evans and Johnston 1980)

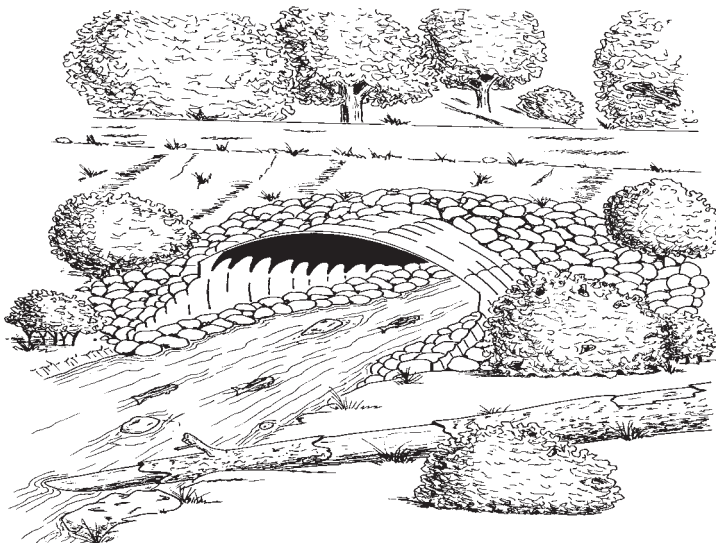


Figure 2.2c A fish “friendly” culvert (pipe arch) with a natural stream channel bottom that promotes fish passage and is wide enough to avoid constricting the normal or “bankfull” flow.

RECOMMENDED PRACTICES

- Use the Environmental Analysis Process early during project planning and development.
- Open project information to public scrutiny.
- Involve all parties affected by the project, as well as key Interdisciplinary Team members.
- **Communicate, Communicate, Communicate!!!** Communications between all interested parties is the key to understanding the issues and problems and to finding solutions!

PRACTICES TO AVOID

- Waiting until a project is fully planned or problems develop before doing Environmental Analysis.
- Getting lost in the “process” of EA studies.

Table 2.1

An EIGHT Step Environmental Analysis Process and Its Associated Outputs

1. Identify the Project	Identify the purpose and need of the proposed action. Develop a goal to provide a framework for EA.
2. Scoping	Identify the issues, opportunities, and effects of implementing the proposed action.
3. Collect and Interpret Data	Collect data. Identify probable effects of project implementation.
4. Design of the Alternatives	Consider a reasonable range of alternatives. Usually at least three alternatives are considered. Include a No-Action Alternative. Consider the mitigation of negative impacts.
5. Evaluate Effects	Predict and describe the physical, biological, economic, and social effects of implementing each alternative. Address the three types of effects -- Direct, Indirect, and Cumulative.
6. Compare Alternatives	Measure the predicted effects of each alternative against evaluation criteria.
7. Decision Notice and Public Review	Select preferred alternative. Allow for review and comment by the affected and interested public.
8. Implementation and Monitoring	Record results. Implement selected alternative. Develop a monitoring plan. Insure that EA mitigations are being followed.



Photo 2.3 A bottomless arch pipe culvert that spans the active stream channel and doesn't constrict the flow, maintains a natural stream bottom, and helps promote fish passage. (Photo provided by S. Wilson-Musser)

- Avoiding costly modification during construction;
- Determining the proper balance between roads needs and environmental impacts (*Figure 2.1*);
- Increasing project acceptance by the public;
- Avoiding negative impacts and violations of laws and regulations (*Photo 2.4*);
- Improving project design and performance (*Photo 2.5*);
- Producing a healthier environment by avoiding or mitigating problems (*Figure 2.2*, *Photo 2.6*); and
- Minimizing conflicts over natural resource use.

Examples of typical environmental mitigation measures associated with roads projects that have been developed as a result of environmental analysis are:

- Additional road surface cross drainage structures to reduce water concentration and subsequent erosion problems;
- Relocation of a road to avoid a meadow or sensitive area;
- Addition of extra culvert pipes to keep flows spread out across a meadow and prevent gully formation from concentrated flows;



Photo 2.4 Adverse environmental impact from road surface erosion caused by steep road grades and insufficient cross-drains. This road is also difficult to maintain.

- Route location to avoid fragmentation of wildlife habitat or avoid sensitive species areas;
- Addition of wildlife crossings, such as overpasses or underpasses (*Photo 2.7*), or using reduced speed zones at animal migration routes to reduce the number of animals killed crossing highways;
- Increasing culvert pipe size, using bottomless arch culverts, or building a bridge to maintain a natural stream channel bottom, avoid channel disturbance and



Photo 2.5 A well designed, “minimum impact” road that has an appropriate standard for its use, good drainage, and stable slopes.

impacts on aquatic organisms, and promote fish passage;

- Adding aggregate or some form of paving to the road surface to reduce erosion, materials loss, and dust problems, as well as reduce maintenance frequency and improve rider comfort;
- Developing a project quarry using local materials, but located in a nonsensitive area, and reclaiming the site upon completion of the project; and
- Implementing specific revegetation and erosion control measures for a project, utilizing appropriate native species of vegetation and a local project nursery to provide adequate types of plants with fast growth, good ground cover, and deep roots (*Photo 2.8*).

Remember that Environmental Analysis is often required by law, but the process is intended to be a very useful planning tool to help make good decisions and improve projects.



Photo 2.6 Locate and manage roads to minimize degradation of water quality in local streams. Minimize the connectivity and amount of contact between roads and streams.

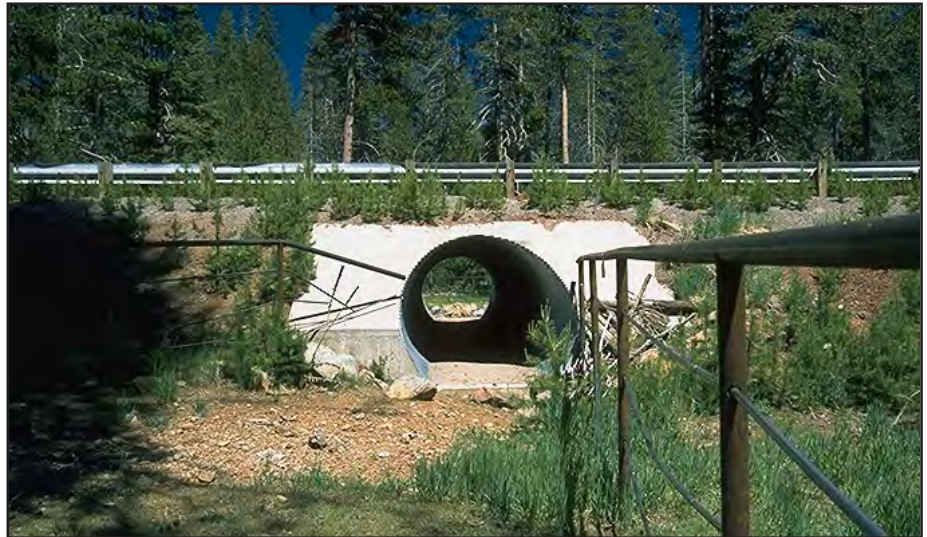


Photo 2.7 A road underpass constructed to allow animals to move safely from one side of the highway to the other.



Photo 2.8 Stream bank stabilization and revegetation work can be done in conjunction with road construction projects near a stream as an environmental mitigation measure.

Chapter 3

Planning Issues and Special Applications

“Assess the long term impacts and benefits of a road.”

KEY ROAD ISSUES should be addressed during the planning phase of a road project, prior to construction or upgrading roads. These key issues involve changes or impacts to an area that a road can cause that may be significant, irreversible, or difficult to mitigate. The benefits of a road project must be weighed against the long-term costs and impacts of that project. Once a road is built into an area, it can lead to long-term land use changes and unplanned growth, as shown in *Figure 3.1*. Sediment from roads can also be a direct source of water pollution. *Figure 3.2* shows some of the ways that roads directly contribute sediment to nearby streams when they are closeby and “hydrologically connected”. Thus the social, environmental and fiscal cost-effectiveness of the road need to be examined.

Key issues include the following:

- Impacts on area growth, land use, deforestation, and impacts on local communities or indigenous populations (influences beyond the Right-of-Way of the road) (*Figure 3.1*);
- Optimum road location and system to serve area needs as well as specific project needs.;
- Long term potential use of the road versus current use;
- The appropriate minimum design standard to serve the road user and meet road needs (“right” sizing a road) (*Photo 3.1*);
- Avoiding local water quality impacts and degradation (keep roads away from and disconnected from water courses), as well as improving or maintaining water quality standards (*Figure 3.2*) (*Photo 3.2 and 3.9*);
- Minimizing impacts on local plants and animals, both directly and indirectly;
- Ability to provide sufficient long-term road maintenance;
- Ability to have knowledgeable technical personnel as well as good, locally experienced individuals involved in road projects. Hire good people. Assure that they have the working tools available that they need to do the job;
- Identifying and avoiding problem areas such as landslides, wet areas, poor soils, or excessively steep grades.

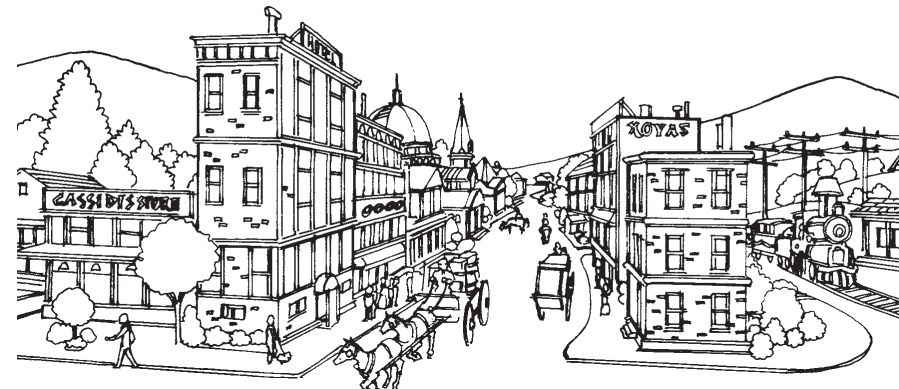
Indicators and Watershed Assessment for Problematic Roads

How do we decide when a road is creating or likely to cause problems? Today’s road managers are frequently faced with additional expectations

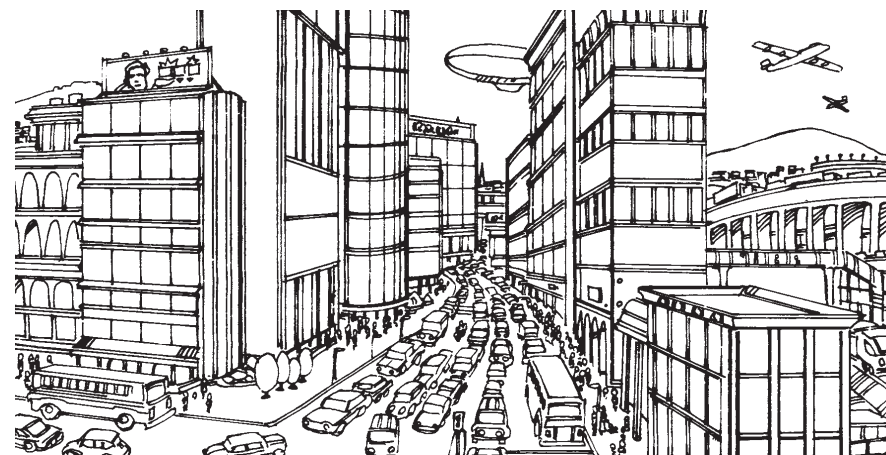
Figure 3.1 Planned and Unplanned growth along a road. Consider the long-term impact and consequences of road development. (Adapted from *Citizens for Responsible Planning*)



3.1a A low-volume road can become.....



3.1ba small road in a town after many years.....



3.1cand eventually become an overcrowded street in a city.

from society compared to those under which many low volume roads were originally constructed. Concerns about water quality, connectivity of roads and streams, endangered species, wildlife mortality and impacts, land use, and watershed and ecosystem health, are all influencing the way roads are viewed and managed. These concerns, along with economic concerns and dwindling budgets for maintaining low volume roads, are pressing road managers to better assess road conditions and impacts. They are now making reassessments about their road maintenance levels, design requirements, closure options, and storm-proofing methods.

Indicators are simple, tangible facts or conditions that can show progress towards goals or impacts. They can highlight trends, a need for additional studies, management opportunities, or needed design and construction modifications. The goals of assessment are to look for indicators and determine the impacts of roads on water, land, people, and related resources by reviewing road systems at the watershed or landscape scale.

The following issues should be considered:

- **Slope position and risk of slope failure.** Is there a risk of road or slope failure (and subsequent delivery of sediments to streams and sensitive resources) due to location of a road on an unstable or saturated hillslope, canyon, or valley bottom floodplain location?
- **Risk of road-stream crossing failure.** Does the road crossing



Photo 3.1 A low-volume, local road, with minimum adverse environmental impact, that serves local users by providing access between communities.

structure have adequate capacity for the site and adequate streambank protection?

- **Stream channel proximity and sediment delivery to water bodies and riparian areas (Photo 3.9).** Is the road too near a stream and are road-related sediments being delivered to wetlands, lakes, and streams?
- **Groundwater and surface water regimes.** Do roads intercept groundwater or interfere with direction, seasonal variation, or the amount of ground or surface water flows?
- **Wildlife, fisheries, and aquatic habitats.** What are the impacts of roads on fish and wildlife, migration routes, habitat fragmentation, and particularly sensitive species and their habitats, at both local and

landscape scales?

- **Human disturbance.** Is the road network responsible for poaching, dumping, off road

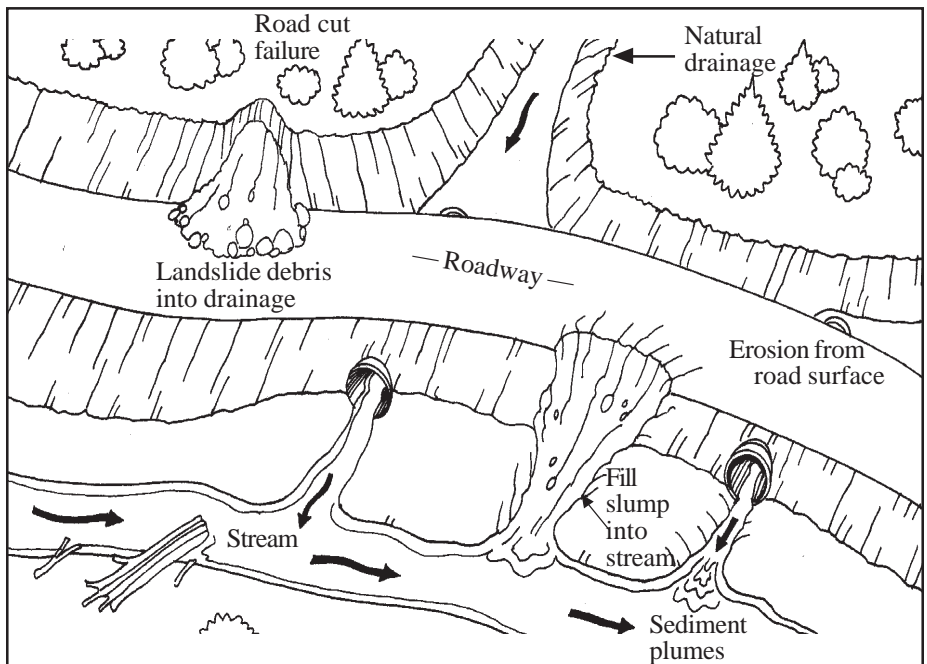


Figure 3.2 The many ways roads can be “connected” to streams and contribute sediment. Keep roads away from streams to protect water quality as well as reduce road maintenance and damage. (Adapted from M. Furniss, 1991)

vehicle use, illegal occupation and collecting, or pollution?

- **Road density.** Is the road system too big, inefficient, or wasting valuable land that has other, better uses?
- **Exotic species.** Is the road network responsible for the introduction and spread of exotic, non-native plants and animals?

A “yes” answer to any of the questions above can indicate the need for a more detailed assessment of existing or potential roads impacts. Additional information on assessments can be found in references such as the USDA’s, *Forest Service Roads Analysis*, 1999, or the Environmental Protection Agency’s *National Management Measures to Control Nonpoint Source Pollution*, Draft 2001.



Photo 3.2 A poor road location where the road has become a “creek” and is hydrologically “connected” to streams around it.

Reducing Vulnerability of Roads to Natural Disasters

Natural disasters such as major storms or earthquakes can have a major impact on all aspects of life and on infrastructure. When transportation systems are needed the most they may not be functional. Roads that are

damaged or closed during natural disasters often compound the effects of the disaster.

An assessment of the vulnerability of planned or existing roads should be made, considering the factors listed below, as well as social and

physical factors that affect the selection or priority of a project. Social factors include local community support and identified need of a project, the ability to do long-term maintenance, and contributing agencies or communities. Physical factors include avoiding problematic areas, feasibility of repairs or reconstruction, traffic use and standard of the road, and cost. An assessment is useful to identify and minimize problems and ideally reduce the potential impact to roads from disasters before they occur!

Many planning and design factors can be used to reduce the vulnerability of roads to natural disasters, or, in other words, used to “storm-proof” or limit the damage to roads during disasters or catastrophic events. PIARC World Roads Association’s *Natural Disaster Reduction for Roads*, 1999, provides excellent information on the topic. Some key considerations applicable to low-volume roads include the following:

- Identify areas of historic or potential vulnerability, such as geologically unstable materials or areas, areas subject to flooding, or areas with high volcanic or seismic hazards.
- Avoid problematic areas and road locations in areas of high natural hazard risk, such as landslides, rock-fall areas, steep slopes (over 60-70%), wet areas, and saturated soils.
- Avoid or minimize construction in narrow canyon bottoms or on flood plains of rivers that will inevitably be inundated during major storm events (*Photo 3.3*).



Photo 3.3 A poorly located road, in the hazardous flood plain area of a river, that has washed out during a major storm event.

- Provide good roadway surface drainage and rolling road grades so that water is dispersed off the road frequently and water concentration is minimized.
- Minimize changes to natural drainage patterns and crossings to drainages. Drainage crossings are expensive and potentially problematic, so they must be well designed. Changes to natural drainage patterns or channels often result in environmental damage or failures.
- Out slope roads whenever practical and use rolling dip cross drains for surface drainage rather than a system of ditches and culverts that require more maintenance and can easily plug during major storm events (*Photo 3.4*).
- Use simple fords or vented low-water crossings (vented fords) for small or low-flow stream crossings instead of culvert pipes that are more susceptible to plugging and failure. With fords, protect the entire wetted perimeter of the structure, protect the downstream edge of the structure against scour, and provide for fish passage where needed.
- Perform scheduled maintenance to be prepared for storms. Ensure that culverts have their maximum capacity, that ditches are armored and cleaned (*Photo 3.5*), and that channels are free of debris and brush than can plug structures. Keep the roadway surface shaped to disperse water rapidly and avoid areas of water concentration.



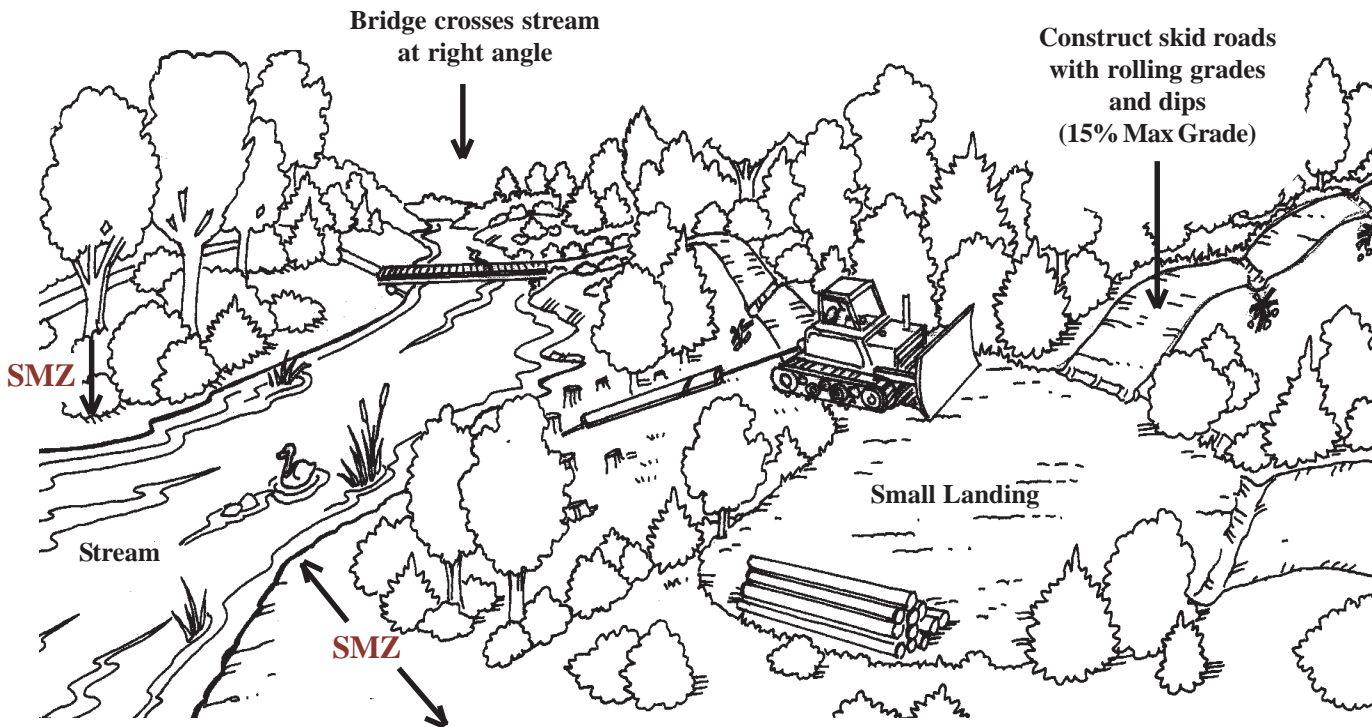
Photo 3.4 A road that has been heavily damaged during a storm because of an undersized, plugged culvert pipe and no overflow protection.

- Keep cut and fill slopes as flat as possible and well covered (stabilized) with vegetation to minimize slumping as well as minimize surface erosion. However, near-vertical slopes that minimize the exposed surface area may best resist surface erosion for well-cemented but highly erosive soils.
- Use deep-rooted vegetation for biotechnical stabilization on slopes. Use a mixture of good ground cover plus deep-rooted vegetation, preferably with a native species, to minimize mass instability as well as offer surface erosion control protection.



Photo 3.5 Maintain roads and drainage features to withstand major storm events with minimum erosion, such as with armored ditches that are kept clean.

Figure 3.3 Streamside Management Zone (SMZ) Activities



Winch logs from the SMZ. Construct small safe, efficient landing. Minimize activities in the SMZ. Keep landings and skid roads out of the SMZ.

- Locate bridges and other hydraulic structures on narrow sections of rivers and in areas of bedrock where possible. Avoid fine, deep alluvial deposits (e.g., fine sand and silt) that are scour susceptible and problematic or that otherwise require costly foundations. Avoid mid-channel piers.
- Design critical bridges and culverts with armored overflow areas near the structure to withstand overtopping, or that have a controlled “failure” point that is easy to repair. Alternatively, over-size the structure and allow for extra

freeboard on bridges to maximize capacity and minimize risk of plugging. Also avoid constricting the natural channel.

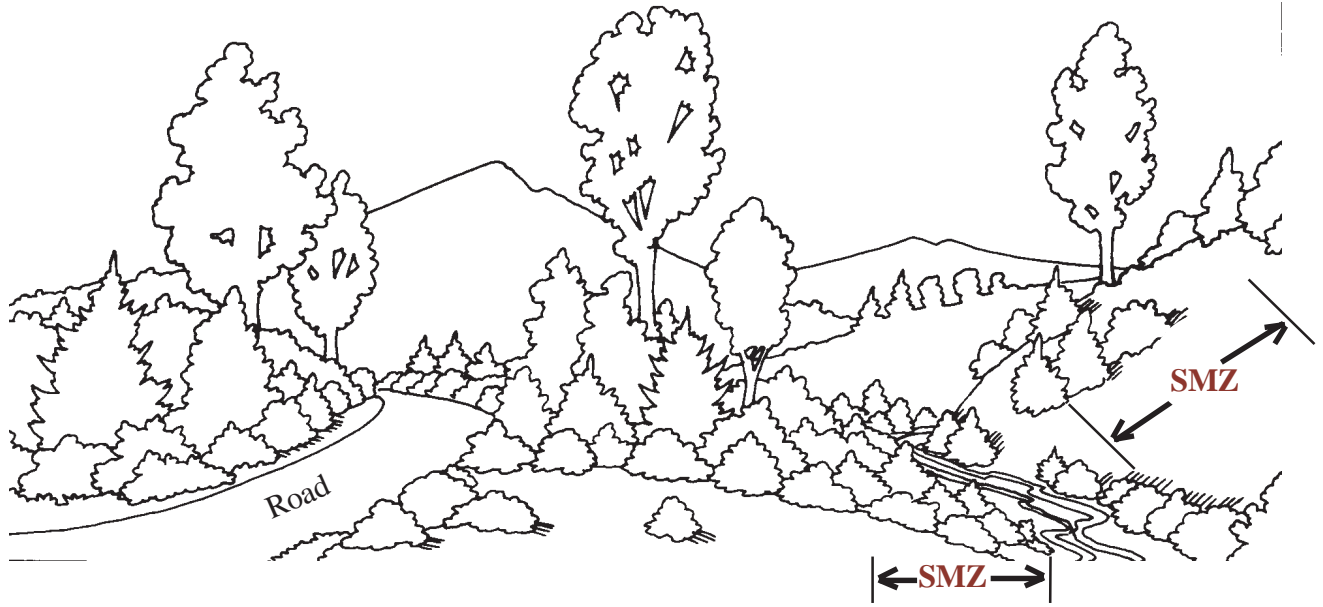
- Ensure that structural designs for bridges, retaining walls, and other critical structures include appropriate seismic design criteria and have good foundations to prevent failures during earthquakes.
- Place retaining structures, foundations, and slope stabilization measures into bedrock or firm, in-place material with good bearing capacity to minimize undermining and

foundation failure, rather than placing these structures on shallow colluvial soil or on loose fill material.

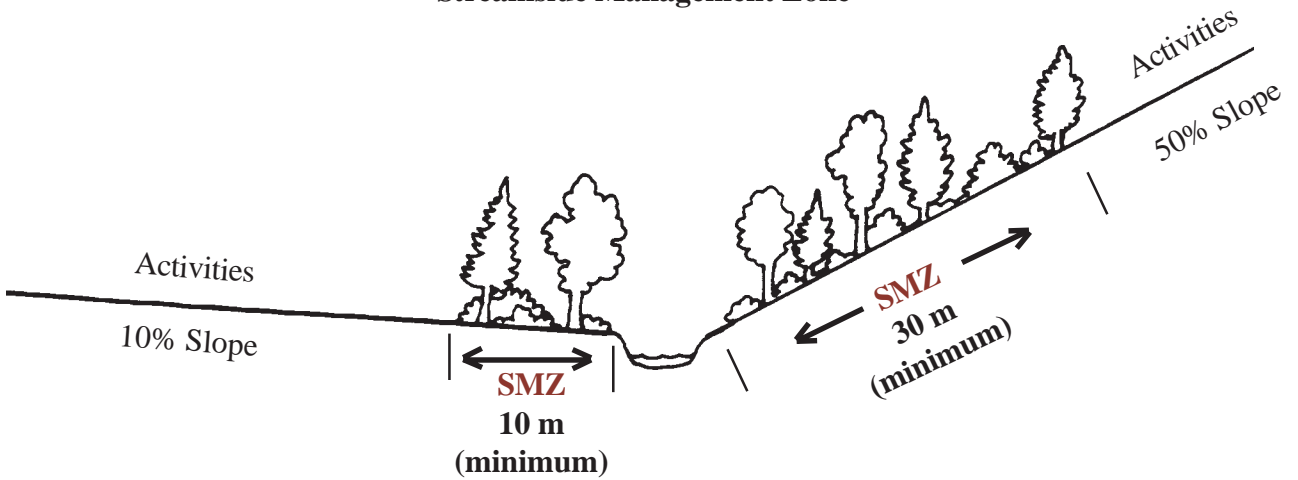
Streamside Management Zones

Streamside Management Zones (SMZs), or riparian reserves, are those areas adjacent to natural streams and rivers that require special consideration during construction or forestry operations. These SMZs are important zones for protecting water quality by serving as buffer zones to filter sedimentation that may occur from road construction and other land disturbance activities such as logging or quarry development.

Figure 3.4 Streamside Management Zone (SMZ) Widths as a Function of Slope. (See Table 3.1)



Streamside Management Zone



Activities may not need to be eliminated in SMZs, but they should be minimized and modified to ensure that stream channels and stream banks are protected from disturbance, as seen in *Figure 3.3*. The width of the SMZ will vary with the natural ground slope on each side of the stream and with the erosion potential of the soil (*Figure 3.4*). Steeper ground slopes will increase the possibility of sediment reaching the stream. *Table 3.1* gives a recommended minimum width of the

Table 3.1

Recommended Minimum Widths for SMZs

Ground Slope	*Slope Distance Width of SMZ
0 - 20 %	10 m
21 - 40 %	20 m
41 - 60 %	30 m
60% +	40 m

**Note-The indicated slope distances should be roughly doubled in areas with highly erosive soils, areas with bare ground or minimal ground cover, areas of intense rainfall, and near sensitive streams with fish.*

PRACTICES TO AVOID

- Getting construction debris in lakes and streams.
- Using mechanized equipment within the SMZ.
- Road or landing construction within the SMZ.
- Contaminating forest soils with fuel and oils.
- Cutting trees that shade the stream and cool the water.

RECOMMENDED PRACTICES

- Plan landings and access roads as part of pre-harvest activities.
- Limit the number of landings and constructed access roads.
- Keep landings small, consistent with a safe and efficient operation (*Photo 3.7*).
- Locate landings outside the SMZ (*Figure 3.3*).
- Construct landings with enough slope to drain properly but not exceed 5 percent.
- Locate landings to avoid skidding patterns that concentrate water from the skid roads onto the landing or off the landing into local streams.
- Maintain landings prior to and during periods of wet weather to avoid erosion problems.
- During and after operations are completed, rehabilitate landings and access roads with water diversion structures and erosion control measures.



Photo 3.6 Select the width of the Streamside Management Zone (SMZ) in accordance with the natural ground slope, amount of vegetation, and soil type. Minimize activities and disturbances in the SMZ.

SMZ. The actual width of the SMZ should be determined by the local land manager or an Interdisciplinary Team. The decision should be based upon local laws and regulations, as well as slope angle, soil type, vegetative cover, and sensitivity of the area (*Photo 3.6*).

Timber Harvesting

Timber harvesting activities should be accomplished in a manner that will insure the long-term protection of water quality. Timber harvesting requires access roads and landings in order to move forest products to markets. Different types of harvest systems require different road standards and road spacing to



Photo 3.7 Locate logging roads and landings away from SMZ's and water courses. Keep the roads and landing areas small and efficient.

be efficient. Generally speaking, roads and landings (not skidding and hauling operations) have the greatest potential for impacting water quality. When care is taken, erosion and sedimentation can be minimized.

Road Spacing

Total harvesting efficiency is a combination of logging costs and road costs. Animal logging is effective at very short skidding distances and requires a dense network of roads and landings, whereas helicopter logging can be effective at much greater distances and thereby uses a much wider spacing of roads and landings.

Road Standards

The type of harvest system used determines the size and location of forest roads. Generally, the type of haul vehicle determines the road standards of width, surfacing, alignment, grade, and position on the slope. In some cases, a large piece

of harvesting equipment such as a cable yarder may require special road standard considerations. The size and location of landings are also determined by the type of harvest system as well as other factors such as volume and type of product. High production systems will require larger, better stabilized, and more protected

landings than will low production systems. Larger landings and higher production systems have greater potential to cause water quality impacts.

Log Landings

Log landings should be located so that soil movement from the landing and skidding operations is minimized both during and after logging operations. Erosion control measures should be planned to effectively stabilize the landing using grading to control water flow, water bars, and revegetation or other ground cover.

Skid Roads and Skid Trails

Skidding should be conducted in such a way that soil disturbance is minimized. Skid trails and constructed skid roads can be a major impact to soil and water resources. Care and attention must be given to skid roads just as with truck roads, and the same Best Management Practices apply for these types of roads.



Photo 3.8 Stabilize skid roads and trails after use with water bars and apply a ground cover or other erosion control measures.

RECOMMENDED PRACTICES

- Design and locate main skid roads and trails before logging operations begin.
- Design and locate skid roads to follow the contour of the natural terrain.
- Winch logs from the SMZ or areas of steep slopes to avoid equipment movement in this area.
- Locate skid roads and trails in such a way that water from the skid trail is not concentrated into the log landing or into creeks (*Photo 3.9*).
- Cross natural drainages at right angles with skid roads.
- Construct skid roads with rolling grades and breaks in grade.
- Stabilize skid roads and trails with water bars and cover the bare ground with logging slash after operations cease to minimize erosion from exposed soils (*Photo 3.8*).
- Construct skid roads on grades of 15% or less except for short distances (20 meters) where 30% pitches (grades) are acceptable.
- Decommission or close skid roads after timber removal operations.

PRACTICES TO AVOID

- Contaminating forest soils with fuel and oils.
- Locating landings and skid roads within the SMZ.
- Using stream channels as skid trails.
- Constructing skid roads on steep slopes or with steep road grades.
- Operating skidding equipment within the SMZ.
- Logging and construction operations during wet weather.

Photo 3.9 Locate logging and other roads away from streams and lakes. This road is too close and thus is hydrologically “connected” to the stream. Sediment from the road will likely reach the stream.



Chapter 4

Low-Volume Roads Engineering

“You get what you Inspect, not what you Expect.”

A **LOW VOLUME ROAD** is considered a road that has relatively low use (an Average Daily Traffic of less than 400 vehicles per day), low design speeds (typically less than 80 kph), and corresponding geometry. Most roads in rural areas are low-volume roads. A well planned, located, designed, constructed, and maintained low-volume road system is essential for community development, flow of goods and services between communities, and resource management activities. However roads, and particularly road construction, can create more soil erosion than most other activities that occur in rural areas. Proper planning and design of the road system will minimize adverse impacts to water quality. Poorly planned road systems can have high maintenance and repair costs, contribute to excessive erosion, and fail to meet the needs of the users.

It is very important from the outset to locate roads on stable ground, on moderate slopes, in dry areas away from drainages, and away from other problematic and difficult areas. Avoiding problem areas can save major design, construction, and maintenance costs and can minimize many undesirable impacts.

For a road project to be successful, each step of the road management process must be performed.

The basic steps are:

Planning
Location
Survey
Design
Construction
Maintenance

If any one of these steps is omitted, a road may perform poorly, not meet its expectations, fail prematurely, require unnecessarily high maintenance, or cause environmental impacts. Without planning and good location, a road may not adequately serve its users or may be in a problematic area. Survey and design are needed to fit the road to the ground and have it function properly. Good construction insures that the design is implemented and built with some degree of quality control. Maintenance is needed to keep the surface drivable and the drainages functioning. Finally, a bad road may need to be reconstructed or closed (decommissioned) to eliminate unacceptable problems.

Road Planning

Road planning and analysis are key to ensuring that a road meets the current needs of the users, that it is not overbuilt, that it minimizes impacts to the environment and to the people along the road, and that it considers future needs of an area. Road Management Objectives (RMOs) help define and document the road purpose,

BEST MANAGEMENT PRACTICES

Some key Best Management Practices for road design and construction include the following:

- Minimizing road width and area of disturbance;
- Avoiding alteration of natural drainage patterns;
- Providing adequate surface drainage;
- Avoiding steep ground with slopes over 60 percent;
- Avoiding problems such as wet and unstable areas;
- Maintaining an adequate distance or separation from creeks and minimizing the number of drainage crossings;
- Minimizing the number of “connections” between roads and water courses, and minimizing “diversion potential”;
- Designing creek and river crossings with adequate capacity and bank erosion protection and allowing for fish passage at all stages of life;
- Avoiding constriction of the active (bankfull width) stream channel;
- Having a stable, structurally sound road surface;
- Installing subsurface drainage where needed;
- Reducing erosion by providing vegetative or physical ground cover on cuts, fills, drainage outlets, and any exposed or disturbed areas;
- Using stable cut and fill slope angles;
- Using slope stabilization measures, structures, and drainage as needed;
- Applying special techniques when crossing meadows, riparian areas, and when controlling gullies;
- Providing thorough, periodic road maintenance; and
- Closing or obliterating roads when not in use or when they are no longer needed.

standards, and how a road will be used, managed, maintained, and funded, as well as applicable BMPs for the road.

RECOMMENDED PRACTICES

Planning

- Do road transportation analysis to determine the optimum road system for an area, user needs, and to evaluate future options.
- Keep minimum road standards consistent with user demands, needs, Road Management Objectives, and public safety.
- Use an Interdisciplinary Team approach to road planning, and coordinate development with local landowners.
- Use topographic maps, aerial photos, and soils information for planning the optimum route.
- Consider both short-term and long-term access needs of the road users.
- Limit the total area disturbed by minimizing the number, width, and length of roads.
- Use existing roads only if they serve the long-term needs of the area and can be reconstructed to provide adequate drainage and safety.
- Minimize the number of stream crossings.

Road Location

Road location is key to ensuring that a road is placed in a desirable area, that it avoids problematic features or areas where construction is very expensive, that it best accesses areas where the road is needed, and that it minimizes the driving distance between destinations. Flag or mark the proposed road location **on the ground** to ensure that it meets the road design criteria (*Photo 4.1*).

It is much better to have a bad road in a good location than it is to have a good road in a bad location. A bad road can be fixed. A bad location cannot. Most of the investment in the bad road can be recovered, but little, if any, can be recovered from a bad location!

Road Survey, Design, and Construction

Road survey, design, and construction are the steps in the process where road user needs are combined with geometric factors and terrain features, and the road is built on the ground. A road or site survey is needed to identify the terrain features, such as drainages, outcrops, and ground slopes, and to add some level of geometric control to a project. A survey may be very simple and accomplished with compass and cloth tape for a rural road, or it may be very detailed using instruments and a high level of precision in difficult terrain or for a high standard road.



Photo 4.1 Plan and locate roads using topographic control points and natural ground features. Verify road location and alignment on the ground!

RECOMMENDED PRACTICES

Location

- Use topographic control points and physical features to control or dictate the ideal location of a road. Use saddles in the terrain, follow ridges, and avoid rock outcrops, steep slopes, stream crossings, etc.
- Locate roads to avoid or minimize adverse affects on water quality and outside of riparian areas and SMZs except at stream crossings. Approach stream crossings at the least gradient possible.
- Locate roads high on the topography to avoid steep inner canyon slopes and provide for more distance between the road and streams.
- Locate roads on well-drained soils and slopes where drainage will move away from the road.
- Locate roads to follow the natural terrain by conforming to the ground, rolling the grade, and minimizing cuts and fills (*Figure 2.1* and *Figure 4.1, Photo 4.2*).
- Locate roads, switchbacks and landings on bench areas and relatively flat terrain.
- Avoid problematic locations such as springs, wet areas, landslides, steep slopes, massive rock outcrops, flood plains, and highly erosive soils.
- Avoid very steep terrain (over 60%) and very flat terrain where drainage is difficult to control.

Elements of design include roadway geometry, design speed, drainage, stream crossing structures, slope stabilization needs, structural sections (materials type, use, and thickness), and road grades (*Table 4.1*). Construction involves all aspects of implementation of the design and fitting the project to the ground. A key link between design and construction are the use of **standard plans and drawings** that show how the work should look, and **specifications** that describe how the work is to be done. Another key part of construction is **quality control and inspection** to ensure that the work is done in

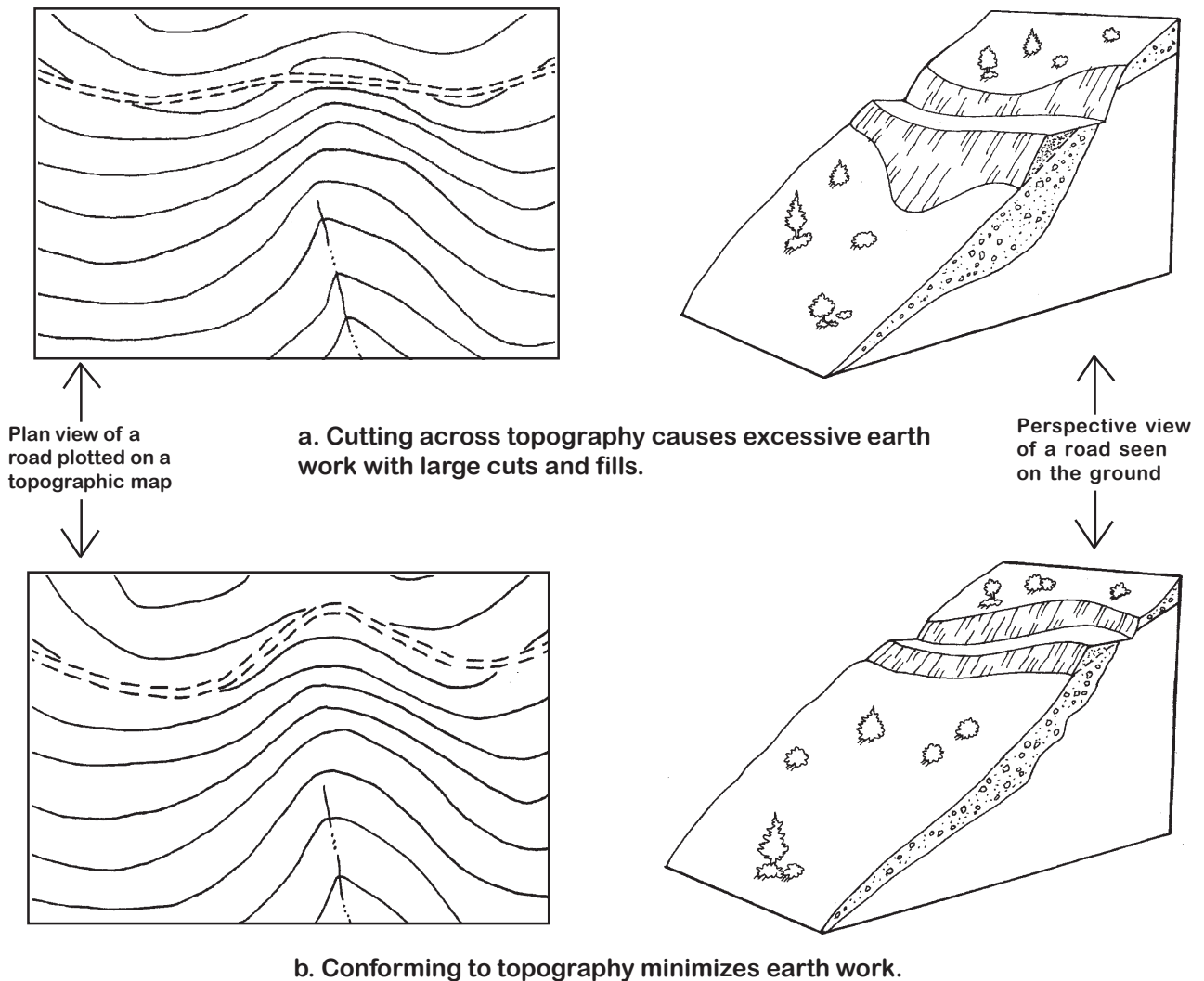
accordance with the plans and specifications. Some amount of **sampling and testing** is typically specified to ensure that the materials used in construction meet specifications.

***Remember --
You get what you Inspect,
not what you Expect.***



Photo 4.2 Locate roads to conform to the natural terrain and roll the road grades to disperse surface water frequently.

Figure 4.1 The affects of road alignment across topography.



RECOMMENDED PRACTICES

General Design

- Use minimum Road Standards needed for safety and traffic use (*Table 4.1*).
- Use Standard Plans and Specifications, with Standard Drawings, for most typical construction work. Develop Special Project Specifications and Drawings for unique types of work.
- Remove merchantable timber from the road right-of-way before excavation. Deck the material in a designated area.
- In community and urban areas, build footpaths along the road for the safety of people walking along the road. Use roadway surfacing and speed bumps to control dust and traffic speed.
- Construct roads with grades of 12% or less, using short sections of 15% where necessary. On steep roads, drainage is difficult to control (*Photo 4.3*)!
- Construct the road only wide enough to safely pass the traffic, normally 3.5 to 4.5 meters wide for single-lane roads and 5 to 7 meters for double-lane roads. Add turnouts as needed. Minimize the area of clearing.

- Locate roads with a minimum curve radius of 15 meters.

Materials

- Compact the road embankments, subgrade material, and surfacing materials, particularly in sensitive areas (*Photo 4.4*), or allow new roads to “settle” for several weeks before using the road. In wet climates a longer period of time is desirable.
- Use road surface stabilization measures, like aggregate or pavements, where needed and as often as possible (*Photo 4.5*). Utilize durable materials that will not degrade to fine sediments under traffic.
- Dispose of unsuitable or excess excavation material in locations that will minimize water quality or other adverse resource impacts.
- Establish minimum sampling and testing requirements and schedule for quality control of materials.

Slopes

- Typically construct cut slopes on a 3/4:1 or flatter slope. Build fill slopes on a 1½:1 or flatter slope. Revegetate the slopes.
- Typically use balanced cut-and-fill construction in gentle terrain. Use full-bench

construction on slopes over 65 % and end haul the excavated material to a suitable disposal site.

- In very steep terrain build narrow roads (3-4 meters wide) with turnouts, or use retaining walls as needed. End-haul most excavated material to stable disposal sites. Avoid side-casting.

Drainage

- Outslope road surface 3-5% for road grades less than 10% on stable soils, using rolling dips for cross-drainage structures. In slippery soils, either inslope the road or add aggregate surfacing to the road.
- Construct ditches only when necessary. An outsloped road without ditches disturbs less ground and is less expensive to construct.
- Inslope road surface 3-5% with a ditch section for road grades in excess of 10% or in areas with steep natural slopes, erodible or slippery soils, or on sharp turns. Provide cross drainage with culvert pipes or rolling dips.
- Use a crown road section on a wide road with gentle slopes or flat ground to prevent water from standing on the road surface (see *Figure 7.1*).

RECOMMENDED PRACTICES (cont.)

Drainage (cont.)

- Construct roads with rolling grades to minimize concentration of water.
- Provide filter strips or infiltration areas to trap sediment between drain outlets and waterways. Keep roads and streams disconnected!
- Use appropriate type and adequately sized drainage structures for natural stream crossings. Design bridges and culverts that are large enough to span the ordinary high water width of flow (bankfull width). Use armoring, headwalls, and trash racks as necessary to protect the structure (*Photo 4.6*).
- Divert water and stream flows around construction areas as needed to keep the construction site dry and avoid water quality degradation. Restore natural channels as soon as possible after construction.

Erosion Control

- Remove windrow slash, tops, tree trunks and stumps

from the right-of-way at the toe of the fill slope before excavation for erosion control (*Figure 4.2*). The quantity of material may be limited for fire hazard.

- Require a final Erosion Control Plan and interim erosion control measures during seasonal shutdowns. Stabilize all disturbed areas, work areas, and temporary roads. Include typical drawings for sediment traps, brush barriers, silt fences, biotechnical structures, and so on.

Miscellaneous

- Develop dependable local water sources for project construction and maintenance needs where possible. Construct a well located, durable, stabilized site that will protect water quality and aquatic life. The timing and amount of water withdrawal may require control.
- Use construction techniques that are the most appropriate and cost effective for the project and geographic area, using either equipment or hand labor (*Photo 4.7*).

- Use best available appropriate technologies, such as Global Positioning Systems (GPS), personal computer programs, geotextiles, biotechnical erosion control measures, Mechanically Stabilized Earth (MSE) retaining structures, and soil stabilization materials where applicable.
- Minimize earthwork activities when soils are very wet or very dry or before oncoming storms. Time road construction activity and road use for the milder, drier seasons where possible (*Photo 4.8*).
- Use traffic control devices as necessary to provide safety for construction personnel and road users.
- Visit the field during both the design and construction phases of a project. Ensure that you have adequate inspectors, vehicles and quality control testing **to see that the job is built correctly.**

Road Costs

Road construction costs are most influenced by the standard of road built, particularly road width and type of surfacing, and the steepness of the terrain. Placing a

road with cuts and fills on steep cross slopes greatly increases the time of construction, the amount of excavation and earthwork, the areas of clearing and needed revegetation, and adds length to

cross-drains and other drainage structures. *Figure 4.3* shows the difference in quantities for road construction on a 10 percent side slope versus a 50 percent slope. *Table 4.2* presents those typical

Table 4.1

TYPICAL LOW-VOLUME ROAD DESIGN STANDARDS

Design Element	Rural Access Road	Collector Road
Design Speed	25-35 kph	45-60 kph
Road Width	3.5-4.5 m	4-5.5 m
Road Grade	15% max.	12% max.
Curve Radius	15 m min.	25 m min.
Crown/Shape	outslope/inslope (5%)	in/outslope or crown (5%)
Surfacing Type	native or gravel	gravel, cobble-stone or pavement



Photo 4.3 Avoid constructing roads with steep grades or on steep side slopes. It is difficult to control drainage with steep road grades.



Photo 4.4 Compact the roadway surface and fill material when the road is located near streams or in areas with erosive soils.

quantities for the major road work items. Ideal construction is in terrain with cross-slopes in the range of 25 to 35 percent.

Road cost estimates are important in both the planning process and the overall project budgets to ensure that adequate funds are available to properly build the road. Good design and construction techniques require relatively high initial costs but can greatly reduce future maintenance needs and avoid costly failures, repairs, and adverse environmental impacts.

KEY COST FACTORS

- Steep side slopes (particularly with wide roads) rapidly increase the quantities of work, including the area involved for clearing and revegetation, and the amount of excavated material. Thus, steep slopes greatly increase the cost of construction (see *Figure 4.3* and *Table 4.2*)!
- High standard surfacing materials (aggregate, asphalt, etc.) greatly increase road cost -- but also greatly improve user comfort and reduce road surface erosion.
- Frequent or large numbers of drainage (stream) crossings greatly increase road costs -- but must be used as needed, particularly in dissected terrain.
- Steep grades increase long-term maintenance costs of the road.



Photo 4.5 A stable logging road with aggregate surfacing. Use road surfacing materials as frequently as possible to reduce erosion and improve the roadbed structural support and rider comfort.



Photo 4.6 A well designed and installed culvert with head walls for efficiency and fill protection.

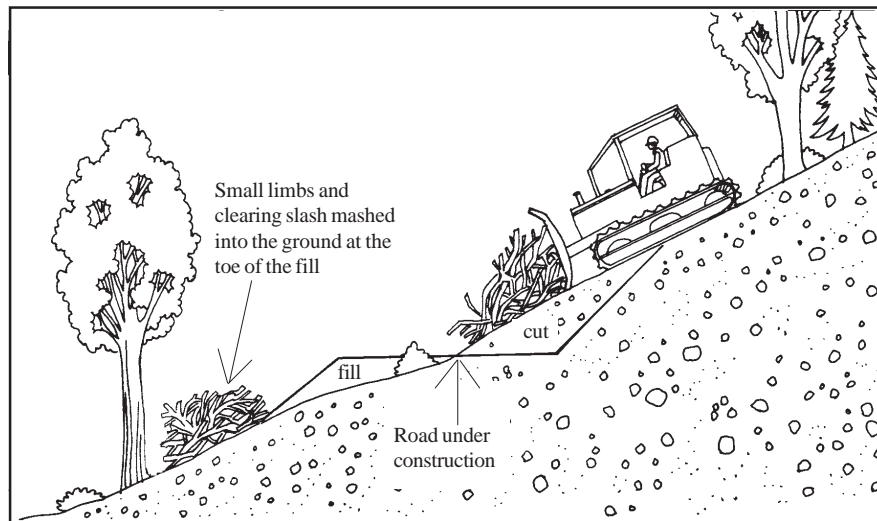


Figure 4.2 Windrow construction slash at the toe of the fill slope for erosion control. Place the slash before excavation begins. **Do not** bury the slash in the fill.



Photo 4.7 Use the road construction techniques that are most appropriate and cost-effective for the job and geographic area. Hand labor versus equipment depends on labor costs, equipment availability, and production rates.

PRACTICES TO AVOID

General Design

- Road construction on steep side slopes.
- Side-casting material on cross-slopes steeper than 50 to 60 %.
- Burying stumps, logs, slash, or organic debris in the fill material or in the road prism.
- Construction and resource extraction activities during periods of wet weather (see *Photo 4.8*).
- Steep road grades (over 12-15%). Water becomes very difficult to control.
- Vertical cut slopes, particularly on roads with inside ditches.
- Very flat areas (where drainage cannot be controlled).
- Locating roads within flood plains, riparian areas, wetlands, or the SMZ (except at crossings).
- Wet and spring areas, landslide areas, and large rock outcrops.
- Construction projects with **insufficient funds** for proper design, construction, inspection, and future maintenance. Consider building fewer kilometers of road, and building them well.

Figure 4.3 Road quantity variation with ground slope.

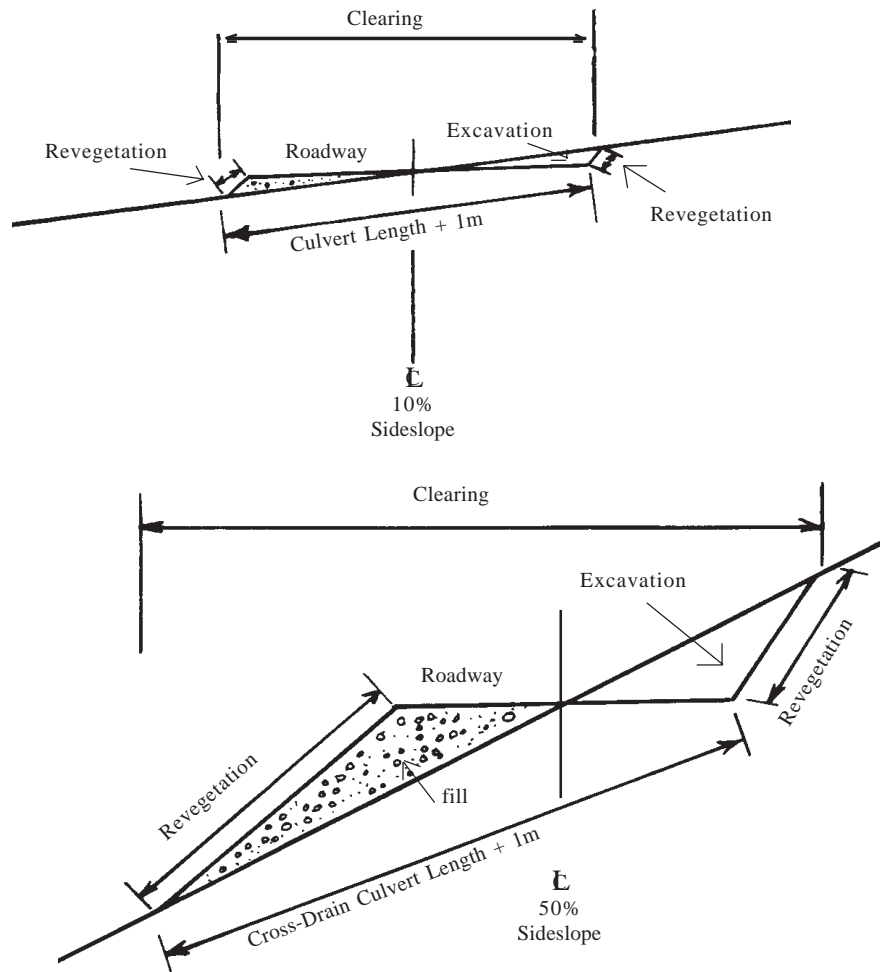


Table 4.2

TYPICAL QUANTITIES OF WORK & MATERIALS FOR ROAD CONSTRUCTION IN TERRAIN WITH GENTLE AND STEEP SLOPES (FOR A 4.5 M WIDE ROAD)

Work Item	10% Side Slope	50% Side Slope
Clearing	0.62 ha/km	0.95 ha/km
Excavation	237 m ³ /km	2220 m ³ /km
Revegetation (cut & fill slopes)	0.10 ha/km	0.89 ha/km
Culvert length (natural channel)	8 m	22 m
Culvert length (ditch relief crossdrain)	6 m	11 m

Road Maintenance

Rural roads must be maintained during active use, after periodic operations have been completed, and after major storm events, to ensure that the drainage structures are functioning properly. Heavy rainstorms will cause cut slope failures that block ditches, cause water flow on the road surface, and erode the surface and fill slopes (see *Figure 4.4*). Debris moves down natural channels during heavy rains and blocks drainage structures, causing water to overtop the road and erode the fill. Ruts, washboards, and potholes in the road surface will pond water, weaken the roadway structural section, accelerate surface damage, and make driving difficult, as shown in *Figure 4.5*. Routine maintenance is needed on any road to keep the road serviceable and its drainage system working properly. A well-maintained road will reduce road user costs, prevent road damage, and minimize sediment production.

How road maintenance will be accomplished should be resolved **before** the road is built or reconstructed. Maintenance work can be accomplished either by state or local agency personnel, by contractors, or by local community groups. Funding for maintenance may be allocated directly from agency funds, from local or gas taxes, from road user fees, or from donated local labor by interested road users.



Photo 4.8 Avoid construction and other road activities during wet periods when possible. Alternatively, add drainage and surface stabilization to the roadway in weak soil areas for all-weather use.

Key Road Maintenance Items

Maintenance items that should be performed routinely include:

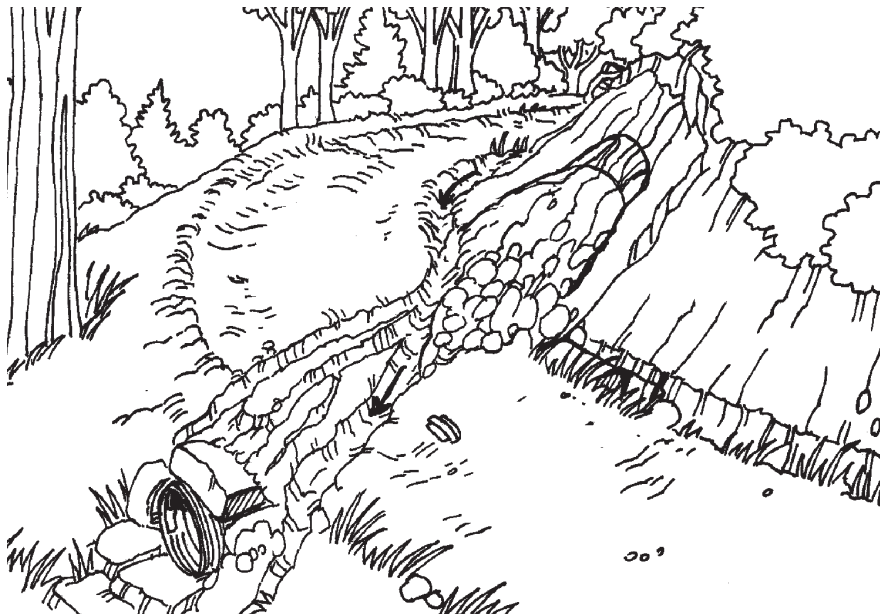
- Grading and shaping the roadway surface to maintain a distinct insloped, outsloped, or crown shape to move water rapidly off the road surface.
- Compacting the graded roadway surface to keep a hard driving surface and prevent the loss of fines. Replace surfacing material when needed. Keep the road surface moist!
- Removing ruts through rolling dips and water bars. Reshape the structures to function properly.
- Cleaning ditches and reshaping them when necessary to have adequate flow capacity. Do not grade ditches that do not need it!
- Removing debris from the entrance of culverts to prevent plugging and overtopping. Check for damage and signs of piping or scour.
- Replacing/repairing rock armor, concrete, or vegetation used for slope protection, scour protection, or energy dissipation.
- Trimming roadside vegetation (brushing) adequately, but not excessively, for sight distance and traffic safety.
- Replacing missing or damaged road information, safety, and regulatory signs.

RECOMMENDED PRACTICES

Maintenance

- Perform maintenance when needed. **DO NOT WAIT!** The longer you wait, the more damage will occur and repairs will be more costly.
- Keep ditches and culverts free from debris, but maintain an erosion resistant surfacing such as grass or rock in the ditches. Remove debris during inspections (*Figure 4.4, Photo 4.9*). Also keep overflow channels clean.
- Regrade and shape the road surface periodically to maintain proper surface drainage (*Photo 4.10*). Keep the road surface moist during grading. Fill in ruts and potholes with gravel or compacted fill as frequently as possible (see *Figure 4.5*). Keep rolling dips shaped and graded. Ideally, compact the final graded road surface.
- Keep the downhill side of the road free from a berm except where a berm is intentionally constructed to control water or traffic.
- Apply a surface stabilization material, such as aggregate, cobblestone, or pavement, to the road surface to protect the roadbed from damage and reduce the frequency of maintenance needed.
- Avoid disturbing soil and vegetation if not necessary. Leave as much vegetation (grasses) in ditches, on road shoulder areas, and on cut or fill slopes (especially grasses and low growing brush) as possible. However, ensure sight distance and that the drainage systems still function properly.
- Remove slide material from the roadway or inside ditches where the material will block normal roadway surface drainage (*Photo 4.11*).
- Avoid widening the road or oversteepening the fill slopes formed by blading surface material off the road.
- Close the road during very wet conditions or periods of inactivity.
- Inspect the road at regular intervals, especially following periods of heavy rains.

Figure 4.4 Road maintenance is needed to maintain roadway surface drainage patterns and remove slides that block ditches and culvert inlets.



Road Closure

A road may be closed because it is no longer needed, such as if a resource is depleted, if a community has moved, if it will not be used for some period of time, or if the road is causing unacceptably high maintenance costs or environmental damage. Road closure often involves input from the public and other affected road users. Basic road closure options include the following: **temporary closure** or blockage with gates, barricades or berms; **permanent closure, or decommissioning**, where the road surface is stabilized and drainage structures are removed, yet the road template is left on the terrain; or **road obliteration** where the roadway and drainage features are totally removed and the area is reshaped to its natural, pre-road condition. *Figure 4.6* shows the range of options commonly considered in road closure.

If interim road use has been completed, such as after logging or mining operations, roads should be temporarily closed or decommissioned in order to protect them from erosion during the period that they are not being used. **Temporarily closed roads** should be blocked with a gate, barricade or berm to keep traffic off the road but drainage crossing structures should be maintained. The road surface should be reshaped for good drainage and stabilized with water bars and possibly scarified, seeded and mulched. Permanent drainage structures such as culverts and ditches will require periodic cleaning. Use of road closure techniques and routine



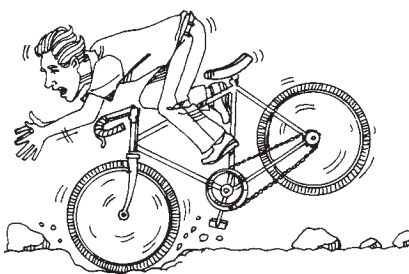
Photo 4.9 Perform road maintenance, either with equipment or by hand, to keep the roadway shaped and drainage structures functioning. Keep ditches clean but do not remove the layer of vegetative (grass) stabilization.



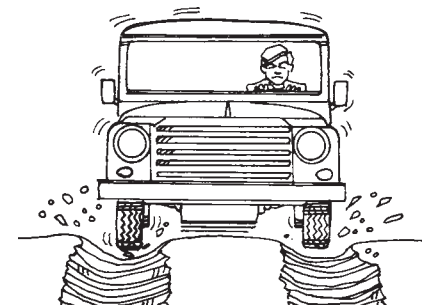
Photo 4.10 Use grader maintenance to keep the road surface properly shaped and drained.

Figure 4.5 Signs of need for road maintenance. (Adapted from *PIARC Road Maintenance Handbook*)

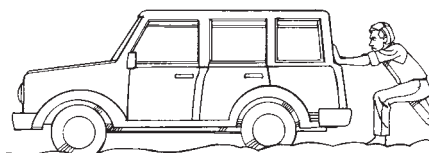
*Implement road maintenance
before significant surface damage occurs!*



Potholes



Ruts



Soft, muddy, roadway surface



Rills and gullies

maintenance after operations are completed will protect the road investment until it is needed in the future.

Permanent road closure (decommissioning) involves blocking the road, removing all drainage crossing structures and fill material, and stabilizing the road surface. This is commonly accomplished by breaking up the road surface (scarification), then seeding and mulching, so that the road will naturally be revegetated over time (*Photo 4.12*). The cost of this work is relatively inexpensive, most environmental damage from the road is eliminated, and the basic roadbed shape is still in place in case the road is ever reopened in the future.

Road closure by **obliteration** is where the roadbed is totally eliminated and the ground is restored



Photo 4.11 Remove slide material that blocks the drainage ditches and narrows the road.

to its natural terrain shape. All drainage crossing materials are removed, the ground is reshaped, natural drainage patterns are restored, ideally including subsurface groundwater flow patterns, and the area is revegetated. It is particularly important to remove all fill

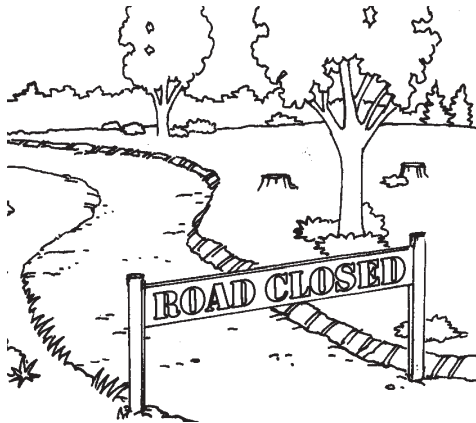
material that has been placed into drainages, such as the culvert backfill material. These relatively expensive measures are ideally used in sensitive areas such as parks or reserves, near recreation areas, or near streams and lakes. These measures are very effective to remove all traces of a road and

eventually restore the area to a pre-road natural condition. However, because of high cost, simple decommissioning is typically most cost-effective for road closure, and thus is the most commonly used closure option.

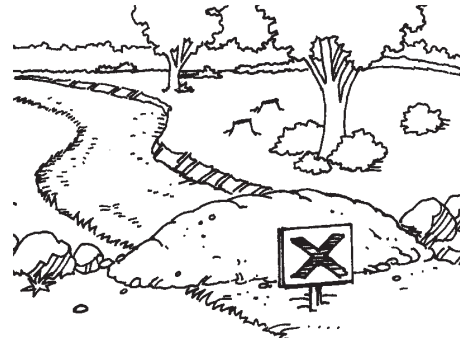


Photo 4.12 Close roads that are not needed. Stabilize the surface with water bars, berms, and ground cover such as grass seed and mulch.

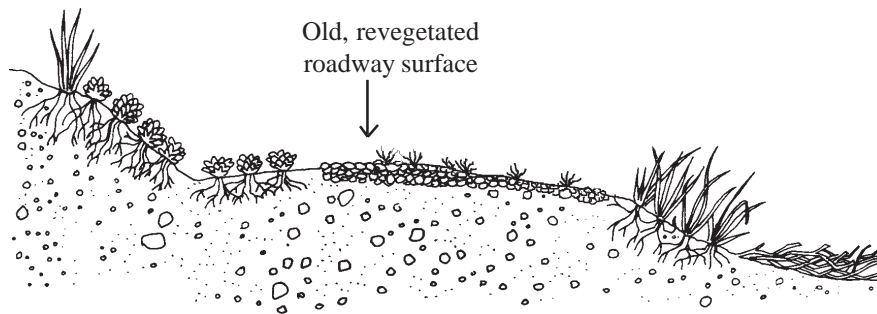
Figure 4.6 Road closure options, including temporary closure (a,b), decommissioning (c), and full road obliteration (d).



a. Gate Closure (Temporary)

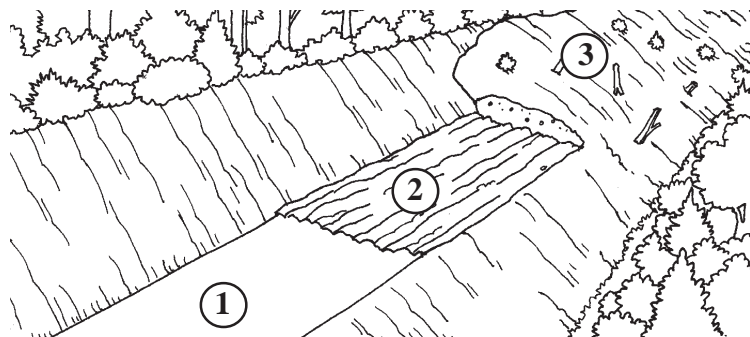


b. Earth Mound or Berm Closure (Temporary)



c. Decommissioning - Permanent Road Closure with Surface Scarification and Seeding for Revegetation, but Keeping Most of Road Template (Shape).

- (1) Road template before obliteration.
- (2) During obliteration, old road is scarified and refilled.
- (3) Final obliteration, with filling and recontouring to the original natural topography, followed by revegetation.



d. Road Obliteration

RECOMMENDED PRACTICES

Road Closure

- Involve the affected population or road users in decisions regarding road closure, typically using an interdisciplinary process.
- Temporarily close roads using gates, barricades, or large berms.
- Install water bars (See Chapter 7, Drainage) on closed roads to divert water off the road surface.
- Remove all drainage and stream crossing structures in permanently closed roads.
- Close roads by reshaping the roadbed to maintain natural surface drainage patterns and avoid concentration of water.
- Revegetate exposed soil on closed roads. A common treatment includes scarification, seeding, and a mulch application to promote grass and brush growth. Trees may be planted. On grades, waterbars should be added.
- Remove berms that may impede surface drainage on closed roads.
- Decommission roads with closure structures, drainage control, and erosion protection, but without recontouring the road template, if future use of the road is likely.
- Obliterate unneeded roads whenever possible and where cost-effective to provide the highest degree of road removal and land reclamation.

PRACTICES TO AVOID

- Leaving drainage structures on closed (decommissioned or obliterated) roads.
- Neglecting temporarily closed roads.



The paved road (above) and gravel road (below) are relatively well located and designed low-impact roads since their surfaces are armored and they conform to the terrain, thus dispersing water effectively and avoiding heavy earthwork.



Chapter 5

Hydrology for Drainage Crossing Design

“Base drainage structure size on some rational or statistical design process.”

DRAINAGE STRUCTURE SIZE should be based on some reasonable design flow, as well as site characteristics and environmental considerations such as fisheries (*Photo 5.1*). Determining the correct or a reasonable design flow for any engineered drainage structure is critically important, both for the structure to perform properly and to prevent failures of structures. A reasonable design flow is commonly based upon a storm event that will have a recurrence frequency (return interval) of 20 to 100 years, depending on type and value of the structure and local regulations. Any culvert has a finite flow capacity that should not be exceeded. Bridges also have a specific capacity for the given cross-sectional area, but typically it is large. Low-water crossing design is based upon estimates of both low flows and peak flows for that specific drainage, but are less sensitive to flow estimates.

Most flow determination methods require that the

drainage area be defined or estimated. This work is typically accomplished by delineating the area of the watershed on a topographic map (*Figure 5.1*). Ideally, topographic maps with a scale of 1:10,000 to 1:24,000 should be used for drainage project design. However, the most detailed map commonly available in many countries is a 1:50,000 scale, so that map should be used.



Photo 5.1 Determine an adequate design storm flow at any site using available, appropriate hydrological methods. Install drainage crossing structures based upon design flows and other site characteristics.

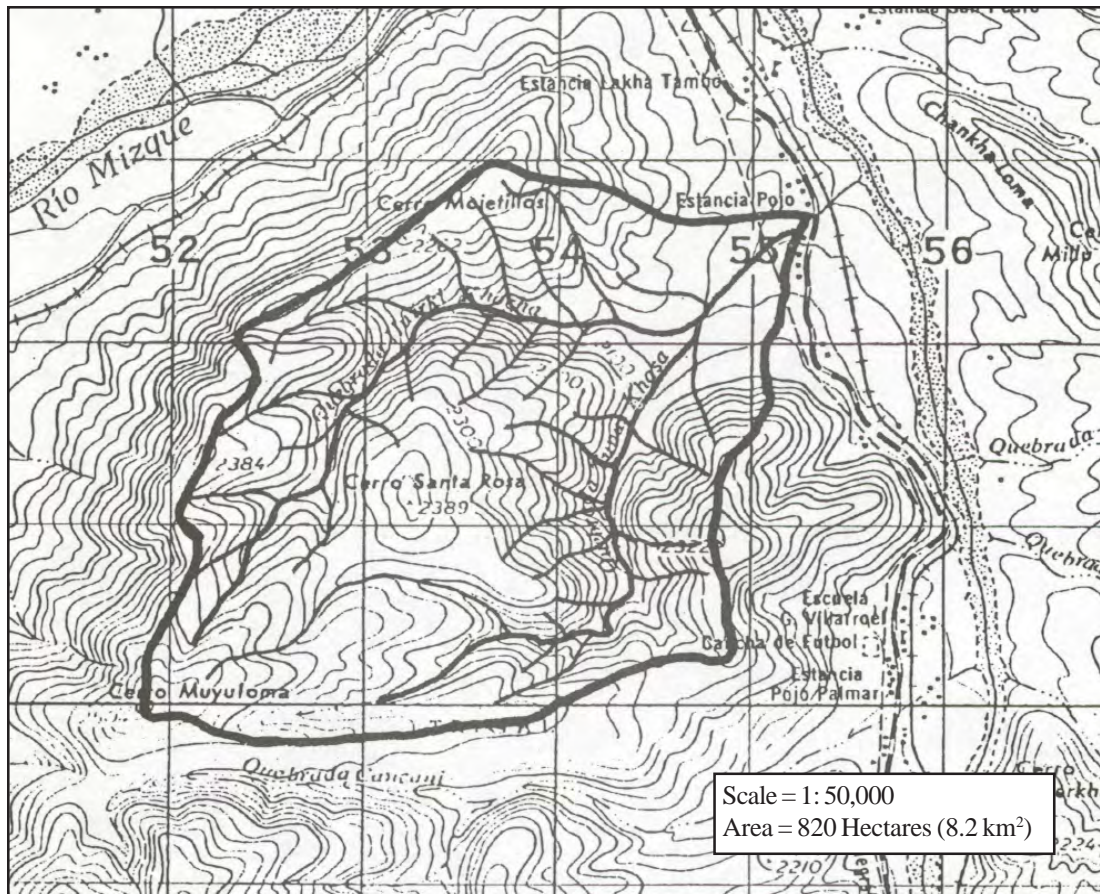


Figure 5.1 Determine the drainage area of watersheds on a topographic map to help determine appropriate flows for drainage structure design.

At a minimum, the Rational Method, a rainfall based method, should be used to determine the discharge from small watersheds, with a drainage area of up to around 120 hectares. The Talbot Method directly uses the Rational Method and can be useful in making a preliminary estimate of the pipe size needed as a function of drainage area. However, the Talbot Method does not consider varying rainfall intensity or return interval, so the method is not precise. Ideally, statistical methods based upon regression analysis of regional stream flow data, or actual local stream flow data will be available and can be used.

Large watersheds may have specific gauging station data that can

be examined statistically and used for hydraulic design to determine flows at different return intervals. High water marks and measurements of the channel geometry can be used in conjunction with Manning's Equation (see Chapter 6) to determine flow velocity and thus flow volume (discharge, or capacity) through the channel for that given high-water level. A variety of methods may be available to the designer to determine design flows. At least some analytical method should be used, and ideally, several methods should be used and compared to gain confidence in your design flow values. Typical analysis methods for varying sizes of watersheds are shown in *Table 5.1*.

Rational Method

The Rational Method is commonly used for the determination of flows from small watersheds, and it can be applied in most geographic areas. It is particularly useful if local stream flow data do not exist, and it can be used to make a rough estimate of flow from large watersheds if other options do not exist. Thus, the Rational Formula is presented and briefly explained on the next page. More detailed information on its use is presented in references such as the *Minimum Impact Low-Volume Roads Manual* or the FHWA Manual *HDS4 - Introduction to Highway Hydraulics*.

THE RATIONAL FORMULA

To determine flow volume...

$$Q = \frac{CiA}{362} \quad \text{where:}$$

Q = Quantity of Flow (Runoff), in Cubic Meters per Second (m^3/s).

C = Runoff Coefficient. This coefficient is selected to reflect the watershed characteristics, such as topography, soil type, vegetation, and land use.

i = Average Rainfall Intensity for the selected frequency and for a duration equal to the Time of Concentration, in millimeters per hour.

A = Area of the watershed, in Hectares.

Runoff Coefficient (C) values are presented in *Table 5.2*. These values reflect the differing watershed characteristics that influence runoff. The designer must develop experience and use judgment to select the appropriate value of C within the range shown. Note that the value of C may change over the design life of the structure due to changes in land use such as a forest converted to agricultural land or from a fire in the watershed. Flow quantity is directly proportional to the selection of this coefficient.

Area (A) is simply the area of the watershed that contributes runoff to the drainage crossing. Its boundaries go from drainage divide to drainage divide and down slope to the crossing. On a roadway surface, the "drainage area" is the cut slope and road surface area between cross-drains or leadoff ditches.

Rainfall intensity (i) is the third factor, and the one often most difficult to obtain. It is expressed as the average rainfall intensity in millimeters per hour (mm/hr) for a selected recurrence frequency and for a duration equal to the Time of Concentration of the watershed. At the beginning of a storm, runoff from distant parts of the watershed have not reached the discharge point (such as a culvert). Once water has reached the discharge point from **all** parts of the watershed, a steady state flow will occur. The estimated time when water from all parts of the watershed reaches the discharge point is the Time of Concentration (TOC). TOC depends on the overland flow rate of water in that watershed. For very small watersheds, a minimum TOC of 5 minutes is recommended for finding the intensity used in determining design flows. TOC can be estimated by dividing the length of the runoff route by the average runoff velocity (usually 0.1 [flat, wooded] to 1.0 m/s [steep, barren]).

Figure 5.2 shows a typical family of rainfall intensity-duration curves for a recurrence frequency of 2 to 50 years. Such curves, developed from local rainfall data, should be located or generated when working in any particular area. The typical maximum intensity values for a 25 to 50-year event for desert regions are around 75 to 100 mm/hr; some coastal and jungle, or tropical regions have maximum intensities from 200 to 400 mm/hr, or more; and most areas, including semi-arid regions, mountain forests, and coastal areas typically have values of 100 to 250 mm/hr. Because of the wide range of values, and the amount of local variation that can occur around islands and mountains, local data is desirable for project design work.

RECOMMENDED PRACTICES

- Use the best available hydrologic methods to determine design flows.
- Where appropriate, use drainage structures that are not sensitive to exact flow predictions, such as low water crossings (fords) and drivable dips versus culvert pipes.
- Add freeboard or extra capacity to structures in drainages with uncertain flow or for debris passage in watersheds with changing land uses, usually on the order of 120% to 150%.
- To minimize risk to structures, the recommended storm frequency (return period) for design of culverts is 20 to 50 years, and 100 to 200 years is recommended for bridges or drainages with sensitive environmental concerns.
- For culverts installed in areas with limited or inadequate hydrologic data or designs, include overflow (overtopping) protection to reduce risk of total failure or stream diversion (see Figure 7.10).
- Involve hydrologists, fisheries biologists and engineers in the process of hydrologic and hydraulic design.

PRACTICES TO AVOID

- Installing drainage structures without some rational or statistical assessment of the expected flow.

Table 5.1

DESIGN FLOW ANALYSIS METHODS FOR VARIOUS WATERSHED SIZES

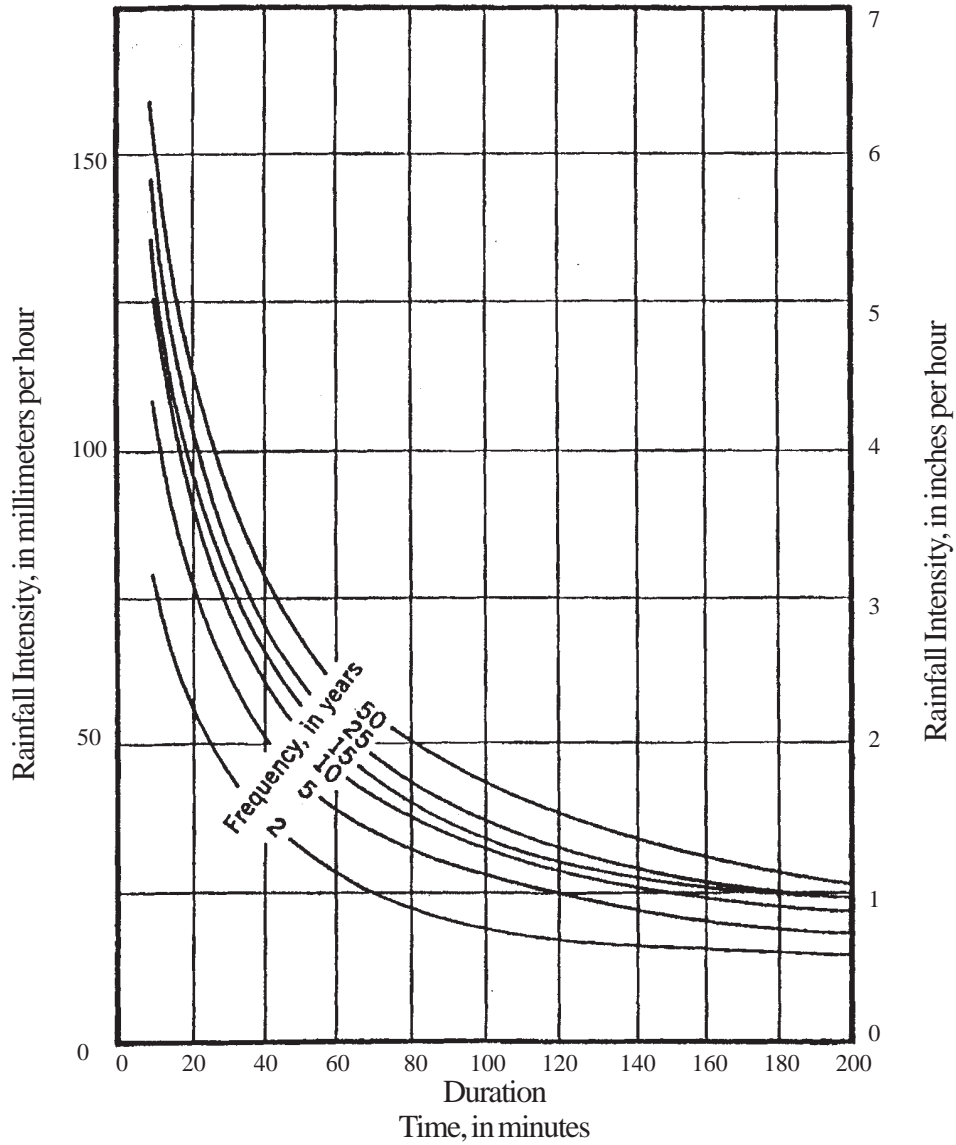
Watershed Size	Typical Type of Analysis
Small (to 120 ha) (300 acres)	Rational Method, Talbot Method, Local Experience
Medium (to 4,000 ha) (10,000 acres)	Regression Analysis, High Water Marks + Manning, Local Experience
Large (over 4,000 ha)	Gauging Data, High Water Marks, Statistical or Regression Analysis

Table 5.2

RATIONAL METHOD VALUES OF "C"

Land Use or Type	"C" Value
Agriculture	
Bare Soil	0.20-0.60
Cultivated Fields (sandy soil)	0.20-0.40
Cultivated Fields (clay soil)	0.30-0.50
Grass	
Turf, Meadows	0.10-0.40
Steep Grassed Areas	0.50-0.70
Woodland/Forest	
Wooded Areas with Level Ground	0.05-0.25
Forested Areas with Steep Slopes	0.15-0.40
Bare Areas, Steep and Rocky	0.50-0.90
Roads	
Asphalt Pavement	0.80-0.90
Cobblestone or Concrete Pavement	0.60-0.85
Gravel Surface	0.40-0.80
Native Soil Surface	0.30-0.80
Urban Areas	
Residential, Flat	0.40-0.55
Residential, Moderately Steep	0.50-0.65
Commercial or Downtown	0.70-0.95

Figure 5.2 Typical Rainfall Intensity-Duration Frequency Curves (Adapted from FHWA Hydraulic Design Series No. 4, 1997).



Note: Common Maximum Intensity Values for 25-50 Year Frequency of Events:

- Jungle Areas: 200-400 mm/hr
- Deserts: 50-100 mm/hr
- Most Areas (Semi-Arid, Mountains, Coastal Areas): 100-250 mm/hr



A drainage crossing can be a critical and vulnerable point in the road if the drainage structure fails. Thus, drainage crossings must be designed to pass the appropriate storm flows plus debris or to survive overtopping.

Chapter 6

Tools for Hydraulic and Road Design

“Protect against scour! Incorporate adequate riprap size and filters into streambank protection measures.”

HYDRAULIC DESIGN involves several basic concepts that must be considered to build successful projects with a minimum risk of failure (*Photo 6.1*). Use of **Manning’s Formula** to determine flow capacity and velocity, use adequately sized **Riprap** for stream bank and scour protection, use **Filter Zones** to prevent piping and scour, and use gravels or **Geotextiles** to stabilize the road structure. Basic road drainage design often uses Manning’s Formula for the determination of flow velocities in natural channels, for determining the quantity of that flow (as an alternative to methods discussed in Chapter 5), and for determining the flow capacity of canals and ditches. The use of Manning’s Formula to determine stream velocities and flow quantity is well documented in many engineering and

hydraulics manuals. Road engineers doing basic hydraulic design should become familiar with it and its applications. Complex channels with rapidly varying, unsteady, or critical flows should be evaluated by an experienced Hydraulic Engineer.



Photo 6.1 Scour behind a bridge abutment caused by insufficient channel and stream bank protection during a flood.

Manning's Formula

Channel discharge quantity (Q) is the product of the mean channel velocity (V) and the area (A) of the channel. To determine the discharge (Q) in natural drainages, canals, and non-pressure pipes, the following formula is used:

$$\text{Discharge} = (\text{Velocity}) \times (\text{Area})$$

or

$$Q = VA$$

where:

Q = discharge, in cubic meters per second (m^3/s)

V = average flow velocity, in meters per second (m/s)

A = cross sectional area, in square meters (m^2).

Manning's Formula can be used to compute the average flow velocity (V) in any channel or natural stream with uniform flow as shown to the right. Manning's Formula can be readily solved for a given channel when the known or assumed depth of flow is used. However, to determine the depth that a given discharge will produce in a channel, a trial and error solution is required. More detailed information on the use of Manning's Formula is presented in references, such as the *Minimum Impact Low-Volume Roads Manual*, the FHWA Manual *HDS4-Introduction to Highway Hydraulics*, or *Open-Channel Hydraulics*, by V.T. Chow.

Riprap Use

High flow velocities in channels or along local stream banks often lead to bank erosion, scour, or the formation of gullies. Scour can undermine and cause failure of bridges

MANNING'S FORMULA

To calculate average flow velocity...

$$V = \frac{1}{n} (R^{2/3})(S^{1/2})$$

where:

V = average flow velocity (meters/second)

n = roughness coefficient (usually 0.04 - 0.07 for natural channels); see handbooks for specific n values

S = channel slope (meter/meter)

R = hydraulic radius (meters) = A/P

where A and P are:

A = channel cross-sectional area

P = wetted perimeter

Roughness Coefficient (n) varies considerably, depending on the characteristics of a channel or the smoothness of a canal, pipe, etc. Manning's "n" values for various natural and manmade channels are found in many hydraulics manuals and handbooks. Smooth, open stream channels with gravel bottoms have values around 0.035-0.055. Very winding, vegetated, or rocky channels have values around 0.055 to 0.075. Smooth earth or rock channels have values of 0.020 to 0.035. Roughness values typically increase as channel vegetation and debris increase, as channel sinuosity increases, and as the mean size of channel materials increases. The value decreases slightly as flow depth increases.

Slope (S) of the canal or drainage channel is determined for the local reach of the channel being analyzed by dividing the rise, or change in elevation in that reach by the distance of that reach. This slope is typically measured in the actual stream channel, upslope and downslope of the site, and ideally is also checked on a topographic map.

Hydraulic radius (R) is determined from the channel cross-sectional area (A) divided by the wetted perimeter (P). The wetted perimeter is simply the distance along the channel bottom and/or sides that is under water, or within the area (A) of flow. Area should be determined from one or a couple representative cross-sections of the flow channel.



Photo 6.2 Riprap used for stream bank slope protection to prevent scour at the entrance of a structure. Note the use of willows for additional “biotechnical” root strength.

and culverts. Riprap, or large stone, is commonly used to protect stream banks and structures against scour (*Photo 6.2*). Rock may be used in conjunction with vegetation or other measures such as root wads, gabions, or jetties to provide bank protection (*Photo 6.3*). Riprap rock size, as well as use of other measures, is commonly determined as a function of stream velocity and local channel conditions.

Average stream channel velocity (V_{AVE}) can be determined using Manning’s Formula. Also, stream velocities can be estimated in the field if the surface flow can be measured during storm events. Stream velocity is the distance an object, such as a log or stick, travels in the middle of the stream divided by some short period of time. The average stream velocity will be about 0.8, or 80% of the value of the surface velocity. Common average peak velocities in streams

and rivers range from 1.5-3 m/sec in flat terrain to 2-4 m/sec in steep mountain channels. Flatter channels may actually experience faster flow velocities than steeper channels because of their typically lower roughness characteristics.

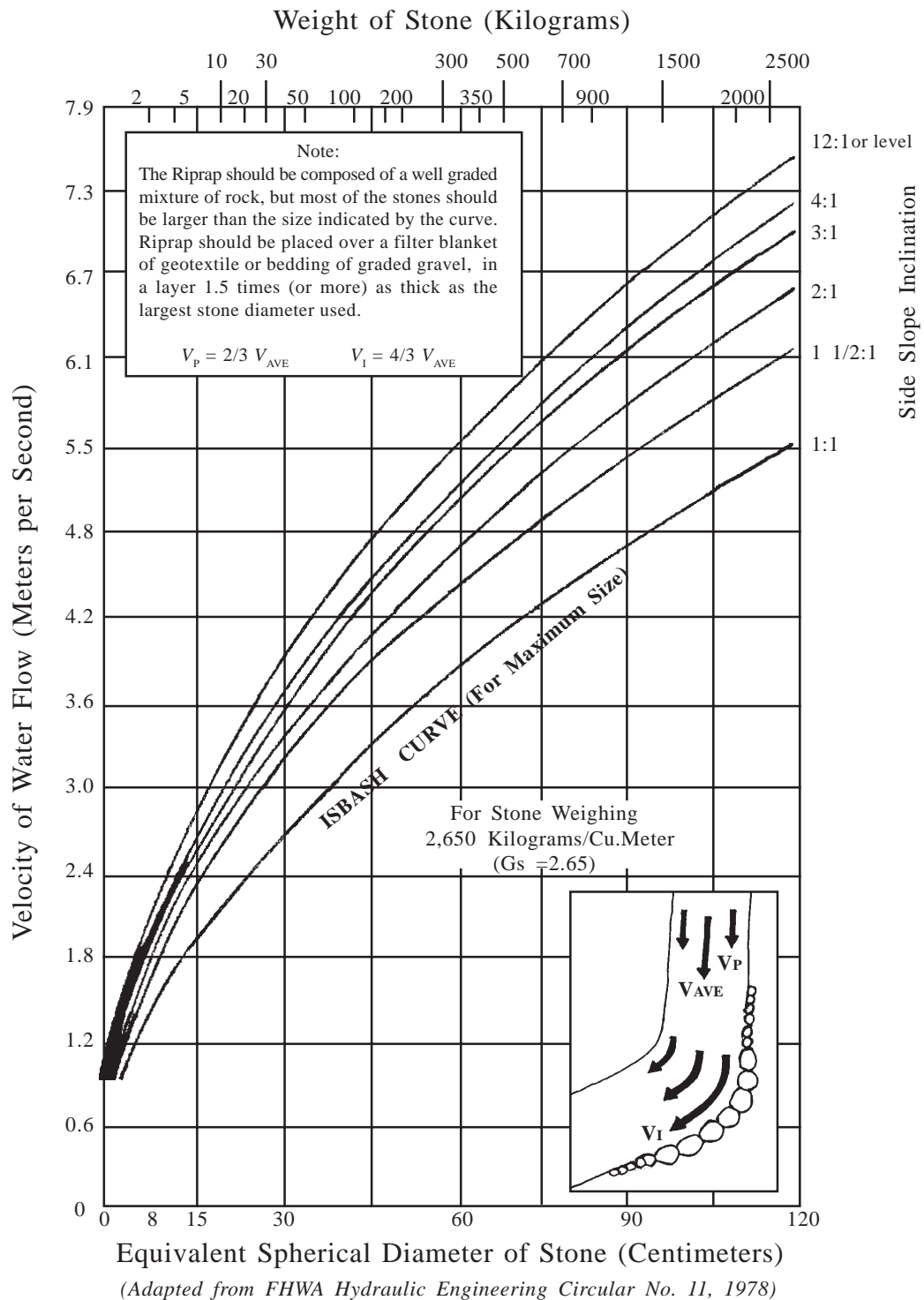


Photo 6.3 A root wad, log, and rock armored stream bank built for protection against scour. Logs and vegetation can offer an attractive alternative to riprap in relatively low stream velocity areas.

Figure 6.1 presents a useful correlation between water velocity (Velocity of Flow) and the size of riprap (Diameter) needed to protect the stream bank and not move. The flow along a long tangent section of stream, or the flow parallel (V_p) to the stream, is assumed to be about 2/3, or 67%, of the average velocity (V_{AVE}). The flow in a curved section of stream, with an impinging flow, has an assumed impinging velocity (V_I) equal to about 4/3, or 133%, of the average velocity (V_{AVE}). Thus, riprap in an area with relatively fast flow, such as a bend in the channel, will have higher stresses and require larger rock than the size needed in a straight part of the channel.

Note that most of the rock should be as large or larger than the size indicated in *Figure 6.1*. The Isbash Curve indicates the maximum size rock that might be considered in a critical application. If suitably large rock is not available,

Figure 6.1 Size of stone that will resist displacement for various velocities of water flow and side slopes.



then the use of cement grouted rock, masonry, or gabions should be considered.

Table 6.1 presents common gradations, sizes, and weights of classes of riprap. Riprap installation details are shown in *Figure 6.2*, as well as in the Note in *Figure 6.1*. Ideally riprap should be placed upon a stable foundation and upon a filter layer made either of coarse sand, gravel, or a geotextile. The riprap itself should be graded to have a range of sizes that will minimize the voids and form a dense layer. The riprap should be placed in a layer with a thickness that is at least 1.5 times the size (diameter) of the largest specified stone, with the thickest zone at the base of the rock. In a stream channel, the riprap layer should cover the entire wetted channel sides, with some freeboard, and it should be placed to a depth equal or greater than the depth of expected scour.

Filters

A filter serves as a transitional layer of small gravel or geotextile placed between a structure, such as riprap, and the underlying soil. Its purpose is to 1) prevent the movement of soil behind riprap or gabions, or into underdrains, and 2) allow groundwater to drain from the soil without building up pressure. Specific filter criteria, documented in other references, will establish the particle size and gradation relationships needed between the fine native soil, a filter material, and coarse rock such as drain rock or riprap. Also, specific geotextile requirements information exists for filter applications, as found in the Selected References.



Photo 6.4 Use of geotextiles placed against fine soil to provide adequate filtration for an underdrain.

Traditionally, coarse sand or well-graded, free draining gravel have been used for filter materials. A sand or gravel filter layer is typically about 15 to 30 cm thick. In some applications, two filter layers may be needed between fine soil and large rock. Today, geotextiles are commonly used to provide filter zones between materials of different size and gradation because they are economical, easy to install, and perform well with a wide range of soils (*Photo 6.4*). *Figure 6.2* shows the application of a gravel or geotextile filter between a streambank soil and the riprap rock protection.

Use of Geotextiles

Geotextiles are commonly used to provide a filter between rock and soil, thus preventing scour and soil movement. They are relatively easy to install under most conditions. The fabric should be pulled tight across the soil area to be protected before the rock is placed (*Photo 6.5*). The geotextile can be a wo-

ven monofilament or a needle-punch nonwoven geotextile, and it must be permeable. The geotextile needs to have an apparent opening size of 0.25 to 0.5 mm. In the absence of other information, a 200 g/m² (6.0 oz/yd²) needle-punch nonwoven geotextile is commonly used for many soil filtration and separation applications.

Other common geotextile or geosynthetic material applications on roads include subgrade reinforcement to reduce the thickness of needed aggregate over very weak soils; separation of aggregate from soft subgrade soils; reinforcement of soils in structures such as retaining walls and reinforced fills; and entrapment of sediment with silt fences (*Photo 6.6*), as seen in *Figure 6.3*. If knowledgeable engineers are not available, then geotextile distributors or manufacturers should be consulted regarding the function and appropriate types of geotextile to use in various engineering applications.

Table 6.1

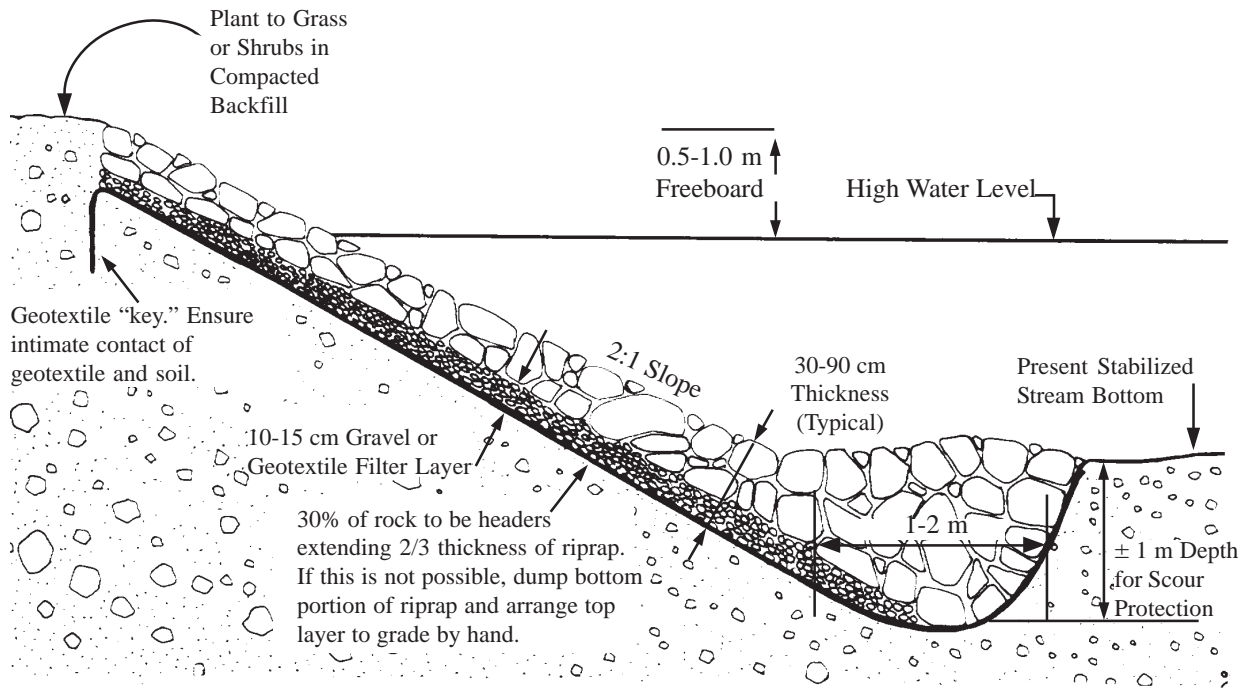
CLASSIFICATION AND GRADATION OF RIPRAP
(by Weight & Size of Rock)

Category	Weight	Size of Rock*		Percent Passing (total minus the diameter indicated)
		Kilograms (pounds)	Centimeters	
Class I	5 (11)	15	100	
	2.5 (5)	12	80	
	0.5 (1)	7	50	
	0.1 (.2)	3	10	maximum
Class II	25 (55)	25	100	
	15 (35)	20	80	
	5 (11)	15	50	
	0.5 (1)	8	10	maximum
Class III	50 (100)	30	100	
	30 (60)	25	80	
	10 (25)	20	50	
	1 (2)	10	10	maximum
Class V	100 (220)	45	100	
	70 (150)	35	70	
	35 (75)	25	30	
	7 (15)	15	10	maximum
Class VII	300 (650)	60	100	
	200 (440)	50	70	
	100 (220)	40	30	
	10 (22)	20	10	maximum
Class VIII	1,000 (2,200)	90	100	
	600 (1,320)	70	70	
	200 (440)	50	30	
	30 (65)	25	10	maximum
Class X	2,000 (4,400)	120	100	
	1,000 (2,200)	90	80	
	300 (660)	60	50	
	40 (90)	30	10	maximum

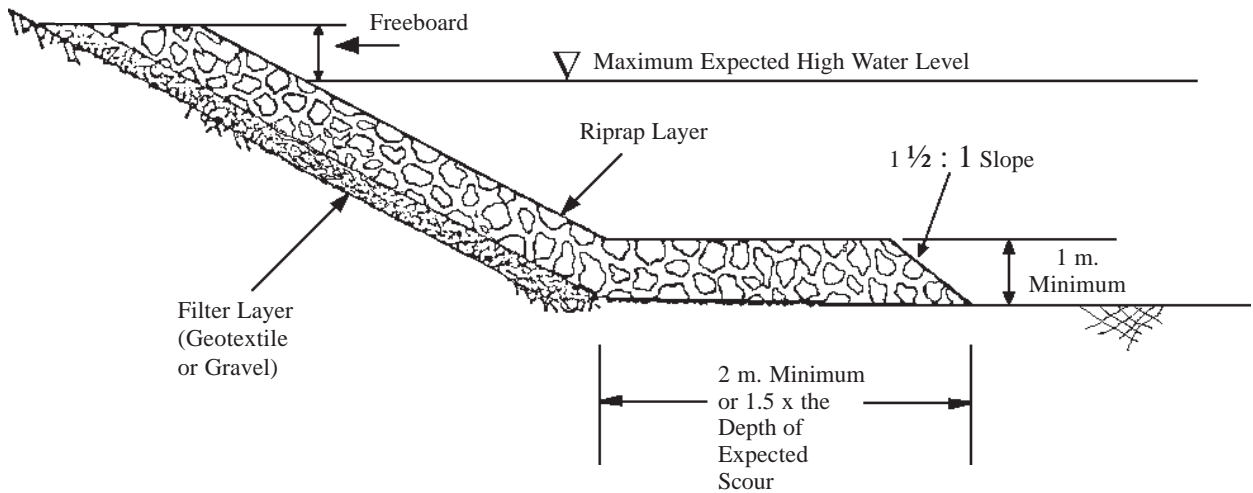
Source: Adapted from USDA-Forest Service.

*equivalent spherical diameter

Figure 6.2 Two examples of typical riprap stream bank protection.



a. Rock Toe and Blanket Detail



b. Details of Rock Riprap Layer Placed on the Stream Channel Bottom for Scour Protection

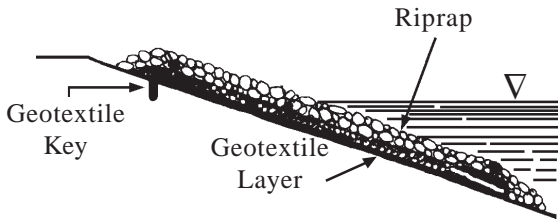


Photo 6.5 A filter cloth (geotextile) backing behind a loose rock slope buttress to provide a filter for drainage and to prevent movement of fine soil into the rock. (Photo by Richard Van Dyke)

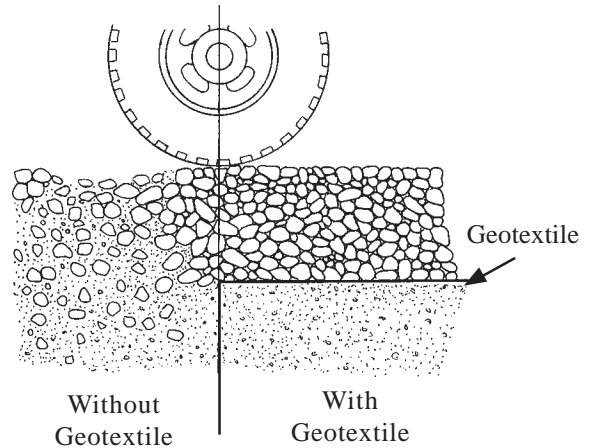


Photo 6.6 Use of a geotextile as a “silt fence” to trap sediment from a construction area.

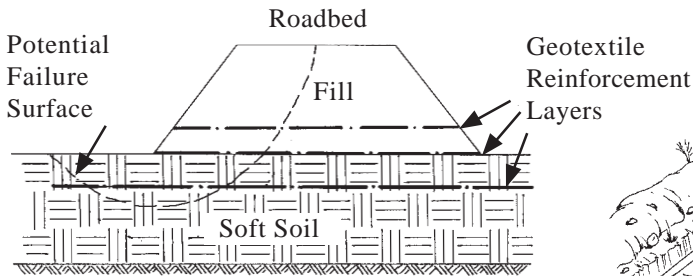
Figure 6.3 Typical Geotextile Applications for Rural Roads. (Adapted with permission from AMOCO Fibers Corporation)



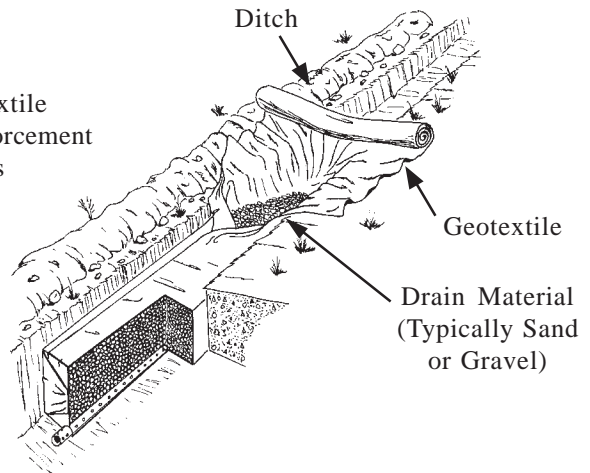
a. Filter Behind Riprap for Stream Bank Protection.



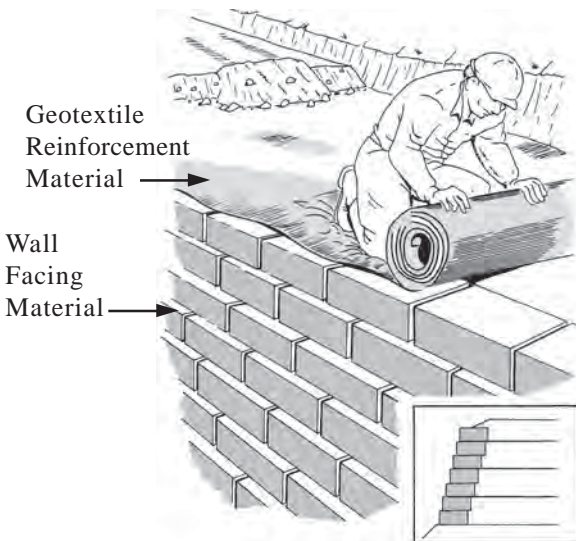
b. Subgrade Separation and Reinforcement.



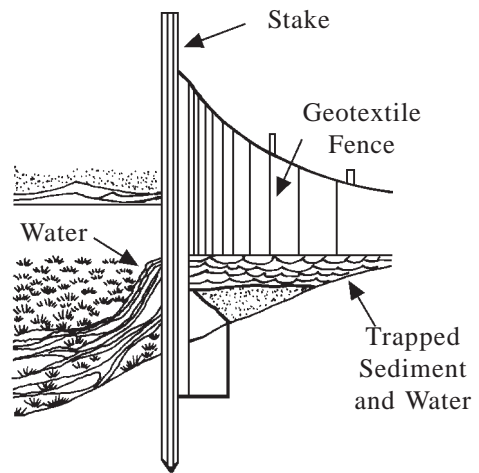
c. Embankment Reinforcement over Soft Soil Deposit.



d. Filtration in an Underdrain.



e. Reinforced Soil Retaining Structure.



f. Silt Fence to Trap Sediment.

RECOMMENDED PRACTICES

- Determine stream channel velocities to examine scour potential, structure protection needs, and impacts on aquatic life.
- Use well graded, hard, angular, properly sized riprap where scour protection is needed. Needed rock size (and weight) as a function of average water flow velocity is shown in Figure 6.1. On curves (impinging flow) increase the rock size by 30 to 50 percent above that shown in Figure 6.1 for average flow velocities.
- Use clean sand, clean, well graded 0.5 to 1 cm gravel, or a geotextile for filters between fine erodable soils and coarse drain rock or riprap (see Figure 6.2 for typical riprap installation with filter backing).
- Use scour countermeasures to protect structures, prevent failure of structures, and avoid adverse impacts to streams. Riprap or gabions are most commonly used in high velocity or critical areas (*Photo 6.7*). Vegetation, root wads, logs, or barbs can also be used for streambank stabilization.
- Pay attention to design details where rock protection and filters are needed.
- Use geotextiles in road and hydraulic design applications to provide a filter behind riprap or around an underdrain. Use geosynthetic materials in other applications, such as for separation and reinforcement, wherever cost-effective and practical.

PRACTICES TO AVOID

- Installing structures without adequate consideration of expected stream velocities and appropriately sized rock for bank protection.
- Installing subsurface drainage measures, such as underdrains, without filter protection (such as use of geotextiles and properly sized sand or gravel filter material).

Photo 6.7 Riprap with a geotextile filter backing are being used to protect the road from high water flows. Note that the road is poorly located so close to the stream!



Chapter 7

Drainage of Low-Volume Roads

*“Three of the most important aspects of road design --
drainage, drainage, and drainage”*

ROAD LOCATION and drainage of roads, construction areas, and other areas of activity are the most significant factors that can affect water quality, erosion, and road costs. Drainage includes controlling surface water and adequately passing water under roads in natural channels. Drainage issues that must be addressed in road design and construction include roadway surface drainage; control of water in ditches and at pipe inlets/outlets; crossings of natural channels and streams; wet area crossings; subsurface drainage; and selection and design of culverts (Chapter 8), low water crossings (Chapter 9), and bridges (Chapter 10). Three of the most important aspects of road design are **drainage, drainage, and drainage!**

Adequate road drainage requires careful **attention to detail**. Drainage conditions and patterns must be studied on the ground. Drainage should be observed during

rainy periods to see how the water is actually moving, where it is concentrated, what damage it may cause, and what measures are needed to prevent damage and keep the drainage systems functioning properly.

ROADWAY SURFACE DRAINAGE CONTROL

The roadway surface needs to be shaped to disperse water and move it off the road quickly and as



Photo 7.1 Design roads that move water rapidly off the surface of the road and minimize water concentration with the use of rolling grades and outsloped, insloped, or crowned roads.

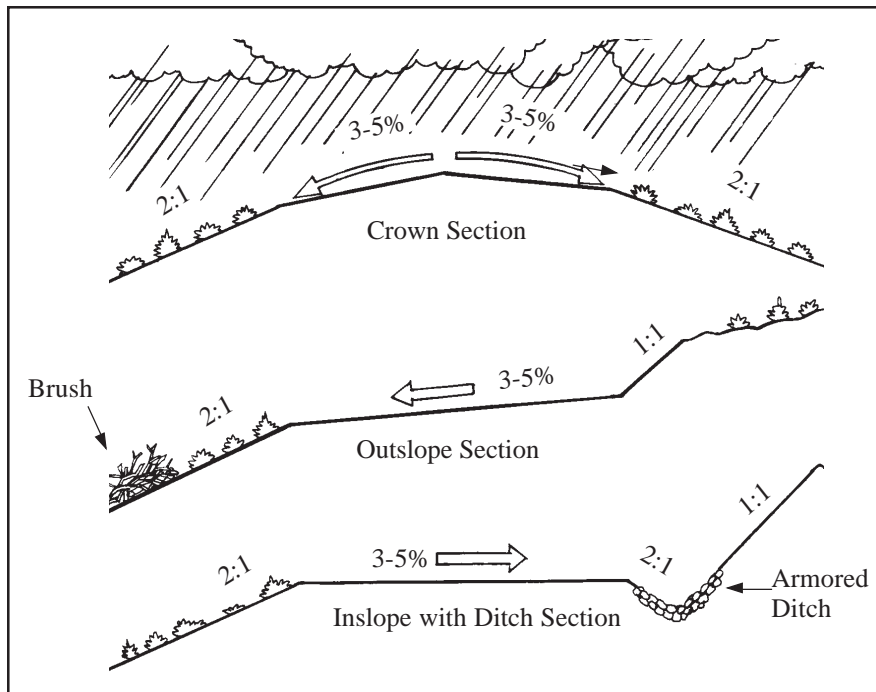


Figure 7.1 Typical road surface drainage options.

frequently as possible (*Photo 7.1*). Water standing in potholes, ruts and sags will weaken the subgrade and accelerate damage. Water concentrated in ruts or kept on the road surface for long distances can accelerate erosion as well as wash off the surface material. Steep road grades cause surface and ditch water to move rapidly, and make surface drainage difficult to control. Steep grades accelerate erosion unless surfaces are armored or water is dispersed or removed frequently.

Roadway surface water should be controlled with positive drainage measures using **outsloped**, **insloped**, or **crown** sections of road, as shown in *Figure 7.1*. **Outsloped** roads best disperse water and minimize road width, but may require roadway surface and fill slope stabilization. An outsloped road minimizes concentration of water, minimizes needed road width, avoids the

need for an inside ditch, and minimizes costs. Outsloped roads with clay rich, slippery road surface materials often require rock surface stabilization or limited use during rainy periods to assure traffic safety. On road grades over 10 to 12 percent and on steep hill slope areas, outsloped roads are



Photo 7.2 Use rolling dip (broad-based dip) cross-drains to move water off the road surface efficiently and economically, without the use of culvert pipes. Rolling dip cross-drains are not susceptible to plugging.

difficult to drain and can feel unsafe.

Insloped roads best control the road surface water but concentrate water and thus require a system of ditches, cross-drains, and extra road width for the ditch. Cross-drains, using either rolling dips (broad-based dips) or culvert pipes, must be spaced frequently enough to remove all the expected road surface water before erosion occurs. The maximum recommended distances (listed in *Table 7.1*) should be used for guidance on spacing of cross-drains and ditch relief structures. Specific locations should be determined in the field based upon actual water flow patterns, rainfall intensity, road surface erosion characteristics, and available erosion resistant outlet areas.

Crown section roads are appropriate for higher standard, two lane roads on gentle grades. They also require a system of inside

Table 7.1

**Recommended Maximum Distance Between Rolling Dip
or Culvert Cross-Drains (meters)**

Road Grade %	Low to	
	Non-Erosive soils (1)	Erosive Soils (2)
0-3	120	75
4-6	90	50
7-9	75	40
10-12	60	35
12+	50	30

ditches and cross drains. It is difficult to create and maintain a crown on a narrow road, so generally insloped or outsloped road drainage is more effective for rural roads.

Culvert cross-drains are used to move ditch water across the road. They are the most common type of road surface drainage, and are most appropriate for high-standard roads where a smooth road surface profile is desired. However the pipes are expensive, and the relatively small culvert pipes used for cross-drains are susceptible to plugging and require cleaning.

Rolling dip cross-drains (**broad-based dips**) are designed to pass slow traffic, while also dispersing surface water (*Photo 7.2*). Rolling dips usually cost less, require less maintenance, and are less likely to plug and fail than culvert pipes. Rolling dips are ideal on low volume, low to moderate speed roads (20-50 kph). Spacing is a function of road grade and soil type, as seen in *Table 7.1*. Other types of roadway surface cross-drain structures occasionally used include open top wood or metal flumes, and rubber water deflectors.

Steep road grades are undesirable and problematic, but occasionally necessary. On grades up to 10%, cross-drains with culverts or rolling dips are easy to use. Between 10 and 15%, frequently spaced culvert cross-drains work, often in conjunction with armored ditches. On grades over 15%, it is difficult to slow down the wa-

Table 7.2

Recommended Water Bar Spacing (meters)

Road/Trail Grade %	Low to	
	Non-Erosive soils (1)	Erosive Soils (2)
0-5	75	40
6-10	60	30
11-15	45	20
16-20	35	15
21-30	30	12
30+	15	10

Note: (1) **Low Erosion Soils** = Coarse Rocky Soils, Gravel, and Some Clay

(2) **High Erosion Soils** = Fine, Friable Soils, Silt, Fine Sands

*Adapted from Packer and Christensen (1964)
& Copstead, Johansen, and Moll (1998)*

RECOMMENDED PRACTICES

ROADWAY SURFACE DRAINAGE CONTROL

- Design and construct roads so that they will move water rapidly off the road surface to keep the surface drained and structurally sound.
- Avoid steep road grades in excess of 12 to 18%. It is very difficult and expensive to properly control drainage on steep grades.
- Maintain positive surface drainage with an outsloped, insloped, or crown roadway section using 3 - 5 % cross slopes (up to 5% is best) (*Figure 7.1*).
- Roll grades or undulate the road profile frequently to disperse water, particularly into and out of stream crossings (*Figure 7.2a*, *Photo 7.1*).
- Use frequently spaced leadoff ditches (*Figure 7.2b* and *Figure 7.8*) to prevent accumulation of excessive water in the roadway ditches.
- Use roadway cross-drain structures (either rolling dips, pipe culverts, or open top culverts (flumes)) to move water across the road from the inside ditch to the slope below the road. Space the cross-drain structures

frequently enough to remove all surface water. *Table 7.1* gives recommended cross-drain spacing.

- **Protect cross-drain outlets** with rock (riprap), brush, or logging slash to dissipate energy and prevent erosion, or locate the outlet of cross drains on stable, non-erosive soils, rock, or in well vegetated areas (*Figure 7.2b*).
- Construct **rolling dips** rather than culvert cross-drains for typical, low-volume, low speed roads with grades less than 12%. Construct rolling dips deep enough to provide adequate drainage, angled 0-25 degrees from perpendicular to the road, with a 3-5% outslope, and long enough (15 to 60 meters) to pass vehicles and equipment (*See Photo 7.2*). In soft soils, armor the mound and dip with gravel or rock, as well as the outlet of the dip (*Figure 7.3*).
- Install **culvert cross-drains** with an angle of 0-30 degrees perpendicular to the road, using an outslope of 2% greater than the ditch grade to prevent plugging. (*Figure 7.4*). (See Chapter 8 for more information on culverts). Use culvert cross-drains on roads with an

inside ditch and moderately fast vehicle speeds.

- Construct **water bars** on infrequently used roads or closed roads to control surface runoff. Construct frequently spaced waterbars angled at 0-25 degrees with an outslope of 3-5% and a depth of 0.3 to 0.6 meters. Install water bars as shown in *Figure 7.5*. Spacing of waterbars is shown in *Table 7.2*.
- Use **catch water ditches** (intercept ditches) across the natural ground above a cut slope only in areas with high intensity rainfall and overland flow. These ditches are useful to capture overland sheet flow before it pours over the cut slope and erodes or destabilizes the cut. However, be aware that catch water ditches are that are not properly maintained can become a counter-productive pool for water above the slope, increasing the probability of a slope failure.
- Avoid the use of **outside ditches**, along the outside edge of the road, except in specific areas that must be protected from sheet flow off the road surface. Preferably, use berms. Note that an outside ditch or berm necessitates additional road width.

PRACTICES TO AVOID

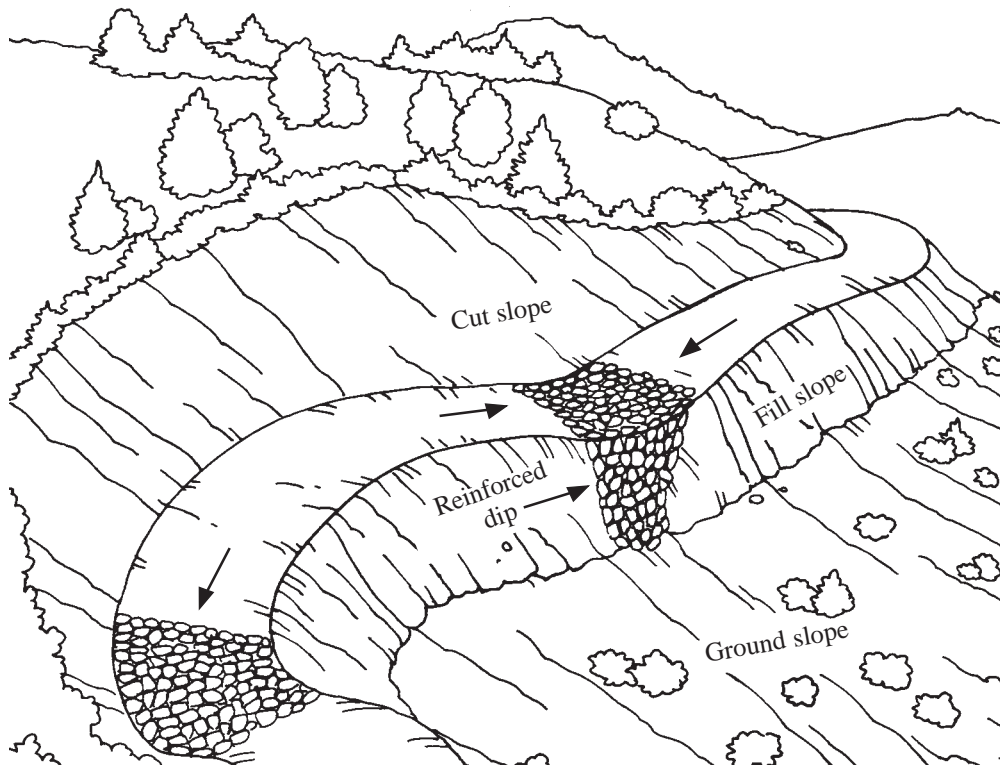
- Long sustained road grades that concentrate flows.
- Discharging water onto

erosive, unprotected soils.

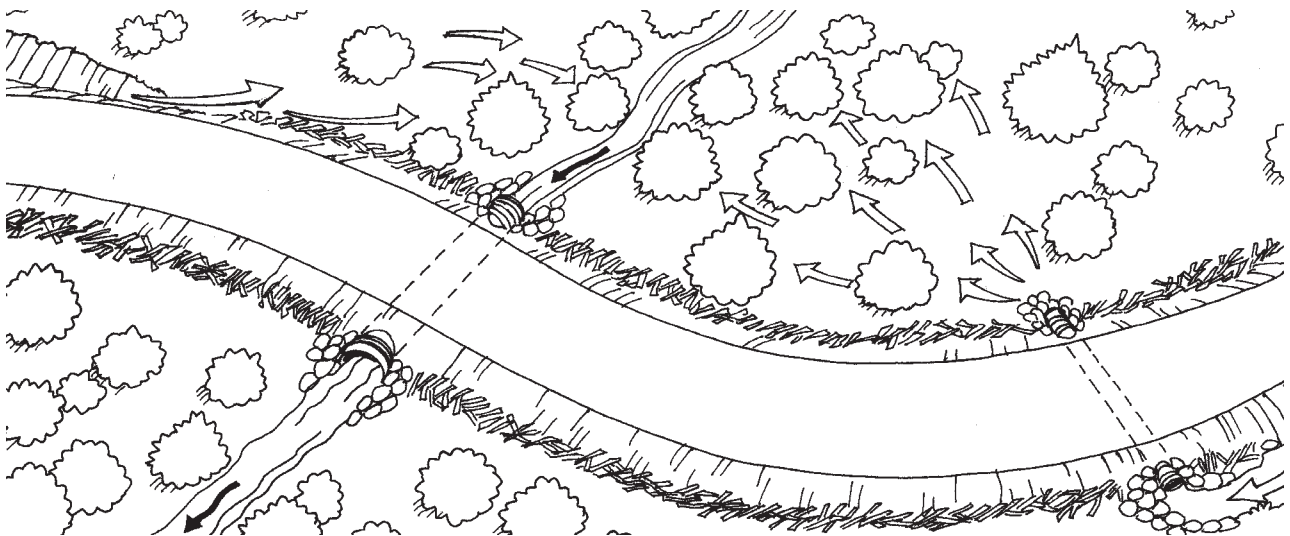
- “Eyeballing” grades in flat terrain. Use a clinometer,

abney level, or survey equipment to ensure that you have proper slopes or grades.

Figure 7.2

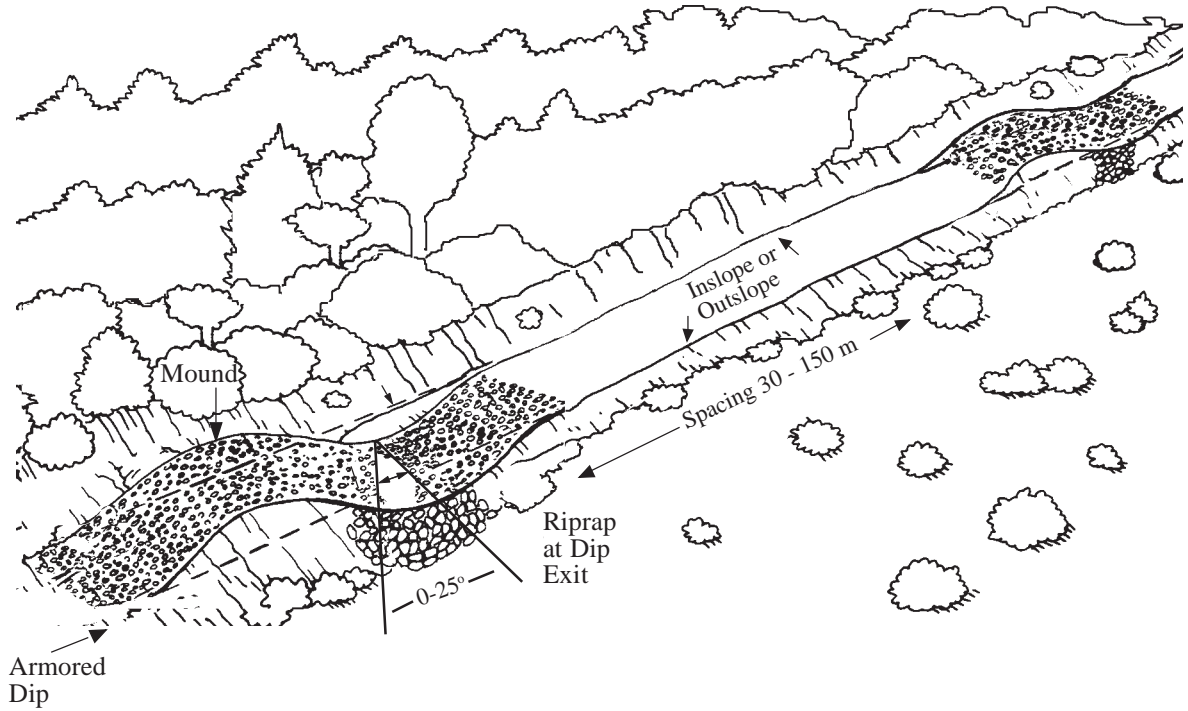


a. Basic road surface drainage with outsloping, rolling grades, and reinforced dips.

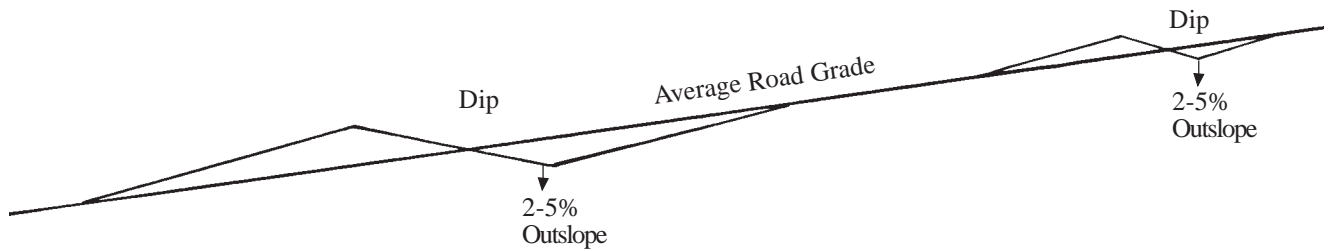


b. Basic road surface drainage with leadoff ditches and culvert cross-drains exiting into vegetation or a streamside buffer area. (Adapted from Montana State Univ. 1991)

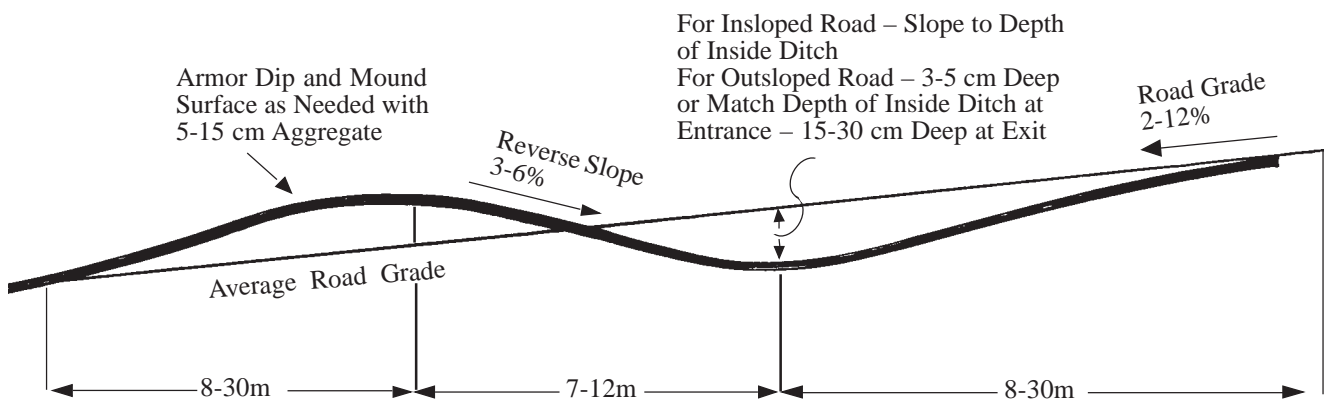
Figure 7.3 Rolling (broad-based) dip cross-drains.



a. Perspective View



b. Profile



c. Rolling Dip Profile Detail

Figure 7.4 Culvert cross-drains.

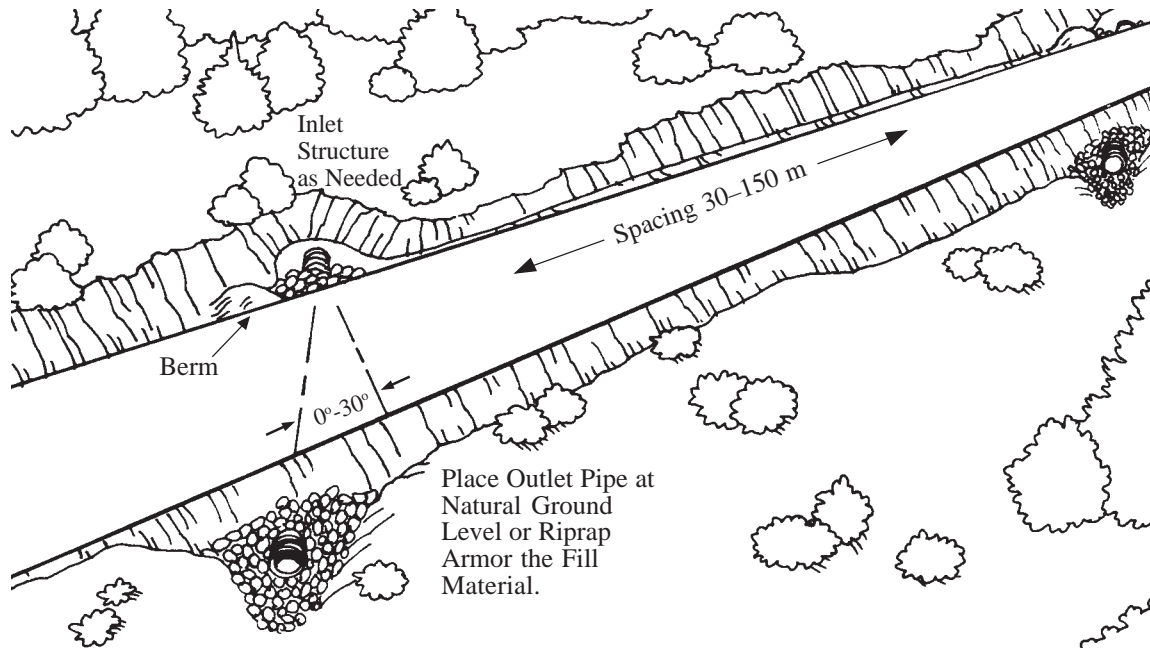
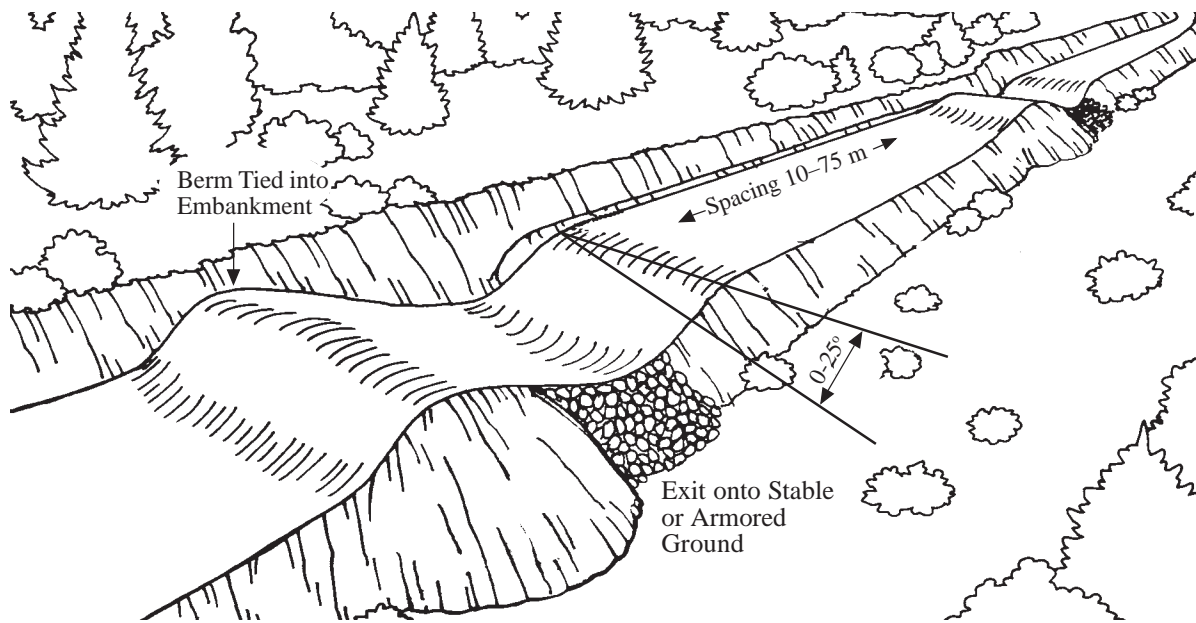
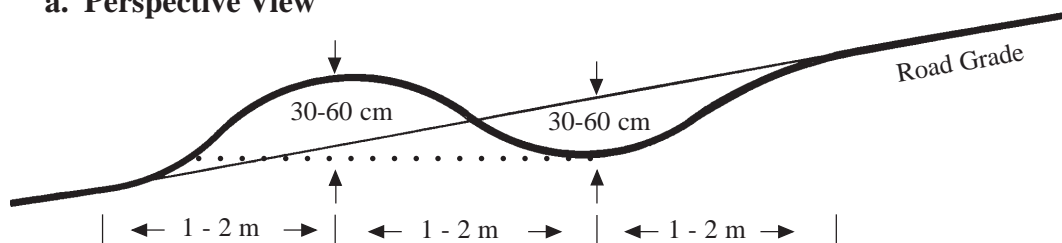


Figure 7.5 Water bar construction. (Adapted from Wisconsin's Forestry Best Management Practices for Water Quality. 1995, Publication FR093, Wisconsin Department of Natural Resources)



a. Perspective View



b. Cross-Section



Photo 7.3 Use masonry, concrete, or metal inlet structures to control water in the ditch, direct the water into the cross-drain pipe, and prevent ditch down-cutting.

ter or remove it from the road surface rapidly. On such steep grades, it is best to use frequently spaced cross-drain culverts, with armored ditches. Also, the road surface will need armoring or surfacing with some form of pavement to resist erosion. For seasonal or low use roads, interim drivable waterbars could also be constructed.

Water bars are used to control drainage on closed or inactive roads, 4-wheel drive roads, skid roads, and skid trails. Water bars are frequently spaced (see *Table 7.2*) for maximum erosion control and can be shaped to pass high clearance vehicles or to block traffic.



Photo 7.4 Add outlet protection and/or energy dissipators to prevent erosion and the formation of gullies.

CONTROL AT INLETS AND OUTLETS OF CROSS-DRAINS AND DITCHES

Water should be controlled, directed, or have energy dissipated at the inlet and outlet of culverts, rolling dips, or other cross-drainage structures. This can ensure that water and debris enters the cross-drain efficiently without plugging, and that it exits the cross-drain without damaging the structure or causing erosion at the outlet.

Culvert inlet structures (drop inlets) are usually placed in the inside ditchline at the location of a culvert cross-drain. They are commonly constructed of concrete, masonry (*Photo 7.3*), or from round metal pipe, as seen in *Figure 7.6*. They are typically used where the ditch is eroding and downcutting, so that the structure controls the ditch elevation. Inlet structures are also useful to change the direction of water flowing in the ditch, particularly on steep grades, and they can help stabilize the cut bank behind the pipe inlet.

The outlet of pipes and dips are ideally located in a stable, non-erosive soil area or in a well-vegetated or rocky area. The accelerated velocity of water leaving a roadway can cause severe erosion or gullying if discharged directly onto erosive soils (*Photo 7.4*). The pipe, dip, or drain outlet area can be stabilized, and the energy of the water dissipated, by discharging the water onto 1-2 cubic meters of a graded rock riprap, as seen in *Figure 7.7*. Other energy dissipation measures include the use of stilling basins, rein-



Photo 7.5 Protect the outlet of culvert pipe and rolling dip cross-drains with riprap or a masonry splash apron, or choose areas of bedrock or dense vegetation.

forced splash aprons, or use of dense vegetation or bedrock (Photo 7.5).

Ditches on steep road grades,

in erosive soils, and with flow velocities over one meter per second may require armoring or the use of small ditch dike or dam structures placed in the ditch to

RECOMMENDED PRACTICES

CONTROL AT INLETS & OUTLETS

- When ditch grade control is needed, use drop inlet structures with culvert cross-drains to prevent ditch down-cutting or where space is limited against the cut bank (Figure 7.6). Alternately, use catch basins excavated into firm soil.
- Discharge culverts and cross-drain dips at natural ground level, on firm, non-erosive soil or in rocky or brushy areas. If discharged on the fill slopes, armor outlets with riprap or logging slash, or use down-drain structures. (Figures 7.3, 7.4, 7.7 and Figure 8.1). Extend the pipe 0.5 to

1.0 meters beyond the toe of the fill slope to prevent erosion of the fill material.

- In erosive soils, armor roadway ditches and leadoff ditches with rock riprap (Photo 7.7), masonry, concrete lining or, at a minimum, grasses. Ditch dike structures can also be used to dissipate energy and control ditch erosion. (Figure 7.8).
- Discharge roadway drains in an area with infiltration capability or into filter strips to trap sediment before it reaches a waterway. Keep the road and streams hydrologically “disconnected.”

slow down the velocity of water, as shown in Figure 7.8. Ditches are commonly armored with grass, erosion control matting, rock, or masonry /concrete paving (Photo 7.6). Grasses can resist flow velocities to 1-2 meters per second. A durable armoring such as graded rock riprap or concrete is recommended on grades over 5 percent in erosive soils or for velocities over a few meters per second.

Ditch dikes will prevent ditch erosion, and dikes can serve to catch sediment, but they require maintenance in that they need to be periodically cleaned out. Common ditch dike construction materials include loose rock, masonry, concrete, bamboo, and wooden posts. Each dike structure should be keyed into the banks of the ditch and a notch is needed over each structure to keep the flow in the middle of the ditch.

PRACTICES TO AVOID

- Discharging a cross-drain pipe or dip onto any unprotected fill slope or barren, erosive soil.
- Discharging cross-drain pipes mid-height on a fill slope.
- Discharging cross-drain pipes or dips onto unstable natural slopes.



Photo 7.6 Armor ditches with vegetation, rock, masonry, or concrete to resist ditch erosion and carry the water to a stable exit point.

Figure 7.6 Typical drop inlet structure types (with culvert cross-drains).

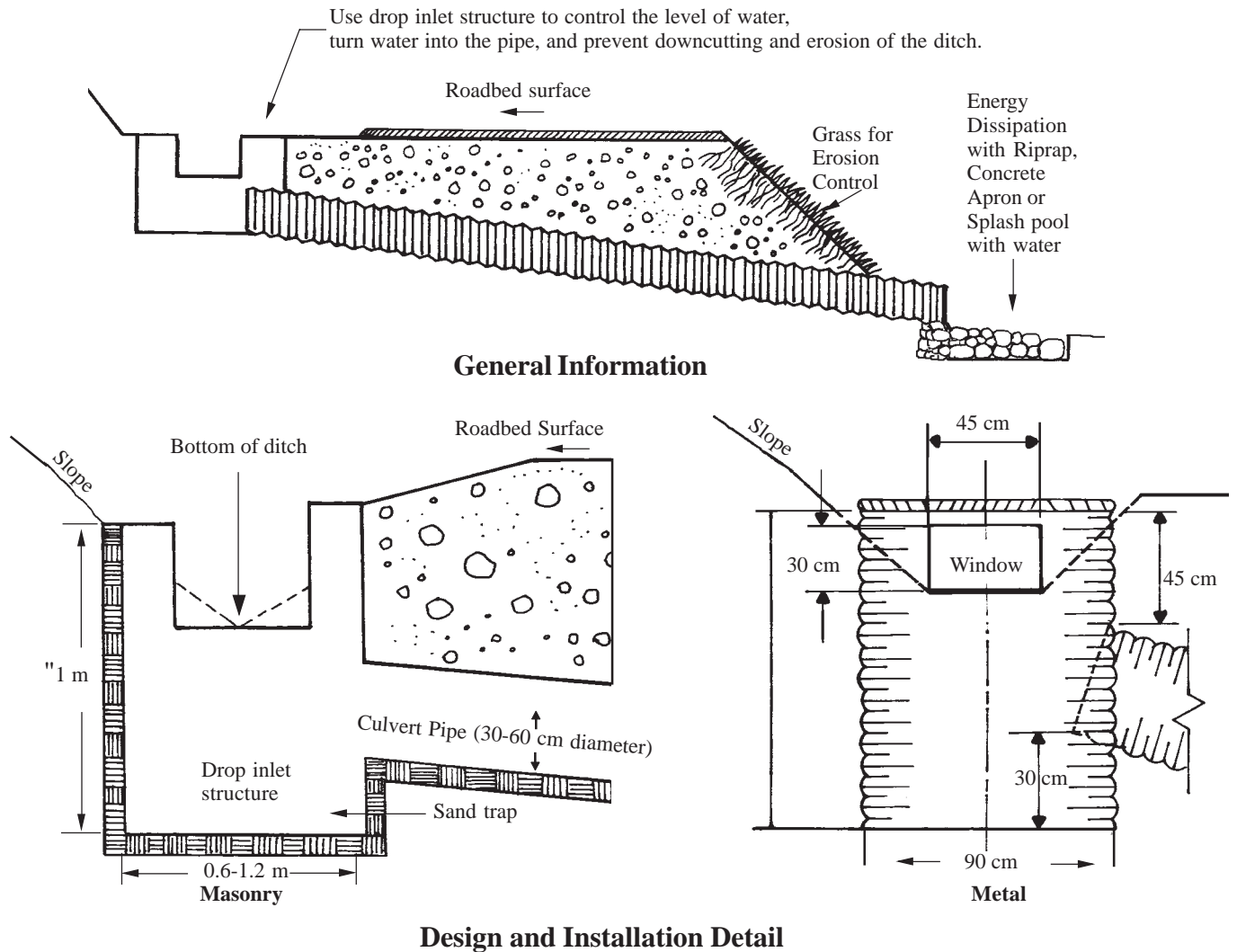


Figure 7.7 Culvert outlet protection.

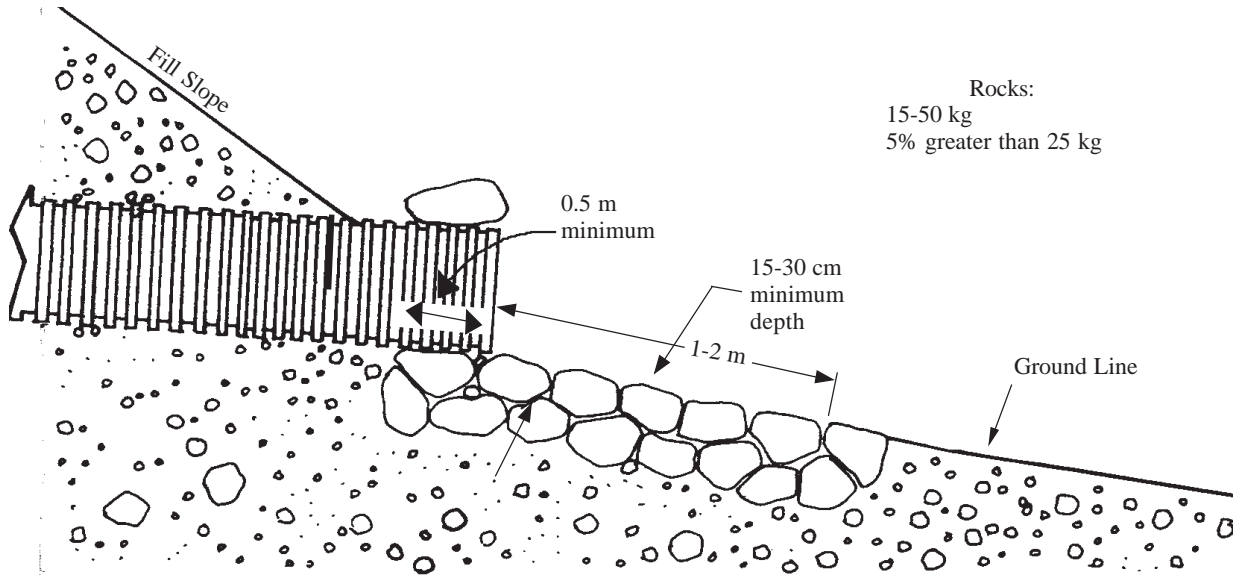
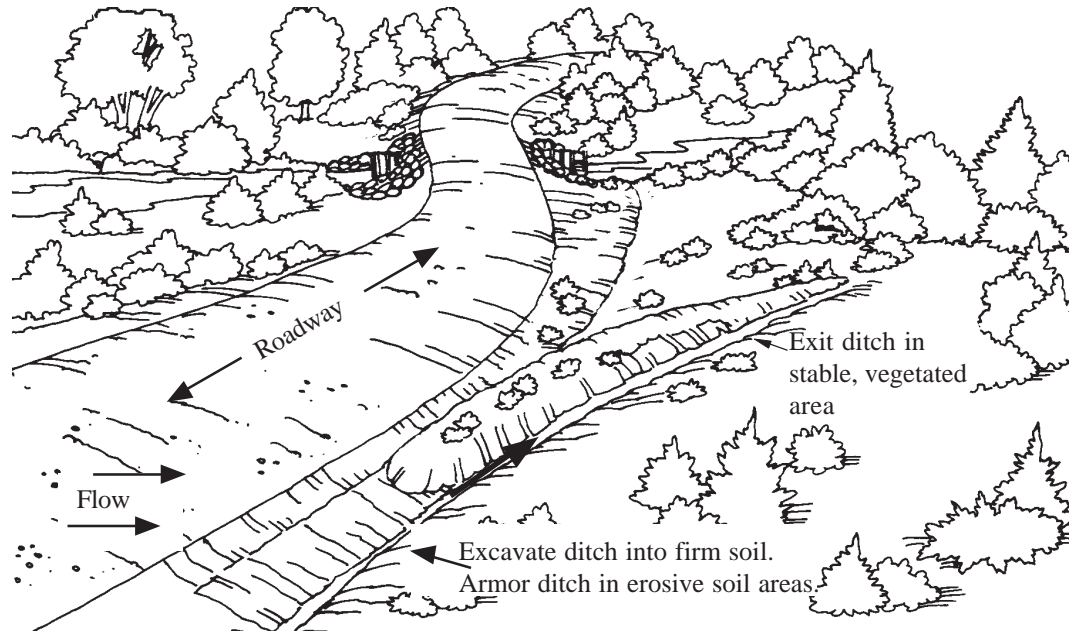
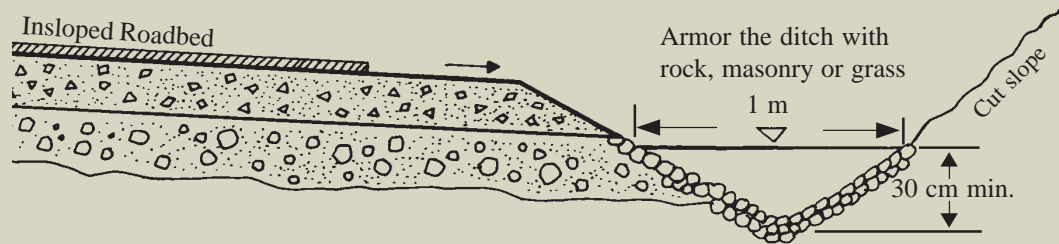


Photo 7.7 A rock armored ditch and metal drop inlet to control the water and prevent down-cutting of the ditch.

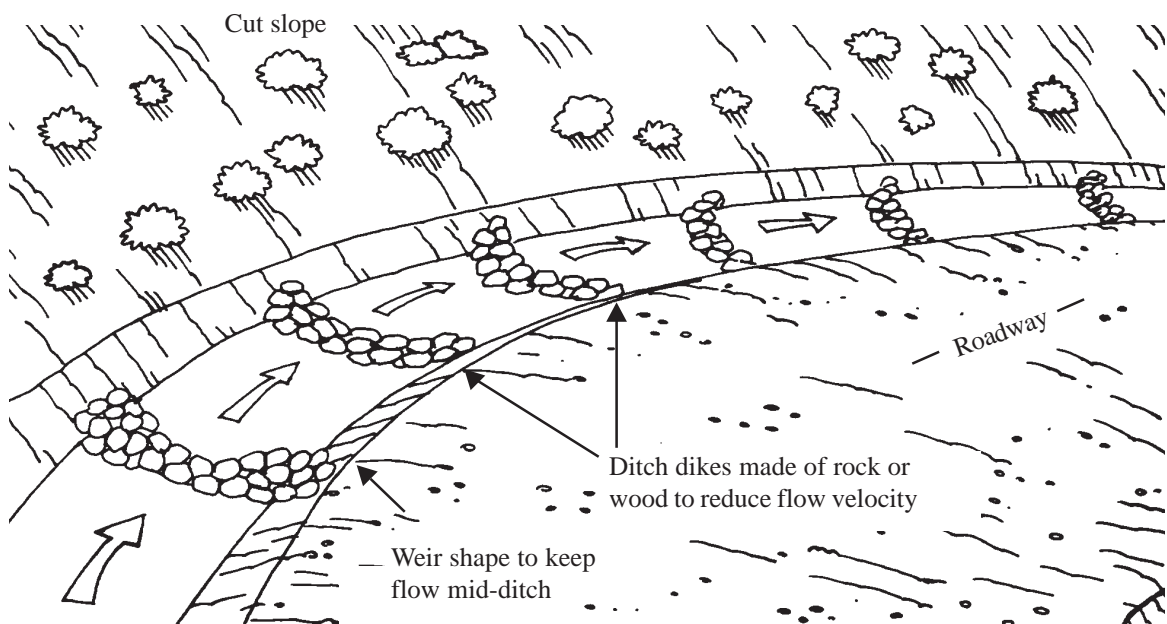
Figure 7.8 Ditches and ditch armoring.



a. Ditch Layout and Leadoff (Adapted from Wisconsin's Forestry Best Management Practices for Water Quality, 1995)



b. Typical Ditch Armoring and Shape



c. Use of Ditch Dikes

NATURAL STREAM CROSSINGS

Road crossings of natural drainage channels and streams require hydrologic and hydraulic design expertise to determine the proper size and type of structure, as discussed in Chapters 5 and 6. Structures for small drainages can be sized using *Table 8.1*. The choice of structure includes culvert pipes, arch or box culverts, low water fords, or bridges, as shown in *Figure 7.9*.

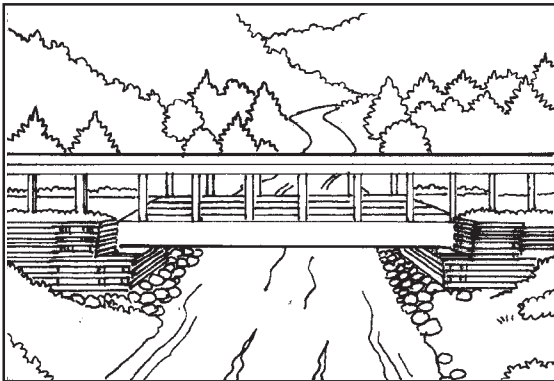
Because drainage crossings are at areas of running water, they can be costly to construct and can have major negative impacts on water quality. Impacts from improper design or installation of structures can include degraded water quality, bank erosion, chan-

nel scour, traffic delays, and costly repairs if a structure fails. Also, structures can greatly impact fish, as well as other aquatic species, at all stages of life. Stream crossings should be as short as possible and cross perpendicular to the channel (*Photo 7.8*). The road and ditches should be armored, ditches should divert surface water before it reaches the stream channel, and construction should minimize the area of disturbance, as shown in *Figure 7.10*. Large drainage crossings should receive site-specific analysis and design input, ideally by an experienced hydraulic engineer and other specialists.

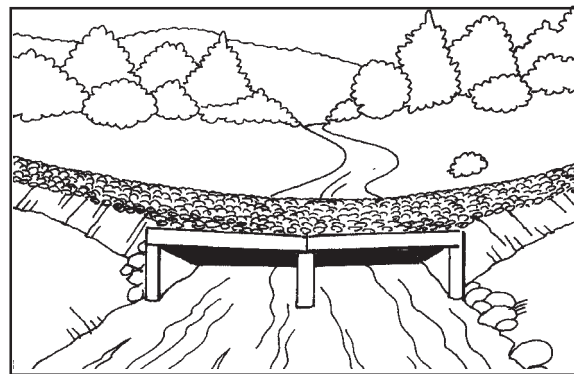
In drainages with uncertain flow values, large quantities of debris in the channel, or on sites with

existing undersized pipes, there is a high risk of a culvert pipe plugging and the site washing out or failing. In such areas, or in particularly sensitive watersheds, overflow protection is desirable. A low point in the fill and an armored overflow “spillway,” as shown in *Figures 7.11a & b*, will protect the fill and keep the flow in the same drainage, thus reducing diversion potential and usually preventing a failure. A plugged pipe that diverts the stream water down the road can cause a great deal of off-site damage or gully-ing or cause landslides, as seen in *Figures 7.11c & d*. Overflow structures should not be used as a substitute for good hydraulic design, but they can offer “cheap insurance” against failure at culvert crossings.

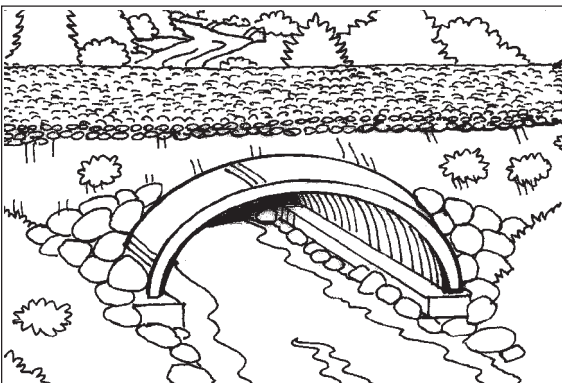
Figure 7.9 Structural options for crossing natural streams. (Adapted from Ontario Ministry of Natural Resources, 1988)



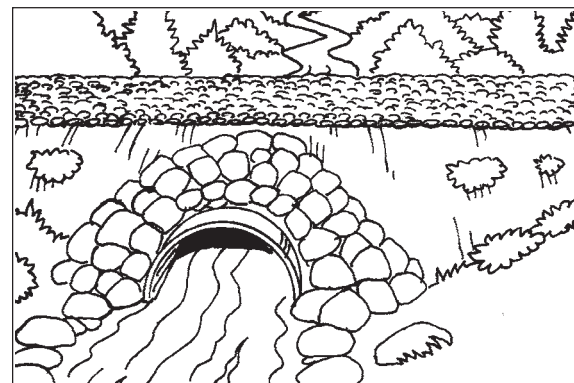
a. Bridge



b. Low-Water Crossing



c. Arch Pipe



d. Culvert with Single or Multiple Pipes

RECOMMENDED PRACTICES

NATURAL STREAM CROSSINGS

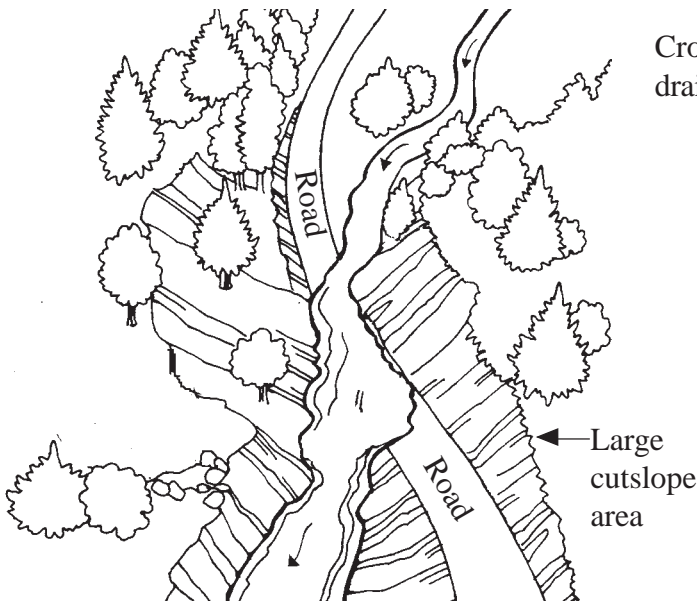
- Use drainage structures that best conform to the natural channel and that are as wide as the active stream channel (bankfull width). Minimize natural channel changes and the amount of excavation or fill in the channel.
- Limit construction activity to periods of low flow in live streams. Minimize use of equipment in the stream. Stay out of the stream!
- Design structures and use construction practices that minimize impacts on fish and other aquatic species or that can enhance fish passage.
- Cross drainage channels as infrequently as possible. When necessary, cross streams at right angles except where prevented by terrain features (*Figure 7.10*).
- Keep approaches to stream crossings to as gentle a grade as practical. Roll grades into and out of the crossing to disperse water.
- Stabilize disturbed soil around crossings soon after construction. Remove or protect fill material placed in the channel and floodplain.
- Use bridges, low-water fords or improved fords, and large arch pipes with natural stream bottoms wherever possible to maximize flow capacity, minimize the possibility of a plugged pipe, and minimize impacts on aquatic species.
- Locate crossings where the stream channel is straight, stable, and not changing shape. Bedrock locations are desirable for concrete structures.
- For overflow protection, construct fills over culverts with an armored low point near the pipe in low fills or add an armored rolling dip on native ground just beyond a large fill to return water to the drainage and prevent off-site damage (*Figure 7.11*).
- Stabilize roadway approaches to bridges, fords, or culvert crossings with gravel, rock, or other suitable material to reduce road surface sediment from entering the stream (*Figure 7.12*). Install cross-drains on both sides of a crossing to prevent road and ditch runoff from entering the drainage channel.
- Construct bridges and culvert fills higher than the road approach to prevent road surface runoff from draining directly into the stream -- but ONLY if likelihood of culvert failure is VERY small. (*Figure 7.13*). Typically, the crossing should be designed to minimize the amount of fill.

PRACTICES TO AVOID

- Working with equipment in an unprotected natural streambed.
- Locating stream crossings in sinuous or unstable channels.
- Adversely impacting fisheries with a stream crossing structure.
- Allowing runoff from road-side ditches to flow directly into streams.

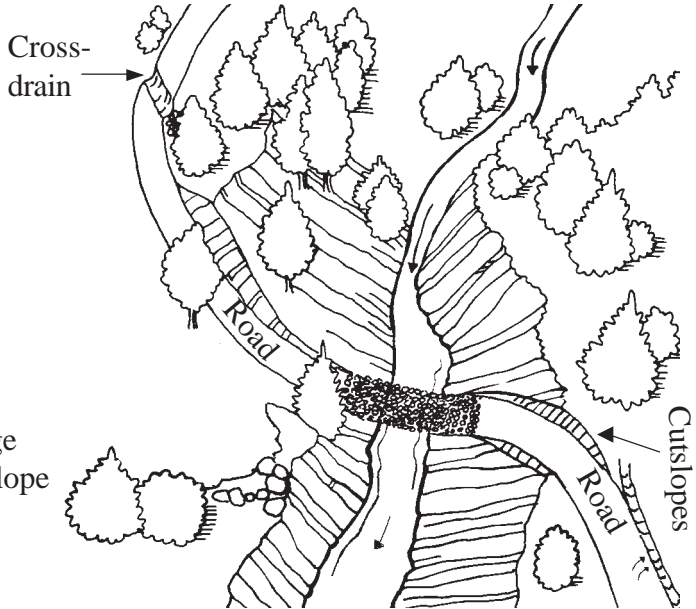
Figure 7.10 Natural drainage crossings. Minimize the area of disturbance with a perpendicular stream crossing alignment, and armor the roadway surface.

Poor Stream Crossing



Crossings near parallel to the drainage cause a large disturbed area in the channel, streambank, and approach cuts.

Better Stream Crossing



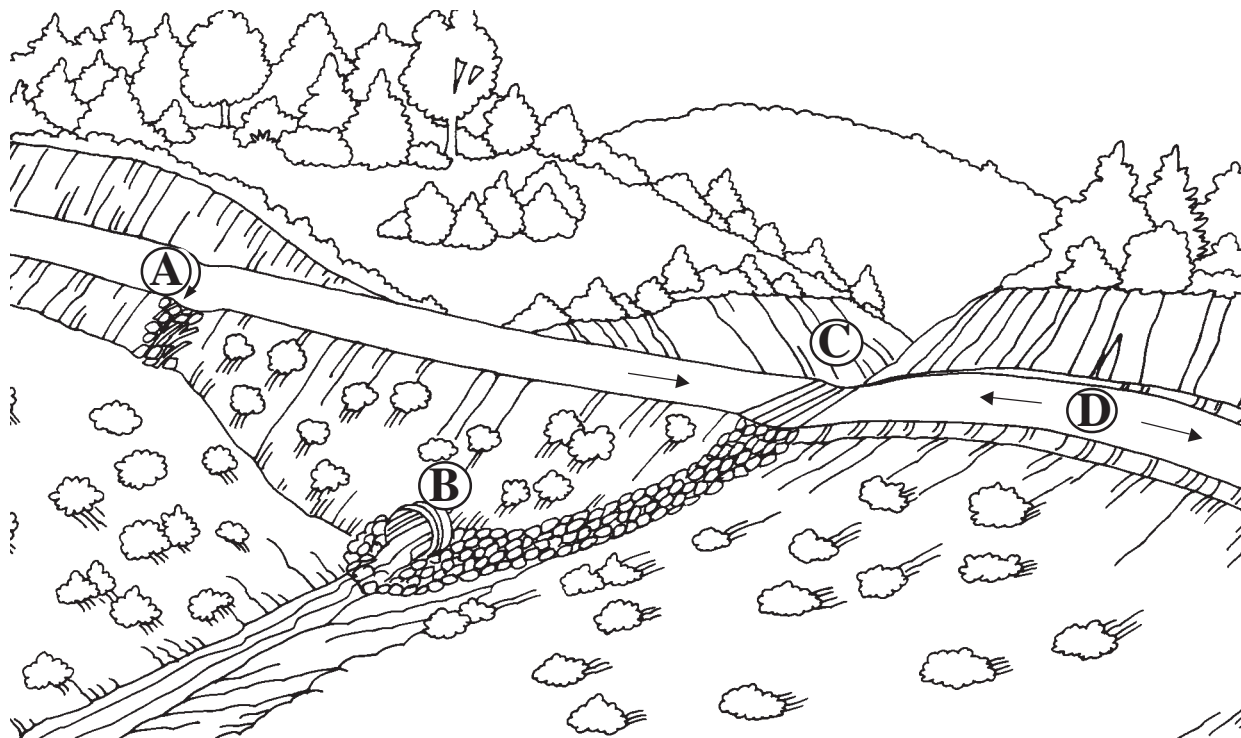
Drainage crossings perpendicular to the creek minimize the area of disturbance. Armor the stream crossing and roadway surface.



Photo 7.8 Avoid natural drainage crossings that are broad and that are not perpendicular to the drainage. Stay out of the stream! This broad channel is a good site for a vented ford.

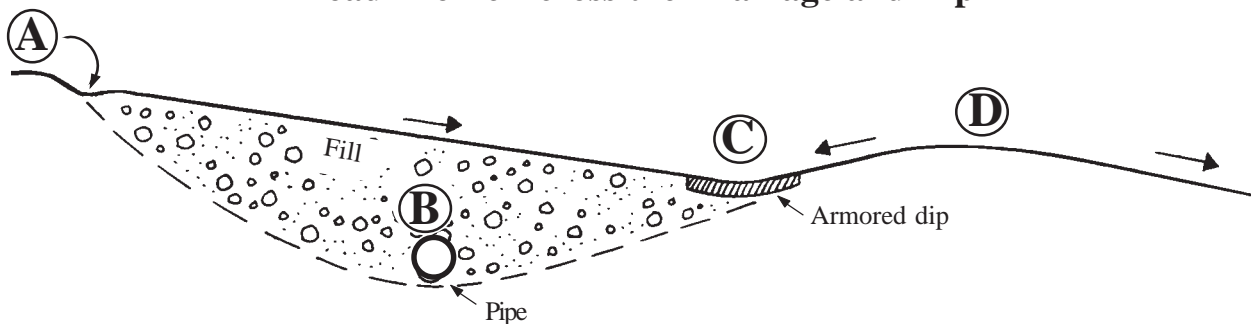
Figure 7.11

Culvert Installed with Protection using an Armored Overflow Dip to Prevent Washout and Fill Failure



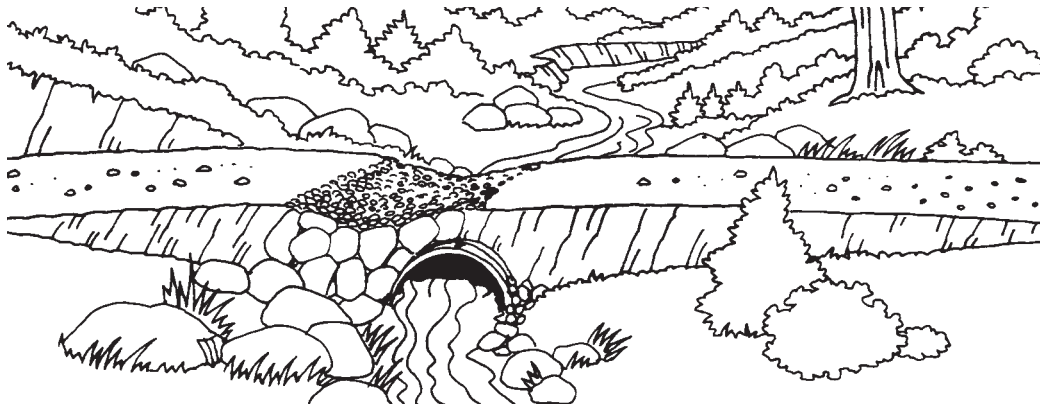
- (A) Roadway Cross Drain (Dip)
- (B) Culvert
- (C) Overflow Protection Dip
- (D) High point in the road profile

Road Profile Across the Drainage and Dip



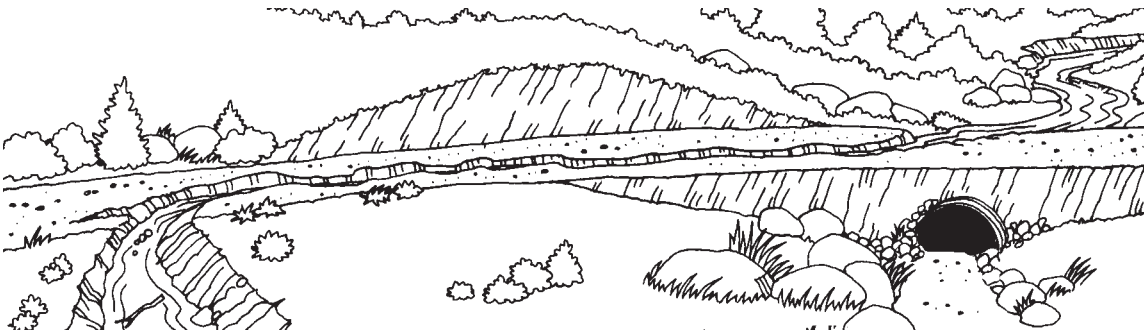
a. Overflow dip protection at a fill stream crossing. (Adapted from Weaver and Hagans, 1994)

Good Installation

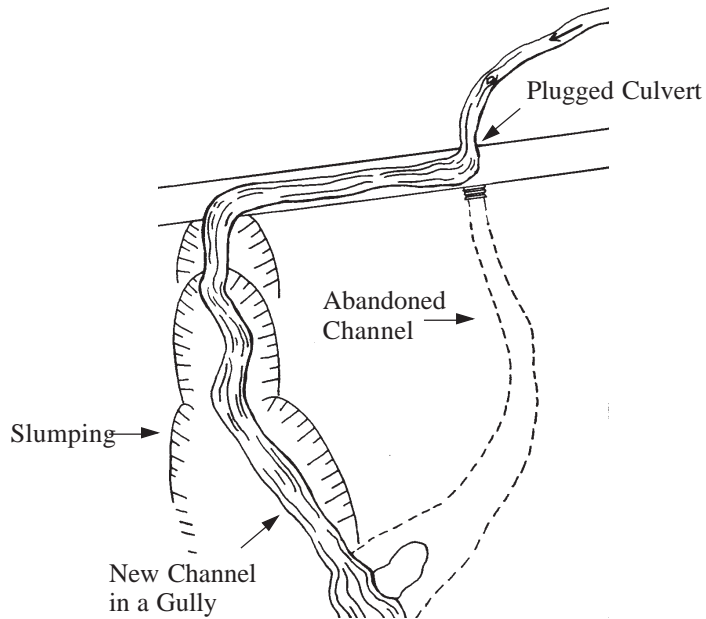


b. Armored dip over a low fill to prevent stream diversion.

Poor Installation

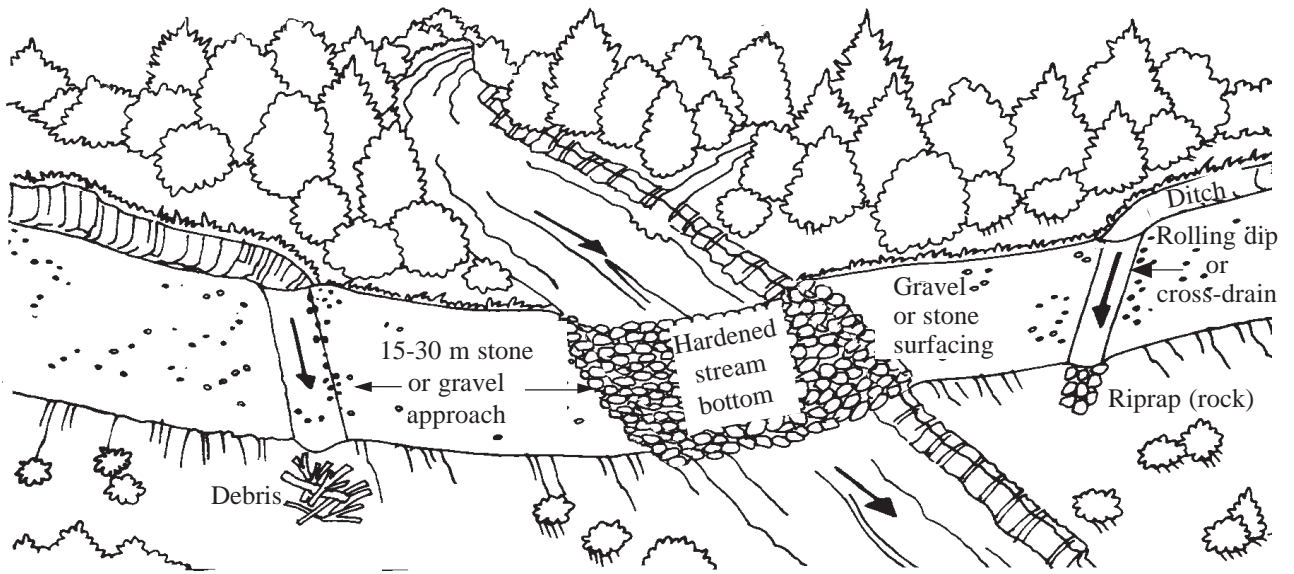


c. Sketch of a stream diverted down the road, forming a new channel.



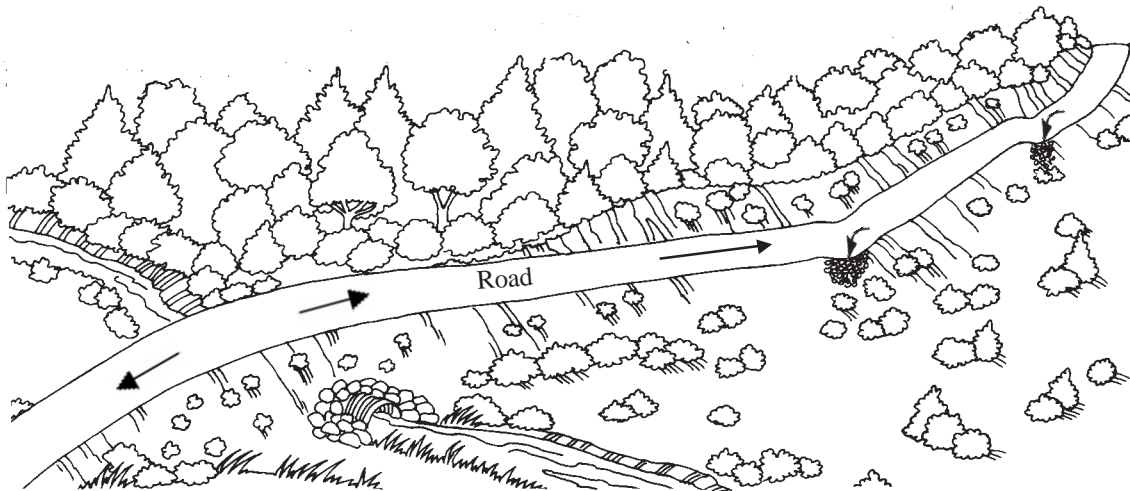
d. Consequence of stream diversion out of its natural channel. (Adapted from M. Furniss, 1997)

Figure 7.12 Protection measures at stream crossings.



Armor or stabilize the actual stream crossing (ford), add surfacing to the roadbed, and drain water off the road surface before reaching the crossing. Set stream channel armoring at the elevation of the natural stream bottom.

Figure 7.13 High point over the crossing. (Adapted from Wisconsin's Forestry Best Management Practices for Water Quality, 1995)



If a plugging failure is **unlikely** to occur, place fill directly over a culvert higher than the road approach to prevent surface road runoff from draining toward the crossing structure and into the stream.

WET AREAS AND MEADOW CROSSINGS, USE OF UNDERDRAINS

Road crossings in wet areas, including damp meadows, swamps, high groundwater areas, and spring sources are problematic and undesirable. Wet areas are ecologically valuable and difficult for road building, logging, or other operations. Soils in these areas are often weak and require considerable subgrade reinforcement. Drainage measures are expensive and may have limited effectiveness. **Wet areas should be avoided!**

If wet areas must be crossed and **cannot** be avoided, special drainage or construction methods should be used to reduce impacts from the crossing. They include multiple drainage pipes (*Photo 7.9*) or coarse permeable rock fill to keep the flow dispersed, subgrade reinforcement with coarse permeable rock, grade control, and the use of filter layers and geotextiles, as shown in *Figure 7.14*. The objective is to maintain the natural groundwater level and flow patterns dispersed across the meadow and, at the same time, provide for a stable, dry roadway surface.

Local wet areas can be temporarily crossed, or “bridged” over, using logs, landing mats, tires, aggregate, and so on. (see *Figure 7.15*). Ideally, the temporary structure will be separated from the wet area with a layer of geotextile. The geotextile helps facilitate removal of the temporary material and minimizes damage to the site. Also, a layer of geotextile

can provide some reinforcement strength as well as provide separation to keep aggregate or other materials from punching into the weak subgrade.

Subsurface drainage, through use of underdrains or aggregate filter blankets, is commonly used along a road in localized wet or spring areas, such as a wet cut bank with seepage, to **specifically remove** the groundwater and keep the roadway subgrade dry. A typical underdrain design uses an interceptor trench 1-2 meters deep and backfilled with drain rock, as shown in *Figure 7.16*. Subsurface drainage is typically needed in local wet areas and is much more cost-effective than adding a thick structural section to the road or making frequent road repairs. Design and filtration requirements for underdrains are discussed in Chapter 6 and other references.

In extensive swamp or wet ar-

reas, subsurface drainage will often not be effective. Here, either the roadway platform needs to be raised well above the water table, such as with a turnpike roadway section, or the surfacing thickness design may be based upon wet, weak subgrade conditions that will require a relatively thick structural section. A thick aggregate layer is commonly used, with the thickness based upon the strength of the soil and anticipated traffic loads.

PRACTICES TO AVOID

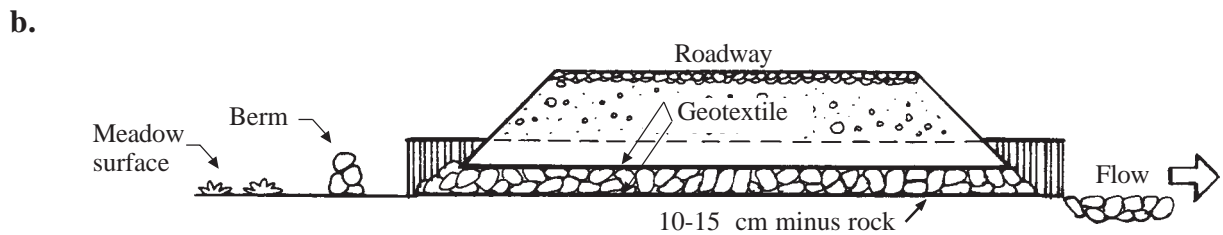
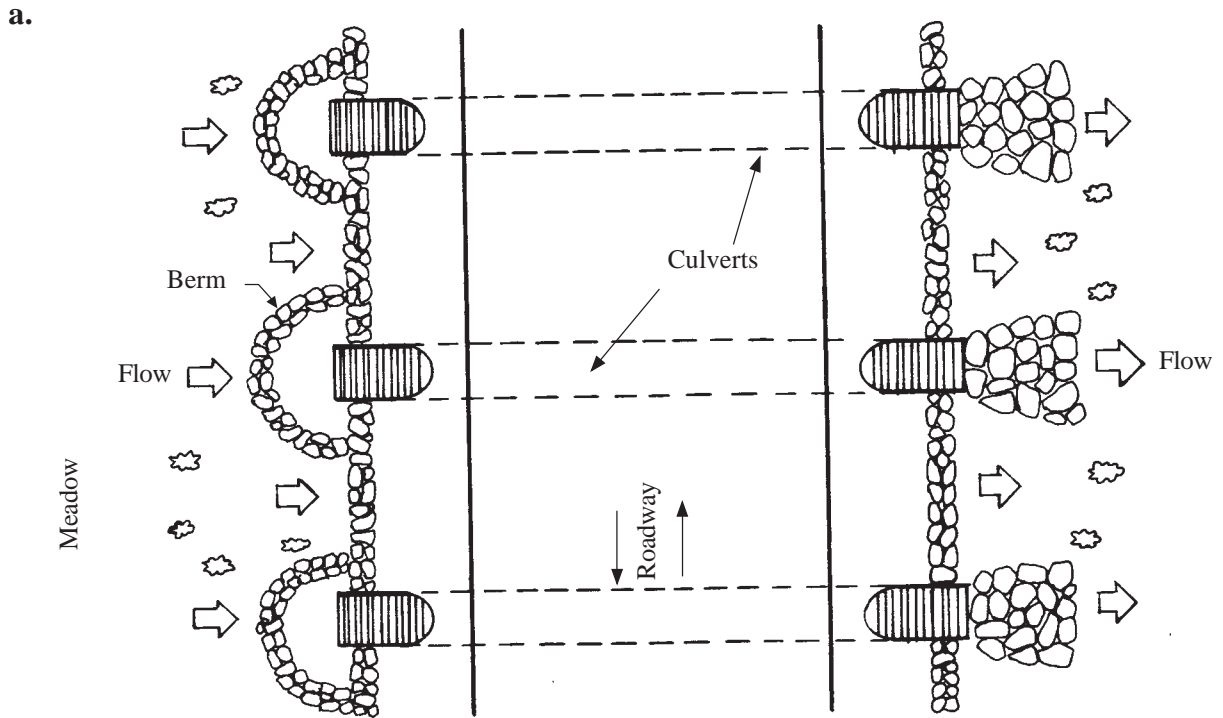
- Crossing wet areas unnecessarily.
- Concentrating water flow in meadows or changing the natural surface and subsurface flow patterns.
- Placing culverts below the meadow surface elevation.



Photo 7.9 Avoid crossing wet meadow areas. When necessary to cross, use multiple drainage pipes to keep water flow dispersed across the meadow.

Figure 7.14 Wet meadow road crossing options. (From *Managing Roads for Wet Meadow Ecosystem Recovery* by Wm. Zeedyk, 1996)

PERMEABLE FILL WITH CULVERTS
(for periodic high flows on flood plains and meadows)



ROCK FILL WITHOUT CULVERTS
(for minimal overland flow)

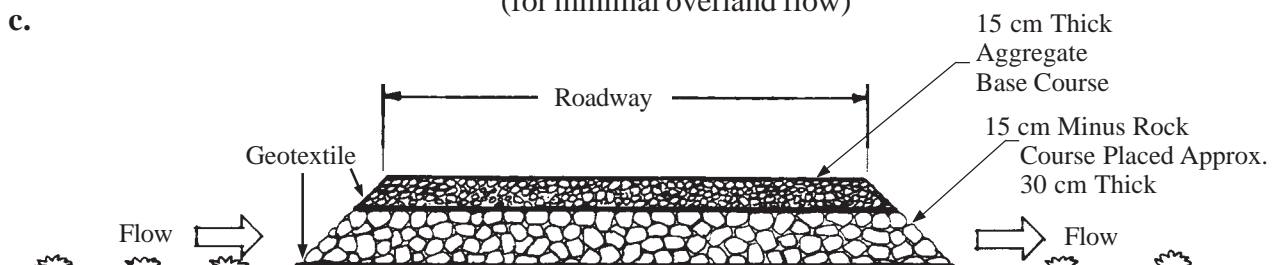
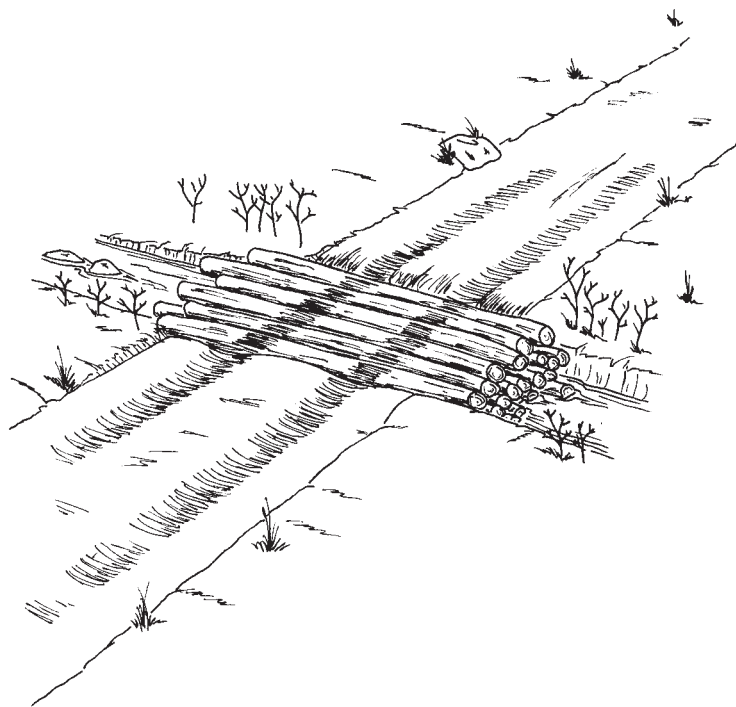


Figure 7.15 Pole or plastic pipe fords for wet area and bog crossings. Pole fords must be removed immediately after use or before the upstream end becomes clogged with debris and impedes stream flow. (Adapted from Vermont Department of Forests, Parks and Recreation, 1987)



RECOMMENDED PRACTICES

WET AREAS AND MEADOW CROSSINGS, UNDERDRAINS

- For permanent road crossings of meadows and wetlands, maintain the natural groundwater flow patterns by the use of multiple pipes set at meadow level to spread out any overland flow (See *Photo 7.9*). Alternatively, a coarse, permeable rock fill can be used where overland (surface) flow is minimal (see *Figure 7.14*).
- In areas with local wet spots and limited road use, reinforce the roadway with at least 10-30 cm of coarse graded rock or a very coarse granular soil. Ideally, separate the coarse rock and wet

soil with a filter layer of geotextile or gravel.

- For temporary crossing of small, wet drainages or swamps, “corduroy” the road with layers of logs placed perpendicular to the road and capped with a soil or gravel driving surface. PVC pipe, landing mats, wood planks, tire mats and other materials have also been used (see *Figure 7.15*). Place a layer of geotextile between the saturated soil and logs or other material for additional support and to separate the materials. Remove logs from any natural drainage channel before the rainy season (see *Photo 8.8*). A layer of chain-

link fencing or wire under the logs can help facilitate removal of the logs.

- In spring areas, use drainage measures such as underdrains or filter blankets to remove local groundwater and keep the road subgrade dry (*Figure 7.16*, *Photo 7.10*).
- Use underdrains behind retaining structures to prevent saturation of the backfill. Use underdrains or filter blankets behind fills (embankments) placed over springs or wet areas to isolate the fill material and prevent saturation and possible subsequent fill failure.

Figure 7.16 Typical road underdrain used to remove subsurface water.

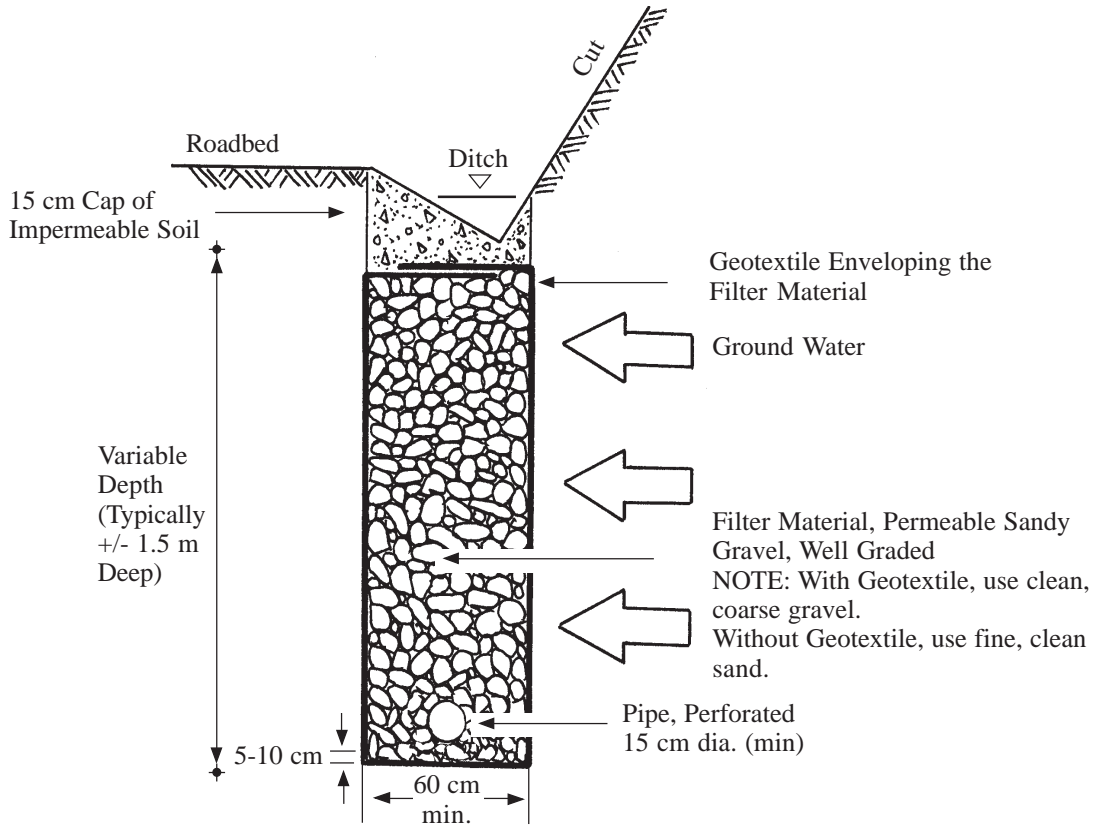


Photo 7.10 Use subdrains or filter blankets when necessary to remove groundwater from the roadway subgrade in local wet or spring areas. Note that this design needs a second layer of geotextile between the soft subgrade soil and the coarse filter rock to keep the rock clean.

Chapter 8

Culvert Use, Installation, and Sizing

“Ensure that culverts are adequately sized or have overflow protection.”

CULVERTS ARE commonly used both as cross-drains for ditch relief and to pass water under a road at natural drainage and stream crossings. In either case, they need to be properly sized and installed, and protected from erosion and scour (*Photo 8.1*). Natural drainages need to have pipes large enough to pass the expected flow plus extra capacity to pass debris without plugging (*Photo 8.2*). Fish passage may also be a design consideration. Discharge (design flow) will depend on the watershed drainage area, runoff characteristics, design rainfall intensity, and return period (frequency) of the design storm. Culvert design typically uses a minimum storm event of 20 years, and may design for as much as a 100-year event (*Photo 8.3*), depending on local regulations and the sensitivity of the site (such as with endangered species).

For small watersheds (up to 120 hectares) pipe size can

be estimated using *Table 8.1* (if better local data is not available). For larger drainages, specific site hydrologic and hydraulic analyses should be done. These analyses must consider the watershed and channel characteristics, high water levels, local rainfall data, and other available flow information (see Chapter 5, Chapter 6, and Chapter 7- Natural Stream Crossings).



Photo 8.1 Protect the outlet of culverts against erosion. Graded riprap is common for this purpose.



Photo 8.2 A culvert failure caused by insufficient flow capacity or inadequate pipe size to pass the debris (boulders) moving through the drainage.

Culverts are made of concrete or metal (corrugated steel or aluminum), and plastic pipe is occasionally used, as well as wood and masonry. The type of material used depends on cost and availability of the materials. However, corrugated metal pipe (CMP) and concrete pipe are generally more durable than plastic pipe. The shape of the culvert, such as a round pipe, pipe arch, structural arch, or box, depends on the site, the needed span, and the allowable height of soil cover. The key factors in culvert selection are that the culvert has adequate flow capacity, fits the site, and that the installation is cost-effective.

Cross-drain culvert installation options and details for ditch relief are seen in *Figure 8.1*, as well as *Figures 7.6* and *7.7*. The cross-drain pipe should ideally be placed at the bottom of the fill, the inlet should be protected with a drop inlet

structure or catch basin, and the outlet area should be protected against scour.

Culvert installation and alignment factors for drainage crossings are shown in *Figures 8.2, 8.3, 8.4, and 8.5*. Important installation details include:

minimizing channel modifications; avoiding constriction of the bankfull flow channel width; maintaining the natural grade and alignment; using quality, well compacted bedding and backfill material; and using inlet, outlet, and streambank protection measures (*Photo 8.4*). Trash racks (*Figure 8.6*) are often desirable in channels with significant amounts of debris to prevent pipe plugging (*Photo 8.5*).

Bedding and backfill material for culverts is commonly specified as “select granular material” or “select mineral soil”. Actually, most soils are satisfactory if they are free of excessive moisture, muck, lumps of frozen soil, roots, highly plastic clay, or rock larger than 7.5 cm. Bedding material beneath the pipe should not have rocks larger than 3.8 cm. Clay soil can be used if it is carefully compacted at a uniform, near-optimum moisture content. **Ideal**



Photo 8.3 Install masonry/concrete box or metal culverts with a large enough size (capacity) to safely pass the anticipated design flow (typically a 20- to 50-year recurrence event), based upon hydrological analysis. Use headwalls and wingwalls whenever possible.

backfill material is a moist, well-graded granular or sandy gravel soil with up to 10 percent fines and free of rocks. The material should be well compacted, at least as dense as the adjacent ground, and preferably at a density of 90-95% of the AASHTO T-99 maximum density. It should be placed in 15cm thick layers (lifts). A dense, uniform backfill is important to structurally support the lateral pressure from the pipe, particularly with plastic pipes.

Uniform fine sand and silt soils can be problematic when used for culvert bedding or backfill material. These fine, non-cohesive soils are very susceptible to scour and piping from moving water (*Photo 8.6*). Thus their use is

discouraged. If used, they should be very well compacted against the pipe. Ideally, a clay plug or anti-seepage collar, made of metal, concrete, or even geotextile, should be placed around the culvert pipe to force any water channel to flow in a longer path through the soil. Concrete headwalls also deter piping.

Because of changing climatic conditions, debris and bedload in channels, changing land use patterns, and uncertainties in hydrologic estimates, culvert size and capacity should be conservative, and should be oversized rather than undersized. Ideally, a culvert will be of a size as wide as the natural channel to avoid channel constriction.

Channel protection, riprap, overflow dips, headwalls, and trash racks can all help mitigate culvert problems, but none are as good as an adequately sized and well placed pipe. An oversized culvert, designed to avoid pipe repairs or failure as well as prevent environmental damage, can be very cost-effective in the long run. Also, the addition of concrete or masonry headwalls helps reduce the likelihood of pipe plugging and failure.

Pipe size, as a function of anticipated design flow (capacity) and headwater depth, can easily be determined using the Nomograms presented in *Figures 8.7a, 8.7b, and 8.7c*. These figures apply to commonly used culverts of round corrugated metal pipe,

Table 8.1

DRAINAGE STRUCTURE SIZING

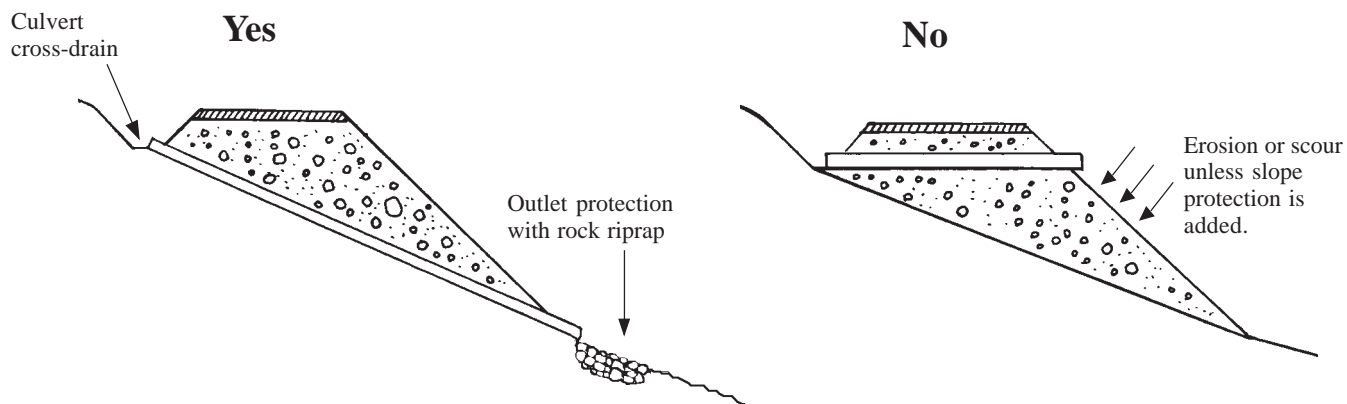
Drainage Area (Hectares)	Size of Drainage Structure Inches and Area (m ²)			
	Steep Slopes		Gentle Slopes	
	Logged, Light Vegetation C=0.7		Unlogged, Heavy Vegetation C=0.2	
	Round Pipe (in)	Area (m ²)	Round Pipe (in)	Area (m ²)
0-4	30"	0.46	18"	0.17
4-8	42"	0.89	24"	0.29
8-15	48"	1.17	30"	0.46
15-30	72"	2.61	42"	0.89
30-50	84"	3.58	48"	1.17
50-80	96"	4.67	60"	1.82
80-120			72"	2.61
120-180			84"	3.58

Notes: If pipe size is not available, use the **next larger** pipe size for the given drainage area. For intermediate terrain, interpolate between pipe sizes.

-Pipe size is based upon the Rational Formula and Culvert Capacity curves. Assumes a rainfall intensity of 75 mm/hr. (3"/hr) to 100 mm/hr (4"/hr). Values of "C" are the Runoff Coefficients for the terrain.

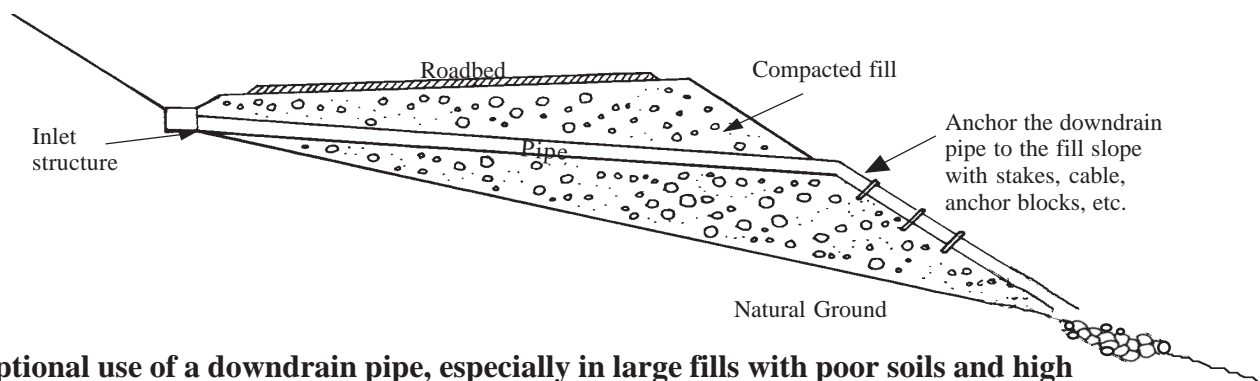
-For tropical regions with frequent high intensity rainfall (over 250 mm/hr or 10"/hr), these drainage areas for each pipe size should be reduced at least in half.

Figure 8.1 Culvert cross-drain installation options in a fill.



The outlet of the pipe should extend beyond the toe of the fill and should never be discharged on the fill slope without erosion protection.

Optional



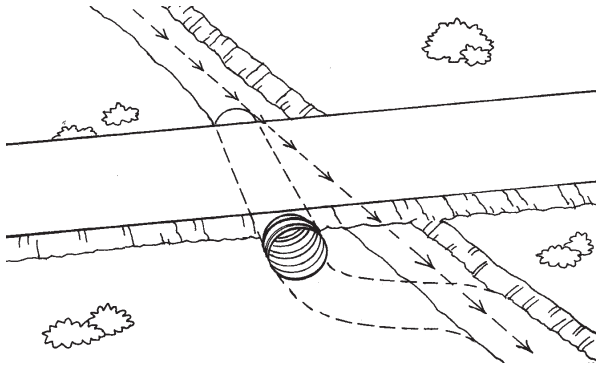
Optional use of a downdrain pipe, especially in large fills with poor soils and high rainfall areas, where fill settlement may require culvert repairs.

round concrete pipe, and concrete boxes. Each of these figures applies to pipes with inlet control, where there is no constraint on the downstream elevation of the water exiting the structure. Ideally, the inlet water elevation (headwater depth) should not greatly exceed the height or diameter of the structure in order to prevent saturation of the fill and minimize the likelihood of the pipe plugging from floating debris. More detailed information is found in FHWA Manual HDS-5, Hydraulic Design of Highway Culverts, 1998)

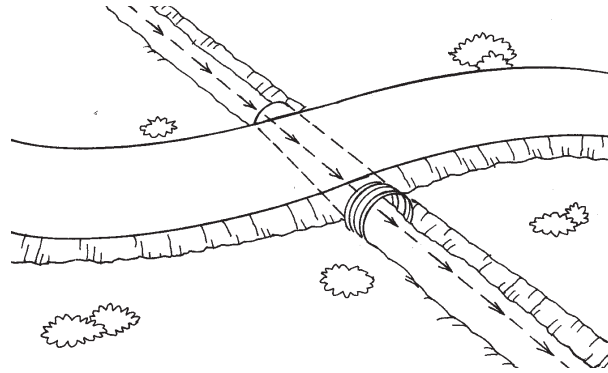


Photo 8.4 A structural plate arch pipe culvert with stream bank protection using large rock riprap placed upon a geotextile filter layer.

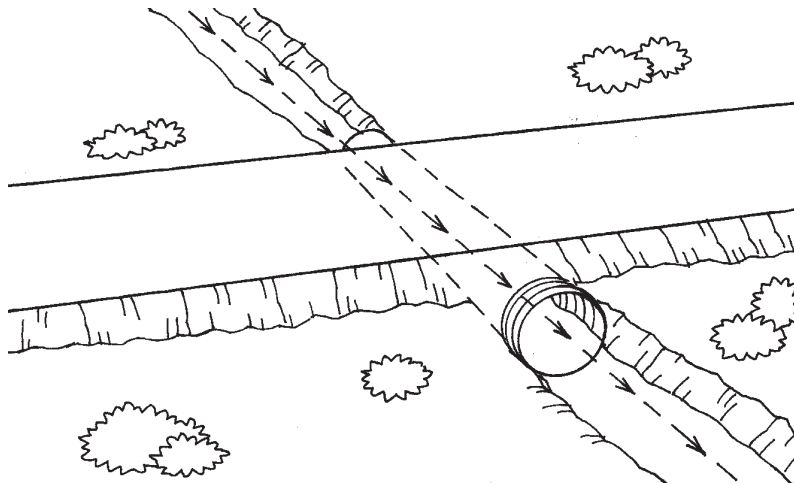
Figure 8.2 Culvert alignment and installation detail (continued on next page).



Poor – Requires a stream channel modification.

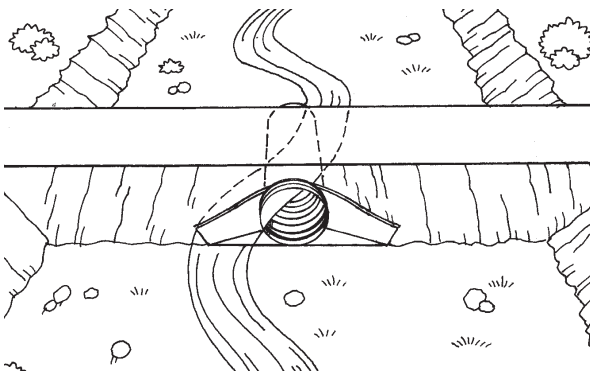


Adequate – No channel modifications but requires a curve in the road.

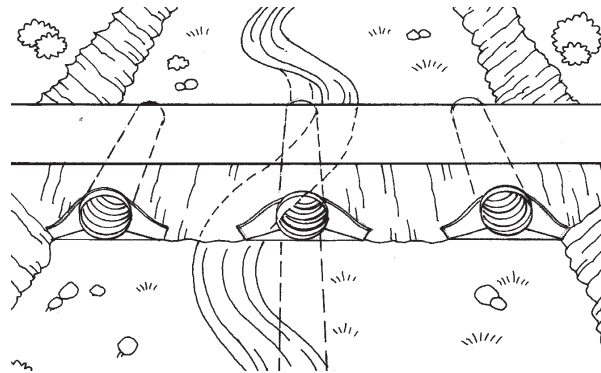


Best – No channel modification, and the road is perpendicular to the culvert without a curve in the road alignment.

a. Culvert alignment options.



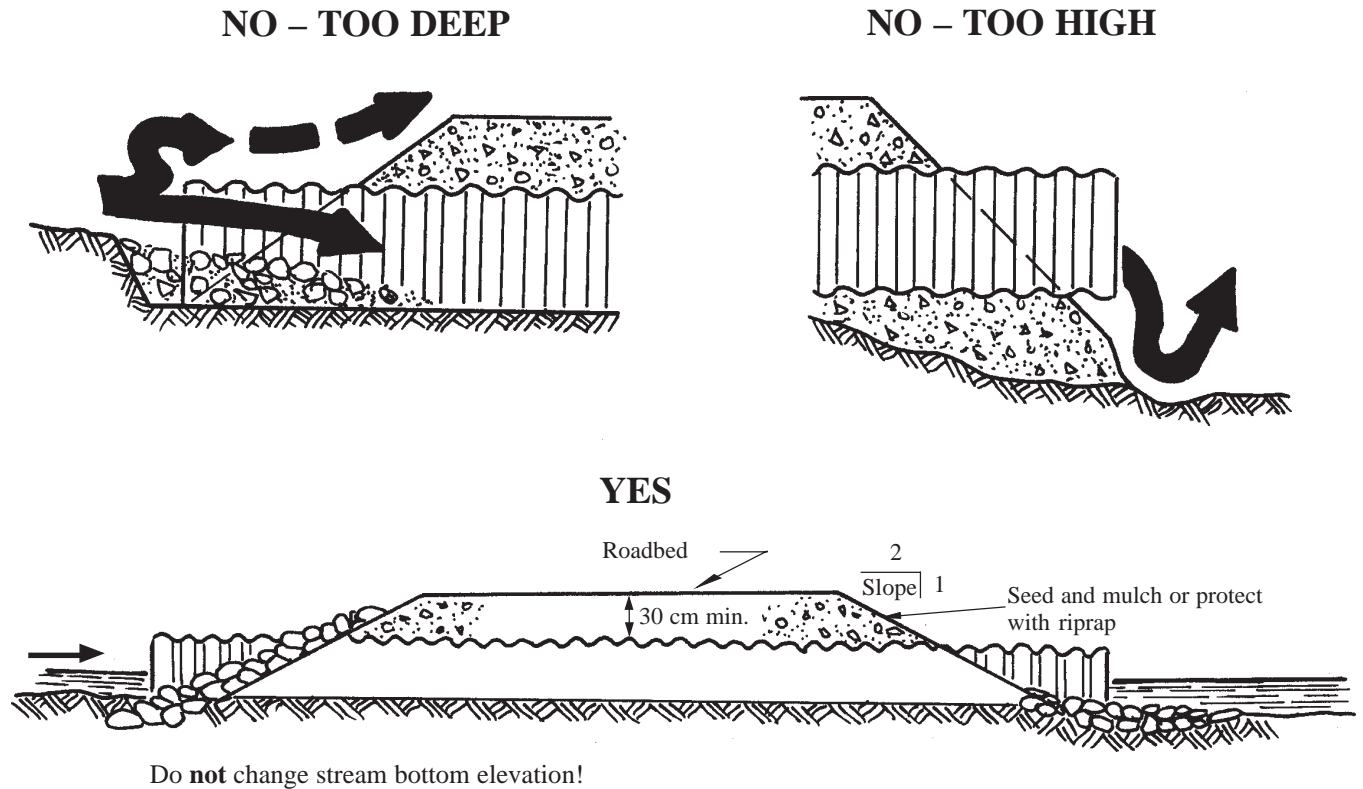
Poor – Single pipe concentrates flow in the broad channel or floodplain.



Better – Multiple pipes disperse the flow across the channel. Middle pipe may be slightly lower to pass the normal low flow and to promote fish passage.

b. Culvert installation in a broad channel.

Figure 8.2 (continued)



c. Install culverts at natural stream grade.

Figure 8.3 Culvert backfill and compaction. (Adapted from Montana Department of State Lands, 1992)

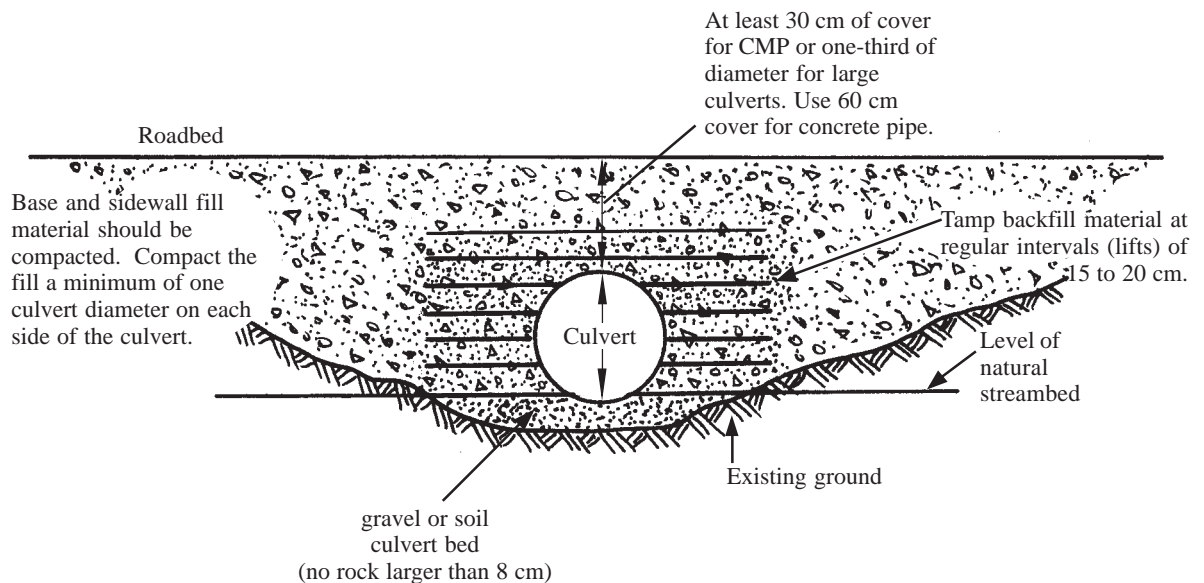
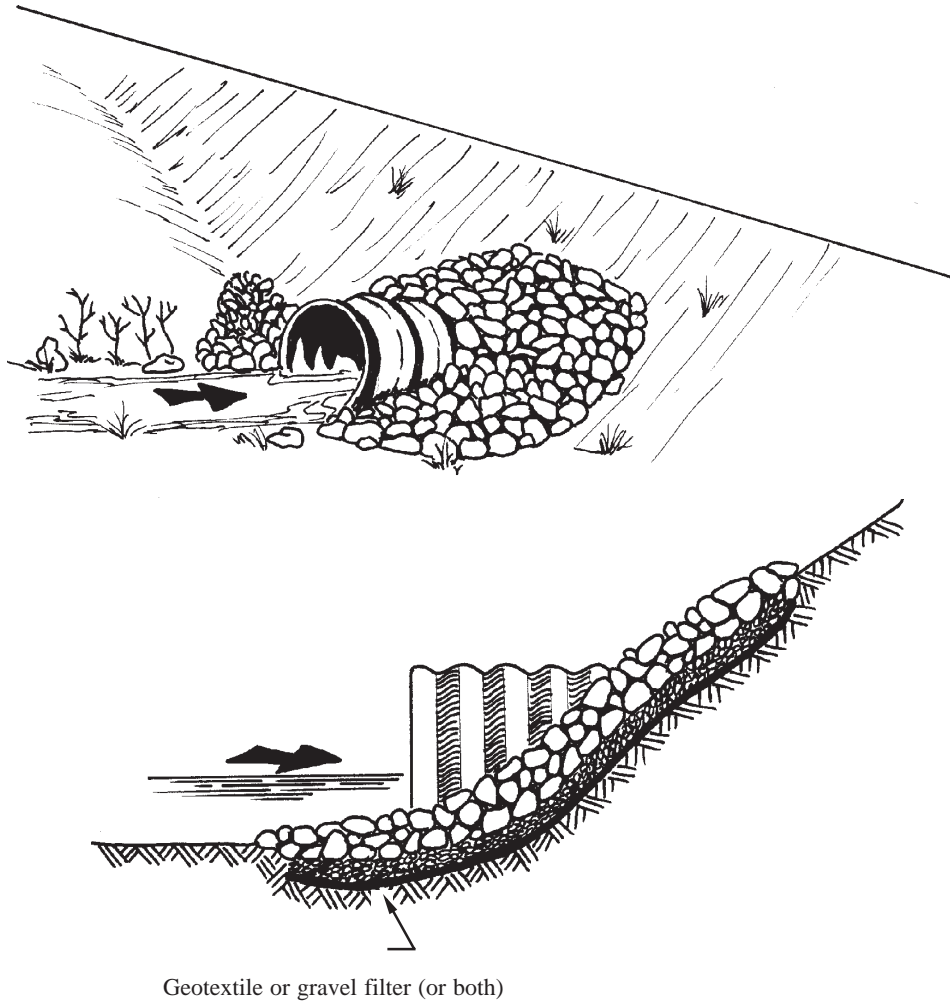
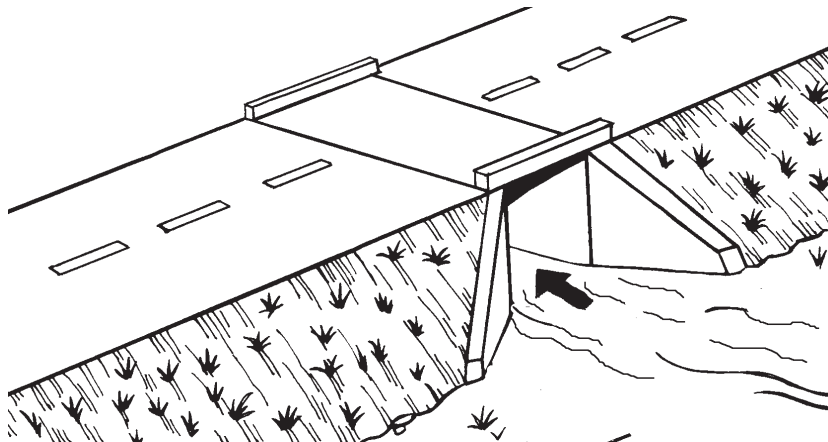


Figure 8.4 Culvert inlet and outlet protection.

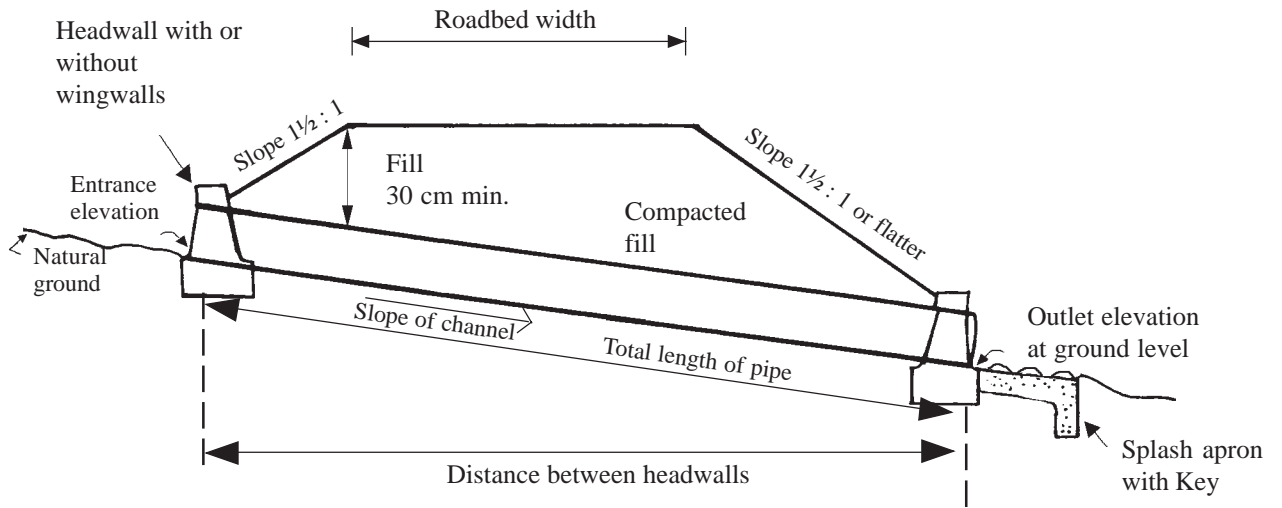


a. Normal metal culvert installation using riprap around the inlet and outlet of culverts. Also use geotextile (filter fabric) or gravel filter beneath the riprap for most installations. (Adapted from Wisconsin's Forestry Best Management Practice for Water Quality, 1995)



b. Concrete box culvert with concrete wingwalls for inlet/outlet protection and fill retention.

Figure 8.5 Culvert installation and outlet protection details with splash apron or riprap lined plunge pool.



Typical culvert installation with headwalls and splash apron or plunge pool with riprap for energy dissipation and scour control.

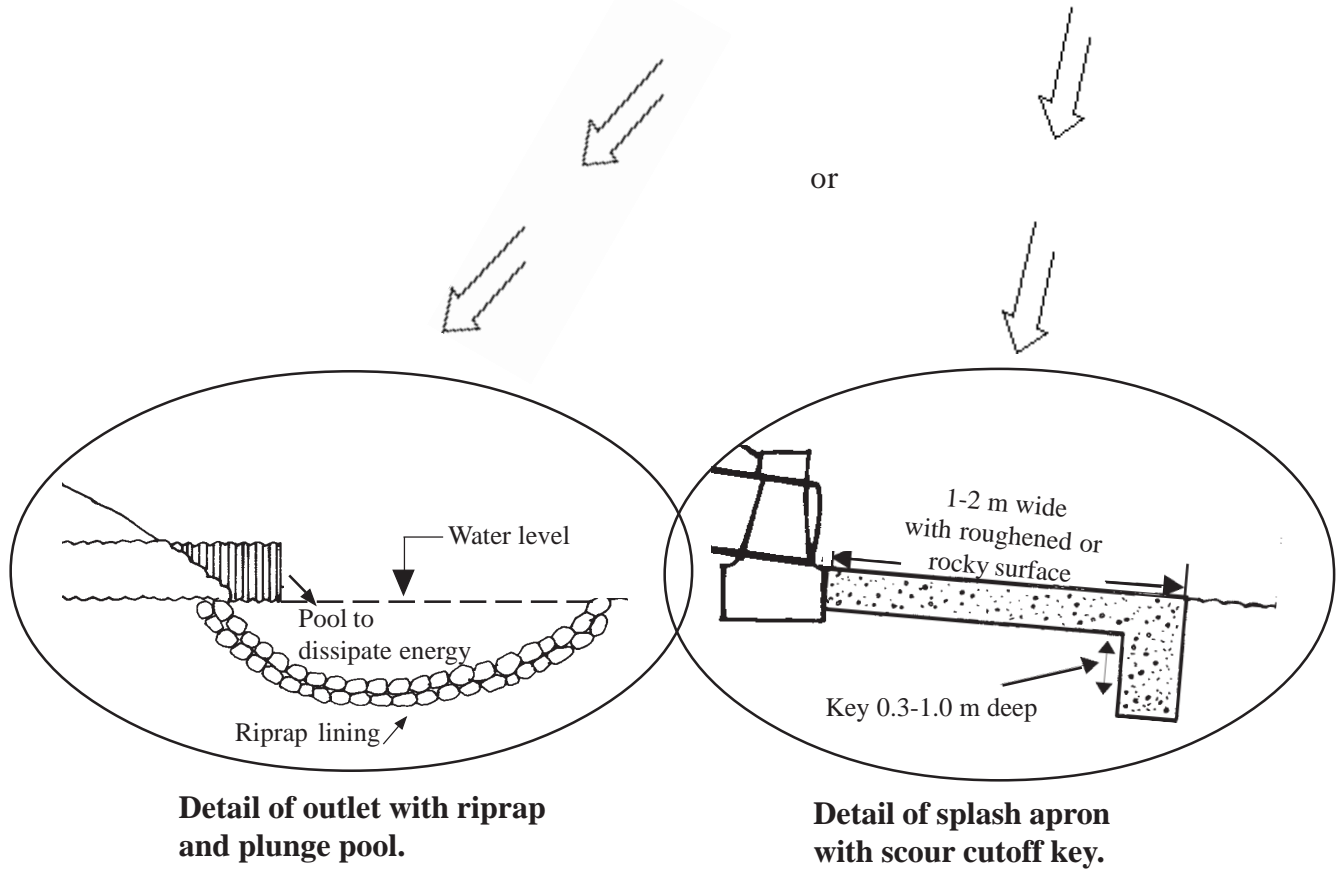


Figure 8.6 Trash rack options for culverts to prevent plugging from debris. Note that some trash racks are located at the pipe and others are located upstream of the pipe, depending on site conditions and access for cleaning and maintenance. Location at the pipe is typically best.

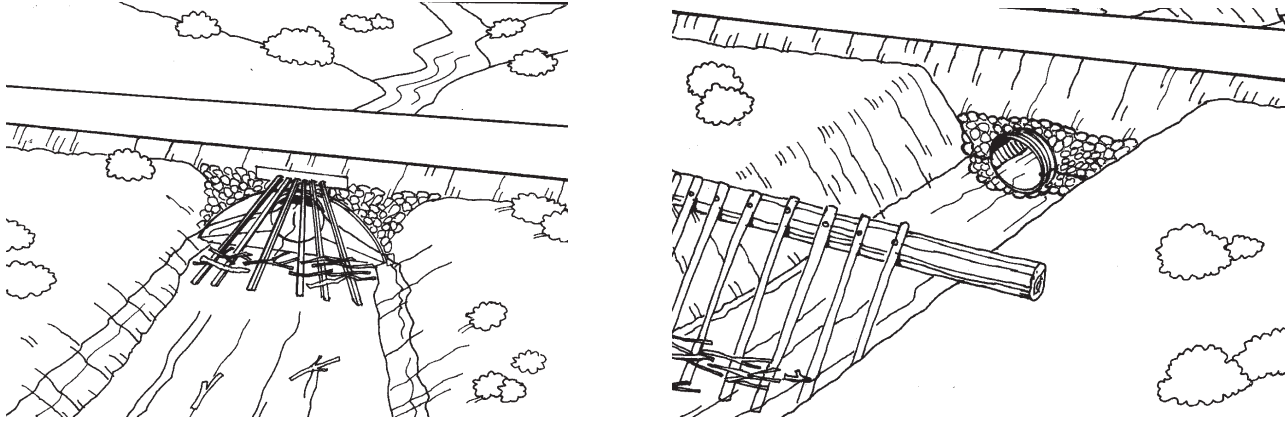


Photo 8.5 Use trash racks on culverts where a lot of debris is found in the channel. Remember that trash racks require cleaning and maintenance.

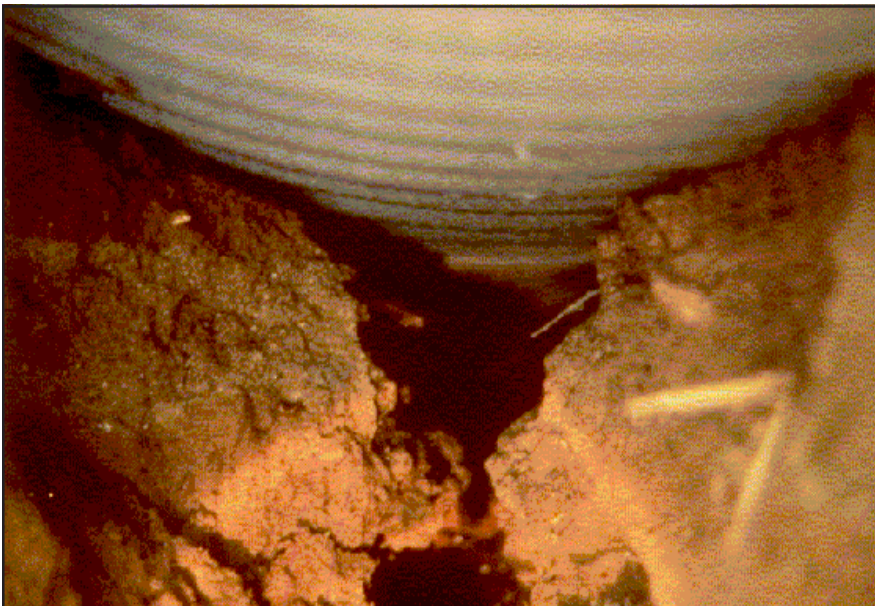


Photo 8.6 Piping can occur under poorly installed culverts and lead to failure. Avoid the use of fine sand and silt bedding and backfill soil, and ensure that the material is well compacted. Use clay plugs or anti-seepage collars as needed.

Figure 8.7a Headwater depth and capacity for corrugated metal pipe culverts with inlet control (metric system). (Adapted from FHWA, HDS 5, 1998)

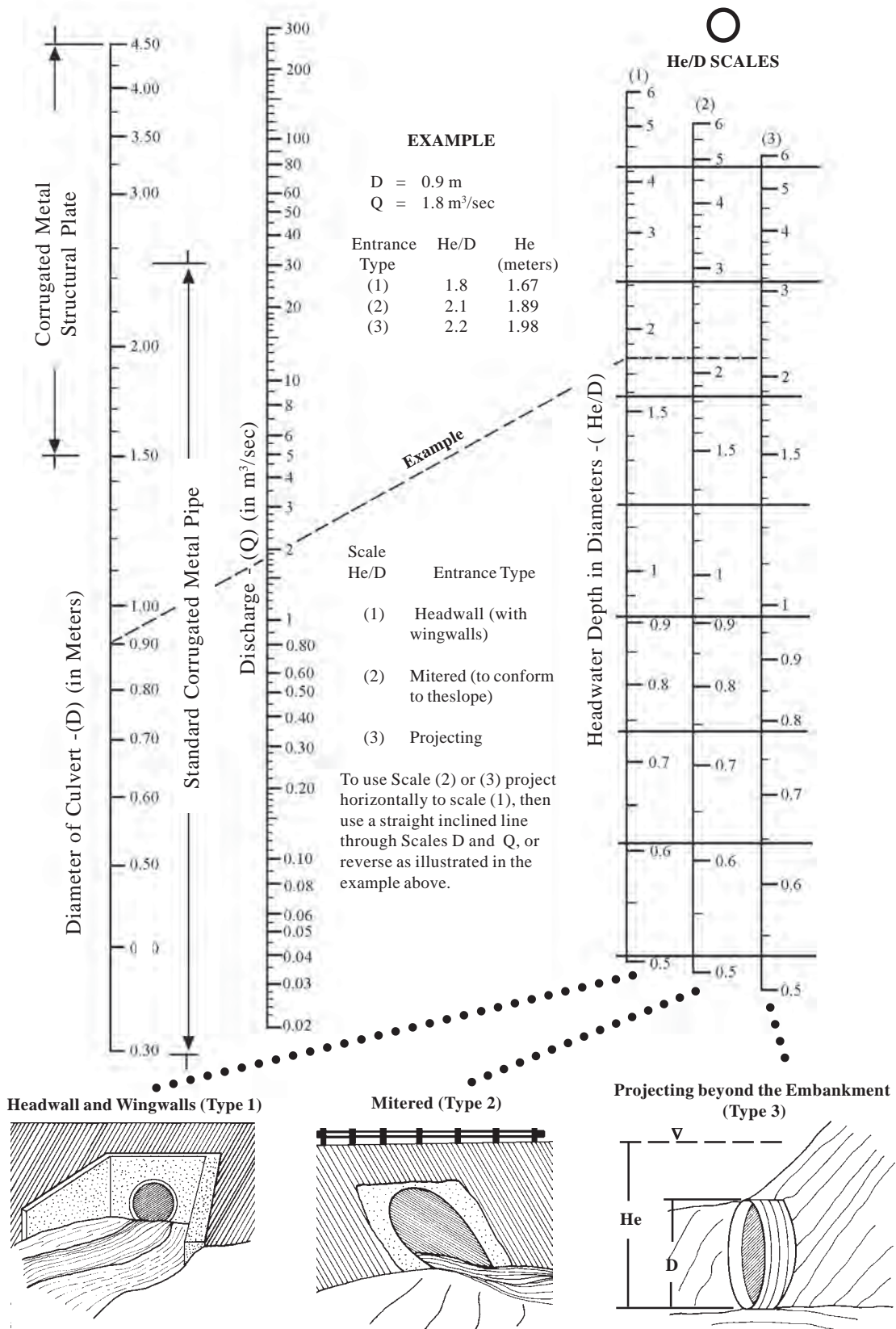


Figure 8.7b Headwater depth and capacity for concrete pipe culverts with inlet control. (Adapted from FHWA, HDS 5, 1998)

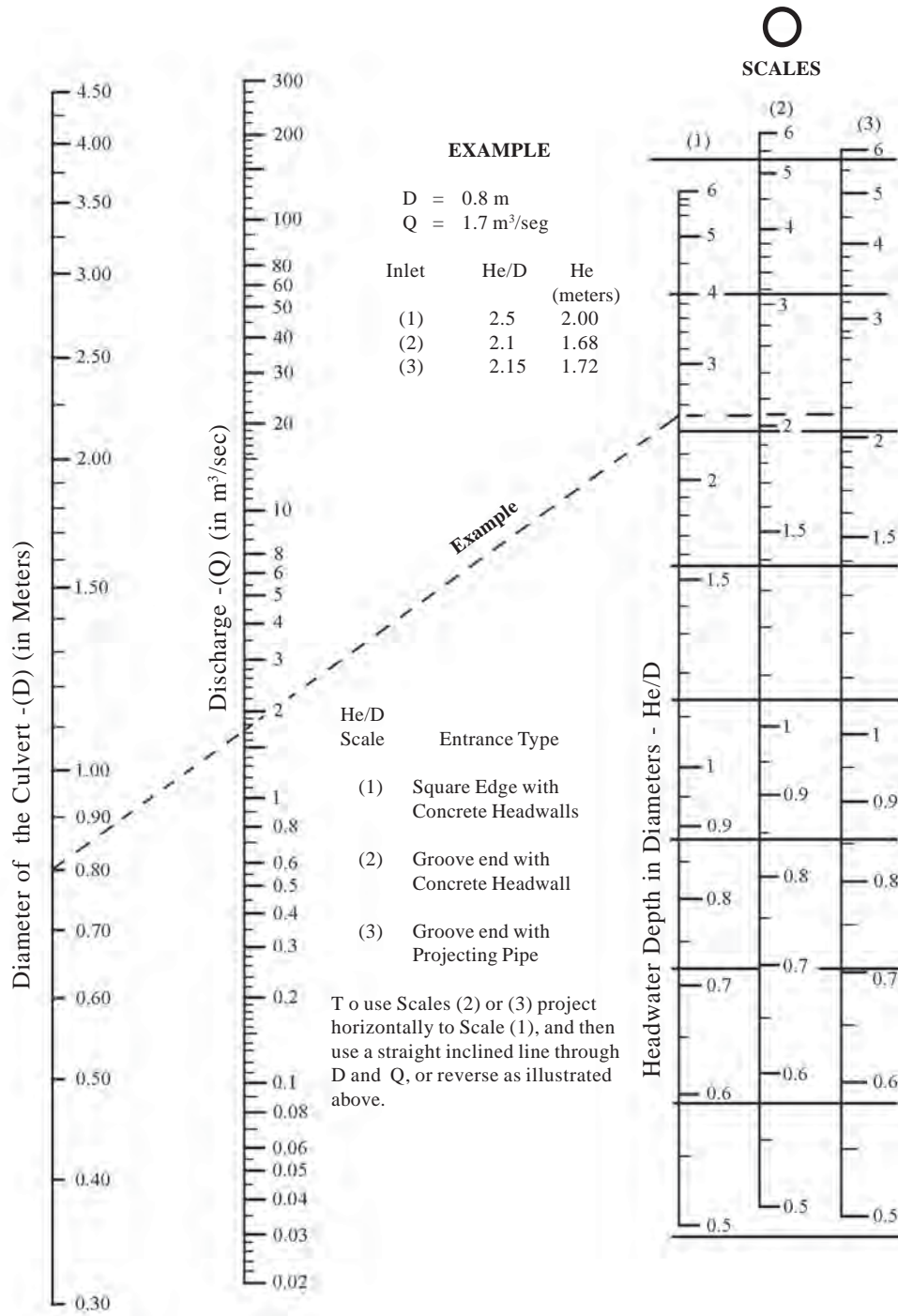
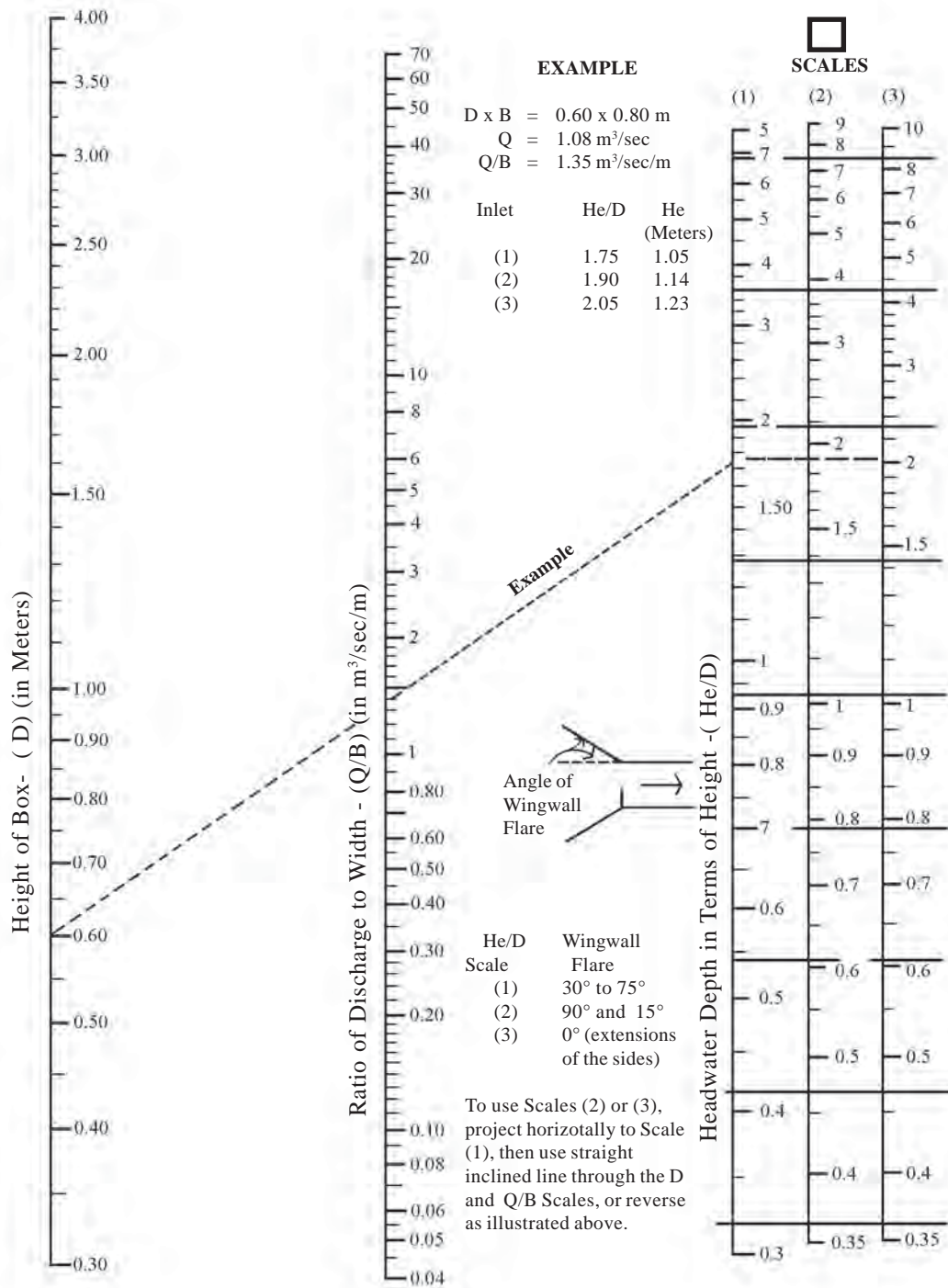


Figure 8.7c Headwater depth and capacity for concrete box culverts with inlet control. (Adapted from FHWA, HDS5, 1998)



RECOMMENDED PRACTICES

Ditch Relief Cross-Drain Culverts

- Ditch relief cross-drain pipes should typically have a diameter of 45 cm (minimum diameter of 30 cm). In areas with debris, unstable cut slopes, and raveling problems, use 60 cm or larger pipes.
- Ditch relief cross-drain pipe grade should be at least 2% more (steeper) than the ditch grade and skewed 0 to 30 degrees perpendicular to the road (see *Figure 7.4*). This additional grade helps keep the pipe from plugging with sediment.
- Ditch relief cross-drains should exit at the toe of the fill near natural ground level, at least 0.5 meters beyond the toe of the fill slope. Armor the pipe outlet (see *Figures 7.6, 7.7, and Figure 8.1*). Don't discharge the pipe on unprotected fill material, unstable slopes, or directly into streams (see *Photo 8.1 vs. Photo 8.9*).
- In large fills, culvert down-drains may be needed to move the water to the toe of the fill (*Figure 8.1*). Anchor down-drains to the slope with metal stakes, concrete anchor blocks, or cable. Pipes, flumes, or armored ditches may be used.

Drainage Crossing Culverts

- Install permanent culverts with a size large enough to pass design flood flows plus anticipated debris. Design for 20- to 50-year storm events. Sensitive streams may require designs to pass a 100-year flood. Pipe size can be determined using general design criteria, such as in *Table 8.1*, but is ideally based upon site-specific hydrologic analysis.
- Consider impacts of any structure on fish passage and the aquatic environment. Select a structure such as a bridge or bottomless arch culvert that is as wide as the ordinary high water width (bankfull width), that minimizes channel disturbance, and that maintains the natural channel bottom material (*Photo 8.7*).
- Make road crossings of natural drainages perpendicular to the drainage to minimize pipe length and area of disturbance (*Figure 8.2a*).
- Use single large pipes or a concrete box versus multiple smaller diameter pipes to minimize plugging potential in most channels (unless roadway elevation is critical). In very broad channels, multiple pipes are desirable to maintain the natural flow spread

across the channel (*Figure 8.2b*).

- For sites with limited height, use “squash pipe” or arch pipes and box culverts that maximize capacity while minimizing height.
- Use concrete or masonry headwalls on culvert pipes as often as possible. The advantages of headwalls include: preventing large pipes from floating out of the ground when they plug; reducing the length of the pipe; increasing pipe capacity; helping to funnel debris through the pipe; retaining the backfill material; and reducing the chances of culvert failure if it is overtopped (*Photo 8.8*).
- Install culverts long enough so that both ends of the culvert extend beyond the toe of the roadway fill (*Figure 8.2c, Photo 8.9*). Alternatively, use retaining walls (headwalls) to hold back the fill slope (*Figure 8.5*).
- Align culverts in the bottom and middle of the natural channel so that installation causes no change in the stream channel alignment or stream bottom elevation. Culverts should not cause

RECOMMENDED PRACTICES (cont.)

damming or pooling or increase stream velocities significantly (*Figure 8.2*).

- Firmly compact well-graded fill material around culverts, particularly around the bottom half, using placement in layers to achieve a uniform density (*Figure 8.3*). Use slightly plastic sandy gravel with fines. Avoid the use of fine sand and silt rich soils for bedding material because of their susceptibility to piping. Pay particular attention to culvert bedding and compaction around the haunches of the pipe. Do not allow the compaction to move or raise the pipe. In large fills, allow for settlement by installing the pipe with camber.
- Cover the top of metal and plastic culvert pipes with fill to a depth of at least 30 cm to prevent pipe crushing by heavy trucks. Use a minimum cover of 60 cm of fill over concrete pipe (*Figure 8.3*). For maximum allowable fill height, follow the manufacturer's recommendations.
- Use riprap, flared metal end sections or masonry/concrete headwalls around the inlet

and outlet of culverts to prevent water from eroding the fill or undercutting the pipe, as well as to improve pipe efficiency. With riprap, use graded small rock, gravel or a geotextile filter under the coarse riprap slope protection (*Figure 8.4*).

- At culvert outlets where pipe velocities are accelerated, protect the channel with either a plunge pool (on gentle slopes), rock armoring (riprap) or with a splash apron with a rough or rock inset surface and cutoff key (*Figure 8.5*).
- On existing pipes with plugging potential, add a trash rack upstream of the pipe or at the pipe entrance (inlet) to trap debris before plugging the pipe (*Figure 8.6, Photo 8.5*). Trash racks may be constructed with logs, pipe, rebar, angle iron, railroad rail, H-Piles, and so on. However, trash racks typically require additional maintenance and cleaning. They are undesirable if other alternatives, such as installing a larger pipe, are available.

- Examine stream channels for the amount of debris, logs, and brushy vegetation. In channels with large amounts of debris, consider using a **low-water ford**, oversized pipes, or placing a trash rack upstream of the pipe entrance.
- Install overflow dips off the side of the culvert in drainage channels with a large fill that could be overtopped. Also use overflow dips on long sustained road grades where a plugged culvert could divert water down the road, plugging subsequent culverts and causing extensive off-site damage (see Chapter 7, *Figure 7.11*).
- Temporary log culverts ("Humboldt" culverts) usually have very little flow capacity. When used, ensure that the structure and all fill material are removed from the channel before the rainy season or expected large runoff events (*Photo 8.10*).
- Do periodic maintenance and channel cleaning to keep culverts protected and clear of debris that could plug the pipe.

PRACTICES TO AVOID

- Discharging cross-drain pipes on a fill slope unless the slope is protected or a down drain is used.
- Using pipes undersized for the expected flow and amount of debris.
- Using non-cohesive fine sands and silt bedding materials that are very susceptible to piping.
- Installing pipes too short to fit the site.
- Placing pipes improperly (i.e. buried or aligned with the natural stream channel bottom).
- Leaving low-capacity temporary drainage crossing structures in place over the rainy season.



Photo 8.7 Use structures with natural stream bottoms, such as arch pipes, bottomless arches, or concrete box culverts, to promote fish passage and minimize impacts to the stream.



Photo 8.8 Install culverts with adequate capacity. Use headwalls to improve culvert capacity, protect the roadway fill, resist overtopping damage, and prevent bank scour, particularly at a bend in the channel.



Photo 8.9 Avoid culvert outlets in the middle of a fill slope. Use culverts long enough to extend to the toe of the slope, or use headwall structures to retain the fill material and minimize the pipe length.



Photo 8.10 Most log culverts have very little flow capacity. Remove temporary log (Humboldt) culverts before major rainstorms or before the rainy season.

Chapter 9

Fords and Low-Water Crossings

“Keep the ford profile low, armor the driving surface, and protect against scour.”

LOW WATER CROSSINGS, fords, or drifts, as they are commonly called, can offer a desirable alternative to culverts and bridges for stream crossings on low-volume roads where road use and stream flow conditions are appropriate. Like other hydraulic structures for stream crossings, they require specific site considerations and specific hydrologic, hydraulic, and biotic analyses. Ideally, they should be constructed at a relatively narrow, shallow stream location and should be in an area of bedrock or coarse soil for good foundation conditions. A ford can be narrow or broad, but should not be used in deeply incised drainages that require a high fill or excessively steep road approaches.

Low-water crossings may have a simple rock reinforced (armored) driving surface or an improved surface such as gabions or a concrete slab, as seen in *Figure 9.1a* and *Photo 9.1*. Vented fords combine the

use of culvert pipes or box culverts to pass low flows and a reinforced driving surface over the culverts to support traffic and keep traffic out of the water most of the time, as seen in *Figures 9.1b* and *c*. The reinforced driving surface over the pipes also resists erosion during overtopping at high water flows (*Photo 9.2*). The entire wetted perimeter of the structure



Photo 9.1 Use armored low-water crossings, fords, or drifts as often as possible to cross low flows in broad, shallow natural drainages, thus avoiding the use of pipes. Note that part of this reinforced driving surface needs repair.



Photo 9.2 A vented ford, using multiple culvert pipes to handle low flows through the pipes, yet allow major flows and debris to overtop the entire structure.

should be protected to a level above the anticipated high water elevation.

Key factors to consider for the design and location of a ford include the following: low and high water levels; foundation conditions; scour potential; allowable traffic delays; channel cross-section shape and confinement; protection of the downstream edge of the structure against local scour; stream channel and bank stability; locally available construction materials; and grade control for fish passage.

ADVANTAGES OF LOW-WATER CROSSINGS

- The major advantage is that a ford is usually not susceptible to plugging by debris or vegetation the way a culvert pipe may plug.
- Fords are typically less expensive structures than large culverts or bridges. They may be initially more expensive than culverts, but they require less fill in the channel, and they can accommodate larger flows.
- Vented fords can be used to pass low flows and keep vehicles out of the water, avoiding water quality degradation.
- The structure can be designed as a broad-crested weir that can pass a large flow volume over the top of the ford. It is not very sensitive to specific flow volumes since a small increase in flow depth greatly increases capacity. They can be more “forgiving” and accommodate more uncertainties in the design flow and thus are ideal for drainages with unknown or variable flow characteristics.

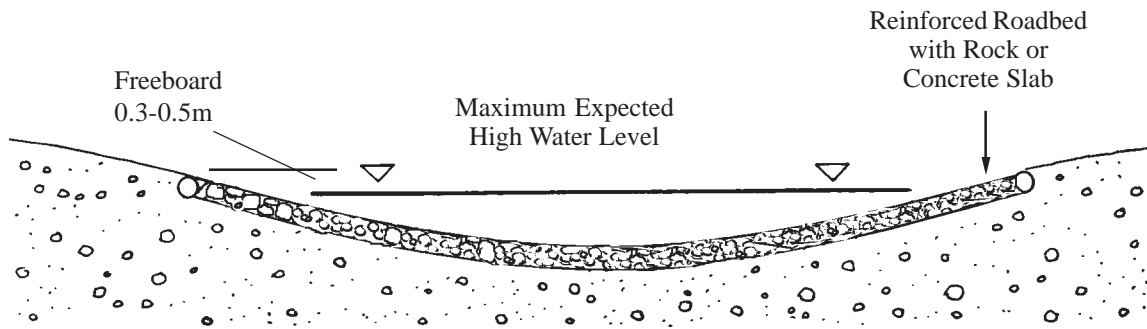
DISADVANTAGES OF LOW-WATER CROSSINGS

- Ford-type structures imply some periodic or occasional traffic delays during periods of high flow.
- The shape is not easily suitable to deeply incised drainages that would require high fills.
- Since the shape of the structure involves a dip and periodic delays, they are typically not desirable for high use or high-speed roads.
- Vented fords may back up the bedload in a stream channel, causing culvert plugging, requiring maintenance, and causing other channel adjustments.
- Fish passage may be difficult to incorporate into the design.
- Crossing the structure can be dangerous during periods of high flow (*Figure 9.2*).

For fish or aquatic species passage, a natural or rough stream channel bottom should be maintained through the ford, and water velocities should not be accelerated. Ideal structures are either

vented fords with box culverts and a natural stream bottom (see *Photo 9.5*) or simple on-grade fords with a reinforced, rough driving surface (*Figure 9.1a*).

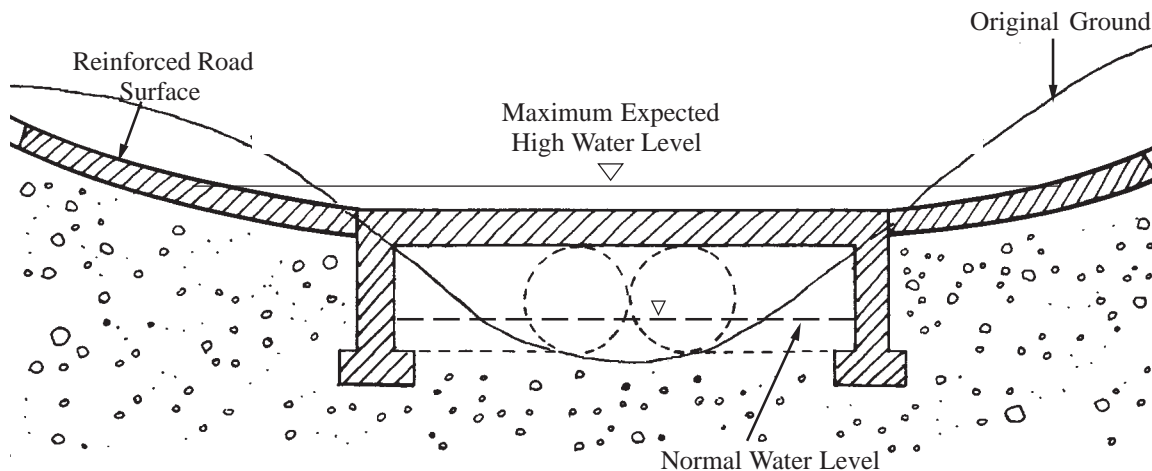
Figure 9.1 Basic low-water crossing (fords or drifts) options. Note: Armor the road surface (with rock, concrete reinforcement, etc.) to an elevation **above** the high water level!



a. Simple Low-Water Crossing with Reinforced Roadbed of Rock or Concrete

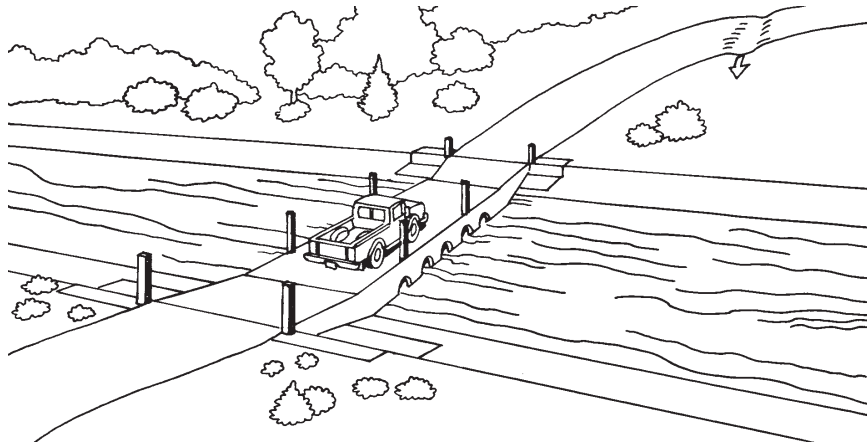


b. Improved (Vented) Ford with Culvert Pipes in a Broad Channel

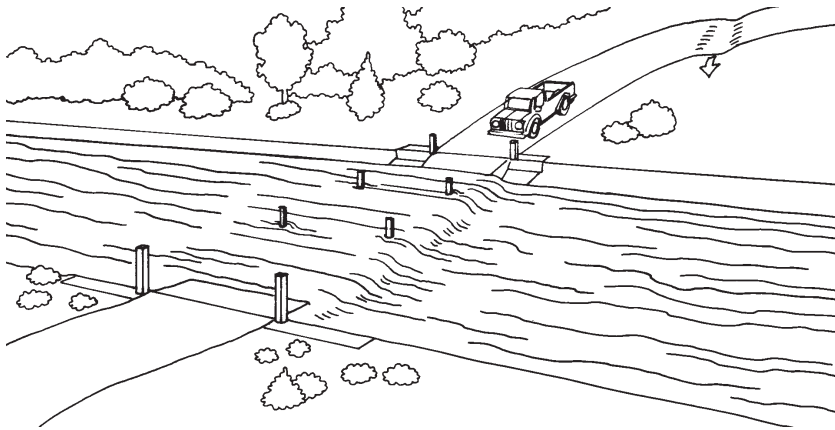


c. Vented Ford with Pipes or Box Culverts in an Incised Channel

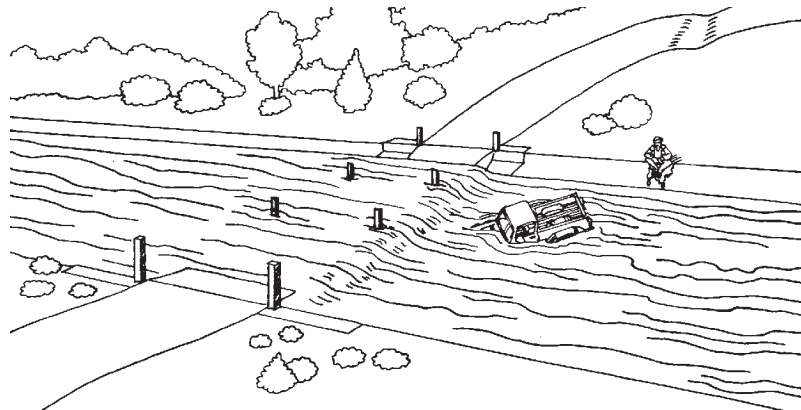
Figure 9.2 Danger of crossing a ford at high water. Fords require occasional traffic delays during periods of high water. (Adapted from Martin Ochoa, 2000 and PIARC Road Maintenance Handbook, 1994)



a. Low-water crossing at low water.



b. Low-water crossing at high water – WAIT!



c. Crossing during high water can be dangerous!

RECOMMENDED PRACTICES

- Use an adequately long slab or structure to protect the “wetted perimeter” of the natural flow channel. Add protection above the expected level of the high flow (*Photo 9.3*). Allow for some freeboard, typically 0.3 to 0.5 meters in elevation, between the top of the reinforced driving surface (slab) and the expected high water level (see *Figure 9.1*). The flow capacity of a ford, and thus the high water level, can be estimated using a “Broad-Crested Weir” formula.
- Protect the entire structure with cutoff walls, riprap, gabions, concrete slabs, or other scour protection. The downstream edge of a ford is a particularly critical location for scour and needs energy dissipators or riprap protection because of the typical drop in water level off the structure and the accelerated flows across the slab.
- For simple rock fords, use large graded rock in the roadbed through the creek, large enough to resist the flow of water. Use criteria as shown in *Figure 6.1*. Fill the voids with clean, small rock or gravel to provide a smooth driving surface. This small rock will have to be periodically maintained and replaced.
- Use fords for crossing seasonally dry streambeds or streams with low flows during most periods of road use. Use improved (vented) fords with pipes or concrete box culverts to pass low water flows (*Photo 9.4*). Accommodate fish passage where needed using box culverts with a natural stream channel bottom (*Figure 9.1c* and *Photo 9.5*).
- Locate fords where stream banks are low and where the channel is well confined. For moderately incised drainages, use improved fords with pipe or box culverts (*Figure 9.1c*).
- Place foundations into scour resistant material (bedrock or coarse rock) or below the expected depth of scour. Prevent foundation or channel scour with the use of locally placed heavy riprap, gabion baskets, concrete reinforcement or dense vegetation.
- Use well placed, sturdy depth markers at fords to advise traffic of dangerous water depths (*Figure 9.2*).

PRACTICES TO AVOID

- Constructing sharp vertical curves on fords that can trap long trucks or trailers.
- Placing approach fill material in the drainage channel.
- Crossing fords during high water flows.
- Placing low-water crossings on scour susceptible, fine grained soil deposits, or using designs without scour protection.
- Constructing fords that block upstream and downstream passage of fish.

Photo 9.3 With low-water crossings, the downstream edge of the structure typically must be protected against scour and the entire wetted perimeter (to a level above the high water level) should be reinforced.



Photo 9.4 Use vented fords with pipes or openings to keep traffic out of the water most of the time, minimize traffic delays, and allow for fish passage. Note the downstream scour protection with gabions and rock.



Photo 9.5 Some fords can be designed as “low-water bridge” structures. They must be designed to be occasionally overtopped and have an erosion resistance deck and approaches. This structure is ideal for fish passage.



Chapter 10

Bridges

"Bridges -- usually the best, but most expensive drainage crossing structure. Protect bridges against scour."

BRIDGES ARE relatively expensive but often are the most desirable stream crossing structure because they can be constructed outside of the stream channel and thus minimize channel changes, excavation, or placement of fill in the natural channel. They minimize disturbance of the natural stream bottom and they do not require traffic delays once constructed. They are ideal for fish passage. They do require detailed site considerations and specific hydraulic analyses and structural design.

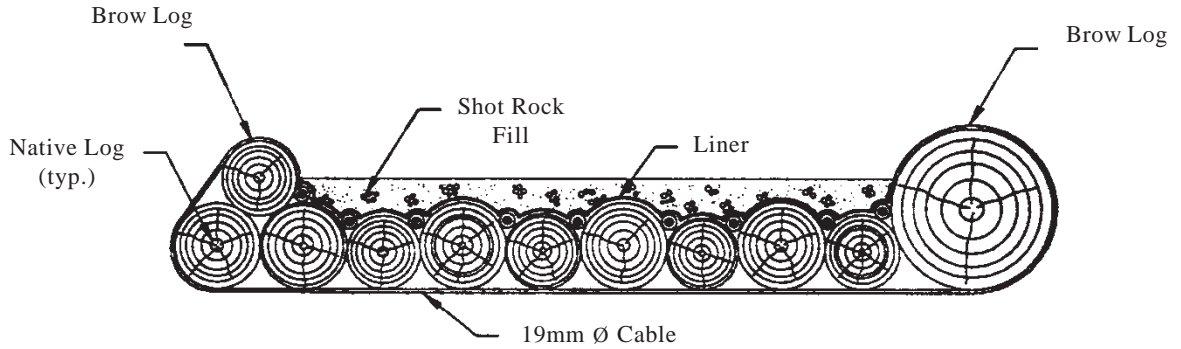
The bridge location and size should ideally be determined by an engineer, hydrologist, and fisheries biologist who are working together as a team. When possible, a bridge should be constructed at a narrow channel location and should be in an area of bedrock or coarse soil and rock for a bridge site with good foundation conditions. **Many bridge failures occur due to foundations placed upon fine materials that are susceptible to scour.**

Bridges should be designed to ensure that they have adequate structural capacity to support the heaviest anticipated vehicle or posted for load limits. Simple span bridges may be made of logs, timbers, glue-laminated wood beams, steel girders, railroad car beds, cast-in-place concrete slabs, prefabri-

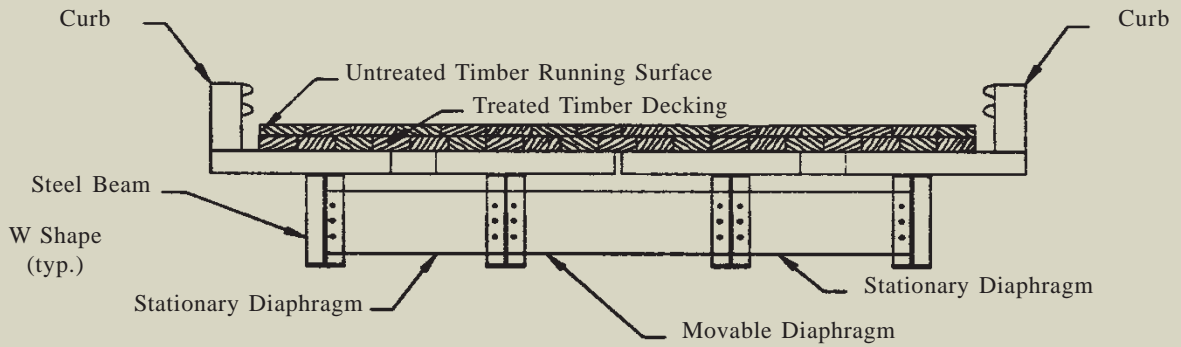


Photo 10.1 Culverts, fords, or bridges may be used for stream crossings. Use bridges to cross large permanent streams, minimize channel disturbance, and to minimize traffic delays. Use an opening wide enough to avoid constricting the natural channel. Locate the bridge foundation on bedrock or at an elevation below the anticipated depth of scour.

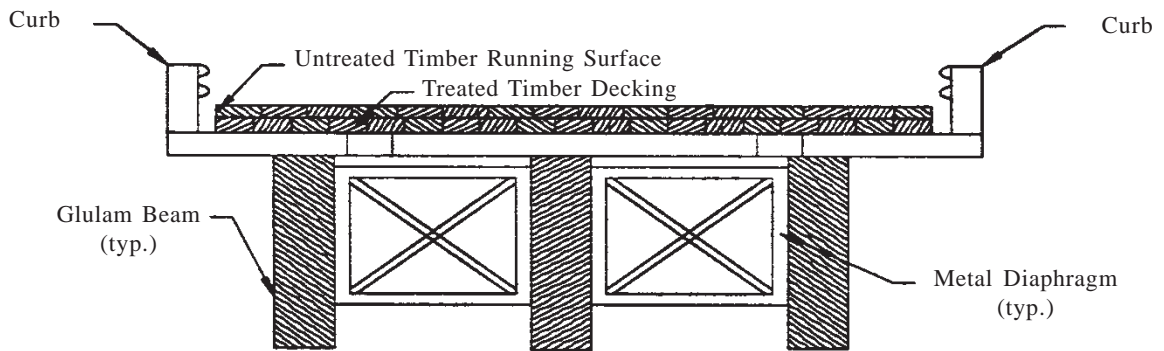
Figure 10.1 Cross-sections of typical types of bridges used on low-volume roads.



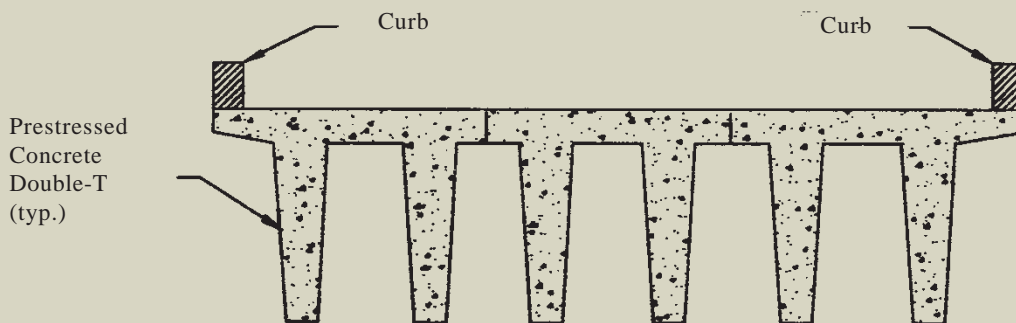
Native Log Stringer Bridge



Hamilton EZ Bridge (Modular)



Treated Timber Glue Laminated Bridge



Prestressed Concrete Single or Double-T Bridge



Photo 10.2 A bridge structure typically offers the best channel protection by staying out of the creek. Use local material for bridges as available, considering design life, cost, and maintenance. Inspect bridges regularly, and replace them when they are no longer structurally adequate.

cated concrete voided slabs or “T” beams, or using modular bridges such as Hamilton EZ or Bailey Bridges (see *Figure 10.1*). Many types of structures and materials are appropriate, so long as they are structurally designed (*Photo 10.1*).

“Standard designs” can be found for many simple bridges as a function of bridge span and loading conditions. Complex structures should be specifically designed by a structural engineer. Bridge designs often require the approval of local agencies or governments. Concrete structures are desirable because they can be relatively simple and inexpensive, require minimal maintenance, and have a relatively long design life (100+ years) in most environments. Log bridges are commonly used because of the availability of local materials, particularly in remote areas. However, keep in

mind that they have relatively short spans and they have a relatively short design life (20-50 years) (*Photo 10.2*).

Foundations for bridges may



Photo 10.3 Scour is one of the most common causes of bridge failure. Use an opening wide enough to minimize constriction of the natural channel. Locate the bridge foundation on bedrock when possible, or below the depth of scour, and use stream bank protection measures such as riprap.

include simple log sills, gabions, masonry retaining walls, or concrete stem walls with footings. Some simple bridge foundation details are shown in *Figure 10.2*. Deep foundations often use drilled piers or driven piles. Most bridge failures occur either because of inadequate hydraulic capacity (too small) or because of scour and undermining of a foundation placed upon fine soils (*Photo 10.3*). Thus, **foundation considerations are critical**. Since bridge structures are typically expensive, and sites may be complicated, most bridge designs should be done with input from experienced structural, hydraulic, and geotechnical engineers.

Periodic bridge inspection (every 2-4 years) and maintenance is needed to ensure that the structure is safe to pass the anticipated vehicles, that the stream channel is clear, and to maximize the de-

sign life of the structure. Typical bridge maintenance items include cleaning the deck and “seats” of the girders, clearing vegetation and debris from the stream channel, replacing object markers and signs, repairing stream bank protection measures, treating dry and checking wood, replacing missing nuts and bolts, and repainting the structure.

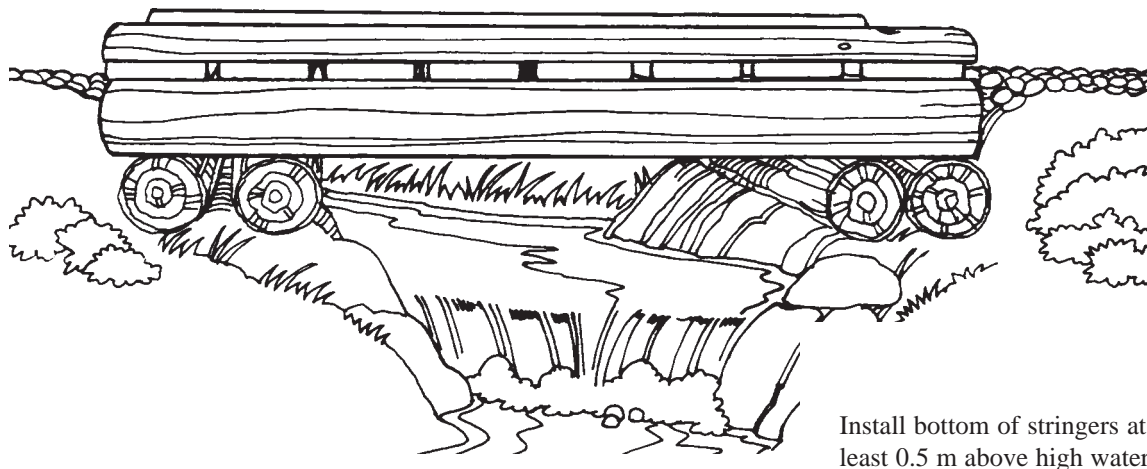
PRACTICES TO AVOID

- Placing piers or footing in the active stream channel or mid-channel.
- Placing approach fill material in the drainage channel.
- Placing structural foundations on scour susceptible soil deposits such as silts and fine sands.
- Constricting or narrowing the width of the natural stream channel.

RECOMMENDED PRACTICES

- Use an **adequately long bridge span** to avoid constricting the natural active (bankfull) flow channel. Minimize constriction of any overflow channel.
- Protect the upstream and downstream approaches to structures with wing walls, riprap, gabions, vegetation, or other slope protection where necessary (*Photo 10.4*).
- Place foundations onto non-scour susceptible material (ideally bedrock (*Photo 10.5*) or coarse rock) or below the expected maximum depth of scour. Prevent foundation or channel scour with the use of locally placed heavy riprap, gabion baskets, or concrete reinforcement. Use scour protection as needed.
- Locate bridges where the stream channel is narrow, straight, and uniform. Avoid placing abutments in the active stream channel. Where necessary, place in-channel abutments in a direction parallel to the stream flow.
- Consider natural channel adjustments and possible channel location changes over the design life of the structure. Channels that are sinuous, have meanders, or have broad flood plains may change location within that area of historic flow after a major storm event.
- For bridge abutments or footings placed on natural slopes, set the structure into firm natural ground (not fill material or loose soil) at least 0.5 to 2.0 meters deep. Use retaining structures as needed in steep, deep drainages to retain the approach fills, or use a relatively long bridge span (*Figure 10.2*).
- Design bridges for a 100- to 200-year storm flow. Expensive structures and structures with high impacts from failure, such as bridges, justify conservative designs.
- Allow for some freeboard, typically at least 0.5 to 1.0 meter, between the bottom of bridge girders and expected high water level and floating debris. Structures in a jungle environment with very high intensity rainfall may need additional freeboard. Alternatively, a bridge may be designed for overtopping, somewhat like a low water ford, and eliminate the need for freeboard, but increase the need for an erosion resistant deck and approach slabs (*Photo 10.6*).
- Perform bridge inspections every 2 to 4 years. Do bridge maintenance as needed to protect the life and function of the structure.

Figure 10.2 Bridge installation with simple foundation details.



Typical Log Bridge Installation

Ensure that the bridge has adequate flow capacity beneath the structure. Keep fill material and the abutments or footings out of the stream channel. Set footings into the streambank above the high water level or below the depth of scour if they are near the channel. Add protection against scour, such as riprap, gabions, or vegetation.

Set the stringers or deck slab at least 0.5 to 2.0 meters above the expected high water level to pass storm flow **plus** debris.

Bridge Abutment Detail

Set bridge foundation (gabion abutment, footings, or logs) into rock or firm, stable soil. Set footings 0.5-2.0 meters into firm material.

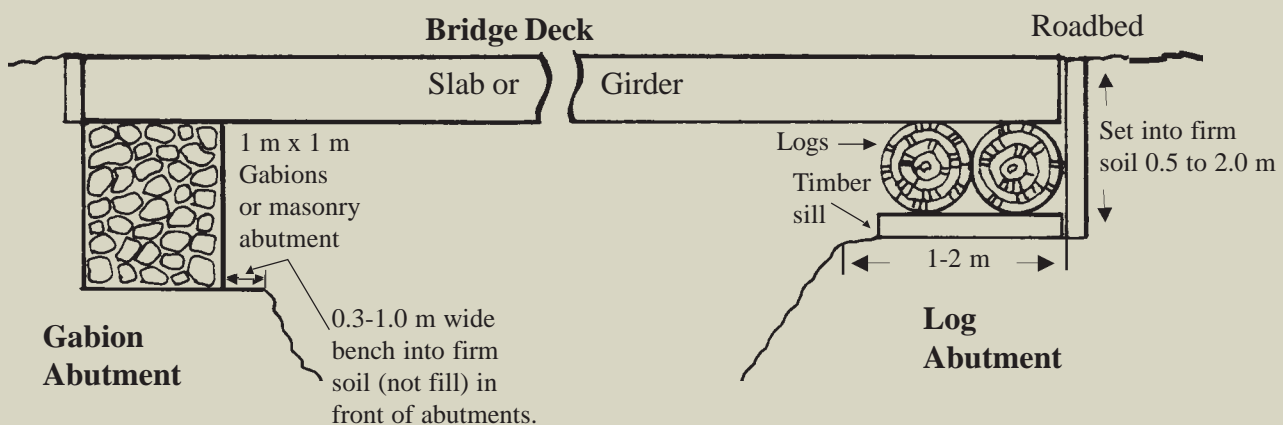


Photo 10.4 Concrete structures have a long design life and are typically very cost-effective for long bridge spans. Medium-length structures often combine a concrete deck placed upon steel girders. Use bank protection, such as riprap, to protect the entrance and outlet of structures.



Photo 10.5 Locate the bridge foundation on bedrock or on non-scour susceptible material when possible. When it is necessary to locate the bridge foundation on materials susceptible to scour, use a deep foundation or design the bridge with scour protection.



Photo 10.6 Here is a well built treated timber bridge with good streambank protection and adequate span to minimize stream channel impacts. The freeboard is marginally adequate.



Chapter 11

Slope Stabilization and Stability of Cuts and Fills

“Construct cut and fill slopes that are flat enough to be stable over time and that can be revegetated.”

THE OBJECTIVES OF ROUTINE ROAD CUTS AND FILLS are 1) to create space for the road template and driving surface; 2) to balance material between the cut and fill; 3) to remain stable over time; 4) to not be a source of sediment; and 5) to minimize long-term costs. Landslides and failed road cuts and fills can be a major source of sediment, they can close the road or require major repairs, and they can greatly increase road maintenance costs (*Photo 11.1*). Vertical cut slopes should not be used unless the cut is in rock or very well cemented soil. Long-term stable cut slopes in most soils and geographic areas are typically made with about a 1:1 or $\frac{3}{4}$:1 (horizontal: vertical) slope (*Photo 11.2*). Ideally, both cut and fill slopes should be constructed so that they can be vegetated (*Photo 11.3*), but cut slopes in dense, sterile soils or rocky material are often difficult to vegetate.

Fill slopes should be constructed with a 1 1/2:1 or flat-

ter slope. Over-steep fill slopes (steeper than a 1 1/2 :1 slope), commonly formed by side-casting loose fill material, may continue to ravel with time, are difficult to stabilize, and are subject to sliver fill failures (*Photo 11.4*). A rock fill can be stable with a 1 1/3:1 slope. Ideally, fills should be constructed with a 2:1 or flatter slope to promote growth of vegetation and slope stability (*Photo 11.5*). Terraces or



Photo 11.1 Over-steep slopes, wet areas, or existing slide areas can cause instability problems for a road and increase repair and maintenance costs, as well as sediment production.

Photo 11.2 Construct cut slopes at a 3/4:1 or flatter slope in most soils for long-term stability. In well-cemented soils and rock, a 1/4:1 cut clope will usually be stable.



Photo 11.3 A well-stabilized cut slope, with about a 1:1 slope, that is well covered with vegetation.



Photo 11.4 Avoid loose, over-steep fill slopes (steeper than 1 1/5:1), particularly along streams and at drainage crossings.



benches are desirable on large fill slopes to break up the flow of surface water.

Table 11.1 presents a range of commonly used cut and fill slope ratios appropriate for the soil and rock types described. Also Figure 11.1 and Figure 11.2 show typical cut slope and fill slope design options, respectively, for varying slope and site conditions. Note, however, that local conditions can vary greatly, so determination of stable slopes should be based upon local experience and judgment. Groundwater is the major cause of slope failures.

Slope failures, or landslides, typically occur where a slope is over-steep, where fill material is not compacted, or where cuts in natural soils encounter groundwater or zones of weak material. Good road location can often avoid landslide areas and reduce slope failures. When failures do occur, the slide area should be stabilized by removing the slide material, flattening the slope, adding drainage, or using structures, as discussed below. Figure 11.3 shows some of the common causes of slope failures along with common solutions. Designs are typically site specific and may require input from geotechnical engineers and engineering geologists. Failures that occur typically impact road operations and can be costly to repair. Failures near streams and channel crossings have an added risk of impact to water quality.

A wide range of slope stabilization measures is available to the engineer to solve slope stability



Photo 11.5 Construct fill slopes with a 1 1/2:1 or flatter slope (to promote vegetation growth) and stabilize the fill slope surface. Use benches (terraces) on large fill slopes to intercept any flow of surface water.

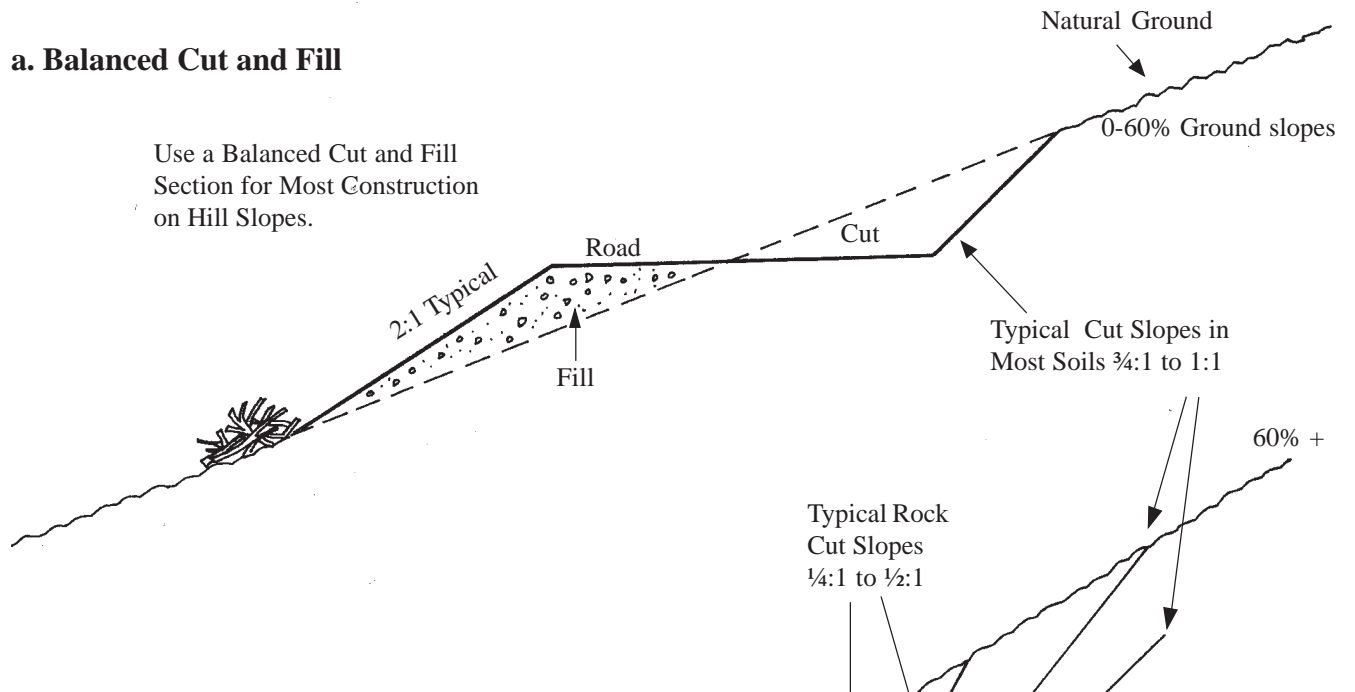
Table 11.1

**COMMON STABLE SLOPE RATIOS
FOR VARYING SOIL/ROCK CONDITIONS**

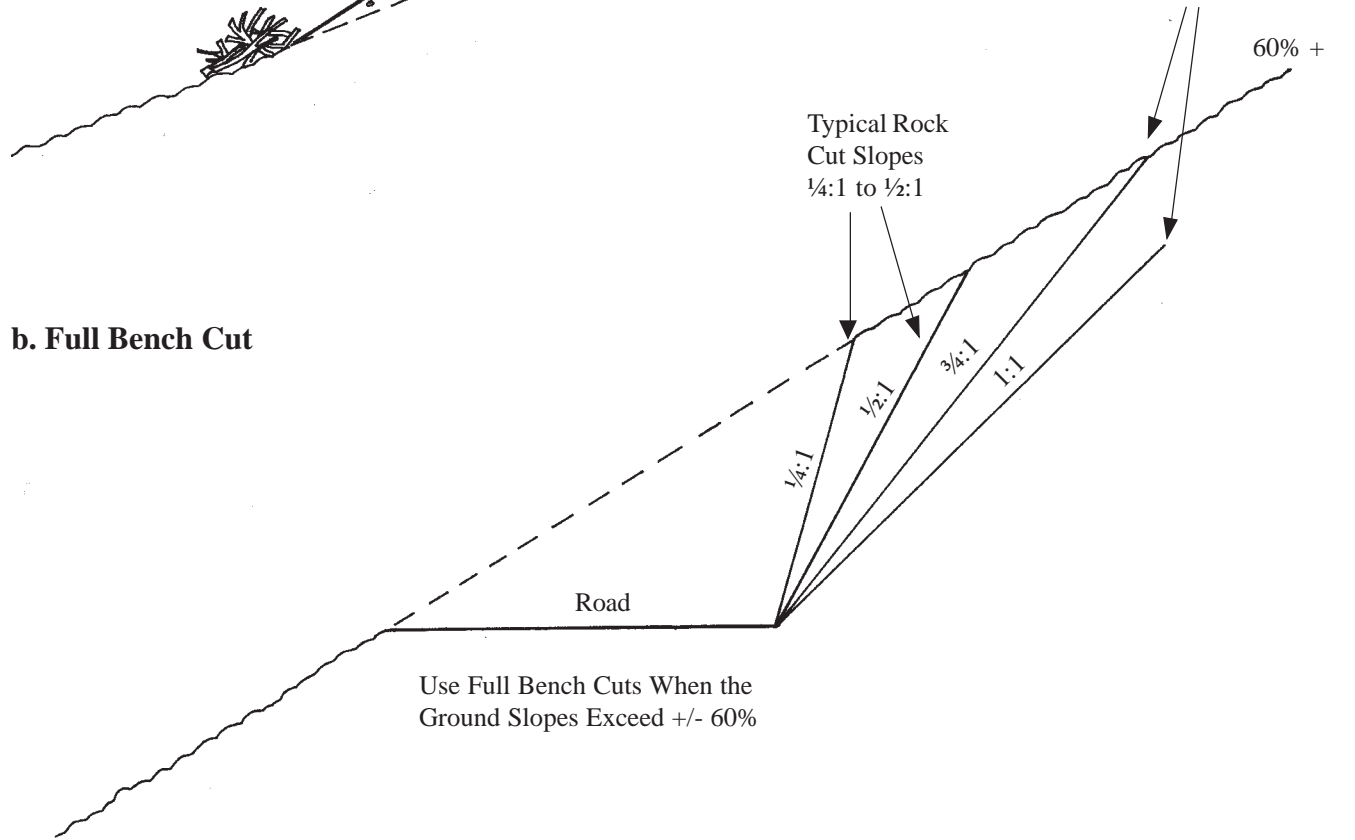
Soil/Rock Condition	Slope Ratio (Hor:Vert)
Most rock	¼:1 to ½:1
Very well cemented soils	¼:1 to ½:1
Most in-place soils	¾:1 to 1:1
Very fractured rock	1:1 to 1 ½:1
Loose coarse granular soils	1 ½:1
Heavy clay soils	2:1 to 3:1
Soft clay rich zones or wet seepage areas	2:1 to 3:1
Fills of most soils	1 ½:1 to 2:1
Fills of hard, angular rock	1 1/3:1
Low cuts and fills (<2-3 m. high)	2:1 or flatter (for revegetation)

Figure 11.1 Cut slope design options.

a. Balanced Cut and Fill



b. Full Bench Cut



c. Through Cut

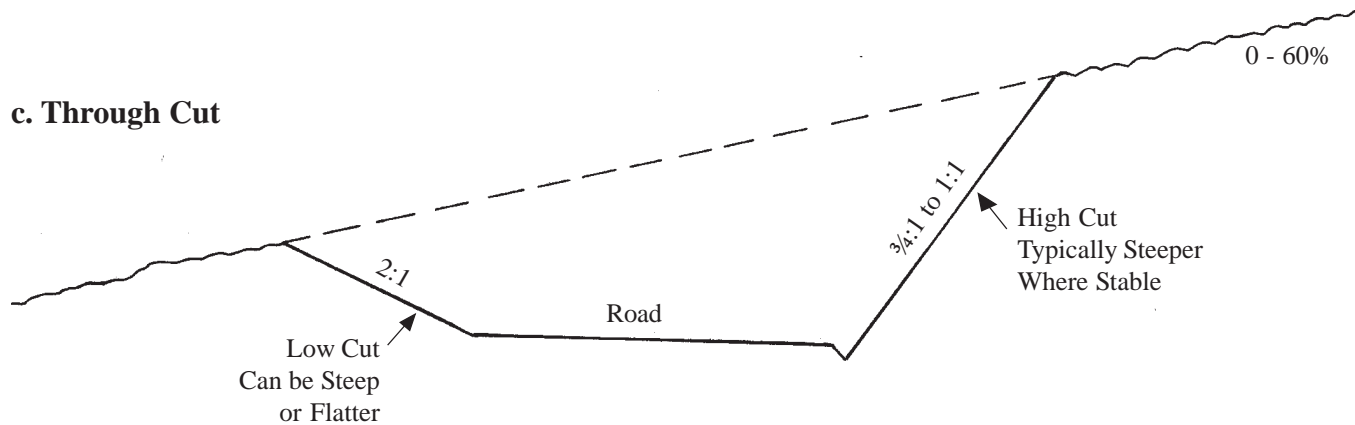
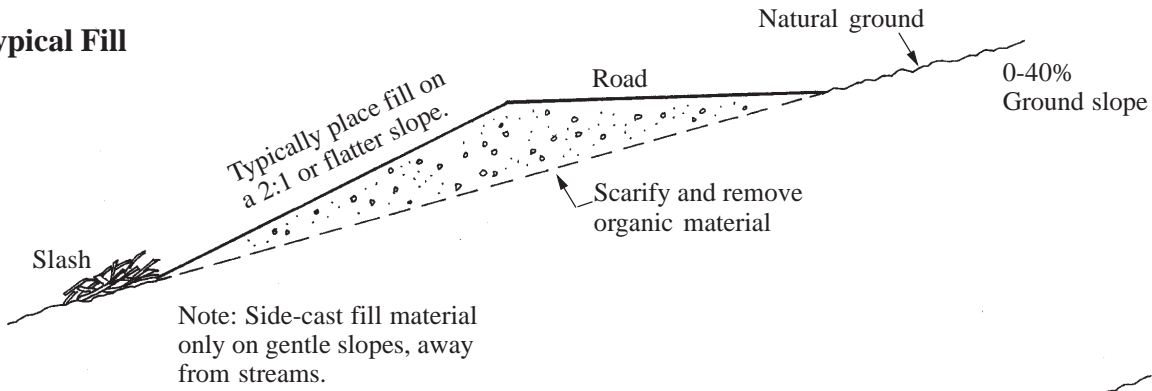
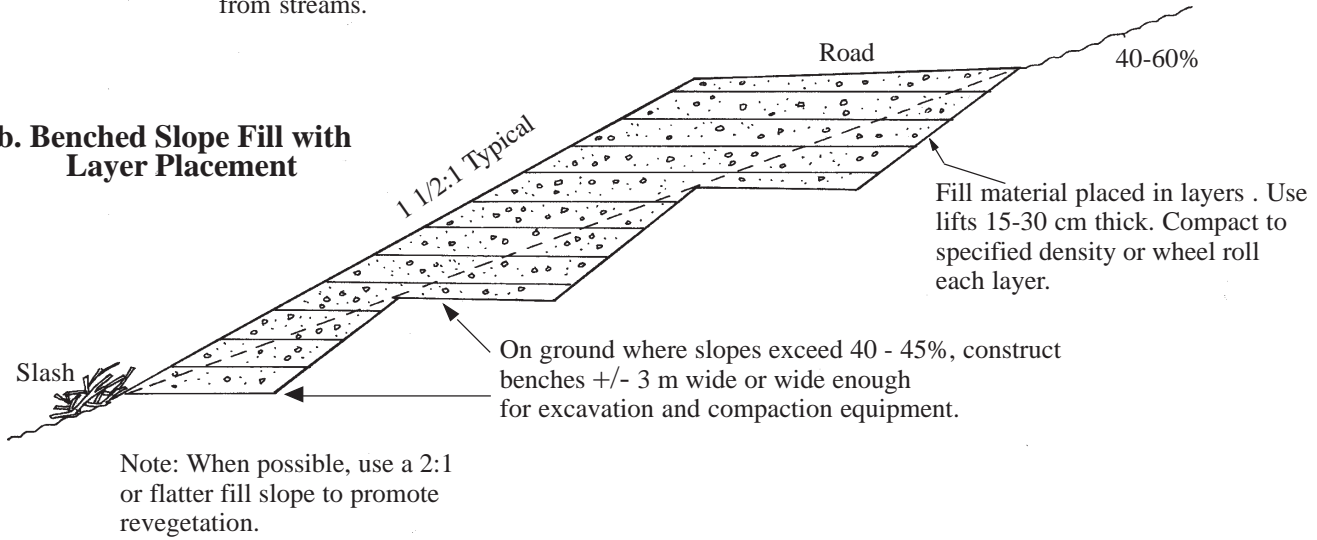


Figure 11.2 Fill slope design options

a. Typical Fill

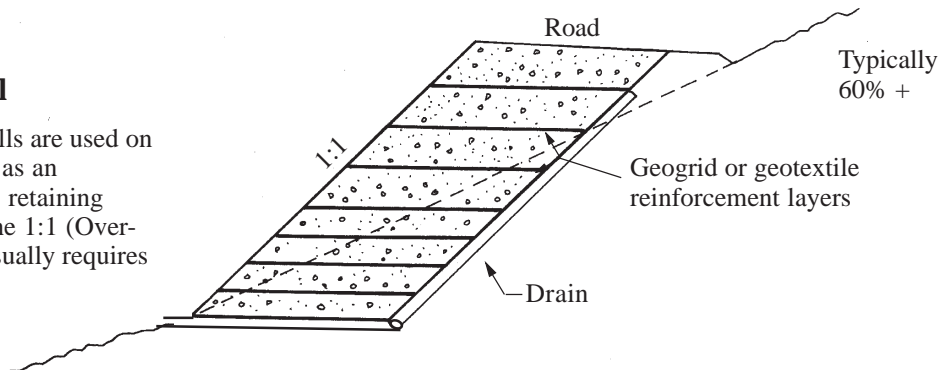


b. Benched Slope Fill with Layer Placement



c. Reinforced Fill

Reinforced fills are used on steep ground as an alternative to retaining structures. The 1:1 (Over-steep) face usually requires stabilization.



d. Through Fill

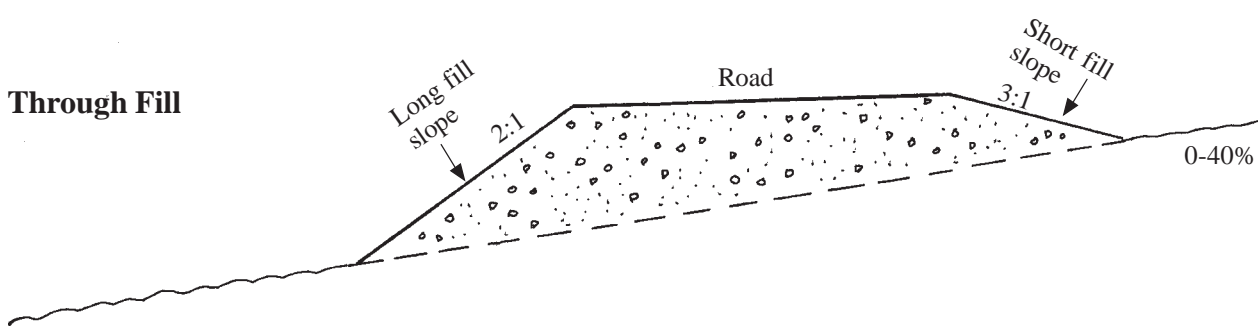
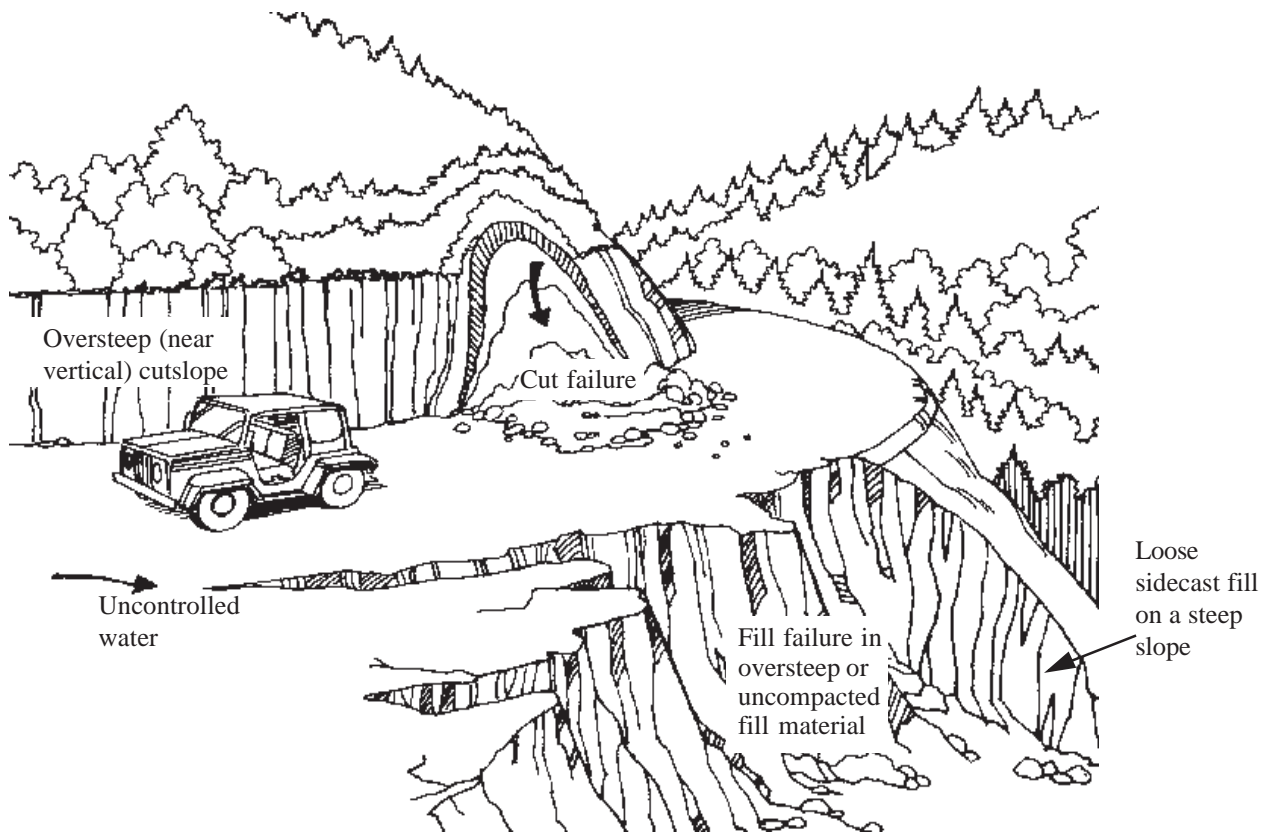


Figure 11.3 Slope problems and solutions with stabilization measures.

The Problem



Solutions

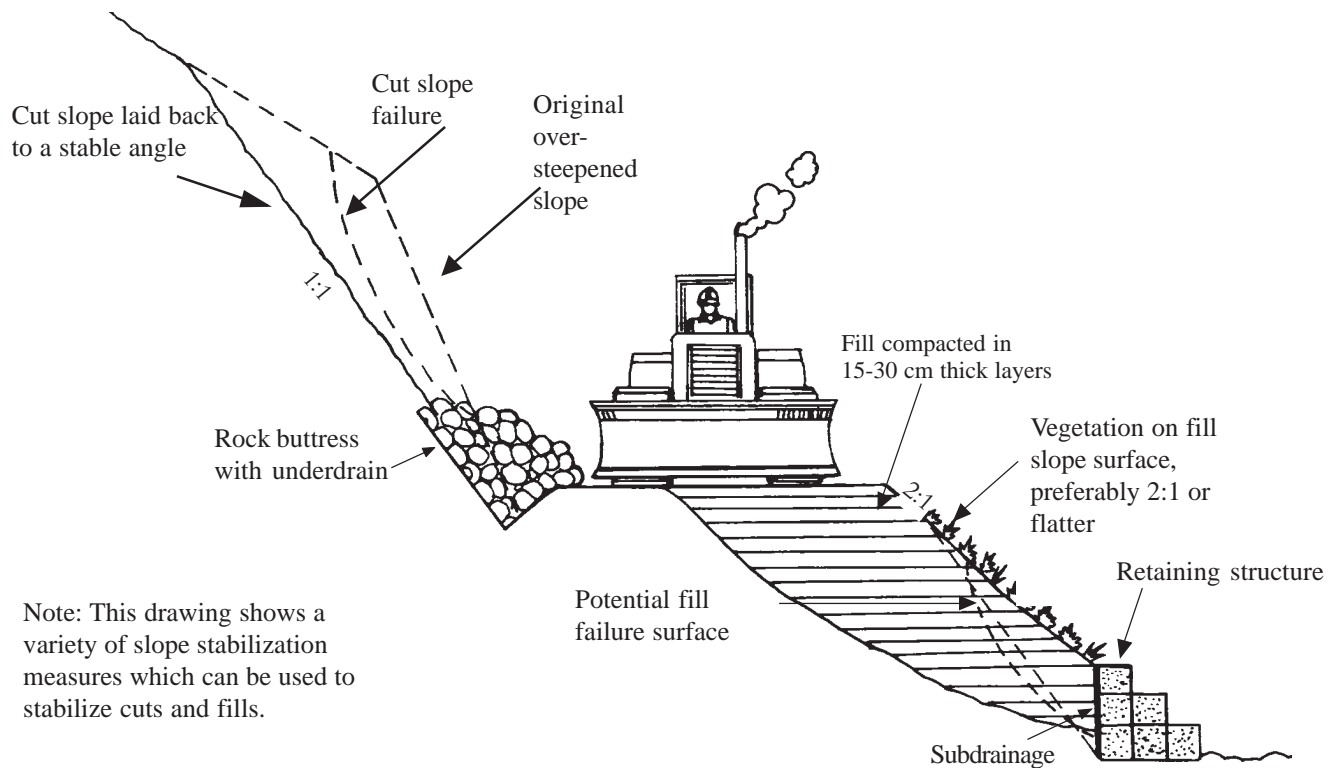




Photo 11.6 Simple hand compaction behind a low rock wall. Compaction is important behind any retaining structure or fill. It can be achieved by hand or, preferably, using equipment such as a wacker or small compactor.

problems and cross an unstable area. In most excavation and embankment work, relatively flat slopes, good compaction, and adding needed drainage will typically eliminate routine instability problems (*Photo 11.6*). Once a failure has occurred, the most appropriate stabilization measure will depend on site-specific conditions such as the size of the slide, soil type, road use, alignment constraints, and the cause of the failure. Here are a range of common slope stabilization options appropriate for low-volume roads, presented roughly from simplest and least expensive, to the most complex and expensive:

- Simply remove the slide material.
- Ramp over or align the road around the slide.
- Revegetate the slope and add spot stabilization (See *Photo 13.10*).
- Flatten or reconstruct the

slope.

- Raise or lower the road level to buttress the cut or remove weight from the slide, respectively.
- Relocate the road to a new stable location.
- Install slope drainage such as deep cutoff trenches or

dewater with horizontal drains.

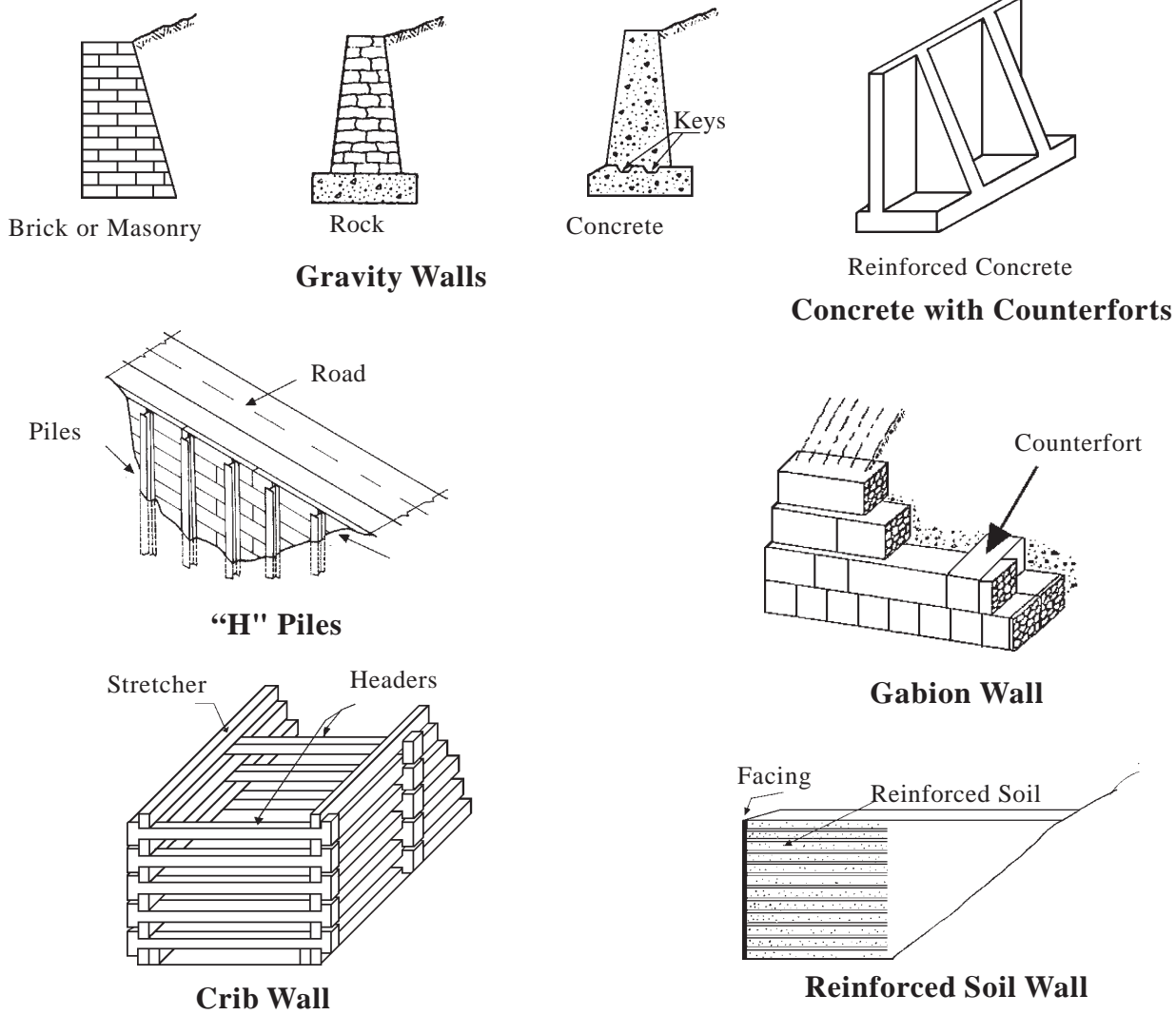
- Design and construct buttresses (*Photo 11.7*), retaining structures, or rock anchors.

Retaining structures are relatively expensive but necessary in steep areas to gain roadway space or to support the roadbed on a steep slope, rather than make a large cut into the hillside. They can also be used for slope stabilization. *Figure 11.4 (a and b)* presents information on common types of retaining walls and simple design criteria for rock walls, where the base width is commonly **0.7 times the wall height** (*Photo 11.8*). *Figure 11.4c* presents common gabion gravity wall designs and basket configurations for varying wall heights. Gabion structures are very commonly used for walls up to 6 meters high, particularly because they use locally available rock and are labor intensive (*Photo 11.9*).

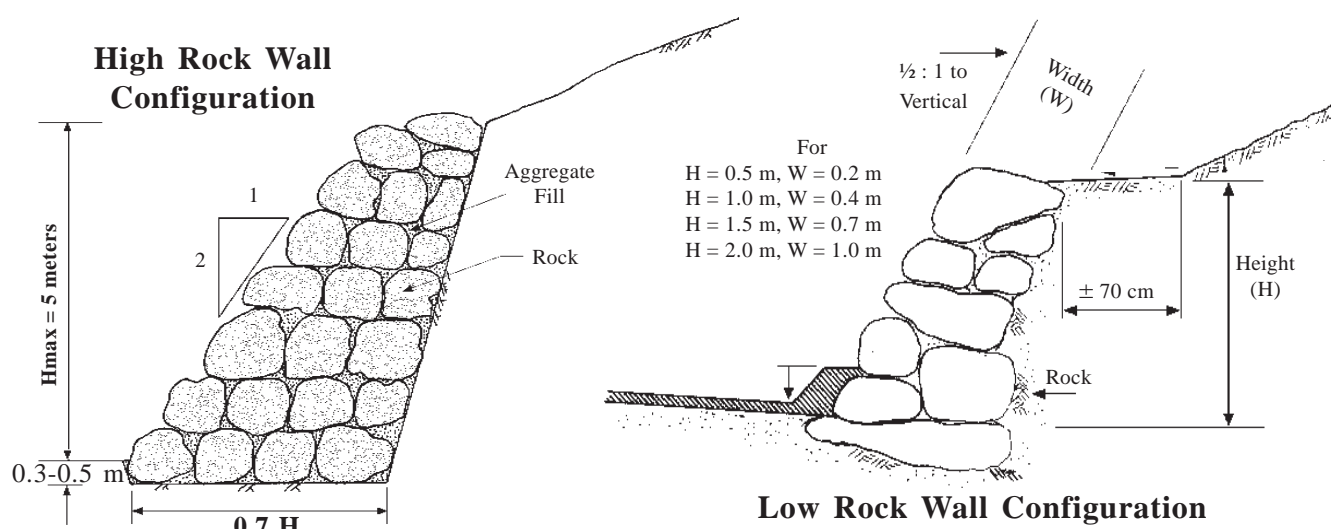


Photo 11.7 A drained rock buttress can be used to stabilize a cut slope failure area.

Figure 11.4 Construction of various types of retaining structures. (Adapted from Gray & Leiser, 1982)

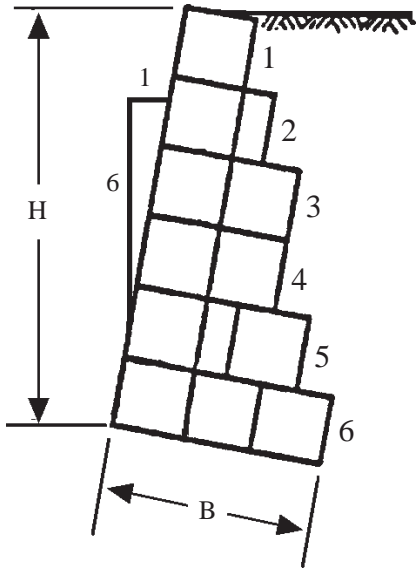


a. Common Types of Retaining Structures.



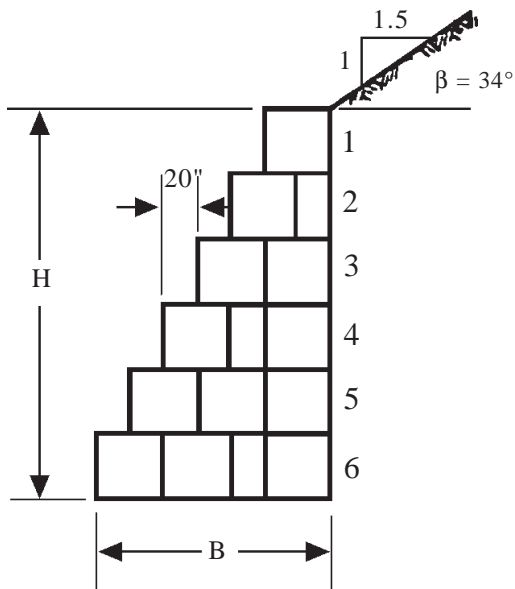
b. Typical Rock Wall Construction.

Figure 11.4 Continued. (Adapted from Gray & Leiser, 1982)



No. of levels	H	B	No. of gabions (per width)
1	3' 3"	3' 3"	1
2	6' 6"	4' 3"	1 1/2
3	9' 9"	5' 3"	2
4	13' 1"	6' 6"	2
5	16' 4"	8' 2"	2 1/2
6	19' 7"	9' 9"	3

Flat Backfill (smooth face)



No. of levels	H	B	No. of gabions (per width)
1	3' 3"	3' 3"	1
2	6' 6"	4' 11"	1 1/2
3	9' 9"	6' 6"	2
4	13' 1"	8' 2"	2 1/2
5	16' 4"	9' 9"	3
6	19' 7"	11' 5"	3 1/2

Fill at 1 1/2:1 (face with steps)

Note: Loading conditions are for silty sand to sand and gravel back fill. For finer or clay rich soils, earth pressure on the wall will increase and the wall base width (B) will have to increase for each height. Backfill weight = 110 pcf. (1.8 Tons/m³) (1,762 kg/m³)

- Safe against overturning for soils with a minimum bearing capacity of 2 Tons/foot² (19,500 kg/m²)
- For flat or sloping backfills, either a flat or stepped face may be used.

b. Standard design for Gabion Retaining Structures up to 20 feet in height (6 meters) with flat or sloping backfill.

For low to high walls in many geographic areas today, Mechanically Stabilized Earth (MSE), or “Reinforced Soil” structures are the least expensive type of wall available. They are simple to build, and often they can use on-site granular backfill material. They are commonly constructed using layers of geotextile or welded wire

placed in lifts 15 to 45 cm apart in the soil, thus adding tensile reinforcement to the soil (see *Figure 6.3e*). Driven “H” piles or sheet piles, with or without tie-backs, are relatively expensive but are often the most environmentally acceptable type of wall. They cause less site disturbance than gravity or MSE structures that re-

quire a large foundation excavation. Most types of retaining structures and designs provided by manufacturers are internally stable for the specified use, site conditions, and height. Most wall failures occur due to **foundation failure**. Thus structures **must** be placed on a good foundation, such as bedrock or firm, in-place soil.

PRACTICES TO AVOID

- Constructing vertical cut slopes (except in very well cemented soils and rock).
- Road locations and construction practices where the toe of the fill ends up in the creek. Do not use side-cast fill placement methods on steep slopes next to streams.
- Placing fills or “side-casting” materials on natural ground slopes steeper than 60%.
- Road locations in areas of known instability.
- Leaving cut slopes and, particularly, fill slopes barren and exposed to erosion.



Photo 11.8 Use physical slope stabilization methods, such as retaining walls, reinforced fills, or rock buttresses where necessary in areas of space limitation on steep slopes.



Photo 11.9 Gabions are a commonly used type of low gravity retaining structure because they use locally available rock and are relatively inexpensive.

RECOMMENDED PRACTICES

- Use balanced cut and fill construction in most terrain to minimize earthwork (*Figure 11.1a*).
- On steep ground (>60% slope) use full bench construction. Consider constructing a narrow, single lane road with inter-visible turnouts to minimize excavation (*Figure 11.1b*).
- Construct cut slopes in most soils using a cut slope ratio of 3/4:1 to 1:1 (horizontal: vertical) (*Figure 11.1*). Use flatter cut slopes in coarse granular and unconsolidated soils, in wet areas, and in soft or clay-rich soils. Use relatively flat cut slopes (2:1 or flatter) for low (<2-3 meters high) cuts to promote growth of vegetation.
- Construct cut slopes in rock using a cut slope ratio of 1/4:1 to 1/2:1 (*Figure 11.1*).
- Use vertical cuts (1/4:1 or steeper) only in stable rock or in very well cemented soils, such as cemented volcanic ash or in-place decomposed granite soil, where the risk of surface erosion or continued ravel from a relatively flat cut slope is great and the risk of local failures in the steep cut is low.
- Where long-term examples are available, use local experience, as well as ideally materials testing and analysis, to determine the stable cut slope angle in a particular soil type.
- Direct concentrated surface water (runoff) away from cut and fill slopes.
- Place construction slash and rocks along the toe of fill slopes (See Road Design, *Figure 4.2*) (Do not bury the slash in the fill!).
- Dispose of unsuitable or excess excavation material in locations that will not cause water quality degradation or other resource damage.
- Construct fills with a fill slope ratio of 1 1/2:1 or flatter. In most soils, a 2:1 or flatter fill slope ratio will promote vegetative growth (*Figure 11.2a*). For clay-rich tropical soils in high rainfall areas, a 3:1 fill slope is desirable.
- Compact fill slopes in sensitive areas or when the fill is constructed with erosive or weak soils. Use specific compaction procedures, such as wheel rolling, layer placement of the fill (with 15 to 30 cm lifts), or use specific compaction equipment when available (*Figure 11.2b*).
- Remove organic surface material, construct a toe bench, and bench the natural ground surface on slopes of 40-60% before the fill is placed over the native soil (*Figure 11.2b*) to prevent a “sliver fill” failure at the contact of the native soil and fill. Once a fill failure occurs on a steep slope, a retaining structure or reinforced fill is typically needed for repairs (*Photo 11.10*).
- Consider the use of reinforced fills where a 1:1 fill slope will fit (catch) on natural, stable ground (see *Figure 11.2c*). Use reinforced fills as a cost saving alternative to retaining structures.
- Use physical and bio-technical slope stabilization measures such as retaining structures, buttresses, brush layering, and drainage, as needed to achieve stable slopes (see *Figure 11.3* and *Figure 13.4*). Retaining structures may be loose rock, gabions, reinforced concrete, piles, crib walls, soil nails, or mechanically stabilized soil walls with a variety of facings such as geotextile, welded wire, timber, concrete blocks, or tires

RECOMMENDED PRACTICES (continued)

(Photo 11.11). Wall back-fill is typically compacted to 95% of the AASHTO T-99 maximum density.

- Use retaining structures to gain roadway width in steep terrain.
- Place retaining structures only upon good foundation materials, such as bedrock or firm, in-place soils (Photo 11.12).

Photo 11.11 A tire-faced, mechanically stabilized earth (MSE) retaining wall, with layers of geotextile reinforcement, being used to gain road width in a fill failure area. MSE (reinforced soil) structures are often the least expensive retaining structure available. Welded wire MSE walls are also commonly used.

Photo 11.12 A gabion retaining structure which will fail soon due to lack of a suitable foundation. All retaining structures, either mechanically stabilized earth (MSE) walls or gravity walls, require a **good foundation**.



Photo 11.10 A road fill failure in steep terrain which now needs either a retaining structure or a large road cut around the failure.



Chapter 12

Roadway Materials and Material Sources

“Select quality roadway materials that are durable, well-graded, and perform well on the road. Maintain quality control.”

LOW-VOLUME ROAD surfaces and structural sections are typically built from native materials that must support light vehicles and may have to support heavy commercial truck traffic. In addition, low-volume roads should have a surface that, when wet, will not rut and will provide adequate traction for vehicles. The surface of native soil roads is also an exposed area that can produce significant amounts of sediment, especially if rutted (*Photo 12.1*).

Roadway Materials

It is usually desirable and, in many cases, necessary to add subgrade structural support or to improve the roadbed native soil surface with materials such as gravel, coarse rocky soil, crushed aggregate, cobblestone, concrete block, or some type of bituminous seal coat or asphalt pavement, as shown in *Figure 12.1*. Surfacing improves the structural support and reduces road surface erosion. The selection of surfacing type depends upon the traffic volume, local soils,

available materials, ease of maintenance, and, ultimately, cost.

A range of options exists for improving the structural capacity of the roadway in areas of soft soils or poor subgrades. These commonly include:

- Adding material of higher strength and quality over the soft soil, such as a layer of gravel or



Photo 12.1 A rutting road caused either by soft subgrade soil or inadequate road drainage (or both).

Figure 12.1 Commonly used low-volume road surfacing types and structural sections.

a. Native Soil



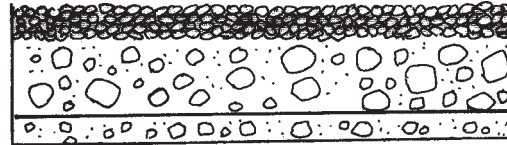
— Native (In-Place) Soil

b. Aggregate



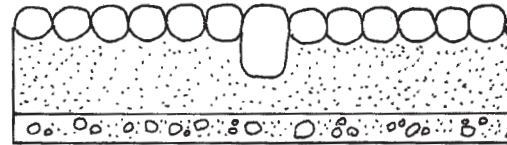
— Crushed Surface Aggregate or Gravel
— Native Soil

c. Aggregate and Base



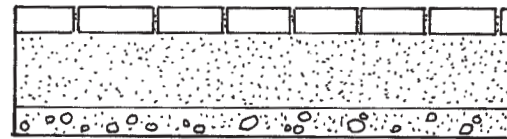
— Crushed Surface Aggregate or Gravel
— Aggregate Base
— Native Soil

d. Cobblestone



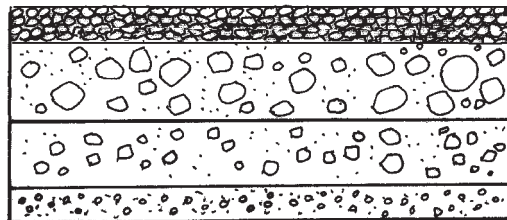
— Cobblestones
— Sand
— Native Soil

e. Concrete Block



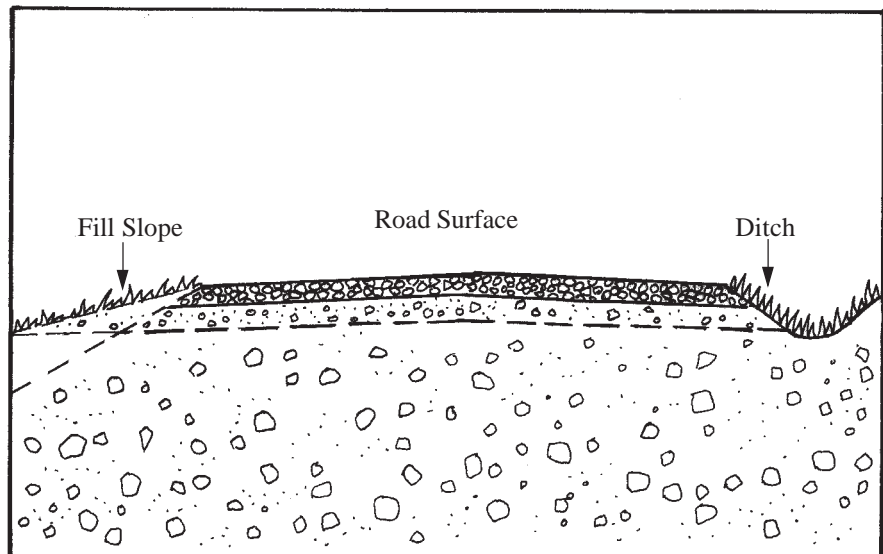
— Concrete Blocks
— Sand
— Native Soil

f. Asphalt Surfacing



— Asphalt Pavement
— Aggregate Base
— Aggregate Sub-Base (Optional)
— Native Soil

g. Typical Aggregate Surfaced Road Template



crushed aggregate;

- Improving the soft soil in place (in-situ) by mixing it with stabilization additives such as lime, cement, asphalt, or chemicals;
- Bridging over the soft soil with materials such as geotextiles or wood pieces (corduroy);
- Removing the soft or poor soil and replacing it with a high quality soil or rocky material;
- Limiting the use of the road during periods of wet weather when clay soils are soft;
- Compacting the native soil to increase its density and strength; and
- Keeping moisture out of the soil with effective roadway drainage or encapsulating the soil to keep water out.

Various soil stabilization materials such as oils, lime, cements, resins, lignin, chlorides, enzymes, and chemicals may be used to improve the material properties of the in-place soil. They may be very cost-effective in areas where aggregate or other materials are difficult to locate or are expensive. The best soil stabilization material to use depends on cost, soil type, performance and local experience. Test sections are often needed to determine the most desirable and cost-effective product. However, many soil stabilizers still



Photo 12.2 Stabilize the roadway surface with crushed rock (or other surfacing) on steep grades, in areas of soft soil, or in erosive soils.

need some type of wearing surface. A stabilized road surface improves traction and offers erosion protection as well as structural support.

Gravel, pit run rock, select material, or crushed aggregate are the most common improved surfacing materials used on low-volume roads (*Photo 12.2*). Aggregate is sometimes used only as “fill” material in ruts. However, it is more desirable to place it as a full structural section, as shown in *Figure 12.2*. The roadway surfacing aggregate must perform two basic functions. It must have high enough quality and be thick enough to provide structural support to the traffic and prevent rutting, and it must be well graded and mixed with sufficient fines, preferably with some plasticity, to prevent raveling and washboarding.

Necessary aggregate thickness typically ranges from 10 to

30 cm, depending on soil strength, traffic, and climate. Specific aggregate thickness design procedures are found in the Selected References. Over very weak soils (CBR less than 3), aggregate thickness can be reduced with the use of geotextile or geogrid subgrade reinforcement. Also, geotextile layers are useful over soft soils to separate the aggregate from the soil, keep it uncontaminated, and extend the useful life of the aggregate.

Figure 12.3 presents some of the physical properties and tradeoffs of various soil-aggregate mixtures, first with no fines (no material passing the #200 sieve, or .074 mm size), second with an ideal percentage of fines (6-15%), and finally with excessive fines (over 15 to 30%). *Figure 12.4* shows the typical gradation ranges of aggregates used in road construction, how the materials, ranging from coarse to fine, best perform for a road, and the approxi-

Figure 12.2 Aggregate options to prevent rutting.

POOR



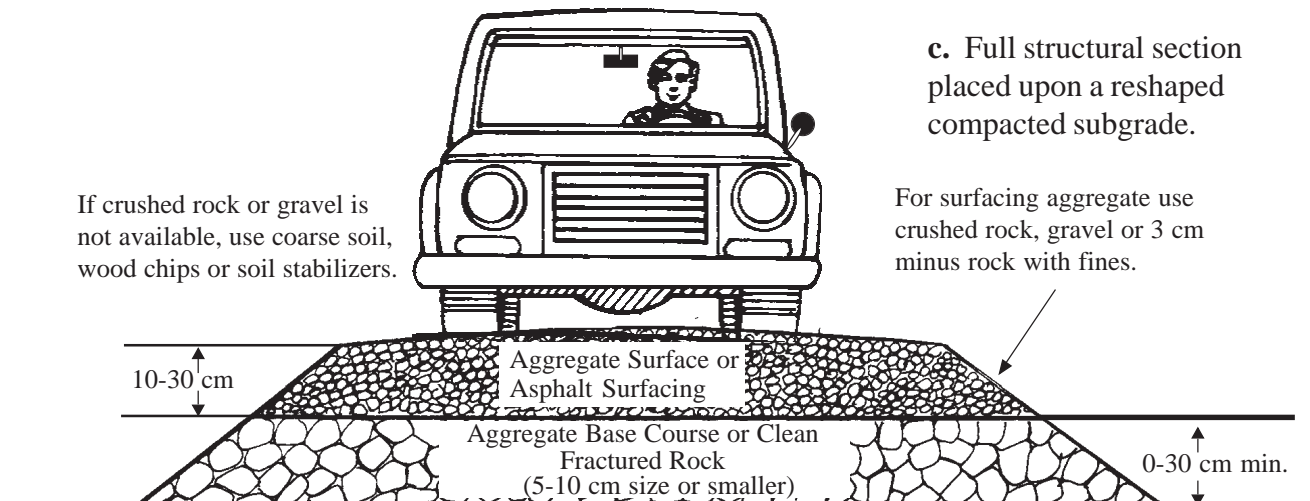
a. Minimal aggregate filled into ruts when they develop.

MEDIOCRE-ADEQUATE



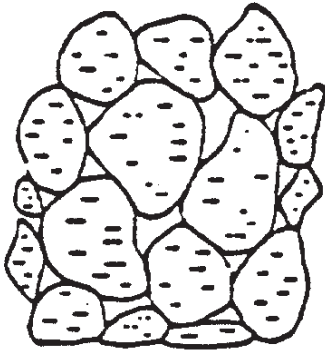
b. Ruts filled plus addition of 10-15 cm-thick layer of aggregate.

BEST



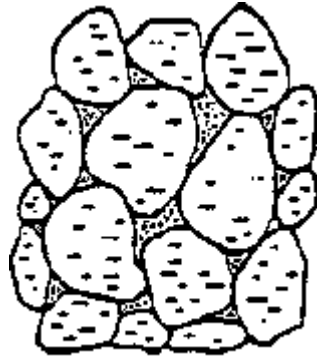
c. Full structural section placed upon a reshaped compacted subgrade.

Figure 12.3 Physical states of soil-aggregate mixtures. (Adapted from Yoder and Witczak, 1975)



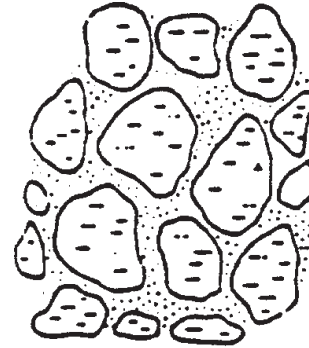
Aggregate with no Fines

- Grain-to-grain contact
- Variable density
- High Permeability
- Non-Frost Susceptible
- High stability when confined, low if unconfined
- Not affected by water
- Difficult to compact
- Ravels easily



Aggregate with Sufficient Fines for Maximum Density

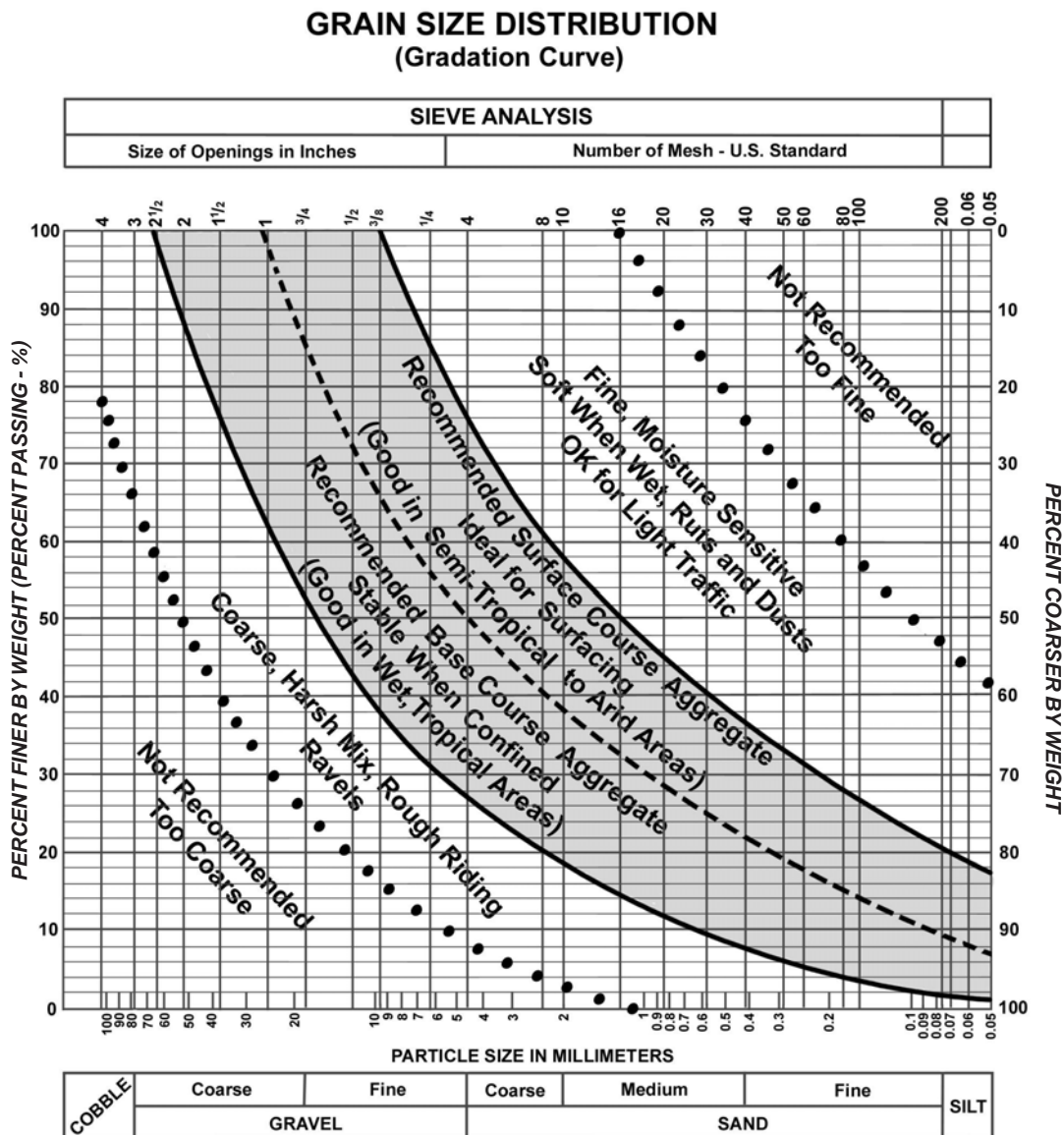
- Grain-to-grain contact with increased resistance against deformation
- Increased to maximum density
- Low permeability
- Frost susceptible
- Relatively high stability in confined or unconfined conditions
- Not greatly affected by adverse water conditions
- Moderately easy to compact
- Good road performance



Aggregate with High Amount of Fines (>30 percent)

- Grain-to-grain contact destroyed, aggregate is "floating" in soil
- Decreased density
- Low permeability
- Frost susceptible
- Low stability and low strength
- Greatly affected by water
- Easy to compact
- Dusts easily

Figure 12.4 Gradation ranges of roadway surfacing materials and their performance characteristics. (Adapted from R. Charles, 1997 and the Association of Asphalt Paving Technologists)



NOTE: Gradation Ranges Shown Are Approximate.

The best roadbed surfacing materials have some plasticity and are well graded. They have gradations parallel to the curves shown above, and are closest to the “Ideal” dashed curve in the middle of the gradation ranges shown.

PRACTICES TO AVOID

- Construction operations or heavy traffic during wet or rainy periods on roads with clay rich or fine-grained soil surfaces that form ruts.
 - Allowing ruts and potholes to form over 5 to 10 cm deep in
- the roadway surface.
 - Road surface stabilization using coarse rock larger than about 7.5 cm. Coarse rock is difficult to drive upon or keep stabilized on the road surface, and it damages tires.
- Using surfacing materials that are fine grain soils, soft rock that will degrade to fine sediment, or clean, poorly graded coarse rock that will erode, ravel, or washboard.

mate limitations to the desirable gradation ranges. Note that the desirable percentage of fines in an aggregate can be sensitive to the climate or road environment. In semi arid to desert regions, a relatively high percentage of fines, such as 15 to 20%, with moder-

ate plasticity, is desirable. In a high rainfall “wet” environment, such as tropical, coastal mountain, or jungle areas, a low percentage, such as 5 to 10% fines, is desirable to prevent rutting and maintain a stable road surface.

Ideally, aggregate surfacing material is (1) hard, durable, and crushed or screened to a minus 5 cm size; (2) well graded to achieve maximum density; (3) contains 5-15% clayey binder to prevent raveling; and (4) has a Plasticity Index of 2 to 10. The

RECOMMENDED PRACTICES

- Stabilize the roadway surface on roads that form ruts or ravel excessively. Common surface stabilization techniques include using 10-15 cm of crushed aggregate; local pit run or grid roll rocky material (*Photo 12.4*); cobblestone surfacing; wood chips or fine logging slash; or soils mixed and stabilized with cement, asphalt, lime, lignin, chlorides, chemicals, or enzymes.
- For heavy traffic on soft subgrade soils, use a single, thick structural section consisting of at least 20-30 cm of surfacing aggregate. Alternatively, use a structural section consisting of a 10-30 cm thick layer of base aggregate or coarse fractured rock, capped with a 10-15 cm thick layer of surfacing aggregate (*Figure 12.2-BEST*). Note that soft clay-rich tropical soils and heavy tire loads may require a thicker structural section. The structural depth needed is a function of the traffic volume, loads and soil type, and should ideally be determined through local experience or testing, such as using the CBR (California Bearing Ratio) test.
- Maintain a 3-5% road cross-slope with insloping, outsloping, or a crown to rapidly move water off the road surface (see *Figure 7.1*).
- Grade or maintain the roadway surface before significant potholes, washboarding, or ruts form (see *Figure 4.5*).
- Compact the embankment material, road surface material or aggregate during construction and maintenance to achieve a dense, smooth road surface and thus reduce the amount of water that can soak into the road (*Photo 12.5*).
- “Spot” stabilize local wet areas and soft areas with 10-15 cm of coarse rocky material. Add more rock as needed (*Figure 12.2*).
- Stabilize the road surface in sensitive areas near streams and at drainage crossings to minimize road surface erosion.
- Control excessive road dust with water, oils, wood chips, or use of other dust palliatives.
- Blend coarse aggregate and fine clay-rich soil (when available) to produce a desirable composite roadway material that is coarse yet well-graded with 5-15 % fines for binder (see *Figures 12.3* and *12.4*).
- Use project construction quality control, through visual observation and materials sampling and testing, to achieve specified densities and quality, well-graded road materials (*Photo 12.6*).
- On higher standard, high traffic volume roads (collectors, principals, or arterials) use appropriate, cost effective surfacing materials such as oils, cobblestone, paving blocks (*Photo 12.7*), bituminous surface treatments (chip seals) (*Photo 12.8*), and asphalt concrete pavements.

Photo 12.3 A road in need of maintenance and surfacing. Add roadway surface stabilization or do maintenance with grading and shaping of the surface to remove ruts and potholes before significant road damage occurs, to achieve good road surface drainage, and to define the roadbed.



Photo 12.4 A grid roller can be used to produce a desirable surfacing material when the coarse rock is relatively soft. Level and compact the roadway surface aggregate to achieve a dense, smooth, well-drained riding surface.



Photo 12.5 Compaction of soil and aggregate is typically the least expensive way to improve the strength and performance of the material. Compaction is useful and cost-effective both for the stability of fill embankments and for the road surface.





Photo 12.6 Here, a “nuclear gauge” is being used to check the density of aggregate. Use project construction quality control, gradation and density testing, etc., as needed to achieve the desirable materials properties for the project.



Photo 12.7 Concrete blocks (Adoquin) or cobblestone offer an intermediate alternative to aggregate and pavement road surfacing. These materials are labor intensive to construct and maintain, but are very cost-effective in many areas.



Photo 12.8 A chip seal road surface being compacted. A variety of surfacing materials can be used, depending on availability, cost, and performance.

surfacing applied to the road must be maintainable in order to prevent rutting and erosion. Significant deterioration of the road can occur if ruts, raveling, washboarding, or surface erosion are not controlled (*Photo 12.3*). Road damage can be greatly reduced by restricting road use during wet conditions if road management allows for this option.

Compaction is usually the most cost-effective method to improve the quality, including strength and water resistance, of subgrade soils and to improve the performance of aggregate surfacing. It increases the density and reduces the void spaces in the material, making it less susceptible to moisture. Thus, compaction is useful to protect the investment in road aggregate, maximize its strength, minimize loss of fines, and prevent raveling. Road performance has been excellent in some semi-arid regions with the use of blended local materials, very high compaction standards, and a waterproof membrane such as a bituminous seal coat.

Compaction can best be achieved with a minimum of effort if the soil or aggregate is well graded and if it is moist. Ideally, it should be close to the “optimum moisture content” as determined by tests such as the “Proctor” Moisture-Density Tests. Expansive soils should be compacted on the wet side of optimum. Hand tamping can be effective, but only when done in thin lifts (2-8 cm) and ideally at a moisture content a few percent above optimum.

The best compaction equipment for granular soils and aggregate is a vibratory roller. A tamping, or sheepfoot roller is most effective on clay soils. A smooth drum, steel wheel roller is ideal for compaction of the roadway surface. Vibratory plates or rammers, such as “wackers”, are ideal in confined spaces. No one piece of equipment is ideal for all soils, but the best all-purpose equipment for earthwork in most mixed soils is a pneumatic tire roller that produces good compaction in a wide range of soil types, from aggregates to cohesive silty soils.

Materials Sources

The use of local materials sources, such as borrow pits and quarries, can produce major cost savings for a project compared to the cost of hauling materials from distant, often commercial, sources. However, the quarry or borrow pit material quality must be adequate. Sources may be nearby rock outcrops or granular deposits adjacent to the road or within the roadway. Road widening or lowering road grade in fractured, rocky areas may produce good construction materials in an area already impacted by construction. Rock excavation and production may be by hand (*Photo 12.9*), or with the use of various types of equipment, such as screens and crushers. Relatively low-cost, on-site materials can result in the application of considerably more roadway surfacing and more slope protection with rock since the materials are readily available and inexpensive. However, poor quality materials will require more road maintenance

and may have poor performance.

Borrow pits and quarries can have major adverse impacts, including sediment from a large denuded area, a change in land use, impacts on wildlife, safety problems, and visual impacts. Thus quarry site planning, location, and development should usually be done in conjunction with Environmental Analysis to determine the suitability of the site and constraints. A **Pit Development Plan** should be required for any quarry or pit development to define and control the use of the site and the materials being extracted. A pit development plan typically defines the location of the materials deposit, the working equipment, stockpile and extraction areas (*Photo 12.10*), access roads, property boundaries, water sources, and final shape of the pit and back slopes. Materials source extraction can cause long-term land use changes, so good site analysis is needed.

In-channel gravel deposits or stream terrace deposits are often used as materials sources. Ideally, deposits in or near streams or rivers should **not** be used. Gravel extraction in active stream channels can cause significant damage to the stream, both on-site and downstream (or upstream) of the site. However, it may be reasonable to remove some materials from the channel with adequate study of the fluvial system and care in the operation. Some gravel bar or terrace deposits may be appropriate for a materials source, particularly if taken from above the active river channel. Equip-



Photo 12.9 Develop quarries and borrow sites (materials sources) close to the project area whenever possible. Either hand labor or equipment may be appropriate, depending on the site conditions and production rates.



Photo 12.10 Quarries and borrow sites (materials sources) can provide an excellent, relatively inexpensive source of project materials. A site may require simple excavation, screening, or crushing to produce the desired materials. Control use of the area with a Pit Development Plan.

ment should not work in the water.

Site reclamation is typically needed after materials extraction, and reclamation should be an integral part of site development and included in the materials cost. Reclamation work should be defined in a **Pit Reclamation Plan**. Reclamation can include conserving and reapplying topsoil, reshaping the pit, revegetation, drainage, erosion control, and safety measures. Often, interim site use, clo-

sure, and future reuse must also be addressed. A site may be used for many years but be closed between projects, so interim reclamation may be needed. Roadside borrow areas are commonly used as close, inexpensive sources of material (*Photo 12.11*). These areas ideally should be located out of sight of the road, and they too need reclamation work after use.

The quality of the local material may be variable or marginal, and the use of local material of-

ten requires extra processing or quality control. Low quality material may be produced at a cost much lower than commercially available material, but may not perform well. Zones of good and bad material may have to be separated. The use of local materials, however, can be very desirable and cost-effective when available and suitable.

RECOMMENDED PRACTICES

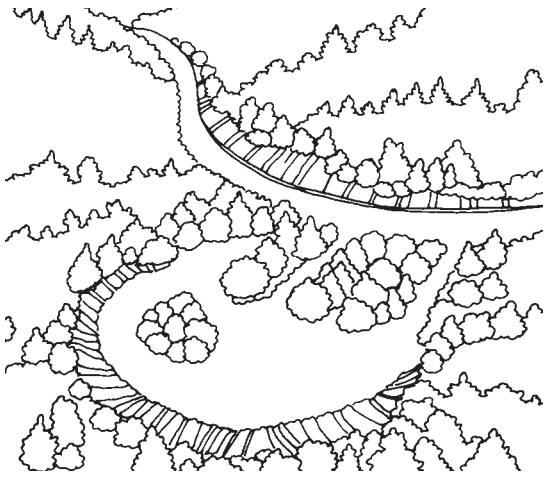
- Develop local borrow pits, quarries and pit-run material sources wherever practical in a project area. Ensure that Environmental Analysis has been done for the establishment of new materials sources.
- Use a **Pit Development Plan** to define and control the use of local materials. A Pit Development Plan should include the location of the site, extent of development, excavation, stockpiling and working areas, shape of the pit, volume of useable material, site limitations, a plan view, cross-sections of the area, and so on. A plan should also address interim or temporary closures and future operations.
- Develop a **Pit Reclamation Plan** in conjunction with pit planning to return the area to other long-term productive uses. A Pit Reclamation Plan should include information such as topsoil conservation and reapplication, final slopes and shaping, drainage needs, safety measures, revegetation, and erosion control measures (*Photo 12.12*).
- Reshape, revegetate and control erosion in roadside borrow areas to minimize their visual and environmental impacts (*Figure 12.5*). Locate materials sources either within the roadway or out of view of the road.
- Maintain project quality control with materials testing to guarantee the production of suitable quality material from quarry and borrow pit sources.

PRACTICES TO AVOID

- In-stream channel gravel extraction operations and working with equipment in the stream.
- Developing materials sources without planning and implementing reclamation measures.
- Using low quality, questionable, or unproven materials without adequate investigation and testing.

Figure 12.5 Good and bad roadside quarry development practices. (Adapted from *Visual Quality Best Management Practices for Forest Management in Minnesota, 1996*)

Good Practices for Quarry Development



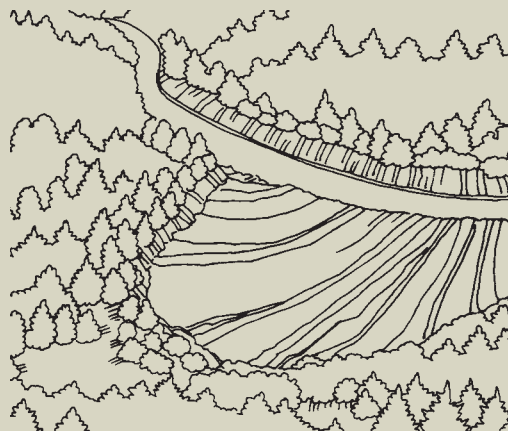
DO!

- Screen pit area from road
- Leave gentle slopes
- Reshape and smooth the area
- Leave pockets of vegetation
- Seed and mulch the area
- Use drainage control measures
- Replace Topsoil

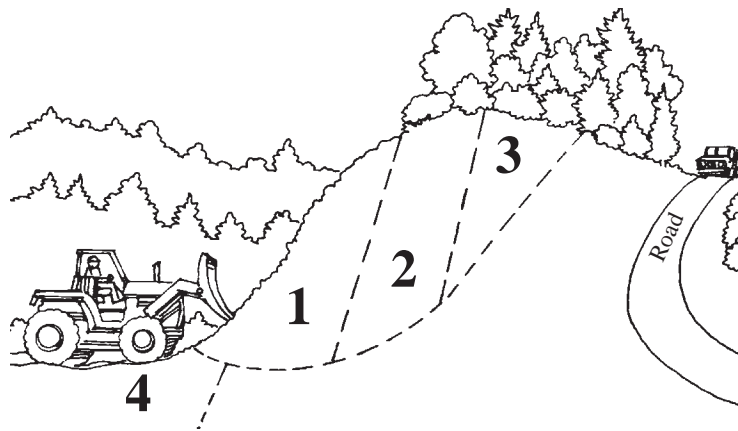
Poor Practices for Quarry Development

DO NOT!

- Expose large, open area
- Leave area barren
- Leave steep or vertical slopes



Ideal Location and Sequence of Excavation



Locate borrow areas out of sight of the road.

(NOTE: Safe backslope excavation height depends on soil type. Keep backslopes low, sloped or terraced for safety purposes.)



Photo 12.11 This roadside borrow area lacks drainage and erosion control. Roadside quarry development can be inexpensive and useful, but the areas should be hidden if possible, and the areas should be reclaimed once the project is completed.



Photo 12.12 A reclaimed and revegetated borrow site. Reshape, drain, plant vegetation, and rehabilitate borrow pits and quarries once the usable materials are removed and use of the area is completed.

Chapter 13

Erosion Control

“Erosion control -- one of the best, most inexpensive ways to protect the road and the environment. Just do it!”

EROSION CONTROL on roads is fundamental for the protection of water quality (*Photo 13.1*). Soil stabilization and erosion control practices are needed and should be used in areas where soil is exposed and natural vegetation is inadequate. Bare ground should be covered, typically with grass seed and some form of matting or mulch. This will help prevent erosion and subsequent movement of sediment into streams, lakes and wetlands. This movement of sediment can occur during and after road construction, after road maintenance, during logging or mining activities, as the road is being used, if a road is closed but not stabilized, or from poor land management practices near the road (*Photo 13.2*). Roughly half of the erosion from a logging operation, for instance, comes from the associated roads. Also, most erosion occurs during the first rainy season after construction.

Erosion control measures need to be implemented immediately following construc-

tion and every time an area is disturbed. Soil erosion prediction models such as the Water Erosion Prediction Project (WEPP) or Unified Soil Loss Equation (USLE) can be used to quantify erosion and compare the effectiveness of various erosion control measures. Concentrated water flow can begin as minor sheet flow, produce rills, and eventually result in major gully formation (See Chapter 14).



Photo 13.1 Do not leave disturbed or barren areas exposed to raindrops and runoff. Use erosion control measures to protect the area and protect water quality.



Photo 13.2 Erosion on a slope adjacent to a highway due to lack of vegetation or poor land use practices. Note that vegetation is preventing erosion next to the highway.

Erosion control practices include surface armoring and ground cover with netting (*Photo 13.3*), vegetative material or slash (*Photo 13.4*), rock, and so on; installing water and sediment control structures; and mulching, seeding, and various forms of revegetation, as seen in *Figures 13.1* through *Figure 13.4*. Effective erosion control requires attention to detail, and installation work requires inspection and quality control.

Physical methods include such measures as armored ditches (*Photo 13.5*), berms, wood chips, ground cover mats, and silt or sediment fences (*Photo 13.6*). These control or direct the flow of water, protect the ground surface against erosion, or modify the soil surface to make it more resistant to erosion (*Photo 13.7*).

Vegetative methods, using grasses, brush, and trees, offer

ground cover, root strength, and soil protection with inexpensive and aesthetic “natural” vegetation, as well as help control water and promote infiltration (*Photo 13.8*). Ideally, vegetation should be selected for good growth properties, hardiness, dense ground cover, and deep roots for slope

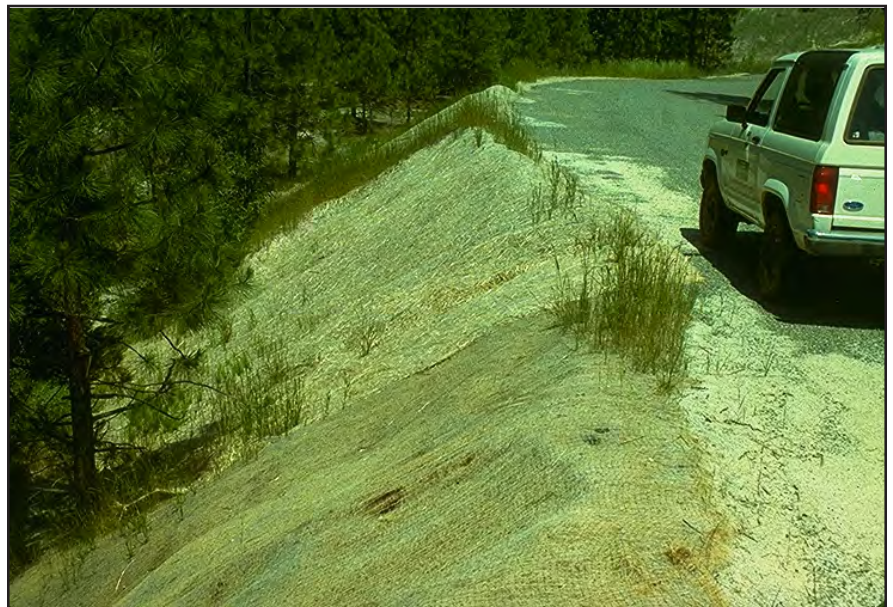


Photo 13.3 Cover fill slopes, work areas, and other exposed soil areas with straw, netting, rock, or other material to protect the ground and promote vegetative growth.

stabilization. Local native species having the above mentioned properties should be used. However some grasses, such as Vetiver, have been used extensively worldwide because of their strong, deep roots, adaptability, and non-invasive properties (*Photo 13.9*).

Biotechnical methods such as brush layering, live stakes, and contour hedgerows (*Figure 13.4*) offer a combination of structures with vegetation for physical protection as well as additional long-term root support and aesthetics (*Photo 13.10*).

An **Erosion Control Plan** and use of erosion control measures should be an integral part of any road construction or resource extraction project. Most disturbed areas, including landings, construction storage areas, skid roads, road fills, some road cuts, drainage ditches, borrow pits, the road surface and shoulders, and other working areas should re-

Table 13.1

Key Elements of an Erosion Control and Revegetation Plan for Road Projects

- A. Description of Project**
1. Project Objectives
 2. Project Location
 3. Description of Local Environment
- B. Planning**
1. Site Analysis
 - a. Climate and Microclimate
 - b. Vegetation Options
 - c. Soils and Fertility
 2. Developing the Revegetation Plan
 - a. Suitable Plant Species
 - b. Soil and Site Preparation
 - c. Aesthetics vs. Erosion Control Needs
 - d. Use of Local “Native” Species
- C. Implementation**
1. Planting Methods—Cuttings and Transplants
 - a. Tools and Materials
 - b. Planting Holes and Methods
 2. Planting Methods—Seeding and Mulching
 - a. Hand Broadcasting or Hydroseeding
 - b. Range Drills
 - c. Type / Quantity of Seed
 - d. Type / Quantity of Mulch and Fertilizer
 - e. Holding Mulch with Tackifiers or Netting
 3. Plant Protection
 - a. Wire Caging around Plants
 - b. Fencing Around the Entire Site
 4. Maintenance and Care After Planting
 - a. Irrigation
 - b. Weed Control
 - c. Fertilization
 5. Biotechnical Planting Methods
 - a. Wattling
 - b. Brush Layering or Brush Matting
 - c. Live Stakes
- D. Obtaining Plants and Handling of Plant Materials**
1. Timing and Planning
 - a. Fall versus Spring Planting
 - b. Summer Plantings
 2. Types of Plant Materials
 - a. Cuttings
 - b. Tublings
 - c. Other Container Plants
 3. Hardening-off and Holding Plants (Acclimatizing)
 4. Handling Live Plants and Cuttings

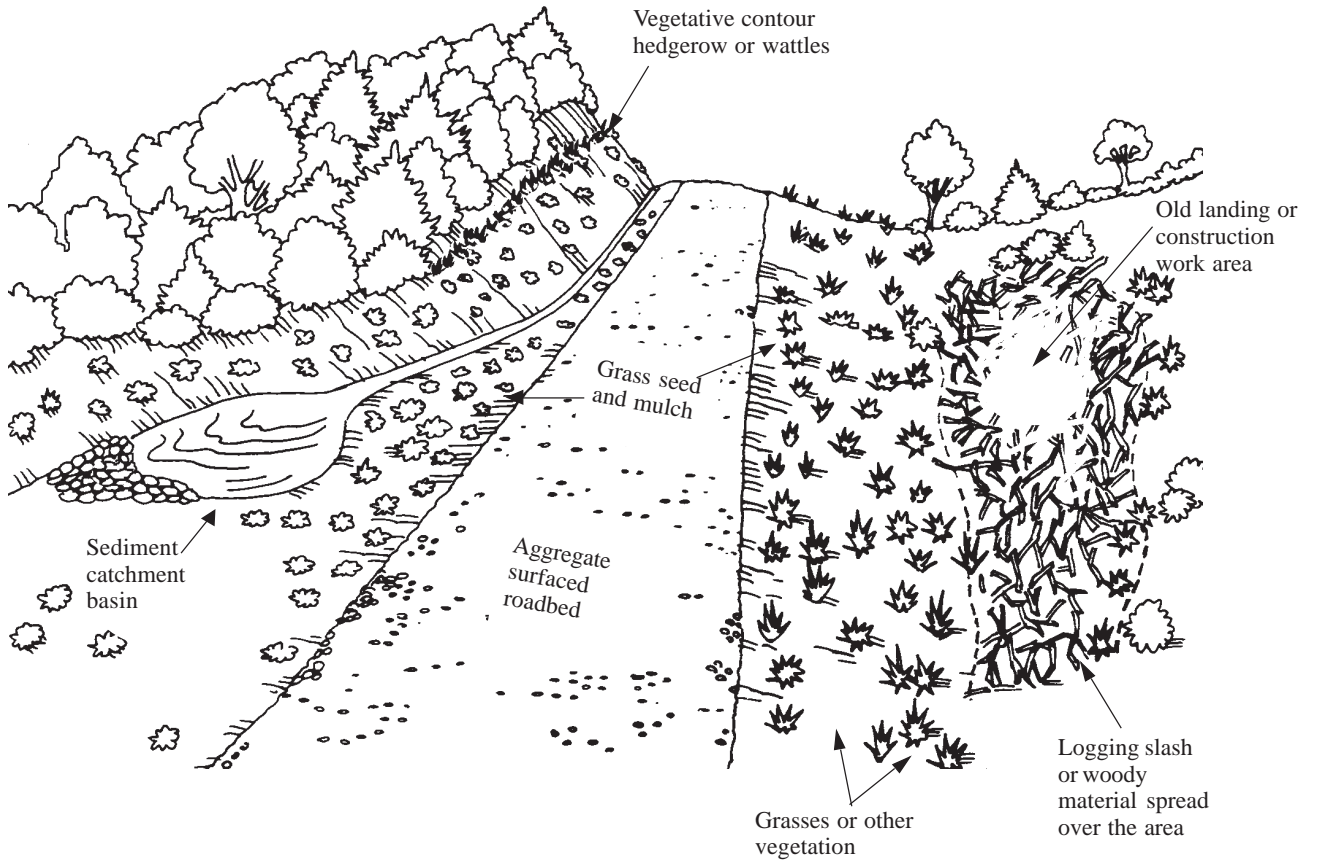
ceive erosion control treatment. It is more cost effective and efficient to prevent erosion than to repair the damage or remove sediment from streams, lakes, or groundwater.

Elements of an Erosion Control and Revegetation Plan include project location and climate, soil types, type of erosion control measures, timing of implementation of the vegetative erosion control measures, source of seeds and plants, and planting methods. *Table 13.1* presents the many aspects of planning, implementation, and care involved in an Erosion Control Plan for roads projects.

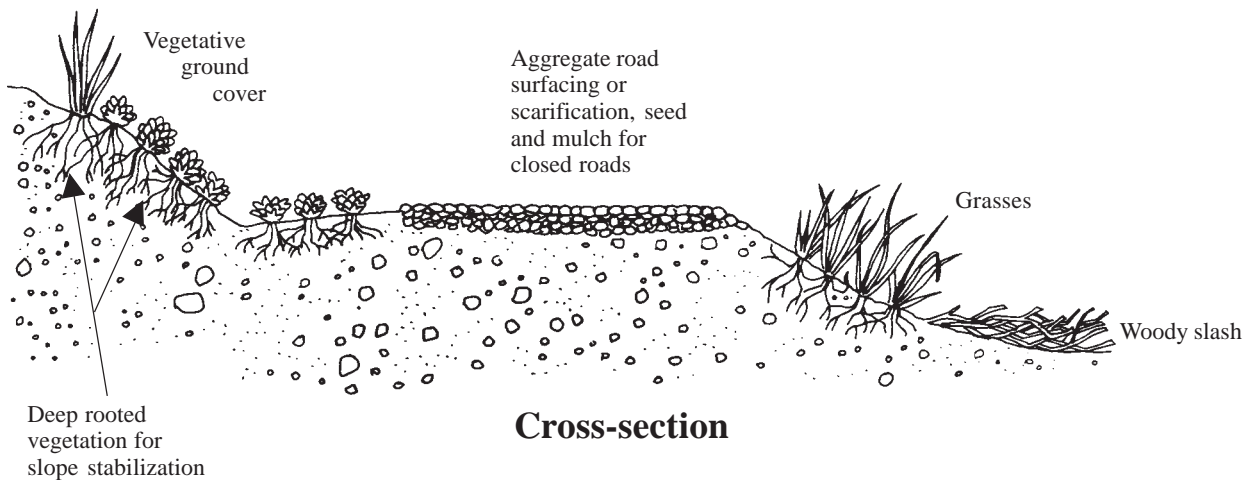
PRACTICES TO AVOID

- Disturbing unnecessarily large areas.
- Leaving native soil unprotected against erosion after new construction or ground disturbance.
- Earthwork and road construction during periods of rain or the winter.

Figure 13.1 Use of vegetation, woody material and rock for erosion control and ground cover. (Adapted from Wisconsin's Forestry BMP for Water Quality, 1995)



Perspective View



Cross-section

Various erosion control ground covers include seeding and straw mulch, grasses and other mulch, vegetation, rock, slash, chips, and leaves.



Photo 13.4 A disturbed work area covered with woody material such as brush from clearing or logging slash for erosion control . Ensure that the material is well mashed onto the ground.



Photo 13.5 A roadside ditch armored with graded rock (riprap) for erosion control.



Photo 13.6 Sediment control fences (silt fences), live vegetative barriers, or brush fences can all be used to control sediment movement on slopes (also see *Photo 6.6*).

Photo 13.7 Rock armoring, placed on a very erosive soil fill slope adjacent to a creek, used for durable, permanent erosion control.



Photo 13.8 Seed and mulch (cover for seed protection and moisture retention) applied to the ground surface to promote grass growth on barren areas, closed roads, and on erosive soils.

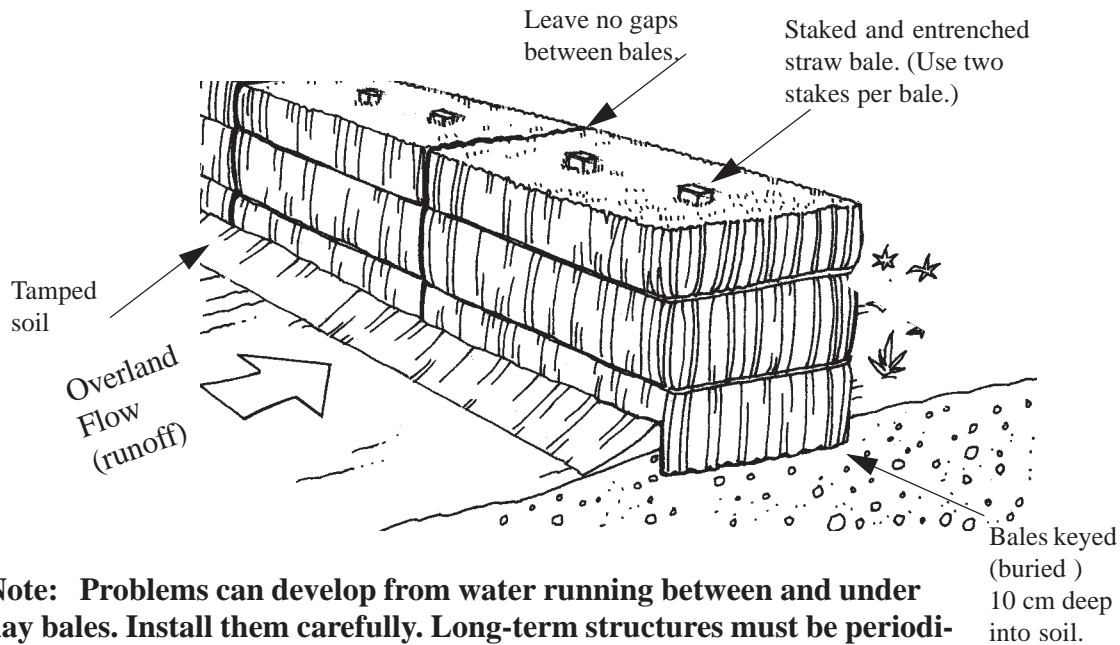


Photo 13.9 Use of Vetiver grass for slope stabilization and erosion control. Choose vegetation that is adapted to the site, has strong roots, and provides good ground cover. Ideally, use native species.



Figure 13.2a Sediment control structures using hay bales or silt fences. Note that hay bales must be installed correctly and keyed into the ground! (Adapted from Wisconsin's Forestry BMP for Water Quality)

a. Hay Bales (or bundles of grass)



Note: Problems can develop from water running between and under hay bales. Install them carefully. Long-term structures must be periodically cleaned and maintained.

b. Silt Fences

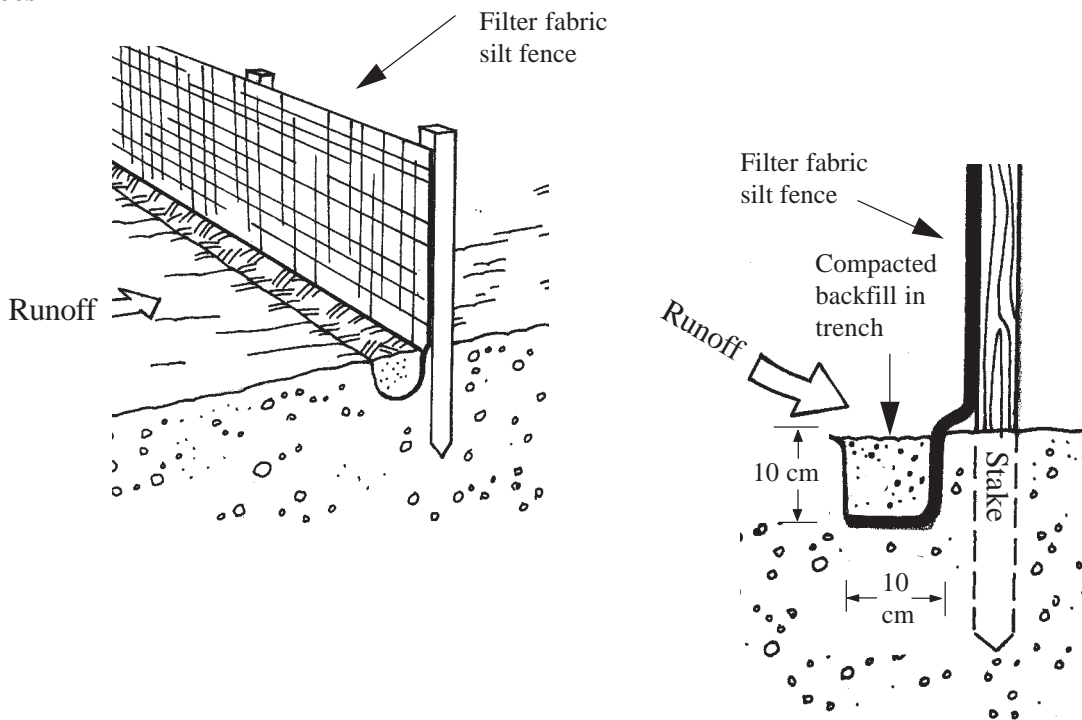
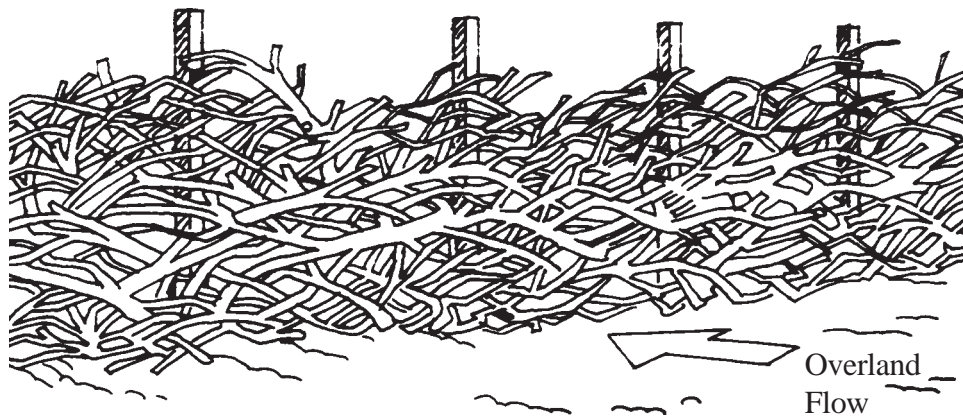
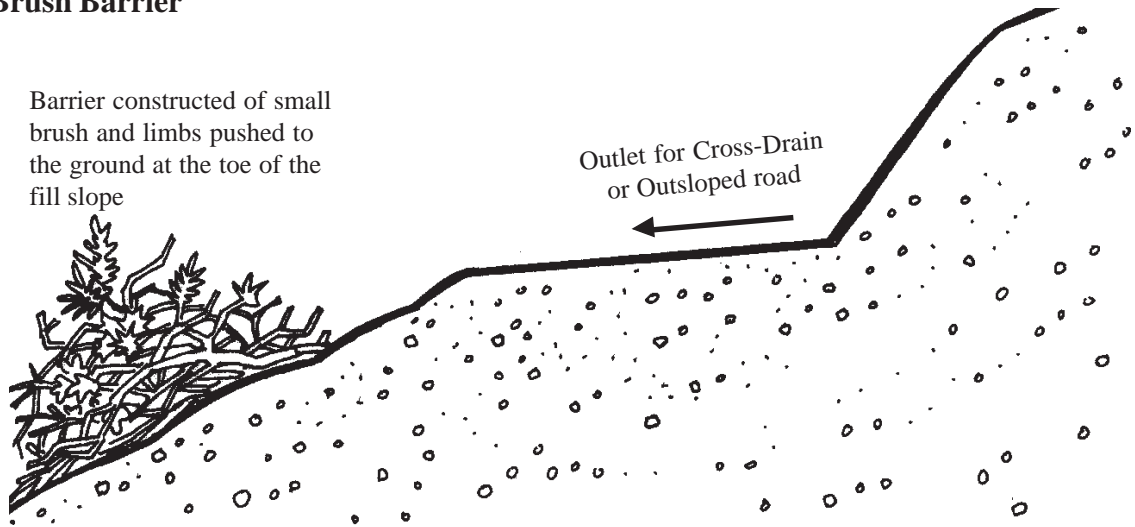


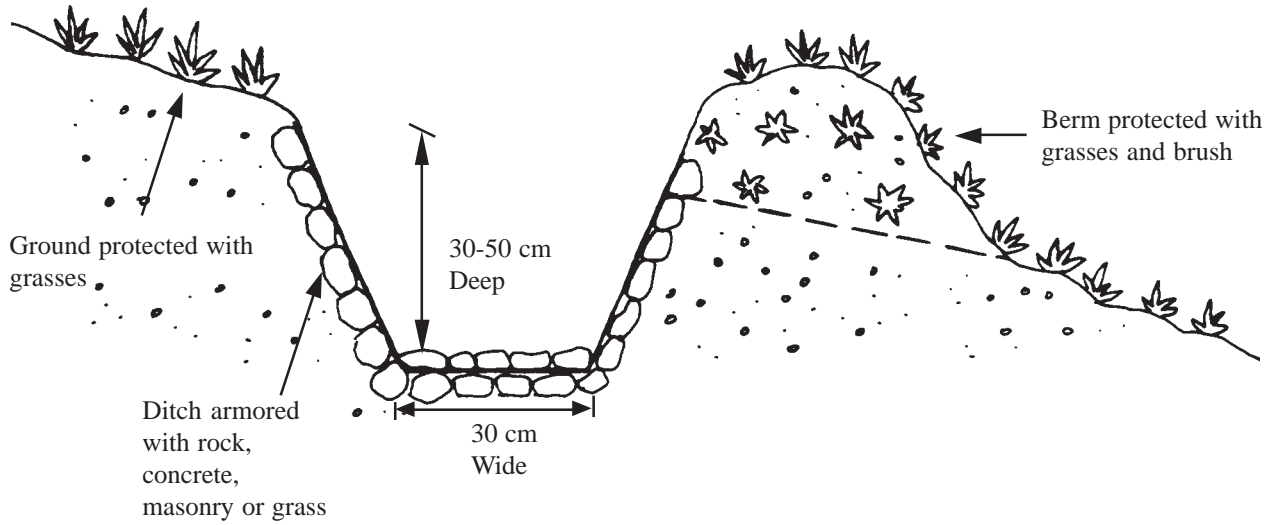
Figure 13.2b Sediment control structures using brush barriers and brush fences.

c. Brush Barrier

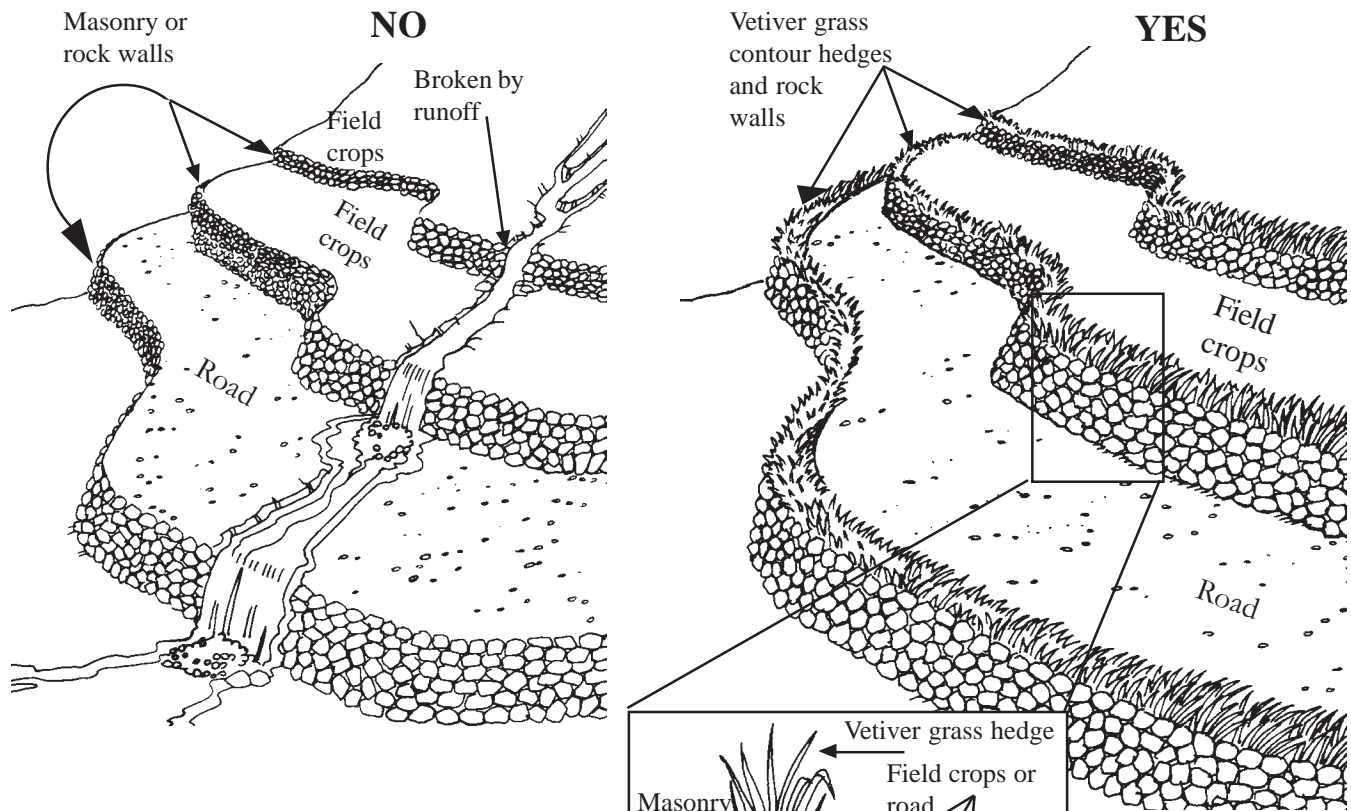


Brush Fence (buried 10 cm deep into soil).

Figure 13.3 Water control structures.



a. Water Control with Ditches and/or Berms



b. Water Control with Vegetative Barriers (and Terracing) (Adapted from *Vetiver, 1990*)

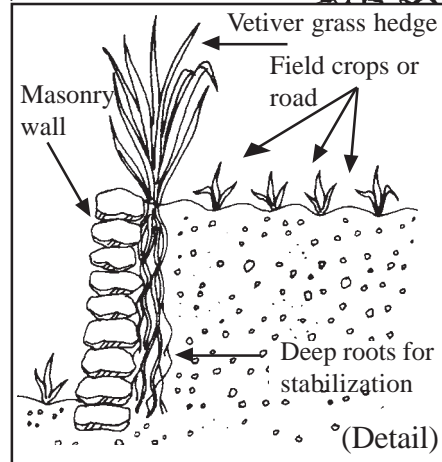


Photo 13.10 Use of grasses, planted on contour, to provide surface slope stabilization and erosion control on a steep road cut.



Photo 13.11 Live vegetative barriers (contour hedgerows), using Vetiver, other grasses, or vegetation, located on contour to prevent down-slope erosion from barren or disturbed areas.



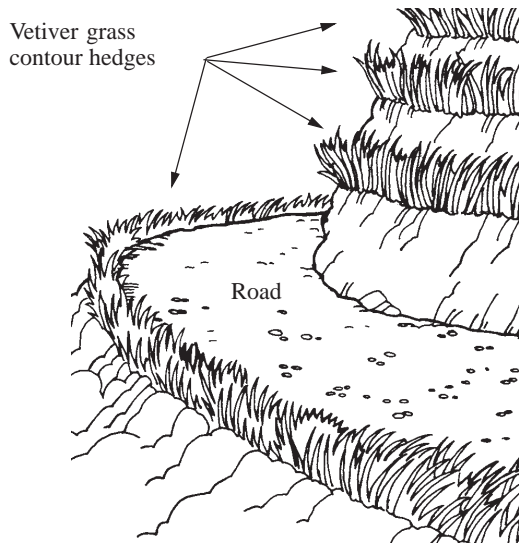
Photo 13.12 A local nursery, developed in conjunction with a construction project, to provide a source of plants and grow appropriate (preferably native) vegetation for the erosion control work.



RECOMMENDED PRACTICES

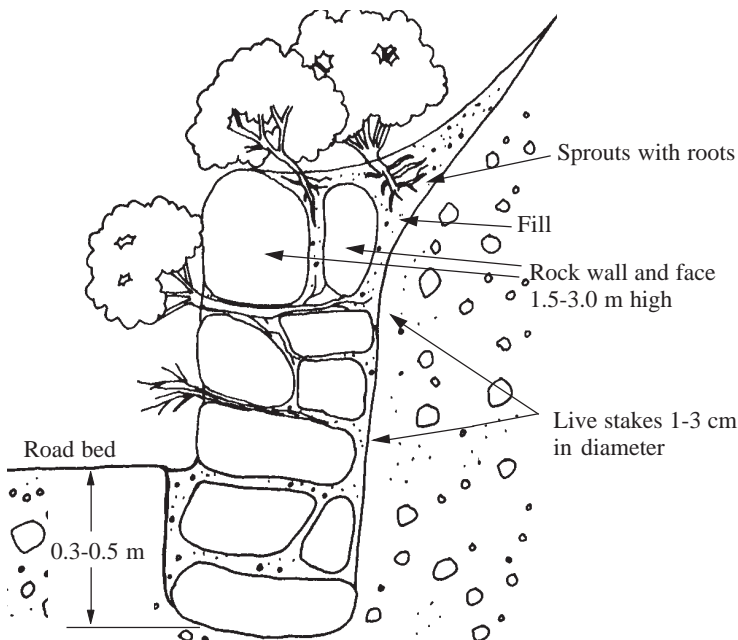
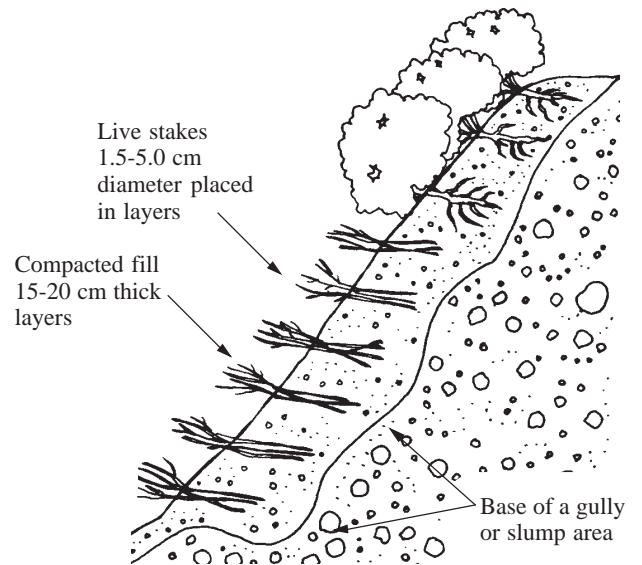
- Develop a project **Erosion Control Plan** to address interim and final erosion control needs, specific measures, and how to implement or install those measures. Develop typical drawings for sediment traps, sediment fences, brush barriers, ground cover, check dams, armored ditches, and biotechnical measures.
- Disturb as little ground area as possible, stabilize that area as quickly as possible, control drainage through the area, and trap sediment on-site.
- Conserve topsoil with its leaf litter and organic matter, and reapply this material to local disturbed areas to promote the growth of local native vegetation.
- Apply local, native grass seed and mulch to barren erosive soil areas or closed road surfaces. Mulch material may be straw, wood chips, bark, brush, leaves and limbs, shredded paper, or gravel. (*Figure 13.1*).
- Apply erosion control measures before the rainy season begins and after each season of construction, preferably immediately following construction. Install erosion control measures as each road section is completed.
- Cover disturbed or eroding areas with limbs, tree tops and woody debris such as logging slash placed on contour and mashed down to achieve good contact with the soil (*Figure 13.1*).
- Install sediment control structures where needed to slow or redirect runoff and trap sediment until vegetation is established. Sediment control structures include windrows of logging slash, rock berms, sediment catchment basins, straw bales, brush fences, and silt fencing (see *Figures 13.1, 13.2a* and *13.2b*).
- Control water flow through construction sites or disturbed areas with ditches, berms, check structures, live grass barriers, and rock (*Figure 13.3*).
- Place windrows of logging or clearing slash along the toe of roadway fill slopes (See *Low-Volume Roads Engineering, Figure 4.2*).
- Stabilize cut and fill slopes, sliver fills, upland barren areas, or gullies with brush layers, rock structures with live stakes, vegetative contour hedgerows (*Photo 13.11*), wattling, or other biotechnical measures (*Figure 13.4*).
- Maintain and reapply erosion control measures until vegetation is successfully established. Do soil chemistry tests if necessary to determine available soil nutrients.
- Use fertilizers in areas of poor, nutrient deficient soils to promote faster growth and better erosion control. Fertilizer should be used only if needed. Add water or irrigation only if necessary to initially establish vegetation.
- Develop local plant sources and nurseries for vegetative erosion control materials. Use local native species whenever possible (*Photo 13.12*). Select species appropriate for the use, the site, and the bioregion.

Figure 13.4 Biotechnical slope stabilization measures.



a. Contour Hedges
For Erosion Control and
Slope Stabilization (*Adapted
from Vetiver, 1990*)

b. Brush Layering
(for Stabilization of Gullies and Slides)



c. Live Retaining Walls
Constructed with Rock or
Gabions and Vegetation

Chapter 14

Stabilization of Gullies

“A gram of erosion control and gully stabilization can prevent a kilogram of sediment loss.”

GULLIES ARE A SPECIFIC FORM OF SEVERE EROSION typically caused by concentrated water flow on erosive soils. *Figure 14.1* shows a typical gully on a hillside and how it can impact a road and land use. Concentrated water flow may begin as minor sheet flow, produce rills, and eventually result in major gully formation. Gullies can have major impacts on an area by taking land out of production and by lowering the groundwater table, as well as being a major source of sediment (*Photo 14.1*). They

can be caused by concentrated water flowing off roads, or they can impact roads by necessitating extra drainage crossings and more frequent maintenance.

Once formed, gullies typically grow with time and will continue down-cutting until resistant material is reached. They also expand laterally as they deepen. Gullies often form at the outlet of culverts or cross-drains due to the concentrated flows and relatively fast water velocities. Also, gullies can form

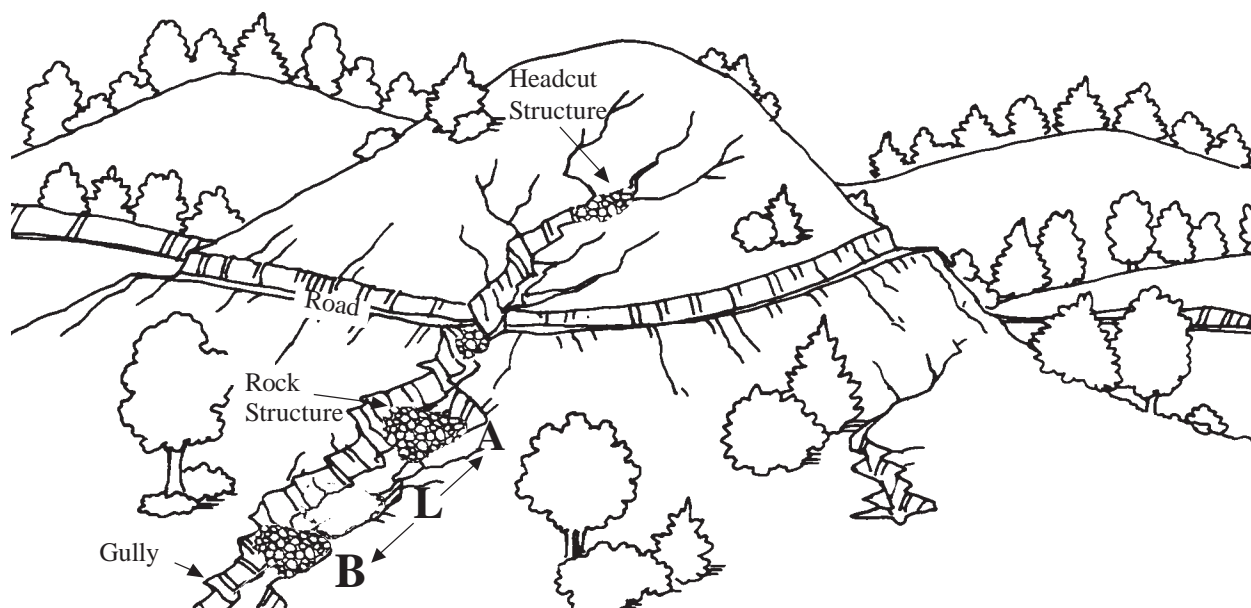


Figure 14.1 A gully caused by or impacting a road.

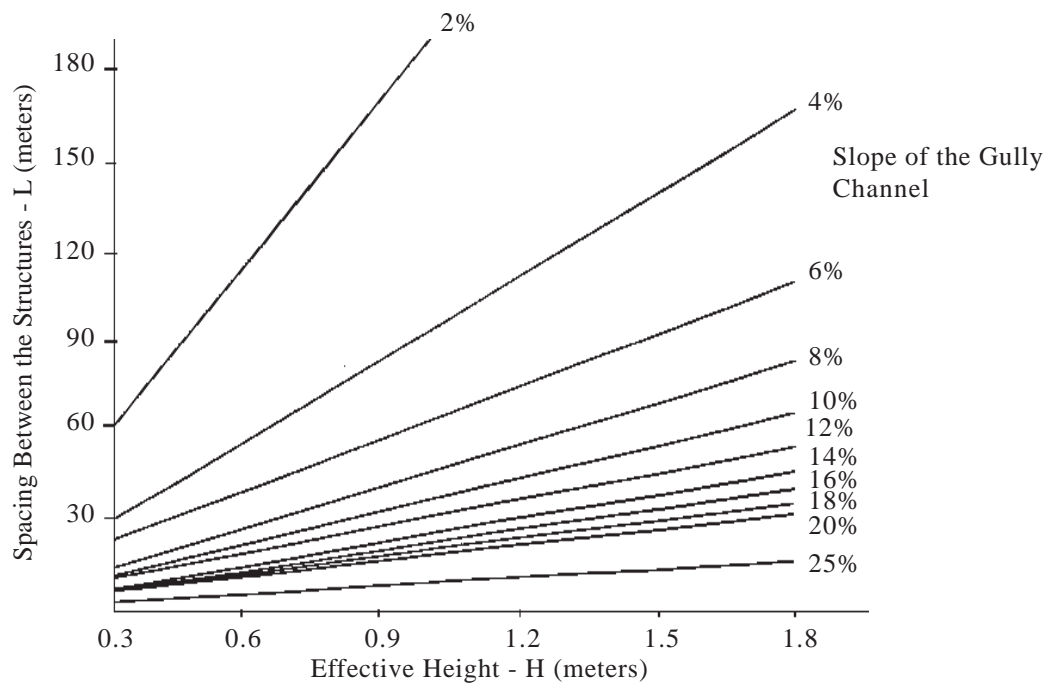


Photo 14.1 A typical gully caused by concentrated water on erosive soils and/or poor land use practices.

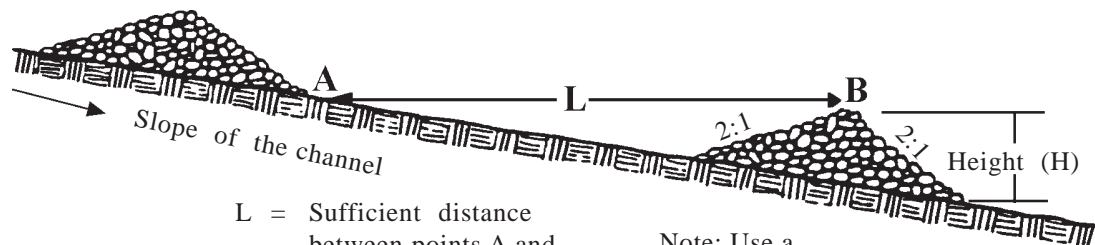
upslope of culvert pipes, especially in meadows, if the pipe is set below the meadow elevation. This causes a drop in the meadow or channel elevation and subsequent headward migration of the gully. Gullies formed through meadows often lower the local water table and may dry up the meadow.

Stabilization of gullies typically requires **removing or reducing the source of water** flowing through the gully and refilling the gully with dikes, or small dams, built at specific inter-

Figure 14.2 Spacing details of gully control structures. (Adapted from D. Gray and A. Leiser, 1982)



a.



L = Sufficient distance between points A and B so that the two dams have the same elevation (toe to top).

Note: Use a slope of 2:1 or flatter for rock dams structures.

b.

vals along the gully. Reshaping and stabilizing over-steep banks may also be needed. Typical gully stabilization structures are constructed of rock, gabions, logs (*Photo 14.2*), wood stakes with wire or brush, bamboo, or vegetative barriers. Biotechnical methods offer a combination of physical structure along with vegetative measures for physical protection as well as additional long-term root support and aesthetics. A headcut structure also typically is needed to stabilize the upslope, or top-most portion of the gully, and prevent additional headward movement (see *Figure 14.1*).

The recommended spacing for structures depends on the slope of the terrain or gully channel and the height of each structure, as presented in *Figure 14.2*. *Figure 14.2a* shows the ideal spacing needed between structures for varying channel slope and structure height. *Figure 14.2b* shows the physical relationship between structure height and spacing in a sloped channel so that water and material stored behind the lower structure is level with the toe of the upper structure. Thus, water will spill over the crest of the upper structure into the pool behind the lower structure.

In gully prevention, a **“gram” of erosion control measures can prevent a “kilogram” of sediment loss** and damage caused by erosion. Take action to prevent the formation of gullies and to stabilize existing gullies before they grow larger! Once large, gully stabilization measures can be very difficult and expensive.



Photo 14.2 Logs being used to build gully stabilization structures in a fire damaged area. Physical or vegetative dams (dikes or debris retention structures) may be used to control sediment and stabilize gullies. Prevent water concentration **before** gullies form.

SUCCESSFUL GULLY STABILIZATION

Design details important for successful gully stabilization structures begin with removing the source of water and, as shown on *Figures 14.2* and *14.3*, include:

- Having a weir, notched, or “U” shaped top on the structures to keep the water flow concentrated in the middle of the channel;
- Keying the structures into the adjacent banks tightly and far enough to prevent erosion around the ends of the structures (*Photo 14.3*);
- Burying the structures deep enough in the channel to prevent flow **under** the structure;
- Spilling the water over the structures onto a splash apron, protective layer of rock, or into a pool of water to prevent scour and undermining of the structure; and
- Spacing the structures close enough so that the flow over the structure spills into backwater caused by the next structure downstream (*Figure 14.2*).

Note: Rock commonly used in loose rock check dams should be hard, durable, well-graded with fines, and large enough to resist movement. A commonly used gradation is shown below.

Size (cm)	Percent Passing
60cm	100
30cm	50
15cm	20
6 cm	10

RECOMMENDED PRACTICES

- Remove the source of water. Control water flow as needed with ditches, berms, outsloping, and so on. to divert water away from the top of gullies.
- Use gully control check dam structures constructed of materials such as stakes, logs, gabions, or loose rock, live vegetative barriers or brush layering planted on contour in disturbed areas to control gully erosion (see *Figure 13.4b* and *Figure 14.3*).
- Install gully control structures as soon as possible after the initial formation of a gully. Gullies only get bigger with time!
- Ensure that gully control structures are installed with needed design details. Such structures should be properly spaced, well keyed into the banks and channel bottom, notched to keep flows over the middle of the structure, and protected from down slope scour (*Photo 14.4*).
- Install headcut structures at the top of the gully to prevent up-channel migration of gullies in meadows.
- Develop local plant sources and nurseries for native vegetation that can be used in gully control measures.

PRACTICES TO AVOID

- Leaving gullies unprotected against continued erosion.
- Installing check dam structures with a straight, flat top, without scour protection, and without being well keyed into the banks.



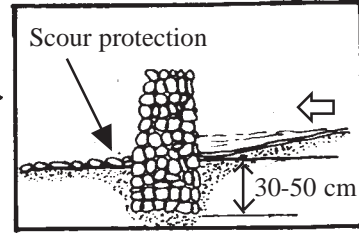
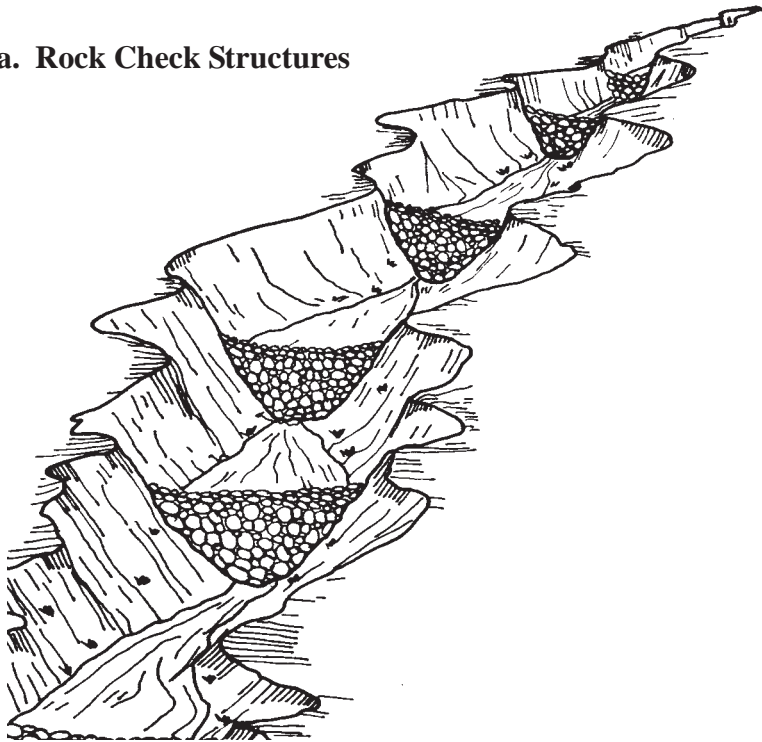
Photo 14.3 An expensive but failed gabion gully control structure that was not properly keyed into the banks of the gully. Further, the flow was not kept over the protected middle of the structure.



Photo 14.4 Construct debris retention and gully control structures with a notched wier to keep flow over the middle of the structure, add scour protection at the outlet of each structure, and key the structures into the firm soil banks.

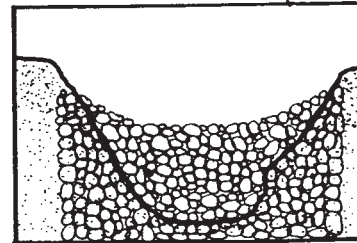
Figure 14.3 Stabilization of gullies and severe erosion areas with check structures.

a. Rock Check Structures



Side View

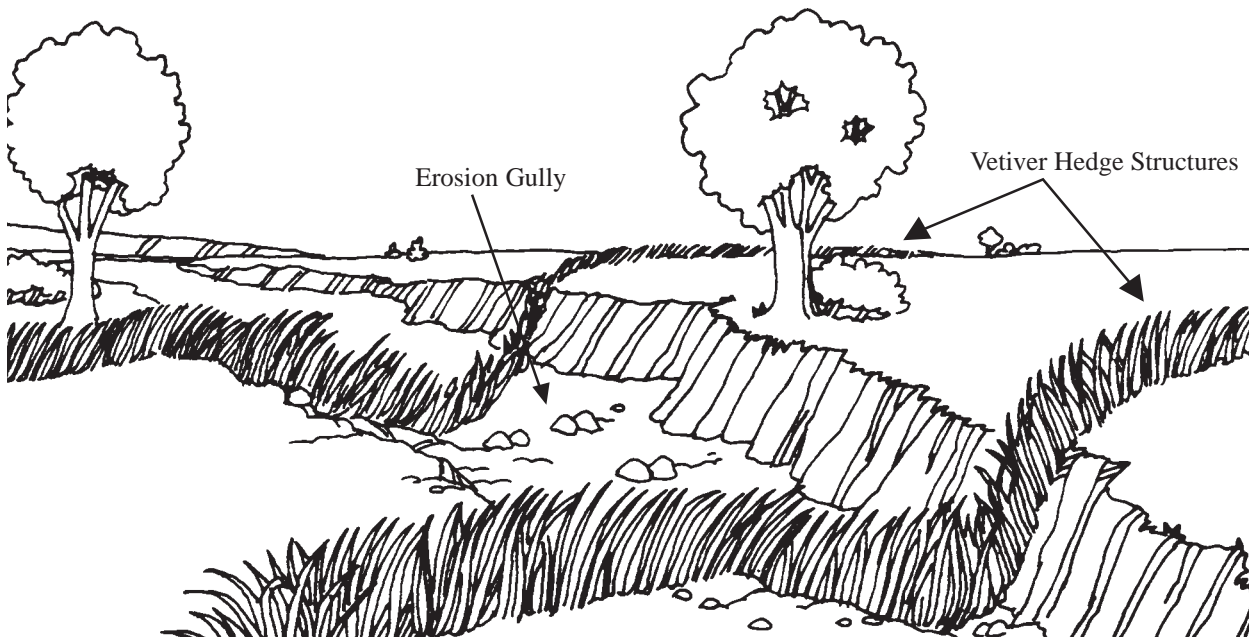
Key check structure into the native soil at the base of the gully. Add scour protection below each structure.



Front View

Key into native soil banks. Maintain a "U" or "V" shape over the top of the check structure.

b. Vegetative Check Structures (Adapted from Vetiver Grass. "The Hedge Against Erosion," World Bank, 1993.)





Depicted above is a loose rock gully control structure being used to stop headcutting up into the meadow. Note that the rock structure is well keyed into the banks and channel bottom.

Selected References

Arranged by Topic:

Best Management Practices - General	147
Environmental Analysis	148
Planning Issues and Special Applications	148
Basic Engineering Considerations for Low-Volume Roads	151
Hydrology for Drainage Crossing Design	152
Tools for Hydraulic Design: Manning's Formula, Riprap, Filters, & Geosynthetics	152
Drainage of Low-Volume Roads	153
Culvert Use, Installation, and Sizing	153
Fords and Low-Water Crossings	154
Bridges	155
Slope Stability and Stabilization of Cuts and Fills	155
Roadway Materials and Materials Sources	156
Erosion Control: Physical, Vegetative, and Biotechnical Methods	157
Stabilization of Gullies	158

BEST MANAGEMENT PRACTICES- GENERAL

Environmental Protection Agency. Draft 2001. National Management Measures to Control Non-point Source Pollution from Forestry. EPA Contract No. 68-C7-0014, Work Assignment #2-20. Prepared for Office of Water, U.S. Environmental Protection Agency by Tetra Tech, Fairfax, Virginia. *A comprehensive guide to measures for reducing water pollution from roads and logging activities.*

Michigan Department of Natural Resources. 1994. Water Quality Management Practices on Forest Lands.

Minnesota Department of Natural Resources, Division of Forestry. 1994. Visual Quality Best Management Practices for Forest Management in Minnesota.

Montana State University. 1991. Montana Forestry Best Management Practices. Montana State University Extension Service. July *BMPs also produced by Montana Department of State Lands in 1992.*

Ontario Ministry of Natural Resources. 1988. Environmental Guidelines for Access Roads and Water Crossings. Queen's Printer for Ontario, Canada.

U.S. Department of Agriculture, Forest Service. 2000. Water Quality Management for National Forest System Lands in California-Best Management Practices. Vallejo, CA: Pacific Southwest Region, U.S. Department of Agriculture, Forest Service. 186 pp.

U.S. Department of Agriculture, Forest Service. Draft 2001. Best Management Practices for Forest Roads: A performance-based framework. Washington, DC: A cooperative effort between the U.S. Department of Agriculture, Forest Service, and U.S. Environmental Protection Agency. 24 pp.

Vermont Department of Forests, Parks and Recreation. 1987. Acceptable Management Practices for Maintaining Water Quality on Logging Jobs in Vermont.

Wisconsin Department of Natural Resources. 1995. Wisconsin's Forestry Best Management Practices for Water Quality-Field Manual for Loggers, Landowners and Land Managers. Publication No. FR093. March. Madison, WI. 76 pp.

ENVIRONMENTAL ANALYSIS

Bingham, Cc; Knausenberger, Wc; Fisher, W. 1999. Environmental Documentation Manual for P.L.480, Title II Cooperating Sponsors Implementing Food-aided Development Programs, February. Food Aid Management, U.S. Agency for International Development, Washington, DC.

Burpee, G.; Harrigan, P.; Remington, T. Second Edition 2000. A Cooperating Sponsor's Field Guide to USAID Environmental Compliance Process- Based on Regulation 216 to the USAID Environmental Documentation Manual for PL 480 Title II Food for Development Programs. Published jointly by Catholic Relief Services and Food Aid Management. Baltimore, MD. 69 pp.

Forman, R.T.; Sperling, D.; et al. 2003. Road Ecology: Science and Solutions. Washington, DC: Island Press. 482 pp. (ISBN 1-55963-933-4) *A comprehensive and thoughtful book addressing the many ecological impacts of roads, their principles, and approaches to solving transportation problems.*

Knausenberger, W.; et al. 1996. Environmental Guidelines for Small-scale activities in Africa. SD Pub. Series, Technical Paper 18, Section 3.8, Rural Roads. June. Bureau for Africa, Office of Sustainable Development, U.S. Agency for International Development, Washington, DC. [Online] <http://www.afr-sd.org/SDPublications.htm>.

Public Law 91-190. [S. 1075]. National Environmental Policy Act of 1969. Act of January 1, 1970. [An act to establish a national policy for the environment, to provide for the establishment of a Council of Environmental Quality, and for other purposes.] In: United States statutes at large, 1969. 42 U.S.C. sec. 4231, et seq. (1970). Washington, DC: U.S. Government Printing Office; 1970: 852-856. Vol. 83.

World Bank, The. 1997. Roads and the Environment: A Handbook. Report TWU 13, and update WB Technical Paper No. 376. Washington, DC: The World Bank Environmentally Sustainable Development Vice-Presidency and Transportation, Water & Urban Development Department Transport Division. [Online] <http://www.worldbank.org/transport/publicat/reh/toc.htm>.

PLANNING ISSUES AND SPECIAL APPLICATIONS

Dykstra, D.; Heinrich, R. 1996. FAO Model Code of Forest Harvesting Practice. Rome, Italy: Food and Agriculture Organization of the United Nations. 85 pp. (ISBN 92-5-103690-X). [Online] <http://www.fao.org>.

Evans, W.; Johnston, B. 1972. Fish Migration and Fish Passage: A Practical Guide to Solving Fish Passage Problems. EM-7100-12. Washington, DC: U.S. Department of Agriculture, Forest Service. 63 pp.

Keller, G.; Sherar, J. 2000. Practicas Mejoradas de Caminos Forestales (Manual of Best Management Practices for Forest Roads). Manual written in Spanish for US Agency for International Development (Forestry Development Project) and ESNACIFOR (Honduras National School for Forestry Sciences), Tegucigalpa, Honduras. 95 pp.

Oregon Department of Forestry. 2000. Forest Roads Manual. Forest Engineering Coordinator, State Forests Program, Oregon Dept. of Forestry, Salem, OR. (503-945-7371). *This manual provides basic logging road design, construction, and maintenance information.*

PIARC World Roads Association. 1999. Natural Disaster Reduction for Roads, Final Report 72.02B, Paris, FR: PIARC Working Group G2. 275 pp. (ISBN 2-84060-109-5) [Online] <http://www.piarc.org>. *Also see Comprehensive Report 72.01B, 1995.*

Rajvanshi, A.; Mathur, V.; Teleki, G.; Mukherjee, S. 2001. Roads, Sensitive Habitats and Wildlife: Environmental Guidelines for India and South Asia. Wildlife Institute of India, Dehradun, India, in collaboration with Canadian Environmental Collaborative Ltd. Toronto, Canada. [Phone # 1-416-488-3313] 215 pp. (ISBN 81-85496-10-2) *A comprehensive book on the issues of wildlife, their habitats, and roads, discussing problems, mitigations, and case histories.*

U.S. Department of Agriculture, Forest Service. 2000. Water/road Interaction Toolkit- FishXing: CD software and Interactive Learning for Fish Passage through Culverts. Water/Road Interaction Technology Series-SDTDC. November. Washington, DC: U.S. Department of Agriculture, Forest Service. San Dimas Technology & Development Program. [Online] <http://www.stream.fs.fed.us/fishxing>. *A CD covering various aspects of fish passage.*

U.S. Department of Transportation, Federal Highway Administration. 1996. Transportation and Wildlife: Reducing Wildlife Mortality and Improving Wildlife Passageways Across Transportation Corridors. Report No. FHWA-PD-96-041. Proceedings of the Florida Department of Transportation/Federal Highway Administration-Related Wildlife Mortality Seminar. Washington, DC. [Online] <http://www.itre.ncsu.edu/cte/cte.html> *Case histories and information on wildlife mortality and animal movements across roads. Also see www.wildlifecrossings.info for extensive information and links on the subject.*

U.S. Department of Transportation, Federal Highway Administration. 1990. Fish Passage through Culverts. FHWA-FL-90-006. San Dimas, CA: U.S. Department of Agriculture, Forest Service. San Dimas Technology and Development Center. *A good handbook on fish passage, with a literature review.*

Walbridge, T.A. 1997. The Location of Forest Roads. Virginia Polytechnical Institute and State University, Blacksburg, VA: Industrial Forestry Operations. 91 pp. *A primer on basic road planning, reconnaissance, location and drainage in mountainous terrain. Also available in Spanish.*

BASIC ENGINEERING CONSIDERATIONS FOR LOW-VOLUME ROADS

American Association of State Highway and Transportation Officials. 2001. Guidelines for geometric design of very low-volume local roads (ADT<400). Washington, DC. (ISBN 1-56051-166-4).

[Online] <http://www.transportation.org>. *Covers the geometric design standards for very low-volume, local roads.*

Australian Road Research Board Limited. 2000. Unsealed roads manual- Guidelines to good practice. (Revised Edition) Vermont South Victoria, Australia: Australian Roads Research Board, Transport Research Ltd. [Online] <http://www.arrb.org.au> *A useful manual for gravel road design and maintenance, particularly in semi-arid regions.*

Casaday, E.; Merrill, B. 2001. Field techniques for forest and range road removal. Eureka, California: California State Parks, North Coast Redwoods District. 63 pp. *A useful Field Guide to Road Closure and Obliteration, with great photos and figures.*

Charles, R. 1997. Design of low-volume low cost roads. UWI Public Information Series/Roads, Volume 1. Dept of Civil Engineering, University of West Indies, West Indies. 132 pp. *A practical design manual that covers all aspects of rural road design, particularly considering tropical climates.*

Department of Transport, South African Roads Board. 1993. Guidelines for upgrading of low volume roads. RR 92/466/2, Division of Roads and Transport, South African Roads Board, Pretoria. (ISBN 1-874844-90-9) *A manual that provides information, considerations, and needs for upgrading rural gravel roads.*

Geunther, K. 1999. Low maintenance roads for ranch, fire and utility access. Wildland Solutions Field Guide Series, Clyde, CA: Wildland Solutions. 48 pp. [Online] www.wildlandsolutions.com.

Keller, G.; Bauer, G.; Aldana, M. 1995. Caminos rurales con impactos minimos (minimum impact rural roads). Training Manual written in Spanish for U.S.D.A., Forest Service, International Programs, USAID, and Programa de Caminos Rurales. Guatemala City, Guatemala. 800 pp. *Manual is currently being rewritten into English.*

Moll, J.E. 1996. A guide for road closure and obliteration in the Forest Service. San Dimas Technology and Development Program. Pub. No. 7700. Washington, DC: U.S. Department of Agriculture, Forest Service. 49 pp.

National Research Council, Transportation Research Board. 1978. Geometric design standards for low-volume roads. Transportation Technology Support for Developing Countries Compendium 1. Washington, DC: National Academy of Sciences. 297 pp. *Compendium contains ten selected texts intended to provide useful documentation to those in developing countries concerned with the geometric design of low-volume roads.*

Nichols, R; Irwin, L. 1993. The basics of a good road. CLRP Report No. 93-3, Ithaca, NY: Cornell University Local Roads Program, Revised by Paul Clooney as CLRP Report 96-5. 40 pp.

Ochoa, M. 2000. Technical guidelines for rural road design, construction, and improvement incorporating environmental considerations. Jicaro Galan, Honduras. Proceedings of International Environmental

Workshop on Design, Construction, and Rehabilitation of Rural Roads, sponsored by CARE Honduras, USAID, and US Forest Service.

PIARC World Roads Association. 1994. International Road Maintenance Handbook-Practical guidelines for rural road maintenance. A Four Volume set published by Transport Research Laboratory, Crowthorne, Berkshire RG116AU, United Kingdom. (ISBN 0-9521860-12) *A comprehensive guide on all aspects of maintenance for rural paved and unpaved roads, drainage, structures, and traffic control devices. Available in English, Spanish, Portuguese, and French.*

Strombom, R. 1987. Maintenance of aggregate and earth roads. *See reference under Roadway Materials.*

U.S. Department of Agriculture, Forest Service. 1999. Road analysis: Informing decisions about managing the national forest transportation system. Misc. Report FS-643. Washington, DC: U.S. Department of Agriculture, Forest Service. 222 pp. [Online] <http://www.fs.fed.us/news/roads> *Covers costs to maintain and mitigate in relationship to values at risk – uses and benefits as opposed to environmental damage.*

Weaver, W.; Hagans, D. 1994. Handbook for forest and ranch roads: A guide for planning, designing, constructing, reconstructing, maintaining, and closing wildland roads. Ukiah, CA: Pacific Watershed Associates for the Mendocino County Resource Conservation District, in cooperation with CDF and the NRCS. 161 pp.

Weist, R. 1998. A landowner's guide to building forest access roads. Report NA-TP-06-98. Radnor, PA: U.S. Department of Agriculture, Forest Service, Northeastern Area. Published in cooperation with State and Private Forestry. 45 pp.

HYDROLOGY FOR DRAINAGE CROSSING DESIGN

American Association of State Highway and Transportation Officials. 1999, Highway Drainage Guidelines (Metric Edition). Washington, DC. (ISBN I-56051-126-5). 630 pp. [Online] <http://www.transportation.org>. *A comprehensive guide on all aspects of highway drainage design.*

Jennings, M.E.; Thomas, W.O.; Riggs, H.C. 1994. Nationwide summary of U.S. Geological Survey regional regression equations for estimating magnitude and frequency of floods for ungaged sites, 1993. Water Resources Investigation Report 94-4002. Reston, VA: U.S. Geologic Survey. 38 p. Prepared in cooperation with FHWA and FEMA. [Online] <http://www.ntis.gov>. *Available through NTIS, Springfield, Va. Phone (703) 605-6000.*

Linsley, R.; Kohler, M.; Paulhus, J. 1958. Hydrology for engineers. New York, NY: McGraw-Hill Book Company, 340 p. *A classic text on hydrology.*

McCuen, R.; Johnson, P.; Ragan, R. 1996. Highway hydrology. Hydraulic Design Series No. 2. Pub. No. FHWA-SA-96-067. September. Washington, DC: U.S. Department of Transportation, Federal Highway Administration. 326 pp. [Online] <http://www.fhwa.dot.gov/bridge>. *Covers hydrologic techniques and methods suitable to small drainage areas.*

Rosgen, D. 1996. Applied river morphology. Pagosa Springs, CO: Wildland Hydrology. (ISBN 0-9653289-0-2)

TOOLS FOR HYDRAULIC DESIGN: MANNING'S FORMULA, RIPRAP, FILTERS, AND GEOSYNTHETICS

Barnes, H. Jr. 1967. Roughness characteristics of natural channels. U.S. Geological Survey Water Supply Pap. 1849. Washington, DC: U.S. Government Printing Office. Available through U.S. Geological Survey, Arlington, VA. 213 pp. [Online] <http://www.engr.utk.edu/hydraulics/openchannels/cover.htm>. *Presents many color photos comparing stream types and their Mannings Roughness Coefficient "n".*

Brown, S.; Clyde, E. 1989. Design of riprap revetment. Hydraulic Engineering Circular No. 11, March. Washington, DC: U.S. Department of Transportation, Federal Highway Administration. 156 pp. [Online] <http://www.fhwa.dot.gov/bridge>. *Covers detailed design guidance for sizing and placing riprap. Updated from 1978 version.*

Chow, V.T. 1959. Open channel hydraulics. New York, NY: McGraw-Hill Book Company. 680 pp. (ISBN 07-010776-9) *A classic, basic textbook on hydraulics and flow in open channels.*

Copeland, R.; McComas, D.N.; Thorne, C.R.; Soar, P.J.; Jonas, M.M.; Fripp, J.B. 2001. Hydraulic Design of Stream Restoration Projects. ERDC/CHL TR-01-28, U. S. Army Engineering Research and Development Center, U. S. Army Corps of Engineers. 175 pp. [Online] <http://libweb.wes.army.mil/uhtbin/hyperion/CHL-TR-01-28.pdf> *Covers a systematic hydraulic design methodology to aid in the design of stream restoration projects.*

Holtz, R.D.; Christopher, B.R.; Berg, R.R. 1998. Geosynthetic design and construction guidelines. Participant Notebook, NHI Course No. 13213 (Revised April 1998). Rep. No. FHWA-HI-95-038. Washington DC: U.S. Department of Transportation, Federal Highway Administration. 484 pp. [Online] <http://www.fhwa.dot.gov/bridge>. *A comprehensive guide on the use and design of geotextiles, geogrids, and geocomposites in highway applications.*

Koerner, R. 1998. Designing with geosynthetics. 4th ed. Englewood Cliffs, NJ: Prentice Hall. 761 pp. (ISBN 0-13-726175-6) *This updated edition covers the latest materials and design techniques using geosynthetics.*

Racin, J.; Hoover, T.; Avila, C. 1996. California bank and shore rock slope protection design. FHWA-CA-TL-95-10 Sacramento, CA: California Department of Transportation and Federal Highway Administration, 139 pp. *A useful reference on riprap sizing and placement.*

Schall, J.D.; Richardson, E.V. 1997. Introduction to highway hydraulics. Hydraulic Design Series No. 4. Pub. No. FHWA-HI-97-028. June. Washington, DC: U.S. Department of Transportation, Federal Highway Administration. 192 pp. <http://www.fhwa.dot.gov/bridge>. *Covers hydraulic techniques applied to roadway surface drainage and for drainage crossings.*

Steward, J.; Williamson, R.; Mohny, J. 1977. Guidelines for use of fabrics in construction and maintenance of low-volume roads. Interim Rept. June. Portland, OR: U.S. Department of Agriculture, Forest Service, Region 6. 174 pp. *Covers basic porous woven and non-woven fabrics use in road construction in the U.S. Forest Service.*

U.S. Department of Agriculture, Natural Resources Conservation Service. 1994. Gradation design of sand and gravel filters. Chapter 26. In: Part 633, National Engineering Handbook. Washington, DC. 40 pp.

U.S. Department of Agriculture, Natural Resource Conservation Service. 1996. Streambank and shoreline protection. In: Engineering Field Handbook, Chapter 16. Rep. No. NEH-650-16. December. Washington, DC. 130 pp. *Covers bank protection from scour and erosion by using vegetative plantings, soil bioengineering, and structural systems.*

DRAINAGE OF LOW-VOLUME ROADS

Blinn, C.R.; Dahlman, R.; Hislop, L.; Thompson, M. 1998. Temporary stream and wetland crossing options for forest management. Forest Service Gen. Tech. Rep. NC-202. St. Paul, MN: U.S. Department of Agriculture, Forest Service, North Central Forest Experiment Station. 136 pp. *Discusses temporary options for crossing streams and wetland soil areas with forest harvesting equipment and logging trucks.*

Cedergren, H. 1977. Seepage, drainage, and flow nets. 3rd ed. New York: John Wiley and Sons. 496 pp. (ISBN 0-471-14179-8)

Copstead, R.; Johansen, K.; Moll, J. 1998. Water/road interaction: Introduction to surface cross drains. Water/Road Interaction Technology Series. Res. Rep. 9877 1806 – SDTDC. September. Washington, DC: U.S. Department of Agriculture, Forest Service. San Dimas Technology & Development Program. 16 pp. *A water-roads interaction toolkit is also available on a CD.*

Elliot, W.; Graves, S.; Hall, D.; Moll, J. 1998. The X-DRAIN cross drain spacing and sediment yield model. In: Water/Road Interaction Technology Series. Res. Rep. 9877 1801 – SDTDC. June. Washington, DC: U.S. Department of Agriculture, Forest Service. San Dimas Technology & Development Program. 23 pp. [Online] <http://www.stream.fs.fed.us/water-road/index.htm>.

Furniss, M.; Love, M.; Flanagan, S. 1997. Diversion potential at road-stream crossings. In: Water/Road Interaction Technology Series. Res. Rep. 9777 1814 – SDTDC. December. Washington, DC: U.S. Department of Agriculture, Forest Service. San Dimas Technology & Development Program. 12 pp. [Online] <http://www.stream.fs.fed.us/water-road/index.htm>.

Furniss, M.; Roelofs, T.; Yee, C. 1991. Road construction and maintenance. In: Meehan, W.R., ed. Influences of forest and rangeland management on salmonid fishes and their habitat, Chapter 8. Special Pub. 19. Bethesda, MD: American Fisheries Society. pp. 297-324.

Orr, D. 1998. Roadway and roadside drainage. CLRP Publication No. 98-5. Ithaca, NY: Cornell Local Roads Program. 88 pp.

Packer, P.; Christensen, G. 1964. Guide for controlling sediment from secondary logging roads. [pamphlet] Ogden, UT: U.S. Department of Agriculture, Forest Service, Intermountain Forest and Range Experiment Station. 42 pp. (Government Printing Office 1980-682-866/222)

Washington Department of Fish and Wildlife. 2002. Integrated Streambank Protection Guidelines. Aquatic Habitat Guidelines: An Integrated Approach to Marine, Freshwater, and Riparian Habitat Protection and Restoration, June. In cooperation with Washington Department of Transportation and Washing-

ton Department of Ecology. 329 pp. [Online] <http://www.wa.gov/wdfw/hab/ahg/ispgdoc.htm>. *Presents and describes a broad range of streambank protection techniques.*

Zeedyk, W.D. 1996. Managing roads for wet meadow ecosystem recovery. November. Tech. Rep. FHWA-FLP-96-016. Albuquerque, NM: U.S. Department of Agriculture, Forest Service, Southwestern Region. 76 pp. *Includes a riparian restoration guide for wet meadows.*

CULVERT USE, INSTALLATION, AND SIZING

American Iron and Steel Institute. 1994, Fifth Edition. Handbook of steel drainage and highway construction products. Washington, DC: American Iron and Steel Institute. 518 pp.

Johansen, K.; Copstead, R.; Moll, J. 1997. Relief culverts. Water/Road Interaction Technology Series. Res. Rep 9777 1812-SDTDC. October. Washington, DC: U.S. Department of Agriculture, Forest Service, San Dimas Technology & Development Program. 7 pp. [Online] <http://www.stream.fs.fed.us/water-road/index.htm>. *Covers surface drainage and ditch relief culvert spacing and design.*

Normann, J.M.; Houghtalen, R.J.; Johnston, W.J. 1985 (Reprinted 1998). Hydraulic design of highway culverts. Hydraulic Design Series No. 5. Tech. Rep. No. FHWA-IP-86-15 HDS 5. September. McLean, VA: Department of Transportation, Federal Highway Administration, Office of Implementation. 265 pp. [Online] <http://www.fhwa.dot.gov/bridge/hydpub.htm>. *Includes a comprehensive design for both conventional culverts and culverts with inlet improvements.*

FORDS AND LOW-WATER CROSSINGS

Berger, L.; Greenstein, J.; Arrieta, J. 1987. Guidelines for the design of low-cost water crossings. Transportation Res. Record 1106. Washington, DC: National Research Council, Transportation Research Board. pp. 318-327.

Coghlan, G.; Davis, N. 1979. Low-water crossings. Transportation Res. Record 702, Washington, DC: National Research Council, Transportation Research Board. pp. 98-103.

Eriksson, M. 1983. Cost-effective low-volume-road stream crossings. Transportation Res. Record 898. Washington, DC: National Research Council, Transportation Research Board. pp. 227-232.

Lohnes, R.A.; Gu, R.R.; McDonald, T.; Jha, M.K. 2001. Low-Water Stream Crossings: Design and Construction Recommendations. Final Report CTRE Project 01-78, IOWA DOT Project TR-453, Center for Transportation Research and Education, Iowa State University. 50 pp. [Online] www.ctre.iastate.edu *A useful publication on specific design information for low-water crossings.*

Motayed, A.K.; Chang, F.M.; Mukherjee, D.K. 1982. Design and construction of low-water stream crossings. Report No. FHWA/RD-82/163. June. Washington, DC: U.S. Department of Transportation, Federal Highway Administration. 119 pp. *A thorough review on low-water stream crossing structure design criteria, site selection, and structure types. This publication is currently being revised and updated by Robert Gu at Iowa State University.*

Moll, J. 1997. Site and selection of low water crossings. In: Ecosystem Road Management. Compiled by San Dimas Technology and Development Center. San Dimas, CA:U.S. Department of Agriculture, Forest Service.

Ring, S.L. 1987. The design of low-water stream crossings. Transportation Res. Record 1106. Washington, DC: National Research Council, Transportation Research Board. pp. 309-318.

U.S. Department of Transportation, Transportation Research Board. 1979. Low-cost water crossings. Compendium 4, Transportation Technology Support for Developing Countries. Prepared for U.S. Agency for International Development. Washington, DC. 203 pp. *Provides useful information for those in developing countries who have direct responsibility for low-cost water crossings.*

Warhol, T.; Pyles, M. 1989. Low water fords: An alternative to culverts on forest roads. August 27-30; Coeur d'Alene, ID: Proc. 12th Annual Council on Forest Engineering Meeting.

BRIDGES

American Association of State Highway and Transportation Officials, Inc. 1996. Standard specifications for highway bridges, 16th Edition (and Interim Revisions 1997, 1998, 1999, and 2000) Washington, DC. [Online] <http://www.aashto.org> and <http://www.transportation.org>. *Covers all aspects of design for wood, steel, and concrete bridges, substructures, foundations, retaining walls, as well as structural plate structures and culverts.*

Nagy, M.; Trebett, J.; Wellburn, G. 1980. Log bridge construction handbook. FERIC Handbook #3, Vancouver, B.C., Canada: Forest Engineering Research Institute of Canada. (ISSN 0701-8355) 421 pp.

Neill, C. 1973. Guide to bridge hydraulics (plus Metric Revision Supplement). Toronto, ON: Project Committee on Bridge Hydraulics, Roads and Transportation Association of Canada, University of Toronto Press. 191 pp. (ISBN 0-8020-1961-7)

Richardson, E.V.; Davis, S.R. 1995. Evaluating scour at bridges. Hydraulic Engineering Circular No. 18. Pub. No. FHWA-HI-96-031. November. Washington, DC: U.S. Department of Transportation, Federal Highway Administration. 204 pp. [Online] <http://www.fhwa.dot.gov/bridge>. *Covers all aspects of scour evaluation and determination of scour depth.*

SLOPE STABILIZATION AND STABILITY OF CUTS AND FILLS

Barrett, R.K. 1985. Geotextiles in earth reinforcement. Geotechnical Fabrics Report, March/April:15-19.

Elias, V.; Christopher, B.R. 1997. Mechanically stabilized earth walls and reinforced soil slopes - design and construction guidelines. August. Tech. Rep. No. FHWA-SA 96-071, reprinted September 1998. FHWA Demonstration Project 82. Washington, DC: Department of Transport., Federal Highway Administration. 396 pp. [Online] <http://www.fhwa.dot.gov/bridge>. *Covers the design of mechanically stabilized earth walls and reinforced soil slopes.*

Gray, D.; Leiser, A. 1982. Biotechnical slope protection and erosion control. Melbourne, FL: Krieger Publishing Co. 288 pp. (ISBN 0-442-21222-4) *Covers various biotechnical slope stabilization and erosion control techniques.*

Hoek, E.; Bray, J. 1974. Rock slope engineering. London: Institute of Mining and Metallurgy. 358 pp. (ISBN 0-900488-573)

Keller, G.; Cummins, O. 1990. Tire retaining structures. Engineering Field Notes. 22:15-24, March/April. Washington, DC: U.S. Department of Agriculture, Forest Service.

Mohney, J. 1994. Retaining wall design guide. 2d ed. Tech. Rep. No. EM-7170-14. Washington, DC: U.S. Department of Agriculture, Forest Service, Engineering Staff. Also Pub. No. FHWA-FLP-94-006. September. Washington, DC: Department of Transportation, Federal Highway Administration, Federal Lands Highway Program. 537 pp. [Online] <http://www.ntis.gov>. *Covers the analysis and design of a wide variety of low-cost retaining structures.*

Turner, A.K.; Schuster, R.L. 1996. Landslides — investigation and mitigation. Tech. Rep. No. TRB-SR-247. Washington, DC: National Research Council, Transportation Research Board. National Academy Press. 680 pp. (ISBN 0-309-06208-X) *A comprehensive publication on all aspects of landslide hazards, investigation, their analysis, the design of unstable soil and rock slope stabilization measures, and special applications.*

U.S. Department of Agriculture, Forest Service. 1994. Slope stability reference guide for National Forests in the United States. EM-7170-13. Engineering Staff, Washington, DC: U.S. Department of Agriculture, Forest Service. Available from the Government Printing Office, Phone (202) 512-1800, <http://www.bookstore.gpo.gov> *A comprehensive 3-volume set of information on all aspects of slope stability, identification, planning and risk, analysis methods, and stabilization techniques, written by field practitioners. A practical guide for geologists and engineers dealing with slope stability problems.*

ROADWAY MATERIALS AND MATERIALS SOURCES

Australian Roads Research Board. 1996. Road dust control techniques – Evaluation of chemical dust suppressants' performance. Spec. Rep. 54. Victoria, Australia: Australian Roads Research Board, Transport Research Ltd. [Online] <http://www.arrb.org.au>. *Covers the products available, how they work, selecting the product, and the product's environmental impacts.*

Bolander, P.; Yamada, A. 1999. Dust palliative selection and application guide. Technology & Development Program No. 9977 1207—SDTDC. November. Washington, DC: U.S. Department of Agriculture, Forest Service. San Dimas Technology and Development Program. 19 pp.

Dunne, T.; Collins, B. 1990. Fluvial geomorphology and river gravel mining: A guide for planners, case studies included. Special Publication SP 098. Sacramento, CA: California Department of Conservation, Division of Mines and Geology. 29 pp.

Rodriguez, A.; del Castillo, H.; Sowers, G. F. 1988. Soil mechanics in highway engineering. Federal Republic of Germany: TransTech Publications. 843 pp. (ISBN 0-87849-072-8)

Scholen, D.E. 1992. Non-standard stabilizers. Pub. No. FHWA FLD-92-011. July. Washington, DC: U.S. Department of Transportation, Federal Highway Administration, Office of Direct Federal Programs. *Covers the Forest Service use of various non-standard road surface stabilization products.*

South Dakota Local Transportation Assistance Program. 2000. Gravel roads: maintenance and design manual. November. Published in cooperation with U.S. Department of Transportation, Federal Highway Administration. 63 pp. [Online] <http://www.epa.gov/owow/nps/gravelroads/>. *A useful manual on design and maintenance of gravel roads, with great photos and figures.*

Sowers, G. F. 1979. Introductory soil mechanics and foundations: Geotechnical Engineering. 4th ed. New York: Macmillan. 621 pp. (ISBN 0-02-413870-3) *A basic textbook on soil mechanics.*

Strombom, R. 1987. Maintenance of aggregate and earth roads. WA-RD 144.1. June. Olympia, WA: Washington State Dept. of Transportation. Reprinted as Federal Highway Administration Publication No. FHWA-TS-90-035. 71 pp. *A state-of-the-art manual on maintenance and management of aggregate and native earth roads.*

U.S. Department of Agriculture, Forest Service. 1996. Earth and aggregate surfacing design guide for low-volume roads. Pub. No. EM-7170-16. September. Washington, D.C. 302 pp. *Covers the design methodology for Surface Thickness Program, as well as an aid in selecting the type of surfacing material, and surface maintenance.*

U.S. Department of Transportation, Federal Highway Administration. 1998. Problems associated with gravel roads. Publication No. FHWA-SA-98-045. May. Washington, DC: Produced through Local Technical Assistance Program.

Yamada, A. 1999. Asphalt seal coat treatments. Technology & Development Program No. 9977 1201—SDTDC. April. Washington, DC: U.S. Department of Agriculture, Forest Service, San Dimas Technology & Development Program. 24 pp.

Yoder, E.J.; Witczak, M.M. 1975. Principles of pavement design. 2d ed. New York: John Wiley & Sons. 711pp. (ISBN 0-471-97780-2) *A classic text on fundamentals of pavement design.*

EROSION CONTROL: PHYSICAL, VEGETATIVE AND BIOTECHNICAL METHODS

Association of Bay Area Governments. 1995. Manual of standards for erosion & sediment control measures, 2d ed.. May. San Fransisco, CA. 500 pp. *A comprehensive field guide for controlling soil erosion in California.*

Burroughs, E.; King, J. 1989. Reduction of soil erosion on forest roads. Tech. Rep. No. FSGTR-INT-264, July. Moscow, ID: U.S. Department of Agriculture, Forest Service, Intermountain Research Station. 26 pp. *Covers expected reduction in surface erosion from selected treatments applied to forest road traveled ways, cutslopes, fillslopes, and ditches.*

Clackamas County Water Environment Services. 2000. Erosion prevention and sediment control: planning and design manual. Oregon: Developed in cooperation with City of West Lynn and the Unified Sewerage Agency of Washington County. Ph 503-353-4567. *Presents many erosion and sediment control Best Management Practices, with nice photos and illustrations.*

Gray, D.; Leiser, A. 1982. Biotechnical slope protection and erosion control. Melbourne, FL: Krieger Publishing Co. 288 pp. (ISBN 0-442-21222-4) *A good textbook covering various biotechnical erosion control techniques, their design and construction.*

Gray, D.; Sotir, R. 1996. Biotechnical and soil bioengineering slope stabilization-A practical guide for erosion control. New York, NY: A Wiley-Interscience Publication, John Wiley and Sons, Inc. 378 pp. (ISBN 0-471-04978-6) *Covers various biotechnical erosion control techniques and their application.*

Grimshaw, R.G.; Helfer, L. (eds.). 1995. Vetiver grass for soil and water conservation, land rehabilitation, and embankment stabilization: a collection of papers and newsletters compiled by the vetiver network. World Bank Technical Pap. No. 273. Washington, DC: The World Bank. 288 pp. *A collection of papers and newsletters supporting the use of vetiver grass conservation as a low-cost biological system of erosion control and water conservation.*

Lewis, L. 2000. Soil Bioengineering -- An Alternative for Roadside Management, A Practical Guide. Technology & Development Program No. 0077-1801-SDTDC, September. Washington, DC: U.S. Department of Agriculture, Forest Service, San Dimas Technology & Development Center, San Dimas, CA. 43 pp.

Morfin, S.; Elliot, W.; Foltz, R.; Miller, S. 1996. Predicting effects of climate, soil, and topography on road erosion with the WEPP model. In: Proceedings of the 1996 American Society of Agricultural Engineers, Annual International Meeting; 1996 July 16; Phoenix, AZ. ASAE Paper No. 965016. St. Joseph, MI: ASAE. 11 pp. *Use of the Water Erosion Prediction Project (WEPP) soil erosion model.*

U.S. Department of Agriculture, Soil Conservation Service. 1978. Estimating sheet-rill erosion and sediment yield on rural and forest highways. WTSCNT Woodland 12. US Department of Agriculture, Soil Conservation Service, 33 pp. *Basic information on use of the Universal Soil Loss Equation (USLE) to predict erosion loss on roads.*

U.S. Department of Agriculture, Soil Conservation Service. 1992. Soil bioengineering for upland slope protection and erosion reduction. In: Engineering Field Handbook, Chapter 18. October. Rep. No. EFH-650-18. Washington, DC. 62 pp. *Covers biotechnical erosion control techniques and their use, with great photos and drawings.*

World Bank, The. 1993. Vetiver grass: The hedge against erosion. Washington, DC. 78 pp. (ISBN 0-8213-1405) [Online] <http://www.vetiver.org>. *A basic, useful pamphlet on the applications of Vetiver Grass. Spanish version first published in 1990.*

STABILIZATION OF GULLIES

Gray, D.; Leiser, A. 1982. Biotechnical slope protection and erosion control. Melbourne, FL: Krieger Publishing Co. 288 pp. (ISBN 0-442-21222-4) *Covers various erosion control techniques and gully stabilization measures.*

Heede, B. 1976. Gully development and control: The status of our knowledge. Research Paper RM-169. Fort Collins, CO: U.S. Department of Agriculture, Forest Service, Rocky Mountain Forest and Range Experiment Station. 42 pp. *A basic primer on gully formation, gully stabilization techniques, and types of control structures.*