

***THE FUTURE OF  
DIRECT POTABLE REUSE***

---

**Direct Potable Reuse in California  
Specialty Seminar**

Berkeley, CA

September 23, 2015

**George Tchobanoglous**

Professor Emeritus

Department of Civil and Environmental Engineering

University of California, Davis

## ***DISCUSSION TOPICS***

---

What is Direct Potable Reuse  
Some Historical Perspectives  
Some Issues  
Future Challenges

## ***WHAT IS DIRECT POTABLE REUSE?***

---

- DPR
- IPR
- De facto IPR
- Technologies
- Cost and energy usage versus other water sources and measures
- Where does potable reuse fit in the water portfolio

# OVERVIEW: DIRECT POTABLE REUSE

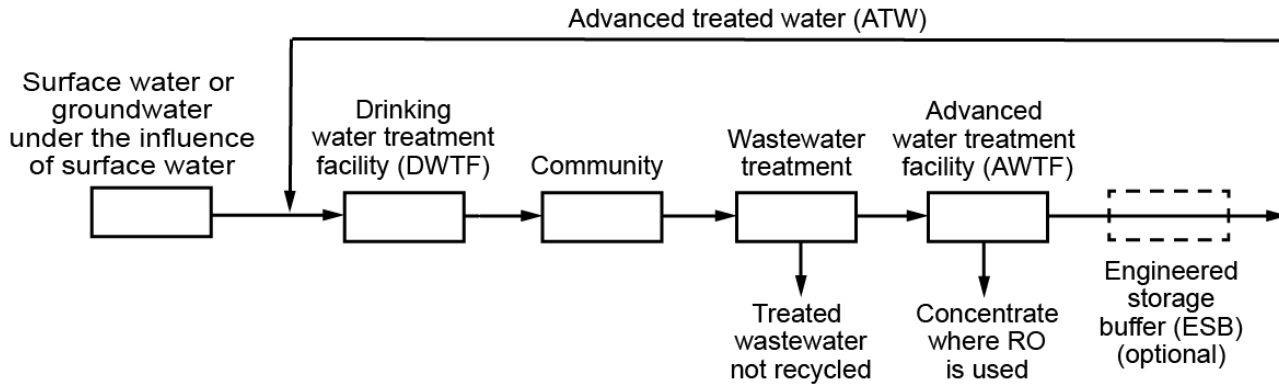

## DPR with *advanced treated water (ATW)*

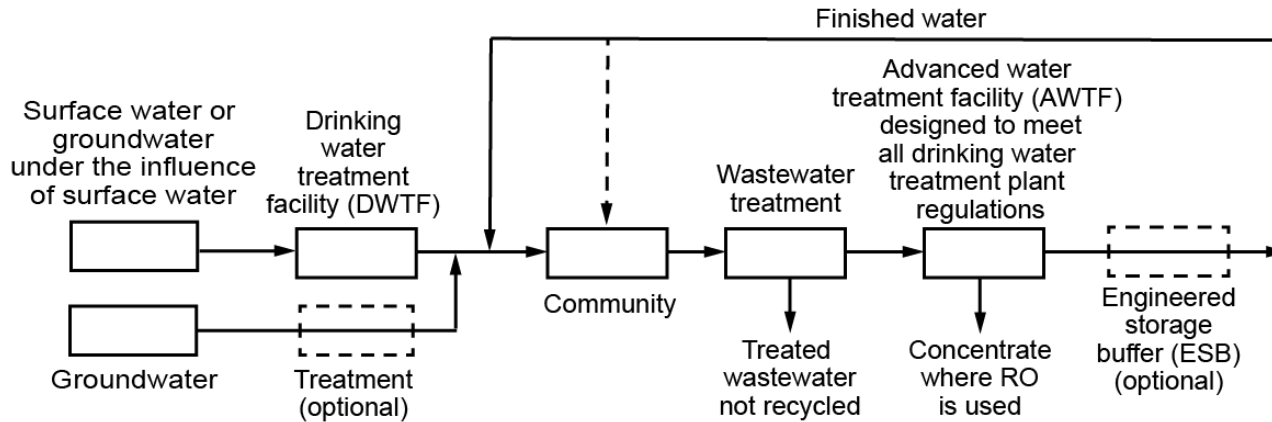

## DPR with *finished water*

# EXAMPLES OF DPR

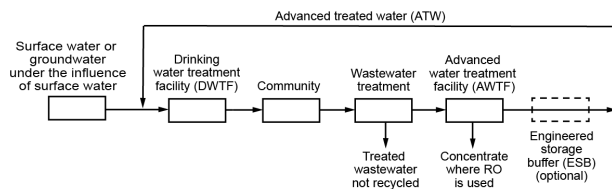

DPR with *advance treated water (ATW)*

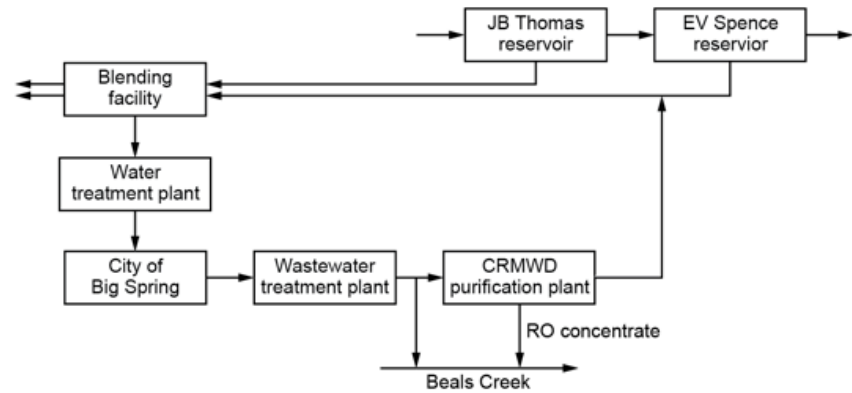

Big Spring, Texas



DPR with *finished water*

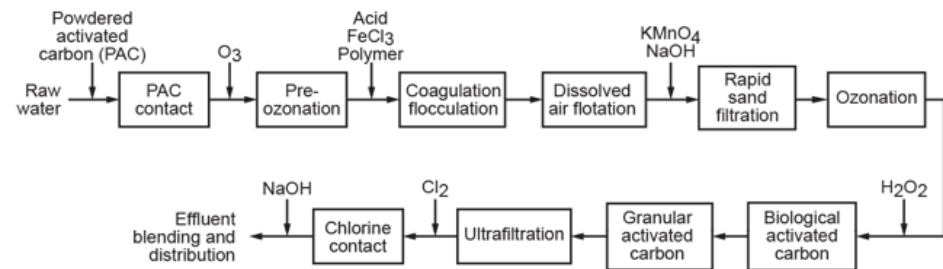

Windhoek, Namibia

# OVERVIEW: INDIRECT POTABLE REUSE

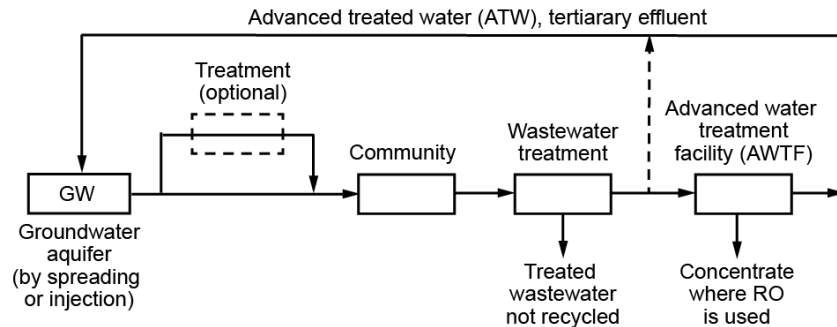

Typical injection well - OCWD

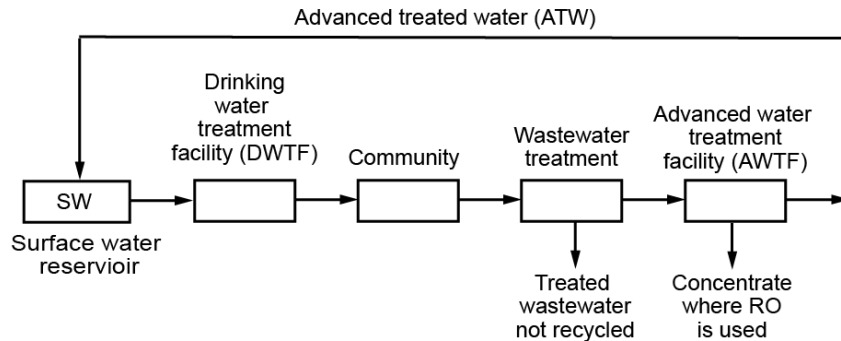

San Vicente reservoir, San Diego, CA

# OVERVIEW: DE FACTO INDIRECT POTABLE REUSE

The downstream use of surface water as a source of drinking water that is subject to upstream wastewater discharges.



Courtesy City of San Diego

# TECHNOLOGIES FOR THE INDIRECT AND DIRECT POTABLE REUSE

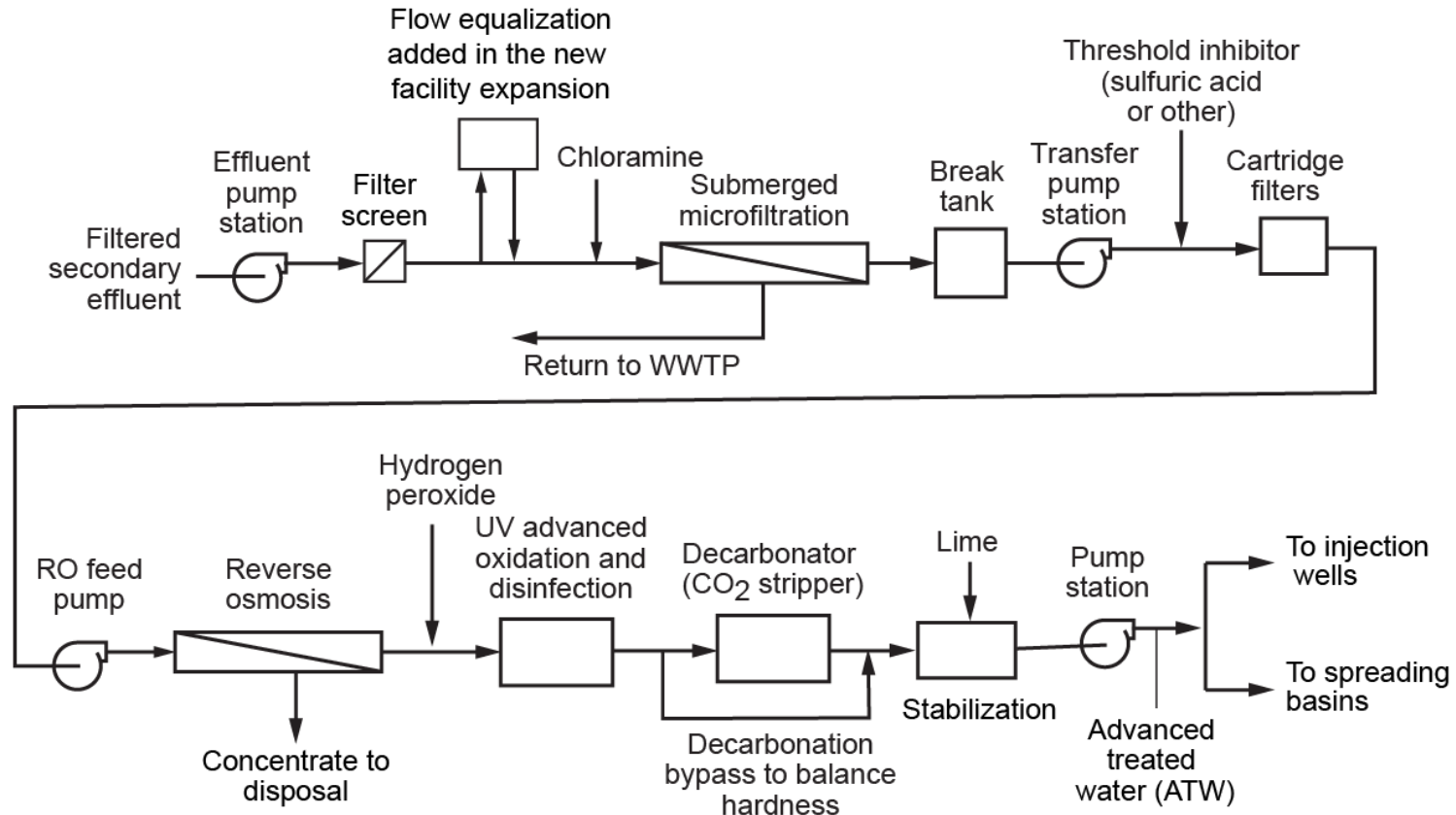

Adapted from OCWD



# WHAT DOES DPR COST?

Supply option	Cost, \$/10 <sup>3</sup> gal (\$/AF)			
	Treatment	Residuals management	RO concentrate management	Conveyance facilities
ATW with RO	2.10 – 2.76 (685 – 900)	0.03 – 0.15 (10 – 50)	0.21 – 2.38 (70 – 775)	0.31 – 3.07 (100 – 1,000)
ATW without RO	1.23 – 2.15 (400 – 700)	0.03 – 0.15 (10 – 50)	n.a.	0.31 – 3.07 (100 – 1,000)
Brackish groundwater desalination (inland)	2.76 – 3.84 (900 – 1,250)	0.06 – 0.31 (20 – 100)	0.21 – 2.15 (70 – 700)	0.92 – 6.14 (300 – 2,000)
Seawater desalination	5.52 – 6.44 (1,800 – 2,100)	0.06 – 0.31 (20 – 100)	0.31 – 0.61 (100 – 200)	1.23 – 9.21 (400 – 3,000)
Retail cost of treated imported surface water	1.23 – 3.99 (400 – 1,300)		n.a.	0.31 – 1.84 (100 – 600)
Water use efficiency, conservation, and use restrictions	1.38 – 2.92 (450 – 950)			0.31 – 1.23 (100 – 400)

 OCWD unsubsidized cost

## DPR ENERGY USAGE

Technology/water source	Energy required			Carbon footprint kg CO <sub>2e</sub> /10 <sup>3</sup> gal
	Range, kWh/10 <sup>3</sup> gal	Typical		
		kWh/10 <sup>3</sup> gal	kWh/m <sup>3</sup>	
Secondary treatment without nutrient removal	1.35 – 1.05	1.25	0.33	0.63
Tertiary treatment with nutrient removal effluent filtration	1.95 – 1.60	1.85	0.49	0.93
Advanced water treatment	3.25 – 3.50	3.30	0.87	1.65
Ocean desalination	9.50 – 14.75	12.00	3.17	6.00
Brackish water desalination	3.10 – 6.20	5.85	1.55	2.93
<u>Interbasin</u> transfer of water, California State Water Project	7.92 – 9.92	9.20	2.43	4.60
<u>Interbasin</u> transfer of water, Colorado River water	6.15 – 7.40	6.15	1.62	3.07
Conventional water treatment	0.30 – 0.40	0.37	0.10	0.19
Membrane-based water treatment	1.00 -1.50	1.25	0.33	0.63

 OCWD actual energy usage

# ***WHERE DOES POTABLE REUSE FIT IN THE WATER PORTFOLIO?***

---

## WATER SOURCES

- Local surface water
- Local groundwater
- Imported water
- **Potable reuse**
- Desalination (brackish and sea water)

## OTHER MEASURES

- Centralized non-potable reuse (e.g., purple pipe)
- Decentralized non-potable reuse (e.g., greywater)
- Conservation and curtailments

## ***SOME HISTORICAL PERSPECTIVE***

---

### Individuals

- A. (Allen) Hazen (1914)
- R. F. Goudey (1930)

Three Important Workshops

Four Useful Documents

***ALLEN HAZEN (1914)***  
***“CLEAN WATER AND HOW TO GET IT”***

---

“Looking at the whole matter as one great engineering problem, it is clear and unmistakably better to purify the water supplies taken from rivers than to purify the sewage before it is discharged into them. It is very much cheaper to do it this way. The volume to be handled is less and the per million gallons the cost of purifying water is much less than the cost of purifying sewage”

***R. F. GOUDEY\* (TALK, October 30, 1930)***  
***RECLAMATION OF TREATED SEWAGE***

---

“Reclamation of sewage in Southern California, is coming whether we like it or not. It is not a. question of sewage disposal, but one directly related to a legitimate increase in water supply.”

\*Sanitary Engineer, Department of Water and Power, Los Angeles, CA. Formally, with the Bureau of Sanitary Engineering, Department of Public Health.

***R. F. GOUDEY (TALK, October 30, 1930)***  
***RECLAMATION OF TREATED SEWAGE***

---

“California likewise need have no fear of eastern criticism, for it is in the east where one finds the most primitive methods of reclamation being practiced with no thought of their being questionable or repulsive. What else is it than reclamation where city after city discharges crude sewage into streams used by cities below for water supply intakes. But it is uncontrolled and unreliable reclamation.”

# GOUDEY'S TREATMENT SYSTEM

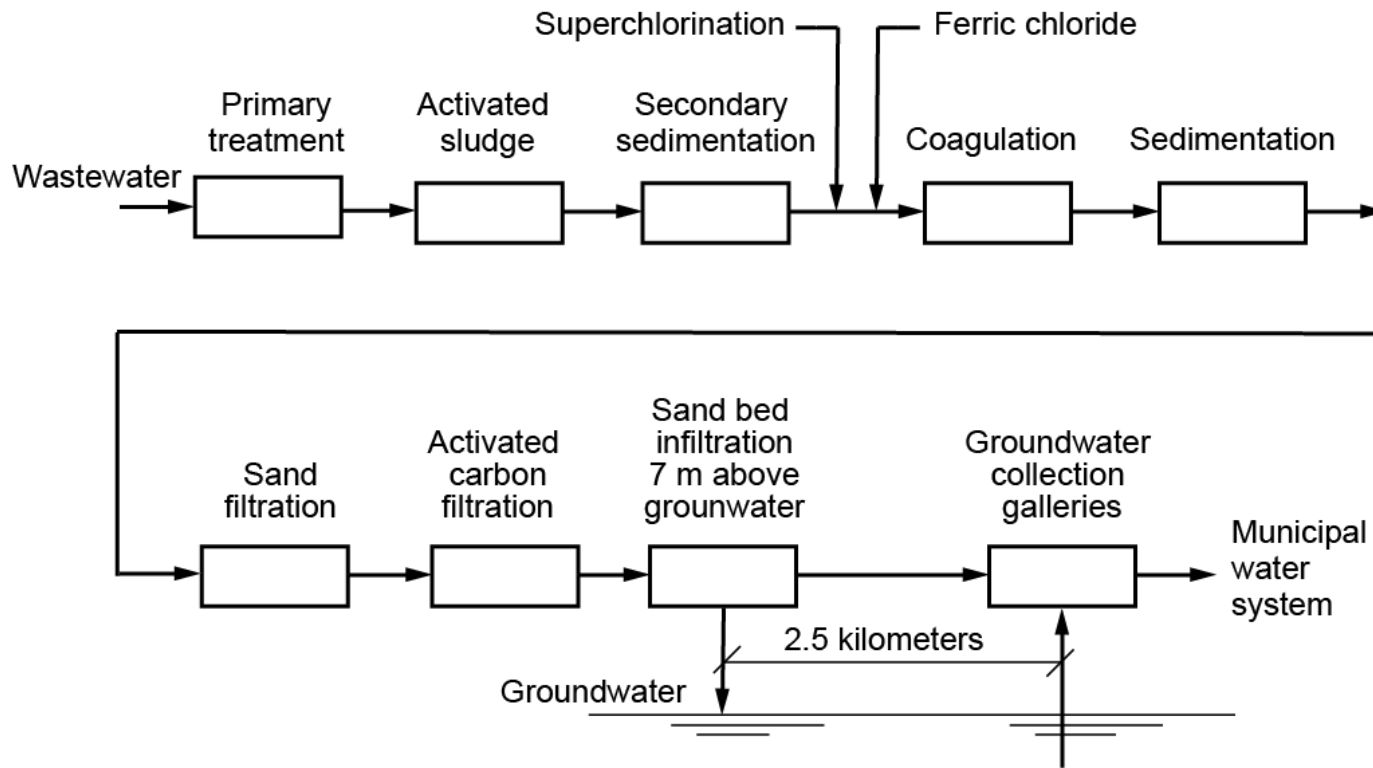

Politicians noted that Los Angeles would have to drink sewage if the bond issue to bring Colorado River water to Los Angeles did not pass



## ***THREE IMPORTANT WORKSHOPS***

---

March, 1975, U.S. EPA Workshop on *Research Needs for the Potable Reuse of Municipal Wastewater*. (Three years after passage of CWA and five years after establishment of EPA)

July, 1980, U.S. EPA Workshop on *Protocol Development: Criteria and Standards for Potable Reuse and Feasible Alternatives*.

April, 2010, WaterReuse California Workshop on *Direct Potable Reuse*. The report *Potable Reuse: A Path Forward* evolved out of the workshop.

## ***FOUR USEFUL DOCUMENTS***

---

NRC (1998) *Issues in Potable Reuse: The Viability of Augmenting Drinking Water Supplies With Reclaimed Water.*

NRC (2012) *Water Reuse: Potential for Expanding the Nation's Water Supply through Reuse of Municipal Wastewater.*

WaterReuse (2011) *Direct Potable Reuse: A Path Forward.*

WaterReuse, AWWA, WEF, and NWRI (2015) *Framework for Direct Potable Reuse.*

## ***ISSUES THAT MAY IMPACT DPR AND IPR***

---

- Suitability of typical wastewater treatment processes for DPR (and IPR)
- Impact of climate change
- Impact of conservation

# ARE ALL SECONDARY WASTEWATER TREATMENT PROCESSES SUITABLE FOR DPR?

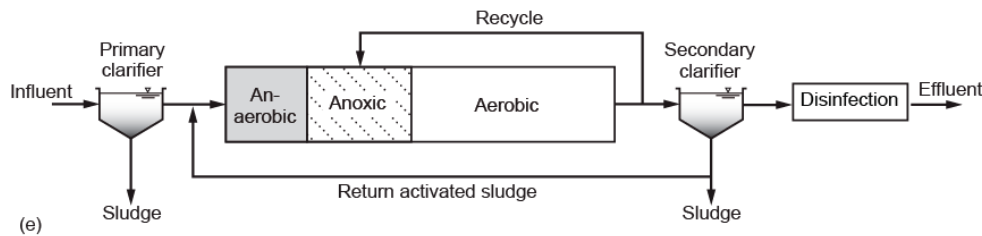
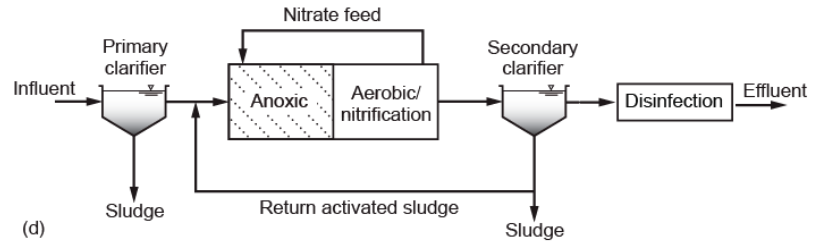
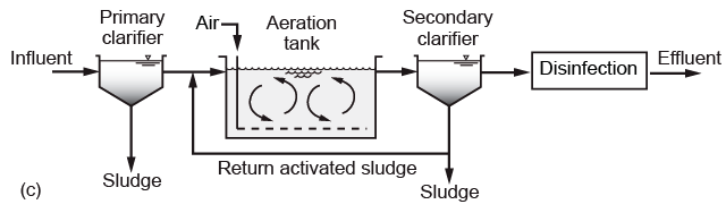
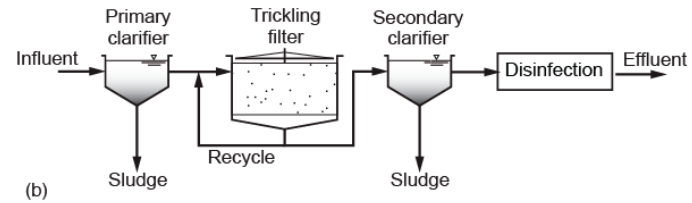
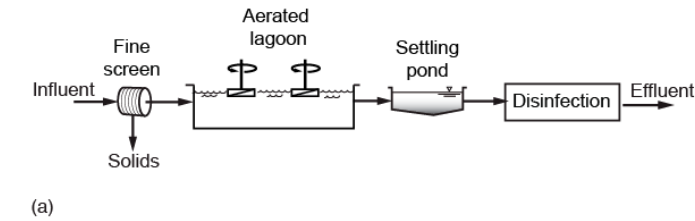

# ARE ALL SECONDARY WASTEWATER TREATMENT PROCESSES SUITABLE FOR DPR?

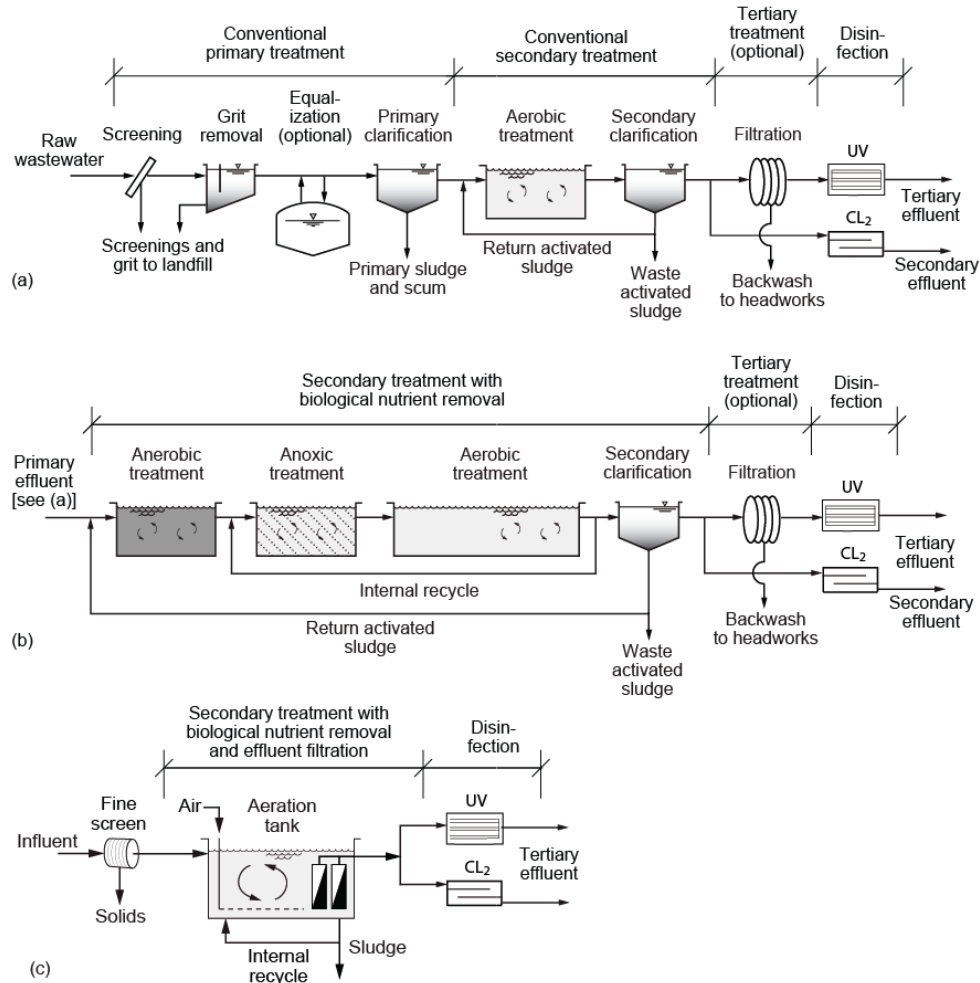

## **DIFFERENCES IN EFFLUENT QUALITY BETWEEN ACCEPTED SECONDARY TREATMENT PROCESSES**

Constituent	Unit	Untreated wastewater	Range of effluent quality after indicated treatment				
			Conventional activated sludge	Conventional activated sludge with filtration	Activated sludge with BNR	Activated sludge with BNR and filtration	Membrane bioreactor
Total suspended solids (TSS)	mg/L	130 - 389	5 - 25	2 - 8	5 - 20	1 - 4	<1 - 5
Turbidity	NTU	80 - 150	2 - 15	1 - 5	1 - 5	1 - 5	<1 - 2
Biochemical oxygen demand (BOD)	mg/L	133 - 400	5 - 25	< 5 - 20	5 - 15	1 - 5	<1 - 5
Chemical oxygen demand (COD)	mg/L	339 - 1016	40 - 80	30 - 70	20 - 40	20 - 30	<10 - 30
Total organic carbon (TOC)	mg/L	109 - 328	20 - 40	15 - 30	10 - 20	1 - 5	<0.5 - 5
Ammonia nitrogen	mg N/L	14 - 41	1 - 10	1 - 6	1 - 3	1 - 2	<1 - 5
Nitrate nitrogen	mg N/L	0 - trace	5 - 30	5 - 30	<2 - 8	1 - 8	<8 <sup>c</sup>
Nitrite nitrogen	mg N/L	0 - trace	0 - trace	0 - trace	0 - trace	0.001 - 0.1	0 - trace
Total nitrogen	mg N/L	23 - 69	15 - 35	15 - 35	3 - 8	2 - 5	<10 <sup>d</sup>
Total phosphorus	mg P/L	3.7 - 11	3 - 10	3 - 8	1 - 2	≤2	<0.3 <sup>d</sup> - 5
Volatile organic compounds (VOCs)	mg/L	<100 - >400	10 - 40	10 - 40	10 - 20	10 - 20	10 - 20
Iron and Manganese	mg/L	1 - 2.5	1 - 1.5	1 - 1.4	1 - 1.5	1 - 1.5	trace
Surfactants	mg/L	4 - 10	0.5 - 2	0.5 - 1.5	0.1 - 1	0.1 - 1	0.1 - 0.5
Totals dissolved solids (TDS)	mg/L	374 - 1121	374 - 1121	374 - 1121	374 - 1121	374 - 1121	374 - 1121
Trace constituents	mg/L	10 - 50	5 to 40	5 - 30	5 - 30	5 - 30	0.5 - 20
Total coliform	No./100 mL	10 <sup>6</sup> - 10 <sup>10</sup>	10 <sup>4</sup> - 10 <sup>5</sup>	10 <sup>3</sup> - 10 <sup>5</sup>	10 <sup>4</sup> - 10 <sup>5</sup>	10 <sup>4</sup> - 10 <sup>5</sup>	<100
Protozoan cysts and oocysts	No./100 mL	10 <sup>1</sup> - 10 <sup>5</sup>	10 <sup>1</sup> - 10 <sup>2</sup>	0 - 10	0 - 10	0 - 1	0 - 1
Viruses	PFU/100 mL	10 <sup>1</sup> - 10 <sup>4</sup>	10 <sup>1</sup> - 10 <sup>3</sup>	10 <sup>1</sup> - 10 <sup>3</sup>	10 <sup>1</sup> - 10 <sup>3</sup>	10 <sup>1</sup> - 10 <sup>3</sup>	10 <sup>0</sup> - 10 <sup>3</sup>

# DESIGN OF BIOLOGICAL TREATMENT PROCESS FOR ALTERNATIVE END POINT

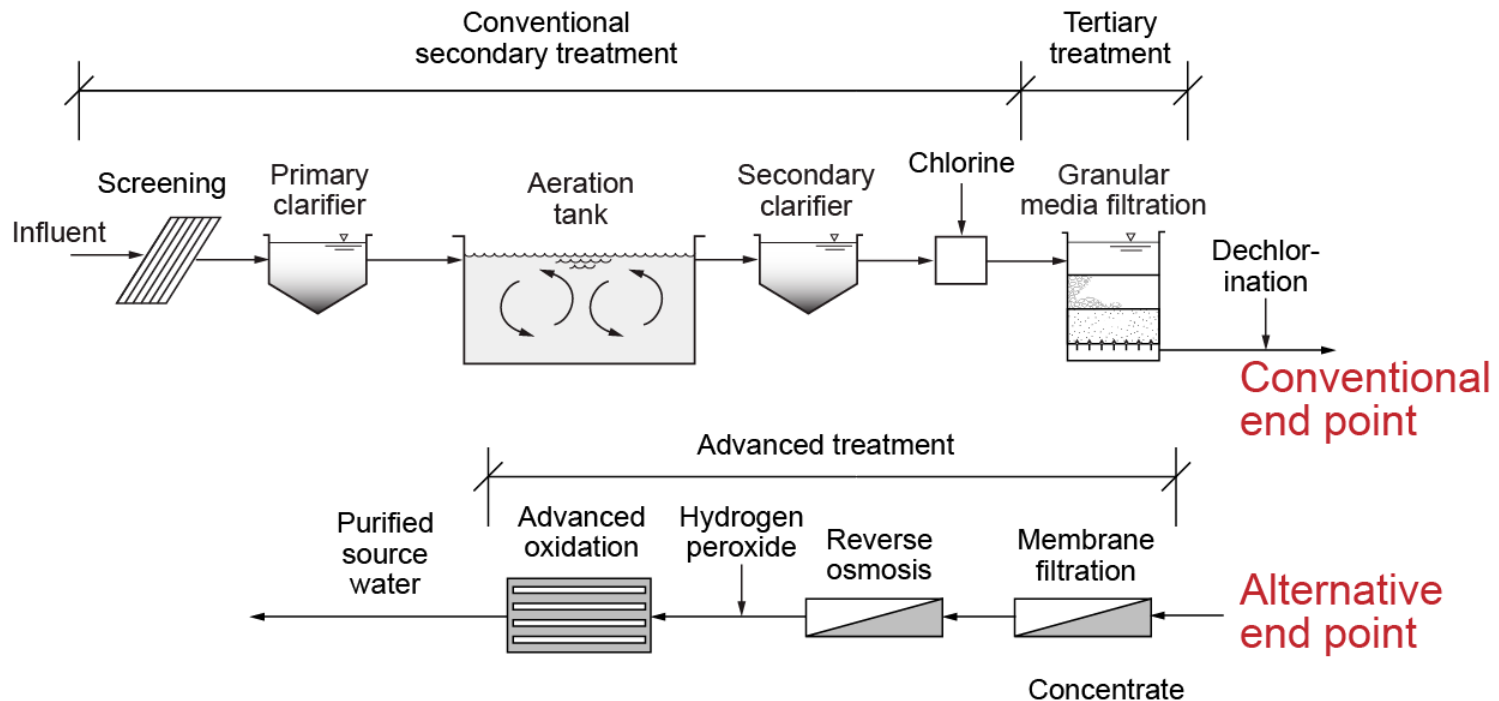

It is time to rethink wastewater treatment

## **MEASURES TO IMPROVE PERFORMANCE AND ENHANCE RELIABILITY OF EXISTING WWTPs**

---

Measure	Value of each measure <sup>a</sup>
Enhanced screening process and possibly fine screening (2 to 6 mm)	Efficiency, reliability
Influent flow and load equalization	Efficiency, water quality, reliability
Elimination (or equalization) of untreated return flows	Water quality, reliability
Operational mode for biological treatment process	Water quality, reliability
Effluent filtration and disinfection	Water quality, reliability
Improved process monitoring	Water quality, reliability

<sup>a</sup>*Efficiency* – increases the overall cost efficiency of operation. *Water quality* – increases the final potable water quality. *Reliability* – increases the overall stability and performance of the treatment train.



# IMPACT OF CLIMATE CHANGE ON RAINFALL INTENSITY AND OPERATION OF WWTPS

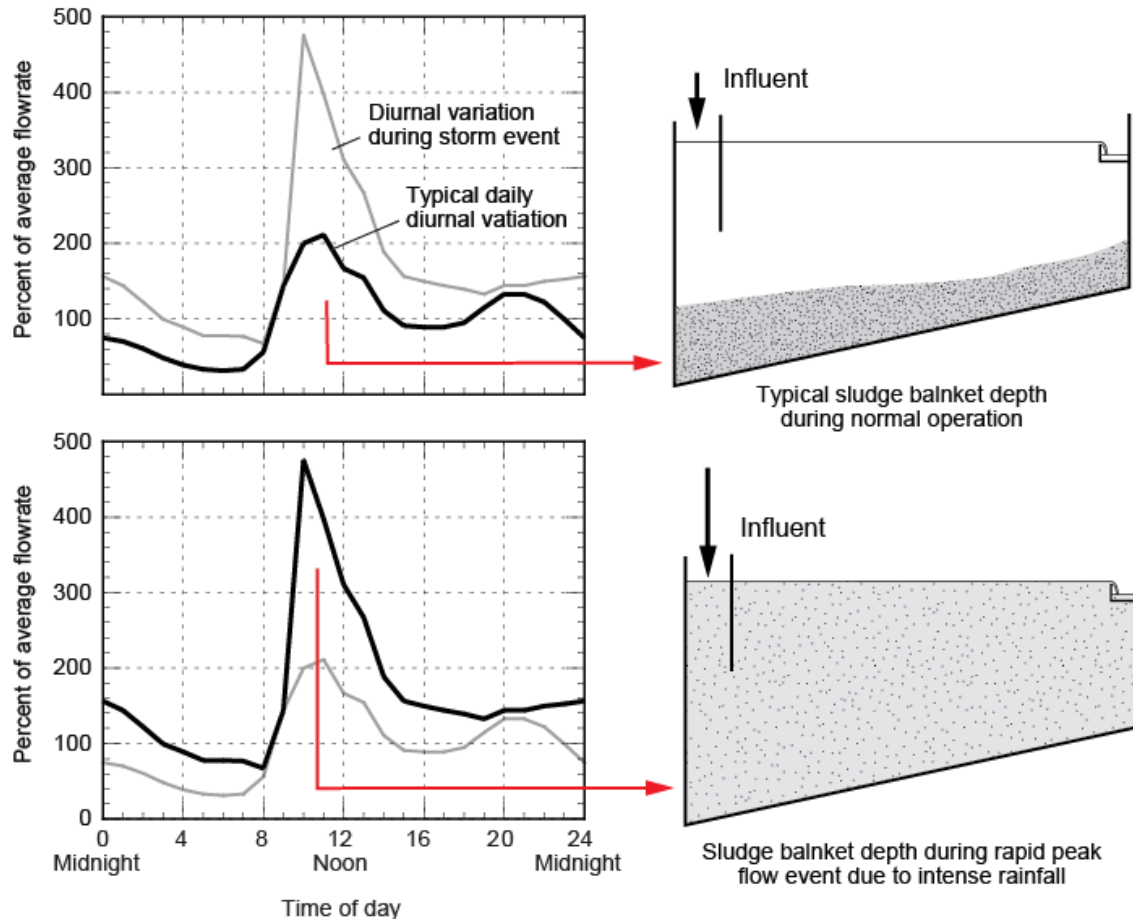

# IMPACT OF CONSERVATION ON OPERATION OF COLLECTION SYSTEMS, WWTPS, AND POTABLE REUSE

---

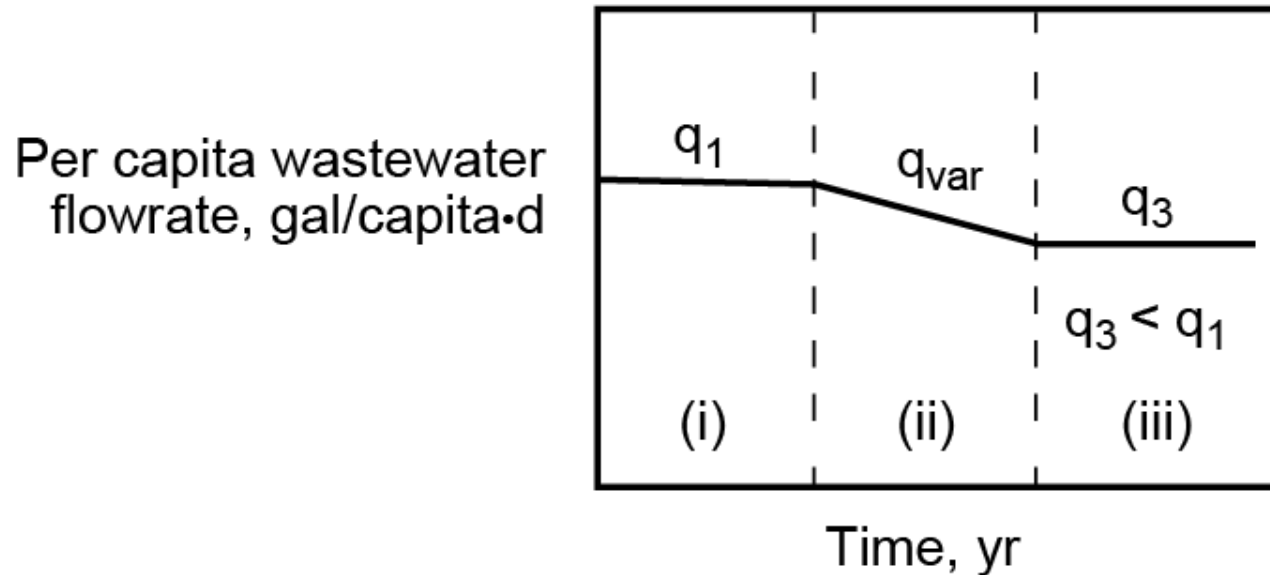

(i) Pre-1992

(ii) Improved water conservation

(iii) Maximum water conservation

## ***CURRENT AND PROJECTED PER CAPITA WATER USE IN THE UNITED STATES***

---

Use	Flow, gal/capita•d					
	2013		2020		2030	
	Range	Typical	Range	Typical	Range	Typical
Domestic						
Indoor use	40 - 80	60	35 - 65	55	30 - 60	45
Outdoor use	16 - 50	35	16 - 50	35	16 - 50	35
Commercial	10 - 75	40	10 - 70	35	10 - 65	30
Public	15 - 25	20	15 - 25	18	15 - 25	15
Loss and waste	15 - 25	20	15 - 25	18	15 - 25	15
Total	96 - 255	175		161		138

84 gal/capita•d in Bay Area to 584 gal/capita•d Northern San Diego

# IMPACT OF WATER CONSERVATION AND DROUGHT: SOLIDS DEPOSITION, H<sub>2</sub>S FORMATION, AND DOWNSTREAM CORROSION DUE TO REDUCED FLOWS

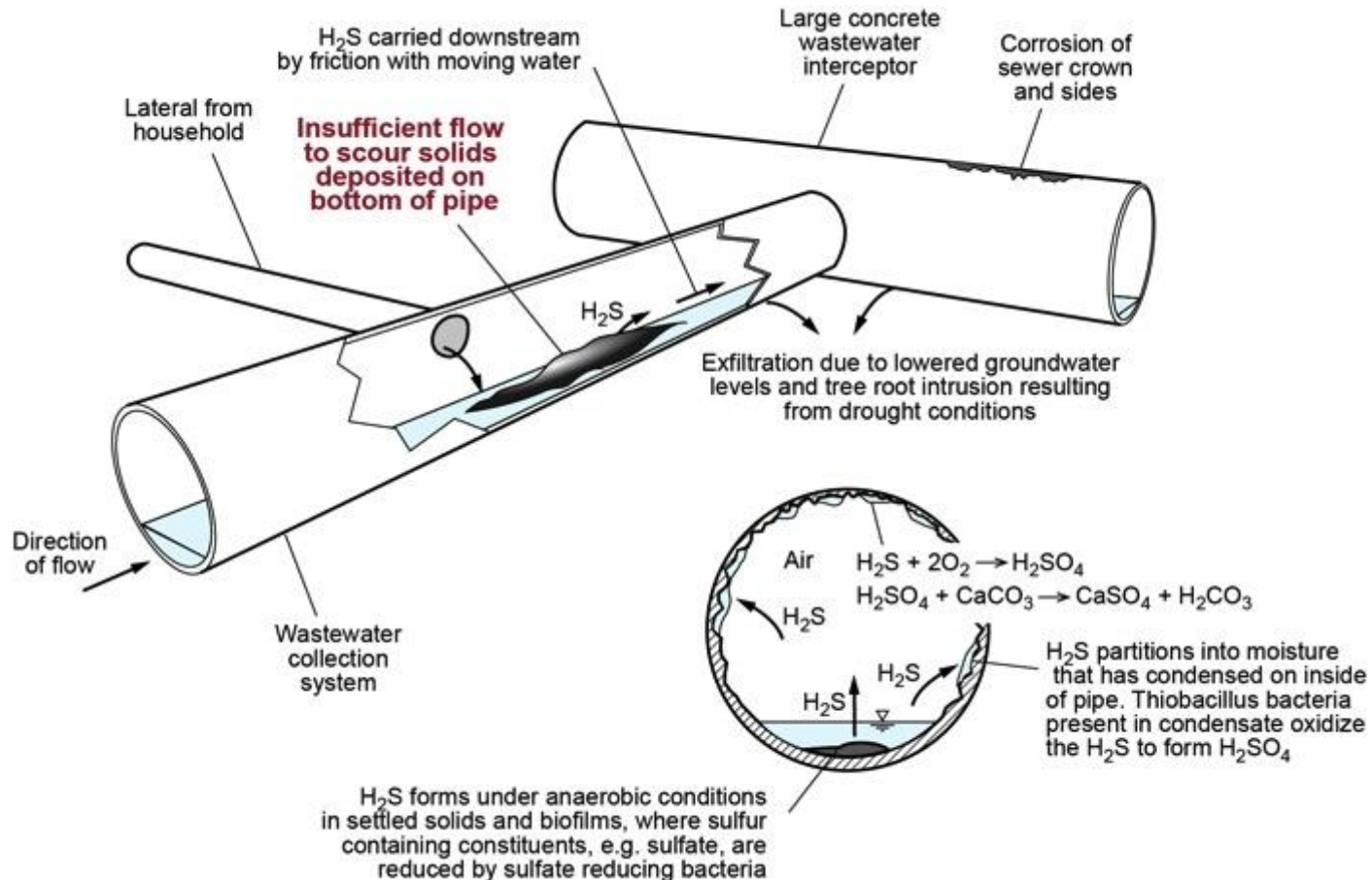

***Impacts of Water Conservation on Treatment Plant Capacity (Approximately 30 Percent Excess Tankage Available, but not Distributed Uniformly)***

---

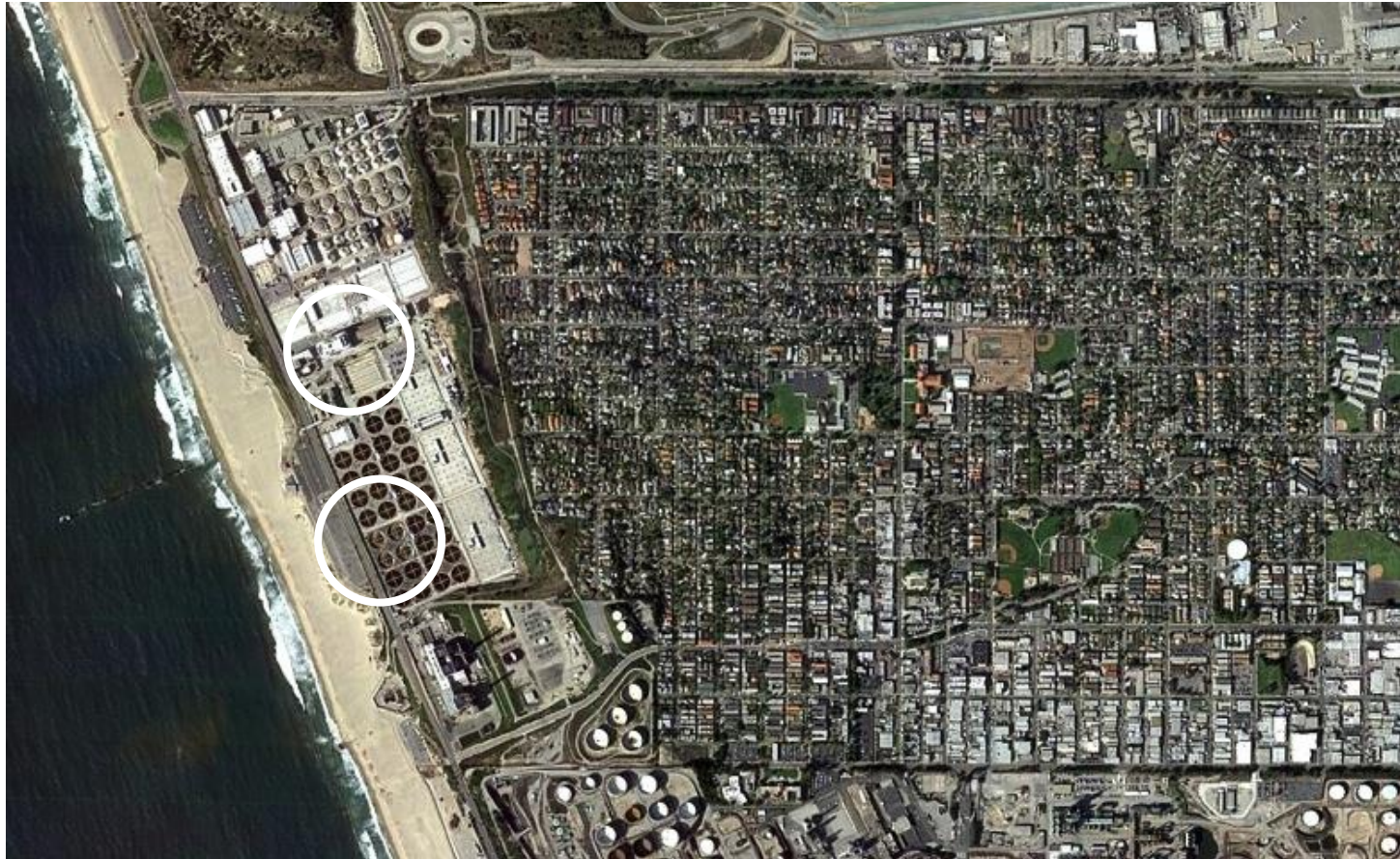

## ***THE FUTURE***

---

- Lets move ahead with DPR
- Regulatory needs
- Technology needs
- Public outreach needs
- Role of the DPR Framework Document  
(Presented and discussed in following presentation)

# LETS MOVE AHEAD WITH DPR

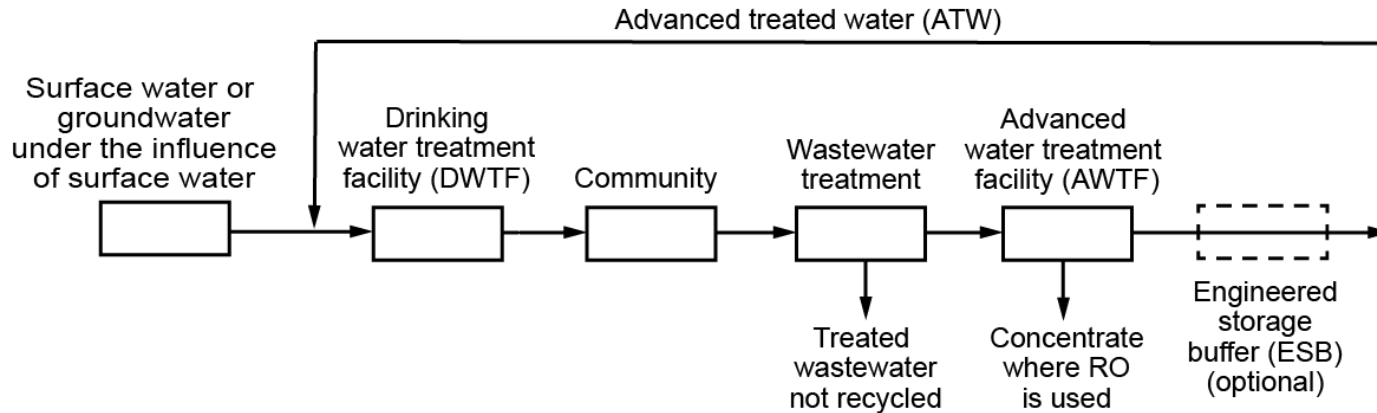

## Focus on DPR with *advanced treated water (ATW)*

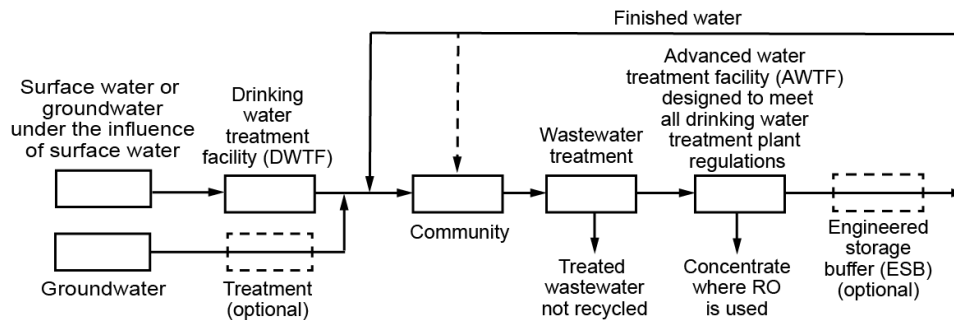

Continue to work on DPR with *finished water*

## ***FUTURE REGULATORY NEEDS***

---

- National guidelines and regulations
- National framework for integrating the CWA and SDWA for permitting DPR projects
- Consideration of advanced treated water (ATW) as a third water source (i.e., surface water, groundwater, and ATW)
- Development of consistent training programs
- Operator training and certification?



## ***FUTURE TECHNOLOGY NEEDS***

---

- Better understanding of treatment processes to reduce overly conservative designs
- Improved understanding of relationship between multiple barriers
- Improved monitoring methods to capture failure and other events of interest
- Full-scale demonstration of advanced water treatment facility without reverse osmosis
- Development of technologies for satellite and decentralized AWTFs

## ***FUTURE PUBLIC OUTREACH***

---

- We already have a lot of tools
- Develop appropriate and consistent terminology
- Clear message about potable reuse—  
what it is and what it is not.

# ***WASTEWATER MANAGEMENT IN THE 21<sup>ST</sup> CENTURY***

---

## ***A PARADIGM SHIFT***

Wastewater is a renewable recoverable source of **potable water, resources, and energy**

## ***A FUNDAMENTAL QUESTION***

What is the optimal use of the carbon in wastewater—nutrient removal, product recovery, and/or energy recovery?

***THANK YOU  
FOR LISTENING***