

WATER DIVERSION MANUAL AND BEST MANAGEMENT PRACTICES

for Routine Maintenance and Emergency Repair of Soft-Bottom and Concrete-Lined Channels

Prepared by:

**County of Los Angeles Department of Public Works
Los Angeles County Flood Control District
900 S. Fremont Avenue
Alhambra, CA 91803**

Prepared for:

**Los Angeles Regional Water Quality Control Board
320 W. 4th Street, Suite 200
Los Angeles, CA 90013**

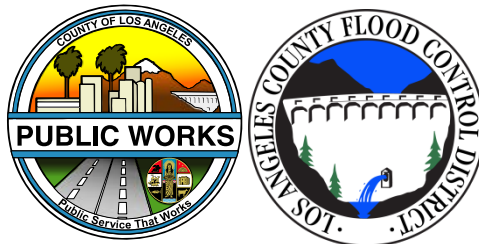

July 2016

TABLE OF CONTENTS

1.0	BACKGROUND	1-1
1.1	Purpose and Need	1-1
1.2	Regulatory Summary	1-1
	1.2.1 Federal Agencies	1-1
	1.2.2 State Agencies	1-2
	1.2.3 Local Agencies	1-2
1.3	Objective.....	1-3
1.4	Submittal Requirements	1-3
1.5	Updates	1-4
2.0	FACILITIES AND MAINTENANCE ACTIVITIES.....	2-1
2.1	Soft Bottom Channels	2-1
	2.1.1 Routine/Preventive Maintenance and Repair.....	2-1
	2.1.2 Emergency Repair.....	2-3
2.2	Concrete-Lined Channels	2-3
	2.2.1 Routine/Preventive Maintenance and Repair.....	2-3
	2.2.2 Emergency Repair.....	2-4
3.0	DIVERSION METHODS AND COMPONENTS	3-1
3.1	Containment Options	3-2
3.2	Conveyance Options.....	3-2
3.3	Diversion Scenarios	3-2
3.4	Project Site Access	3-15
3.5	Sediment Management.....	3-30
3.6	Sensitive Species Considerations	3-38
4.0	APPROACH TO WATER DIVERSION	4-1
4.1	Planning.....	4-1
4.2	Selection of Diversion Methods.....	4-2
4.3	Selection of BMPs.....	4-4
4.4	Water Quality Monitoring.....	4-5
5.0	BEST MANAGEMENT PRACTICES AND PROCEDURES	5-1
5.1	Erosion Control	5-1
5.2	Sediment Control	5-2
5.3	Wind Erosion Control	5-3
5.4	Non-Stormwater Management Control.....	5-3
5.5	Waste Management and Materials Pollution Control.....	5-3
5.6	General Stormwater Management	Error! Bookmark not defined.
6.0	REFERENCES.....	6-1

TABLES

Table 3-1 Containment Barrier Types	3-1
Table 3-2 Barrier Applicability	3-4
Table 3-3 Temporary Site Access Methods	3-16
Table 3-4 Reaches with Potential for Sensitive Species	3-38
Table 3-5 Sensitive Species Protection Measures	3-41
Table 4-1 Barrier Selection.....	4-3
Table 4-2 Conveyance Selection	4-4
Table 4-3 BMP Applicability for Water Division	4-6
Table 5-1 Erosion Control BMPs.....	5-2
Table 5-2 Sediment Control BMPs.....	5-2
Table 5-3 Wind Erosion BMP.....	5-3
Table 5-4 Non-Stormwater Management BMPs.....	5-3
Table 5-5 Waste Management Control BMP	5-4
Table 5-6 General Stormwater Management BMP	5-4

FIGURES

Figure 2-1 Flood Control Facility Coverage.....	2-2
Figure 3-1 Scenario C1	3-5
Figure 3-2 Scenario C2	3-7
Figure 3-3 Scenario C3	3-9
Figure 3-4 Scenario C4	3-11
Figure 3-5 Scenario C5	3-13
Figure 3-6 Scenario S1	3-17
Figure 3-7 Scenario S2	3-19
Figure 3-8 Scenario S3	3-21
Figure 3-9 Scenario S4	3-23
Figure 3-10 Scenario S5	3-25
Figure 3-11 Scenario S6	3-27
Figure 3-12 Construction Mat.....	3-31
Figure 3-13 Crane Lift	3-32
Figure 3-14 Floating Platform.....	3-33
Figure 3-15 Long-Reach Equipment	3-34

Figure 3-16 Temporary Bridging 3-35
Figure 3-17 Standing Water Access Above Diversion..... 3-36
Figure 3-18 Standing Water Access Below Diversion 3-37

APPENDICES

- Appendix A Applicable Best Management Practices
- Appendix B Project Water Diversion Plan Form
- Appendix C Soft-Bottom Channel Reaches
- Appendix D Concrete-Lined Channel Reaches

ACRONYMS AND ABBREVIATIONS

BMP	Best Management Practice
CDFW	California Department of Fish and Wildlife
LACDPW	Los Angeles County Department of Public Works
LACFCD	Los Angeles County Flood Control District
Manual	Water Diversion Manual
RWQCB	Regional Water Quality Control Board
SAA	Streambed Alteration Agreement
USFWS	U.S. Fish and Wildlife Service
WDR	Waste Discharge Requirements

1.0 BACKGROUND

The Los Angeles County Flood Control District (LACFCD) has prepared this Water Diversion Manual (Manual) to provide standard procedures for planning, selecting, and implementing water diversion methods within its flood control system. The Manual includes background information (Section 1), descriptions of the types of facilities and associated maintenance activities (Section 2), descriptions of specific diversion methods (Section 3), a description of the considerations for conducting water diversion with alternate conveyance options (Section 4) and a presentation of the most common and appropriate water diversion best management practices (BMPs) (Section 5).

1.1 PURPOSE AND NEED

LACFCD must perform regular maintenance and emergency repair activities to the flood control system it manages within the three major (Los Angeles River, San Gabriel River, and Santa Clara River) and multiple smaller watersheds. Occasionally the Los Angeles County Department of Public Works (LACDPW) also conducts bridge projects that can require water diversion. During such maintenance and repair work, or bridge projects, potential impacts to water quality and habitat (aquatic and riparian) are avoided or kept to a minimum wherever practicable. An example of impact minimization includes scheduling routine maintenance work during the dry season to reduce the potential of work-related debris from entering a flowing stream. However, emergency repairs cannot always benefit from this type of scheduled avoidance and other measures such as implementation of a water diversion and associated BMPs must be employed to provide adequate protection to water quality and habitat.

1.2 REGULATORY SUMMARY

A large portion of maintenance activities are conducted within concrete and soft bottom channels that are subject to state, federal, and/or local regulations. The applicable regulatory authorities and permitting requirements that are relevant to maintenance activities within the channels are discussed below.

1.2.1 Federal Agencies

United States Army Corps of Engineers

Under the Clean Water Act Section 404, dredge and fill activities require permitting from the United States Army Corps of Engineers. LACFCD is in compliance with the requirements of Section 404 for maintenance of its existing flood control facilities.

U.S. Fish and Wildlife Service / National Marine Fisheries Service

Any project permitted under a Clean Water Act Section 404 is potentially subject to the requirements of the Federal Endangered Species Act. Should actions taken for a project be determined to have the potential to adversely affect listed endangered species or designated critical habitats (directly or indirectly), consultation with the U.S. Fish and

Wildlife Service (USFWS) would be required. The Section 404 permit review process and USFWS consultation typically occur concurrently to one another, and the USFWS would typically render a Biological Opinion about special handling of project activities for species protection.

1.2.2 State Agencies

Regional Water Quality Control Board

The Regional Water Quality Control Board (RWQCB) Los Angeles Region regulates maintenance activities within waterways affected by LACFCD's maintenance activities through the Clean Water Act Section 401, which requires the issuance of a Water Quality Certification by RWQCB for such activities. Additionally, Water Code section 13263 requires RWQCB to prescribe Waste Discharge Requirements (WDRs) for any proposed or existing discharge to surface waters. The WDRs describe the affected waterway reaches, permitted activities within the reaches, agency notification protocol, BMPs, water quality monitoring and reporting requirements, and other provisions pertaining to activities undertaken pursuant to LACFCD's Maintenance Plan.

California Department of Fish and Wildlife

California Department of Fish and Wildlife (CDFW) (formerly California Department of Fish and Game) administers the State of California Fish and Game Code, Section 1600, which requires the agency to issue a Streambed Alteration Agreement (SAA) for channel clearing activities. A SAA Memorandum of Understanding (5-076-99) was entered into by LACFCD and California Department of Fish and Game in 1999 in connection with LACFCD's 1999 Maintenance Plan.

1.2.3 Local Agencies

Los Angeles County Flood Control District

The Los Angeles County Flood Control Act of 1915 authorizes LACFCD to provide flood protection through a network of channels and other infrastructures located throughout Los Angeles County to enhance public safety. This requires LACFCD to perform maintenance activities in the channels to ensure adequate channel capacity in order to reduce the risk of loss of life or property that could otherwise result from flooding during large storm events. The LACFCD must procure all necessary permits from the relevant regulatory agencies discussed in the sections above and fulfill all permit conditions and requirements.

Los Angeles County Department of Public Works

LACDPW directed the development of, or participated in the development of Master Plans for the Los Angeles River, San Gabriel River, Santa Clara River, Malibu Creek, and Dominguez Channel watersheds. These Master Plans contain objectives and plans for environmental and habitat enhancement in addition to flood control.

1.3 OBJECTIVE

This Manual is intended to provide guidance for the selection of the appropriate water diversion structure when the required maintenance activity necessitates work to be performed in a channel when flowing water is present, such as for routine channel maintenance or emergency repairs. In addition, the Manual provides guidelines for the selection of appropriate and necessary BMPs to implement before work is performed. The objectives of the Manual are as follows:

- 1) Define normal and approved water diversion methods to be used given specified situations and conditions.
- 2) Establish process for a water diversion project development, a site-specific Project Water Diversion Plan.
- 3) Establish a framework for the selection of appropriate BMPs for a specific set of circumstances.
- 4) Provide well-defined, clearly presented, and understandable BMP implementation procedures and associated schematics.
- 5) Establish a basis for the approach to water diversion for LACDPW bridge rehabilitation, maintenance, and replacement projects.

The first objective is addressed in Section 3 of this Manual (Diversion Methods and Components). The second is covered in Section 4 (Approach to Water Diversion). The third objective is addressed in Section 5 (Best Management Practices and Procedures). The fourth objective is achieved with the presentation of standardized BMP descriptions in Appendix A as prepared by the California Stormwater Quality Association and made available to public agencies in a series of Stormwater Best Management Practice Handbooks (CASQA 2003a, 2003b, and 2003c). The fifth and final objective is ancillary to the primary purpose of this Manual, and is addressed by the document as a whole.

1.4 SUBMITTAL REQUIREMENTS

LACFCD shall submit a plan for any water diversion project that may significantly deviate from the approved Water Diversion Plans included in this Manual. The plan shall be submitted to the Executive Officer of the RWQCB-Los Angeles District for review and approval within 30 days prior to commencement of the project, and shall include the form in Appendix B which contains the following:

- 1) Project Information such as project name, location, and type
- 2) A description of the project including a short narrative that explains:
 - a. The flow of water through the diversion (diversion method)
 - b. Planning decisions (such as if water diversion has been conducted in the project reach previously, and how that information was used in planning for this project)
 - c. List of sensitive species identified at the project (if any)

- 3) Project schedule including:
 - a. Start and end dates/times
 - b. Water quality monitoring start and end dates/times
 - c. Diversion start and expected completion dateMore detailed schedule shall be provided for complex projects that have multiple phases or diversion components
- 4) Diversion method to be used
- 5) If structures are to be built such as a containment area, include the structure's configuration and construction materials
- 6) Best Management Practices to be used to control erosion, sediment, etc.
- 7) A project plan or a sketch (8.5" x 11" or 11" x 17")
- 8) Contingency measures to address the need for regulation of flow discharge rates and/or direction of flows to protect beneficial uses downstream of the diversion
- 9) If surface flow is present, then upstream and downstream monitoring shall be implemented for the following: pH, temperature, dissolved oxygen, turbidity, and total suspended solids (TSS). In certain circumstances additional sampling locations may be needed, based on length of reach.

This plan shall be submitted to RWQCB prior to any surface water diversions taking place. Non response from the RWQCB shall be construed as no comments on the proposed alternative plan for that project. As such, the project will commence using the submitted plan.

1.5 UPDATES

To ensure continued compliance with its permit requirements, LACFCD shall review and update the Manual every two years. Any modifications made will be submitted to the executive officer of the RWQCB-Los Angeles District, the Unit Chief, and the 401 Program Lead for review and approval via the RWQCB's Online Submittal email address: losangeles@waterboards.ca.gov.

The RWQCB shall provide their comments and/or approval to the changes within 90 days upon email receipt of the updated Manual. If LACFCD does not receive comments from RWQCB within 90 days, LACFCD will incorporate the comments and submit the final revised Manual to the RWQCB, also via email, within 60 days.

2.0 FACILITIES AND MAINTENANCE ACTIVITIES

The facilities operated and maintained by the LACFCD include a broad range of covered and open water conveyance and retention/detention structures. The Manual is concerned only with open surface-water conveyance concrete-lined and soft-bottom channels. The flood protection system under the purview of LACFCD encompasses three major watersheds (Los Angeles River, San Gabriel River, and the Santa Clara River), along with numerous smaller watersheds that drain to the Pacific Ocean (see Figure 2-1). The smaller watersheds include: the Malibu Creek, Ballona Creek, and Dominguez Channel/L. A. Harbor watersheds.

Within these watersheds, the LACFCD maintains over 100 soft-bottom channel reaches that when combined, cover approximately 340,000 feet of channel length. The number of individual concrete-lined channel reaches maintained by LACFCD is currently over 280. The combined channel length of these concrete channels is approximately 2.2 million linear feet.

2.1 SOFT BOTTOM CHANNELS

The soft-bottom channel reaches maintained by the LACFCD are organized by watershed, as shown in Figure 2-1. Tables C-1 and C-2 provide information on each soft-bottom channel facility and are included in Appendix C. Within-channel activities can be characterized as routine or preventive (allowing scheduling flexibility) or emergency (requiring immediate or rapid turn-around scheduling).







2.1.1 Routine/Preventive Maintenance and Repair

Routine maintenance and repair work encompasses non-emergency activities and, therefore, can be scheduled during dry periods of the year when rainfall generally does not occur and surface water flow in the soft bottom reaches is at its lowest levels for the year. For many channels, there is no surface water present or the channel low flows are not impacted when maintenance is performed. As a result, for those channels, there is no need for a surface water diversion. Routine or preventive maintenance and repair includes activities such as:

- **Vegetation Removal.** Without regular maintenance actions, unwanted/non-native/invasive vegetation can establish itself within the channel bottom and limit the capacity of the channel to handle flood flows. Within the restrictions of existing permits, vegetation is removed or cut back to increase channel capacity.
- **Sediment Removal.** Depending on local flow conditions, sediment and debris deposits can accumulate within the channel restricting flows and causing unsightly or unsafe conditions. Within the restrictions of existing permits, sediment and debris are removed to increase channel capacity.



Legend

-  Los Angeles County
-  River/Stream Channel
-  Watershed Boundary
- Flood Maintenance Yards**
-  E
-  S
-  W

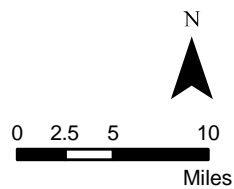

**Figure 2-1
Flood Control Facility Coverage**

**Los Angeles County
Flood Control District (LACFCD)**

- **Invert Repairs.** Local scour and/or deposition can create unstable flow conditions and potentially impact adjacent structures (e.g. where soft-bottom channels transition to concrete-lined channels). Repair of soft-bottom channel sections is accomplished with addition of stabilizing materials and re-grading/adjustment of channel cross sections.

2.1.2 Emergency Repair

Emergency repairs to soft-bottom channels generally do not have scheduling flexibility and must be conducted on short notice and potentially during the rainy season. Therefore, water diversion can often be required as part of an emergency repair project, which could include activities like the following:

- **Undercut Levees.** Structural stability of levees is critical to their flood protection performance. Erosion of levees, particularly at the toe, can jeopardize the integrity of the levee and needs quick repair. Required earthwork often uses heavy equipment to repair eroded locations, replace levee material, compact the added materials, and place any surface protection.
- **Rip-Rap or Engineered Slopes.** Repair of engineered slopes and/or repair of rip-rap protection on levees or other channel banks will involve earthwork and heavy equipment. Depending on the location of this work, it can easily be considered as emergency work.
- **Drop Structures.** Repair of drop structures usually involves some amount of concrete demolition and removal, followed by concrete replacement. If a damaged drop structure is causing ponding, the repair work may be considered an emergency.
- **Outlets/Outlet Structures.** Storm drain outlets commonly experience erosion which can undermine the drain outlet and eventually threaten the integrity of the drain and overlying surfaces, like roadways. Depending on location, this type of repair work can involve earthwork with heavy equipment and even demolition and replacement of concrete.
- **Invert Access Ramps.** Access is an important consideration for properly maintaining flood facilities, so damaged access ramps are a concern that may require emergency repair. Repair work will most likely involve earthwork and heavy equipment.

2.2 CONCRETE-LINED CHANNELS

Table D-1 (Appendix D) provides information on each facility. Within-channel activities can be characterized as routine or preventive (allowing for flexible scheduling) or emergency (requiring immediate or rapid turn-around scheduling).

2.2.1 Routine/Preventive Maintenance and Repair

Routine maintenance and repair work in a concrete-lined channel can be scheduled during dry periods of the year when rainfall generally does not occur and channel flow is

at its lowest levels. In many channels this means no surface water present when maintenance is performed. As a result, for those channels, there is no need for a surface water diversion. Routine/preventive maintenance and repair includes activities such as:

- **Vegetation Removal.** Vegetation can also accumulate in concrete-lined channels restricting flow and increasing the potential for flooding. Within the restrictions of existing permits, vegetation is removed or cut back to increase channel capacity.
- **Sediment Removal.** Within the restrictions of existing permits, sediment and debris are removed to increase channel capacity.
- **Invert Repairs.** Damage to concrete lining on channel bottoms creates unstable conditions for adjoining channel sections and creates potential for additional damage to the concrete lining on the channel bottom or sides. Repair of damaged concrete is accomplished to return the channel to design conditions.

2.2.2 Emergency Repair

Emergency repairs to concrete-lined channels also do not often allow scheduling flexibility and potentially are conducted during the rainy season. As a result, water diversion is a likely part of an emergency repair project, which could include activities like the following in concrete-lined channels:

- **Undercut Levees.** In addition to earthwork, levee repair in concrete-lined channel reaches will also involve concrete demolition and replacement.
- **Drop Structures.** Repair of drop structures in concrete channel reaches generally involves concrete demolition and removal, followed by concrete replacement. If a damaged drop structure is causing nuisance ponding, the repair work may be considered an emergency.
- **Invert Access Ramps.** Access is an important aspect of maintaining flood facilities, so a damaged access ramp is a concern that may require emergency repairs. Repair work will often include earthwork and heavy equipment in addition to concrete demolition and replacement.
- **Outlets/Outlet Structures.** Storm drain outlets in concrete-lined channel reaches which experience erosion can require a significant amount of concrete demolition and replacement. Depending on location, repair work of this type can be considered an emergency.
- **Channel Walls.** Repairing a wall in a concrete-lined channel reach can be a significant project, and most likely be considered an emergency situation. In addition to concrete demolition and replacement, there can be a major earthwork component to prepare the damaged wall location for the new concrete pour.

3.0 DIVERSION METHODS AND COMPONENTS

Water diversion is used to isolate channel sections from flowing or standing surface waters during performance of in-stream maintenance work, routine repair work, or emergency repair work. Diversion can be used to isolate part or all of a channel reach depending on the project objectives. It may require completely isolating flows by bypassing the channel reach to allow dewatering of work areas, or it may require isolating only a portion of the channel reach while allowing a parallel portion of the channel to continue conveying surface water flow past the work area. In its simplest construct, a diversion will have a flow containment or barrier component and a by-pass conveyance component. Containment can be accomplished using a variety of methods or structures (see Table 3-1). Available conveyance options can be resolved into three general types, contained (conveyance flows in a pipe or flexible hose), new open channel (flows within a specifically constructed flume, ditch, or other open channel that more than likely is not located within the existing channel), or existing open channel (flows in a restricted portion of the existing channel used for conveyance while the remainder of the channel is kept dry for maintenance or repair activities).

Table 3-1
Containment Barrier Types

Barrier Type	Details
Earthen Berm	A temporary berm or shallow ridge of compacted soil that is placed to form a barrier to prevent surface water access to a specific area (work area). Potential for loss of berm material causing increases in turbidity must be balanced against design considerations.
Sand/Gravel Bag Berm	Geotextile fabric bags are filled with sand or gravel, laid end to end to form a barrier that prevents surface water from reaching a specific area (work area). Multiple levels of bags can be used and plastic sheeting incorporated into the barrier to help prevent water seepage through the barrier.
Aqua-Barrier	Inflatable barriers made from laminated industrial grade vinyl coated polyester and available in a variety of sizes (lengths and heights) are used to prevent surface water from reaching a work area.
Portadam™	A free-standing superstructure (usually steel) supporting a nylon reinforced vinyl liner that acts as a surface-water barrier preventing standing water in the work area when used in conjunction with active dewatering and seepage control.
K-Rails	K-Rails (temporary concrete barriers) come in 10-foot and 20-foot long sections with heights of 36 inches to 42 inches and a weight of up to 8,000 lbs. K-Rails can be used in a single level or in multiple levels in conjunction with gravel or sand bags and plastic sheeting to form a barrier to prevent surface water from reaching the work area.
Sheet-Pile	Steel sheet piles (long structural sections with a vertical interlocking system) come in various sizes and are used to create a continuous wall to exclude water from work areas.

3.1 CONTAINMENT OPTIONS

Most of the barrier types described in Table 3-1 can be used to either completely block flow across the entire channel (transverse barrier) or to isolate part of the channel to convey the flow while leaving the remainder of the channel dry and open to perform work (longitudinal barrier). The recommended applicability for these barrier types is provided in Table 3-2.

3.2 CONVEYANCE OPTIONS

As noted above, there are three general options for conveying surface water around a work area that is physically located within a channel. One is to use a closed system where the flows are contained using pipe, flexible hose, or some combination of the two. The other options use an open channel; either a newly created (dug) channel or an existing channel which has been restricted to contain the current flow within only part of the channel. In order to provide the capacity needed in a closed system, the predominant channel flow rates should be within acceptable levels, and the pipe or hose capacity must accommodate most if not all of the current flow. A newly dug channel must provide adequate capacity and a reasonable slope to allow efficient conveyance without excessive erosive force. An existing channel that has been restricted to hold all of the current flow in a portion of the normal capacity generally provides that greatest flexibility and capacity. In standing water influenced by tides, the critical design element is to provide adequate freeboard above the expected highest tides during the project's field schedule.

3.3 DIVERSION SCENARIOS

The number of potential combinations of the five barrier options with the three conveyance options and the two channel types can be reduced to the actual number of scenarios expected, based on historical conditions. When transverse barriers are employed for blocking flows, contained conveyance or new open channel conveyance are the only types used for re-routing channel flows. When longitudinal barriers are used, the only conveyance employed is limiting the location of flows within the existing channel. In addition to the four general non-tidal scenarios (see C1/S1, S2, C2/S3, and C3/S4 below) there are two other scenarios where barriers and dewatering could be required in the tidal setting (see C4/S5 and C5/S6).

To provide maximum flexibility for developing Project Water Diversion Plans, each of these scenarios is considered in both the concrete-lined channel setting (Scenarios C1 through C5) and the soft-bottom channel setting (Scenarios S1 through S6) as described below and shown in the cited figures. Drawings for the concrete-lined channel scenarios suggest a trapezoidal cross-section for illustration purposes. Concrete-lined channels can also exhibit rectangular cross-sections that present additional site access challenges for project execution that must be addressed by project-specific work plans.

The project work plan will account for channel reach layout and topography when selecting the best site access solution. Access difficulties can often be overcome using long-reach equipment from the top of the channel bank. However, this will be a design decision on a project-specific basis.

- **SCENARIO C1.** Transverse barrier with complete blockage, and closed system bypass conveyance, in a concrete-lined channel (see Figure 3-1).
- **SCENARIO C2.** Longitudinal barrier(s) with partial channel isolation, and an open-channel bypass conveyance restricted to one side of the existing concrete-lined channel (see Figure 3-2).
- **SCENARIO C3.** Longitudinal barrier(s) with partial channel isolation, and an open-channel bypass conveyance restricted to the center of the existing concrete-lined channel (see Figure 3-3).
- **SCENARIO C4.** Exclusionary barriers are provided to block around and isolate a work area which is connected to a concrete-lined channel side; no bypass conveyance is needed (see Figure 3-4).
- **SCENARIO C5.** Exclusionary barriers are provided to completely surround and isolate a work area which is not connected to either side of the concrete-lined channel; and no bypass conveyance is needed (see Figure 3-5). An example of this type of isolation is to provide a dry work area around a bridge pier in the middle of the channel.

**Table 3-2
Barrier Applicability**

Barrier Type	Channel Type	Applicability
Earthen Berm	Concrete-Lined	Recommended as a secondary option for transverse or longitudinal barriers where channel width, flow rate, and flow depth are within appropriate limits (as determined for each project). Potential for eroding of berm materials must be limited.
	Soft-bottom	Recommended as a secondary option for transverse or longitudinal barriers where channel width, flow rate, and flow depth are within appropriate limits (as determined for each project). Potential for eroding of berm materials must be controlled.
Sand/Gravel Bag Berm	Concrete-Lined	Recommended for transverse barriers where channel width and flow rate are within appropriate limits (as determined for each project). Recommended for longitudinal barriers where channel width and flow depth are within an appropriate range (as determined on a project-specific basis).
	Soft-bottom	Recommended for transverse barriers where channel width and flow rate are within appropriate limits (as determined for each project). Recommended for longitudinal barriers where channel width and flow depth in the conveyance channel are within appropriate limits (as determined on a project-specific basis).
Aqua-Barrier	Concrete-Lined	Recommended for transverse barriers without restriction. Recommended for longitudinal barriers without restriction.
	Soft-bottom	Recommended for transverse barriers without restriction. Recommended for longitudinal barriers without restriction.
Portadam™	Concrete-Lined	Recommended for transverse barriers without restriction. Recommended for longitudinal barriers without restriction.
	Soft-bottom	Recommended for transverse barriers without restriction. Recommended for longitudinal barriers without restriction.
K-Rails	Concrete-Lined	Recommended for transverse barriers where channel width and flow rate are within appropriate limits (as determined for each project). Recommended for longitudinal barriers where channel width and flow depth in the conveyance channel are within appropriate limits (as determined on a project-specific basis).
	Soft-bottom	Recommended for transverse barriers where water depth can be maintained within a specified range (as determined for each project).
Sheet Pile	Concrete-Lined	Not applicable.
	Soft-bottom	Recommended for transverse barriers where channel width and flow rate are within appropriate limits (as determined for each project). Recommended for exclusionary barriers where channel width and flow depth exclude other barrier types.

**TRANSVERSE BARRIER WITH COMPLETE BLOCKAGE
CLOSED SYSTEM BYPASS CONVEYANCE
CONCRETE-LINED CHANNEL**

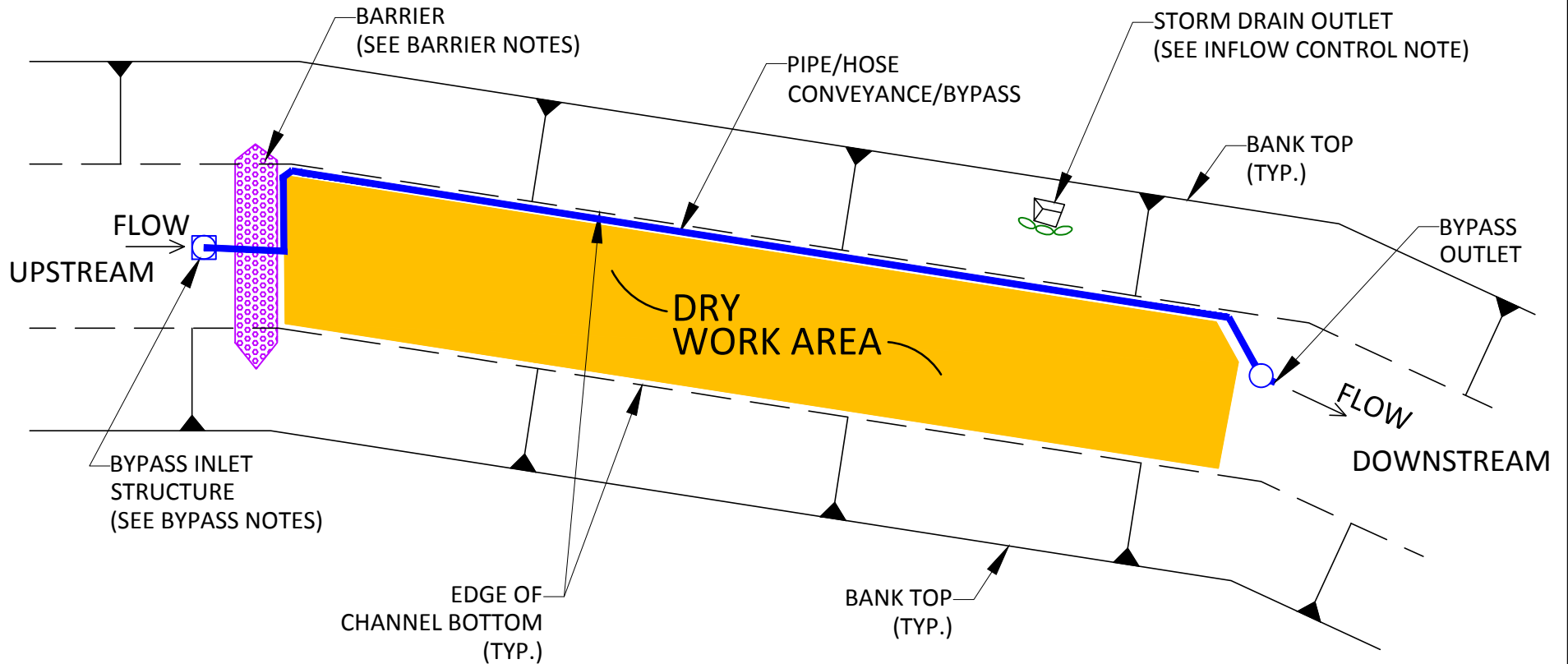

PLAN VIEW
NO SCALE

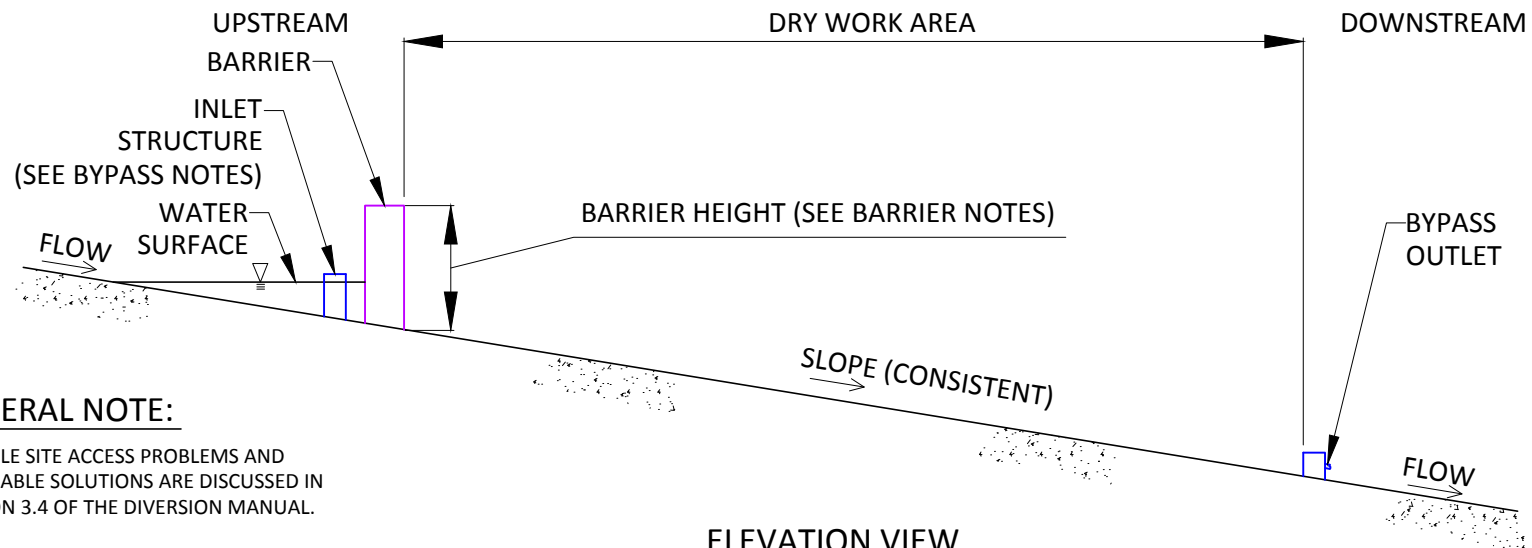

GENERAL NOTE:

1. POSSIBLE SITE ACCESS PROBLEMS AND APPLICABLE SOLUTIONS ARE DISCUSSED IN SECTION 3.4 OF THE DIVERSION MANUAL.

ELEVATION VIEW
NO SCALE

BARRIER NOTES	BMPs
o RECOMMENDED APPLICABILITY OF EARTHEN BERMS IS PROVIDED IN SECTION 3.1 (TABLE 3-2); SEE BMP FOR ADDITIONAL DETAILS.	EC-9
o ADDITIONAL DETAILS AND CONSIDERATIONS ARE PROVIDED IN BMP FOR WATER DIVERSION IMPLEMENTATION.	NS-5
o RECOMMENDED APPLICABILITY OF SANDBAG BERMS IS PROVIDED IN SECTION 3.1 (TABLE 3-2); SEE BMP FOR ADDITIONAL DETAILS.	SE-6
o RECOMMENDED APPLICABILITY OF GRAVELBAG BERMS IS PROVIDED IN SECTION 3.1 (TABLE 3-2); SEE BMP FOR ADDITIONAL DETAILS.	SE-8
o BARRIER TYPE SELECTION WILL BE A PROJECT-SPECIFIC DECISION; HEIGHT OF BARRIER WILL BE BASED ON CURRENT FLOW RATES (SEE SECTION 3.1 AND TABLE 3-2).	EC-9, SE-4, SE-6, SE-8
BYPASS NOTES	BMPs
o INLET TYPE AND CONFIGURATION WILL BE A PROJECT-SPECIFIC DECISION.	
INFLOW CONTROL NOTES	BMPs
o WHERE STORM DRAIN OUTLETS WITH LITTLE OR NO FLOW ARE PRESENT, PREVENT WATER INFLOW WITH SANDBAG BARRIER; SEE BMP FOR ADDITIONAL DETAILS.	SE-8
GENERAL NOTES	BMPs
o TIMING OF FIELD ACTIVITIES SHALL BE CONSIDERED IN DEVELOPING THE WORK PLAN AND PROJECT SCHEDULE; SEE BMP FOR ADDITIONAL DETAILS.	EC-1
o DUST CONTROL SHALL BE IMPLEMENTED WHENEVER HEAVY EQUIPMENT IS USED IN MAINTENANCE OR REPAIR ACTIVITIES AND GROUND DISTURBANCE IS PLANNED; SEE BMP FOR ADDITIONAL DETAILS.	WE-1
o FOR DEMOLITION, EXCAVATION, OR OTHER EARTHWORK ADJACENT TO SURFACE WATER, PRECAUTIONS SHALL BE TAKEN TO CONTAIN DEBRIS AND LOOSE SOIL; SEE BMP FOR ADDITIONAL DETAILS.	NS-12
o FIELD PERSONNEL SHALL TAKE PRECAUTIONS TO AVOID SPILLING OR LEAKING CONTAMINANTS DURING MAINTENANCE OR REPAIR ACTIVITIES; SEE BMP FOR ADDITIONAL DETAILS.	WM-4
o FIELD PERSONNEL SHALL MAINTAIN CLEAN WORK/STAGING AREAS, MANAGE AND CONTAIN POTENTIALLY HAZARDOUS MATERIALS, AND PROVIDE ADEQUATE WASTE RECEPTACLES; SEE BMP DETAILS.	SC-60

**LONGITUDINAL BARRIER(S) WITH PARTIAL CHANNEL ISOLATION
OPEN-CHANNEL BYPASS CONVEYANCE WITHIN EXISTING CHANNEL
CONCRETE-LINED CHANNEL**

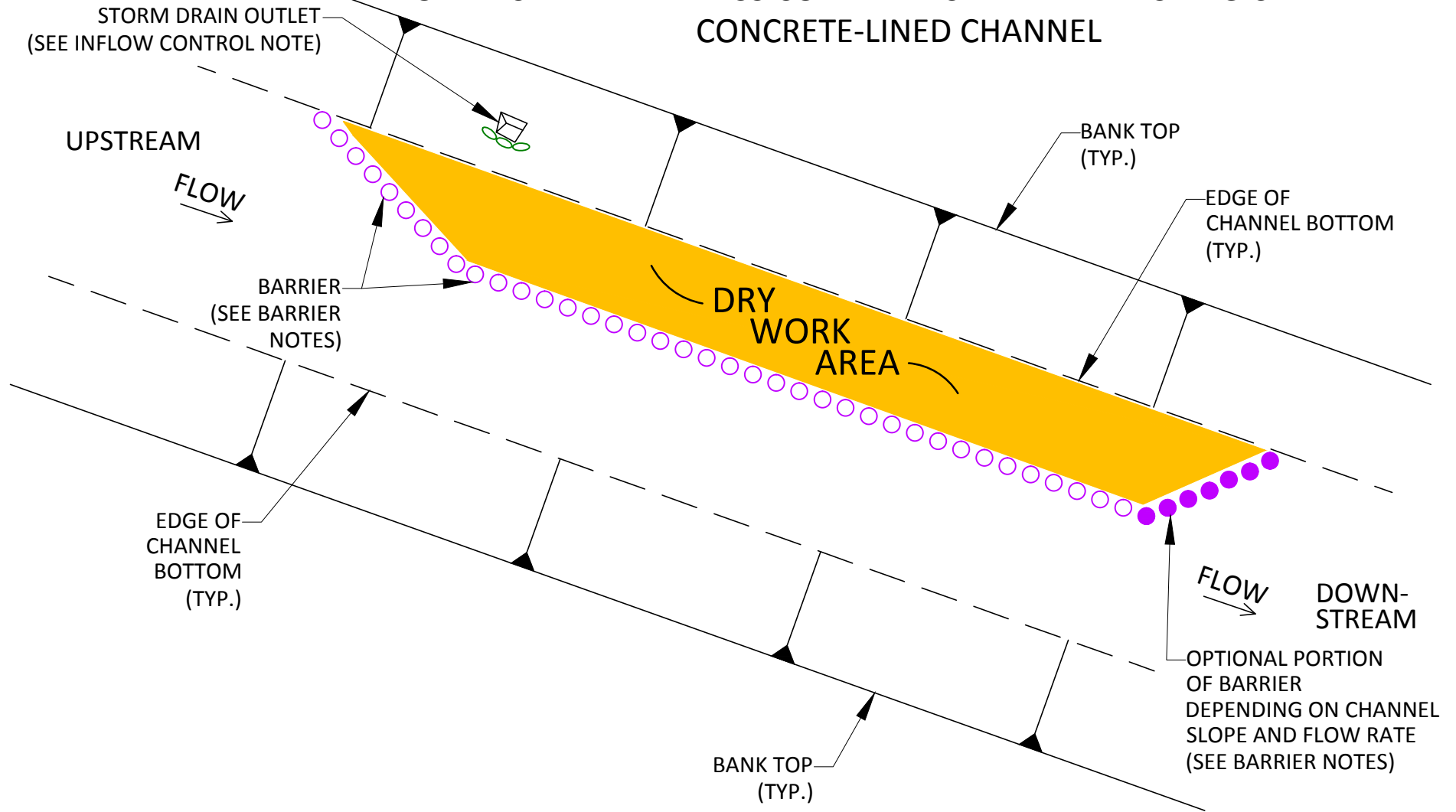

PLAN VIEW
NO SCALE

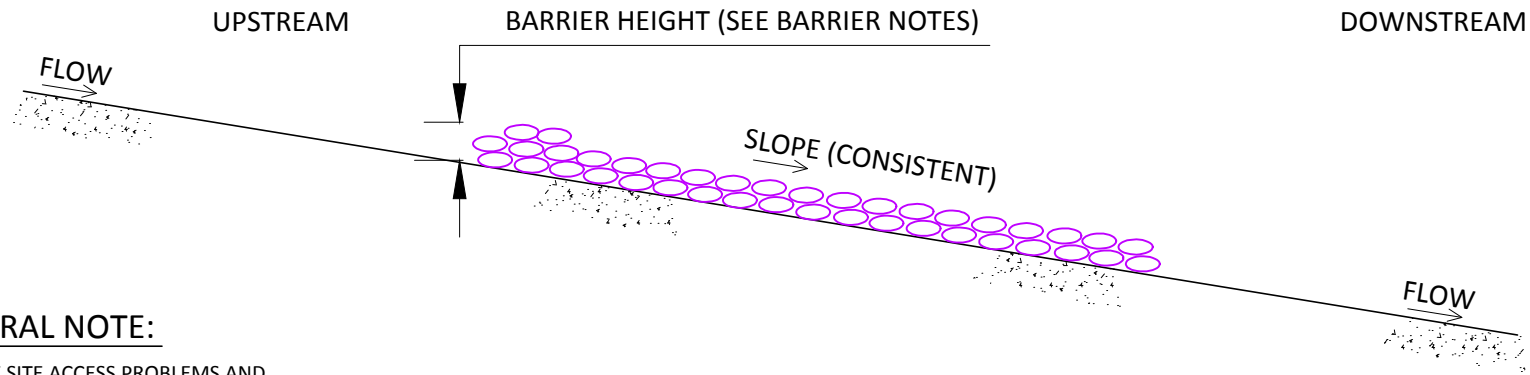

GENERAL NOTE:

1. POSSIBLE SITE ACCESS PROBLEMS AND APPLICABLE SOLUTIONS ARE DISCUSSED IN SECTION 3.4 OF THE DIVERSION MANUAL.

ELEVATION VIEW
NO SCALE

BARRIER NOTES	BMPs
o ADDITIONAL DETAILS AND CONSIDERATIONS ARE PROVIDED IN BMP FOR WATER DIVERSION IMPLEMENTATION.	NS-5
o RECOMMENDED APPLICABILITY OF SANDBAG BERMS IS PROVIDED IN SECTION 3.1 (TABLE 3-2); SEE BMP FOR ADDITIONAL DETAILS.	SE-6
o RECOMMENDED APPLICABILITY OF GRAVELBAG BERMS IS PROVIDED IN SECTION 3.1 (TABLE 3-2); SEE BMP FOR ADDITIONAL DETAILS.	SE-8
o BARRIER TYPE SELECTION WILL BE A PROJECT-SPECIFIC DECISION; HEIGHT OF BARRIER WILL BE BASED ON CURRENT FLOW RATES (SEE SECTION 3.1 AND TABLE 3-2).	EC-9, SE-4, SE-6, SE-8
INFLOW CONTROL NOTES	BMPs
o WHERE STORM DRAIN OUTLETS WITH LITTLE OR NO FLOW ARE PRESENT, PREVENT WATER INFLOW WITH SANDBAG BARRIER; SEE BMP FOR ADDITIONAL DETAILS.	SE-8
GENERAL NOTES	BMPs
o TIMING OF FIELD ACTIVITIES SHALL BE CONSIDERED IN DEVELOPING THE WORK PLAN AND PROJECT SCHEDULE; SEE BMP FOR ADDITIONAL DETAILS.	EC-1
o DUST CONTROL SHALL BE IMPLEMENTED WHENEVER HEAVY EQUIPMENT IS USED IN MAINTENANCE OR REPAIR ACTIVITIES AND GROUND DISTURBANCE IS PLANNED; SEE BMP FOR ADDITIONAL DETAILS.	WE-1
o FOR DEMOLITION, EXCAVATION, OR OTHER EARTHWORK ADJACENT TO SURFACE WATER, PRECAUTIONS SHALL BE TAKEN TO CONTAIN DEBRIS AND LOOSE SOIL; SEE BMP FOR ADDITIONAL DETAILS.	NS-12
o FIELD PERSONNEL SHALL TAKE PRECAUTIONS TO AVOID SPILLING OR LEAKING CONTAMINANTS DURING MAINTENANCE OR REPAIR ACTIVITIES; SEE BMP FOR ADDITIONAL DETAILS.	WM-4
o FIELD PERSONNEL SHALL MAINTAIN CLEAN WORK/STAGING AREAS, MANAGE AND CONTAIN POTENTIALLY HAZARDOUS MATERIALS, AND PROVIDE ADEQUATE WASTE RECEPTACLES; SEE BMP DETAILS.	SC-60

LONGITUDINAL BARRIER(S) WITH PARTIAL CHANNEL ISOLATION
 OPEN-CHANNEL BYPASS CONVEYANCE WITHIN EXISTING CHANNEL
 CONCRETE-LINED CHANNEL

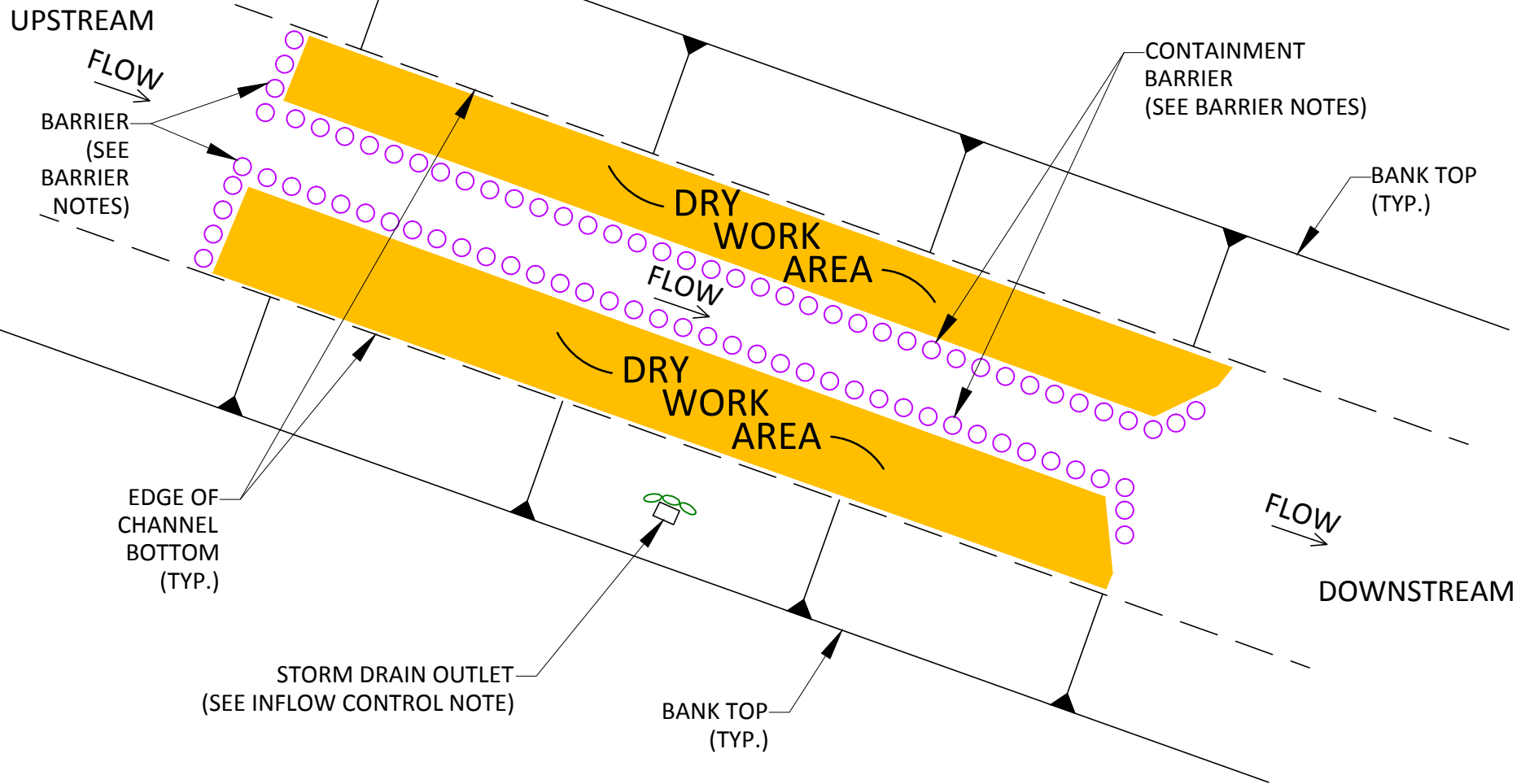

PLAN VIEW
 NO SCALE

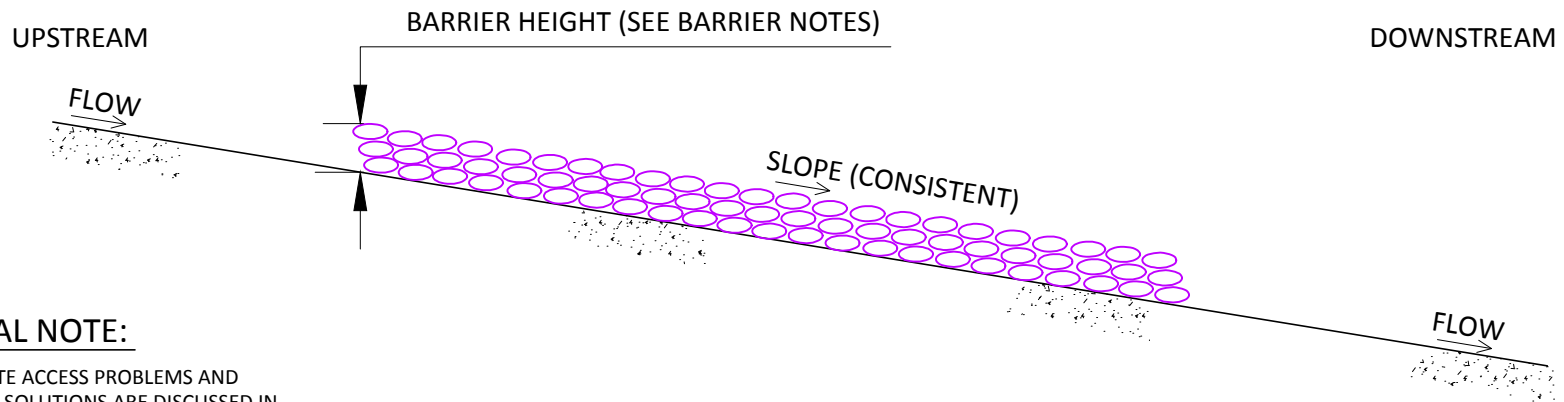

GENERAL NOTE:

1. POSSIBLE SITE ACCESS PROBLEMS AND APPLICABLE SOLUTIONS ARE DISCUSSED IN SECTION 3.4 OF THE DIVERSION MANUAL.

ELEVATION VIEW
NO SCALE

BARRIER NOTES	BMPs
o ADDITIONAL DETAILS AND CONSIDERATIONS ARE PROVIDED IN BMP FOR WATER DIVERSION IMPLEMENTATION.	NS-5
o RECOMMENDED APPLICABILITY OF SANDBAG BERMS IS PROVIDED IN SECTION 3.1 (TABLE 3-2); SEE BMP FOR ADDITIONAL DETAILS.	SE-6
o RECOMMENDED APPLICABILITY OF GRAVELBAG BERMS IS PROVIDED IN SECTION 3.1 (TABLE 3-2); SEE BMP FOR ADDITIONAL DETAILS.	SE-8
o BARRIER TYPE SELECTION WILL BE A PROJECT-SPECIFIC DECISION; HEIGHT OF BARRIER WILL BE BASED ON CURRENT FLOW RATES (SEE SECTION 3.1 AND TABLE 3-2).	EC-9, SE-4, SE-6, SE-8
INFLOW CONTROL NOTES	BMPs
o WHERE STORM DRAIN OUTLETS WITH LITTLE OR NO FLOW ARE PRESENT, PREVENT WATER INFLOW WITH SANDBAG BARRIER; SEE BMP FOR ADDITIONAL DETAILS.	SE-8
GENERAL NOTES	BMPs
o TIMING OF FIELD ACTIVITIES SHALL BE CONSIDERED IN DEVELOPING THE WORK PLAN AND PROJECT SCHEDULE; SEE BMP FOR ADDITIONAL DETAILS.	EC-1
o DUST CONTROL SHALL BE IMPLEMENTED WHENEVER HEAVY EQUIPMENT IS USED IN MAINTENANCE OR REPAIR ACTIVITIES AND GROUND DISTURBANCE IS PLANNED; SEE BMP FOR ADDITIONAL DETAILS.	WE-1
o FOR DEMOLITION, EXCAVATION, OR OTHER EARTHWORK ADJACENT TO SURFACE WATER, PRECAUTIONS SHALL BE TAKEN TO CONTAIN DEBRIS AND LOOSE SOIL; SEE BMP FOR ADDITIONAL DETAILS.	NS-12
o FIELD PERSONNEL SHALL TAKE PRECAUTIONS TO AVOID SPILLING OR LEAKING CONTAMINANTS DURING MAINTENANCE OR REPAIR ACTIVITIES; SEE BMP FOR ADDITIONAL DETAILS.	WM-4
o FIELD PERSONNEL SHALL MAINTAIN CLEAN WORK/STAGING AREAS, MANAGE AND CONTAIN POTENTIALLY HAZARDOUS MATERIALS, AND PROVIDE ADEQUATE WASTE RECEPTACLES; SEE BMP DETAILS.	SC-60

EXCLUSIONARY BARRIERS AROUND SIDE OF CHANNEL WORK AREA
 EXISTING CHANNEL BYPASS
 CONCRETE-LINED CHANNEL

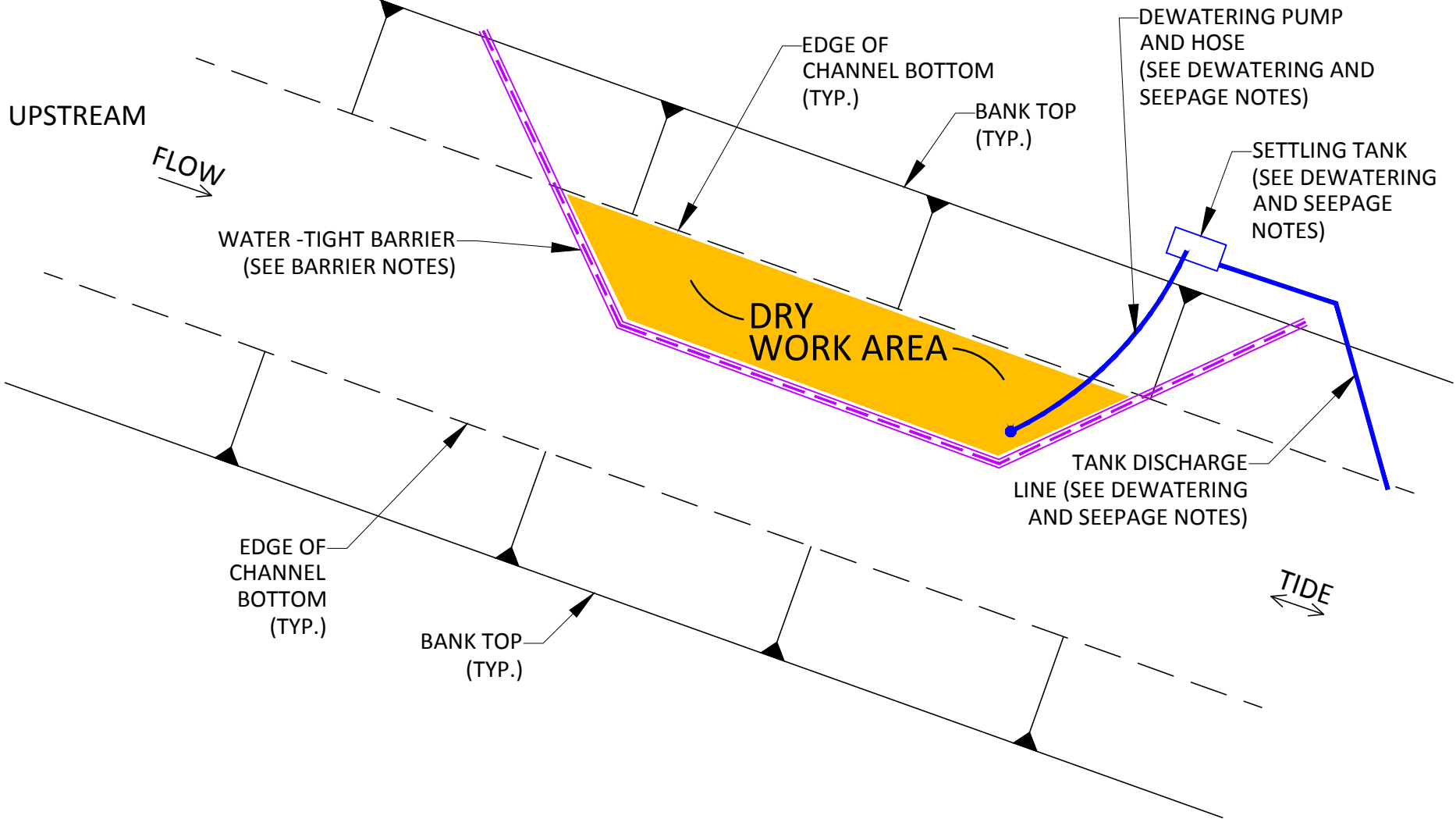

PLAN VIEW
 NO SCALE

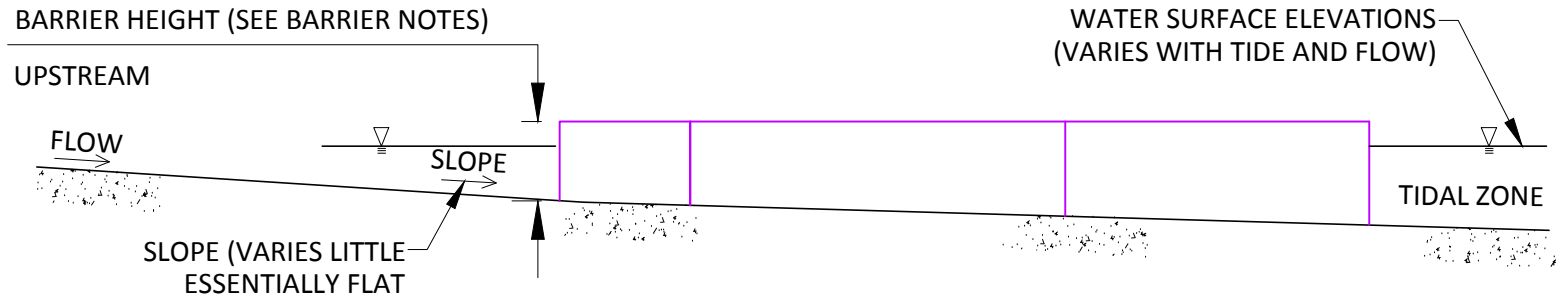

ELEVATION VIEW
NO SCALE

BARRIER NOTES	BMPs
o BARRIER TYPE SELECTION WILL BE A PROJECT-SPECIFIC DECISION; AQUA BARRIER OR K-RAILS ARE LIKELY OPTIONS FOR CONCRETE-LINED CHANNELS.	
o HEIGHT OF BARRIER MUST ACCOUNT FOR WATER DEPTH, HIGH TIDE ELEVATION, AND REQUIRED FREEBOARD.	
DEWATERING AND SEEPAGE CONTROL NOTES	BMPs
o OBTAIN ALL REQUIRED PERMIT APPROVALS FOR DISCHARGE OF WATER REMOVED THROUGH DEWATERING ACTIVITIES.	
o PROVIDE DEWATERING PUMPS AND SETTLING BASINS/TANKS AS REQUIRED TO REMOVE WATER FROM WORK AREA AND CONTROL SEEPAGE; SEE BMP FOR ADDITIONAL DETAILS.	NS-2
o TYPE, SIZE, AND NUMBER OF SETTLING BASINS/TANKS NEEDED WILL BE DETERMINED ON A PROJECT SPECIFIC BASIS.	
o TYPE, SIZE, AND NUMBER OF PUMPS REQUIRED WILL BE BASED ON THE VOLUME OF WATER TO REMOVE AND THE ANTICIPATED RATE OF SEEPAGE.	
INFLOW CONTROL NOTES	BMPs
o WHERE STORM DRAIN OUTLETS WITH LITTLE OR NO FLOW ARE PRESENT, PREVENT WATER INFLOW WITH SANDBAG BARRIER; SEE BMP FOR ADDITIONAL DETAILS.	SE-8
GENERAL NOTES	BMPs
o TIMING OF FIELD ACTIVITIES SHALL BE CONSIDERED IN DEVELOPING THE WORK PLAN AND PROJECT SCHEDULE; SEE BMP FOR ADDITIONAL DETAILS.	EC-1
o ACCESS TO DRY WORK AREA BY HEAVY EQUIPMENT WILL BE FROM BANK TOP USING LONG-REACH MECHANICAL ARMS.	
o ACCESS TO DRY WORK AREA BY PERSONNEL FOR HAND-WORK WILL BE BY LADDER FROM BANK TOP, WITH ALL NECESSARY SAFETY PRECAUTIONS CONSIDERED AND ADDRESSED.	
o DUST CONTROL SHALL BE IMPLEMENTED WHENEVER HEAVY EQUIPMENT IS USED IN MAINTENANCE OR REPAIR ACTIVITIES AND GROUND DISTURBANCE IS PLANNED; SEE BMP FOR ADDITIONAL DETAILS.	WE-1
o FOR DEMOLITION, EXCAVATION, OR OTHER EARTHWORK ADJACENT TO SURFACE WATER, PRECAUTIONS SHALL BE TAKEN TO CONTAIN DEBRIS AND LOOSE SOIL; SEE BMP FOR ADDITIONAL DETAILS.	NS-12
o FIELD PERSONNEL SHALL TAKE PRECAUTIONS TO AVOID SPILLING OR LEAKING CONTAMINANTS DURING MAINTENANCE OR REPAIR ACTIVITIES; SEE BMP FOR ADDITIONAL DETAILS.	WM-4
o FIELD PERSONNEL SHALL MAINTAIN CLEAN WORK/STAGING AREAS, MANAGE AND CONTAIN POTENTIALLY HAZARDOUS MATERIALS, AND PROVIDE ADEQUATE WASTE RECEPTACLES; SEE BMP DETAILS.	SC-60

EXCLUSIONARY BARRIERS SURROUNDING MID-CHANNEL WORK AREA
 EXISTING CHANNEL BYPASS
 CONCRETE-LINED CHANNEL

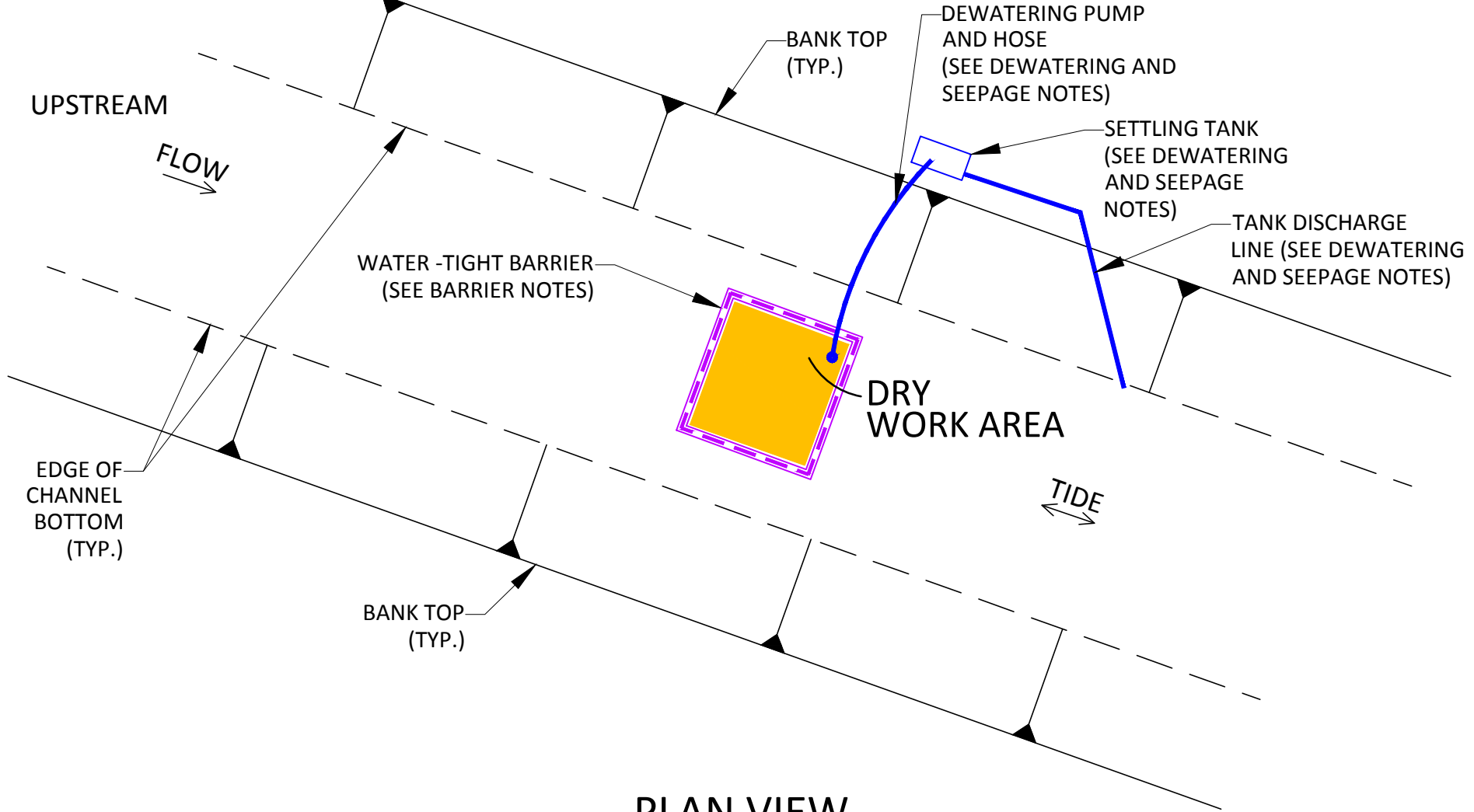

PLAN VIEW
 NO SCALE

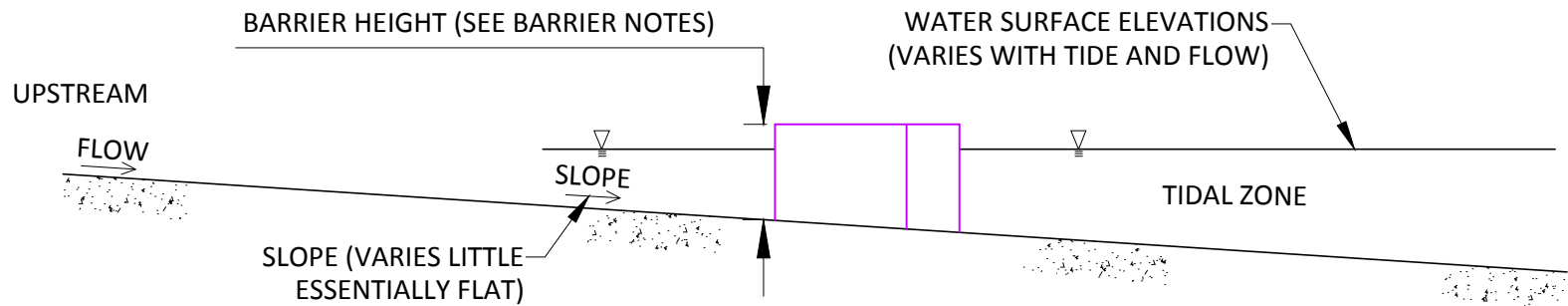

ELEVATION VIEW

NO SCALE

BARRIER NOTES	BMPs
o BARRIER TYPE SELECTION WILL BE A PROJECT-SPECIFIC DECISION; AQUA BARRIER OR K-RAILS ARE LIKELY OPTIONS FOR CONCRETE-LINED CHANNELS.	
o HEIGHT OF BARRIER MUST ACCOUNT FOR WATER DEPTH, HIGH TIDE ELEVATION, AND REQUIRED FREEBOARD.	
o PROVIDE DEWATERING PUMPS AND SETTLING BASINS AS REQUIRED TO REMOVE WATER FROM WORK AREA AND CONTROL SEEPAGE; SEE BMP FOR ADDITIONAL DETAILS.	NS-2
DEWATERING AND SEEPAGE CONTROL NOTES	BMPs
o OBTAIN ALL REQUIRED PERMIT APPROVALS FOR DISCHARGE OF WATER REMOVED THROUGH DEWATERING ACTIVITIES.	
o PROVIDE DEWATERING PUMPS AND SETTLING BASINS/TANKS AS REQUIRED TO REMOVE WATER FROM WORK AREA AND CONTROL SEEPAGE; SEE BMP FOR ADDITIONAL DETAILS.	NS-2
o TYPE, SIZE, AND NUMBER OF SETTLING BASINS/TANKS NEEDED WILL BE DETERMINED ON A PROJECT SPECIFIC BASIS.	
o TYPE, SIZE, AND NUMBER OF PUMPS REQUIRED WILL BE BASED ON THE VOLUME OF WATER TO REMOVE AND THE ANTICIPATED RATE OF SEEPAGE.	
GENERAL NOTES	BMPs
o TIMING OF FIELD ACTIVITIES SHALL BE CONSIDERED IN DEVELOPING THE WORK PLAN AND PROJECT SCHEDULE; SEE BMP FOR ADDITIONAL DETAILS.	EC-1
o ACCESS TO DRY WORK AREA BY HEAVY EQUIPMENT WILL BE FROM FLOATING PLATFORM OR BRIDGE DECK USING LONG-REACH MECHANICAL ARMS.	
o ACCESS TO DRY WORK AREA BY PERSONNEL FOR HAND-WORK WILL BE BY LADDER FROM FLOATING PLATFORM OR BRIDGE DECK, WITH ALL NECESSARY SAFETY PRECAUTIONS ADDRESSED.	
o DUST CONTROL SHALL BE IMPLEMENTED WHENEVER HEAVY EQUIPMENT IS USED IN MAINTENANCE OR REPAIR ACTIVITIES AND GROUND DISTURBANCE IS PLANNED; SEE BMP FOR ADDITIONAL DETAILS.	WE-1
o FOR DEMOLITION, EXCAVATION, OR OTHER EARTHWORK ADJACENT TO SURFACE WATER, PRECAUTIONS SHALL BE TAKEN TO CONTAIN DEBRIS AND LOOSE SOIL; SEE BMP FOR ADDITIONAL DETAILS.	NS-12
o FIELD PERSONNEL SHALL TAKE PRECAUTIONS TO AVOID SPILLING OR LEAKING CONTAMINANTS DURING MAINTENANCE OR REPAIR ACTIVITIES; SEE BMP FOR ADDITIONAL DETAILS.	WM-4
o FIELD PERSONNEL SHALL MAINTAIN CLEAN WORK/STAGING AREAS, MANAGE AND CONTAIN POTENTIALLY HAZARDOUS MATERIALS, AND PROVIDE ADEQUATE WASTE RECEPTACLES; SEE BMP DETAILS.	SC-60

- **SCENARIO S1.** Transverse barrier with complete blockage, and closed system bypass conveyance, around a soft-bottom channel (see Figure 3-6).
- **SCENARIO S2.** Transverse barrier with complete blockage, and a newly dug, open-channel bypass conveyance around a soft-bottom channel (see Figure 3-7).
- **SCENARIO S3.** Longitudinal barrier(s) with partial channel isolation, and an open-channel bypass conveyance restricted to one side of the existing soft-bottom channel (see Figure 3-8).
- **SCENARIO S4.** Longitudinal barrier(s) with partial channel isolation, and an open-channel bypass conveyance restricted to the center of the existing soft-bottom channel (see Figure 3-9).
- **SCENARIO S5.** Exclusionary barriers are provided to block around and isolate a work area which is connected to a soft-bottom channel side; no bypass conveyance is needed (see Figure 3-10).
- **SCENARIO S6.** Exclusionary barriers are provided to completely surround and isolate a work area which is not connected to either side of the soft-bottom channel; and no bypass conveyance is needed (see Figure 3-11).

All of the expected situations in which diversion might be required are captured by these scenarios for either the concrete-lined or soft-bottom channels. Implementing a diversion under one of these scenarios will follow the generic considerations provided on the scenario description (Figures 3-1 through 3-11) and the process described in Section 4.

3.4 PROJECT SITE ACCESS

LACFCD has existing routes that provide access to channels by work crews for necessary maintenance and repair activities. The types of access include roads, ramps, and easements over which personnel and equipment can reach project areas (generally channel bottoms) without disturbing habitat, property, or structures. Where channels are wide, ramps are provided over which heavy equipment can be driven to reach project areas on the channel bottom from the top of the bank. Where channels are narrow enough that long-reach equipment can perform necessary actions from the bank tops, or temporary bridging structures can be deployed over the channel to provide site access, such ramps are unnecessary. However, even with the system of existing and established access routes available, sometimes it is necessary to provide new, temporary access routes either along the bank top or the channel bottom, which could require crossing standing or flowing water, existing utilities, or other sensitive infrastructure. In such cases, precautions are taken to avoid contacting or damaging sensitive features to be crossed. Table 3-3 suggests various applicable methods that can be used to provide temporary site access in order to avoid water contact or any

potentially damaging effects on utilities or other sensitive infrastructure. A brief description of these access methods follows.

**Table 3-3
Temporary Site Access Methods**

Channel Size	Concrete Channel	Soft-Bottom Channel
Large Channel [Width greater than 50 feet bank top to bank top]	<ul style="list-style-type: none"> • Crane lift • Long-reach equipment • Temporary bridging 	<ul style="list-style-type: none"> • Construction mat • Crane lift • Long-reach equipment • Temporary bridging
Small Channel [Width of 50 feet or less bank top to bank top]	<ul style="list-style-type: none"> • Long-reach equipment • Temporary bridging 	<ul style="list-style-type: none"> • Construction mat • Long-reach equipment • Temporary Bridging
Tidal Channel [Standing water present at high tide, and possibly also at low tide]	<ul style="list-style-type: none"> • Crane lift • Floating platform • Low-tide access 	<ul style="list-style-type: none"> • Crane lift • Floating platform • Long-reach equipment

**TRANSVERSE BARRIER WITH COMPLETE BLOCKAGE
CLOSED SYSTEM BYPASS CONVEYANCE
SOFT-BOTTOM CHANNEL**

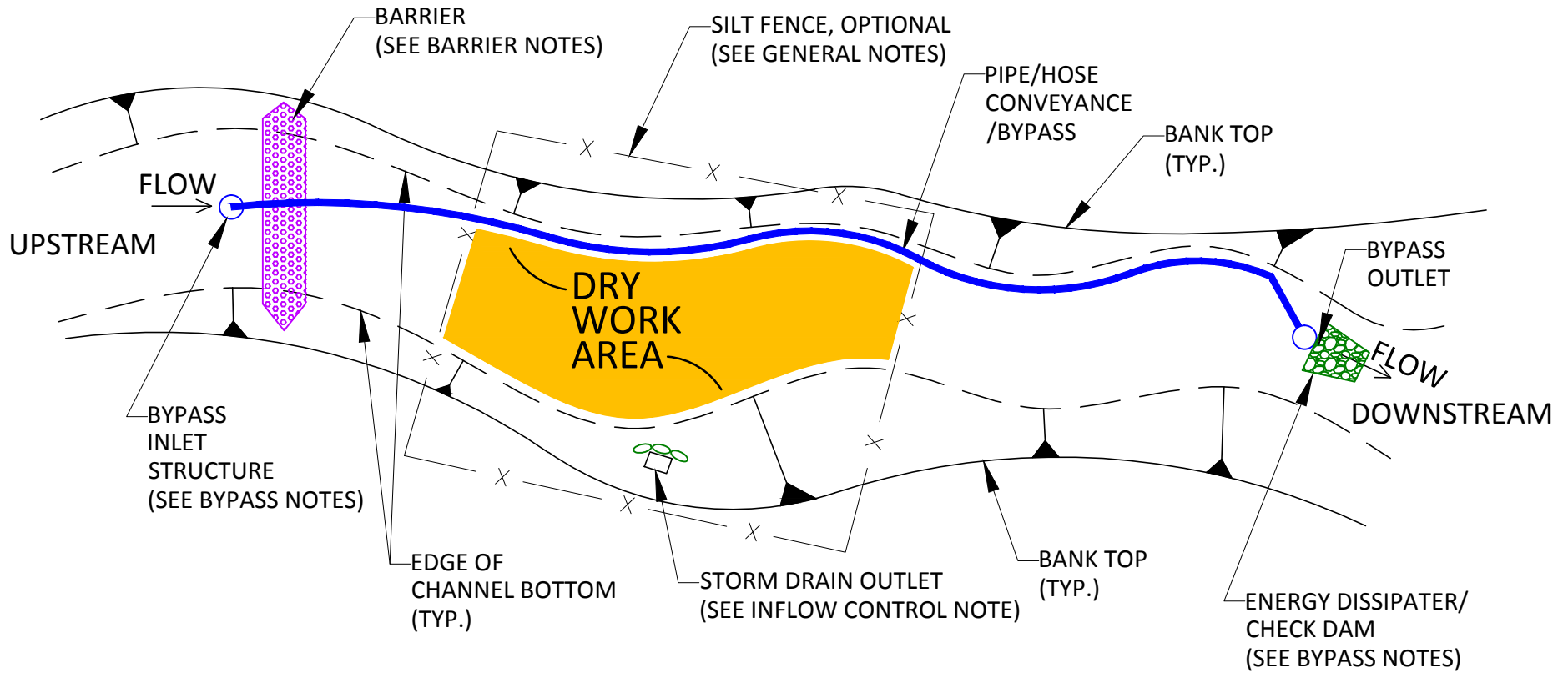

PLAN VIEW
NO SCALE

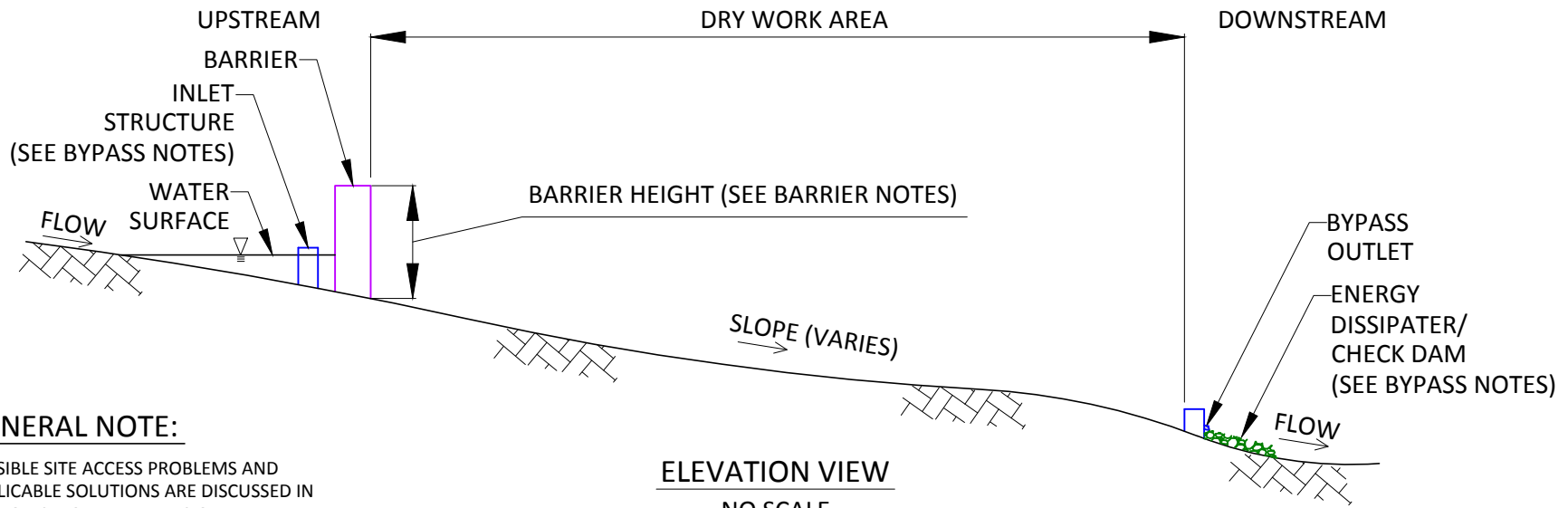

GENERAL NOTE:

1. POSSIBLE SITE ACCESS PROBLEMS AND APPLICABLE SOLUTIONS ARE DISCUSSED IN SECTION 3.4 OF THE DIVERSION MANUAL.

ELEVATION VIEW
NO SCALE

BARRIER NOTES	BMPs
o RECOMMENDED APPLICABILITY OF EARTHEN BERMS IS PROVIDED IN SECTION 3.1 (TABLE 3-2); SEE BMP FOR ADDITIONAL DETAILS.	EC-9
o ADDITIONAL DETAILS AND CONSIDERATIONS ARE PROVIDED IN BMP FOR WATER DIVERSION IMPLEMENTATION.	NS-5
o RECOMMENDED APPLICABILITY OF SANDBAG BERMS IS PROVIDED IN SECTION 3.1 (TABLE 3-2); SEE BMP FOR ADDITIONAL DETAILS.	SE-6
o RECOMMENDED APPLICABILITY OF GRAVELBAG BERMS IS PROVIDED IN SECTION 3.1 (TABLE 3-2); SEE BMP FOR ADDITIONAL DETAILS.	SE-8
o BARRIER TYPE SELECTION WILL BE A PROJECT-SPECIFIC DECISION; HEIGHT OF BARRIER WILL BE BASED ON CURRENT FLOW RATES (SEE SECTION 3.1 AND TABLE 3-2).	EC-9, SE-4, SE-6, SE-8
BYPASS NOTES	BMPs
o USE OF VELOCITY DISSIPATION DEVICES IS RECOMMENDED FOR ALL PIPE-FLOW BYPASS APPLICATIONS; SEE BMP FOR ADDITIONAL DETAILS.	EC-10
o CUSTOMIZED APPLICATIONS OF CHECK DAMS MAY BE SUBSTITUTED FOR VELOCITY DISSIPATION, SEE BMP FOR ADDITIONAL DETAILS.	SE-4
o INLET TYPE AND CONFIGURATION WILL BE A PROJECT-SPECIFIC DECISION.	
INFLOW CONTROL NOTES	BMPs
o WHERE STORM DRAIN OUTLETS WITH LITTLE OR NO FLOW ARE PRESENT, PREVENT WATER INFLOW WITH SANDBAG BARRIER; SEE BMP FOR ADDITIONAL DETAILS.	SE-8
GENERAL NOTES	BMPs
o TIMING OF FIELD ACTIVITIES SHALL BE CONSIDERED IN DEVELOPING THE WORK PLAN AND PROJECT SCHEDULE; SEE BMP FOR ADDITIONAL DETAILS.	EC-1
o AS REQUIRED BY REACH OR AS REASONABLE FOR A PROJECT, MEASURES SHALL BE TAKEN TO PRESERVE VEGETATION IN THE WORK AREA; SEE BMP FOR ADDITIONAL DETAILS.	EC-2
o DUST CONTROL SHALL BE IMPLEMENTED WHENEVER HEAVY EQUIPMENT IS USED IN MAINTENANCE OR REPAIR ACTIVITIES AND GROUND DISTURBANCE IS PLANNED; SEE BMP FOR ADDITIONAL DETAILS.	WE-1
o FOR DEMOLITION, EXCAVATION, OR OTHER EARTHWORK ADJACENT TO SURFACE WATER, PRECAUTIONS SHALL BE TAKEN TO CONTAIN DEBRIS AND LOOSE SOIL; SEE BMP FOR ADDITIONAL DETAILS.	NS-12
o USE SILT FENCES FOR PERIMETER CONTROL AS REQUIRED FOR PROJECT-SPECIFIC LAYOUT; SEE BMP FOR ADDITIONAL DETAILS.	SE-1
o FIELD PERSONNEL SHALL TAKE PRECAUTIONS TO AVOID SPILLING OR LEAKING CONTAMINANTS DURING MAINTENANCE OR REPAIR ACTIVITIES; SEE BMP FOR ADDITIONAL DETAILS.	WM-4
o FIELD PERSONNEL SHALL MAINTAIN CLEAN WORK/STAGING AREAS, MANAGE AND CONTAIN POTENTIALLY HAZARDOUS MATERIALS, AND PROVIDE ADEQUATE WASTE RECEPTACLES; SEE BMP DETAILS.	SC-60

**TRANSVERSE BARRIER WITH COMPLETE BLOCKAGE
NEW OPEN-CHANNEL BYPASS CONVEYANCE
SOFT-BOTTOM CHANNEL**

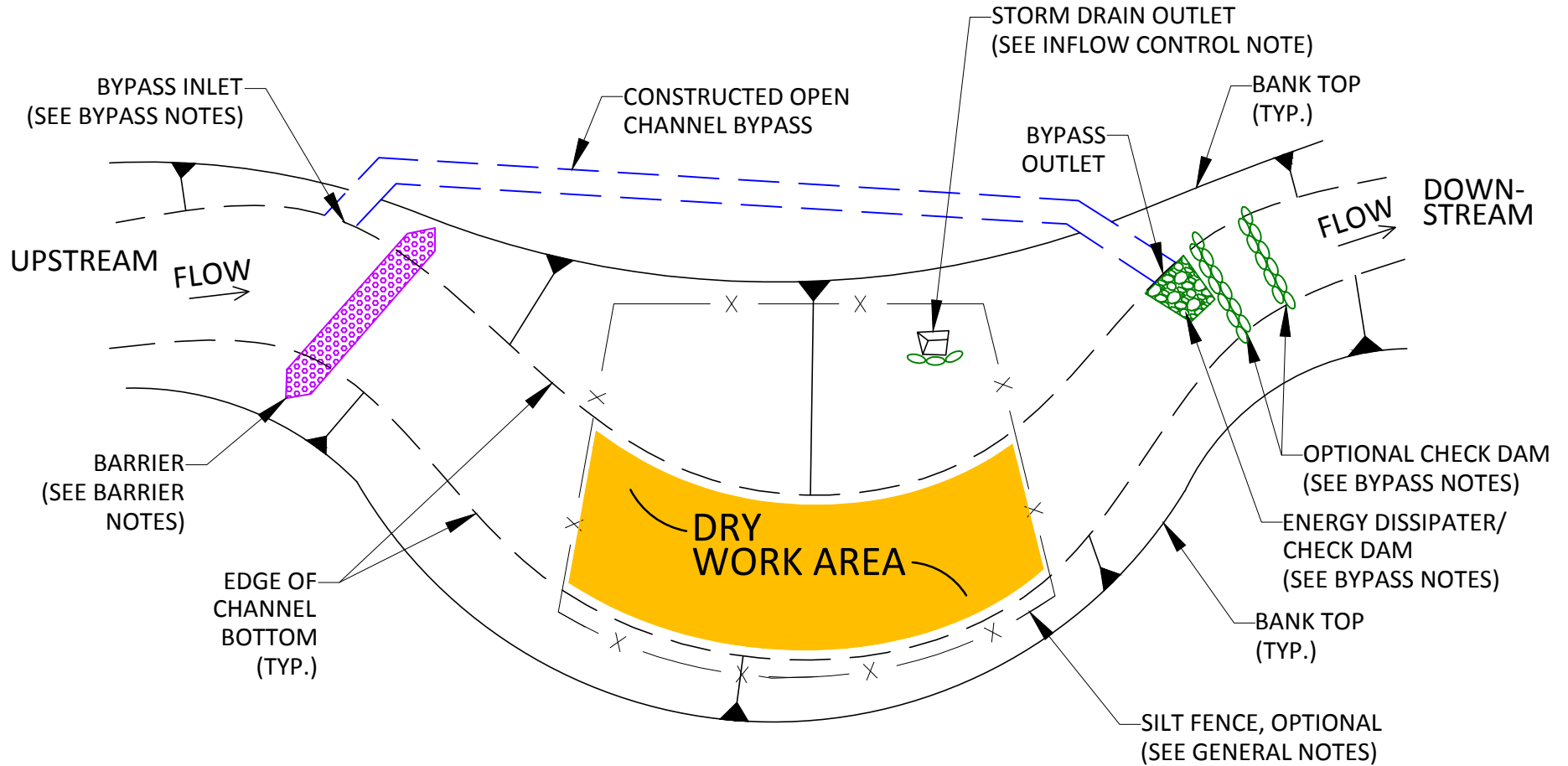

PLAN VIEW
NO SCALE

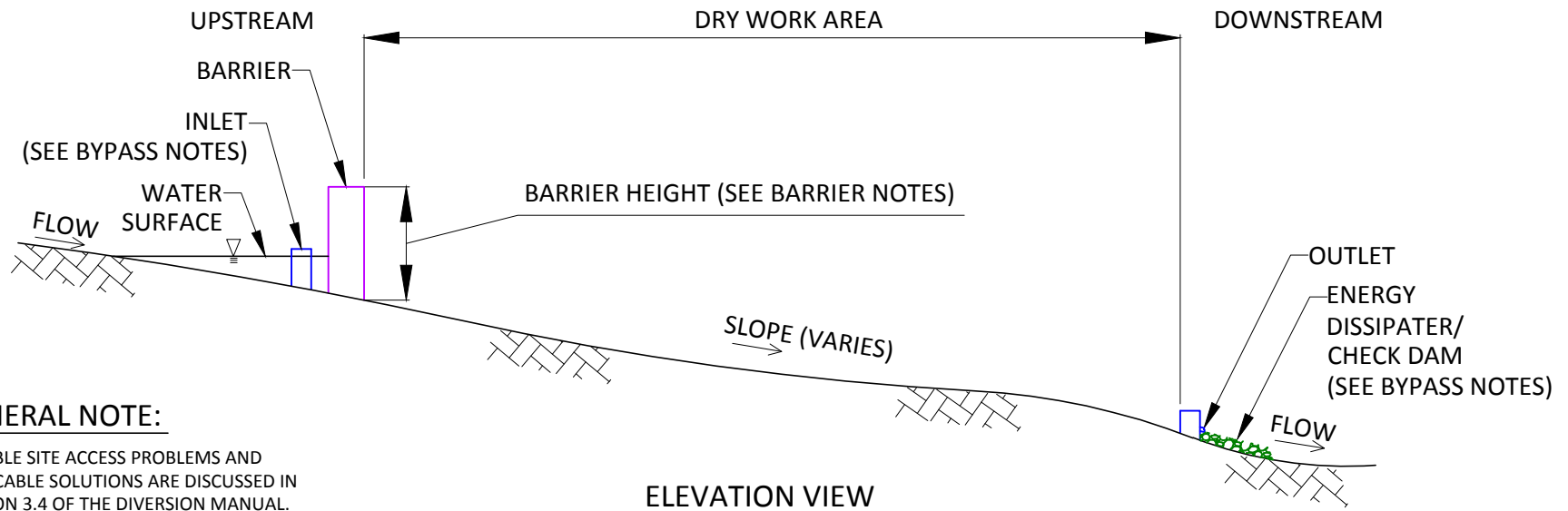

GENERAL NOTE:

- 1. POSSIBLE SITE ACCESS PROBLEMS AND APPLICABLE SOLUTIONS ARE DISCUSSED IN SECTION 3.4 OF THE DIVERSION MANUAL.

ELEVATION VIEW
NO SCALE

BARRIER NOTES	BMPs
o RECOMMENDED APPLICABILITY OF EARTHEN BERMS IS PROVIDED IN SECTION 3.1 (TABLE 3-2); SEE BMP FOR ADDITIONAL DETAILS.	EC-9
o ADDITIONAL DETAILS AND CONSIDERATIONS ARE PROVIDED IN BMP FOR WATER DIVERSION IMPLEMENTATION.	NS-5
o RECOMMENDED APPLICABILITY OF SANDBAG BERMS IS PROVIDED IN SECTION 3.1 (TABLE 3-2); SEE BMP FOR ADDITIONAL DETAILS.	SE-6
o RECOMMENDED APPLICABILITY OF GRAVELBAG BERMS IS PROVIDED IN SECTION 3.1 (TABLE 3-2); SEE BMP FOR ADDITIONAL DETAILS.	SE-8
o BARRIER TYPE SELECTION WILL BE A PROJECT-SPECIFIC DECISION; HEIGHT OF BARRIER WILL BE BASED ON CURRENT FLOW RATES (SEE SECTION 3.1 AND TABLE 3-2).	EC-9, SE-4, SE-6, SE-8
BYPASS NOTES	BMPs
o USE OF VELOCITY DISSIPATION DEVICES MAY BE RECOMMENDED FOR BYPASS APPLICATIONS; SEE BMP FOR ADDITIONAL DETAILS.	EC-10
o CUSTOMIZED APPLICATIONS OF CHECK DAMS MAY BE SUBSTITUTED FOR VELOCITY DISSIPATION, SEE BMP FOR ADDITIONAL DETAILS.	SE-4
o INLET TYPE AND CONFIGURATION WILL BE A PROJECT-SPECIFIC DECISION.	
INFLOW CONTROL NOTES	BMPs
o WHERE STORM DRAIN OUTLETS WITH LITTLE OR NO FLOW ARE PRESENT, PREVENT WATER INFLOW WITH SANDBAG BARRIER; SEE BMP FOR ADDITIONAL DETAILS.	SE-8
GENERAL NOTES	BMPs
o TIMING OF FIELD ACTIVITIES SHALL BE CONSIDERED IN DEVELOPING THE WORK PLAN AND PROJECT SCHEDULE; SEE BMP FOR ADDITIONAL DETAILS.	EC-1
o AS REQUIRED BY REACH OR AS REASONABLE FOR A PROJECT, MEASURES SHALL BE TAKEN TO PRESERVE VEGETATION IN THE WORK AREA; SEE BMP FOR ADDITIONAL DETAILS.	EC-2
o DUST CONTROL SHALL BE IMPLEMENTED WHENEVER HEAVY EQUIPMENT IS USED IN MAINTENANCE OR REPAIR ACTIVITIES AND GROUND DISTURBANCE IS PLANNED; SEE BMP FOR ADDITIONAL DETAILS.	WE-1
o FOR DEMOLITION, EXCAVATION, OR OTHER EARTHWORK ADJACENT TO SURFACE WATER, PRECAUTIONS SHALL BE TAKEN TO CONTAIN DEBRIS AND LOOSE SOIL; SEE BMP FOR ADDITIONAL DETAILS.	NS-12
o USE SILT FENCES FOR PERIMETER CONTROL AS REQUIRED FOR PROJECT-SPECIFIC LAYOUT; SEE BMP FOR ADDITIONAL DETAILS.	SE-1
o FIELD PERSONNEL SHALL TAKE PRECAUTIONS TO AVOID SPILLING OR LEAKING CONTAMINANTS DURING MAINTENANCE OR REPAIR ACTIVITIES; SEE BMP FOR ADDITIONAL DETAILS.	WM-4
o FIELD PERSONNEL SHALL MAINTAIN CLEAN WORK/STAGING AREAS, MANAGE AND CONTAIN POTENTIALLY HAZARDOUS MATERIALS, AND PROVIDE ADEQUATE WASTE RECEPTACLES; SEE BMP DETAILS.	SC-60

LONGITUDINAL BARRIER(S) WITH PARTIAL CHANNEL ISOLATION
 OPEN-CHANNEL BYPASS CONVEYANCE WITHIN EXISTING CHANNEL
 SOFT-BOTTOM CHANNEL

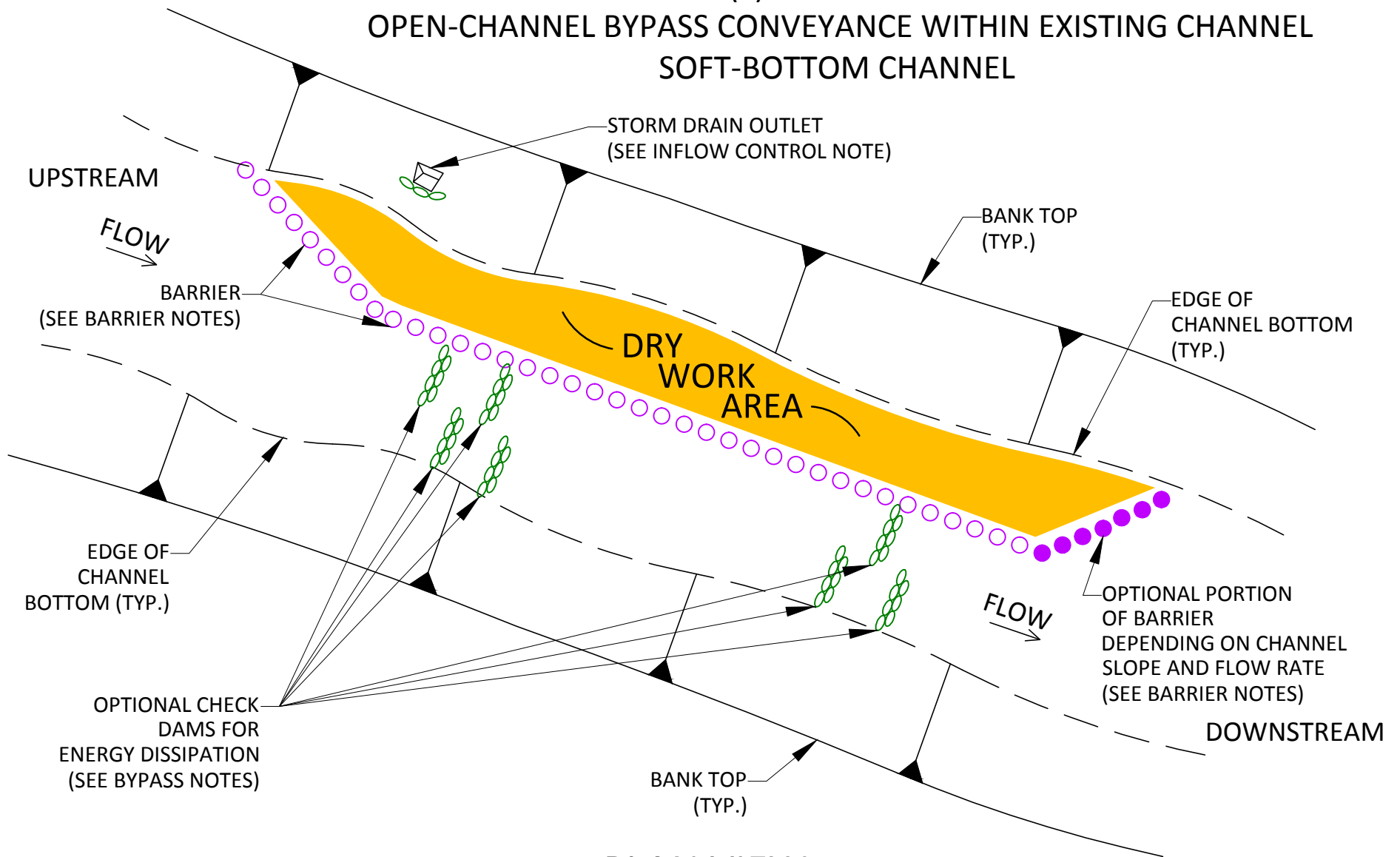

PLAN VIEW
 NO SCALE

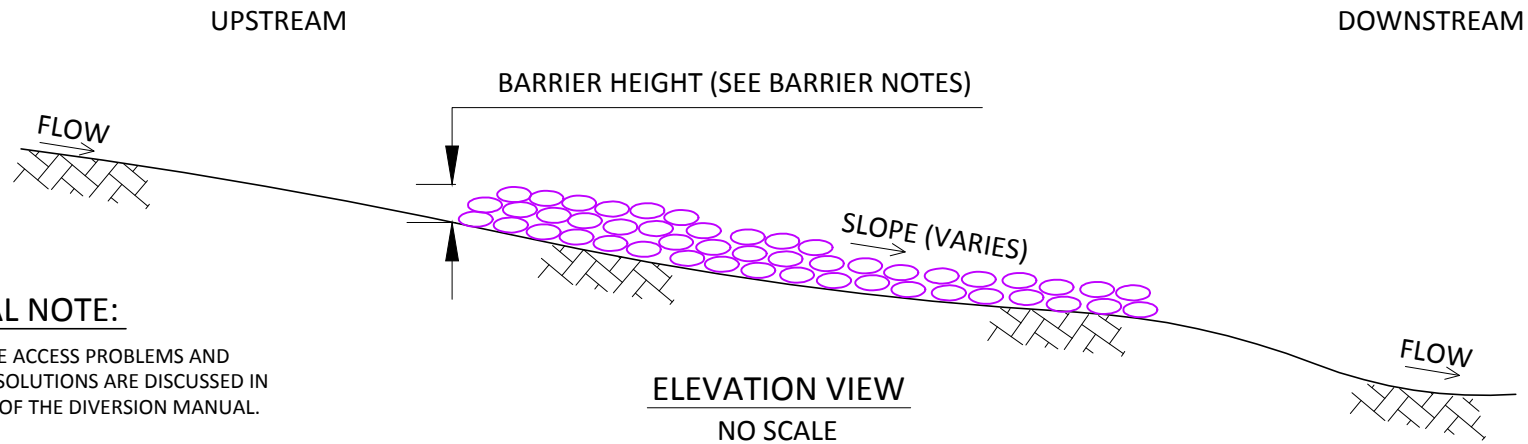

GENERAL NOTE:

- 1. POSSIBLE SITE ACCESS PROBLEMS AND APPLICABLE SOLUTIONS ARE DISCUSSED IN SECTION 3.4 OF THE DIVERSION MANUAL.

BARRIER NOTES	BMPs
o RECOMMENDED APPLICABILITY OF EARTHEN BERMS IS PROVIDED IN SECTION 3.1 (TABLE 3-2); SEE BMP FOR ADDITIONAL DETAILS.	EC-9
o ADDITIONAL DETAILS AND CONSIDERATIONS ARE PROVIDED IN BMP FOR WATER DIVERSION IMPLEMENTATION.	NS-5
o RECOMMENDED APPLICABILITY OF SANDBAG BERMS IS PROVIDED IN SECTION 3.1 (TABLE 3-2); SEE BMP FOR ADDITIONAL DETAILS.	SE-6
o RECOMMENDED APPLICABILITY OF GRAVELBAG BERMS IS PROVIDED IN SECTION 3.1 (TABLE 3-2); SEE BMP FOR ADDITIONAL DETAILS.	SE-8
o BARRIER TYPE SELECTION WILL BE A PROJECT-SPECIFIC DECISION; HEIGHT OF BARRIER WILL BE BASED ON CURRENT FLOW RATES (SEE SECTION 3.1 AND TABLE 3-2).	EC-9, SE-4, SE-6, SE-8
BYPASS NOTES	BMPs
o USE OF VELOCITY DISSIPATION DEVICES MAY BE RECOMMENDED FOR BYPASS APPLICATIONS; SEE BMP FOR ADDITIONAL DETAILS.	EC-10
o CUSTOMIZED APPLICATIONS OF CHECK DAMS MAY BE SUBSTITUTED FOR VELOCITY DISSIPATION, SEE BMP FOR ADDITIONAL DETAILS.	SE-4
INFLOW CONTROL NOTES	BMPs
o WHERE STORM DRAIN OUTLETS WITH LITTLE OR NO FLOW ARE PRESENT, PREVENT WATER INFLOW WITH SANDBAG BARRIER; SEE BMP FOR ADDITIONAL DETAILS.	SE-8
GENERAL NOTES	BMPs
o TIMING OF FIELD ACTIVITIES SHALL BE CONSIDERED IN DEVELOPING THE WORK PLAN AND PROJECT SCHEDULE; SEE BMP FOR ADDITIONAL DETAILS.	EC-1
o AS REQUIRED BY REACH OR AS REASONABLE FOR A PROJECT, MEASURES SHALL BE TAKEN TO PRESERVE VEGETATION IN THE WORK AREA; SEE BMP FOR ADDITIONAL DETAILS.	EC-2
o DUST CONTROL SHALL BE IMPLEMENTED WHENEVER HEAVY EQUIPMENT IS USED IN MAINTENANCE OR REPAIR ACTIVITIES AND GROUND DISTURBANCE IS PLANNED; SEE BMP FOR ADDITIONAL DETAILS.	WE-1
o FOR DEMOLITION, EXCAVATION, OR OTHER EARTHWORK ADJACENT TO SURFACE WATER, PRECAUTIONS SHALL BE TAKEN TO CONTAIN DEBRIS AND LOOSE SOIL; SEE BMP FOR ADDITIONAL DETAILS.	NS-12
o FIELD PERSONNEL SHALL TAKE PRECAUTIONS TO AVOID SPILLING OR LEAKING CONTAMINANTS DURING MAINTENANCE OR REPAIR ACTIVITIES; SEE BMP FOR ADDITIONAL DETAILS.	WM-4
o FIELD PERSONNEL SHALL MAINTAIN CLEAN WORK/STAGING AREAS, MANAGE AND CONTAIN POTENTIALLY HAZARDOUS MATERIALS, AND PROVIDE ADEQUATE WASTE RECEPTACLES; SEE BMP DETAILS.	SC-60

LONGITUDINAL BARRIER(S) WITH PARTIAL CHANNEL ISOLATION,
AND AN OPEN-CHANNEL BYPASS CONVEYANCE RESTRICTED
TO THE CENTER OF THE EXISTING SOFT-BOTTOM CHANNEL

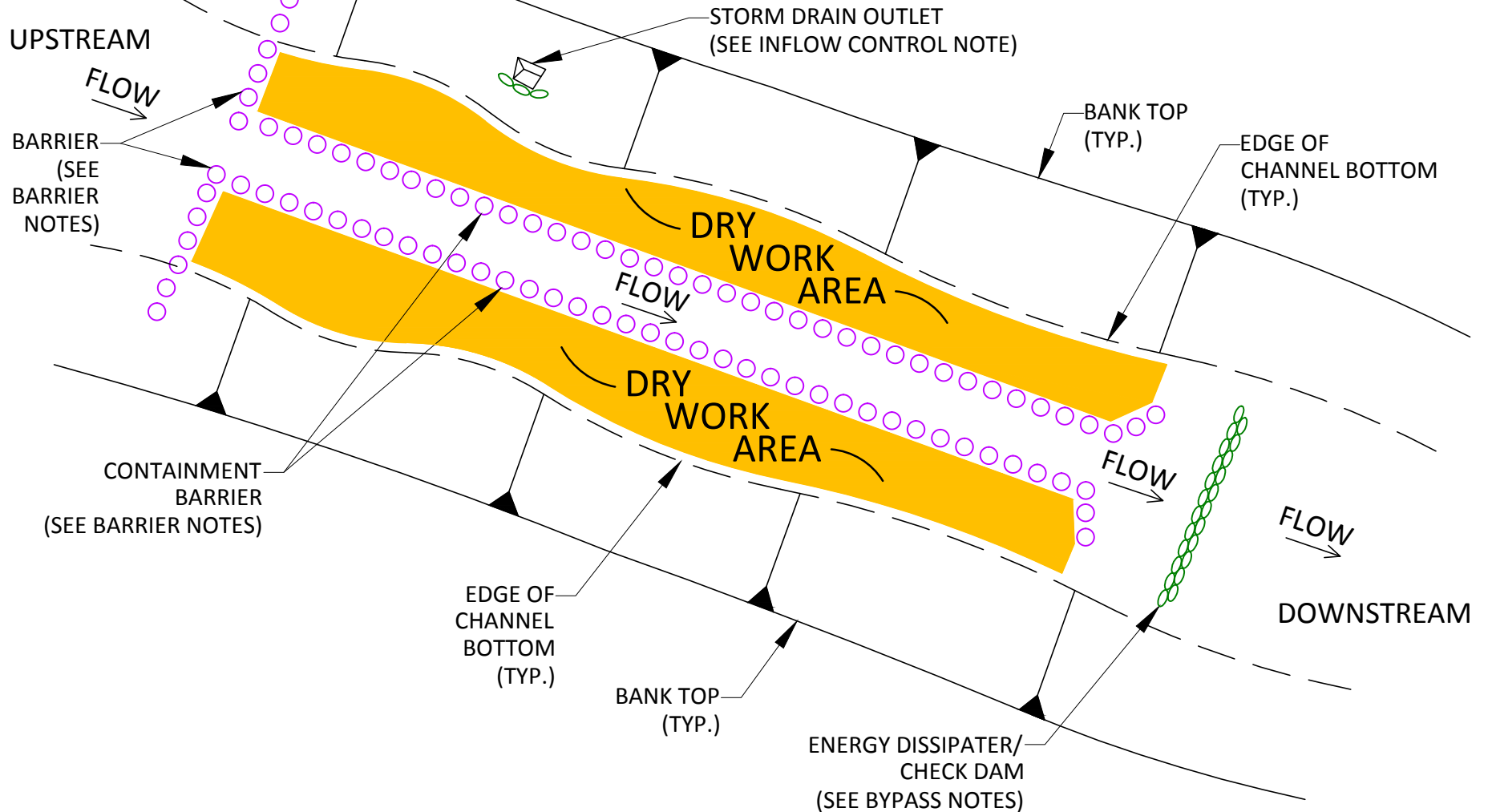

PLAN VIEW

NO SCALE

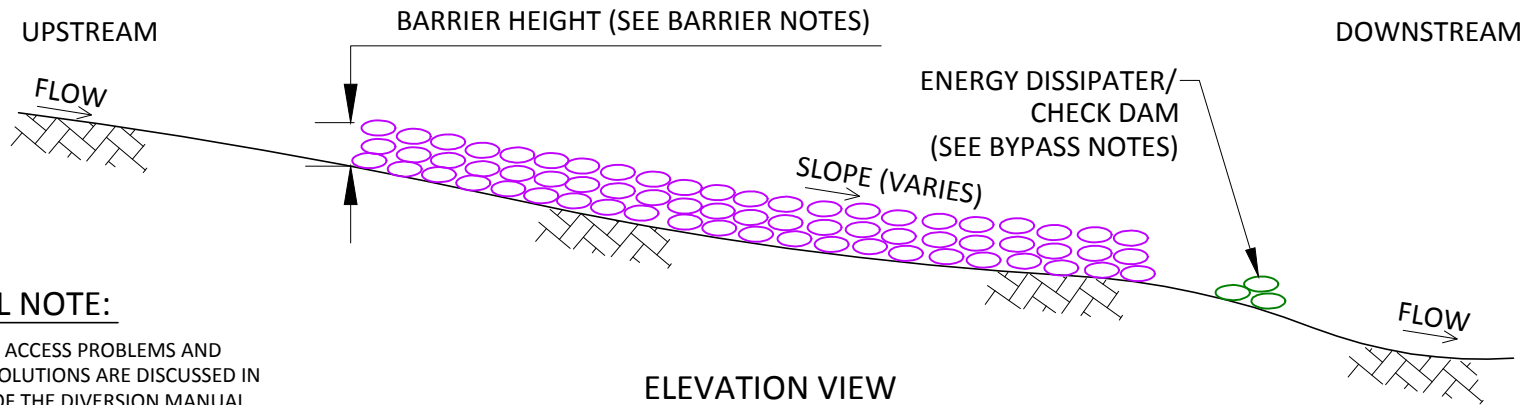

GENERAL NOTE:

1. POSSIBLE SITE ACCESS PROBLEMS AND APPLICABLE SOLUTIONS ARE DISCUSSED IN SECTION 3.4 OF THE DIVERSION MANUAL.

BARRIER NOTES	BMPs
o RECOMMENDED APPLICABILITY OF EARTHEN BERMS IS PROVIDED IN SECTION 3.1 (TABLE 3-2); SEE BMP FOR ADDITIONAL DETAILS.	EC-9
o ADDITIONAL DETAILS AND CONSIDERATIONS ARE PROVIDED IN BMP FOR WATER DIVERSION IMPLEMENTATION.	NS-5
o RECOMMENDED APPLICABILITY OF SANDBAG BERMS IS PROVIDED IN SECTION 3.1 (TABLE 3-2); SEE BMP FOR ADDITIONAL DETAILS.	SE-6
o RECOMMENDED APPLICABILITY OF GRAVELBAG BERMS IS PROVIDED IN SECTION 3.1 (TABLE 3-2); SEE BMP FOR ADDITIONAL DETAILS.	SE-8
o BARRIER TYPE SELECTION WILL BE A PROJECT-SPECIFIC DECISION; HEIGHT OF BARRIER WILL BE BASED ON CURRENT FLOW RATES (SEE SECTION 3.1 AND TABLE 3-2).	EC-9, SE-4, SE-6, SE-8
BYPASS NOTES	BMPs
o USE OF VELOCITY DISSIPATION DEVICES MAY BE RECOMMENDED FOR BYPASS APPLICATIONS; SEE BMP FOR ADDITIONAL DETAILS.	EC-10
o CUSTOMIZED APPLICATIONS OF CHECK DAMS MAY BE SUBSTITUTED FOR VELOCITY DISSIPATION, SEE BMP FOR ADDITIONAL DETAILS.	SE-4
INFLOW CONTROL NOTES	BMPs
o WHERE STORM DRAIN OUTLETS WITH LITTLE OR NO FLOW ARE PRESENT, PREVENT WATER INFLOW WITH SANDBAG BARRIER; SEE BMP FOR ADDITIONAL DETAILS.	SE-8
GENERAL NOTES	BMPs
o TIMING OF FIELD ACTIVITIES SHALL BE CONSIDERED IN DEVELOPING THE WORK PLAN AND PROJECT SCHEDULE; SEE BMP FOR ADDITIONAL DETAILS.	EC-1
o AS REQUIRED BY REACH OR AS REASONABLE FOR A PROJECT, MEASURES SHALL BE TAKEN TO PRESERVE VEGETATION IN THE WORK AREA; SEE BMP FOR ADDITIONAL DETAILS.	EC-2
o DUST CONTROL SHALL BE IMPLEMENTED WHENEVER HEAVY EQUIPMENT IS USED IN MAINTENANCE OR REPAIR ACTIVITIES AND GROUND DISTURBANCE IS PLANNED; SEE BMP FOR ADDITIONAL DETAILS.	WE-1
o FOR DEMOLITION, EXCAVATION, OR OTHER EARTHWORK ADJACENT TO SURFACE WATER, PRECAUTIONS SHALL BE TAKEN TO CONTAIN DEBRIS AND LOOSE SOIL; SEE BMP FOR ADDITIONAL DETAILS.	NS-12
o FIELD PERSONNEL SHALL TAKE PRECAUTIONS TO AVOID SPILLING OR LEAKING CONTAMINANTS DURING MAINTENANCE OR REPAIR ACTIVITIES; SEE BMP FOR ADDITIONAL DETAILS.	WM-4
o FIELD PERSONNEL SHALL MAINTAIN CLEAN WORK/STAGING AREAS, MANAGE AND CONTAIN POTENTIALLY HAZARDOUS MATERIALS, AND PROVIDE ADEQUATE WASTE RECEPTACLES; SEE BMP DETAILS.	SC-60

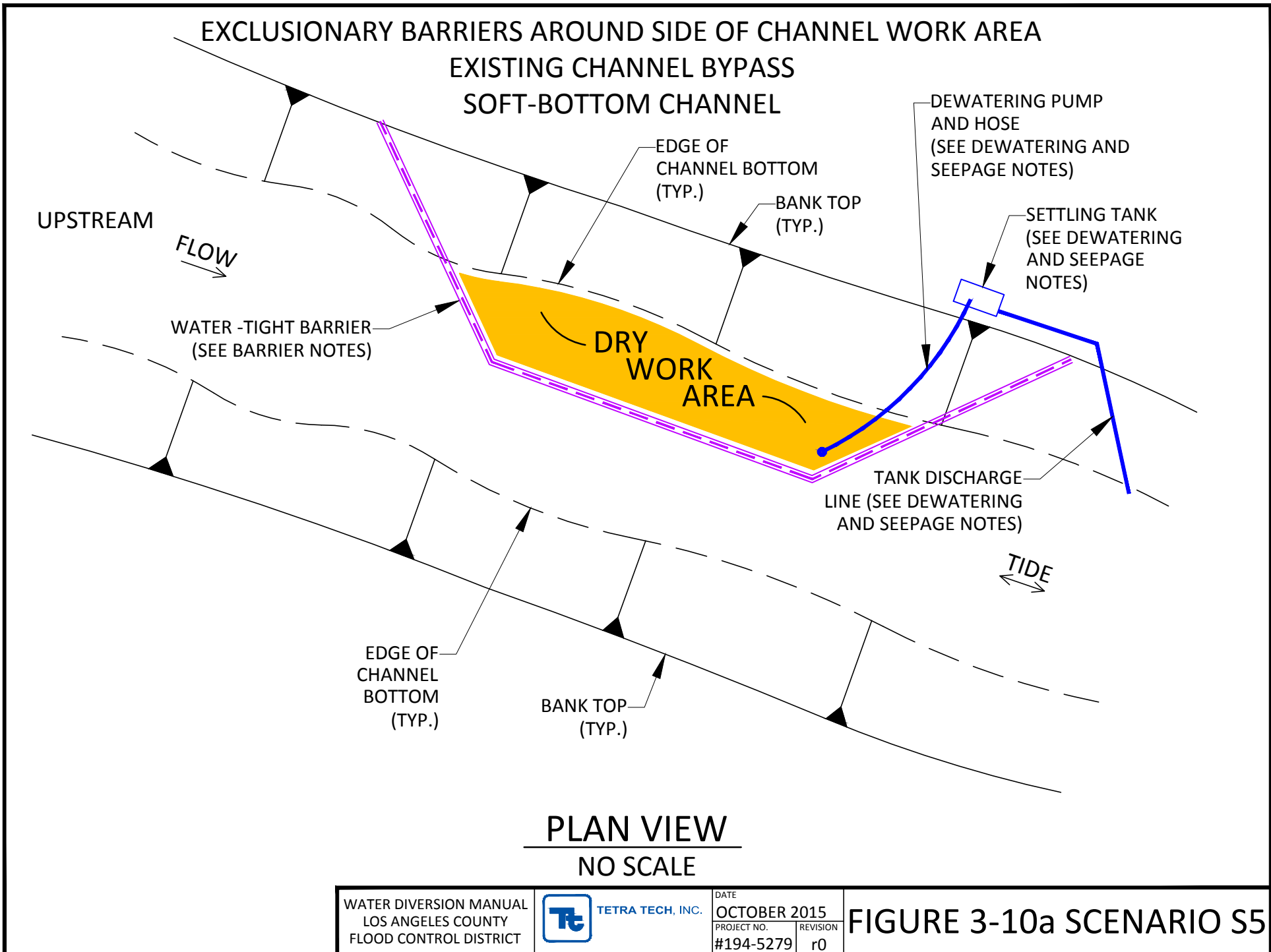

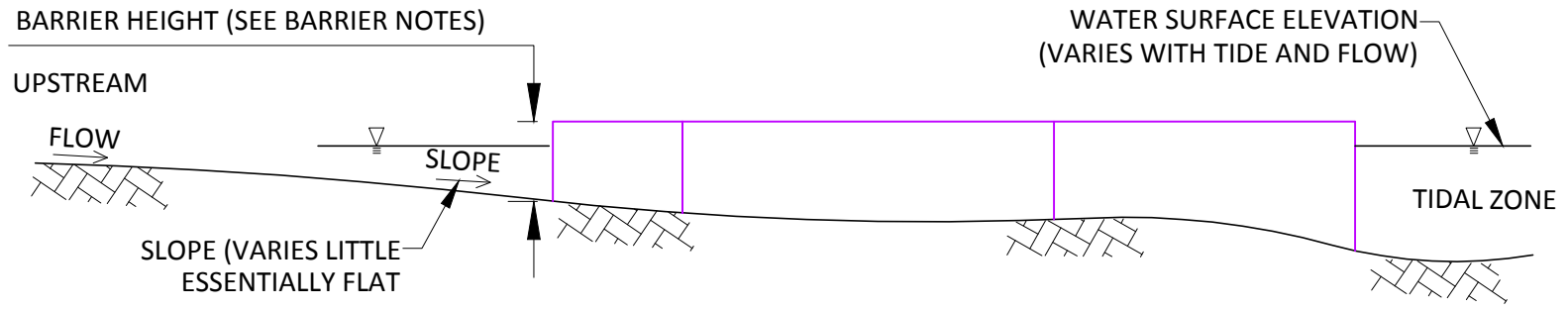

ELEVATION VIEW
NO SCALE

BARRIER NOTES	BMPs
o BARRIER TYPE SELECTION WILL BE A PROJECT-SPECIFIC DECISION; SHEET PILE IS LIKELY OPTION FOR SOFT-BOTTOM CHANNELS.	
o HEIGHT OF BARRIER MUST ACCOUNT FOR WATER DEPTH, HIGH TIDE ELEVATION, AND REQUIRED FREEBOARD.	
o PROVIDE DEWATERING PUMPS AND SETTLING BASINS/TANKS AS REQUIRED TO REMOVE WATER FROM WORK AREA AND CONTROL SEEPAGE; SEE BMP FOR ADDITIONAL DETAILS.	NS-2
DEWATERING AND SEEPAGE CONTROL NOTES	BMPs
o OBTAIN ALL REQUIRED PERMIT APPROVALS FOR DISCHARGE OF WATER REMOVED THROUGH DEWATERING ACTIVITIES.	
o PROVIDE DEWATERING PUMPS AND SETTLING BASINS/TANKS AS REQUIRED TO REMOVE WATER FROM WORK AREA AND CONTROL SEEPAGE; SEE BMP FOR ADDITIONAL DETAILS.	NS-2
o TYPE, SIZE, AND NUMBER OF SETTLING BASINS/TANKS NEEDED WILL BE DETERMINED ON A PROJECT SPECIFIC BASIS.	
o TYPE, SIZE, AND NUMBER OF PUMPS REQUIRED WILL BE BASED ON THE VOLUME OF WATER TO REMOVE AND THE ANTICIPATED RATE OF SEEPAGE.	
INFLOW CONTROL NOTES	BMPs
o WHERE STORM DRAIN OUTLETS WITH LITTLE OR NO FLOW ARE PRESENT, PREVENT WATER INFLOW WITH SANDBAG BARRIER; SEE BMP FOR ADDITIONAL DETAILS.	SE-8
GENERAL NOTES	BMPs
o TIMING OF FIELD ACTIVITIES SHALL BE CONSIDERED IN DEVELOPING THE WORK PLAN AND PROJECT SCHEDULE; SEE BMP FOR ADDITIONAL DETAILS.	EC-1
o AS REQUIRED BY CHANNEL REACH OR AS REASONABLE FOR A PROJECT, MEASURES SHALL BE TAKEN TO PRESERVE VEGETATION IN THE WORK AREA; SEE BMP FOR ADDITIONAL DETAILS.	EC-2
o ACCESS TO DRY WORK AREA BY HEAVY EQUIPMENT WILL BE FROM BANK TOP USING LONG-REACH MECHANICAL ARMS.	
o ACCESS TO DRY WORK AREA BY PERSONNEL FOR HAND-WORK WILL BE BY LADDER FROM BANK TOP, ALL NECESSARY SAFETY PRECAUTIONS WILL BE CONSIDERED AND ADDRESSED.	
o DUST CONTROL SHALL BE IMPLEMENTED WHENEVER HEAVY EQUIPMENT IS USED IN MAINTENANCE OR REPAIR ACTIVITIES AND GROUND DISTURBANCE IS PLANNED; SEE BMP FOR ADDITIONAL DETAILS.	WE-1
o FOR DEMOLITION, EXCAVATION, OR OTHER EARTHWORK ADJACENT TO SURFACE WATER, PRECAUTIONS SHALL BE TAKEN TO CONTAIN DEBRIS AND LOOSE SOIL; SEE BMP FOR ADDITIONAL DETAILS.	NS-12
o FIELD PERSONNEL SHALL TAKE PRECAUTIONS TO AVOID SPILLING OR LEAKING CONTAMINANTS DURING MAINTENANCE OR REPAIR ACTIVITIES; SEE BMP FOR ADDITIONAL DETAILS.	WM-4
o FIELD PERSONNEL SHALL MAINTAIN CLEAN WORK/STAGING AREAS, MANAGE AND CONTAIN POTENTIALLY HAZARDOUS MATERIALS, AND PROVIDE ADEQUATE WASTE RECEPTACLES; SEE BMP DETAILS.	SC-60

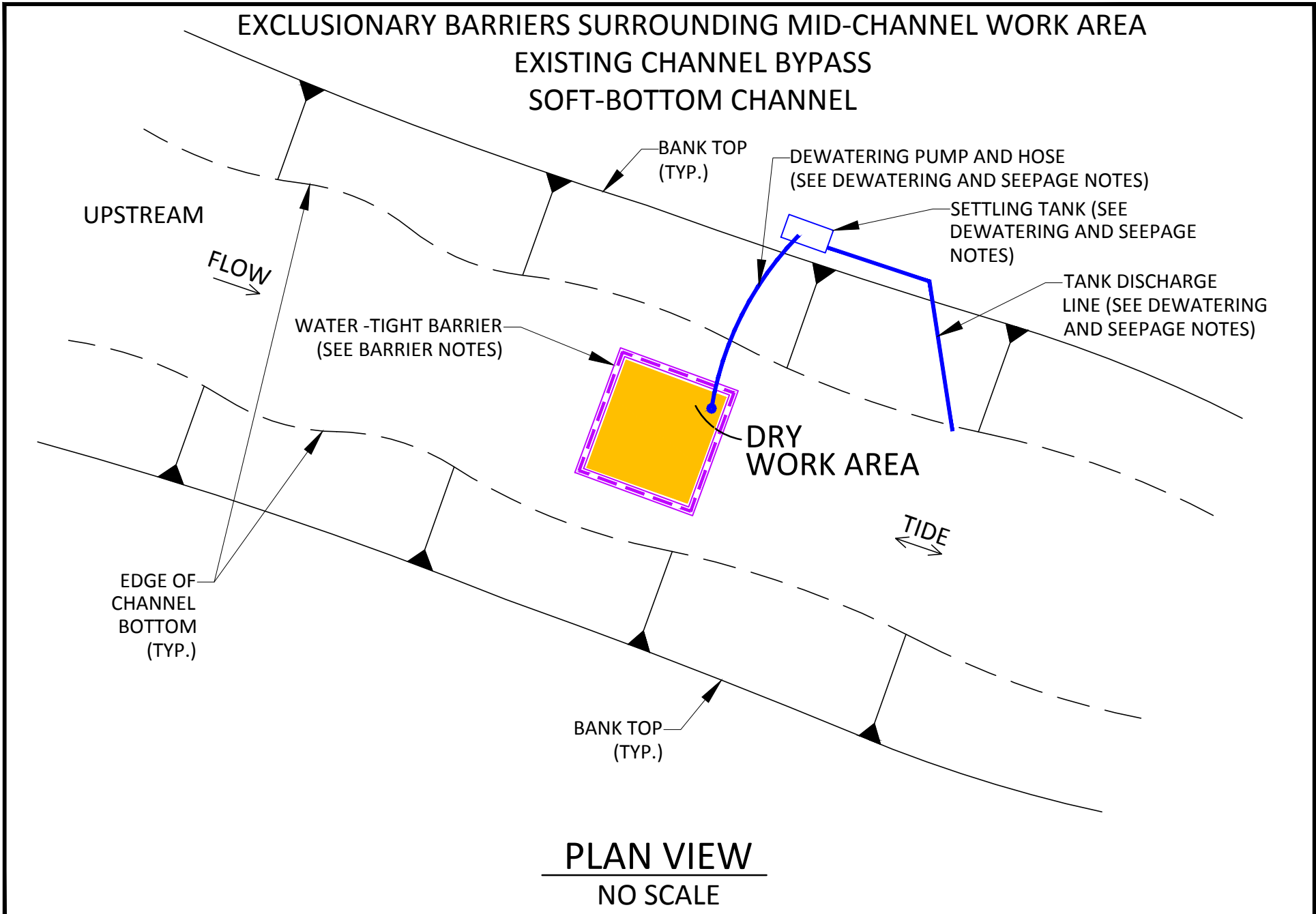

PLAN VIEW
NO SCALE

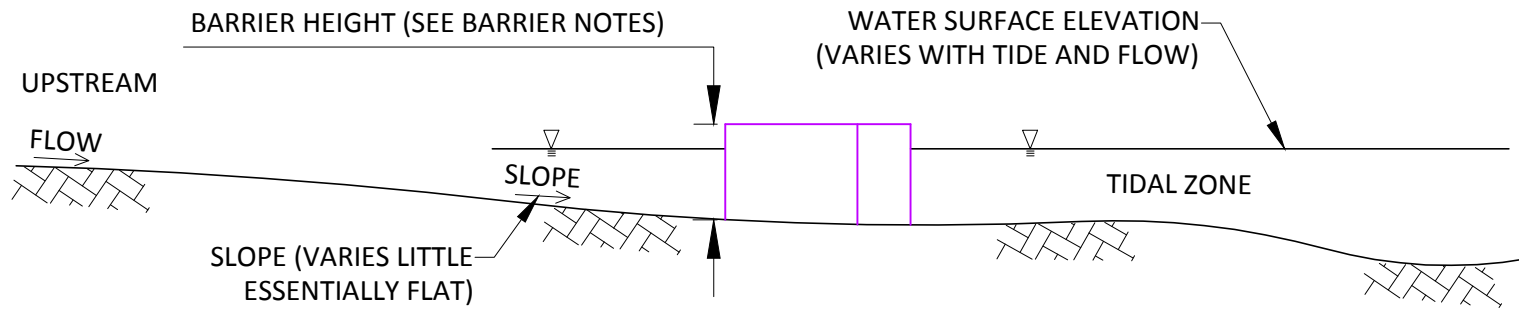

ELEVATION VIEW
NO SCALE

BARRIER NOTES	BMPs
o BARRIER TYPE SELECTION WILL BE A PROJECT-SPECIFIC DECISION; SHEET PILE IS LIKELY OPTION FOR SOFT-BOTTOM CHANNELS.	
o HEIGHT OF BARRIER MUST ACCOUNT FOR WATER DEPTH, HIGH TIDE ELEVATION, AND REQUIRED FREEBOARD.	
o PROVIDE DEWATERING PUMPS AND SETTLING BASINS/TANKS AS REQUIRED TO REMOVE WATER FROM WORK AREA AND CONTROL SEEPAGE; SEE BMP FOR ADDITIONAL DETAILS.	NS-2
DEWATERING AND SEEPAGE CONTROL NOTES	BMPs
o OBTAIN ALL REQUIRED PERMIT APPROVALS FOR DISCHARGE OF WATER REMOVED THROUGH DEWATERING ACTIVITIES.	
o PROVIDE DEWATERING PUMPS AND SETTLING BASINS/TANKS AS REQUIRED TO REMOVE WATER FROM WORK AREA AND CONTROL SEEPAGE; SEE BMP FOR ADDITIONAL DETAILS.	NS-2
o TYPE, SIZE, AND NUMBER OF SETTLING BASINS/TANKS NEEDED WILL BE DETERMINED ON A PROJECT SPECIFIC BASIS.	
o TYPE, SIZE, AND NUMBER OF PUMPS REQUIRED WILL BE BASED ON THE VOLUME OF WATER TO REMOVE AND THE ANTICIPATED RATE OF SEEPAGE.	
INFLOW CONTROL NOTES	BMPs
o WHERE STORM DRAIN OUTLETS WITH LITTLE OR NO FLOW ARE PRESENT, PREVENT WATER INFLOW WITH SANDBAG BARRIER; SEE BMP FOR ADDITIONAL DETAILS.	SE-8
GENERAL NOTES	BMPs
o TIMING OF FIELD ACTIVITIES SHALL BE CONSIDERED IN DEVELOPING THE WORK PLAN AND PROJECT SCHEDULE; SEE BMP FOR ADDITIONAL DETAILS.	EC-1
o AS REQUIRED BY CHANNEL REACH OR AS REASONABLE FOR A PROJECT, MEASURES SHALL BE TAKEN TO PRESERVE VEGETATION IN THE WORK AREA; SEE BMP FOR ADDITIONAL DETAILS.	EC-2
o ACCESS TO DRY WORK AREA BY HEAVY EQUIPMENT WILL BE FROM FLOATING PLATFORM OR BRIDGE DECK USING LONG-REACH MECHANICAL ARMS.	
o ACCESS TO DRY WORK AREA BY PERSONNEL FOR HAND-WORK WILL BE BY LADDER FROM FLOATING PLATFORM OR BRIDGE DECK, WITH ALL NECESSARY SAFETY PRECAUTIONS ADDRESSED.	
o DUST CONTROL SHALL BE IMPLEMENTED WHENEVER HEAVY EQUIPMENT IS USED IN MAINTENANCE OR REPAIR ACTIVITIES AND GROUND DISTURBANCE IS PLANNED; SEE BMP FOR ADDITIONAL DETAILS.	WE-1
o FOR DEMOLITION, EXCAVATION, OR OTHER EARTHWORK ADJACENT TO SURFACE WATER, PRECAUTIONS SHALL BE TAKEN TO CONTAIN DEBRIS AND LOOSE SOIL; SEE BMP FOR ADDITIONAL DETAILS.	NS-12
o FIELD PERSONNEL SHALL TAKE PRECAUTIONS TO AVOID SPILLING OR LEAKING CONTAMINANTS DURING MAINTENANCE OR REPAIR ACTIVITIES; SEE BMP FOR ADDITIONAL DETAILS.	WM-4
o FIELD PERSONNEL SHALL MAINTAIN CLEAN WORK/STAGING AREAS, MANAGE AND CONTAIN POTENTIALLY HAZARDOUS MATERIALS, AND PROVIDE ADEQUATE WASTE RECEPTACLES; SEE BMP DETAILS.	SC-60

- **Construction Mat.** Where unconsolidated materials need to be traversed and sensitive underground utilities are present, use of a construction mat (or temporary access mat) may be able (with appropriate engineering design considerations) to effectively distribute the weight from heavy equipment over a larger area than the footprint of the underground line and provide some reduction in the effects of vibration. Various types of mats are available that use a variety of materials from metal to plastic (see Figure 3-12).
- **Crane Lift.** Where ground access using other acceptable methods is not possible, and heavy equipment is needed in the dry work area, individual equipment pieces can be lifted into the work area using a crane. An appropriate crane size will be needed for the weight of equipment used and the distance to be covered with the lift (see Figure 3-13).
- **Floating Platform.** Where there is strong tidal influence, and the project dry work area is too distant from the bank or an existing bridge, a floating platform (i.e. a barge or equivalent alternative) can be used for site access. For some heavy equipment (of limited size) a crane can be used on the floating platform to lower equipment into the dry-work area (see Figure 3-14).
- **Long-Reach Equipment.** To eliminate the need to be in the channel, when the work area is close enough to the bank top, use of equipment that can provide a long reach through an extended and/or articulating arm. Such equipment can provide access to maintenance areas while limiting the size of potential disturbance during project activities (see Figure 3-15).
- **Low-Tide Access.** If a tidal channel site is accessible overland during low tide, equipment and materials can be driven in during the low tide window.
- **Temporary Bridging.** A number of options for temporary bridging can be used to aid personnel with site access (see Figure 3-16). These address situations where a limited amount of ground clearance is needed to not disturb above-ground piping or at-grade utilities, a ramp up and over a sensitive linear feature is required, or a bridge over an open channel or other hole is necessary. To separate the potential effects of heavy equipment on subsurface utility lines, an elevated platform can be used to distribute the equipment weight to a limited number of footings that are not located directly over an underground line. Elevated platforms can also reduce the effects of vibration on the underground line. Reduction of impacts can be achieved with a height gain of as little as 6 inches. If a limited width of above-ground piping or at-grade utilities must be crossed to reach a project area, temporary ramps can be provided to clear sensitive features. A ramp-over structure can be made of a variety of materials acceptable for use in surface water conveyance channels. Similar to a ramp-over crossing, but intended for

channels or open holes, a temporary bridge can be used to economically span distances up to 50 feet in length. This could provide the ability to cross an entire channel (if small enough and having banks with adequate strength) or just a smaller feature like the low-flow channel of a much larger concrete-lined channel. In addition to providing an access route, temporary bridging can also be used as an effective platform for staging long-reach equipment.

A common scenario that provides site access challenges to the LACFCD is when crossing water within the channel bottom cannot be avoided. Figures 3-17 and 3-18 provide examples of this scenario, and the application of temporary bridging methods shown in Figure 3-16 to prevent vehicles and heavy equipment from contacting the water when accessing the project site. The first example is a scenario where a transverse barrier contains the water in the channel to allow diversion around the work area, but the contained water also inundates the only access route (Figure 3-17). In this case an elevated platform is used to keep the access route above the water. The second scenario has the necessary site access route crossing the diverted flow below the transverse barrier (see Figure 3-18). In this example an elevated structure and a bridge structure would both be used to keep site traffic out of the water. Other possible scenarios for site access challenges might use one or more of the temporary site access methods identified in Table 3-3 to avoid water contact, damage to utilities, or harm to other sensitive features.

3.5 SEDIMENT MANAGEMENT

Management techniques to contain erosion and off-site sediment transport during water diversion and further maintenance and repair activities (as well as to contain within-channel sediment which might be disturbed during these activities) can include a number of BMPs which are generally applied to construction activities.

- Measures will be taken to minimize sediment disturbance during maintenance and repair activities (see Section 5.1 and Section 5.3).
- To prevent off-site movement of sediment, measures will be taken to contain mobilized or suspended sediment (see Section 5.2 and 5.4) and manage sediment taken offsite on equipment (see Section 5.5).
- To limit sediment transported by the diverted water, measures will be taken to allow suspended sediment to settle out of the water before entering the bypass, after discharge by the bypass, and during any associated dewatering (see Section 5.2 and 5.4).
- To limit the introduction of wastes or hazardous wastes into the channel during project activities, measures will be taken to control wastes and pollutants (see Section 5.6 Waste Management and Materials Pollution Control) and maintain a clean project site (see Section 5.7).



NOTES:

1. APPROPRIATE SITE-SPECIFIC ENGINEERING DESIGN IS REQUIRED TO ASSURE NECESSARY PROTECTION.
2. AVAILABLE MAT MATERIALS INCLUDE HDPE, WOOD, AND STEEL.
3. MAT DESIGN IS MODULAR WITH INDIVIDUAL UNITS COMBINED TO COVER REQUIRED DIMENSIONS OF WORK AREA.
4. MAT CONFIGURATION IS VARIABLE BASED ON ASSEMBLY OF UNITS WITH SPECIFIED DIMENSIONS.
5. DESIGN AND COMPOSITION OF INDIVIDUAL UNITS INCLUDE SOLID NATIVE MATERIALS, MANUFACTURED COMPOSITES, METALS (PERFORATED OR SOLID), AND ENGINEERED GRIDS (PICTURED).
6. INSTALLATION WILL FOLLOW MANUFACTURERS REQUIREMENTS FOR BASE LAYER UNDER MAT.

CONSTRUCTION MAT

NO SCALE

WATER DIVERSION MANUAL
LOS ANGELES COUNTY
FLOOD CONTROL DISTRICT



TETRA TECH, INC.

DATE	
OCTOBER 2015	
PROJECT NO.	REVISION
#194-5279	r0

FIGURE 3-12

NOTES:

1. VERIFY CRANE LIFT AND REACH WILL MEET PROJECT REQUIREMENTS PRIOR TO MOBILIZATION TO SITE.
2. EQUIPMENT SUPPLIER WILL PROVIDE A CRANE OPERATOR CERTIFIED FOR THE CRANE DEPLOYED.
3. EQUIPMENT AND RIGGING WILL BE INSPECTED DAILY PRIOR TO FIRST USE.
4. A MINIMUM OF ONE SPOTTER, IN ADDITION TO CRANE OPERATOR, WILL BE USED AT ALL TIMES.
5. NO OTHER PERSONNEL WILL BE IN CRANE OPERATING AREA DURING ACTIVE LIFTS.
6. CRANE OPERATIONS WILL FOLLOW STANDARD PROCEDURES TO INSURE ALL SAFETY PRECAUTIONS ARE ENFORCED DURING CRANE LIFTS.



CRANE LIFT
NO SCALE

WATER DIVERSION MANUAL
LOS ANGELES COUNTY
FLOOD CONTROL DISTRICT



TETRA TECH, INC.

DATE	OCTOBER 2015
PROJECT NO.	REVISION
#194-5279	r0

FIGURE 3-13



NOTES:

1. DETERMINE WHAT TYPE OF FLOATING PLATFORM WILL BE USED; A DECK BARGE OR A SPUD BARGE ARE OPTIONS.
2. INSURE THAT A LICENSED MASTER OF A TOWING VESSEL WILL BE RESPONSIBLE FOR MOVING THE BARGE INTO POSITION.
3. ESTABLISH THE APPROPRIATE MOORING OPTION TO HOLD BARGE IN PLACE WHEN IN USE.

FLOATING PLATFORM

NO SCALE

WATER DIVERSION MANUAL
LOS ANGELES COUNTY
FLOOD CONTROL DISTRICT



TETRA TECH, INC.

DATE	
OCTOBER 2015	
PROJECT NO.	REVISION
#194-5279	r0

FIGURE 3-14

NOTES:

1. WHERE APPROPRIATE USE LONG-REACH, HEAVY EQUIPMENT WITH CUTTER/MULCHER ATTACHMENTS TO REACH INTO CHANNEL FROM BANKTOP.
2. USE STANDARD SAFETY PRECAUTIONS FOR WORKERS AROUND HEAVY EQUIPMENT.
3. ANY ON-SITE MULCHING WILL FOLLOW SITE-SPECIFIC REQUIREMENTS TO CAPTURE CUT MATERIALS AND AVOID SPREADING SEEDS.

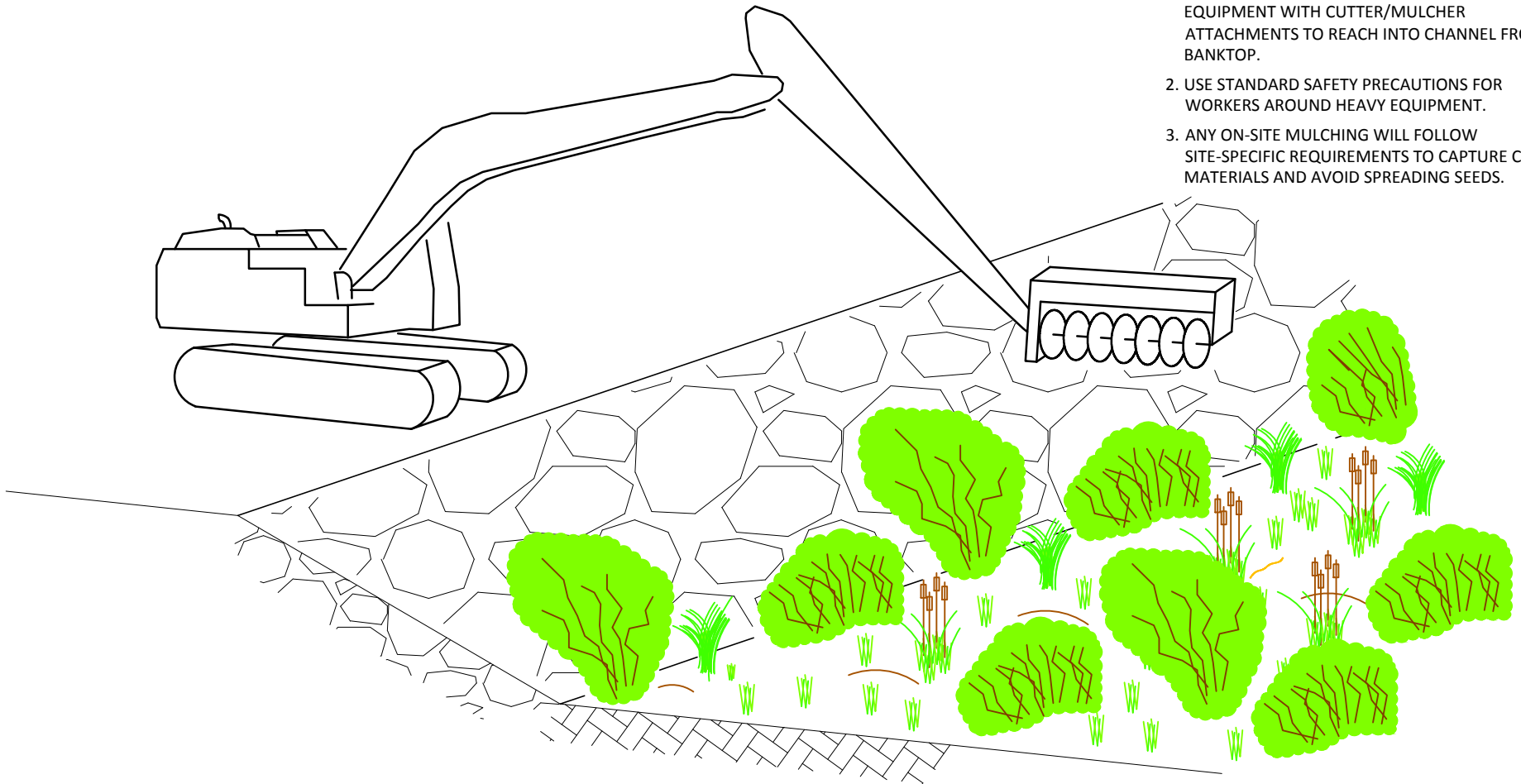

LONG-REACH EQUIPMENT

NO SCALE

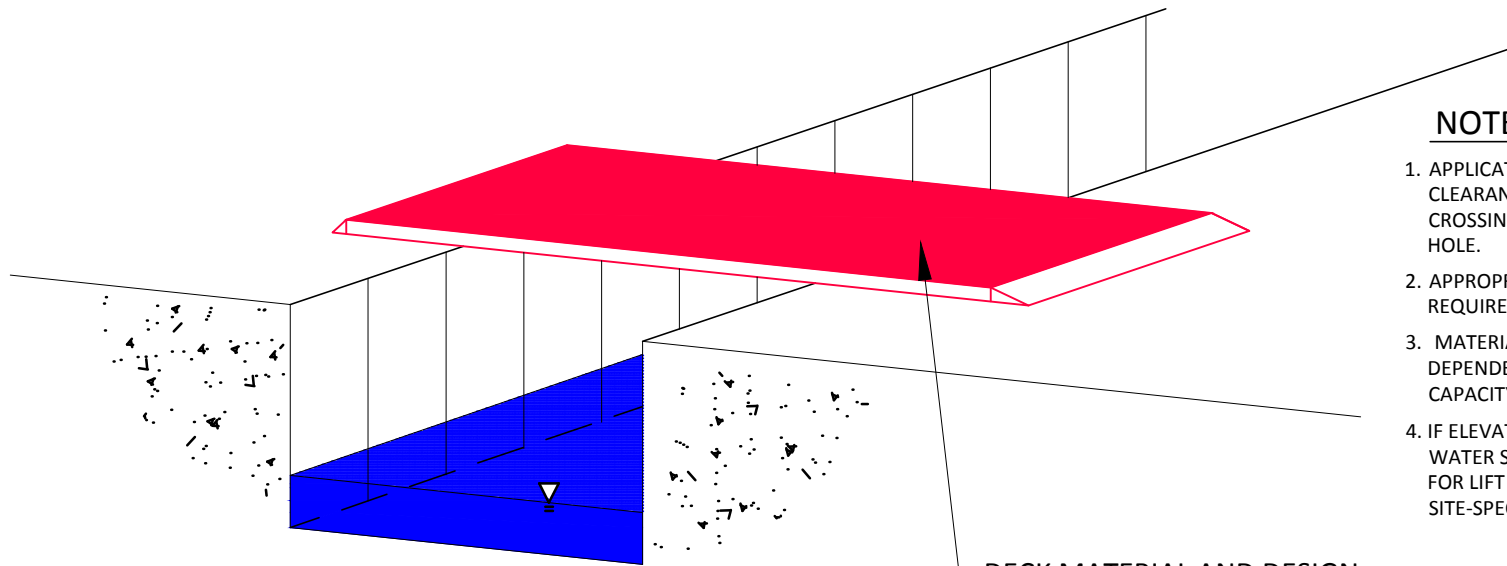

A. BRIDGE STRUCTURE

DECK MATERIAL AND DESIGN
WILL BE PROJECT-SPECIFIC

NOTES:

1. APPLICATIONS CAN VARY FROM LIMITED CLEARANCE REQUIREMENTS TO A STANDARD CROSSING OVER A CHANNEL OR OTHER OPEN HOLE.
2. APPROPRIATE ENGINEERING DESIGN IS REQUIRED TO ASSURE NECESSARY PROTECTION.
3. MATERIALS USED FOR BRIDGING WILL BE DEPENDENT ON SITE CONDITIONS AND BRIDGE CAPACITY REQUIREMENTS.
4. IF ELEVATION/CLEARANCE OVER GROUND OR WATER SURFACE IS NEEDED; MATERIALS USED FOR LIFT WILL BE DETAILED IN AN APPROPRIATE, SITE-SPECIFIC ENGINEERING DESIGN.

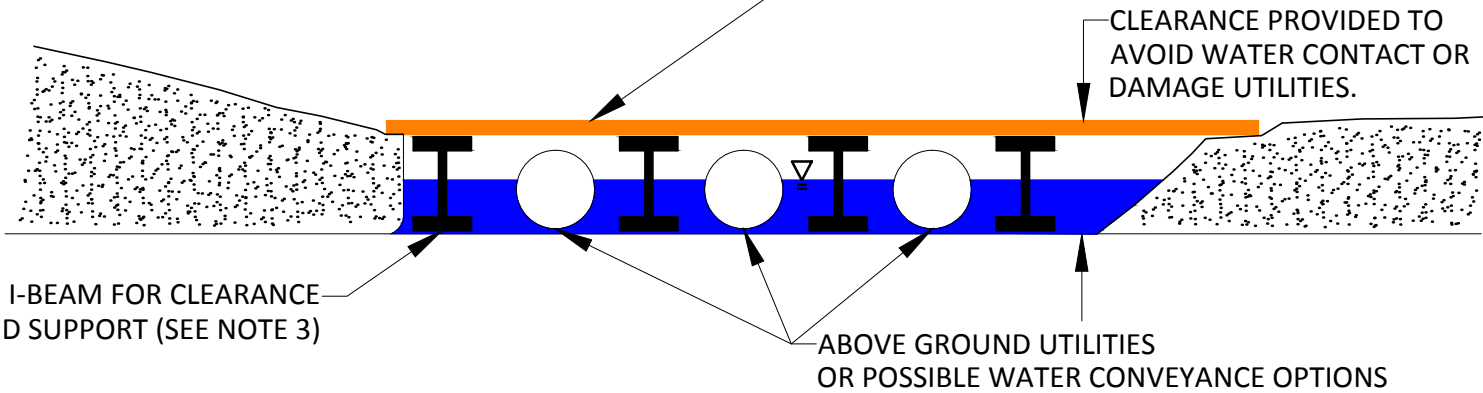

CLEARANCE PROVIDED TO
AVOID WATER CONTACT OR
DAMAGE UTILITIES.

I-BEAM FOR CLEARANCE
AND SUPPORT (SEE NOTE 3)

ABOVE GROUND UTILITIES
OR POSSIBLE WATER CONVEYANCE OPTIONS

B. ELEVATED STRUCTURE

TEMPORARY BRIDGING

NO SCALE

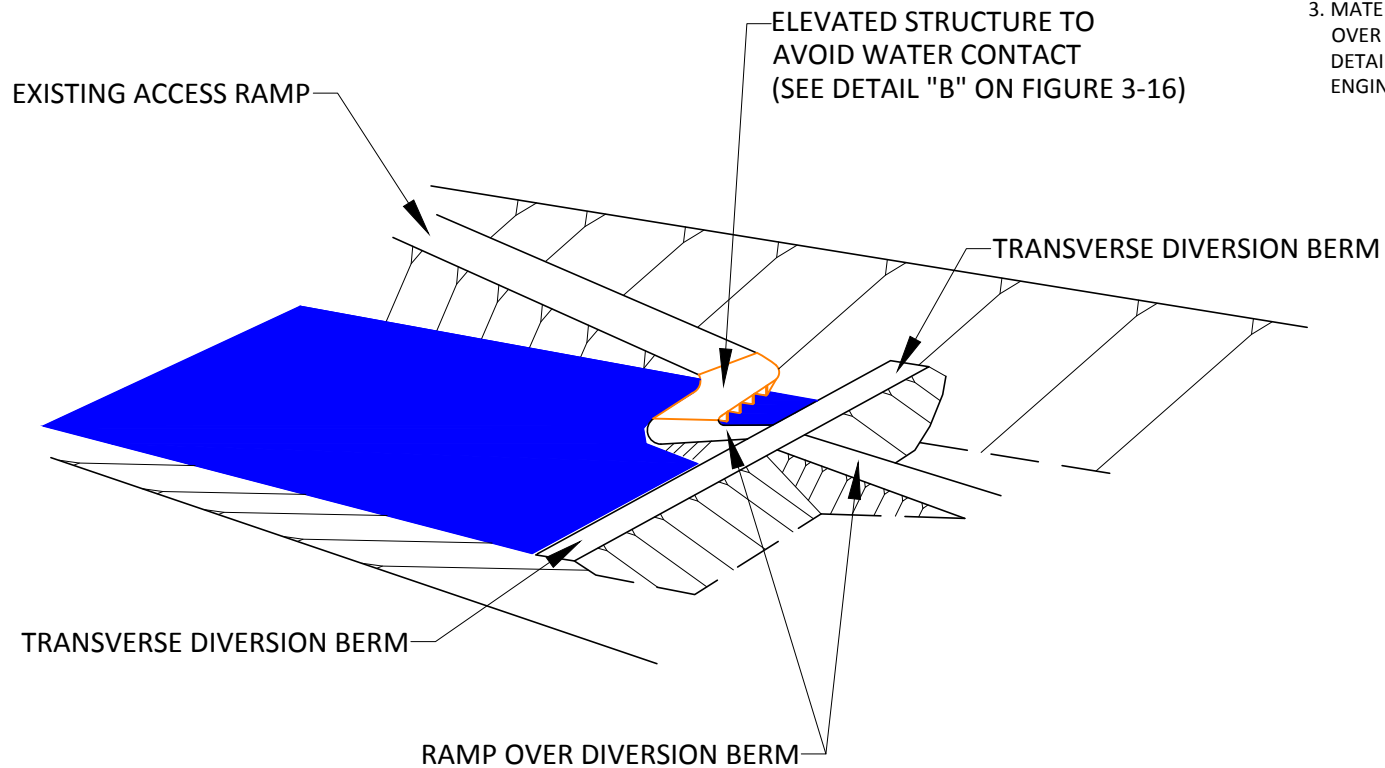

NOTES:

1. APPROPRIATE ENGINEERING DESIGN IS REQUIRED TO ASSURE NECESSARY PROTECTION.
2. MATERIALS USED FOR BRIDGING WILL DEPEND ON SITE CONDITIONS AND BRIDGE CAPACITY REQUIREMENTS.
3. MATERIALS USED FOR ELEVATION/CLEARANCE OVER WATER OR GROUND SURFACE, WILL BE DETAILED IN AN APPROPRIATE, SITE-SPECIFIC ENGINEERING DESIGN.

**STANDING WATER ACCESS
ABOVE DIVERSION**

NO SCALE

NOTES:

1. APPROPRIATE ENGINEERING DESIGN IS REQUIRED TO ASSURE NECESSARY PROTECTION.
2. MATERIALS USED FOR BRIDGING WILL DEPEND ON SITE CONDITIONS AND BRIDGE CAPACITY REQUIREMENTS.
3. MATERIALS USED FOR ELEVATION/CLEARANCE OVER WATER OR GROUND SURFACE, WILL BE DETAILED IN AN APPROPRIATE, SITE-SPECIFIC ENGINEERING DESIGN.

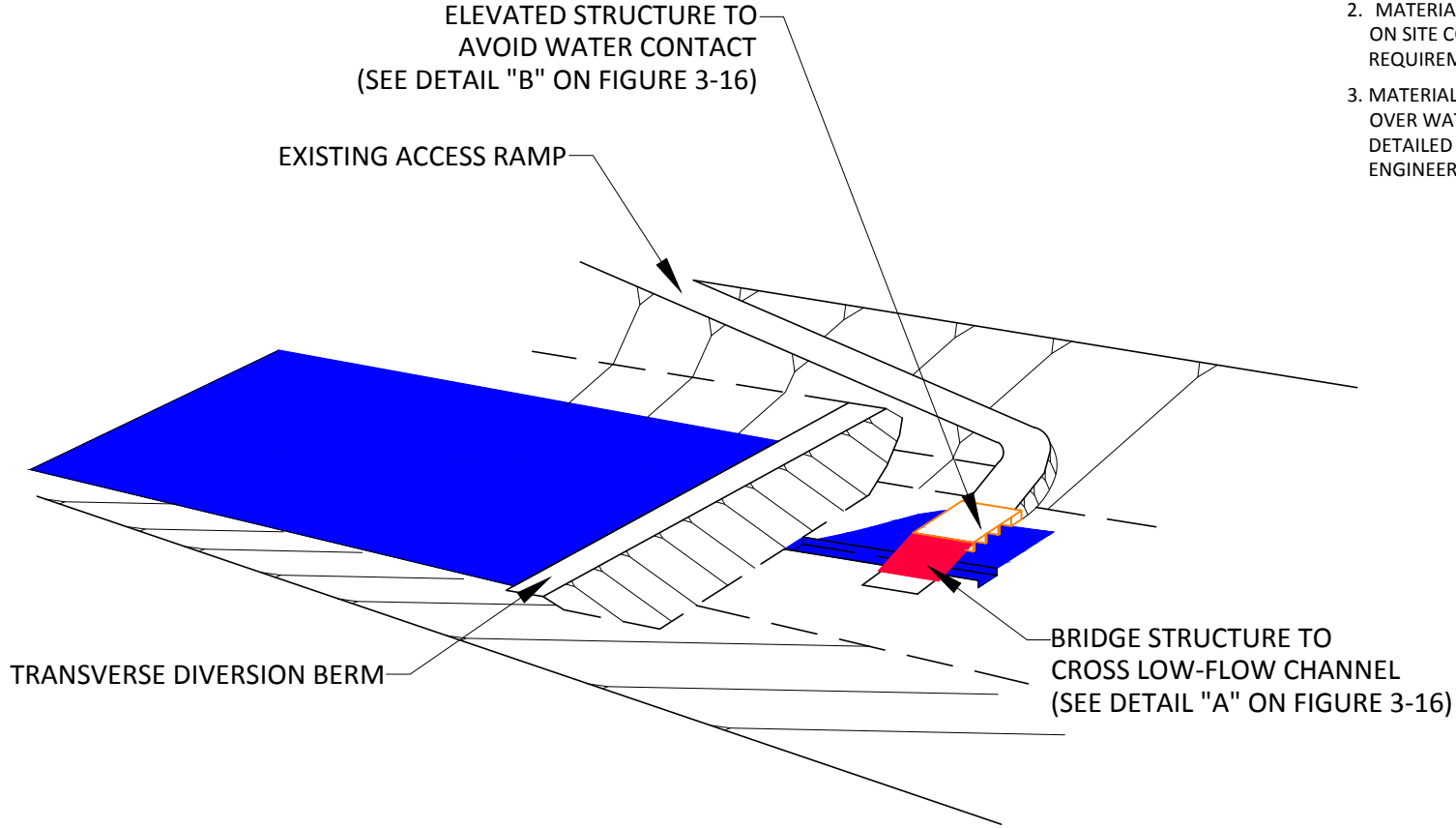

**STANDING WATER ACCESS
BELOW DIVERSION**

NO SCALE

WATER DIVERSION MANUAL LOS ANGELES COUNTY FLOOD CONTROL DISTRICT	 TETRA TECH, INC.	DATE	OCTOBER 2015	
		PROJECT NO.	#194-5279	REVISION

FIGURE 3-18

3.6 SENSITIVE SPECIES CONSIDERATIONS

In addition to the physical considerations for water diversion and management of sediment, a number of sensitive species have been identified within various flood facilities maintained by the LACFCD. The species and the specific reaches to which they have been associated are listed in Table 3-4. As a result of these identified species and locations, and the possibility of identification elsewhere, LACFCD incorporates a number of measures into the water diversion process to provide protection for sensitive species. They are:

- A biological survey is performed by a qualified biologist prior to project initiation at every project reach (not just those listed in Table 3-4).
- If any sensitive species are located in or adjacent to the project reach, or potential habitat for sensitive species is identified within the reach, then all permitted requirements for the identified species will be followed in the preparation for, and execution of, the project.
- Applicable requirements are provided in the WDR issued by the Los Angeles RWQCB, the Biological Opinion and Take Permit issued by the USFWS (for a specific species), and the SAA issued by the CDFW.
- For any reaches identified with sensitive species concerns, either through pre-project surveys or by inclusion in Table 3-4, special precautions will be implemented. These precautions will fall into two general categories those protecting (1) aquatic and amphibian species and (2) avian species (see Table 3-5).
- A qualified biologist will be on-site at any project with identified sensitive species during all project-related activities, including installation of BMPs, implementation of all water diversion features, all project related activities (i.e. channel maintenance emergency repair actions), and all project wrap-up and demobilization activities.

Although the presence of sensitive species does not limit the applicability of any of the BMPs included in this Manual to the process of water diversion, it can affect the application (timing, location, configuration, and installation process) of individual BMPs within a given project reach. Although the protection measures described in Table 3-5 are not demonstrated on the generic water diversion scenarios provided here (Figures 3-1 through 3-11), they will be incorporated as applicable into the Project Water Diversion Plan (see Section 4 and Appendix B).

Table 3-4
Reaches with Potential for Sensitive Species

Reach	Reach Name	Species
7	Bull Creek M.C.O.	Potential for: LBV and SWF
12	Haines Canyon M.C.O.	Potential for: LBV, SAS, and SWF
14	May Channel (M.C.O. Into Pacoima Canyon)	Known occupation by: LBV Potential for: SWF
27	Wilmington Drain	Known territory for: LBV Potential for: SWF
28	Triunfo Creek (PD T2200)	Potential for: LBV, SWF, and WPT
39	Beatty Channel Outlet @ SGR 25+99.00	Known territory for: LBV Potential for: SAS and SWF
40	(b)San Gabriel River – I-10 Freeway to Thienes Avenue	Known territory for: LBV Potential for: SWF
43	(a) San Gabriel River- Upper	Known territory for: LBV Potential for: SWF
43	(b) San Gabriel River- Lower	Known territory for: LBV Potential for: SWF
47	Santa Clara River Main Channel (PD T1733 Unit 1)	Potential for: UTS
51	Mint Canyon M.C.O. (PD 1894)/Santa Clara River – Main Channel	Potential for: UTS
54	Santa Clara River, Non-Main Channel (PD 832), Main Channel Outlet	Potential for: UTS
55	Santa Clara River Main Channel – Right Bank Reach (PD's 910, 832, 1758, & 1562 Unit 2)	Potential for: UTS
56	Santa Clara River Main Channel – Left Bank Reach (PD 832)	Potential for: UTS
58	Santa Clara River Main Channel – Right Bank Reach (PD 374)	Potential for: UTS
60	Santa Clara River Main Channel – Right Bank Reach (PD's 1339 and 374)	Potential for: UTS
61	Santa Clara River Main Channel (PD 659 & 754)	Potential for: UTS
63	Oak Ave Road Drainage (CDR 523.081)	Potential for: UTS
64	Soledad Canyon Road Drain (CDR 523.071 D outlet)	Potential for: UTS
66	Santa Clara River Main Channel (PD 1538)	Potential for: UTS
67	Bouquet Canyon Upper (PD's 1201, 802, 700B, & 625)	Potential for: UTS
69	Bouquet Canyon Middle (PD's 722, 773, 1365, 1065, & 451)	Known occurrence: UTS

Table 3-4
Reaches with Potential for Sensitive Species

Reach	Reach Name	Species
70	Bouquet Canyon Lower (PD's 544 & 345)	Potential for: UTS
71	Santa Clara River Main Channel (PD 1946)	Potential for: AT, LBV, SWF, and UTS
75	South Fork - Santa Clara River (PD's 725, 916, 1041, & 1300)	Potential for: AT, LBV, SWF, and UTS
79	South Fork - Santa Clara River (Valencia Boulevard Bridge Stabilizer)	Potential for: AT, LBV, SWF, and UTS
80	South Fork - Santa Clara River (PD's 1947 & 1946)	Potential for: AT, LBV, SWF, and UTS
82	Santa Clara River Main Channel (PD 2278)	Potential for: AT, LBV, SWF, and UTS
86	Violin Canyon Main Channel Outlet	Potential for: AT, LBV, SWF, and UTS
87	Castaic - Old Road Drainage (CDR 525.021D) Outlet	Potential for: AT, LBV, SWF, and UTS
97	PD T1982, Castaic Creek	Potential for: AT, LBV, SWF, and UTS

Abbreviations:

ESA	Endangered Species Act
FE	Species designated as endangered under the federal ESA
SE	Species designated as endangered under the California ESA
FT	Species designated as threatened under the federal ESA
OT	"Other" listed endangered species
M.C.O.	Main channel outlet
PD	Private drain
USACE	U.S. Army Corps of Engineers
NWP	Nationwide Permit
CDFW	California Department of Fish and Wildlife
CRPR	California Rare Plant Ranks

Species and Designation:

FISH	
UTS	Unarmored threespine stickleback (FE/SE)
SAS	Santa Ana sucker (FT)
ANIMAL	
AT	Arroyo toad (FE)
LBV	Least Bell's vireo (FE/SE)
SWF	Southwestern willow flycatcher (FE/SE)
WPT	Western pond turtle (OT)

Table 3-5
Sensitive Species Protection Measures

Species Group	Protection Measures
<p><i>Aquatic and Amphibian Species</i></p> <ul style="list-style-type: none"> • Unarmored threespine stickleback • Santa Ana sucker • Arroyo toad • Western pond turtle 	<ol style="list-style-type: none"> 1. A qualified biologist shall conduct a pre-construction survey of the area to identify sensitive fish species. 2. No work shall be performed in areas where unarmored threespine stickleback, Santa Ana sucker, arroyo toad, and western pond turtle are known to occur without prior agency approval. 3. If unarmored threespine stickleback, Santa Ana sucker, arroyo toad, and western pond turtle are identified in the work area, all work shall cease and USFWS/CDFW shall be notified immediately. The USFWS/CDFW will determine whether work may continue in areas where these species have been identified. 4. Prior to construction of a transverse barrier, the channel will be isolated upstream and downstream of the project reach at appropriate locations. Isolation will remain in place until construction activities are completed and bypass is removed. Actions used to implement this isolation will include the following: <ul style="list-style-type: none"> • Block nets will be placed entirely across the channel at both upstream and downstream locations (extending into substrate of soft-bottom channels or weighted in concrete-lined channels) under the direct supervision of a qualified biologist. • As directed by the qualified biologist, a seine net (or other appropriate equipment) will be used to recover fish, macroinvertebrates, and amphibians from the project reach. • All recovered aquatic life will be relocated (in water-filled buckets) to the channel either upstream or downstream of the project reach (and outside the installed block nets). • At least three channel sweeps of the full isolated reach will be conducted before the barrier is installed. • On-site biologist must give approval before the barrier can be installed. 5. Any bypass used will be sized to provide adequate flows downstream of the project reach to provide viable habitat conditions. 6. Bypass design will provide for a mesh screen at the inlet for the bypass with a nominal mesh size of 5 mm. 7. If a new bypass channel is used, the on-site biologist will monitor flows during project activities to assure adequate flow volume is provided, and that no organism is stranded during project activities or when bypass is decommissioned. 8. If dewatering of a channel section with standing water is required (see for example Figures 3-4; 3-5; 3-10; and 3-11), seine netting of organisms will continue during the dewatering process until the work area is “dry.”

Table 3-5
Sensitive Species Protection Measures

Species Group	Protection Measures
<p>Avian Species</p> <ul style="list-style-type: none"> • Least Bell's vireo • Southwestern willow flycatcher 	<ol style="list-style-type: none"> 1. No work shall be performed in areas where least Bell's vireo or southwestern willow flycatcher are known to occur without prior agency approval. 2. Avoid construction during the breeding season (March 1 and September 1) to avoid potential impacts to least Bell's vireo and southwestern willow flycatchers. 3. If activities are to occur between March 1 and September 1, a nesting bird survey shall be conducted by a qualified biologist to determine the presence of nests or nesting birds within 100 feet of the construction activities. The nesting bird surveys shall be completed no more than 72 hours prior to any construction activities. The survey will focus on special-status species known to use the area as well as other nesting birds that are protected under the Migratory Bird Treaty Act. 4. If least Bell's vireo or southwestern willow flycatcher are identified, work shall cease and USFWS and CDFW shall be notified immediately. The USFWS/CDFW will determine whether work may continue in areas where these species have been identified. 5. If nesting birds are identified, the nest will be avoided until the eggs have hatched and the nestlings have fledged the nest. The biological monitor will determine the appropriate buffer widths for nest avoidance within the construction area. If the monitor determines the buffer is not effective, the monitor will increase the buffer width, use of visual or sound barrier, or halt work until the birds do not show signs of stress. 6. In areas where suitable habitat for sensitive species is present, every effort shall be made to minimize native vegetation removal within the construction activity area. If vegetation removal is required, the vegetation will be removed by use of hand tools and hauled off site. A biological monitor shall be present to flag native vegetation for avoidance (where feasible) and document vegetation removal areas. 7. A biological monitor shall be present to ensure species protection during construction

4.0 APPROACH TO WATER DIVERSION

Prior to conducting any channel facility maintenance or repair activity in a specific reach, the potential need for water diversion techniques and associated BMPs is determined by the LACFCD. If a need for water diversion is identified, the approach described in this section, relating to planning, selection, and installation of specific water diversion methods and appropriate supportive BMPs, will be followed. The specific project development steps include the following:

- Step 1:** Check for previous work in the project reach that required water diversion for the maintenance or repair activities. Evaluate the degree of success achieved by that previous work in using specific water diversion methods, barrier design, and water conveyance type. Adopt the successful methods, designs, and BMPs applied, and change the less successful as necessary.
- Step 2:** Identify any sensitive species or habitat associated with the reach (see Table 3-3) and all permit requirements that have been established for the reach (see Appendix C, Table C-2). Incorporate all requirements into the planning process.
- Step 3:** Prepare a Project Water Diversion Plan for the project (see Form WDM-1 in Appendix B), to provide a schedule, identify project components, and a project map sheet to show locations for diversion requirements (barriers and conveyance), BMPs, and site access considerations). Preparation of the Project Water Diversion Plan will require selection of the best-suited components for the project based on engineering review and the results of input gathered in Steps 1 and 2 (see also Sections 4.1, 4.2, and 4.3 below). The Project Water Diversion Plan will be available for all field activities.
- Step 4:** Establish the water quality monitoring schedule and requirements for the project in conjunction with the Project Water Diversion Plan. Prior to work crew mobilization, deploy the monitoring team to collect baseline samples (see also Section 4.4 below).

4.1 PLANNING

For a specific reach with a water diversion requirement, the reach location will be assessed for any watershed-specific requirements that could be applicable. Channel type/flow probability (i.e. ephemeral, intermittent, perennial, or tidal), potential for sensitive species, and type of action (routine or emergency) will influence the proposed schedule for the action as well as the implementation of diversion techniques and BMPs.

Based on limitations due to expected surface water flow rate, sensitive species associated with the reach (see Table 3-3), and expected project activity requirements, a project schedule will be developed and a project Work Plan will be prepared. If water diversion is an anticipated requirement of the project, the applicable scenario will be identified (see Section 3.3), a barrier type specified, and a planned conveyance defined. A Project Water Diversion Plan form (see Appendix B) will be prepared as part of project planning in order to lay out the type and location of any barrier(s), the type and location of any water conveyance, and specify the BMPs (see Section 5) planned for inclusion in the diversion implementation.

4.2 SELECTION OF DIVERSION METHODS

The specific diversion method selected for a project will be based on the channel type, channel characteristics, project requirements (what maintenance and repair activities are planned), scheduling requirements (is it an emergency), and any permitting limitations. A number of physical barrier options are possible (see Table 3-1) which offer a variety of applicability (see Table 3-2). The first option is to use a transverse barrier if the channel configuration is appropriate. The second is to use a longitudinal barrier where a transverse barrier is not a viable option. If the latter option is selected, the channel capacity requirements will be determined and the type, size, and location of the barrier will be designed to balance work area needs with conveyance requirements for the diverted water. Some advantages and disadvantages of transverse and longitudinal barriers are provided in Table 4-1 to aid the selection process.

Once the type and purpose of the barrier have been established, the associated conveyance requires little additional choice. If a transverse barrier is planned, either an open system (channel or flume) or a closed system (pipe or hose) is selected. An open system is generally more cost effective but does require more space and greater flexibility for ground disturbance. A closed system can generally accommodate a less flexible site, but its design must consider pipe or hose sizes, whether a pump is needed or gravity flow is possible, and the length of the conveyance. If a longitudinal barrier is planned, the existing channel will be used for conveyance, and the only decisions needed are which portion of the channel will be dedicated to conveyance (where and how wide) and the height of the barrier to be installed. In the case of a tidal channel location, the work defines the barrier location and no conveyance needs to be designed. Table 4-2 provides some considerations for the selection of a conveyance type.

**Table 4-1
Barrier Selection**

Barrier Type	Concrete Lined Channel	Soft-Bottom Channel
Transverse	<p><u>Advantages</u></p> <ol style="list-style-type: none"> 1. Maximizes the work area within the channel reach. 2. Provides optimal flexibility for access to work area. <p><u>Disadvantages</u></p> <ol style="list-style-type: none"> 1. If the project reach is wider than it is long, a transverse barrier can require a larger structure than a longitudinal barrier. 2. Requires adequate storage volume (based on expected flow rate and conveyance capacity). 	<p><u>Advantages</u></p> <ol style="list-style-type: none"> 1. Maximizes the work area within the channel reach. 2. Provides optimal site access flexibility. 3. Best used in narrow channels. <p><u>Disadvantages</u></p> <ol style="list-style-type: none"> 1. If the project reach is wider than it is long, a transverse barrier can require a larger structure than a longitudinal barrier. 2. Requires adequate storage volume (based on expected flow rate and conveyance capacity). 3. May require additional effort to limit or control seepage under the barrier.
Longitudinal	<p><u>Advantages</u></p> <ol style="list-style-type: none"> 1. Minimizes the need for work area isolation. 2. May limit disturbance to in-channel flows and aquatic species. <p><u>Disadvantages</u></p> <ol style="list-style-type: none"> 1. If the work area within the channel is much longer than the channel width, a longitudinal barrier can require more materials and a greater effort than a transverse barrier. 2. May limit site access options. 	<p><u>Advantages</u></p> <ol style="list-style-type: none"> 1. Minimizes the need for work area isolation. 2. May limit disturbance to in-channel flows and aquatic species. 3. Can be used in large (wide) channels). <p><u>Disadvantages</u></p> <ol style="list-style-type: none"> 1. If the work area within the channel is much longer than the channel width, a longitudinal barrier can require more materials and a greater effort than a transverse barrier. 2. May limit site access options. 3. Seepage may be an issue (but not as much as it would be with a transverse barrier).

Table 4-2
Conveyance Selection

Bypass Type	Advantages	Disadvantages
Closed System	<ol style="list-style-type: none"> 1. Greater flexibility for locating bypass route. 2. Eliminates potential for erosion due to bypass conveyance. 3. Provides no opportunity for increasing constituents in water during bypass. 4. Simplifies monitoring requirements (two sampling points instead of three). 	<ol style="list-style-type: none"> 1. Concentrates discharge energy in smaller area (erosive force) downstream. 2. May require use of pumps and electricity.
New Channel or Flume	<ol style="list-style-type: none"> 1. Digging a new channel is a relatively easy task after the route is selected. 2. No materials are required (for digging new channel), just equipment. 3. Relatively easy to maintain. 	<ol style="list-style-type: none"> 1. Flume requires materials and construction. 2. Ground surface disturbance may not be allowed by permit restriction. 3. Will require significant attention to in-channel sediment control and sediment trapping. 4. May require lining if dug in native/local soils. 5. Could raise groundwater recharge issues.
Existing Channel	<ol style="list-style-type: none"> 1. Easiest option to implement. 2. Can accommodate longer reaches more easily. 3. Greater installation flexibility (especially in a wide channel). 	<ol style="list-style-type: none"> 1. A long barrier has greater maintenance requirements and costs.

4.3 SELECTION OF BMPS

A large number of BMPs are available in standardized “Fact Sheet” format that provides the basic information needed to incorporate a tailored version of individual BMPs into a design plan with drawings (Caltrans 2003, CASQA 2009, 2003a, and 2003b). A comprehensive list of the available BMPs for construction projects is provided in Table 4-3, with an indication of the expected applicability to water diversion projects for specific BMPs. There are a few variations in the expected applicability for the scenarios described in Section 3, but there is a standard “core group” of BMPs likely to be used on diversion projects. The general categories of BMPs recognized in the stormwater management community are presented in Section 5, with a brief synopsis of each BMP. A full BMP description for each BMP in the core group is included as Appendix A to this Manual.

After the planning process has established the diversion method and selected the type of barrier and conveyance to be used, individual BMPs will be reviewed for applicability. At a minimum, the BMPs listed in Table 4-3 with a probability rating of “possible” through “expected” under the appropriate scenario for the proposed project will be reviewed. Those BMPs determined to be useful for the reach and the proposed actions

will be indicated on the Project Water Diversion Plan form (see Section 4.1 and Appendix B).

4.4 WATER QUALITY MONITORING

In order to assess the performance of any water diversion methods implemented and all associated BMPs incorporated into the process, water quality monitoring is conducted as part of the water diversion project. The basic process involves three time periods (before, during, and after the diversion project) and up to three locations (upstream, within, and downstream from the project). A limited set of parameters are measured in the field (pH, temperature, dissolved oxygen, and turbidity), and field samples are collected for laboratory analysis of total suspended solids.

A Water Quality Monitoring Guide (Tetra Tech 2015) is available as a companion document to this Manual. The Guide provides details of the water quality monitoring program for water diversion projects, including background on the objectives and parameters, monitoring process, quality assurance/quality control, and all necessary forms and instructions.

Table 4-3
BMP Applicability for Water Diversion

		SCENARIOS										
		C1	C2	C3	C4	C5	S1	S2	S3	S4	S5	S6
EROSION CONTROL												
EC-1	Scheduling	1	1	1	1	1	1	1	1	1	1	1
EC-2	Preservation of Existing Vegetation	n/a	n/a	n/a	n/a	n/a	2	2	2	2	2	2
EC-3	Hydraulic Mulch	n/a	n/a	n/a	n/a	n/a	n/a	n/a	n/a	n/a	n/a	n/a
EC-4	Hydroseeding	n/a	n/a	n/a	n/a	n/a	n/a	n/a	n/a	n/a	n/a	n/a
EC-5	Soil Binders	n/a	n/a	n/a	n/a	n/a	n/a	n/a	n/a	n/a	n/a	n/a
EC-6	Straw Mulch	n/a	n/a	n/a	n/a	n/a	n/a	n/a	n/a	n/a	n/a	n/a
EC-7	Geotextiles & Mats	n/a	n/a	n/a	n/a	n/a	n/a	n/a	n/a	n/a	n/a	n/a
EC-8	Wood Mulching	n/a	n/a	n/a	n/a	n/a	n/a	n/a	n/a	n/a	n/a	n/a
EC-9	Earth Dikes & Drainage Swales	2	3	3	3	3	2	2	3	3	3	3
EC-10	Velocity Dissipation Devices	1	1	1	1	1	1	1	1	1	1	1
EC-11	Slope Drains	n/a	n/a	n/a	n/a	n/a	n/a	n/a	n/a	n/a	n/a	n/a
EC-12	Streambank Protection	3	2	2	2	2	3	3	2	2	2	2
EC-14	Compost Blankets	n/a	n/a	n/a	n/a	n/a	n/a	n/a	n/a	n/a	n/a	n/a
EC-15	Soil Preparation/Roughening	n/a	n/a	n/a	n/a	n/a	n/a	n/a	n/a	n/a	n/a	n/a
EC-16	Non-Vegetative Stabilization	n/a	n/a	n/a	n/a	n/a	n/a	n/a	n/a	n/a	n/a	n/a
SEDIMENT CONTROL												
SE-1	Silt Fence	n/a	n/a	n/a	n/a	n/a	1	1	2	2	3	3
SE-2	Sediment Basin	3	3	3	3	3	3	3	3	3	3	3
SE-3	Sediment Trap	3	3	3	3	3	3	3	3	3	3	3
SE-4	Check Dam	2	1	1	1	1	2	2	1	1	1	1
SE-5	Fiber Rolls	n/a	n/a	n/a	n/a	n/a	n/a	n/a	n/a	n/a	n/a	n/a
SE-6	Gravel Bag Berm	2	2	2	2	2	2	2	2	2	2	2
SE-7	Street Sweeping and Vacuuming	3	2	2	2	2	3	3	2	2	2	2

Table 4-3
BMP Applicability for Water Diversion

		SCENARIOS										
		C1	C2	C3	C4	C5	S1	S2	S3	S4	S5	S6
SE-8	Sandbag Barrier	2	2	2	2	2	2	2	2	2	2	2
SE-9	Straw Bale Barrier	3	3	3	3	3	3	3	3	3	3	3
SE-10	Storm Drain Inlet Protection	n/a	n/a	n/a	n/a	n/a	n/a	n/a	n/a	n/a	n/a	n/a
SE-11	Active Treatment Systems	n/a	n/a	n/a	n/a	n/a	n/a	n/a	n/a	n/a	n/a	n/a
SE-12	Temporary Silt Dike	n/a	n/a	n/a	n/a	n/a	n/a	n/a	n/a	n/a	n/a	n/a
SE-13	Compost Socks and Berms	n/a	n/a	n/a	n/a	n/a	n/a	n/a	n/a	n/a	n/a	n/a
SE-14	Biofilter Bags	n/a	n/a	n/a	n/a	n/a	n/a	n/a	n/a	n/a	n/a	n/a
WIND EROSION												
WE-1	Wind Erosion Control	1	1	1	1	1	1	1	1	1	1	1
NON-STORMWATER MANAGEMENT												
NS-1	Water Conservation Practices	n/a	n/a	n/a	n/a	n/a	n/a	n/a	n/a	n/a	n/a	n/a
NS-2	Dewatering Operations	3	2	2	1	1	3	3	2	2	1	1
NS-3	Paving and Grinding Operations	n/a	n/a	n/a	n/a	n/a	n/a	n/a	n/a	n/a	n/a	n/a
NS-4	Temporary Stream Crossing	3	2	2	2	2	3	3	2	2	2	2
NS-5	Clear Water Diversion	1	1	1	1	1	1	1	1	1	1	1
NS-6	Illicit Connection/ Discharge	n/a	n/a	n/a	n/a	n/a	n/a	n/a	n/a	n/a	n/a	n/a
NS-7	Potable Water/Irrigation	n/a	n/a	n/a	n/a	n/a	n/a	n/a	n/a	n/a	n/a	n/a
NS-8	Vehicle and Equipment Cleaning	2	2	2	2	2	2	2	2	2	2	2
NS-9	Vehicle and Equipment Fueling	n/a	n/a	n/a	n/a	n/a	n/a	n/a	n/a	n/a	n/a	n/a
NS-10	Vehicle and Equipment Maintenance	3	3	3	3	3	3	3	3	3	3	3
NS-11	Pile Driving Operations	n/a	n/a	n/a	n/a	n/a	n/a	n/a	n/a	n/a	n/a	n/a
NS-12	Concrete Curing	n/a	n/a	n/a	n/a	n/a	n/a	n/a	n/a	n/a	n/a	n/a
NS-13	Concrete Finishing	n/a	n/a	n/a	n/a	n/a	n/a	n/a	n/a	n/a	n/a	n/a
NS-14	Material & Equipment Use	n/a	n/a	n/a	n/a	n/a	n/a	n/a	n/a	n/a	n/a	n/a
NS-15	Demolition Adjacent to Water	1	1	1	1	1	1	1	1	1	1	1

Table 4-3
BMP Applicability for Water Diversion

		SCENARIOS										
		C1	C2	C3	C4	C5	S1	S2	S3	S4	S5	S6
NS-16	Temporary Batch Plants	n/a	n/a	n/a	n/a	n/a	n/a	n/a	n/a	n/a	n/a	n/a
WASTE & MATERIALS MANAGEMENT CONTROL												
WM-1	Material Delivery and Storage	n/a	n/a	n/a	n/a	n/a	n/a	n/a	n/a	n/a	n/a	n/a
WM-2	Material Use	n/a	n/a	n/a	n/a	n/a	n/a	n/a	n/a	n/a	n/a	n/a
WM-3	Stockpile Management	n/a	n/a	n/a	n/a	n/a	n/a	n/a	n/a	n/a	n/a	n/a
WM-4	Spill Prevention and Control	1	1	1	1	1	1	1	1	1	1	1
WM-5	Solid Waste Management	2	2	2	2	2	2	2	2	2	2	2
WM-6	Hazardous Waste Management	3	3	3	3	3	3	3	3	3	3	3
WM-7	Contaminated Soil Management	3	3	3	3	3	3	3	3	3	3	3
WM-8	Concrete Waste Management	n/a	n/a	n/a	n/a	n/a	n/a	n/a	n/a	n/a	n/a	n/a
WM-9	Sanitary/Septic Waste Management	n/a	n/a	n/a	n/a	n/a	n/a	n/a	n/a	n/a	n/a	n/a
WM-10	Liquid Waste Management	n/a	n/a	n/a	n/a	n/a	n/a	n/a	n/a	n/a	n/a	n/a
GENERAL STORMWATER MANAGEMENT												
SC-60	Housekeeping Practices	1	1	1	1	1	1	1	1	1	1	1
SC-61	Safer Alternative Products	n/a	n/a	n/a	n/a	n/a	n/a	n/a	n/a	n/a	n/a	n/a

KEY

- 1 Expected (high probability)
- 2 Likely (moderate probability)
- 3 Possible (low probability)

n/a Not expected to be applicable for water diversion projects.
 Included in Appendix A (all others are available from the California Stormwater Quality Association or Caltrans).

This page intentionally left blank.

5.0 BEST MANAGEMENT PRACTICES AND PROCEDURES

The use of BMPs during maintenance and repair activities is intended to reduce potential impacts to surface water quality from projects in LACFCD maintained channels. BMPs provided here are generic versions developed for construction-type activities similar to those conducted during the various maintenance and repair projects. The objectives for BMP application for maintenance and repair projects include:

- Limit the amount of sediment disturbed during project execution.
- Limit the opportunity for any disturbed sediment to be carried off-site by surface water or other means.
- Capture as much disturbed sediment (caused by project activities and carried by surface water or other means) before it moves off-site.
- Manage all field operations to provide a clean work site, limit spills and leaks of hazardous materials, and provide for regular waste collection and disposal.

There are several categories of BMP referenced in this document and provided in full in Appendix A. This is not an exhaustive selection of BMPs, but a reasonable collection of those most likely to be used during LACFCD projects. The categories are described in the following subsections with brief summaries about the applicability of each BMP presented in Appendix A.

5.1 EROSION CONTROL

Erosion control BMPs focus on providing source control for alluvial materials in channels, or soils outside of the channel, that prevents or limits particle detachment and mobilization. These controls can be accomplished in various ways, as summarized in Table 5-1.

Table 5-1
Erosion Control BMPs

BMP#	BMP Name	Applicability
EC-1	Scheduling	Select project timing to eliminate or limit the likelihood of surface water flow in the channel or rainfall events during the project schedule.
EC-2	Preservation of Existing Vegetation	Within the allowances provided by existing permits, leave as much existing vegetation within the work area as possible while accomplishing project objectives (which likely include vegetation removal).
EC-9	Earth Dikes and Drainage Swales	If earthen berms are used for flow control, especially as a barrier to surface water flow within a channel, care is needed to properly size the berm and the volume of the blocked channel, to accommodate the current flow rate.
EC-10	Velocity Dissipation Devices	Where bypass flows are discharged into the existing channel downstream of the work area, velocity dissipation should be provided.

5.2 SEDIMENT CONTROL

Sediment control BMPs address the management of disturbed sediment (see Table 5-2). The general purpose of sediment control is to limit the capacity of surface water (overland or channelized flows) to carry sediment. The concept is to interrupt or to slow down flowing water to reduce its capacity.

Table 5-2
Sediment Control BMPs

BMP#	BMP Name	Applicability
SE-1	Silt Fence	Use of woven geotextile fabric to contain soils and/or sediment within work areas. For maintenance or repair work, silt fences would provide perimeter containment.
SE-4	Check Dam	Structure placed transverse to flow direction in channelized flow. Can be made with various materials, including large rocks, sandbags, and gravel bags. Can be used to provide velocity dissipation at bypass flow outlets.
SE-6	Gravel Bag Berm	Intended for sheet-flow interception and sediment control, gravel bag berms can also be used to create a flow barrier in a water diversion application.
SE-8	Sandbag Barrier	Similar to gravel bag berms, sandbag barriers are generally used for sheet-flow interception and sediment control. However, they can be modified for use as a flow barrier.

5.3 WIND EROSION CONTROL

Erosion and transport of fine particles by wind can be a significant consideration for projects in southern California. Disturbance of ground surfaces or channel beds during maintenance or repair activities creates an opportunity for particle detachment and transport by winds with strong to moderate velocities. Although not directly related to water diversion projects, wind erosion control is a necessary BMP on most project sites (see Table 5-3).

Table 5-3
Wind Erosion BMP

BMP#	BMP Name	Applicability
WE-1	Wind Erosion Control	Use of water or other soil/ sediment binder applied to ground surface to protect soil/sediment particles from detachment.

5.4 NON-STORMWATER MANAGEMENT CONTROL

A number of BMPs address activities that are critical to water diversion projects, including the removal of standing water in work areas, water diversion considerations, and disturbance actions (particularly through demolition) that occurs adjacent to surface water (see Table 5-4).

Table 5-4
Non-Stormwater Management BMPs

BMP#	BMP Name	Applicability
NS-2	Dewatering Operations	Removal of standing water from a project work area to provide access for maintenance and/or repair activities. This also concerns removal or reduction of constituents during water removal.
NS-5	Clearwater Diversion	Diverting water within or from channels to create a dry work area.
NS-15	Demolition Adjacent to Water	Accomplishing demolition and removal of structures, or just earthwork, next to water in channels requires careful planning and execution of the project.

5.5 WASTE MANAGEMENT AND MATERIALS POLLUTION CONTROL

Any field operation using large equipment with on-site re-fueling and vehicle maintenance, or herbicide use with on-site storage requirements, or the need for any other hazardous materials storage on site should take precautions to prevent spills or have a plan for rapid cleanup in the event of a spill. Similarly, solid wastes, hazardous wastes, and contaminated soils/sediment need to be addressed in project work plans with a contingency plan, at a minimum, prepared in advance with handling procedures.

These BMPs provide guidelines for this type of planning in order to put proper procedures in place (see Table 5-5).

Table 5-5
Waste Management Control BMP

BMP#	BMP Name	Applicability
WM-4	Spill Prevention and Control	Provides procedures for storage and handling as well as for cleanup of spills of various sizes.
WM-5	Solid Waste Management	Provides recommendations for collection and handling procedures for on-site wastes (non-liquid and non-hazardous) generated during project activities.
WM-6	Hazardous Waste Management	Provides recommended procedures for managing on-site hazardous wastes to limit potential for release.
WM-7	Contaminated Soil Management	Provides recommendations for safe handling of soils containing contaminants; including evaluation, on-site treatment, and removal for off-site disposal.

5.6 GENERAL STORMWATER MANAGEMENT

General site management plays a role in the potential for off-site sediment migration, and along with it, the possibility of associated hazardous or contaminated materials. The BMP provided for general management addresses good site management practices (see Table 5-6).

Table 5-6
General Stormwater Management BMP

BMP#	BMP Name	Applicability
SC-60	Housekeeping Practices	Provides recommendations on safe and efficient practices for storage, use, and cleanup of materials, particularly harmful or hazardous products. General site management principals are described and product tracking is encouraged.

6.0 REFERENCES

- California Department of Transportation (Caltrans). 2003. Storm Water Quality Handbooks: *Construction Site Best Management Practices (BMPs) Manual*. Available on-line at: <http://www.dot.ca.gov/hq/construc/stormwater/manuals.htm>.
- California Stormwater Quality Association (CASQA). 2003a. *Stormwater Best Management Practice Handbook: Municipal*. Available on-line at: <http://www.casqa.org>.
- . 2003b. *Stormwater Best Management Practice Handbook: New Development and Redevelopment*. Available on-line at: <http://www.casqa.org>.
- . 2009. *Stormwater Best Management Practice Handbook: Construction*. Available on-line at: <http://www.casqa.org>.
- Tetra Tech, Inc. (Tetra Tech). 2015. *Water Quality Monitoring Guide, for Maintenance and Repair Projects Involving Water Diversion*. Prepared for the Los Angeles County Flood Control District, May.

This page intentionally left blank.

Appendix A Applicable Best Management Practices (BMPs)

This page intentionally left blank.

Erosion Control [EC]

This page intentionally left blank.

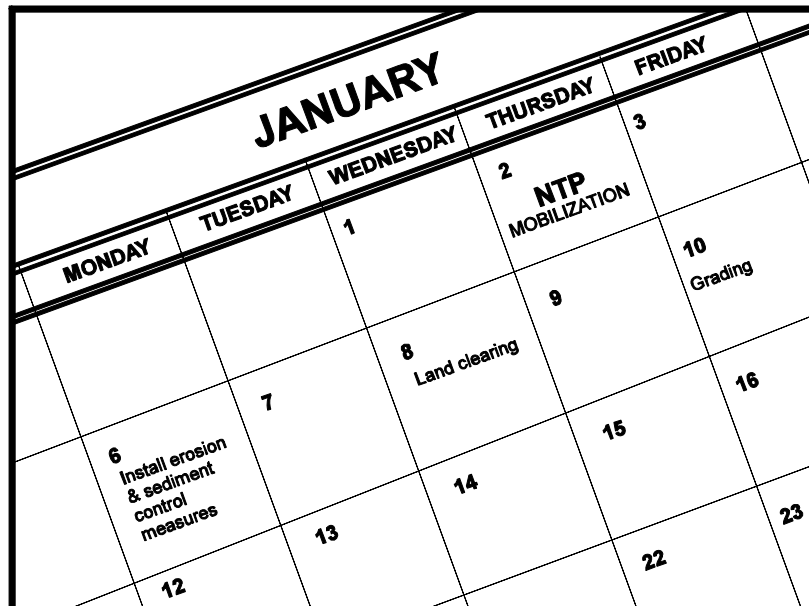

Description and Purpose

Scheduling is the development of a written plan that includes sequencing of construction activities and the implementation of BMPs such as erosion control and sediment control while taking local climate (rainfall, wind, etc.) into consideration. The purpose is to reduce the amount and duration of soil exposed to erosion by wind, rain, runoff, and vehicle tracking, and to perform the construction activities and control practices in accordance with the planned schedule.

Suitable Applications

Proper sequencing of construction activities to reduce erosion potential should be incorporated into the schedule of every construction project especially during rainy season. Use of other, more costly yet less effective, erosion and sediment control BMPs may often be reduced through proper construction sequencing.

Limitations

- Environmental constraints such as nesting season prohibitions reduce the full capabilities of this BMP.

Implementation

- Avoid rainy periods. Schedule major grading operations during dry months when practical. Allow enough time before rainfall begins to stabilize the soil with vegetation or physical means or to install sediment trapping devices.
- Plan the project and develop a schedule showing each phase

Categories

EC	Erosion Control	<input checked="" type="checkbox"/>
SE	Sediment Control	<input checked="" type="checkbox"/>
TC	Tracking Control	<input checked="" type="checkbox"/>
WE	Wind Erosion Control	<input checked="" type="checkbox"/>
NS	Non-Stormwater Management Control	
WM	Waste Management and Materials Pollution Control	

Legend:

- Primary Objective
- Secondary Objective

Targeted Constituents

Sediment	<input checked="" type="checkbox"/>
Nutrients	
Trash	
Metals	
Bacteria	
Oil and Grease	
Organics	

Potential Alternatives

None



of construction. Clearly show how the rainy season relates to soil disturbing and re-stabilization activities. Incorporate the construction schedule into the SWPPP.

- Include on the schedule, details on the rainy season implementation and deployment of:
 - Erosion control BMPs
 - Sediment control BMPs
 - Tracking control BMPs
 - Wind erosion control BMPs
 - Non-stormwater BMPs
 - Waste management and materials pollution control BMPs
- Include dates for activities that may require non-stormwater discharges such as dewatering, sawcutting, grinding, drilling, boring, crushing, blasting, painting, hydro-demolition, mortar mixing, pavement cleaning, etc.
- Work out the sequencing and timetable for the start and completion of each item such as site clearing and grubbing, grading, excavation, paving, foundation pouring utilities installation, etc., to minimize the active construction area during the rainy season.
 - Sequence trenching activities so that most open portions are closed before new trenching begins.
 - Incorporate staged seeding and re-vegetation of graded slopes as work progresses.
 - Schedule establishment of permanent vegetation during appropriate planting time for specified vegetation.
- Non-active areas should be stabilized as soon as practical after the cessation of soil disturbing activities or one day prior to the onset of precipitation.
- Monitor the weather forecast for rainfall.
- When rainfall is predicted, adjust the construction schedule to allow the implementation of soil stabilization and sediment treatment controls on all disturbed areas prior to the onset of rain.
- Be prepared year round to deploy erosion control and sediment control BMPs. Erosion may be caused during dry seasons by un-seasonal rainfall, wind, and vehicle tracking. Keep the site stabilized year round, and retain and maintain rainy season sediment trapping devices in operational condition.
- Apply permanent erosion control to areas deemed substantially complete during the project's defined seeding window.

Costs

Construction scheduling to reduce erosion may increase other construction costs due to reduced economies of scale in performing site grading. The cost effectiveness of scheduling techniques should be compared with the other less effective erosion and sedimentation controls to achieve a cost effective balance.

Inspection and Maintenance

- Verify that work is progressing in accordance with the schedule. If progress deviates, take corrective actions.
- Amend the schedule when changes are warranted.
- Amend the schedule prior to the rainy season to show updated information on the deployment and implementation of construction site BMPs.

References

Stormwater Quality Handbooks Construction Site Best Management Practices (BMPs) Manual, State of California Department of Transportation (Caltrans), November 2000.

Stormwater Management for Construction Activities Developing Pollution Prevention Plans and Best Management Practices (EPA 832-R-92-005), U.S. Environmental Protection Agency, Office of Water, September 1992.

This page intentionally left blank

Preservation Of Existing Vegetation EC-2

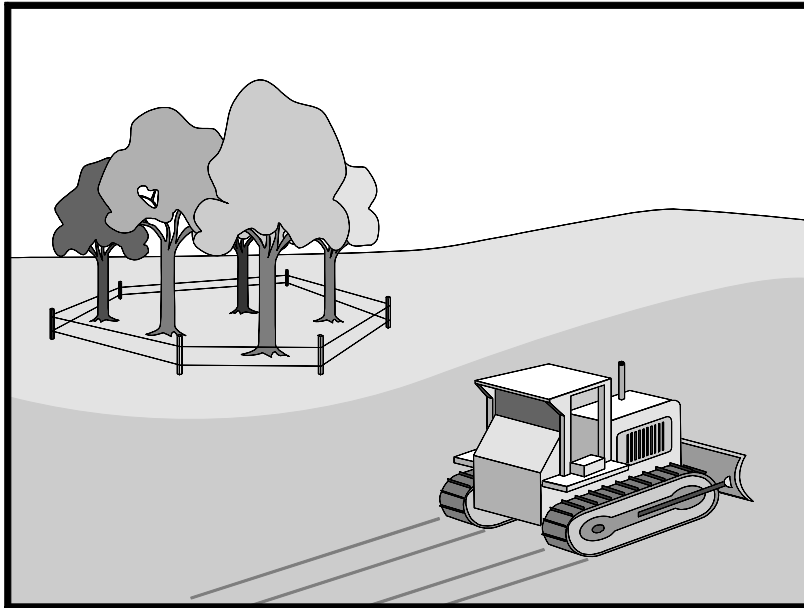

Description and Purpose

Carefully planned preservation of existing vegetation minimizes the potential of removing or injuring existing trees, vines, shrubs, and grasses that protect soil from erosion.

Suitable Applications

Preservation of existing vegetation is suitable for use on most projects. Large project sites often provide the greatest opportunity for use of this BMP. Suitable applications include the following:

- Areas within the site where no construction activity occurs, or occurs at a later date. This BMP is especially suitable to multi year projects where grading can be phased.
- Areas where natural vegetation exists and is designated for preservation. Such areas often include steep slopes, watercourse, and building sites in wooded areas.
- Areas where local, state, and federal government require preservation, such as vernal pools, wetlands, marshes, certain oak trees, etc. These areas are usually designated on the plans, or in the specifications, permits, or environmental documents.
- Where vegetation designated for ultimate removal can be temporarily preserved and be utilized for erosion control and sediment control.

Limitations

- Requires forward planning by the owner/developer,

Categories

EC	Erosion Control	<input checked="" type="checkbox"/>
SE	Sediment Control	<input type="checkbox"/>
TC	Tracking Control	<input type="checkbox"/>
WE	Wind Erosion Control	<input type="checkbox"/>
NS	Non-Stormwater Management Control	<input type="checkbox"/>
WM	Waste Management and Materials Pollution Control	<input type="checkbox"/>

Legend:

- Primary Objective
- Secondary Objective

Targeted Constituents

Sediment	<input checked="" type="checkbox"/>
Nutrients	<input type="checkbox"/>
Trash	<input type="checkbox"/>
Metals	<input type="checkbox"/>
Bacteria	<input type="checkbox"/>
Oil and Grease	<input type="checkbox"/>
Organics	<input type="checkbox"/>

Potential Alternatives

None



Preservation Of Existing Vegetation EC-2

contractor, and design staff.

- Limited opportunities for use when project plans do not incorporate existing vegetation into the site design.
- For sites with diverse topography, it is often difficult and expensive to save existing trees while grading the site satisfactory for the planned development.

Implementation

The best way to prevent erosion is to not disturb the land. In order to reduce the impacts of new development and redevelopment, projects may be designed to avoid disturbing land in sensitive areas of the site (e.g., natural watercourses, steep slopes), and to incorporate unique or desirable existing vegetation into the site's landscaping plan. Clearly marking and leaving a buffer area around these unique areas during construction will help to preserve these areas as well as take advantage of natural erosion prevention and sediment trapping.

Existing vegetation to be preserved on the site must be protected from mechanical and other injury while the land is being developed. The purpose of protecting existing vegetation is to ensure the survival of desirable vegetation for shade, beautification, and erosion control. Mature vegetation has extensive root systems that help to hold soil in place, thus reducing erosion. In addition, vegetation helps keep soil from drying rapidly and becoming susceptible to erosion. To effectively save existing vegetation, no disturbances of any kind should be allowed within a defined area around the vegetation. For trees, no construction activity should occur within the drip line of the tree.

Timing

- Provide for preservation of existing vegetation prior to the commencement of clearing and grubbing operations or other soil disturbing activities in areas where no construction activity is planned or will occur at a later date.

Design and Layout

- Mark areas to be preserved with temporary fencing. Include sufficient setback to protect roots.
 - Orange colored plastic mesh fencing works well.
 - Use appropriate fence posts and adequate post spacing and depth to completely support the fence in an upright position.
- Locate temporary roadways, stockpiles, and layout areas to avoid stands of trees, shrubs, and grass.
- Consider the impact of grade changes to existing vegetation and the root zone.
- Maintain existing irrigation systems where feasible. Temporary irrigation may be required.
- Instruct employees and subcontractors to honor protective devices. Prohibit heavy equipment, vehicular traffic, or storage of construction materials within the protected area.

Preservation Of Existing Vegetation EC-2

Costs

There is little cost associated with preserving existing vegetation if properly planned during the project design, and these costs may be offset by aesthetic benefits that enhance property values. During construction, the cost for preserving existing vegetation will likely be less than the cost of applying erosion and sediment controls to the disturbed area. Replacing vegetation inadvertently destroyed during construction can be extremely expensive, sometimes in excess of \$10,000 per tree.

Inspection and Maintenance

During construction, the limits of disturbance should remain clearly marked at all times. Irrigation or maintenance of existing vegetation should be described in the landscaping plan. If damage to protected trees still occurs, maintenance guidelines described below should be followed:

- Verify that protective measures remain in place. Restore damaged protection measures immediately.
- Serious tree injuries shall be attended to by an arborist.
- Damage to the crown, trunk, or root system of a retained tree shall be repaired immediately.
- Trench as far from tree trunks as possible, usually outside of the tree drip line or canopy. Curve trenches around trees to avoid large roots or root concentrations. If roots are encountered, consider tunneling under them. When trenching or tunneling near or under trees to be retained, place tunnels at least 18 in. below the ground surface, and not below the tree center to minimize impact on the roots.
- Do not leave tree roots exposed to air. Cover exposed roots with soil as soon as possible. If soil covering is not practical, protect exposed roots with wet burlap or peat moss until the tunnel or trench is ready for backfill.
- Cleanly remove the ends of damaged roots with a smooth cut.
- Fill trenches and tunnels as soon as possible. Careful filling and tamping will eliminate air spaces in the soil, which can damage roots.
- If bark damage occurs, cut back all loosened bark into the undamaged area, with the cut tapered at the top and bottom and drainage provided at the base of the wood. Limit cutting the undamaged area as much as possible.
- Aerate soil that has been compacted over a trees root zone by punching holes 12 in. deep with an iron bar, and moving the bar back and forth until the soil is loosened. Place holes 18 in. apart throughout the area of compacted soil under the tree crown.
- Fertilization
 - Fertilize stressed or damaged broadleaf trees to aid recovery.
 - Fertilize trees in the late fall or early spring.

Preservation Of Existing Vegetation EC-2

- Apply fertilizer to the soil over the feeder roots and in accordance with label instructions, but never closer than 3 ft to the trunk. Increase the fertilized area by one-fourth of the crown area for conifers that have extended root systems.
- Retain protective measures until all other construction activity is complete to avoid damage during site cleanup and stabilization.

References

County of Sacramento Tree Preservation Ordinance, September 1981.

Stormwater Quality Handbooks Construction Site Best Management Practices (BMPs) Manual, State of California Department of Transportation (Caltrans), November 2000.

Stormwater Management of the Puget Sound Basin, Technical Manual, Publication #91-75, Washington State Department of Ecology, February 1992.

Water Quality Management Plan for The Lake Tahoe Region, Volume II, Handbook of Management Practices, Tahoe Regional Planning Agency, November 1988.

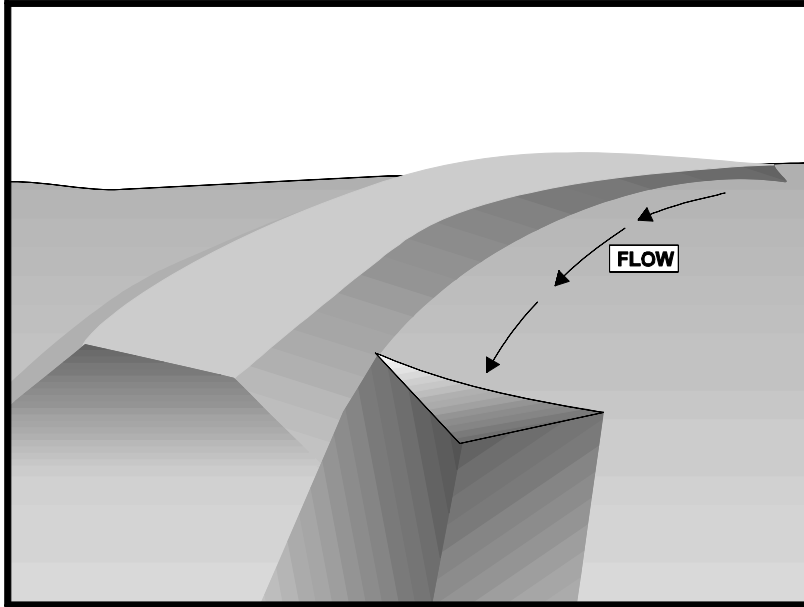

Description and Purpose

An earth dike is a temporary berm or ridge of compacted soil used to divert runoff or channel water to a desired location. A drainage swale is a shaped and sloped depression in the soil surface used to convey runoff to a desired location. Earth dikes and drainage swales are used to divert off site runoff around the construction site, divert runoff from stabilized areas and disturbed areas, and direct runoff into sediment basins or traps.

Suitable Applications

Earth dikes and drainage swales are suitable for use, individually or together, where runoff needs to be diverted from one area and conveyed to another.

- Earth dikes and drainage swales may be used:
 - To convey surface runoff down sloping land
 - To intercept and divert runoff to avoid sheet flow over sloped surfaces
 - To divert and direct runoff towards a stabilized watercourse, drainage pipe or channel
 - To intercept runoff from paved surfaces
 - Below steep grades where runoff begins to concentrate
 - Along roadways and facility improvements subject to flood drainage

Categories

EC	Erosion Control	<input checked="" type="checkbox"/>
SE	Sediment Control	<input type="checkbox"/>
TC	Tracking Control	<input type="checkbox"/>
WE	Wind Erosion Control	<input type="checkbox"/>
NS	Non-Stormwater Management Control	<input type="checkbox"/>
WM	Waste Management and Materials Pollution Control	<input type="checkbox"/>

Legend:

- Primary Objective
- Secondary Objective

Targeted Constituents

Sediment	<input checked="" type="checkbox"/>
Nutrients	<input type="checkbox"/>
Trash	<input type="checkbox"/>
Metals	<input type="checkbox"/>
Bacteria	<input type="checkbox"/>
Oil and Grease	<input type="checkbox"/>
Organics	<input type="checkbox"/>

Potential Alternatives

None



- At the top of slopes to divert runoff from adjacent or undisturbed slopes
- At bottom and mid slope locations to intercept sheet flow and convey concentrated flows
- Divert sediment laden runoff into sediment basins or traps

Limitations

Dikes should not be used for drainage areas greater than 10 acres or along slopes greater than 10 percent. For larger areas more permanent drainage structures should be built. All drainage structures should be built in compliance with local municipal requirements.

- Earth dikes may create more disturbed area on site and become barriers to construction equipment.
- Earth dikes must be stabilized immediately, which adds cost and maintenance concerns.
- Diverted stormwater may cause downstream flood damage.
- Dikes should not be constructed of soils that may be easily eroded.
- Regrading the site to remove the dike may add additional cost.
- Temporary drains and swales or any other diversion of runoff should not adversely impact upstream or downstream properties.
- Temporary drains and swales must conform to local floodplain management requirements.
- Earth dikes/drainage swales are not suitable as sediment trapping devices.
- It may be necessary to use other soil stabilization and sediment controls such as check dams, plastics, and blankets, to prevent scour and erosion in newly graded dikes, swales, and ditches.
- Sediment accumulation, scour depressions, and/or persistent non-stormwater discharges can result in areas of standing water suitable for mosquito production in drainage swales.

Implementation

The temporary earth dike is a berm or ridge of compacted soil, located in such a manner as to divert stormwater to a sediment trapping device or a stabilized outlet, thereby reducing the potential for erosion and offsite sedimentation. Earth dikes can also be used to divert runoff from off site and from undisturbed areas away from disturbed areas and to divert sheet flows away from unprotected slopes.

An earth dike does not itself control erosion or remove sediment from runoff. A dike prevents erosion by directing runoff to an erosion control device such as a sediment trap or directing runoff away from an erodible area. Temporary diversion dikes should not adversely impact adjacent properties and must conform to local floodplain management regulations, and should not be used in areas with slopes steeper than 10%.

Slopes that are formed during cut and fill operations should be protected from erosion by runoff. A combination of a temporary drainage swale and an earth dike at the top of a slope can divert

runoff to a location where it can be brought to the bottom of the slope (see EC-11, Slope Drains). A combination dike and swale is easily constructed by a single pass of a bulldozer or grader and compacted by a second pass of the tracks or wheels over the ridge. Diversion structures should be installed when the site is initially graded and remain in place until post construction BMPs are installed and the slopes are stabilized.

Diversion practices concentrate surface runoff, increasing its velocity and erosive force. Thus, the flow out of the drain or swale must be directed onto a stabilized area or into a grade stabilization structure. If significant erosion will occur, a swale should be stabilized using vegetation, chemical treatment, rock rip-rap, matting, or other physical means of stabilization. Any drain or swale that conveys sediment laden runoff must be diverted into a sediment basin or trap before it is discharged from the site.

General

- Care must be applied to correctly size and locate earth dikes, drainage swales. Excessively steep, unlined dikes, and swales are subject to erosion and gully formation.
- Conveyances should be stabilized.
- Use a lined ditch for high flow velocities.
- Select flow velocity based on careful evaluation of the risks due to erosion of the measure, soil types, overtopping, flow backups, washout, and drainage flow patterns for each project site.
- Compact any fills to prevent unequal settlement.
- Do not divert runoff onto other property without securing written authorization from the property owner.
- When possible, install and utilize permanent dikes, swales, and ditches early in the construction process.
- Provide stabilized outlets.

Earth Dikes

Temporary earth dikes are a practical, inexpensive BMP used to divert stormwater runoff. Temporary diversion dikes should be installed in the following manner:

- All dikes should be compacted by earth moving equipment.
- All dikes should have positive drainage to an outlet.
- All dikes should have 2:1 or flatter side slopes, 18 in. minimum height, and a minimum top width of 24 in. Wide top widths and flat slopes are usually needed at crossings for construction traffic.
- The outlet from the earth dike must function with a minimum of erosion. Runoff should be conveyed to a sediment trapping device such as a Sediment Trap (SE-3) or Sediment Basin

(SE-2) when either the dike channel or the drainage area above the dike are not adequately stabilized.

- Temporary stabilization may be achieved using seed and mulching for slopes less than 5% and either rip-rap or sod for slopes in excess of 5%. In either case, stabilization of the earth dike should be completed immediately after construction or prior to the first rain.
- If riprap is used to stabilize the channel formed along the toe of the dike, the following typical specifications apply:

Channel Grade	Riprap Stabilization
0.5-1.0%	4 in. Rock
1.1-2.0%	6 in. Rock
2.1-4.0%	8 in. Rock
4.1-5.0%	8 in. -12 in. Riprap

- The stone riprap, recycled concrete, etc. used for stabilization should be pressed into the soil with construction equipment.
- Filter cloth may be used to cover dikes in use for long periods.
- Construction activity on the earth dike should be kept to a minimum.

Drainage Swales

Drainage swales are only effective if they are properly installed. Swales are more effective than dikes because they tend to be more stable. The combination of a swale with a dike on the downhill side is the most cost effective diversion.

Standard engineering design criteria for small open channel and closed conveyance systems should be used (see the local drainage design manual). Unless local drainage design criteria state otherwise, drainage swales should be designed as follows:

- No more than 5 acres may drain to a temporary drainage swale.
- Place drainage swales above or below, not on, a cut or fill slope.
- Swale bottom width should be at least 2 ft
- Depth of the swale should be at least 18 in.
- Side slopes should be 2:1 or flatter.
- Drainage or swales should be laid at a grade of at least 1 percent, but not more than 15 percent.
- The swale must not be overtopped by the peak discharge from a 10-year storm, irrespective of the design criteria stated above.

- Remove all trees, stumps, obstructions, and other objectionable material from the swale when it is built.
- Compact any fill material along the path of the swale.
- Stabilize all swales immediately. Seed and mulch swales at a slope of less than 5 percent, and use rip-rap or sod for swales with a slope between 5 and 15 percent. For temporary swales, geotextiles and mats (EC-7) may provide immediate stabilization.
- Irrigation may be required to establish sufficient vegetation to prevent erosion.
- Do not operate construction vehicles across a swale unless a stabilized crossing is provided.
- Permanent drainage facilities must be designed by a professional engineer (see the local drainage design criteria for proper design).
- At a minimum, the drainage swale should conform to predevelopment drainage patterns and capacities.
- Construct the drainage swale with a positive grade to a stabilized outlet.
- Provide erosion protection or energy dissipation measures if the flow out of the drainage swale can reach an erosive velocity.

Costs

- Cost ranges from \$15 to \$55 per ft for both earthwork and stabilization and depends on availability of material, site location, and access.
- Small dikes: \$2.50 - \$6.50/linear ft; Large dikes: \$2.50/yd³.
- The cost of a drainage swale increases with drainage area and slope. Typical swales for controlling internal erosion are inexpensive, as they are quickly formed during routine earthwork.

Inspection and Maintenance

- Inspect BMPs prior to forecast rain, daily during extended rain events, after rain events, weekly during the rainy season, and at two-week intervals during the non-rainy season.
- Inspect BMPs subject to non-stormwater discharges daily while non-stormwater discharges occur.
- Inspect ditches and berms for washouts. Replace lost riprap, damaged linings or soil stabilizers as needed.
- Inspect channel linings, embankments, and beds of ditches and berms for erosion and accumulation of debris and sediment. Remove debris and sediment and repair linings and embankments as needed.
- Temporary conveyances should be completely removed as soon as the surrounding drainage area has been stabilized or at the completion of construction

References

Erosion and Sediment Control Handbook, S.J. Goldman, K. Jackson, T.A. Bursetynsky, P.E., McGraw Hill Book Company, 1986.

Manual of Standards of Erosion and Sediment Control Measures, Association of Bay Area Governments, May 1995.

Metzger, M.E. 2004. Managing mosquitoes in stormwater treatment devices. University of California Division of Agriculture and Natural Resources, Publication 8125. On-line: <http://anrcatalog.ucdavis.edu/pdf/8125.pdf>

National Association of Home Builders (NAHB). Stormwater Runoff & Nonpoint Source Pollution Control Guide for Builders and Developers. National Association of Home Builders, Washington, D.C., 1995

National Management Measures to Control Nonpoint Source Pollution from Urban Areas, United States Environmental Protection Agency, 2002.

Southeastern Wisconsin Regional Planning Commission (SWRPC). Costs of Urban Nonpoint Source Water Pollution Control Measures. Technical Report No. 31. Southeastern Wisconsin Regional Planning Commission, Waukesha, WI. 1991

Stormwater Quality Handbooks Construction Site Best Management Practices (BMPs) Manual, State of California Department of Transportation (Caltrans), November 2000.

Stormwater Management of the Puget Sound Basin, Technical Manual, Publication #91-75, Washington State Department of Ecology, February 1992.

Water Quality Management Plan for the Lake Tahoe Region, Volume II, Handbook of Management Practices, Tahoe Regional Planning Agency, November 1988.

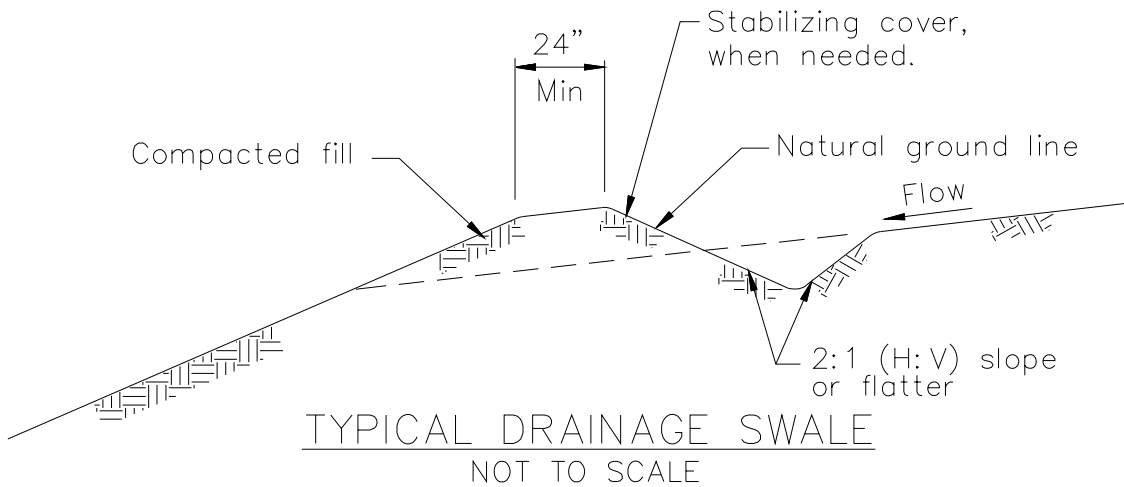

NOTES:

1. Stabilize inlet, outlets and slopes.
2. Properly compact the subgrade.

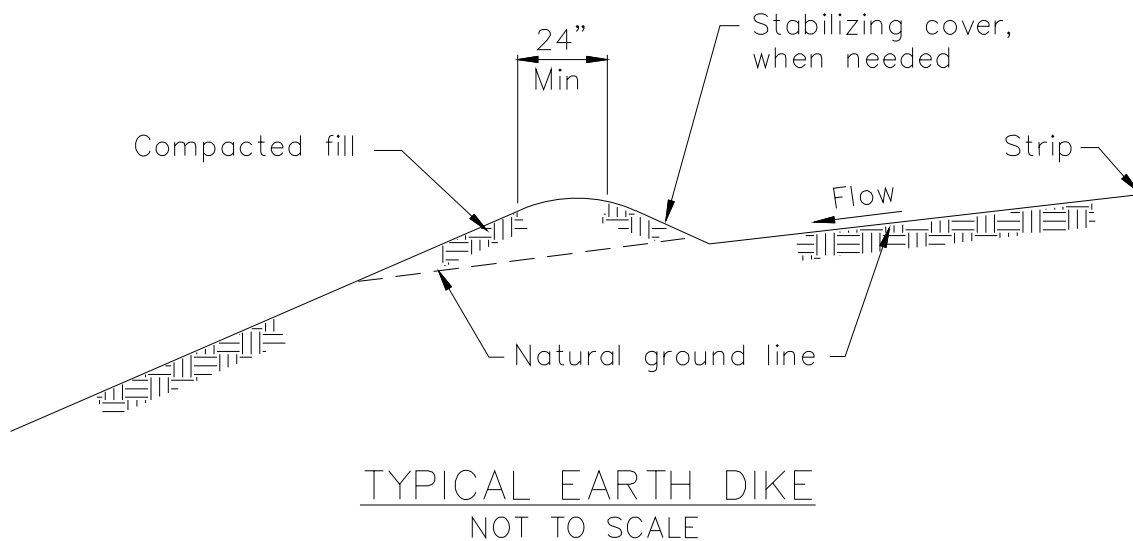

This page intentionally left blank

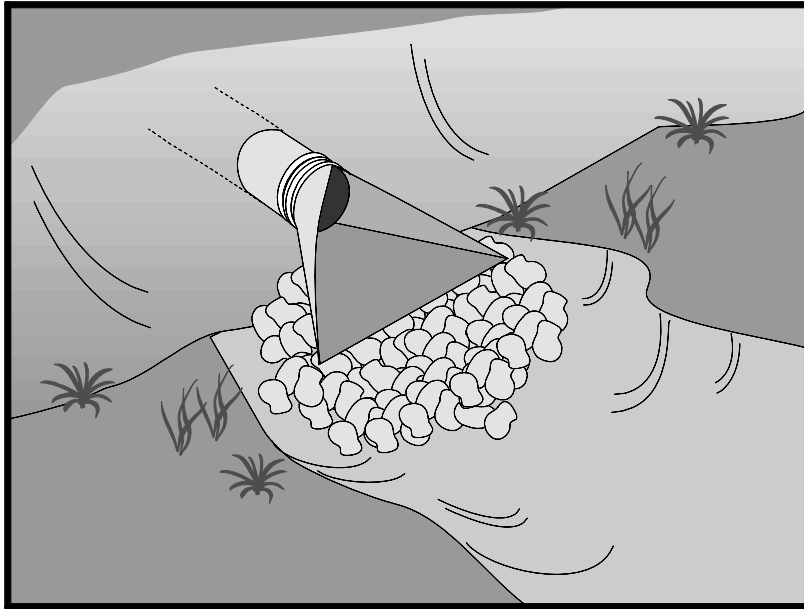

Description and Purpose

Outlet protection is a physical device composed of rock, grouted riprap, or concrete rubble, which is placed at the outlet of a pipe or channel to prevent scour of the soil caused by concentrated, high velocity flows.

Suitable Applications

Whenever discharge velocities and energies at the outlets of culverts, conduits, or channels are sufficient to erode the next downstream reach. This includes temporary diversion structures to divert runoff during construction.

- These devices may be used at the following locations:
 - Outlets of pipes, drains, culverts, slope drains, diversion ditches, swales, conduits, or channels.
 - Outlets located at the bottom of mild to steep slopes.
 - Discharge outlets that carry continuous flows of water.
 - Outlets subject to short, intense flows of water, such as flash floods.
 - Points where lined conveyances discharge to unlined conveyances

Limitations

- Large storms or high flows can wash away the rock outlet protection and leave the area susceptible to erosion.

Categories

EC	Erosion Control	<input checked="" type="checkbox"/>
SE	Sediment Control	
TC	Tracking Control	
WE	Wind Erosion Control	
NS	Non-Stormwater Management Control	
WM	Waste Management and Materials Pollution Control	

Legend:

- Primary Objective
- Secondary Objective

Targeted Constituents

Sediment	<input checked="" type="checkbox"/>
Nutrients	
Trash	
Metals	
Bacteria	
Oil and Grease	
Organics	

Potential Alternatives

None



- Sediment captured by the rock outlet protection may be difficult to remove without removing the rock.
- Outlet protection may negatively impact the channel habitat.
- Grouted riprap may break up in areas of freeze and thaw.
- If there is not adequate drainage, and water builds up behind grouted riprap, it may cause the grouted riprap to break up due to the resulting hydrostatic pressure.
- Sediment accumulation, scour depressions, and/or persistent non-stormwater discharges can result in areas of standing water suitable for mosquito production in velocity dissipation devices.

Implementation

General

Outlet protection is needed where discharge velocities and energies at the outlets of culverts, conduits or channels are sufficient to erode the immediate downstream reach. This practice protects the outlet from developing small eroded pools (plunge pools), and protects against gully erosion resulting from scouring at a culvert mouth.

Design and Layout

As with most channel design projects, depth of flow, roughness, gradient, side slopes, discharge rate, and velocity should be considered in the outlet design. Compliance to local and state regulations should also be considered while working in environmentally sensitive streambeds. General recommendations for rock size and length of outlet protection mat are shown in the rock outlet protection figure in this BMP and should be considered minimums. The apron length and rock size gradation are determined using a combination of the discharge pipe diameter and estimate discharge rate: Select the longest apron length and largest rock size suggested by the pipe size and discharge rate. Where flows are conveyed in open channels such as ditches and swales, use the estimated discharge rate for selecting the apron length and rock size. Flows should be same as the culvert or channel design flow but never the less than the peak 5 year flow for temporary structures planned for one rainy season, or the 10 year peak flow for temporary structures planned for two or three rainy seasons.

- There are many types of energy dissipaters, with rock being the one that is represented in the attached figure.
- Best results are obtained when sound, durable, and angular rock is used.
- Install riprap, grouted riprap, or concrete apron at selected outlet. Riprap aprons are best suited for temporary use during construction. Grouted or wired tied rock riprap can minimize maintenance requirements.
- Rock outlet protection is usually less expensive and easier to install than concrete aprons or energy dissipaters. It also serves to trap sediment and reduce flow velocities.
- Carefully place riprap to avoid damaging the filter fabric.

- Stone 4 in. to 6 in. may be carefully dumped onto filter fabric from a height not to exceed 12 in.
 - Stone 8 in. to 12 in. must be hand placed onto filter fabric, or the filter fabric may be covered with 4 in. of gravel and the 8 in. to 12 in. rock may be dumped from a height not to exceed 16 in.
 - Stone greater than 12 in. shall only be dumped onto filter fabric protected with a layer of gravel with a thickness equal to one half the D_{50} rock size, and the dump height limited to twice the depth of the gravel protection layer thickness.
- For proper operation of apron: Align apron with receiving stream and keep straight throughout its length. If a curve is needed to fit site conditions, place it in upper section of apron.
 - Outlets on slopes steeper than 10 percent should have additional protection.

Costs

Costs are low if material is readily available. If material is imported, costs will be higher. Average installed cost is \$150 per device.

Inspection and Maintenance

- Inspect BMPs prior to forecast rain, daily during extended rain events, after rain events, weekly during the rainy season, and at two-week intervals during the non-rainy season.
- Inspect BMPs subjected to non-stormwater discharges daily while non-stormwater discharges occur. Minimize areas of standing water by removing sediment blockages and filling scour depressions.
- Inspect apron for displacement of the riprap and damage to the underlying fabric. Repair fabric and replace riprap that has washed away. If riprap continues to wash away, consider using larger material.
- Inspect for scour beneath the riprap and around the outlet. Repair damage to slopes or underlying filter fabric immediately.
- Temporary devices should be completely removed as soon as the surrounding drainage area has been stabilized or at the completion of construction.

References

County of Sacramento Improvement Standards, Sacramento County, May 1989.

Erosion and Sediment Control Handbook, S.J. Goldman, K. Jackson, T.A. Bursztynsky, P.E., McGraw Hill Book Company, 1986.

Handbook of Steel Drainage & Highway Construction, American Iron and Steel Institute, 1983.

Manual of Standards of Erosion and Sediment Control Measures, Association of Bay Area Governments, May 1995.

Metzger, M.E. 2004. Managing mosquitoes in stormwater treatment devices. University of California Division of Agriculture and Natural Resources, Publication 8125. On-line: <http://anrcatalog.ucdavis.edu/pdf/8125.pdf>

Stormwater Quality Handbooks Construction Site Best Management Practices (BMPs) Manual, state of California Department of Transportation (Caltrans), November 2000.

Stormwater Management of the Puget Sound Basin, Technical Manual, Publication #91-75, Washington State Department of Ecology, February 1992.

Water Quality Management Plan for the Lake Tahoe Region, Volume II, Handbook of Management Practices, Tahoe Regional Planning Agency, November 1988.

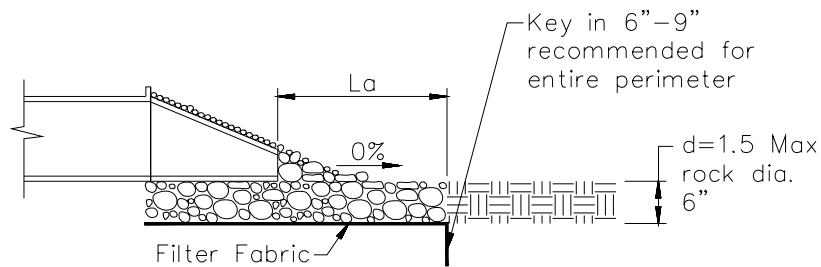
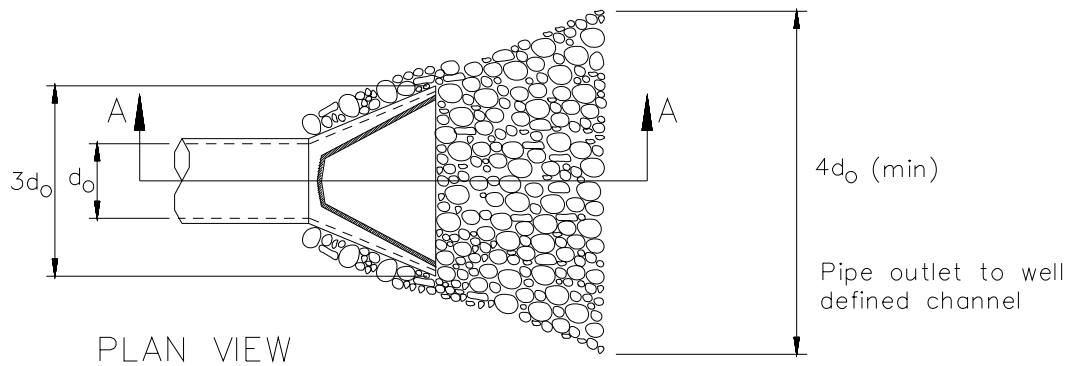

Pipe Diameter inches	Discharge ft ³ /s	Apron Length, La ft	Rip Rap D ₅₀ Diameter Min inches
12	5	10	4
	10	13	6
18	10	10	6
	20	16	8
	30	23	12
24	40	26	16
	30	16	8
	40	26	8
	50	26	12
	60	30	16

For larger or higher flows consult a Registered Civil Engineer
Source: USDA - SCS

This page intentionally left blank



Description and Purpose

Stream channels, streambanks, and associated riparian areas are dynamic and sensitive ecosystems that respond to changes in land use activity. Streambank and channel disturbance resulting from construction activities can increase the stream's sediment load, which can cause channel erosion or sedimentation and have adverse affects on the biotic system. BMPs can reduce the discharge of sediment and other pollutants to minimize the impact of construction activities on watercourses. Streams on the 303(d) list and listed for sediment may require numerous measures to prevent any increases in sediment load to the stream.

Suitable Applications

These procedures typically apply to all construction projects that disturb or occur within stream channels and their associated riparian areas.

Limitations

Specific permit requirements or mitigation measures such as Regional Water Quality Control Board (RWQCB) 401 Certification, U.S. Army Corps of Engineers 404 permit and approval by California Department of Fish and Game supercede the guidance in this BMP.

- If numerical based water quality standards are mentioned in any of these and other related permits, testing and sampling may be required. Streams listed as 303(d) impaired for sediment, silt, or turbidity, are required to

Categories

EC	Erosion Control	<input checked="" type="checkbox"/>
SE	Sediment Control	<input checked="" type="checkbox"/>
TC	Tracking Control	
WE	Wind Erosion Control	
NS	Non-Stormwater Management Control	<input checked="" type="checkbox"/>
WM	Waste Management and Materials Pollution Control	

Legend:

- Primary Objective
- Secondary Objective

Targeted Constituents

Sediment	<input checked="" type="checkbox"/>
Nutrients	
Trash	
Metals	
Bacteria	
Oil and Grease	
Organics	

Potential Alternatives

Combination of erosion and sediment controls.



conduct sampling to verify that there is no net increase in sediment load due to construction activities.

Implementation

Planning

- Proper planning, design, and construction techniques can minimize impacts normally associated with in stream construction activities. Poor planning can adversely affect soil, fish, wildlife resources, land uses, or land users. Planning should take into account: scheduling; avoidance of in-stream construction; minimizing disturbance area and construction time period; using pre-disturbed areas; selecting crossing location; and selecting equipment.

Scheduling

- Construction activities should be scheduled according to the relative sensitivity of the environmental concerns and in accordance with EC-1, Scheduling. Scheduling considerations will be different when working near perennial streams vs. ephemeral streams and are as follows.
- When in-stream construction is conducted in a perennial stream, work should optimally be performed during the rainy season. This is because in the summer, any sediment-containing water that is discharged into the watercourse will cause a large change in both water clarity and water chemistry. During the rainy season, there is typically more and faster flowing water in the stream so discharges are diluted faster. However, should in-stream work be scheduled for summer, establishing an isolation area, or diverting the stream, will significantly decrease the amount of sediment stirred up by construction work. Construction work near perennial streams should optimally be performed during the dry season (see below).
- When working in or near ephemeral streams, work should be performed during the dry season. By their very nature, ephemeral streams are usually dry in the summer, and therefore, in-stream construction activities will not cause significant water quality problems. However, when tying up the site at the end of the project, wash any fines (see Washing Fines) that accumulated in the channel back into the bed material, to decrease pollution from the first rainstorm of the season.
- When working near ephemeral or perennial streams, erosion and sediment controls (see silt fences, straw bale barriers, etc.) should be implemented to keep sediment out of stream channel.

Minimize Disturbance

- Minimize disturbance through: selection of the narrowest crossing location; limiting the number of equipment trips across a stream during construction; and, minimizing the number and size of work areas (equipment staging areas and spoil storage areas). Place work areas at least 50 ft from stream channel. Field reconnaissance should be conducted during the planning stage to identify work areas.

Use of Pre-Disturbed Areas

- Locate project sites and work areas in areas disturbed by prior construction or other activity when possible.

Selection of Project Site

- Avoid steep and unstable banks, highly erodible or saturated soils, or highly fractured rock.
- Select project site that minimizes disturbance to aquatic species or habitat.

Equipment Selection

- Select equipment that reduces the amount of pressure exerted on the ground surface, and therefore, reduces erosion potential and/or use overhead or aerial access for transporting equipment across drainage channels. Use equipment that exerts ground pressures of less than 5 or 6 lb/in², where possible. Low ground pressure equipment includes: wide or high flotation tires (34 to 72 in. wide); dual tires; bogie axle systems; tracked machines; lightweight equipment; and, central tire inflation systems.

Streambank Stabilization

Preservation of Existing Vegetation

- Preserve existing vegetation in accordance with EC-2, Preservation of Existing Vegetation. In a streambank environment, preservation of existing vegetation provides the following benefits.

Water Quality Protection

- Vegetated buffers on slopes trap sediment and promote groundwater recharge. The buffer width needed to maintain water quality ranges from 15 to 100 ft. On gradual slopes, most of the filtering occurs within the first 30 ft. Steeper slopes require a greater width of vegetative buffer to provide water quality benefits.

Streambank Stabilization

- The root system of riparian vegetation stabilizes streambanks by increasing tensile strength in the soil. The presence of vegetation modifies the moisture condition of slopes (infiltration, evapo transpiration, interception) and increases bank stability.

Riparian Habitat

- Buffers of diverse riparian vegetation provide food and shelter for riparian and aquatic organisms. Minimizing impacts to fisheries habitat is a major concern when working near streams and rivers. Riparian vegetation provides shade, shelter, organic matter (leaf detritus and large woody debris), and other nutrients that are necessary for fish and other aquatic organisms. Buffer widths for habitat concerns are typically wider than those recommended for water quality concerns (100 to 1500 ft).
- When working near watercourses, it is important to understand the work site's placement in the watershed. Riparian vegetation in headwater streams has a greater impact on overall water quality than vegetation in downstream reaches. Preserving existing vegetation upstream is necessary to maintain water quality, minimize bank failure, and maximize riparian habitat, downstream of the work site.

Limitations

- Local county and municipal ordinances regarding width, extent and type of vegetative buffer required may exceed the specifications provided here; these ordinances should be investigated prior to construction.

Streambank Stabilization Specific Installation

- As a general rule, the width of a buffer strip between a road and the stream is recommended to be 50 ft plus four times the percent slope of the land, measured between the road and the top of stream bank.

Hydraulic Mulch

- Apply hydraulic mulch on disturbed streambanks above mean high water level in accordance with EC-3, Hydraulic Mulch to provide temporary soil stabilization.

Limitations

- Do not place hydraulic mulch or tackifiers below the mean high water level, as these materials could wash into the channel and impact water quality or possibly cause eutrophication (eutrophication is an algal bloom caused by excessively high nutrient levels in the water).

Hydroseeding

- Hydroseed disturbed streambanks in accordance with EC-4, Hydroseeding.

Limitations

- Do not place tackifiers or fertilizers below the mean high water level, as these materials could wash into the channel and impact water quality or possibly cause eutrophication.

Soil Binders

- Apply soil binders to disturbed streambanks in accordance with EC-5, Soil Binders.

Limitations

- Do not place soil binders below the mean high water level. Soil binder must be environmentally benign and non-toxic to aquatic organisms.

Straw Mulch

- Apply straw mulch to disturbed streambanks in accordance with EC-6, Straw Mulch.

Limitations

- Do not place straw mulch below the mean high water level, as this material could wash into the channel and impact water quality or possibly cause eutrophication.

Geotextiles and Mats

- Install geotextiles and mats as described in EC-7, Geotextiles and Mats, to stabilize disturbed channels and streambanks. Not all applications should be in the channel, for example, certain geotextile netting may snag fish gills and are not appropriate in fish bearing streams. Geotextile fabrics that are not biodegradable are not appropriate for in stream use. Additionally, geotextile fabric or blankets placed in channels must be adequate to sustain anticipated hydraulic forces.

Earth Dikes, Drainage Swales, and Lined Ditches

- Convey, intercept, or divert runoff from disturbed streambanks using EC-9, Earth Dikes and Drainage Swales.

Limitations

- Do not place earth dikes in watercourses, as these structures are only suited for intercepting sheet flow, and should not be used to intercept concentrated flow.
- Appropriately sized velocity dissipation devices (EC-10) must be placed at outlets to minimize erosion and scour.

Velocity Dissipation Devices

- Place velocity dissipation devices at outlets of pipes, drains, culverts, slope drains, diversion ditches, swales, conduits or channels in accordance with EC-10, Velocity Dissipation Devices.

Slope Drains

- Use slope drains to intercept and direct surface runoff or groundwater into a stabilized watercourse, trapping device or stabilized area in accordance with EC-11, Slope Drains.

Limitations

- Appropriately sized outlet protection and velocity dissipation devices (EC-10) must be placed at outlets to minimize erosion and scour.

Streambank Sediment Control

Silt Fences

- Install silt fences in accordance with SE-1, Silt Fence, to control sediment. Silt fences should only be installed where sediment laden water can pond, thus allowing the sediment to settle out.

Fiber Rolls

- Install fiber rolls in accordance with SE-5, Fiber Rolls, along contour of slopes above the high water level to intercept runoff, reduce flow velocity, release the runoff as sheet flow and provide removal of sediment from the runoff. In a stream environment, fiber rolls should be used in conjunction with other sediment control methods such as SE-1, Silt Fence or SE-9 Straw Bale Barrier. Install silt fence, straw bale barrier, or other erosion control method along toe of slope above the high water level.

Gravel Bag Berm

- A gravel bag berm or barrier can be utilized to intercept and slow the flow of sediment laden sheet flow runoff in accordance with SE-6, Gravel Bag Berm. In a stream environment gravel bag barriers can allow sediment to settle from runoff before water leaves the construction site and can be used to isolate the work area from the live stream.

Limitations

- Gravel bag barriers are not recommended as a perimeter sediment control practice around streams.

Straw Bale Barrier

- Install straw bale barriers in accordance with SE-9, Straw Bale Barrier, to control sediment. Straw bale barriers should only be installed where sediment laden water can pond, thus allowing the sediment to settle out. Install a silt fence in accordance with SE-1, Silt Fence,

on down slope side of straw bale barrier closest to stream channel to provide added sediment control.

Rock Filter

Description and Purpose

Rock filters are temporary erosion control barriers composed of rock that is anchored in place. Rock filters detain the sediment laden runoff, retain the sediment, and release the water as sheet flow at a reduced velocity. Typical rock filter installations are illustrated at the end of this BMP.

Applications

- Near the toe of slopes that may be subject to flow and rill erosion.

Limitations

- Inappropriate for contributing drainage areas greater than 5 acres.
- Requires sufficient space for ponded water.
- Ineffective for diverting runoff because filters allow water to slowly seep through.
- Rock filter berms are difficult to remove when construction is complete.
- Unsuitable in developed areas or locations where aesthetics is a concern.

Specifications

- Rock: open graded rock, 0.75 to 5 in. for concentrated flow applications.
- Woven wire sheathing: 1 in. diameter, hexagonal mesh, galvanized 20gauge (used with rock filters in areas of concentrated flow).
- In construction traffic areas, maximum rock berm heights should be 12 in. Berms should be constructed every 300 ft on slopes less than 5%, every 200 ft on slopes between 5% and 10%, and every 100 ft on slopes greater than 10%.

Maintenance

- Inspect and verify that activity-based BMPs are in place prior to the commencement of associated activities. While activities associated with the BMP are under way, inspect weekly during the rainy season and at two-week intervals in the non-rainy season to verify continued BMP implementation.
- Inspect BMPs subject to non-stormwater discharges daily while non-stormwater discharges occur.
- Reshape berms as needed and replace lost or dislodged rock, and filter fabric.
- Sediment that accumulates in the BMP must be periodically removed in order to maintain BMP effectiveness. Sediment should be removed when the sediment accumulation reaches one third of the barrier height. Sediment removed during maintenance may be incorporated into earthwork on the site or disposed at an appropriate location.

K-rail

Description and Purpose

This is temporary sediment control that uses K-rails to form the sediment deposition area, or to isolate the near bank construction area. Install K-rails at toe of slope in accordance with procedures described in NS-5, Clear Water Diversion.

Barriers are placed end to end in a pre-designed configuration and gravel filled bags are used at the toe of the barrier and at their abutting ends to seal and prevent movement of sediment beneath or through the barrier walls.

Appropriate Applications

- This technique is useful at the toe of embankments, cuts or fills slopes.

Limitations

- The K-rail method should not be used to dewater a project site, as the barrier is not watertight.

Implementation

- Refer to NS-5, Clear Water Diversion, for implementation requirements.

Instream Construction Sediment Control

There are three different options currently available for reducing turbidity while working in a stream or river. The stream can be isolated from the area in which work is occurring by means of a water barrier, the stream can be diverted around the work site through a pipe or temporary channel, or one can employ construction practices that minimize sediment suspension.

Whatever technique is implemented, an important thing to remember is that dilution can sometimes be the solution. A probable “worst time” to release high TSS into a stream system might be when the stream is very low; summer low flow, for example. During these times, the flow may be low while the biological activity in the stream is very high. Conversely, the addition of high TSS or sediment during a big storm discharge might have a relatively low impact, because the stream is already turbid, and the stream energy is capable of transporting both suspended solids, and large quantities of bedload through the system. The optimum time to “pull” in-stream structures may be during the rising limb of a storm hydrograph.

Techniques to minimize Total Suspended Solids (TSS)

- **Padding** - Padding laid in the stream below the work site may trap some solids that are deposited in the stream during construction. After work is done, the padding is removed from the stream, and placed on the bank to assist in re-vegetation.
- **Clean, washed gravel** - Using clean, washed gravel decreases solid suspension, as there are fewer small particles deposited in the stream.
- **Excavation using a large bucket** - Each time a bucket of soil is placed in the stream, a portion is suspended. Approximately the same amount is suspended whether a small amount of soil is placed in the stream, or a large amount. Therefore, using a large excavator bucket instead of a small one, will reduce the total amount of soil that washes downstream.

- **Use of dozer for backfilling** - Using a dozer for backfilling instead of a backhoe follows the same principles – the fewer times soil is deposited in the stream, the less soil will be suspended.
- **Partial dewatering with a pump** - Partially dewatering a stream with a pump reduces the amount of water, and thus the amount of water that can suspend sediment.

Washing Fines

Definition and Purpose

- Washing fines is an “in-channel” sediment control method, which uses water, either from a water truck or hydrant, to wash stream fines that were brought to the surface of the channel bed during restoration, back into the interstitial spaces of the gravel and cobbles.
- The purpose of this technique is to reduce or eliminate the discharge of sediment from the channel bottom during the first seasonal flow. Sediment should not be allowed into stream channels; however, occasionally in-channel restoration work will involve moving or otherwise disturbing fines (sand and silt sized particles) that are already in the stream, usually below bankfull discharge elevation. Subsequent re-watering of the channel can result in a plume of turbidity and sedimentation.
- This technique washes the fines back into the channel bed. Bedload materials, including gravel cobbles, boulders and those fines, are naturally mobilized during higher storm flows. This technique is intended to delay the discharge until the fines would naturally be mobilized.

Appropriate Applications

- This technique should be used when construction work is required in channels. It is especially useful in intermittent or ephemeral streams in which work is performed “in the dry”, and which subsequently become re-watered.

Limitations

- The stream must have sufficient gravel and cobble substrate composition.
- The use of this technique requires consideration of time of year and timing of expected stream flows.
- The optimum time for the use of this technique is in the fall, prior to winter flows.
- Consultation with, and approval from the Department of Fish and Game and the Regional Water Quality Control Board may be required.

Implementation

- Apply sufficient water to wash fines, but not cause further erosion or runoff.
- Apply water slowly and evenly to prevent runoff and erosion.
- Consult with Department of Fish and Game and the Regional Water Quality Control Board for specific water quality requirements of applied water (e.g. chlorine).

Inspection and Maintenance

- None necessary

Costs

Cost may vary according to the combination of practices implemented.

Inspection and Maintenance

- Inspect and verify that activity-based BMPs are in place prior to the commencement of associated activities. While activities associated with the BMP are under way, inspect weekly during the rainy season and at two-week intervals in the non-rainy season to verify continued BMP implementation.
- Inspect BMPs subject to non-stormwater discharges daily while non-stormwater discharges occur.
- Inspect and repair equipment (for damaged hoses, fittings, and gaskets).

References

Manual of Standards of Erosion and Sediment Control Measures, Association of Bay Area Governments, May 1995.

Proposed Guidance Specifying Management Measures for Sources of Nonpoint Pollution in Coastal Waters, Work Group Working Paper, USEPA, April 1992.

Sedimentation and Erosion Control Practices, An Inventory of Current Practices (Draft), UESPA, 1990.

Stormwater Quality Handbooks Construction Site Best Management Practices (BMPs) Manual, State of California Department of Transportation (Caltrans), November 2000.

Stormwater Management for Construction Activities, Developing Pollution Prevention Plans and Best Management Practices, EPA 832-R-92005; USEPA, April 1992.

Water Quality Management Plan for the Lake Tahoe Region, Volume II, Handbook of Management Practices, Tahoe Regional Planning Agency, November 1988.

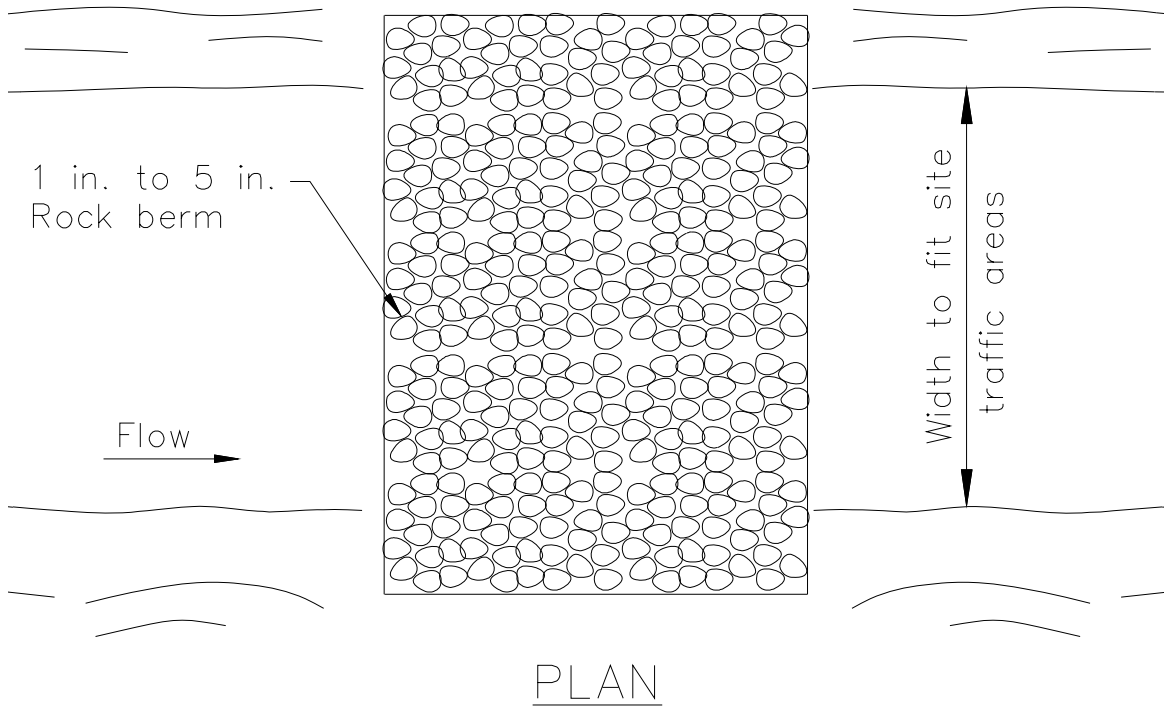
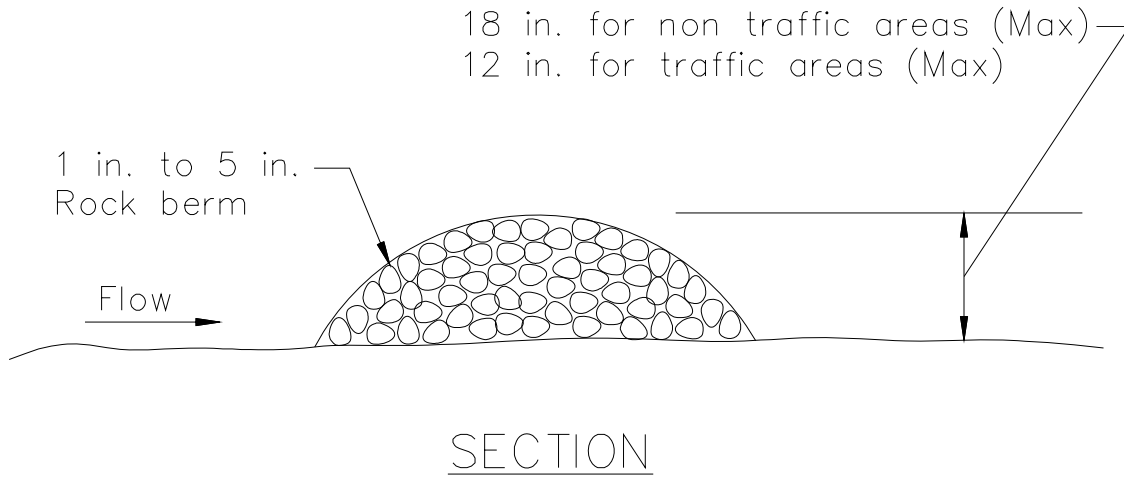

TYPICAL ROCK FILTER
NOT TO SCALE

Sediment Control [SE]

This page intentionally left blank.

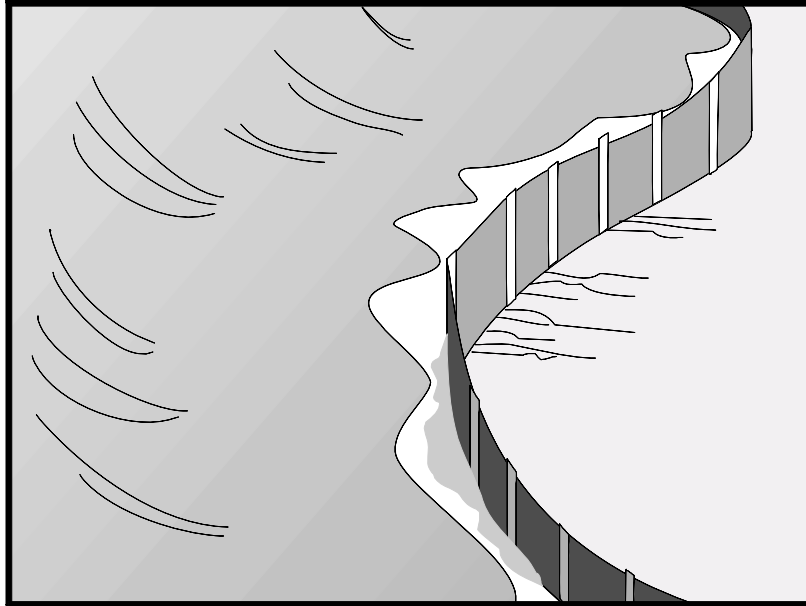

Description and Purpose

A silt fence is made of a woven geotextile that has been entrenched, attached to supporting poles, and sometimes backed by a plastic or wire mesh for support. The silt fence detains sediment-laden water, promoting sedimentation behind the fence.

Suitable Applications

Silt fences are suitable for perimeter control, placed below areas where sheet flows discharge from the site. They could also be used as interior controls below disturbed areas where runoff may occur in the form of sheet and rill erosion and around inlets within disturbed areas (SE-10). Silt fences are generally ineffective in locations where the flow is concentrated and are only applicable for sheet or overland flows. Silt fences are most effective when used in combination with erosion controls. Suitable applications include:

- Along the perimeter of a project.
- Below the toe or down slope of exposed and erodible slopes.
- Along streams and channels.
- Around temporary spoil areas and stockpiles.
- Around inlets.
- Below other small cleared areas.

Categories

EC	Erosion Control	
SE	Sediment Control	<input checked="" type="checkbox"/>
TC	Tracking Control	
WE	Wind Erosion Control	
NS	Non-Stormwater Management Control	
WM	Waste Management and Materials Pollution Control	

Legend:

- Primary Category**
- Secondary Category**

Targeted Constituents

Sediment	<input checked="" type="checkbox"/>
Nutrients	
Trash	
Metals	
Bacteria	
Oil and Grease	
Organics	

Potential Alternatives

- SE-5 Fiber Rolls
- SE-6 Gravel Bag Berm
- SE-8 Sandbag Barrier
- SE-10 Storm Drain Inlet Protection
- SE-14 Biofilter Bags



Limitations

- Do not use in streams, channels, drain inlets, or anywhere flow is concentrated.
- Do not use in locations where ponded water may cause a flooding hazard. Runoff typically ponds temporarily on the upstream side of silt fence.
- Do not use silt fence to divert water flows or place across any contour line. Fences not constructed on a level contour, or fences used to divert flow will concentrate flows resulting in additional erosion and possibly overtopping or failure of the silt fence.
- Improperly installed fences are subject to failure from undercutting, overtopping, or collapsing.
- Not effective unless trenched and keyed in.
- Not intended for use as mid-slope protection on slopes greater than 4:1 (H:V).
- Do not use on slopes subject to creeping, slumping, or landslides.

Implementation

General

A silt fence is a temporary sediment barrier consisting of woven geotextile stretched across and attached to supporting posts, trenched-in, and, depending upon the strength of fabric used, supported with plastic or wire mesh fence. Silt fences trap sediment by intercepting and detaining small amounts of sediment-laden runoff from disturbed areas in order to promote sedimentation behind the fence.

The following layout and installation guidance can improve performance and should be followed:

- Use principally in areas where sheet flow occurs.
- Install along a level contour, so water does not pond more than 1.5 ft at any point along the silt fence.
- The maximum length of slope draining to any point along the silt fence should be 200 ft or less.
- The maximum slope perpendicular to the fence line should be 1:1.
- Provide sufficient room for runoff to pond behind the fence and to allow sediment removal equipment to pass between the silt fence and toes of slopes or other obstructions. About 1200 ft² of ponding area should be provided for every acre draining to the fence.
- Turn the ends of the filter fence uphill to prevent stormwater from flowing around the fence.
- Leave an undisturbed or stabilized area immediately down slope from the fence where feasible.

- Silt fences should remain in place until the disturbed area is permanently stabilized, after which, the silt fence should be removed and properly disposed.
- Silt fence should be used in combination with erosion source controls up slope in order to provide the most effective sediment control.
- Be aware of local regulations regarding the type and installation requirements of silt fence, which may differ from those presented in this fact sheet.

Design and Layout

The fence should be supported by a plastic or wire mesh if the fabric selected does not have sufficient strength and bursting strength characteristics for the planned application (as recommended by the fabric manufacturer). Woven geotextile material should contain ultraviolet inhibitors and stabilizers to provide a minimum of six months of expected usable construction life at a temperature range of 0 °F to 120 °F.

- Layout in accordance with attached figures.
- For slopes steeper than 2:1 (H:V) and that contain a high number of rocks or large dirt clods that tend to dislodge, it may be necessary to install additional protection immediately adjacent to the bottom of the slope, prior to installing silt fence. Additional protection may be a chain link fence or a cable fence.
- For slopes adjacent to sensitive receiving waters or Environmentally Sensitive Areas (ESAs), silt fence should be used in conjunction with erosion control BMPs.

Standard vs. Heavy Duty Silt Fence

Standard Silt Fence

- Generally applicable in cases where the slope of area draining to the silt fence is 4:1 (H:V) or less.
- Used for shorter durations, typically 5 months or less
- Area draining to fence produces moderate sediment loads.

Heavy Duty Silt Fence

- Use is generally limited to 8 months or less.
- Area draining to fence produces moderate sediment loads.
- Heavy duty silt fence usually has 1 or more of the following characteristics, not possessed by standard silt fence.
 - Fence fabric has higher tensile strength.
 - Fabric is reinforced with wire backing or additional support.
 - Posts are spaced closer than pre-manufactured, standard silt fence products.
 - Posts are metal (steel or aluminum)

Materials

Standard Silt Fence

- Silt fence material should be woven geotextile with a minimum width of 36 in. and a minimum tensile strength of 100 lb force. The fabric should conform to the requirements in ASTM designation D4632 and should have an integral reinforcement layer. The

reinforcement layer should be a polypropylene, or equivalent, net provided by the manufacturer. The permittivity of the fabric should be between 0.1 sec^{-1} and 0.15 sec^{-1} in conformance with the requirements in ASTM designation D4491.

- Wood stakes should be commercial quality lumber of the size and shape shown on the plans. Each stake should be free from decay, splits or cracks longer than the thickness of the stake or other defects that would weaken the stakes and cause the stakes to be structurally unsuitable.
- Staples used to fasten the fence fabric to the stakes should be not less than 1.75 in. long and should be fabricated from 15 gauge or heavier wire. The wire used to fasten the tops of the stakes together when joining two sections of fence should be 9 gauge or heavier wire. Galvanizing of the fastening wire will not be required.

Heavy-Duty Silt Fence

- Some silt fence has a wire backing to provide additional support, and there are products that may use prefabricated plastic holders for the silt fence and use metal posts or bar reinforcement instead of wood stakes. If bar reinforcement is used in lieu of wood stakes, use number four or greater bar. Provide end protection for any exposed bar reinforcement for health and safety purposes.

Installation Guidelines – Traditional Method

Silt fences are to be constructed on a level contour. Sufficient area should exist behind the fence for ponding to occur without flooding or overtopping the fence.

- A trench should be excavated approximately 6 in. wide and 6 in. deep along the line of the proposed silt fence (trenches should not be excavated wider or deeper than necessary for proper silt fence installation).
- Bottom of the silt fence should be keyed-in a minimum of 12 in.
- Posts should be spaced a maximum of 6 ft apart and driven securely into the ground a minimum of 18 in. or 12 in. below the bottom of the trench.
- When standard strength geotextile is used, a plastic or wire mesh support fence should be fastened securely to the upslope side of posts using heavy-duty wire staples at least 1 in. long. The mesh should extend into the trench.
- When extra-strength geotextile and closer post spacing are used, the mesh support fence may be eliminated.
- Woven geotextile should be purchased in a long roll, then cut to the length of the barrier. When joints are necessary, geotextile should be spliced together only at a support post, with a minimum 6 in. overlap and both ends securely fastened to the post.
- The trench should be backfilled with native material and compacted.
- Construct silt fences with a setback of at least 3 ft from the toe of a slope. Where, due to specific site conditions, a 3 ft setback is not available, the silt fence may be constructed at the

toe of the slope, but should be constructed as far from the toe of the slope as practicable. Silt fences close to the toe of the slope will be less effective and more difficult to maintain.

- Construct the length of each reach so that the change in base elevation along the reach does not exceed 1/3 the height of the barrier; in no case should the reach exceed 500 ft.
- Cross barriers should be a minimum of 1/3 and a maximum of 1/2 the height of the linear barrier.
- See typical installation details at the end of this fact sheet.

Installation Guidelines - Static Slicing Method

- Static Slicing is defined as insertion of a narrow blade pulled behind a tractor, similar to a plow blade, at least 10 inches into the soil while at the same time pulling silt geotextile fabric into the ground through the opening created by the blade to the depth of the blade. Once the geotextile is installed, the soil is compacted using tractor tires.
- This method will not work with pre-fabricated, wire backed silt fence.
- Benefits:
 - Ease of installation (most often done with a 2 person crew). In addition, installation using static slicing has been found to be more efficient on slopes, in rocky soils, and in saturated soils.
 - Minimal soil disturbance.
 - Greater level of compaction along fence, leading to higher performance (i.e. greater sediment retention).
 - Uniform installation.
 - Less susceptible to undercutting/undermining.

Costs

- It should be noted that costs vary greatly across regions due to available supplies and labor costs.
- Average annual cost for installation using the traditional silt fence installation method (assumes 6 month useful life) is \$7 per linear foot based on vendor research. Range of cost is \$3.50 - \$9.10 per linear foot.
- In tests, the slicing method required 0.33 man hours per 100 linear feet, while the trenched based systems required as much as 1.01 man hours per linear foot.

Inspection and Maintenance

- BMPs must be inspected in accordance with General Permit requirements for the associated project type and risk level. It is recommended that at a minimum, BMPs be inspected weekly, prior to forecasted rain events, daily during extended rain events, and after the conclusion of rain events.
- Repair undercut silt fences.

- Repair or replace split, torn, slumping, or weathered fabric. The lifespan of silt fence fabric is generally 5 to 8 months.
- Silt fences that are damaged and become unsuitable for the intended purpose should be removed from the site of work, disposed, and replaced with new silt fence barriers.
- Sediment that accumulates in the BMP should be periodically removed in order to maintain BMP effectiveness. Sediment should be removed when the sediment accumulation reaches one-third of the barrier height.
- Silt fences should be left in place until the upstream area is permanently stabilized. Until then, the silt fence should be inspected and maintained regularly.
- Remove silt fence when upgradient areas are stabilized. Fill and compact post holes and anchor trench, remove sediment accumulation, grade fence alignment to blend with adjacent ground, and stabilize disturbed area.

References

Manual of Standards of Erosion and Sediment Control Measures, Association of Bay Area Governments, May 1995.

National Management Measures to Control Nonpoint Source Pollution from Urban Areas, United States Environmental Protection Agency, 2002.

Proposed Guidance Specifying Management Measures for Sources of Nonpoint Pollution in Coastal Waters, Work Group-Working Paper, USEPA, April 1992.

Sedimentation and Erosion Control Practices, and Inventory of Current Practices (Draft), UESPA, 1990.

Southeastern Wisconsin Regional Planning Commission (SWRPC). Costs of Urban Nonpoint Source Water Pollution Control Measures. Technical Report No. 31. Southeastern Wisconsin Regional Planning Commission, Waukesha, WI. 1991

Stormwater Quality Handbooks - Construction Site Best Management Practices (BMPs) Manual, State of California Department of Transportation (Caltrans), March 2003.

Stormwater Management Manual for The Puget Sound Basin, Washington State Department of Ecology, Public Review Draft, 1991.

U.S. Environmental Protection Agency (USEPA). Stormwater Management for Industrial Activities: Developing Pollution Prevention Plans and Best Management Practices. U.S. Environmental Protection Agency, Office of Water, Washington, DC, 1992.

Water Quality Management Plan for the Lake Tahoe Region, Volume II, Handbook of Management Practices, Tahoe Regional Planning Agency, November 1988. Soil Stabilization BMP Research for Erosion and Sediment Controls: Cost Survey Technical Memorandum, State of California Department of Transportation (Caltrans), July 2007.

Erosion and Sediment Control Manual, Oregon Department of Environmental Quality, February 2005.

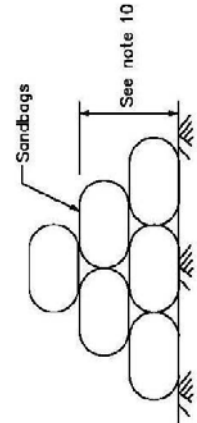
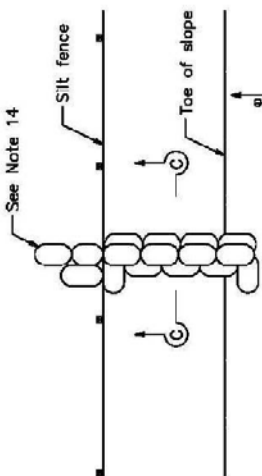
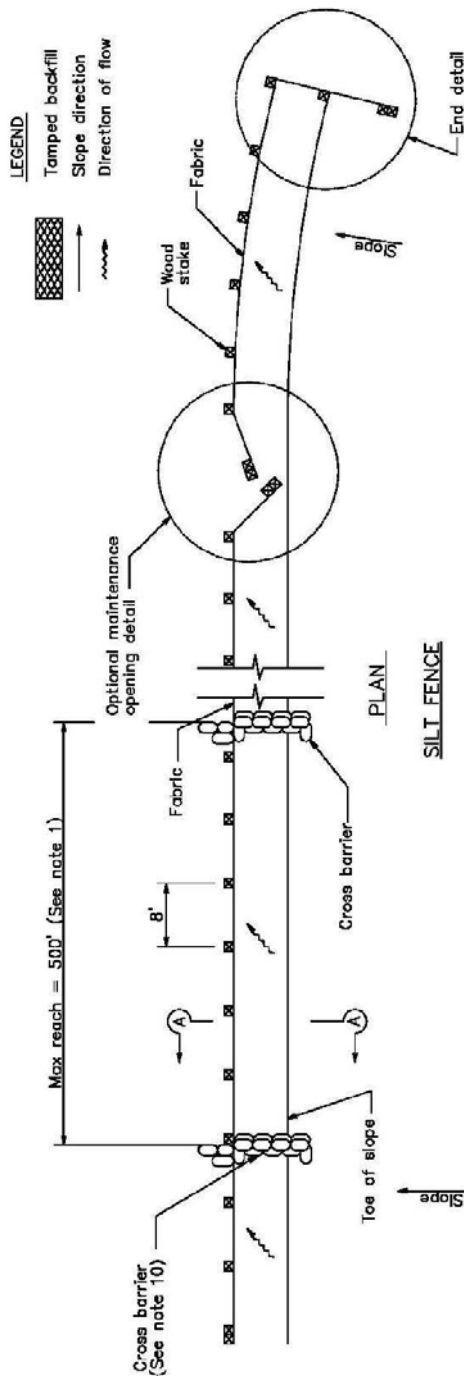

NOTES

1. Construct the length of each reach so that the change in base elevation along the reach does not exceed 1/3 the height of the linear barrier. In no case shall the reach length exceed 500'.
2. The last 8'-0" of fence shall be turned up slope.
3. Stake dimensions are nominal.
4. Dimension may vary to fit field condition.
5. Stakes shall be spaced at 8'-0" maximum and shall be positioned on downstream side of fence.
6. Stakes to overlap and fence fabric to fold around each stake one full turn. Secure fabric to stake with 4 staples.
7. Stakes shall be driven tightly together to prevent potential flow-through of sediment at joint. The tops of the stakes shall be secured with wire.
8. For end stake, fence fabric shall be folded around two stakes one full turn and secured with 4 staples.
9. Minimum 4 staples per stake. Dimensions shown are typical.
10. Cross barriers shall be a minimum of 1/3 and a maximum of 1/2 the height of the linear barrier.
11. Maintenance openings shall be constructed in a manner to ensure sediment remains behind silt fence.
12. Joining sections shall not be placed at sump locations.
13. Sandbag rows and layers shall be offset to eliminate gaps.
14. Add 3-4 bags to cross barrier on downgradient side of silt fence as needed to prevent bypass or undermining and as allowable based on site limits of disturbance.

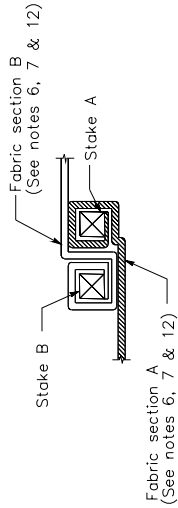
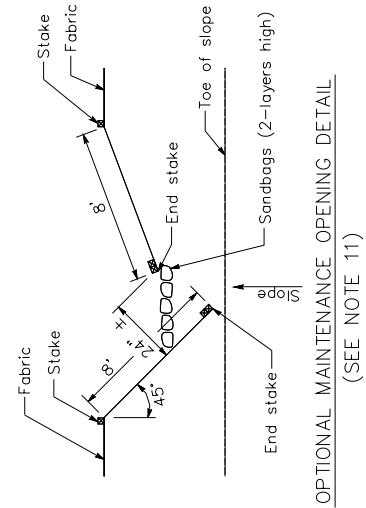
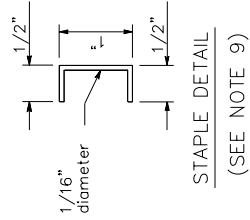

JOINING SECTION DETAIL (TOP VIEW)

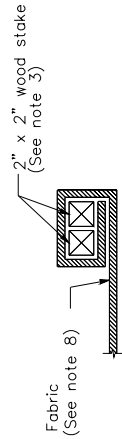

END STAKE DETAIL (TOP VIEW)

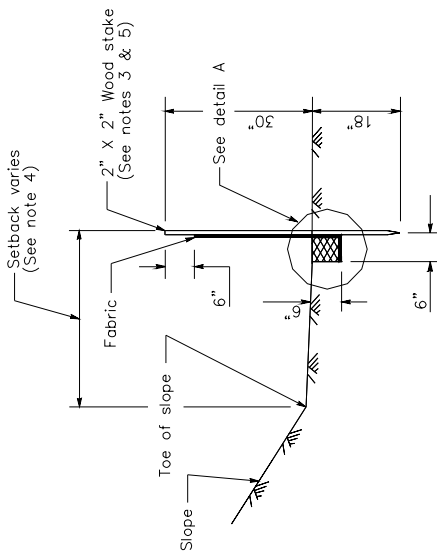
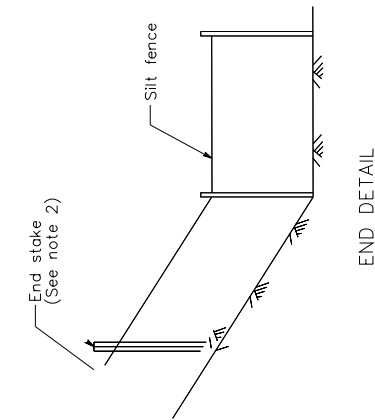

SECTION A-A

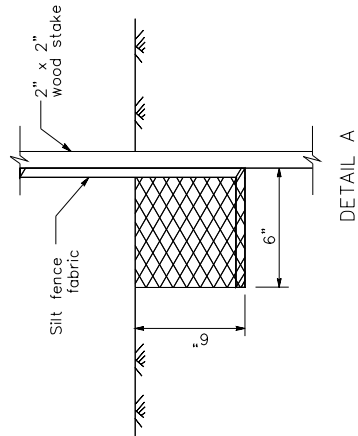

DETAIL A

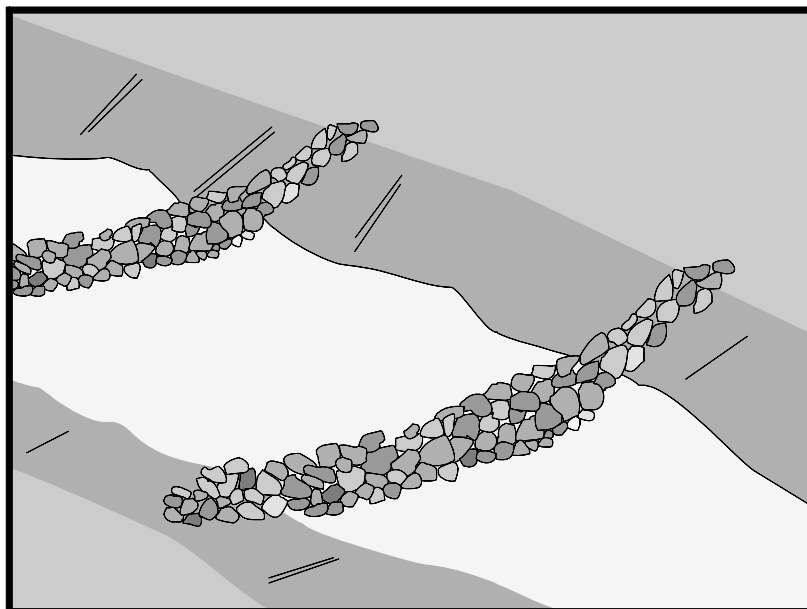

Description and Purpose

A check dam is a small barrier constructed of rock, gravel bags, sandbags, fiber rolls, or other proprietary products, placed across a constructed swale or drainage ditch. Check dams reduce the effective slope of the channel, thereby reducing scour and channel erosion by reducing flow velocity and increasing residence time within the channel, allowing sediment to settle.

Suitable Applications

Check dams may be appropriate in the following situations:

- To promote sedimentation behind the dam.
- To prevent erosion by reducing the velocity of channel flow in small intermittent channels and temporary swales.
- In small open channels that drain 10 acres or less.
- In steep channels where stormwater runoff velocities exceed 5 ft/s.
- During the establishment of grass linings in drainage ditches or channels.
- In temporary ditches where the short length of service does not warrant establishment of erosion-resistant linings.
- To act as a grade control structure.

Categories

EC	Erosion Control	<input checked="" type="checkbox"/>
SE	Sediment Control	<input checked="" type="checkbox"/>
TC	Tracking Control	
WE	Wind Erosion Control	
NS	Non-Stormwater Management Control	
WM	Waste Management and Materials Pollution Control	

Legend:

- Primary Category**
- Secondary Category**

Targeted Constituents

Sediment	<input checked="" type="checkbox"/>
Nutrients	
Trash	
Metals	
Bacteria	
Oil and Grease	
Organics	

Potential Alternatives

- SE-5 Fiber Rolls
- SE-6 Gravel Bag Berm
- SE-8 Sandbag Barrier
- SE-14 Biofilter Bags



Limitations

- Not to be used in live streams or in channels with extended base flows.
- Not appropriate in channels that drain areas greater than 10 acres.
- Not appropriate in channels that are already grass-lined unless erosion potential or sediment-laden flow is expected, as installation may damage vegetation.
- Require extensive maintenance following high velocity flows.
- Promotes sediment trapping which can be re-suspended during subsequent storms or removal of the check dam.
- Do not construct check dams with straw bales or silt fence.
- Water suitable for mosquito production may stand behind check dams, particularly if subjected to daily non-stormwater discharges.

Implementation

General

Check dams reduce the effective slope and create small pools in swales and ditches that drain 10 acres or less. Using check dams to reduce channel slope reduces the velocity of stormwater flows, thus reducing erosion of the swale or ditch and promoting sedimentation. Thus, check dams are dual-purpose and serve an important role as erosion controls as well as as sediment controls. Note that use of 1-2 isolated check dams for sedimentation will likely result in little net removal of sediment because of the small detention time and probable scour during longer storms. Using a series of check dams will generally increase their effectiveness. A sediment trap (SE-3) may be placed immediately upstream of the check dam to increase sediment removal efficiency.

Design and Layout

Check dams work by decreasing the effective slope in ditches and swales. An important consequence of the reduced slope is a reduction in capacity of the ditch or swale. This reduction in capacity should be considered when using this BMP, as reduced capacity can result in overtopping of the ditch or swale and resultant consequences. In some cases, such as a “permanent” ditch or swale being constructed early and used as a “temporary” conveyance for construction flows, the ditch or swale may have sufficient capacity such that the temporary reduction in capacity due to check dams is acceptable. When check dams reduce capacities beyond acceptable limits, either:

- Don't use check dams. Consider alternative BMPs, or.
- Increase the size of the ditch or swale to restore capacity.

Maximum slope and velocity reduction is achieved when the toe of the upstream dam is at the same elevation as the top of the downstream dam (see “Spacing Between Check Dams” detail at the end of this fact sheet). The center section of the dam should be lower than the edge sections (at least 6 inches), acting as a spillway, so that the check dam will direct flows to the center of

the ditch or swale (see “Typical Rock Check Dam” detail at the end of this fact sheet). Bypass or side-cutting can occur if a sufficient spillway is not provided in the center of the dam.

Check dams are usually constructed of rock, gravel bags, sandbags, and fiber rolls. A number of products can also be used as check dams (e.g. HDPE check dams, temporary silt dikes (SE-12)), and some of these products can be removed and reused. Check dams can also be constructed of logs or lumber, and have the advantage of a longer lifespan when compared to gravel bags, sandbags, and fiber rolls. Check dams should not be constructed from straw bales or silt fences, since concentrated flows quickly wash out these materials.

Rock check dams are usually constructed of 8 to 12 in. rock. The rock is placed either by hand or mechanically, but never just dumped into the channel. The dam should completely span the ditch or swale to prevent washout. The rock used should be large enough to stay in place given the expected design flow through the channel. It is recommended that abutments be extended 18 in. into the channel bank. Rock can be graded such that smaller diameter rock (e.g. 2-4 in) is located on the upstream side of larger rock (holding the smaller rock in place); increasing residence time.

Log check dams are usually constructed of 4 to 6 in. diameter logs, installed vertically. The logs should be embedded into the soil at least 18 in. Logs can be bolted or wired to vertical support logs that have been driven or buried into the soil.

See fiber rolls, SE-5, for installation of fiber roll check dams.

Gravel bag and sand bag check dams are constructed by stacking bags across the ditch or swale, shaped as shown in the drawings at the end of this fact sheet (see “Gravel Bag Check Dam” detail at the end of this fact sheet).

Manufactured products, such as temporary silt dikes (SE-12), should be installed in accordance with the manufacturer’s instructions. Installation typically requires anchoring or trenching of products, as well as regular maintenance to remove accumulated sediment and debris.

If grass is planted to stabilize the ditch or swale, the check dam should be removed when the grass has matured (unless the slope of the swales is greater than 4%).

The following guidance should be followed for the design and layout of check dams:

- Install the first check dam approximately 16 ft from the outfall device and at regular intervals based on slope gradient and soil type.
- Check dams should be placed at a distance and height to allow small pools to form between each check dam.
- For multiple check dam installation, backwater from a downstream check dam should reach the toes of the upstream check dam.
- A sediment trap provided immediately upstream of the check dam will help capture sediment. Due to the potential for this sediment to be resuspended in subsequent storms, the sediment trap should be cleaned following each storm event.

- High flows (typically a 2-year storm or larger) should safely flow over the check dam without an increase in upstream flooding or damage to the check dam.
- Where grass is used to line ditches, check dams should be removed when grass has matured sufficiently to protect the ditch or swale.

Materials

- Rock used for check dams should typically be 8-12 in rock and be sufficiently sized to stay in place given expected design flows in the channel. Smaller diameter rock (e.g. 2 to 4 in) can be placed on the upstream side of larger rock to increase residence time.
- Gravel bags used for check dams should conform to the requirements of SE-6, Gravel Bag Berms.
- Sandbags used for check dams should conform to SE-8, Sandbag Barrier.
- Fiber rolls used for check dams should conform to SE-5, Fiber Rolls.
- Temporary silt dikes used for check dams should conform to SE-12, Temporary Silt Dikes.

Installation

- Rock should be placed individually by hand or by mechanical methods (no dumping of rock) to achieve complete ditch or swale coverage.
- Tightly abut bags and stack according to detail shown in the figure at the end of this section (pyramid approach). Gravel bags and sandbags should not be stacked any higher than 3 ft.
- Upper rows of gravel and sand bags shall overlap joints in lower rows.
- Fiber rolls should be trenched in, backfilled, and firmly staked in place.
- Install along a level contour.
- HDPE check dams, temporary silt dikes, and other manufactured products should be used and installed per manufacturer specifications.

Costs

Cost consists of labor costs if materials are readily available (such as gravel on-site). If material must be imported, costs will increase. For other material and installation costs, see SE-5, SE-6, SE-8, SE-12, and SE-14.

Inspection and Maintenance

- BMPs must be inspected in accordance with General Permit requirements for the associated project type and risk level. It is recommended that at a minimum, BMPs be inspected weekly, prior to forecasted rain events, daily during extended rain events, and after the conclusion of rain events.
- Replace missing rock, bags, rolls, etc. Replace bags or rolls that have degraded or have become damaged.

- If the check dam is used as a sediment capture device, sediment that accumulates behind the BMP should be periodically removed in order to maintain BMP effectiveness. Sediment should be removed when the sediment accumulation reaches one-third of the barrier height.
- If the check dam is used as a grade control structure, sediment removal is not required as long as the system continues to control the grade.
- Inspect areas behind check dams for pools of standing water, especially if subjected to daily non-stormwater discharges.
- Remove accumulated sediment prior to permanent seeding or soil stabilization.
- Remove check dam and accumulated sediment when check dams are no longer needed.

References

Draft – Sedimentation and Erosion Control, and Inventory of Current Practices, USEPA, April 1990.

Manual of Standards of Erosion and Sediment Control Measures, Association of Bay Area Governments, May 1995.

Stormwater Quality Handbooks - Construction Site Best Management Practices (BMPs) Manual, State of California Department of Transportation (Caltrans), March 2003.

Stormwater Management of the Puget Sound Basin, Technical Manual, Publication #91-75, Washington State Department of Ecology, February 1992.

Erosion and Sediment Control Manual, Oregon Department of Environmental Quality, February 2005.

Metzger, M.E. 2004. Managing mosquitoes in stormwater treatment devices. University of California Division of Agriculture and Natural Resources, Publication 8125. On-line: <http://anrcatalog.ucdavis.edu/pdf/8125.pdf>

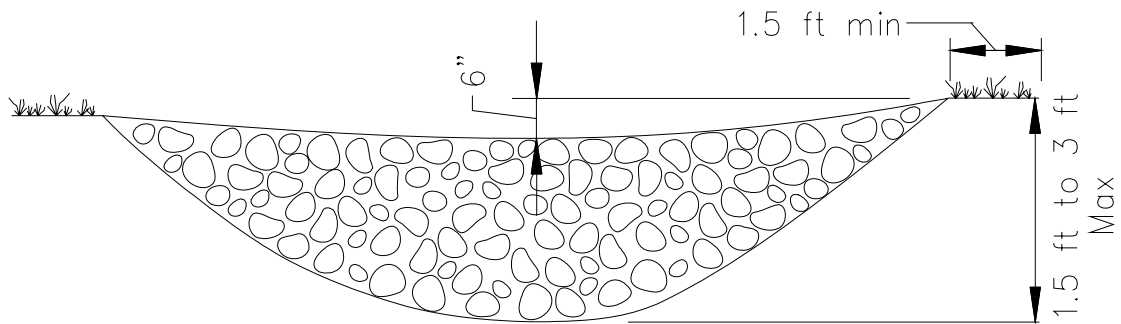

ELEVATION

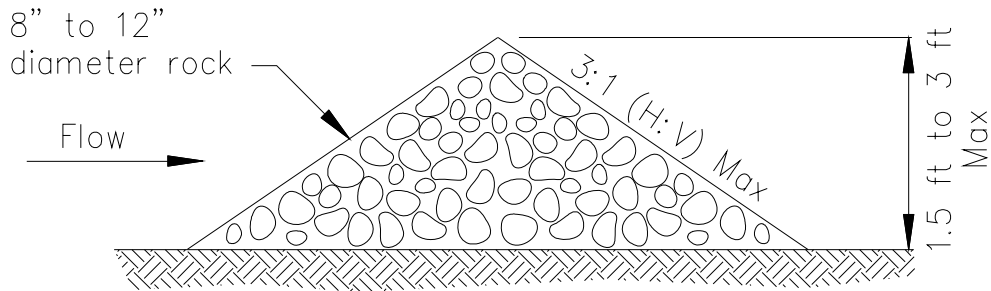

TYPICAL ROCK CHECK DAM SECTION

ROCK CHECK DAM
NOT TO SCALE

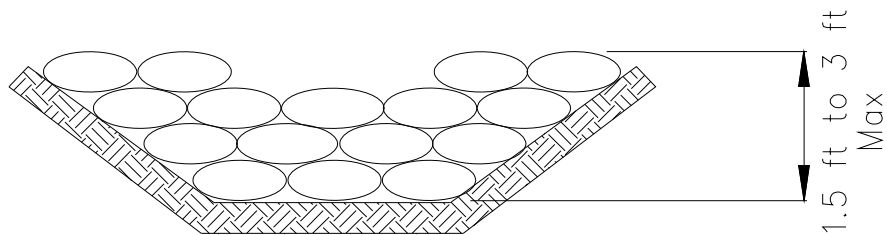

GRAVEL BAG CHECK DAM ELEVATION
NOT TO SCALE

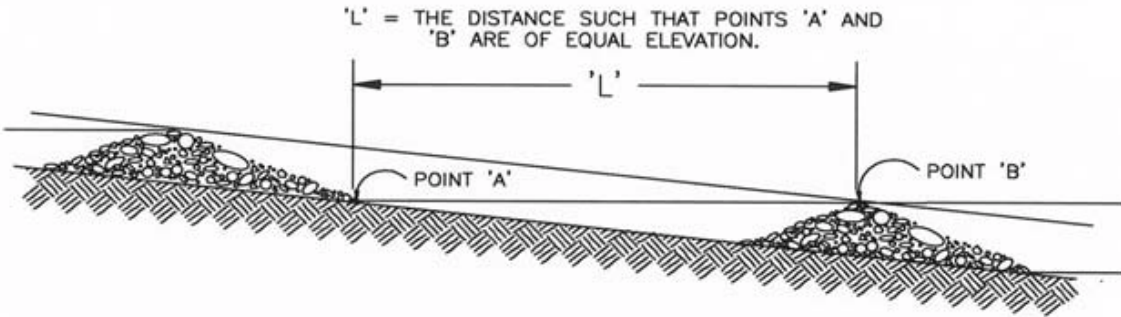

SPACING BETWEEN CHECK DAMS

This page intentionally left blank

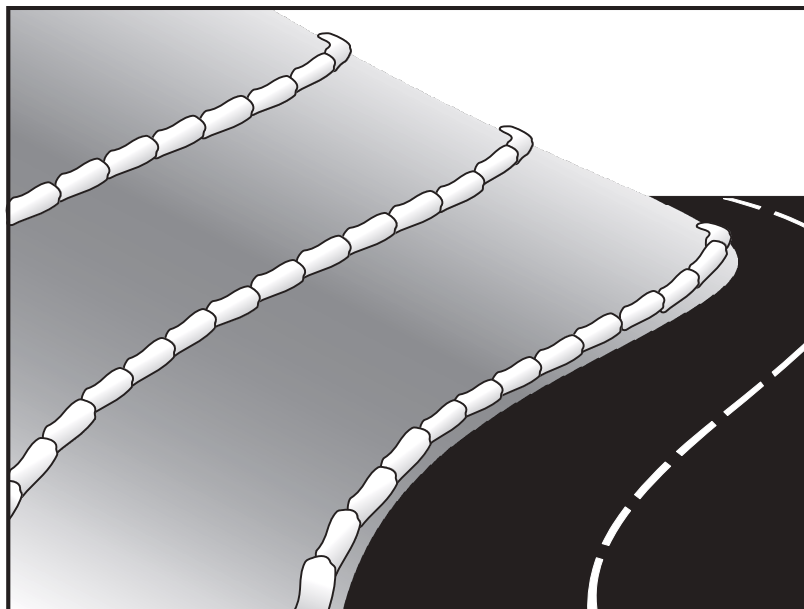

Description and Purpose

A gravel bag berm is a series of gravel-filled bags placed on a level contour to intercept sheet flows. Gravel bags pond sheet flow runoff, allowing sediment to settle out, and release runoff slowly as sheet flow, preventing erosion.

Suitable Applications

Gravel bag berms may be suitable:

- As a linear sediment control measure:
 - Below the toe of slopes and erodible slopes
 - As sediment traps at culvert/pipe outlets
 - Below other small cleared areas
 - Along the perimeter of a site
 - Down slope of exposed soil areas
 - Around temporary stockpiles and spoil areas
 - Parallel to a roadway to keep sediment off paved areas
 - Along streams and channels
- As a linear erosion control measure:
 - Along the face and at grade breaks of exposed and erodible slopes to shorten slope length and spread runoff as sheet flow.

Categories

EC	Erosion Control	<input checked="" type="checkbox"/>
SE	Sediment Control	<input checked="" type="checkbox"/>
TC	Tracking Control	
WE	Wind Erosion Control	
NS	Non-Stormwater Management Control	
WM	Waste Management and Materials Pollution Control	

Legend:

- Primary Category**
- Secondary Category**

Targeted Constituents

Sediment	<input checked="" type="checkbox"/>
Nutrients	
Trash	
Metals	
Bacteria	
Oil and Grease	
Organics	

Potential Alternatives

- SE-1 Silt Fence
- SE-5 Fiber Roll
- SE-8 Sandbag Barrier
- SE-14 Biofilter Bags



- At the top of slopes to divert runoff away from disturbed slopes.
- As chevrons (small check dams) across mildly sloped construction roads. For use check dam use in channels, see SE-4, Check Dams.

Limitations

- Gravel berms may be difficult to remove.
- Removal problems limit their usefulness in landscaped areas.
- Gravel bag berm may not be appropriate for drainage areas greater than 5 acres.
- Runoff will pond upstream of the berm, possibly causing flooding if sufficient space does not exist.
- Degraded gravel bags may rupture when removed, spilling contents.
- Installation can be labor intensive.
- Durability of gravel bags is somewhat limited and bags may need to be replaced when installation is required for longer than 6 months.
- Easily damaged by construction equipment.
- When used to detain concentrated flows, maintenance requirements increase.

Implementation

General

A gravel bag berm consists of a row of open graded gravel-filled bags placed on a level contour. When appropriately placed, a gravel bag berm intercepts and slows sheet flow runoff, causing temporary ponding. The temporary ponding allows sediment to settle. The open graded gravel in the bags is porous, which allows the ponded runoff to flow slowly through the bags, releasing the runoff as sheet flows. Gravel bag berms also interrupt the slope length and thereby reduce erosion by reducing the tendency of sheet flows to concentrate into rivulets, which erode rills, and ultimately gullies, into disturbed, sloped soils. Gravel bag berms are similar to sand bag barriers, but are more porous. Generally, gravel bag berms should be used in conjunction with temporary soil stabilization controls up slope to provide effective erosion and sediment control.

Design and Layout

- Locate gravel bag berms on level contours.
- When used for slope interruption, the following slope/sheet flow length combinations apply:
 - Slope inclination of 4:1 (H:V) or flatter: Gravel bags should be placed at a maximum interval of 20 ft, with the first row near the slope toe.
 - Slope inclination between 4:1 and 2:1 (H:V): Gravel bags should be placed at a maximum interval of 15 ft. (a closer spacing is more effective), with the first row near the slope toe.

Slope inclination 2:1 (H:V) or greater: Gravel bags should be placed at a maximum interval of 10 ft. (a closer spacing is more effective), with the first row near the slope toe.

- Turn the ends of the gravel bag barriers up slope to prevent runoff from going around the berm.
- Allow sufficient space up slope from the gravel bag berm to allow ponding, and to provide room for sediment storage.
- For installation near the toe of the slope, gravel bag barriers should be set back from the slope toe to facilitate cleaning. Where specific site conditions do not allow for a set-back, the gravel bag barrier may be constructed on the toe of the slope. To prevent flows behind the barrier, bags can be placed perpendicular to a berm to serve as cross barriers.
- Drainage area should not exceed 5 acres.
- In Non-Traffic Areas:
 - Height = 18 in. maximum
 - Top width = 24 in. minimum for three or more layer construction
 - Top width = 12 in. minimum for one or two layer construction
 - Side slopes = 2:1 (H:V) or flatter
- In Construction Traffic Areas:
 - Height = 12 in. maximum
 - Top width = 24 in. minimum for three or more layer construction.
 - Top width = 12 in. minimum for one or two layer construction.
 - Side slopes = 2:1 (H:V) or flatter.
- Butt ends of bags tightly.
- On multiple row, or multiple layer construction, overlap butt joints of adjacent row and row beneath.
- Use a pyramid approach when stacking bags.

Materials

- **Bag Material:** Bags should be woven polypropylene, polyethylene or polyamide fabric or burlap, minimum unit weight of 4 ounces/yd², Mullen burst strength exceeding 300 lb/in² in conformance with the requirements in ASTM designation D3786, and ultraviolet stability exceeding 70% in conformance with the requirements in ASTM designation D4355.

- **Bag Size:** Each gravel-filled bag should have a length of 18 in., width of 12 in., thickness of 3 in., and mass of approximately 33 lbs. Bag dimensions are nominal, and may vary based on locally available materials.
- **Fill Material:** Fill material should be 0.5 to 1 in. crushed rock, clean and free from clay, organic matter, and other deleterious material, or other suitable open graded, non-cohesive, porous gravel.

Costs

Material costs for gravel bags are average and are dependent upon material availability. \$2.50-3.00 per filled gravel bag is standard based upon vendor research.

Inspection and Maintenance

- BMPs must be inspected in accordance with General Permit requirements for the associated project type and risk level. It is recommended that at a minimum, BMPs be inspected weekly, prior to forecasted rain events, daily during extended rain events, and after the conclusion of rain events.
- Gravel bags exposed to sunlight will need to be replaced every two to three months due to degrading of the bags.
- Reshape or replace gravel bags as needed.
- Repair washouts or other damage as needed.
- Sediment that accumulates in the BMP should be periodically removed in order to maintain BMP effectiveness. Sediment should be removed when the sediment accumulation reaches one-third of the barrier height.
- Remove gravel bag berms when no longer needed and recycle gravel fill whenever possible and properly dispose of bag material. Remove sediment accumulation and clean, re-grade, and stabilize the area.

References

Handbook of Steel Drainage and Highway Construction, American Iron and Steel Institute, 1983.

Stormwater Quality Handbooks - Construction Site Best Management Practices (BMPs) Manual, State of California Department of Transportation (Caltrans), March 2003.

Stormwater Pollution Plan Handbook, First Edition, State of California, Department of Transportation Division of New Technology, Materials and Research, October 1992.

Erosion and Sediment Control Manual, Oregon Department of Environmental Quality, February 2005.

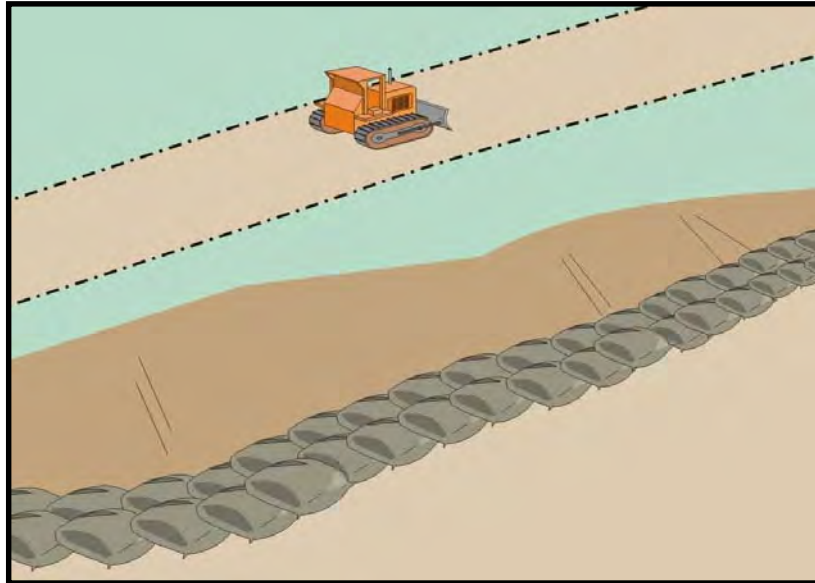

Description and Purpose

A sandbag barrier is a series of sand-filled bags placed on a level contour to intercept or to divert sheet flows. Sandbag barriers placed on a level contour pond sheet flow runoff, allowing sediment to settle out.

Suitable Applications

Sandbag barriers may be suitable:

- As a linear sediment control measure:
 - Below the toe of slopes and erodible slopes.
 - As sediment traps at culvert/pipe outlets.
 - Below other small cleared areas.
 - Along the perimeter of a site.
 - Down slope of exposed soil areas.
 - Around temporary stockpiles and spoil areas.
 - Parallel to a roadway to keep sediment off paved areas.
 - Along streams and channels.
- As linear erosion control measure:
 - Along the face and at grade breaks of exposed and erodible slopes to shorten slope length and spread runoff as sheet flow.

Categories

EC	Erosion Control	<input checked="" type="checkbox"/>
SE	Sediment Control	<input checked="" type="checkbox"/>
TC	Tracking Control	
WE	Wind Erosion Control	
NS	Non-Stormwater Management Control	
WM	Waste Management and Materials Pollution Control	

Legend:

- Primary Category
- Secondary Category

Targeted Constituents

Sediment	<input checked="" type="checkbox"/>
Nutrients	
Trash	
Metals	
Bacteria	
Oil and Grease	
Organics	

Potential Alternatives

- SE-1 Silt Fence
- SE-5 Fiber Rolls
- SE-6 Gravel Bag Berm
- SE-14 Biofilter Bags



- At the top of slopes to divert runoff away from disturbed slopes.
- As check dams across mildly sloped construction roads.

Limitations

- It is necessary to limit the drainage area upstream of the barrier to 5 acres.
- Sandbags are not intended to be used as filtration devices.
- Easily damaged by construction equipment.
- Degraded sandbags may rupture when removed, spilling sand.
- Sand is easily transported by runoff if bag is damaged or ruptured.
- Installation can be labor intensive.
- Durability of sandbags is somewhat limited and bags may need to be replaced when installation is required for longer than 6 months. When used to detain concentrated flows, maintenance requirements increase.
- Burlap should not be used for sandbags.

Implementation

General

A sandbag barrier consists of a row of sand-filled bags placed on a level contour. When appropriately placed, a sandbag barrier intercepts and slows sheet flow runoff, causing temporary ponding. The temporary ponding allows sediment to settle. Sand-filled bags have limited porosity, which is further limited as the fine sand tends to quickly plug with sediment, limiting or completely blocking the rate of flow through the barrier. If a porous barrier is desired, consider SE-1, Silt Fence, SE-5, Fiber Rolls, SE-6, Gravel Bag Berms or SE-14, Biofilter Bags. Sandbag barriers also interrupt the slope length and thereby reduce erosion by reducing the tendency of sheet flows to concentrate into rivulets which erode rills, and ultimately gullies, into disturbed, sloped soils. Sandbag barriers are similar to gravel bag berms, but less porous. Generally, sandbag barriers should be used in conjunction with temporary soil stabilization controls up slope to provide effective erosion and sediment control.

Design and Layout

- Locate sandbag barriers on a level contour.
 - When used for slope interruption, the following slope/sheet flow length combinations apply:
 - Slope inclination of 4:1 (H:V) or flatter: Sandbags should be placed at a maximum interval of 20 ft, with the first row near the slope toe.
 - Slope inclination between 4:1 and 2:1 (H:V): Sandbags should be placed at a maximum interval of 15 ft. (a closer spacing is more effective), with the first row near the slope toe.
- Slope inclination 2:1 (H:V) or greater: Sandbags should be placed at a maximum interval of 10 ft. (a closer spacing is more effective), with the first row near the slope toe.

- Turn the ends of the sandbag barrier up slope to prevent runoff from going around the barrier.
- Allow sufficient space up slope from the barrier to allow ponding, and to provide room for sediment storage.
- For installation near the toe of the slope, sand bag barriers should be set back from the slope toe to facilitate cleaning. Where specific site conditions do not allow for a set-back, the sand bag barrier may be constructed on the toe of the slope. To prevent flows behind the barrier, bags can be placed perpendicular to a berm to serve as cross barriers.
- Drainage area should not exceed 5 acres.
- Stack sandbags at least three bags high.
- Butt ends of bags tightly.
- Overlap butt joints of row beneath with each successive row.
- Use a pyramid approach when stacking bags.
- In non-traffic areas
 - Height = 18 in. maximum
 - Top width = 24 in. minimum for three or more layer construction
 - Side slope = 2:1 (H:V) or flatter
- In construction traffic areas
 - Height = 12 in. maximum
 - Top width = 24 in. minimum for three or more layer construction.
 - Side slopes = 2:1 (H:V) or flatter.
- See typical sandbag barrier installation details at the end of this fact sheet.

Materials

- **Sandbag Material:** Sandbag should be woven polypropylene, polyethylene or polyamide fabric, minimum unit weight of 4 ounces/yd², Mullen burst strength exceeding 300 lb/in² in conformance with the requirements in ASTM designation D3786, and ultraviolet stability exceeding 70% in conformance with the requirements in ASTM designation D4355. Use of burlap is not an acceptable substitute, as sand can more easily mobilize out of burlap.
- **Sandbag Size:** Each sand-filled bag should have a length of 18 in., width of 12 in., thickness of 3 in., and mass of approximately 33 lbs. Bag dimensions are nominal, and may vary based on locally available materials.

- **Fill Material:** All sandbag fill material should be non-cohesive, Class 3 (Caltrans Standard Specification, Section 25) permeable material free from clay and deleterious material, such as recycled concrete or asphalt..

Costs

Empty sandbags cost \$0.25 - \$0.75. Average cost of fill material is \$8 per yd³. Additional labor is required to fill the bags. Pre-filled sandbags are more expensive at \$1.50 - \$2.00 per bag. These costs are based upon vendor research.

Inspection and Maintenance

- BMPs must be inspected in accordance with General Permit requirements for the associated project type and risk level. It is recommended that at a minimum, BMPs be inspected weekly, prior to forecasted rain events, daily during extended rain events, and after the conclusion of rain events.
- Sandbags exposed to sunlight will need to be replaced every two to three months due to degradation of the bags.
- Reshape or replace sandbags as needed.
- Repair washouts or other damage as needed.
- Sediment that accumulates behind the BMP should be periodically removed in order to maintain BMP effectiveness. Sediment should be removed when the sediment accumulation reaches one-third of the barrier height.
- Remove sandbags when no longer needed and recycle sand fill whenever possible and properly dispose of bag material. Remove sediment accumulation, and clean, re-grade, and stabilize the area.

References

Standard Specifications for Construction of Local Streets and Roads, California Department of Transportation (Caltrans), July 2002.

Stormwater Quality Handbooks - Construction Site Best Management Practices (BMPs) Manual, State of California Department of Transportation (Caltrans), March 2003.

Erosion and Sediment Control Manual, Oregon Department of Environmental Quality, February 2005.

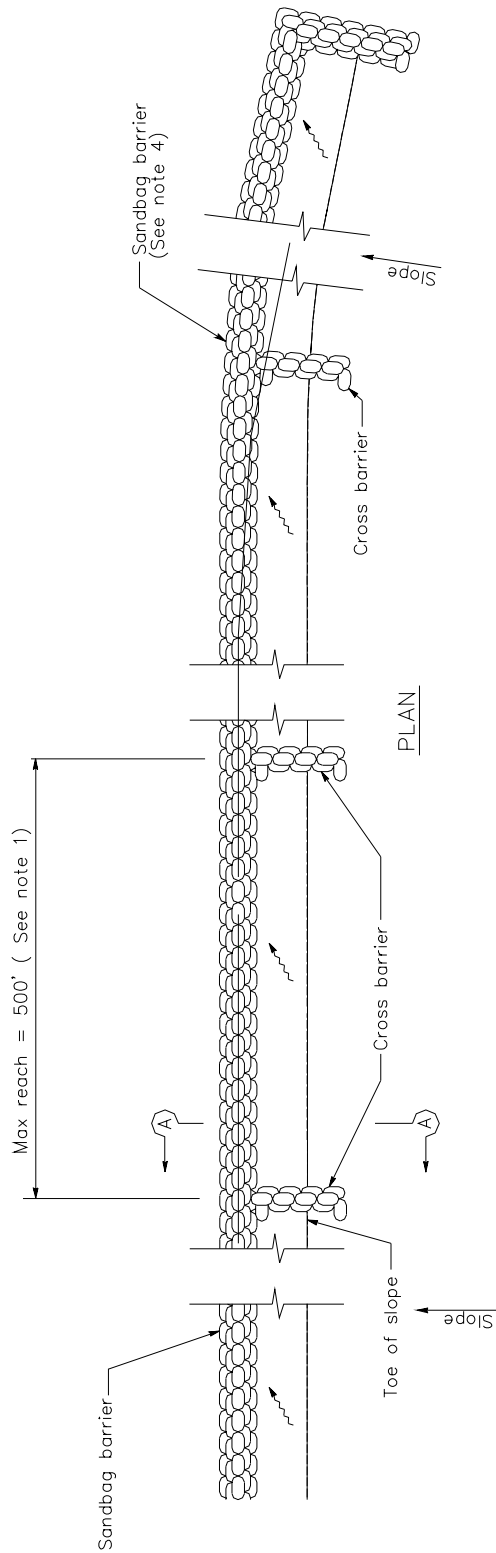

SANDBAG BARRIER

NOTES

1. Construct the length of each reach so that the change in base elevation along the reach does not exceed $1/2$ the height of the linear barrier. In no case shall the reach length exceed 500'.
2. Place sandbags tightly.
3. Dimension may vary to fit field condition.
4. Sandbag barrier shall be a minimum of 3 bags high.
5. The end of the barrier shall be turned up slope.
6. Cross barriers shall be a min of $1/2$ and a max of $2/3$ the height of the linear barrier.
7. Sandbag rows and layers shall be staggered to eliminate gaps.

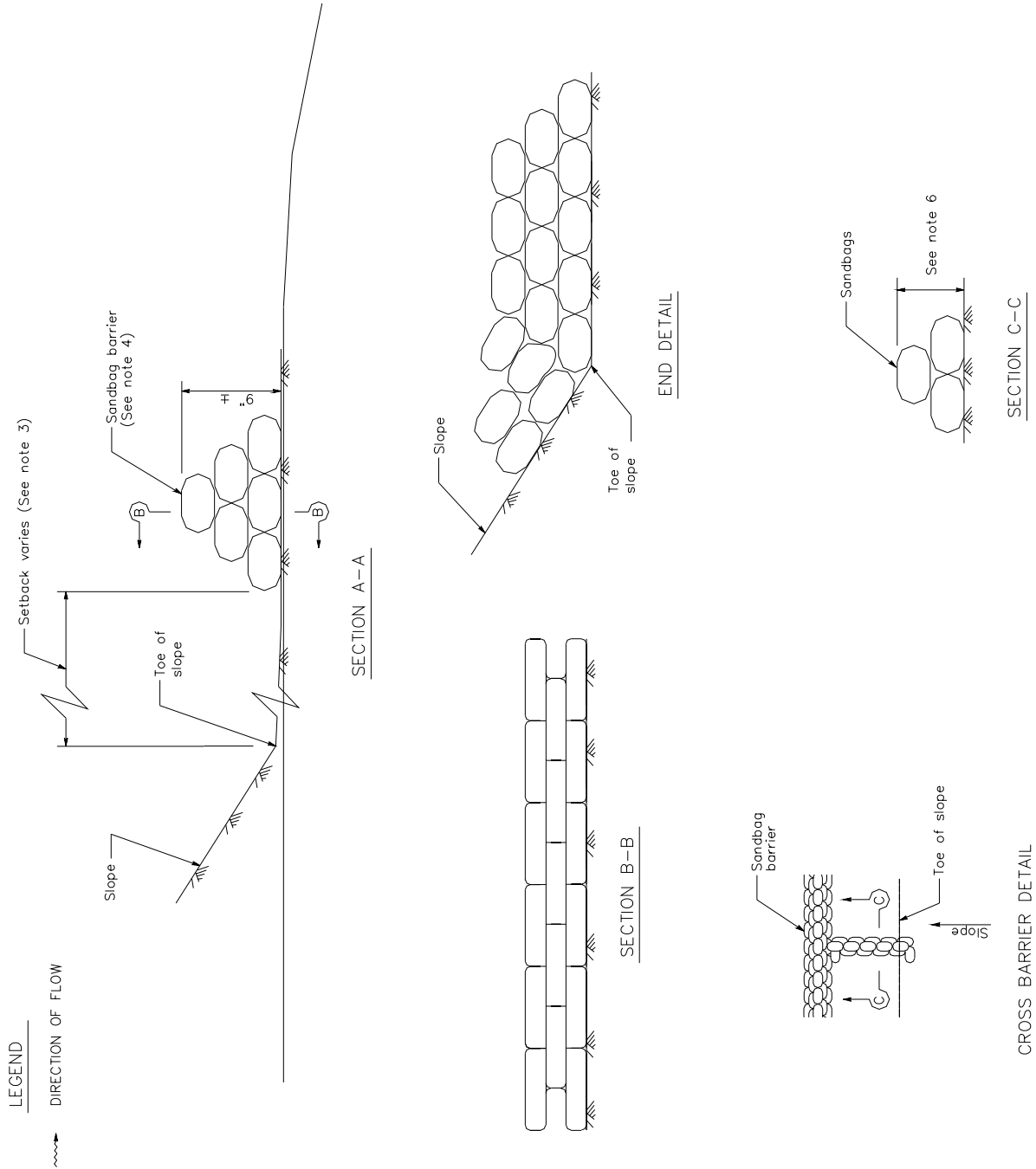

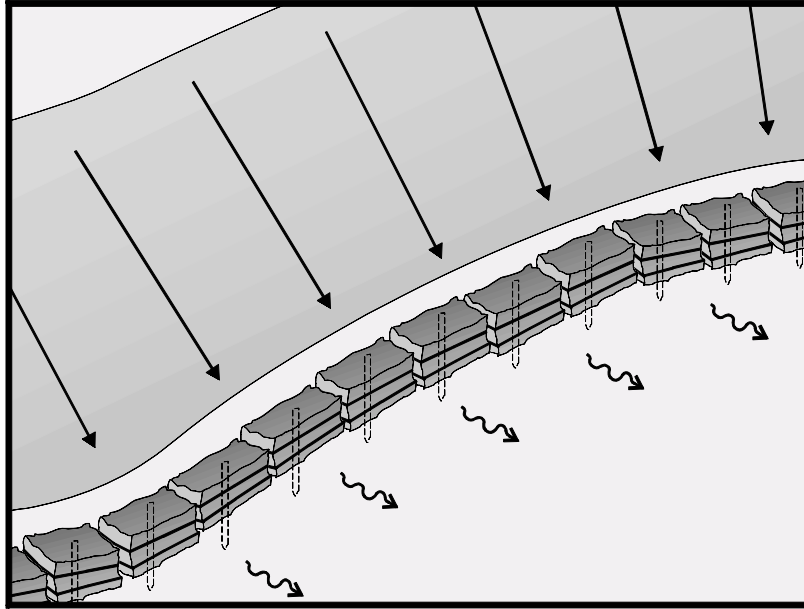

Description and Purpose

A straw bale barrier is a series of straw bales placed on a level contour to intercept sheet flows. Straw bale barriers pond sheet-flow runoff, allowing sediment to settle out.

Suitable Applications

Straw bale barriers may be suitable:

- As a linear sediment control measure:
 - Below the toe of slopes and erodible slopes
 - As sediment traps at culvert/pipe outlets
 - Below other small cleared areas
 - Along the perimeter of a site
 - Down slope of exposed soil areas
 - Around temporary stockpiles and spoil areas
 - Parallel to a roadway to keep sediment off paved areas
 - Along streams and channels
- As linear erosion control measure:
 - Along the face and at grade breaks of exposed and erodible slopes to shorten slope length and spread runoff as sheet flow

Categories

EC	Erosion Control	<input checked="" type="checkbox"/>
SE	Sediment Control	<input checked="" type="checkbox"/>
TC	Tracking Control	
WE	Wind Erosion Control	
NS	Non-Stormwater Management Control	
WM	Waste Management and Materials Pollution Control	

Legend:

- Primary Objective
- Secondary Objective

Targeted Constituents

Sediment	<input checked="" type="checkbox"/>
Nutrients	
Trash	
Metals	
Bacteria	
Oil and Grease	
Organics	

Potential Alternatives

- SE-1 Silt Fence
- SE-5 Fiber Rolls
- SE-6 Gravel Bag Berm
- SE-8 Sandbag Barrier



- At the top of slopes to divert runoff away from disturbed slopes
- As check dams across mildly sloped construction roads

Limitations

Straw bale barriers:

- Are not to be used for extended periods of time because they tend to rot and fall apart
- Are suitable only for sheet flow on slopes of 10 % or flatter
- Are not appropriate for large drainage areas, limit to one acre or less
- May require constant maintenance due to rotting
- Are not recommended for concentrated flow, inlet protection, channel flow, and live streams
- Cannot be made of bale bindings of jute or cotton
- Require labor-intensive installation and maintenance
- Cannot be used on paved surfaces
- Should not to be used for drain inlet protection
- Should not be used on lined ditches
- May introduce undesirable non-native plants to the area

Implementation

General

A straw bale barrier consists of a row of straw bales placed on a level contour. When appropriately placed, a straw bale barrier intercepts and slows sheet flow runoff, causing temporary ponding. The temporary ponding provides quiescent conditions allowing sediment to settle. Straw bale barriers also interrupt the slope length and thereby reduce erosion by reducing the tendency of sheet flows to concentrate into rivulets, which erode rills, and ultimately gullies, into disturbed, sloped soils.

Straw bale barriers have not been as effective as expected due to improper use. These barriers have been placed in streams and drainage ways where runoff volumes and velocities have caused the barriers to wash out. In addition, failure to stake and entrench the straw bale has allowed undercutting and end flow. Use of straw bale barriers in accordance with this BMP should produce acceptable results.

Design and Layout

- Locate straw bale barriers on a level contour.
 - Slopes up to 10:1 (H:V): Straw bales should be placed at a maximum interval of 50 ft (a closer spacing is more effective), with the first row near the toe of slope.
 - Slopes greater than 10:1 (H:V): Not recommended.

- Turn the ends of the straw bale barrier up slope to prevent runoff from going around the barrier.
- Allow sufficient space up slope from the barrier to allow ponding, and to provide room for sediment storage.
- For installation near the toe of the slope, consider moving the barrier away from the slope toe to facilitate cleaning. To prevent flow behind the barrier, sand bags can be placed perpendicular to the barrier to serve as cross barriers.
- Drainage area should not exceed 1 acre, or 0.25 acre per 100 ft of barrier.
- Maximum flow path to the barrier should be limited to 100 ft.
- Straw bale barriers should consist of two parallel rows.
 - Butt ends of bales tightly
 - Stagger butt joints between front and back row
 - Each row of bales must be trenched in and firmly staked
- Straw bale barriers are limited in height to one bale laid on its side.
- Anchor bales with either two wood stakes or four bars driven through the bale and into the soil. Drive the first stake towards the butt joint with the adjacent bale to force the bales together.
- See attached figure for installation details.

Materials

- **Straw Bale Size:** Each straw bale should be a minimum of 14 in. wide, 18 in. in height, 36 in. in length and should have a minimum mass of 50 lbs. The straw bale should be composed entirely of vegetative matter, except for the binding material.
- **Bale Bindings:** Bales should be bound by steel wire, nylon or polypropylene string placed horizontally. Jute and cotton binding should not be used. Baling wire should be a minimum diameter of 14 gauge. Nylon or polypropylene string should be approximately 12 gauge in diameter with a breaking strength of 80 lbs force.
- **Stakes:** Wood stakes should be commercial quality lumber of the size and shape shown on the plans. Each stake should be free from decay, splits or cracks longer than the thickness of the stake, or other defects that would weaken the stakes and cause the stakes to be structurally unsuitable. Steel bar reinforcement should be equal to a #4 designation or greater. End protection should be provided for any exposed bar reinforcement.

Costs

Straw bales cost \$5 - \$7 each. Adequate labor should be budgeted for installation and maintenance.

Inspection and Maintenance

Maintenance

- Inspect BMPs prior to forecast rain, daily during extended rain events, after rain events, weekly during the rainy season, and at two-week intervals during the non-rainy season.
- Straw bales degrade, especially when exposed to moisture. Rotting bales will need to be replaced on a regular basis.
- Replace or repair damaged bales as needed.
- Repair washouts or other damages as needed.
- Sediment that accumulates in the BMP must be periodically removed in order to maintain BMP effectiveness. Sediment should be removed when the sediment accumulation reaches one-third of the barrier height. Sediment removed during maintenance may be incorporated into earthwork on the site or disposed at an appropriate location.
- Remove straw bales when no longer needed. Remove sediment accumulation, and clean, re-grade, and stabilize the area. Removed sediment should be incorporated in the project or disposed of.

References

Stormwater Quality Handbooks - Construction Site Best Management Practices (BMPs) Manual, State of California Department of Transportation (Caltrans), November 2000.

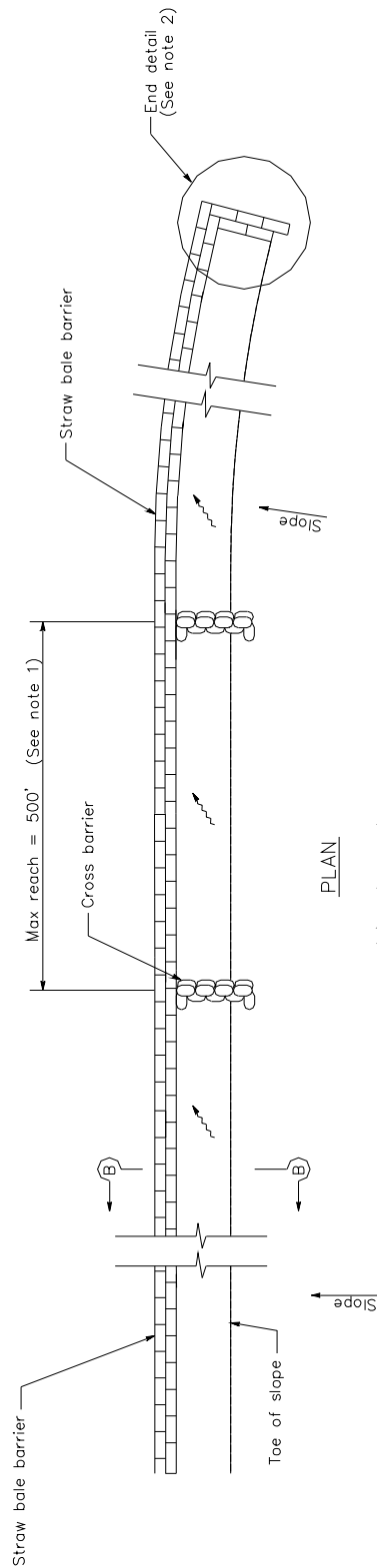

NOTES

1. Construct the length of each reach so that the change in base elevation along the reach does not exceed 1/2 the height of the linear barrier. In no case shall the reach length exceed 500'.
2. The end of barrier shall be turned up slope.
3. Dimension may vary to fit field condition.
4. Stake dimensions are nominal.
5. Place straw bales tightly together.
6. Tamp embedment spoils against sides of installed bales.
7. Drive angled wood stake before vertical stake to ensure tight abutment to adjacent bale.
8. Sandbag cross barriers should be a min of 1/2 and a max of 2/3 the height of the linear barrier.
9. Sandbag rows and layers should be offset to eliminate gaps.

LEGEND

DIRECTION OF FLOW



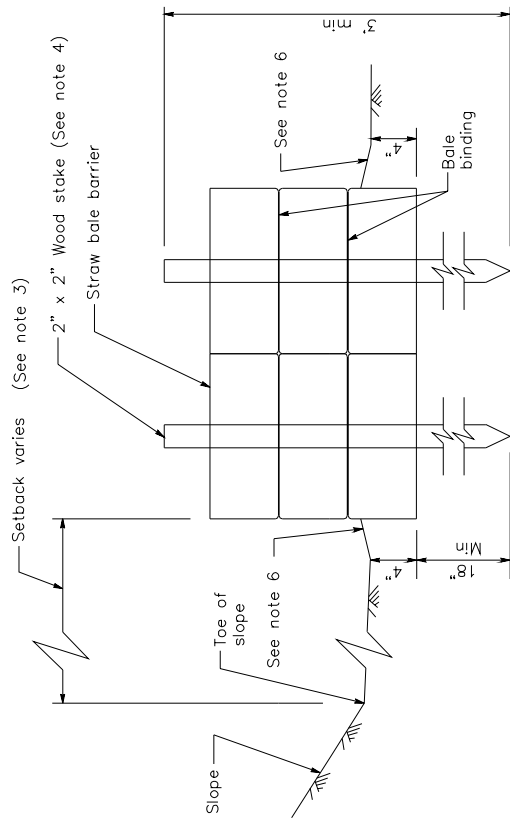

SECTION B-B

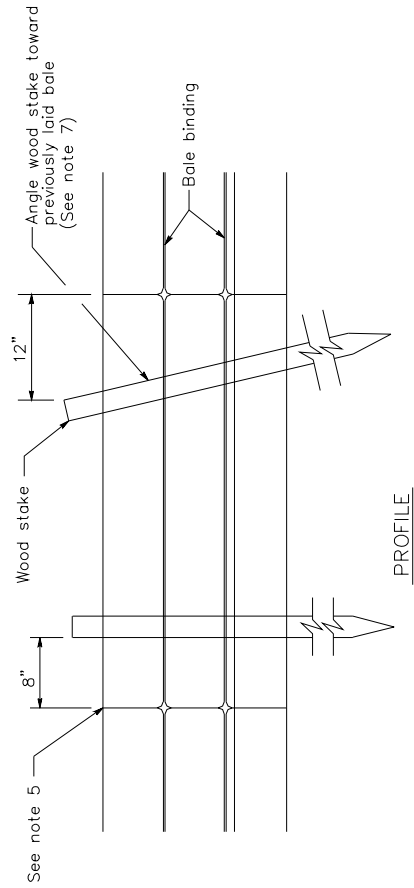

PROFILE

LEGEND
 DIRECTION OF FLOW

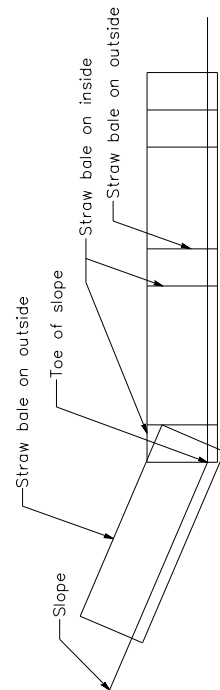

END DETAIL

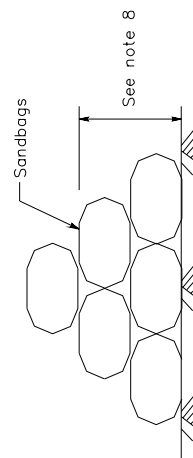

SANDBAG CROSS BARRIER

Wind Erosion [WE]

This page intentionally left blank.

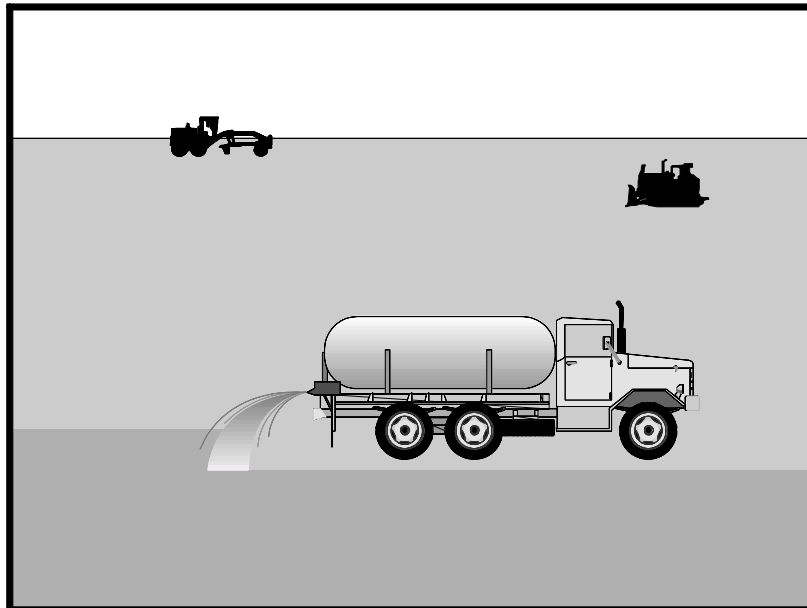

Description and Purpose

Wind erosion or dust control consists of applying water or other chemical dust suppressants as necessary to prevent or alleviate dust nuisance generated by construction activities. Covering small stockpiles or areas is an alternative to applying water or other dust palliatives.

California's Mediterranean climate, with a short "wet" season and a typically long, hot "dry" season, allows the soils to thoroughly dry out. During the dry season, construction activities are at their peak, and disturbed and exposed areas are increasingly subject to wind erosion, sediment tracking and dust generated by construction equipment. Site conditions and climate can make dust control more of an erosion problem than water based erosion. Additionally, many local agencies, including Air Quality Management Districts, require dust control and/or dust control permits in order to comply with local nuisance laws, opacity laws (visibility impairment) and the requirements of the Clean Air Act. Wind erosion control is required to be implemented at all construction sites greater than 1 acre by the General Permit.

Suitable Applications

Most BMPs that provide protection against water-based erosion will also protect against wind-based erosion and dust control requirements required by other agencies will generally meet wind erosion control requirements for water quality protection. Wind erosion control BMPs are suitable during the following construction activities:

Categories

EC	Erosion Control	
SE	Sediment Control	<input checked="" type="checkbox"/>
TC	Tracking Control	
WE	Wind Erosion Control	<input checked="" type="checkbox"/>
NS	Non-Stormwater Management Control	
WM	Waste Management and Materials Pollution Control	

Legend:

- Primary Category
- Secondary Category

Targeted Constituents

Sediment	<input checked="" type="checkbox"/>
Nutrients	
Trash	
Metals	
Bacteria	
Oil and Grease	
Organics	

Potential Alternatives

EC-5 Soil Binders



- Construction vehicle traffic on unpaved roads
- Drilling and blasting activities
- Soils and debris storage piles
- Batch drop from front-end loaders
- Areas with unstabilized soil
- Final grading/site stabilization

Limitations

- Watering prevents dust only for a short period (generally less than a few hours) and should be applied daily (or more often) to be effective.
- Over watering may cause erosion and track-out.
- Oil or oil-treated subgrade should not be used for dust control because the oil may migrate into drainageways and/or seep into the soil.
- Chemical dust suppression agents may have potential environmental impacts. Selected chemical dust control agents should be environmentally benign.
- Effectiveness of controls depends on soil, temperature, humidity, wind velocity and traffic.
- Chemical dust suppression agents should not be used within 100 feet of wetlands or water bodies.
- Chemically treated subgrades may make the soil water repellent, interfering with long-term infiltration and the vegetation/re-vegetation of the site. Some chemical dust suppressants may be subject to freezing and may contain solvents and should be handled properly.
- In compacted areas, watering and other liquid dust control measures may wash sediment or other constituents into the drainage system.
- If the soil surface has minimal natural moisture, the affected area may need to be pre-wetted so that chemical dust control agents can uniformly penetrate the soil surface.

Implementation

Dust Control Practices

Dust control BMPs generally stabilize exposed surfaces and minimize activities that suspend or track dust particles. The following table presents dust control practices that can be applied to varying site conditions that could potentially cause dust. For heavily traveled and disturbed areas, wet suppression (watering), chemical dust suppression, gravel asphalt surfacing, temporary gravel construction entrances, equipment wash-out areas, and haul truck covers can be employed as dust control applications. Permanent or temporary vegetation and mulching can be employed for areas of occasional or no construction traffic. Preventive measures include minimizing surface areas to be disturbed, limiting onsite vehicle traffic to 15 mph or less, and controlling the number and activity of vehicles on a site at any given time.

Chemical dust suppressants include: mulch and fiber based dust palliatives (e.g. paper mulch with gypsum binder), salts and brines (e.g. calcium chloride, magnesium chloride), non-petroleum based organics (e.g. vegetable oil, lignosulfonate), petroleum based organics (e.g. asphalt emulsion, dust oils, petroleum resins), synthetic polymers (e.g. polyvinyl acetate, vinyls, acrylic), clay additives (e.g. bentonite, montmorillonite) and electrochemical products (e.g. enzymes, ionic products).

Site Condition	Dust Control Practices							
	Permanent Vegetation	Mulching	Wet Suppression (Watering)	Chemical Dust Suppression	Gravel or Asphalt	Temporary Gravel Construction Entrances/Equipment Wash Down	Synthetic Covers	Minimize Extent of Disturbed Area
Disturbed Areas not Subject to Traffic	X	X	X	X	X			X
Disturbed Areas Subject to Traffic			X	X	X	X		X
Material Stockpiles		X	X	X			X	X
Demolition			X			X	X	
Clearing/Excavation			X	X				X
Truck Traffic on Unpaved Roads			X	X	X	X	X	
Tracking					X	X		

Additional preventive measures include:

- Schedule construction activities to minimize exposed area (see EC-1, Scheduling).
- Quickly treat exposed soils using water, mulching, chemical dust suppressants, or stone/gravel layering.
- Identify and stabilize key access points prior to commencement of construction.
- Minimize the impact of dust by anticipating the direction of prevailing winds.
- Restrict construction traffic to stabilized roadways within the project site, as practicable.
- Water should be applied by means of pressure-type distributors or pipelines equipped with a spray system or hoses and nozzles that will ensure even distribution.
- All distribution equipment should be equipped with a positive means of shutoff.
- Unless water is applied by means of pipelines, at least one mobile unit should be available at all times to apply water or dust palliative to the project.
- If reclaimed waste water is used, the sources and discharge must meet California Department of Health Services water reclamation criteria and the Regional Water Quality

Control Board (RWQCB) requirements. Non-potable water should not be conveyed in tanks or drain pipes that will be used to convey potable water and there should be no connection between potable and non-potable supplies. Non-potable tanks, pipes, and other conveyances should be marked, "NON-POTABLE WATER - DO NOT DRINK."

- Pave or chemically stabilize access points where unpaved traffic surfaces adjoin paved roads.
- Provide covers for haul trucks transporting materials that contribute to dust.
- Provide for rapid clean up of sediments deposited on paved roads. Furnish stabilized construction road entrances and wheel wash areas.
- Stabilize inactive areas of construction sites using temporary vegetation or chemical stabilization methods.

For chemical stabilization, there are many products available for chemically stabilizing gravel roadways and stockpiles. If chemical stabilization is used, the chemicals should not create any adverse effects on stormwater, plant life, or groundwater and should meet all applicable regulatory requirements.

Costs

Installation costs for water and chemical dust suppression vary based on the method used and the length of effectiveness. Annual costs may be high since some of these measures are effective for only a few hours to a few days.

Inspection and Maintenance

- Inspect and verify that activity-based BMPs are in place prior to the commencement of associated activities.
- BMPs must be inspected in accordance with General Permit requirements for the associated project type and risk level. It is recommended that at a minimum, BMPs be inspected weekly, prior to forecasted rain events, daily during extended rain events, and after the conclusion of rain events.
- Check areas protected to ensure coverage.
- Most water-based dust control measures require frequent application, often daily or even multiple times per day. Obtain vendor or independent information on longevity of chemical dust suppressants.

References

Best Management Practices and Erosion Control Manual for Construction Sites, Flood Control District of Maricopa County, Arizona, September 1992.

California Air Pollution Control Laws, California Air Resources Board, updated annually.

Construction Manual, Chapter 4, Section 10, "Dust Control"; Section 17, "Watering"; and Section 18, "Dust Palliative", California Department of Transportation (Caltrans), July 2001.

Prospects for Attaining the State Ambient Air Quality Standards for Suspended Particulate Matter (PM10), Visibility Reducing Particles, Sulfates, Lead, and Hydrogen Sulfide, California Air Resources Board, April 1991.

Stormwater Quality Handbooks Construction Site Best Management Practices (BMPs) Manual, State of California Department of Transportation (Caltrans), March 2003.

This page intentionally left blank

Non-Stormwater Management [NS]

This page intentionally left blank.

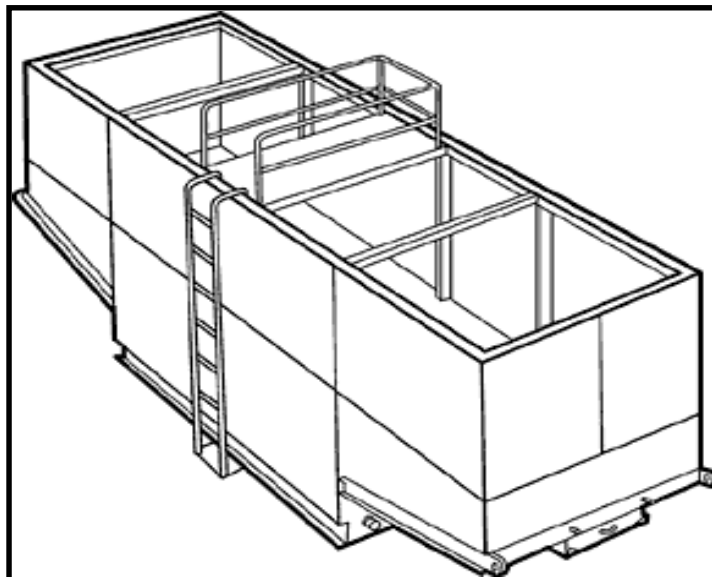

Description and Purpose

Dewatering operations are practices that manage the discharge of pollutants when non-stormwater and accumulated precipitation (stormwater) must be removed from a work location to proceed with construction work or to provide vector control.

The General Permit incorporates Numeric Effluent Limits (NEL) and Numeric Action Levels (NAL) for turbidity (see Section 2 of this handbook to determine your project's risk level and if you are subject to these requirements).

Discharges from dewatering operations can contain high levels of fine sediment that, if not properly treated, could lead to exceedences of the General Permit requirements.

Suitable Applications

These practices are implemented for discharges of non-stormwater from construction sites. Non-stormwaters include, but are not limited to, groundwater, water from cofferdams, water diversions, and waters used during construction activities that must be removed from a work area to facilitate construction.

Practices identified in this section are also appropriate for implementation when managing the removal of accumulated precipitation (stormwater) from depressed areas at a construction site.

Stormwater mixed with non-stormwater should be managed as non-stormwater.

Categories

EC	Erosion Control	
SE	Sediment Control	<input checked="" type="checkbox"/>
TC	Tracking Control	
WE	Wind Erosion Control	
NS	Non-Stormwater Management Control	<input checked="" type="checkbox"/>
WM	Waste Management and Materials Pollution Control	

Legend:

- Primary Category
- Secondary Category

Targeted Constituents

Sediment	<input checked="" type="checkbox"/>
Nutrients	
Trash	
Metals	
Bacteria	
Oil and Grease	<input checked="" type="checkbox"/>
Organics	

Potential Alternatives

- SE-5: Fiber Roll
- SE-6: Gravel Bag Berm



Limitations

- Dewatering operations will require, and should comply with applicable local and project-specific permits and regulations. In some areas, all dewatering activities, regardless of the discharge volume, require a dewatering permit.
- Site conditions will dictate design and use of dewatering operations.
- The controls discussed in this fact sheet primarily address sediment. Other secondary pollutant removal benefits are discussed where applicable.
- The controls detailed in this fact sheet only allow for minimal settling time for sediment particles. Use only when site conditions restrict the use of the other control methods.
- Avoid dewatering discharges where possible by using the water for dust control.

Implementation

- A Construction Site Monitoring Plan (CSMP) should be included in the project Stormwater Pollution Prevention Plan (SWPPP).
- Regional Water Quality Control Board (RWQCB) Regions may require notification and approval prior to any discharge of water from construction sites.
- The destination of discharge from dewatering activities will typically determine the type of permit required by the discharger. For example, when discharging to a water of the U.S., a groundwater extraction permit will be required through the site's governing RWQCB. When discharging to a sanitary sewer or Municipal Separate Storm Sewer System (MS4), a permit may need to be obtained through the owner of the sanitary sewer or MS4 in addition to obtaining an RWQCB dewatering permit. Additional permits or permissions from other agencies may be required for dewatering cofferdams or diversions.
- Dewatering discharges should not cause erosion at the discharge point. Appropriate BMPs should be implemented to maintain compliance with all applicable permits.
- Maintain dewatering records in accordance with all local and project-specific permits and regulations.

Sediment Treatment

A variety of methods can be used to treat water during dewatering operations. Several devices are presented below and provide options to achieve sediment removal. The sediment particle size and permit or receiving water limitations on sediment are key considerations for selecting sediment treatment option(s); in some cases, the use of multiple devices may be appropriate. Use of other enhanced treatment methods (i.e., introduction of chemicals or electric current to enhance flocculation and removal of sediment) must comply with: 1) for storm drain or surface water discharges, the requirements for Active Treatment Systems (SE-11); or 2) for sanitary sewer discharges, the requirements of applicable sanitary sewer discharge permits.

Sediment Basin (see also SE-2)

Description:

- A sediment basin is a temporary basin with a controlled release structure that is formed by excavation or construction of an embankment to detain sediment-laden runoff and allow sediment to settle out before discharging. Sediment basins are generally larger than Sediment Traps (SE-3) and have a designed outlet structure.

Appropriate Applications:

- Effective for the removal of trash, gravel, sand, silt, some metals that settle out with the sediment.

Implementation:

- Excavation and construction of related facilities is required.
- Temporary sediment basins should be fenced if safety is a concern.
- Outlet protection is required to prevent erosion at the outfall location.

Maintenance:

- Maintenance is required for safety fencing, vegetation, embankment, inlet and outlet, as well as other features.
- Removal of sediment is required when the storage volume is reduced by one-third.

Sediment Trap (See also SE-3)

Description:

- A sediment trap is a temporary basin formed by excavation and/or construction of an earthen embankment across a waterway or low drainage area to detain sediment-laden runoff and allow sediment to settle out before discharging. Sediment traps are generally smaller than Sediment Basins (SE-2) and do not have a designed outlet (but do have a spillway or overflow).

Appropriate Applications:

Effective for the removal of large and medium sized particles (sand and gravel) and some metals that settle out with the sediment.

Implementation:

- Excavation and construction of related facilities is required.
- Trap inlets should be located to maximize the travel distance to the trap outlet.
- Use rock or vegetation to protect the trap outlets against erosion.

Maintenance:

- Maintenance is required for vegetation, embankment, inlet and outfall structures, as well as other features.
- Removal of sediment is required when the storage volume is reduced by one-third.

Weir Tanks

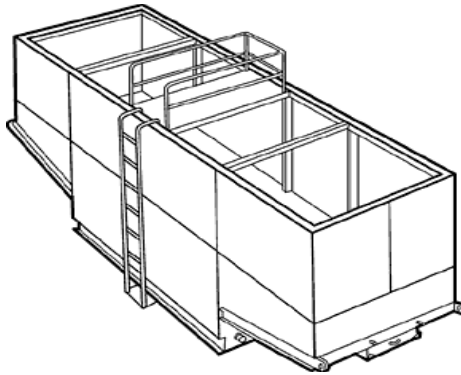

Description:

- A weir tank separates water and waste by using weirs. The configuration of the weirs (over and under weirs) maximizes the residence time in the tank and determines the waste to be removed from the water, such as oil, grease, and sediments.

Appropriate Applications:

- The tank removes trash, some settleable solids (gravel, sand, and silt), some visible oil and grease, and some metals (removed with sediment). To achieve high levels of flow, multiple tanks can be used in parallel. If additional treatment is desired, the tanks can be placed in series or as pre-treatment for other methods.

Implementation:

- Tanks are delivered to the site by the vendor, who can provide assistance with set-up and operation.
- Tank size will depend on flow volume, constituents of concern, and residency period required. Vendors should be consulted to appropriately size tank.
- Treatment capacity (i.e., volume and number of tanks) should provide at a minimum the required volume for discrete particle settling for treatment design flows.

Maintenance:

- Periodic cleaning is required based on visual inspection or reduced flow.
- Oil and grease disposal should be conducted by a licensed waste disposal company.

Dewatering Tanks



Description:

- A dewatering tank removes debris and sediment. Flow enters the tank through the top, passes through a fabric filter, and is discharged through the bottom of the tank. The filter separates the solids from the liquids.

Appropriate Applications:

- The tank removes trash, gravel, sand, and silt, some visible oil and grease, and some metals (removed with sediment). To achieve high levels of flow, multiple tanks can be used in parallel. If additional treatment is desired, the tanks can be placed in series or as pre-treatment for other methods.

Implementation:

- Tanks are delivered to the site by the vendor, who can provide assistance with set-up and operation.
- Tank size will depend on flow volume, constituents of concern, and residency period required. Vendors should be consulted to appropriately size tank.

Maintenance:

- Periodic cleaning is required based on visual inspection or reduced flow.
- Oil and grease disposal should be conducted by licensed waste disposal company.

Gravity Bag Filter

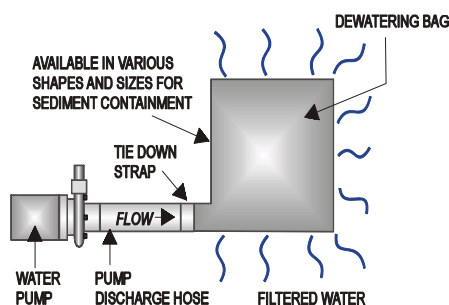

Description:

- A gravity bag filter, also referred to as a dewatering bag, is a square or rectangular bag made of non-woven geotextile fabric that collects gravel, sand, silt, and fines.

Appropriate Applications:

- Effective for the removal of sediments (gravel, sand, silt, and fines). Some metals are removed with the sediment.

Implementation:

- Water is pumped into one side of the bag and seeps through the top, bottom, and sides of the bag.
- Place filter bag on pavement or a gravel bed or paved surface. Avoid placing a dewatering bag on unprotected bare soil. If placing the bag on bare soil is unavoidable, a secondary barrier should be used, such as a rock filter bed placed beneath and beyond the edges of the bag to, prevent erosion and capture sediments that escape the bag.
- Perimeter control around the downstream end of the bag should be implemented. Secondary sediment controls are important especially in the initial stages of discharge, which tend to allow fines to pass through the bag.

Maintenance:

- Inspection of the flow conditions, bag condition, bag capacity, and the secondary barrier (as applicable) is required.
- Replace the bag when it no longer filters sediment or passes water at a reasonable rate.
- Caution should be taken when removing and disposing of the bag, to prevent the release of captured sediment
- Properly dispose of the bag offsite. If sediment is removed from the bag prior to disposal (bags can potentially be reused depending upon their condition), dispose of sediment in accordance with the general maintenance procedures described at the end of this BMP Fact Sheet.

Sand Media Particulate Filter



Description:

- Water is treated by passing it through canisters filled with sand media. Generally, sand filters provide a final level of treatment. They are often used as a secondary or higher level of treatment after a significant amount of sediment and other pollutants have been removed using other methods.

Appropriate Applications:

- Effective for the removal of trash, gravel, sand, and silt and some metals, as well as the reduction of biochemical oxygen demand (BOD) and turbidity.
- Sand filters can be used for stand-alone treatment or in conjunction with bag and cartridge filtration if further treatment is required.
- Sand filters can also be used to provide additional treatment to water treated via settling or basic filtration.

Implementation:

- The filters require delivery to the site and initial set up. The vendor can provide assistance with installation and operation.

Maintenance:

- The filters require regular service to monitor and maintain the level of the sand media. If subjected to high loading rates, filters can plug quickly.
- Venders generally provide data on maximum head loss through the filter. The filter should be monitored daily while in use, and cleaned when head loss reaches target levels.
- If cleaned by backwashing, the backwash water may need to be hauled away for disposal, or returned to the upper end of the treatment train for another pass through the series of dewatering BMPs.

Pressurized Bag Filter



Description:

- A pressurized bag filter is a unit composed of single filter bags made from polyester felt material. The water filters through the unit and is discharged through a header. Vendors provide bag filters in a variety of configurations. Some units include a combination of bag filters and cartridge filters for enhanced contaminant removal.

Appropriate Applications:

- Effective for the removal of sediment (sand and silt) and some metals, as well as the reduction of BOD, turbidity, and hydrocarbons. Oil absorbent bags are available for hydrocarbon removal.
- Filters can be used to provide secondary treatment to water treated via settling or basic filtration.

Implementation:

- The filters require delivery to the site and initial set up. The vendor can provide assistance with installation and operation.

Maintenance:

- The filter bags require replacement when the pressure differential equals or exceeds the manufacturer's recommendation.

Cartridge Filter



Description:

- Cartridge filters provide a high degree of pollutant removal by utilizing a number of individual cartridges as part of a larger filtering unit. They are often used as a secondary or higher (polishing) level of treatment after a significant amount of sediment and other pollutants are removed. Units come with various cartridge configurations (for use in series with bag filters) or with a larger single cartridge filtration unit (with multiple filters within).

Appropriate Applications:

- Effective for the removal of sediment (sand, silt, and some clays) and metals, as well as the reduction of BOD, turbidity, and hydrocarbons. Hydrocarbons can effectively be removed with special resin cartridges.
- Filters can be used to provide secondary treatment to water treated via settling or basic filtration.

Implementation:

- The filters require delivery to the site and initial set up. The vendor can provide assistance.

Maintenance:

- The cartridges require replacement when the pressure differential equals or exceeds the manufacturer's recommendation.

Costs

- Sediment control costs vary considerably depending on the dewatering and sediment treatment system that is selected. Pressurized filters tend to be more expensive than gravity settling, but are often more effective. Simple tanks are generally rented on a long-term basis (one or more months) and can range from \$360 per month for a 1,000 gallon tank to \$2,660 per month for a 10,000 gallon tank. Mobilization and demobilization costs vary considerably.

Inspection and Maintenance

- Inspect and verify that dewatering BMPs are in place and functioning prior to the commencement of activities requiring dewatering.
- Inspect dewatering BMPs daily while dewatering activities are being conducted.

- Inspect all equipment before use. Monitor dewatering operations to ensure they do not cause offsite discharge or erosion.
- Sample dewatering discharges as required by the General Permit.
- Unit-specific maintenance requirements are included with the description of each unit.
- Sediment removed during the maintenance of a dewatering device may be either spread onsite and stabilized, or disposed of at a disposal site as approved by the owner.
- Sediment that is commingled with other pollutants should be disposed of in accordance with all applicable laws and regulations and as approved by the owner.

References

Blueprint for a Clean Bay: Best Management Practices to Prevent Stormwater Pollution from Construction Related Activities; Santa Clara Valley Nonpoint Source Pollution Control Program, 1995.

Stormwater Quality Handbooks - Construction Site Best Management Practices (BMPs) Manual, State of California Department of Transportation (Caltrans), March 2003; Updated March 2004.

Stormwater Management for Construction Activities, Developing Pollution Prevention Plans and Best Management Practices, EPA 832-R-92005; USEPA, April 1992.

Labor Surcharge & Equipment Rental Rates, April 1, 2002 through March 31, 2003, California Department of Transportation (Caltrans).

Erosion and Sediment Control Manual, Oregon Department of Environmental Quality, February 2005.

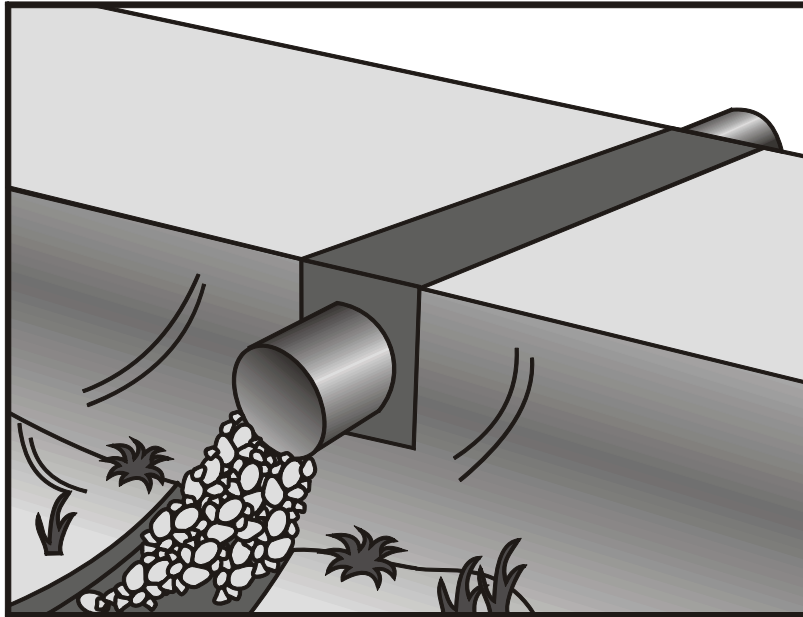

Description and Purpose

A temporary stream crossing is a temporary culvert, ford or bridge placed across a waterway to provide access for construction purposes for a period of less than one year. Temporary access crossings are not intended to maintain traffic for the public. The temporary access will eliminate erosion and downstream sedimentation caused by vehicles.

Suitable Applications

Temporary stream crossings should be installed at all designated crossings of perennial and intermittent streams on the construction site, as well as for dry channels that may be significantly eroded by construction traffic.

Temporary streams crossings are installed at sites:

- Where appropriate permits have been secured (404 Permits, and 401 Certifications)
- Where construction equipment or vehicles need to frequently cross a waterway
- When alternate access routes impose significant constraints
- When crossing perennial streams or waterways causes significant erosion
- Where construction activities will not last longer than one year
- Where appropriate permits have been obtained for the

Categories

EC	Erosion Control	<input checked="" type="checkbox"/>
SE	Sediment Control	<input checked="" type="checkbox"/>
TC	Tracking Control	<input checked="" type="checkbox"/>
WE	Wind Erosion Control	
NS	Non-Stormwater Management Control	<input checked="" type="checkbox"/>
WM	Waste Management and Materials Pollution Control	

Legend:

- Primary Objective**
- Secondary Objective**

Targeted Constituents

Sediment	<input checked="" type="checkbox"/>
Nutrients	
Trash	
Metals	
Bacteria	
Oil and Grease	
Organics	

Potential Alternatives

None



stream crossing

Limitations

The following limitations may apply:

- Installation and removal will usually disturb the waterway.
- Installation may require Regional Water Quality Control Board (RWQCB) 401 Certification, U.S. Army Corps of Engineers 404 permit and approval by California Department of Fish and Game. If numerical-based water quality standards are mentioned in any of these and other related permits, testing and sampling may be required.
- Installation may require dewatering or temporary diversion of the stream. See NS-2, Dewatering Operations and NS-5, Clear Water Diversion.
- Installation may cause a constriction in the waterway, which can obstruct flood flow and cause flow backups or washouts. If improperly designed, flow backups can increase the pollutant load through washouts and scouring.
- Use of natural or other gravel in the stream for construction of Cellular Confinement System (CCS) ford crossing will be contingent upon approval by fisheries agencies.
- Ford crossings may degrade water quality due to contact with vehicles and equipment.
- May be expensive for a temporary improvement.
- Requires other BMPs to minimize soil disturbance during installation and removal.
- Fords should only be used in dry weather.

Implementation

General

The purpose of this BMP is to provide a safe, erosion-free access across a stream for construction equipment. Minimum standards and specifications for the design, construction, maintenance, and removal of the structure should be established by an engineer registered in California. Temporary stream crossings may be necessary to prevent construction equipment from causing erosion of the stream and tracking sediment and other pollutants into the stream.

Temporary stream crossings are used as access points to construction sites when other detour routes may be too long or burdensome for the construction equipment. Often heavy construction equipment must cross streams or creeks, and detour routes may impose too many constraints such as being too narrow or poor soil strength for the equipment loadings. Additionally, the contractor may find a temporary stream crossing more economical for light-duty vehicles to use for frequent crossings, and may have less environmental impact than construction of a temporary access road.

Location of the temporary stream crossing should address:

- Site selection where erosion potential is low.

- Areas where the side slopes from site runoff will not spill into the side slopes of the crossing.

The following types of temporary stream crossings should be considered:

- **Culverts** – A temporary culvert is effective in controlling erosion but will cause erosion during installation and removal. A temporary culvert can be easily constructed and allows for heavy equipment loads.
- **Fords** - Appropriate during the dry season in arid areas. Used on dry washes and ephemeral streams, and low-flow perennial streams. CCS, a type of ford crossing, is also appropriate for use in streams that would benefit from an influx of gravels. A temporary ford provides little sediment and erosion control and is ineffective in controlling erosion in the stream channel. A temporary ford is the least expensive stream crossing and allows for maximum load limits. It also offers very low maintenance. Fords are more appropriate during the dry ice season and in arid areas of California.
- **Bridges** - Appropriate for streams with high flow velocities, steep gradients and where temporary restrictions in the channel are not allowed.

Design

During the long summer construction season in much of California, rainfall is infrequent and many streams are dry. Under these conditions, a temporary ford may be sufficient. A ford is not appropriate if construction will continue through the winter rainy season, if summer thunderstorms are likely, or if the stream flows during most of the year. Temporary culverts and bridges should then be considered and, if used, should be sized to pass a significant design storm (i.e., at least a 10-year storm). The temporary stream crossing should be protected against erosion, both to prevent excessive sedimentation in the stream and to prevent washout of the crossing.

Design and installation requires knowledge of stream flows and soil strength. Designs should be prepared under direction of, and approved by, a registered civil engineer and for bridges, a registered structural engineer. Both hydraulic and construction loading requirements should be considered with the following:

- Comply with any special requirements for culvert and bridge crossings, particularly if the temporary stream crossing will remain through the rainy season.
- Provide stability in the crossing and adjacent areas to withstand the design flow. The design flow and safety factor should be selected based on careful evaluation of the risks due to over topping, flow backups, or washout.
- Install sediment traps immediately downstream of crossings to capture sediments. See SE-3, Sediment Trap.
- Avoid oil or other potentially hazardous materials for surface treatment.
- Culverts are relatively easy to construct and able to support heavy equipment loads.
- Fords are the least expensive of the crossings, with maximum load limits.

- CCS crossing structures consist of clean, washed gravel and cellular confinement system blocks. CCS are appropriate for streams that would benefit from an influx of gravel; for example, salmonid streams, streams or rivers below reservoirs, and urban, channelized streams. Many urban stream systems are gravel-deprived due to human influences, such as dams, gravel mines, and concrete channels.
- CCS allow designers to use either angular or naturally occurring rounded gravel, because the cells provide the necessary structure and stability. In fact, natural gravel is optimal for this technique, because of the habitat improvement it will provide after removal of the CCS.
- A gravel depth of 6 to 12 in. for a CCS structure is sufficient to support most construction equipment.
- An advantage of a CCS crossing structure is that relatively little rock or gravel is needed, because the CCS provides the stability.
- Bridges are generally more expensive to design and construct, but provide the least disturbance of the streambed and constriction of the waterway flows.

Construction and Use

- Stabilize construction roadways, adjacent work area, and stream bottom against erosion.
- Construct during dry periods to minimize stream disturbance and reduce costs.
- Construct at or near the natural elevation of the streambed to prevent potential flooding upstream of the crossing.
- Install temporary erosion control BMPs in accordance with erosion control BMP fact sheets to minimize erosion of embankment into flow lines.
- Any temporary artificial obstruction placed within flowing water should only be built from material, such as clean gravel or sandbags, that will not introduce sediment or silt into the watercourse.
- Temporary water body crossings and encroachments should be constructed to minimize scour. Cobbles used for temporary water body crossings or encroachments should be clean, rounded river cobble.
- Vehicles and equipment should not be driven, operated, fueled, cleaned, maintained, or stored in the wet or dry portions of a water body where wetland vegetation, riparian vegetation, or aquatic organisms may be destroyed.
- The exterior of vehicles and equipment that will encroach on the water body within the project should be maintained free of grease, oil, fuel, and residues.
- Drip pans should be placed under all vehicles and equipment placed on docks, barges, or other structures over water bodies when the vehicle or equipment is planned to be idle for more than one hour.

- Disturbance or removal of vegetation should not exceed the minimum necessary to complete operations. Precautions should be taken to avoid damage to vegetation by people or equipment. Disturbed vegetation should be replaced with the appropriate soil stabilization measures.
- Riparian vegetation, when removed pursuant to the provisions of the work, should be cut off no lower than ground level to promote rapid re-growth. Access roads and work areas built over riparian vegetation should be covered by a sufficient layer of clean river run cobble to prevent damage to the underlying soil and root structure. The cobble must be removed upon completion of project activities.
- Conceptual temporary stream crossings are shown in the attached figures.

Costs

Caltrans Construction Cost index for temporary bridge crossings is \$45-\$95/ft².

Inspection and Maintenance

- Inspect and verify that activity-based BMPs are in place prior to the commencement of associated activities. While activities associated with the BMP are under way, inspect weekly during the rainy season and at two week intervals in the non-rainy season to verify continued BMP implementation.
- Check for blockage in the channel, sediment buildup or trapped debris in culverts, blockage behind fords or under bridges
- Check for erosion of abutments, channel scour, riprap displacement, or piping in the soil
- Check for structural weakening of the temporary crossings, such as cracks, and undermining of foundations and abutments
- Remove sediment that collects behind fords, in culverts, and under bridges periodically
- Replace lost or displaced aggregate from inlets and outlets of culverts and cellular confinement systems
- Remove temporary crossing promptly when it is no longer needed

References

California Bank and Shore Rock Slope Protection Design – Practitioners Guide and Field Evaluations of Riprap Methods, Caltrans Study No. F90TL03, October 2000.

Stormwater Quality Handbooks - Construction Site Best Management Practices (BMPs) Manual, State of California Department of Transportation (Caltrans), November 2000.

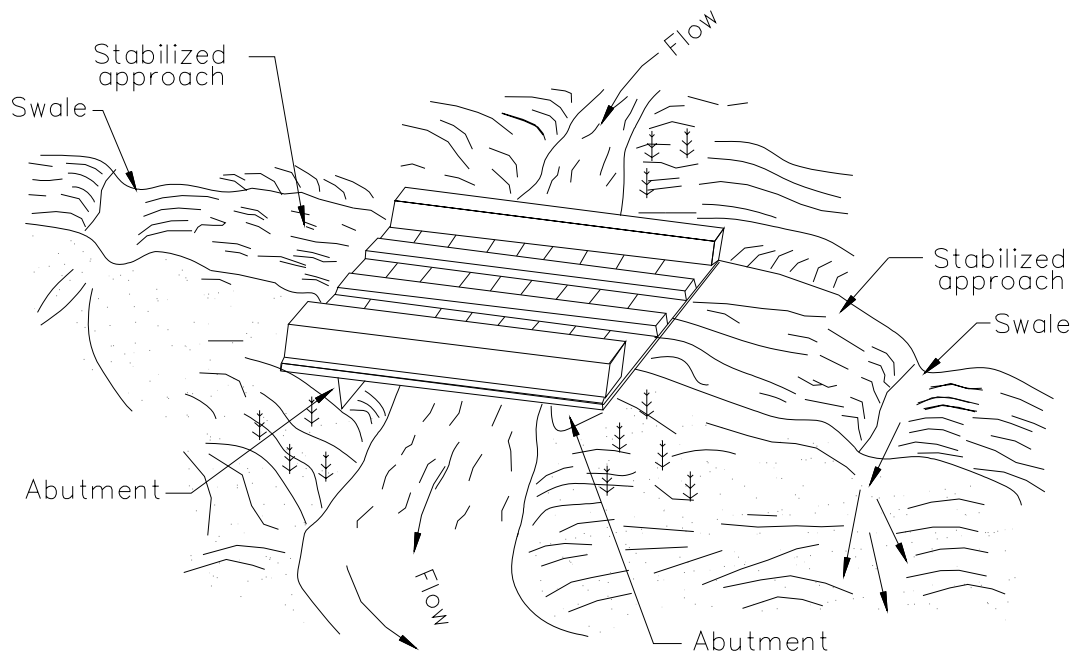

NOTE:
Surface flow of road diverted
by swale and/or dike.

TYPICAL BRIDGE CROSSING NOT TO SCALE

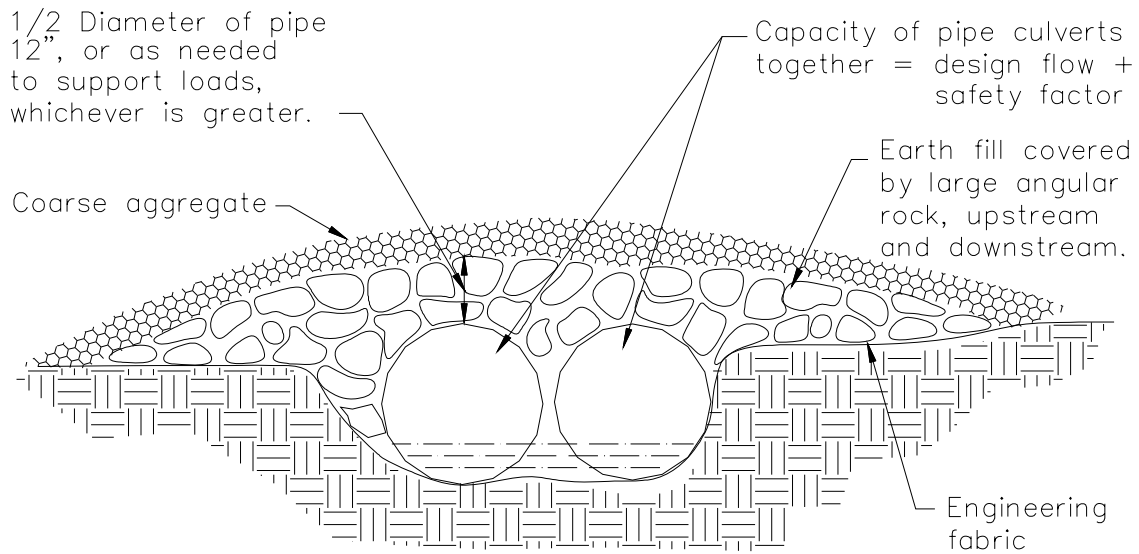

ELEVATION

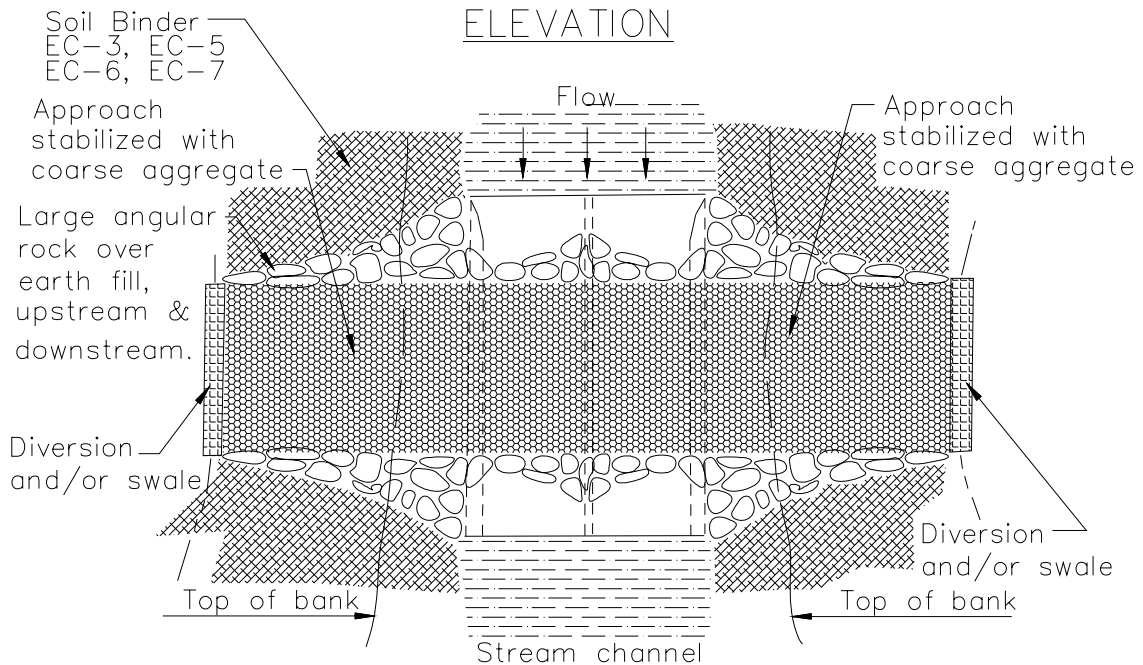

PLAN VIEW

TYPICAL CULVERT CROSSING
NOT TO SCALE

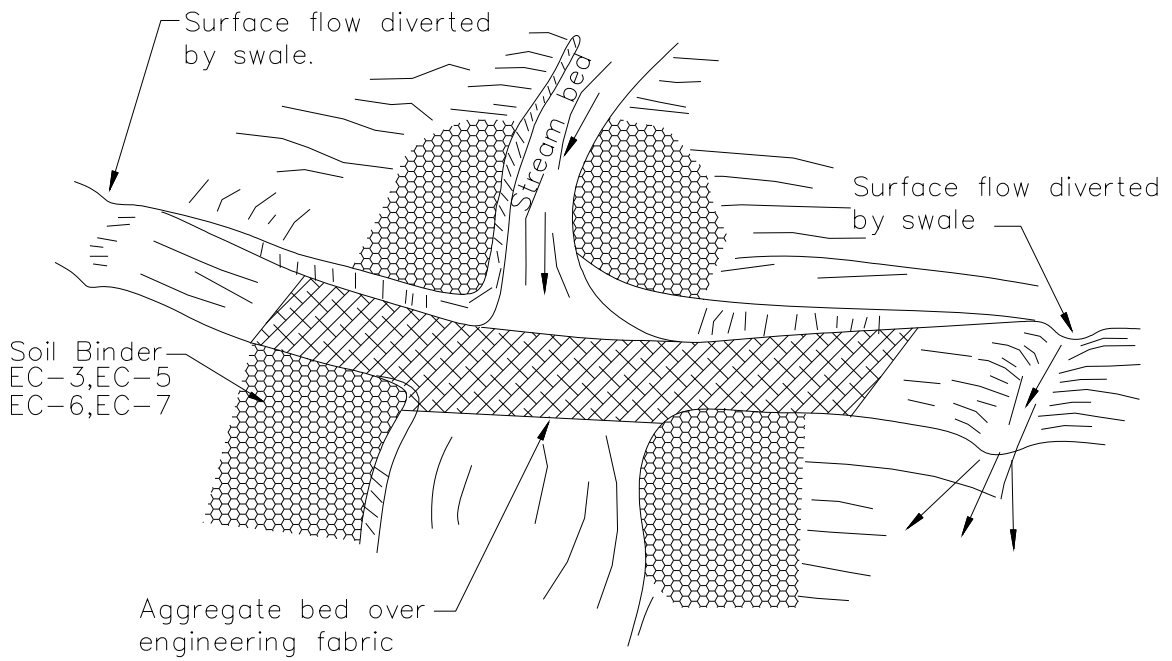

Aggregate approach
1:5 (V:H) Maximum slope on road

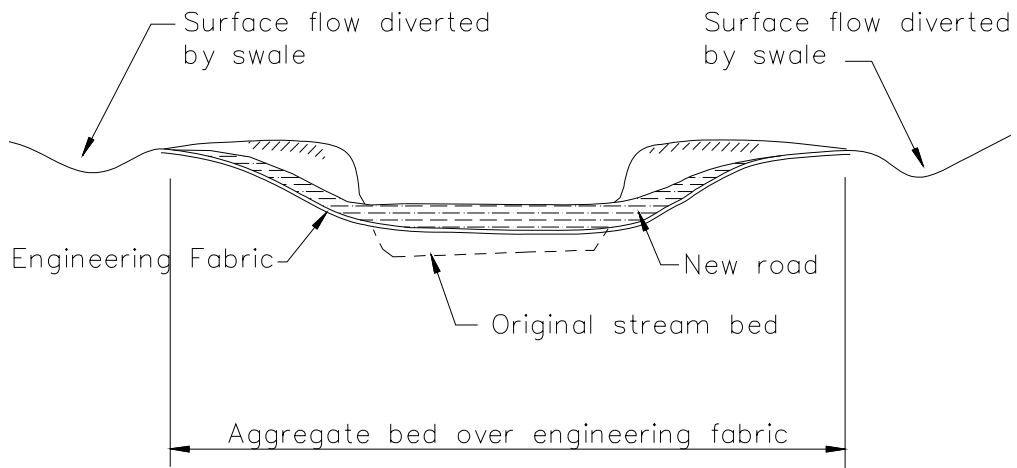

TYPICAL FORD CROSSING
NOT TO SCALE

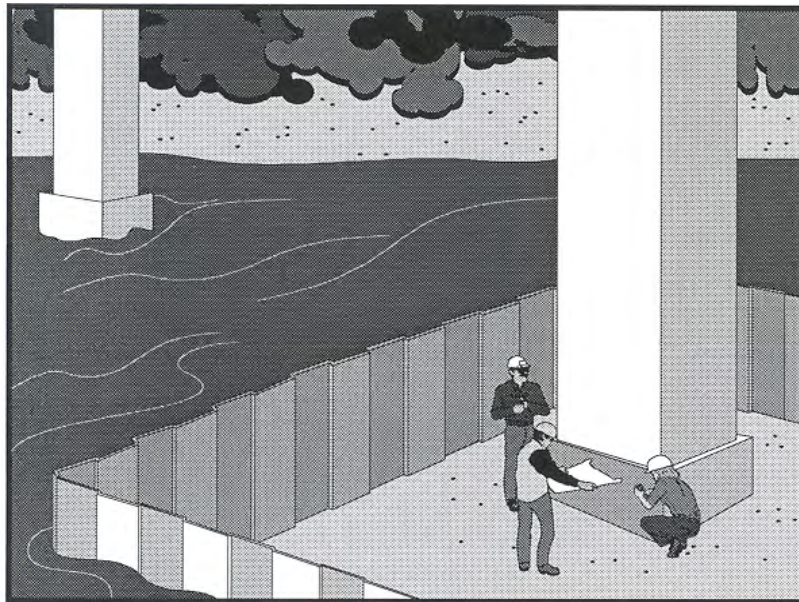

Description and Purpose

Clear water diversion consists of a system of structures and measures that intercept clear surface water runoff upstream of a project, transport it around the work area, and discharge it downstream with minimal water quality degradation from either the project construction operations or the construction of the diversion. Clear water diversions are used in a waterway to enclose a construction area and reduce sediment pollution from construction work occurring in or adjacent to water. Structures commonly used as part of this system include diversion ditches, berms, dikes, slope drains, rock, gravel bags, wood, aqua barriers, cofferdams, filter fabric or turbidity curtains, drainage and interceptor swales, pipes, or flumes.

Suitable Applications

A clear water diversion is typically implemented where appropriate permits (1601 Agreement) have been secured and work must be performed in a flowing stream or water body.

- Clear water diversions are appropriate for isolating construction activities occurring within or near a water body such as streambank stabilization, or culvert, bridge, pier or abutment installation. They may also be used in combination with other methods, such as clear water bypasses and/or pumps.
- Pumped diversions are suitable for intermittent and low flow streams.
- Excavation of a temporary bypass channel, or passing the

Categories

EC	Erosion Control	
SE	Sediment Control	
TC	Tracking Control	
WE	Wind Erosion Control	
NS	Non-Stormwater Management Control	<input checked="" type="checkbox"/>
WM	Waste Management and Materials Pollution Control	

Legend:

- Primary Objective**
- Secondary Objective**

Targeted Constituents

Sediment	<input checked="" type="checkbox"/>
Nutrients	
Trash	
Metals	
Bacteria	
Oil and Grease	
Organics	

Potential Alternatives

None



flow through a heavy pipe (called a “flume”) with a trench excavated under it, is appropriate for the diversion of streams less than 20 ft wide, with flow rates less than 100 cfs.

- Clear water diversions incorporating clean washed gravel may be appropriate for use in salmonid spawning streams.

Limitations

- Diversion and encroachment activities will usually disturb the waterway during installation and removal of diversion structures.
- Installation may require Regional Water Quality Control Board (RWQCB) 401 Certification, U.S. Army Corps of Engineers 404 permit and approval by California Department of Fish and Game. If numerical-based water quality standards are mentioned in any of these and other related permits, testing and sampling may be required.
- Diversion and encroachment activities may constrict the waterway, which can obstruct flood flows and cause flooding or washouts. Diversion structures should not be installed without identifying potential impacts to the stream channel.
- Diversion or isolation activities are not appropriate in channels where there is insufficient stream flow to support aquatic species in the area dewatered as a result of the diversion.
- Diversion or isolation activities are inappropriate in deep water unless designed or reviewed by an engineer registered in California.
- Diversion or isolation activities should not completely dam stream flow.
- Dewatering and removal may require additional sediment control or water treatment. See NS-2, Dewatering Operations.
- Not appropriate if installation, maintenance, and removal of the structures will disturb sensitive aquatic species of concern.

Implementation

General

- Implement guidelines presented in NS-17, Streambank Stabilization to minimize impacts to streambanks.
- Where working areas encroach on flowing streams, barriers adequate to prevent the flow of muddy water into streams should be constructed and maintained between working areas and streams. During construction of the barriers, muddying of streams should be held to a minimum.
- Diversion structures must be adequately designed to accommodate fluctuations in water depth or flow volume due to tides, storms, flash floods, etc.
- Heavy equipment driven in wet portions of a water body to accomplish work should be completely clean of petroleum residue, and water levels should be below the fuel tanks, gearboxes, and axles of the equipment unless lubricants and fuels are sealed such that inundation by water will not result in discharges of fuels, oils, greases, or hydraulic fluids.

- Excavation equipment buckets may reach out into the water for the purpose of removing or placing fill materials. Only the bucket of the crane/ excavator/backhoe may operate in a water body. The main body of the crane/excavator/backhoe should not enter the water body except as necessary to cross the stream to access the work site.
- Stationary equipment such as motors and pumps located within or adjacent to a water body, should be positioned over drip pans.
- When any artificial obstruction is being constructed, maintained, or placed in operation, sufficient water should, at all times, be allowed to pass downstream to maintain aquatic life.
- Equipment should not be parked below the high water mark unless allowed by a permit.
- Disturbance or removal of vegetation should not exceed the minimum necessary to complete operations. Precautions should be taken to avoid damage to vegetation by people or equipment. Disturbed vegetation should be replaced with the appropriate erosion control measures.
- Riparian vegetation approved for trimming as part of the project should be cut off no lower than ground level to promote rapid re-growth. Access roads and work areas built over riparian vegetation should be covered by a sufficient layer of clean river run cobble to prevent damage to the underlying soil and root structure. The cobble should be removed upon completion of project activities.
- Drip pans should be placed under all vehicles and equipment placed on docks, barges, or other structures over water bodies when the vehicle or equipment is planned to be idle for more than 1 hour.
- Where possible, avoid or minimize diversion and encroachment impacts by scheduling construction during periods of low flow or when the stream is dry. Scheduling should also consider seasonal releases of water from dams, fish migration and spawning seasons, and water demands due to crop irrigation.
- Construct diversion structures with materials free of potential pollutants such as soil, silt, sand, clay, grease, or oil.

Temporary Diversions and Encroachments

- Construct diversion channels in accordance with EC-9, Earth Dikes and Drainage Swales.
- In high flow velocity areas, stabilize slopes of embankments and diversion ditches using an appropriate liner, in accordance with EC-7, Geotextiles and Mats, or use rock slope protection.
- Where appropriate, use natural streambed materials such as large cobbles and boulders for temporary embankment and slope protection, or other temporary soil stabilization methods.
- Provide for velocity dissipation at transitions in the diversion, such as the point where the stream is diverted to the channel and the point where the diverted stream is returned to its natural channel. See also EC-10, Velocity Dissipation Devices.

Temporary Dry Construction Areas

- When dewatering behind temporary structures to create a temporary dry construction area, such as cofferdams, pass pumped water through a sediment-settling device, such as a portable tank or settling basin, before returning water to the water body. See also NS-2, Dewatering Operations.
- Any substance used to assemble or maintain diversion structures, such as form oil, should be non-toxic and non-hazardous.
- Any material used to minimize seepage underneath diversion structures, such as grout, should be non-toxic, non-hazardous, and as close to a neutral pH as possible.

Comparison of Diversion and Isolation Techniques:

- Gravel bags are relatively inexpensive, but installation and removal can be labor intensive. It is also difficult to dewater the isolated area. Sandbags should not be used for this technique in rivers or streams, as sand should never be put into or adjacent to a stream, even if encapsulated in geotextile.
- Gravel Bag Berms (SE-6) used in conjunction with an impermeable membrane are cost effective, and can be dewatered relatively easily. If spawning gravel is used, the impermeable membrane can be removed from the stream, and the gravel can be spread out and left as salmonid spawning habitat if approved in the permit. Only clean, washed gravel should be used for both the gravel bag and gravel berm techniques.
- Cofferdams are relatively expensive, but frequently allow full dewatering. Also, many options now available are relatively easy to install.
- Sheet pile enclosures are a much more expensive solution, but do allow full dewatering. This technique is not well suited to small streams, but can be effective on large rivers or lakes, and where staging and heavy equipment access areas are available.
- K-rails are an isolation method that does not allow full dewatering, but can be used in small to large watercourses, and in fast-water situations.
- A relatively inexpensive isolation method is filter fabric isolation. This method involves placement of gravel bags or continuous berms to 'key-in' the fabric, and subsequently staking the fabric in place. This method should be used in relatively calm water, and can be used in smaller streams. Note that this is not a dewatering method, but rather a sediment isolation method.
- Turbidity curtains should be used where sediment discharge to a stream is unavoidable. They can also be used for in-stream construction, when dewatering an area is not required.
- When used in watercourses or streams, cofferdams must be used in accordance with permit requirements.
- Manufactured diversion structures should be installed following manufacturer's specifications.

- Filter fabric and turbidity curtain isolation installation methods can be found in the specific technique descriptions that follow.

Filter Fabric Isolation Technique

Definition and Purpose

A filter fabric isolation structure is a temporary structure built into a waterway to enclose a construction area and reduce sediment pollution from construction work in or adjacent to water. This structure is composed of filter fabric, gravel bags, and steel t-posts.

Appropriate Applications

- Filter fabric may be used for construction activities such as streambank stabilization, or culvert, bridge, pier or abutment installation. It may also be used in combination with other methods, such as clean water bypasses and/or pumps.
- Filter fabric isolation is relatively inexpensive. This method involves placement of gravel bags or continuous berms to 'key-in' the fabric, and subsequently staking the fabric in place.
- If spawning gravel is used, all other components of the isolation can be removed from the stream, and the gravel may be spread out and left as salmonid spawning habitat if approved in the permit. Whether spawning gravel or other types of gravel are used, only clean washed gravel should be used as infill for the gravel bags or continuous berm.
- This method should be used in relatively calm water, and can be used in smaller streams. This is not a dewatering method, but rather a sediment isolation method.
- Water levels inside and outside the fabric curtain must be about the same, as differential heads will cause the curtain to collapse.

Limitations

- Do not use if the installation, maintenance and removal of the structures will disturb sensitive aquatic species of concern.
- Filter fabrics are not appropriate for projects where dewatering is necessary.
- Filter fabrics are not appropriate to completely dam stream flow.

Design and Installation

- For the filter fabric isolation method, a non-woven or heavy-duty fabric is recommended over standard silt fence. Using rolled geotextiles allows non-standard widths to be used.
- Anchor filter fabric with gravel bags filled with clean, washed gravel. Do not use sand. If a bag should split open, the gravel can be left in the stream, where it can provide aquatic habitat benefits. If a sandbag splits open in a watercourse, the sand could cause a decrease in water quality, and could bury sensitive aquatic habitat.
- Another anchor alternative is a continuous berm, made with the Continuous Berm Machine. This is a gravel-filled bag that can be made in very long segments. The length of the berms is usually limited to 18 ft for ease of handling (otherwise, it gets too heavy to move).

- Place the fabric on the bottom of the stream, and place either a bag of clean, washed gravel or a continuous berm over the bottom of the silt fence fabric, such that a bag-width of fabric lies on the stream bottom. The bag should be placed on what will be the outside of the isolation area.
- Pull the fabric up, and place a metal t-post immediately behind the fabric, on the inside of the isolation area; attach the silt fence to the post with three diagonal nylon ties.
- Continue placing fabric as described above until the entire work area has been isolated, staking the fabric at least every 6 ft.

Inspection and Maintenance

- Immediately repair any gaps, holes or scour.
- Remove and properly dispose of sediment buildup.
- Remove BMP upon completion of construction activity. Recycle or reuse if applicable.
- Revegetate areas disturbed by BMP removal if needed.

Turbidity Curtain Isolation Technique

Definition and Purpose

A turbidity curtain is a fabric barrier used to isolate the near shore work area. The barriers are intended to confine the suspended sediment. The curtain is a floating barrier, and thus does not prevent water from entering the isolated area; rather, it prevents suspended sediment from getting out.

Appropriate Applications

Turbidity curtains should be used where sediment discharge to a stream is unavoidable. They are used when construction activities adjoin quiescent waters, such as lakes, ponds, and slow flowing rivers. The curtains are designed to deflect and contain sediment within a limited area and provide sufficient retention time so that the sediment particles will fall out of suspension.

Limitations

- Turbidity curtains should not be used in flowing water; they are best suited for use in ponds, lakes, and very slow-moving rivers.
- Turbidity curtains should not be placed across the width of a channel.
- Removing sediment that has been deflected and settled out by the curtain may create a discharge problem through the resuspension of particles and by accidental dumping by the removal equipment.

Design and Installation

- Turbidity curtains should be oriented parallel to the direction of flow.
- The curtain should extend the entire depth of the watercourse in calm-water situations.
- In wave conditions, the curtain should extend to within 1 ft of the bottom of the watercourse, such that the curtain does not stir up sediment by hitting the bottom repeatedly. If it is

desirable for the curtain to reach the bottom in an active-water situation, a pervious filter fabric may be used for the bottom 1 ft.

- The top of the curtain should consist of flexible flotation buoys, and the bottom should be held down by a load line incorporated into the curtain fabric. The fabric should be a brightly colored impervious mesh.
- The curtain should be held in place by anchors placed at least every 100 ft.
- First, place the anchors, then tow the fabric out in a furled condition, and connect to the anchors. The anchors should be connected to the flotation devices, and not to the bottom of the curtain. Once in place, cut the furling lines, and allow the bottom of the curtain to sink.
- Consideration must be given to the probable outcome of the removal procedure. It must be determined if it will create more of a sediment problem through re-suspension of the particles or by accidental dumping of material during removal. It is recommended that the soil particles trapped by the turbidity curtain only be removed if there has been a significant change in the original contours of the affected area in the watercourse.
- Particles should always be allowed to settle for a minimum of 6 to 12 hours prior to their removal or prior to removal of the turbidity curtain.

Maintenance and Inspection:

- The curtain should be inspected for holes or other problems, and any repairs needed should be made promptly.
- Allow sediment to settle for 6 to 12 hours prior to removal of sediment or curtain. This means that after removing sediment, wait an additional 6 to 12 hours before removing the curtain.
- To remove, install furling lines along the curtain, detach from anchors, and tow out of the water.

K-rail River Isolation

Definition and Purpose

This temporary sediment control or stream isolation method uses K-rails to form the sediment deposition area, or to isolate the in-stream or near-bank construction area.

Barriers are placed end-to-end in a pre-designed configuration and gravel-filled bags are used at the toe of the barrier and at their abutting ends to seal and prevent movement of sediment beneath or through the barrier walls.

Appropriate Applications

The K-rail isolation can be used in streams with higher water velocities than many other isolation techniques.

- This technique is also useful at the toe of embankments, and cut or fill slopes.

Limitations

- The K-rail method should not be used to dewater a project site, as the barrier is not watertight.

Design and Installation

- To create a floor for the K-rail, move large rocks and obstructions. Place washed gravel and gravel-filled bags to create a level surface for K-rails to sit. Washed gravel should always be used.
- Place the bottom two K-rails adjacent to each other, and parallel to the direction of flow; fill the center portion with gravel bags. Then place the third K-rail on top of the bottom two. There should be sufficient gravel bags between the bottom K-rails such that the top rail is supported by the gravel. Place plastic sheeting around the K-rails, and secure at the bottom with gravel bags.
- Further support can be added by pinning and cabling the K-rails together. Also, large riprap and boulders can be used to support either side of the K-rail, especially where there is strong current.

Inspection and Maintenance:

- The barrier should be inspected and any leaks, holes, or other problems should be addressed immediately.
- Sediment should be allowed to settle for at least 6 to 12 hours prior to removal of sediment, and for 6 to 12 hours prior to removal of the barrier.

Stream Diversions

The selection of which stream diversion technique to use will depend upon the type of work involved, physical characteristics of the site, and the volume of water flowing through the project.

Advantages of a Pumped Diversion

- Downstream sediment transport can be nearly eliminated.
- Dewatering of the work area is possible.
- Pipes can be moved around to allow construction operations.
- The dams can serve as temporary access to the site.
- Increased flows can be managed by adding more pumping capacity.

Disadvantages of a Pumped Diversion

- Flow volume is limited by pump capacity.
- A pumped diversion requires 24 hour monitoring of pumps.
- Sudden rain could overtop dams.
- Erosion at the outlet.

- Minor in-stream disturbance is required to install and remove dams.

Advantages of Excavated Channels and Flumes

- Excavated channels isolate work from water flow and allow dewatering.
- Excavated channels can handle larger flows than pumps.

Disadvantages of Excavated Channels and Flumes

- Bypass channel or flume must be sized to handle flows, including possible floods.
- Channels must be protected from erosion.
- Flow diversion and re-direction with small dams involves in-stream disturbance and mobilization of sediment.

Design and Installation

- Installation guidelines will vary based on existing site conditions and type of diversion used.
- Pump capacity must be sufficient for design flow.
- A standby pump is required in case a primary pump fails.
- Dam materials used to create dams upstream and downstream of diversion should be erosion resistant; materials such as steel plate, sheet pile, sandbags, continuous berms, inflatable water bladders, etc., would be acceptable.

When constructing a diversion channel, begin excavation of the channel at the proposed downstream end, and work upstream. Once the watercourse to be diverted is reached and the excavated channel is stable, breach the upstream end and allow water to flow down the new channel. Once flow has been established in the diversion channel, install the diversion weir in the main channel; this will force all water to be diverted from the main channel.

Inspection and Maintenance

- Pumped diversions require 24 hour monitoring of pumps.
- Inspect embankments and diversion channels for damage to the linings, accumulating debris, sediment buildup, and adequacy of the slope protection. Remove debris and repair linings and slope protection as required. Remove holes, gaps, or scour.
- Upon completion of work, the diversion or isolation structure should be removed and flow should be redirected through the new culvert or back into the original stream channel. Recycle or reuse if applicable.
- Revegetate areas disturbed by BMP removal if needed.

Costs

Costs of clear water diversion vary considerably and can be very high.

Inspection and Maintenance

- Inspect and verify that activity-based BMPs are in place prior to the commencement of associated activities. While activities associated with the BMP are under way, inspect weekly during the rainy season and at two-week intervals in the non-rainy season to verify continued BMP implementation.
- Inspect BMPs subject to non-stormwater discharges daily while non-stormwater discharges occur.
- Refer to BMP-specific inspection and maintenance requirements.

References

California Bank and Shore Rock Slope Protection Design – Practitioners Guide and Field Evaluations of Riprap Methods, Caltrans Study No. F90TL03, October, 2000.

Stormwater Quality Handbooks - Construction Site Best Management Practices (BMPs) Manual, State of California Department of Transportation (Caltrans), November 2000.

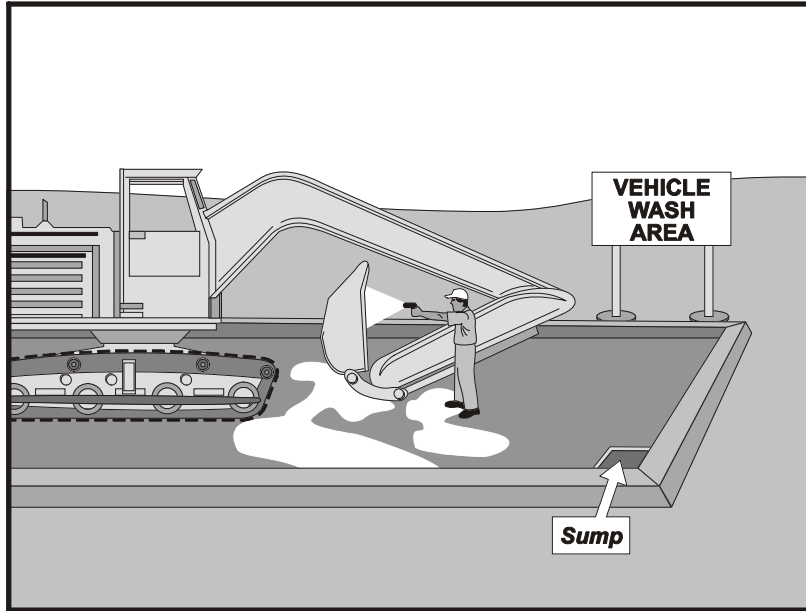

Description and Purpose

Vehicle and equipment cleaning procedures and practices eliminate or reduce the discharge of pollutants to stormwater from vehicle and equipment cleaning operations. Procedures and practices include but are not limited to: using offsite facilities; washing in designated, contained areas only; eliminating discharges to the storm drain by infiltrating the wash water; and training employees and subcontractors in proper cleaning procedures.

Suitable Applications

These procedures are suitable on all construction sites where vehicle and equipment cleaning is performed.

Limitations

Even phosphate-free, biodegradable soaps have been shown to be toxic to fish before the soap degrades. Sending vehicles/equipment offsite should be done in conjunction with TC-1, Stabilized Construction Entrance/Exit.

Implementation

Other options to washing equipment onsite include contracting with either an offsite or mobile commercial washing business. These businesses may be better equipped to handle and dispose of the wash waters properly. Performing this work offsite can also be economical by eliminating the need for a separate washing operation onsite.

If washing operations are to take place onsite, then:

Categories

EC	Erosion Control	
SE	Sediment Control	
TC	Tracking Control	
WE	Wind Erosion Control	
NS	Non-Stormwater Management Control	<input checked="" type="checkbox"/>
WM	Waste Management and Materials Pollution Control	

Legend:

- Primary Objective
- Secondary Objective

Targeted Constituents

Sediment	<input checked="" type="checkbox"/>
Nutrients	<input checked="" type="checkbox"/>
Trash	
Metals	
Bacteria	
Oil and Grease	<input checked="" type="checkbox"/>
Organics	<input checked="" type="checkbox"/>

Potential Alternatives

None



- Use phosphate-free, biodegradable soaps.
- Educate employees and subcontractors on pollution prevention measures.
- Do not permit steam cleaning onsite. Steam cleaning can generate significant pollutant concentrates.
- Cleaning of vehicles and equipment with soap, solvents or steam should not occur on the project site unless resulting wastes are fully contained and disposed of. Resulting wastes should not be discharged or buried, and must be captured and recycled or disposed according to the requirements of WM-10, Liquid Waste Management or WM-6, Hazardous Waste Management, depending on the waste characteristics. Minimize use of solvents. Use of diesel for vehicle and equipment cleaning is prohibited.
- All vehicles and equipment that regularly enter and leave the construction site must be cleaned offsite.
- When vehicle and equipment washing and cleaning must occur onsite, and the operation cannot be located within a structure or building equipped with appropriate disposal facilities, the outside cleaning area should have the following characteristics:
 - Located away from storm drain inlets, drainage facilities, or watercourses
 - Paved with concrete or asphalt and bermed to contain wash waters and to prevent runoff
 - Configured with a sump to allow collection and disposal of wash water
 - No discharge of wash waters to storm drains or watercourses
 - Used only when necessary
- When cleaning vehicles and equipment with water:
 - Use as little water as possible. High-pressure sprayers may use less water than a hose and should be considered
 - Use positive shutoff valve to minimize water usage
 - Facility wash racks should discharge to a sanitary sewer, recycle system or other approved discharge system and must not discharge to the storm drainage system, watercourses, or to groundwater

Costs

Cleaning vehicles and equipment at an offsite facility may reduce overall costs for vehicle and equipment cleaning by eliminating the need to provide similar services onsite. When onsite cleaning is needed, the cost to establish appropriate facilities is relatively low on larger, long-duration projects, and moderate to high on small, short-duration projects.

Inspection and Maintenance

- Inspect and verify that activity-based BMPs are in place prior to the commencement of associated activities. While activities associated with the BMP are under way, inspect weekly during the rainy season and at two-week intervals in the non-rainy season to verify continued BMP implementation.
- Inspect BMPs subject to non-stormwater discharges daily while non-stormwater discharges occur.
- Inspection and maintenance is minimal, although some berm repair may be necessary.
- Monitor employees and subcontractors throughout the duration of the construction project to ensure appropriate practices are being implemented.
- Inspect sump regularly and remove liquids and sediment as needed.
- Prohibit employees and subcontractors from washing personal vehicles and equipment on the construction site.

References

Stormwater Quality Handbooks - Construction Site Best Management Practices (BMPs) Manual, State of California Department of Transportation (Caltrans), November 2000.

Swisher, R.D. Surfactant Biodegradation, Marcel Decker Corporation, 1987.

This page intentionally left blank

Vehicle & Equipment Maintenance NS-10

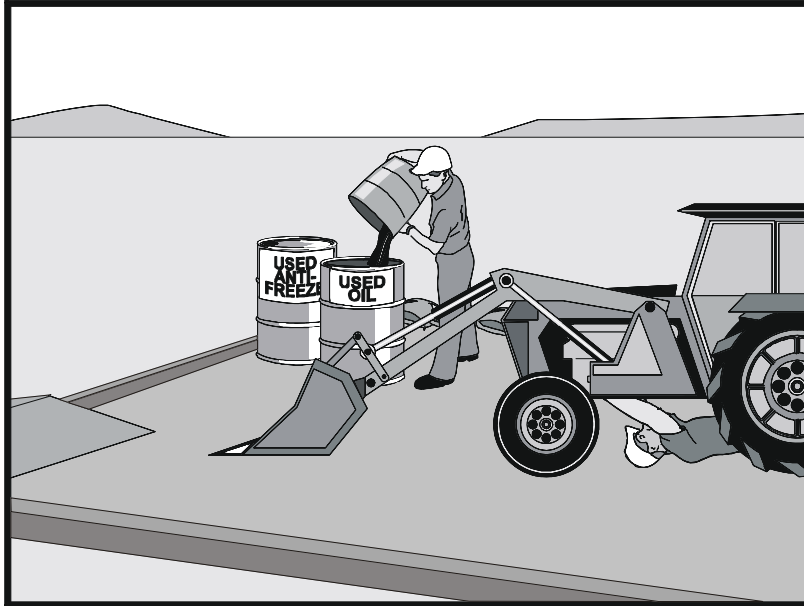

Description and Purpose

Prevent or reduce the contamination of stormwater resulting from vehicle and equipment maintenance by running a “dry and clean site”. The best option would be to perform maintenance activities at an offsite facility. If this option is not available then work should be performed in designated areas only, while providing cover for materials stored outside, checking for leaks and spills, and containing and cleaning up spills immediately. Employees and subcontractors must be trained in proper procedures.

Suitable Applications

These procedures are suitable on all construction projects where an onsite yard area is necessary for storage and maintenance of heavy equipment and vehicles.

Limitations

Onsite vehicle and equipment maintenance should only be used where it is impractical to send vehicles and equipment offsite for maintenance and repair. Sending vehicles/equipment offsite should be done in conjunction with TC-1, Stabilized Construction Entrance/Exit.

Outdoor vehicle or equipment maintenance is a potentially significant source of stormwater pollution. Activities that can contaminate stormwater include engine repair and service, changing or replacement of fluids, and outdoor equipment storage and parking (engine fluid leaks). For further information on vehicle or equipment servicing, see NS-8, Vehicle and Equipment Cleaning, and NS-9, Vehicle and

Categories

EC	Erosion Control	
SE	Sediment Control	
TC	Tracking Control	
WE	Wind Erosion Control	
NS	Non-Stormwater Management Control	<input checked="" type="checkbox"/>
WM	Waste Management and Materials Pollution Control	

Legend:

- Primary Objective
- Secondary Objective

Targeted Constituents

Sediment	
Nutrients	<input checked="" type="checkbox"/>
Trash	<input checked="" type="checkbox"/>
Metals	
Bacteria	
Oil and Grease	<input checked="" type="checkbox"/>
Organics	<input checked="" type="checkbox"/>

Potential Alternatives

None



Vehicle & Equipment Maintenance NS-10

Equipment Fueling.

Implementation

- Use offsite repair shops as much as possible. These businesses are better equipped to handle vehicle fluids and spills properly. Performing this work offsite can also be economical by eliminating the need for a separate maintenance area.
- If maintenance must occur onsite, use designated areas, located away from drainage courses. Dedicated maintenance areas should be protected from stormwater runoff and runoff, and should be located at least 50 ft from downstream drainage facilities and watercourses.
- Drip pans or absorbent pads should be used during vehicle and equipment maintenance work that involves fluids, unless the maintenance work is performed over an impermeable surface in a dedicated maintenance area.
- Place a stockpile of spill cleanup materials where it will be readily accessible.
- All fueling trucks and fueling areas are required to have spill kits and/or use other spill protection devices.
- Use adsorbent materials on small spills. Remove the absorbent materials promptly and dispose of properly.
- Inspect onsite vehicles and equipment daily at startup for leaks, and repair immediately.
- Keep vehicles and equipment clean; do not allow excessive build-up of oil and grease.
- Segregate and recycle wastes, such as greases, used oil or oil filters, antifreeze, cleaning solutions, automotive batteries, hydraulic and transmission fluids. Provide secondary containment and covers for these materials if stored onsite.
- Train employees and subcontractors in proper maintenance and spill cleanup procedures.
- Drip pans or plastic sheeting should be placed under all vehicles and equipment placed on docks, barges, or other structures over water bodies when the vehicle or equipment is planned to be idle for more than 1 hour.
- For long-term projects, consider using portable tents or covers over maintenance areas if maintenance cannot be performed offsite.
- Consider use of new, alternative greases and lubricants, such as adhesive greases, for chassis lubrication and fifth-wheel lubrication.
- Properly dispose of used oils, fluids, lubricants, and spill cleanup materials.
- Do not place used oil in a dumpster or pour into a storm drain or watercourse.
- Properly dispose of or recycle used batteries.
- Do not bury used tires.

Vehicle & Equipment Maintenance NS-10

- Repair leaks of fluids and oil immediately.

Listed below is further information if you must perform vehicle or equipment maintenance onsite.

Safer Alternative Products

- Consider products that are less toxic or hazardous than regular products. These products are often sold under an “environmentally friendly” label.
- Consider use of grease substitutes for lubrication of truck fifth-wheels. Follow manufacturers label for details on specific uses.
- Consider use of plastic friction plates on truck fifth-wheels in lieu of grease. Follow manufacturers label for details on specific uses.

Waste Reduction

Parts are often cleaned using solvents such as trichloroethylene, trichloroethane, or methylene chloride. Many of these cleaners are listed in California Toxic Rule as priority pollutants. These materials are harmful and must not contaminate stormwater. They must be disposed of as a hazardous waste. Reducing the number of solvents makes recycling easier and reduces hazardous waste management costs. Often, one solvent can perform a job as well as two different solvents. Also, if possible, eliminate or reduce the amount of hazardous materials and waste by substituting non-hazardous or less hazardous materials. For example, replace chlorinated organic solvents with non-chlorinated solvents. Non-chlorinated solvents like kerosene or mineral spirits are less toxic and less expensive to dispose of properly. Check the list of active ingredients to see whether it contains chlorinated solvents. The “chlor” term indicates that the solvent is chlorinated. Also, try substituting a wire brush for solvents to clean parts.

Recycling and Disposal

Separating wastes allows for easier recycling and may reduce disposal costs. Keep hazardous wastes separate, do not mix used oil solvents, and keep chlorinated solvents (like, -trichloroethane) separate from non-chlorinated solvents (like kerosene and mineral spirits). Promptly transfer used fluids to the proper waste or recycling drums. Don't leave full drip pans or other open containers lying around. Provide cover and secondary containment until these materials can be removed from the site.

Oil filters can be recycled. Ask your oil supplier or recycler about recycling oil filters.

Do not dispose of extra paints and coatings by dumping liquid onto the ground or throwing it into dumpsters. Allow coatings to dry or harden before disposal into covered dumpsters.

Store cracked batteries in a non-leaking secondary container. Do this with all cracked batteries, even if you think all the acid has drained out. If you drop a battery, treat it as if it is cracked. Put it into the containment area until you are sure it is not leaking.

Costs

All of the above are low cost measures. Higher costs are incurred to setup and maintain onsite maintenance areas.

Vehicle & Equipment Maintenance NS-10

Inspection and Maintenance

- Inspect and verify that activity-based BMPs are in place prior to the commencement of associated activities. While activities associated with the BMP are under way, inspect weekly during the rainy season and at two-week intervals in the non-rainy season to verify continued BMP implementation.
- Inspect BMPs subject to non-stormwater discharges daily while non-stormwater discharges occur.
- Keep ample supplies of spill cleanup materials onsite.
- Maintain waste fluid containers in leak proof condition.
- Vehicles and equipment should be inspected on each day of use. Leaks should be repaired immediately or the problem vehicle(s) or equipment should be removed from the project site.
- Inspect equipment for damaged hoses and leaky gaskets routinely. Repair or replace as needed.

References

Blueprint for a Clean Bay: Best Management Practices to Prevent Stormwater Pollution from Construction Related Activities; Santa Clara Valley Nonpoint Source Pollution Control Program, 1995.

Coastal Nonpoint Pollution Control Program; Program Development and Approval Guidance, Working Group, Working Paper; USEPA, April 1992.

Stormwater Quality Handbooks - Construction Site Best Management Practices (BMPs) Manual, State of California Department of Transportation (Caltrans), November 2000.

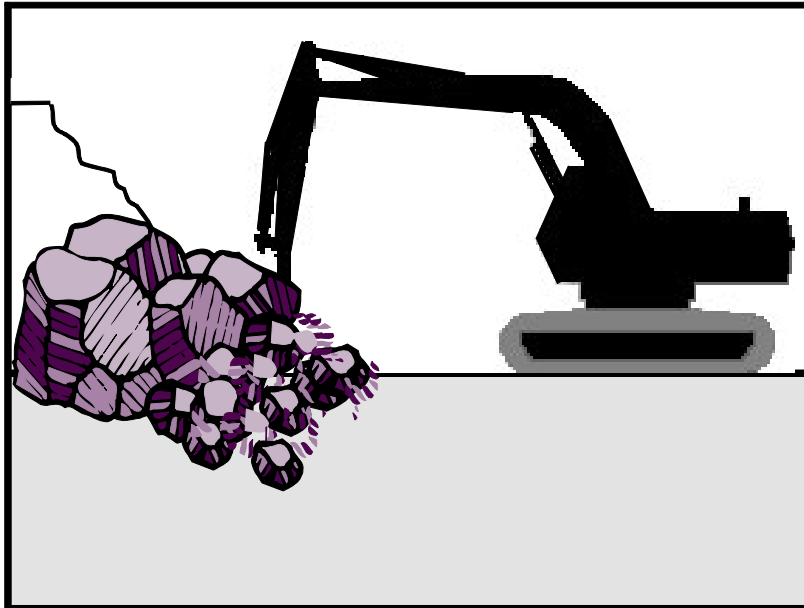

Description and Purpose

Procedures to protect water bodies from debris and wastes associated with structure demolition or removal over or adjacent to watercourses.

Suitable Applications

Full bridge demolition and removal, partial bridge removal (barrier rail, edge of deck) associated with bridge widening projects, concrete channel removal, or any other structure removal that could potentially affect water quality.

Limitations

None identified.

Implementation

- Refer to NS-5, Clear Water Diversion, to direct water away from work areas.
- Use attachments on construction equipment such as backhoes to catch debris from small demolition operations.
- Use covers or platforms to collect debris.
- Platforms and covers are to be approved by the owner.
- Stockpile accumulated debris and waste generated during demolition away from watercourses and in accordance with WM-3, Stockpile Management.
- Ensure safe passage of wildlife, as necessary.

Categories

EC	Erosion Control	
SE	Sediment Control	
TC	Tracking Control	
WE	Wind Erosion Control	
NS	Non-Stormwater Management Control	<input checked="" type="checkbox"/>
WM	Waste Management and Materials Pollution Control	

Legend:

- Primary Objective
- Secondary Objective

Targeted Constituents

Sediment	<input checked="" type="checkbox"/>
Nutrients	<input checked="" type="checkbox"/>
Trash	<input checked="" type="checkbox"/>
Metals	<input checked="" type="checkbox"/>
Bacteria	<input checked="" type="checkbox"/>
Oil and Grease	<input checked="" type="checkbox"/>
Organics	<input checked="" type="checkbox"/>

Potential Alternatives

None



- Discharges to waterways shall be reported to the Regional Water Quality Control Board immediately upon discovery. A written discharge notification must follow within 7 days. Follow the spill reporting procedures in the SWPPP.
- For structures containing hazardous materials, i.e., lead paint or asbestos, refer to BMP WM-6, Hazardous Waste Management. For demolition work involving soil excavation around lead-painted structures, refer to WM-7, Contaminated Soil Management.

Costs

Cost may vary according to the combination of practices implemented.

Inspection and Maintenance

- Inspect and verify that activity-based BMPs are in place prior to the commencement of associated activities. While activities associated with the BMP are under way, inspect weekly during the rainy season and of two-week intervals in the non-rainy season to verify continued BMP implementation.
- Inspect BMPs subject to non-stormwater discharge daily while non-stormwater discharges occur.
- Any debris-catching devices shall be emptied regularly. Collected debris shall be removed and stored away from the watercourse and protected from runoff and runoff.

References

Stormwater Quality Handbooks - Construction Site Best Management Practices (BMPs) Manual, State of California Department of Transportation (Caltrans), November 2000.

Stormwater Management for Construction Activities, Developing Pollution Prevention Plans and Best Management Practices, EPA 832-R-92005; USEPA, April 1992.

Tracking Control [TC]

This page intentionally left blank.

Stabilized Construction Entrance/Exit TC-1

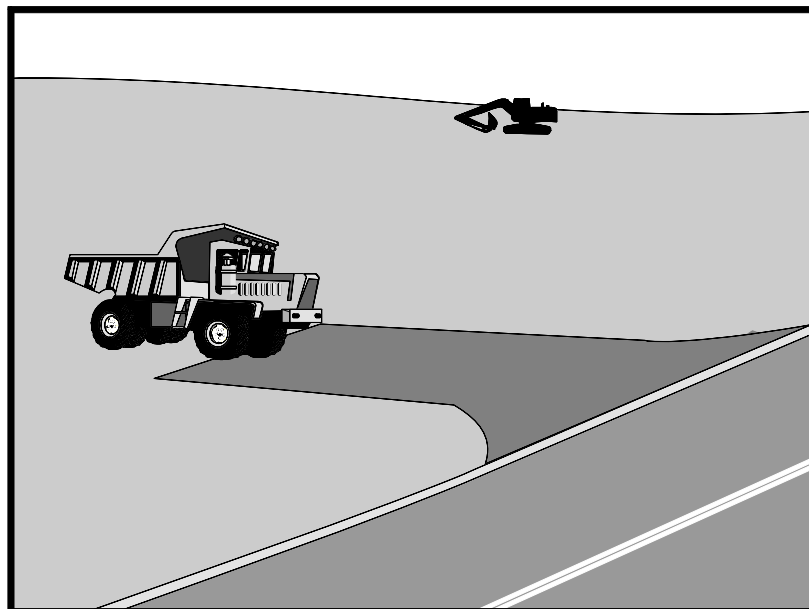

Description and Purpose

A stabilized construction access is defined by a point of entrance/exit to a construction site that is stabilized to reduce the tracking of mud and dirt onto public roads by construction vehicles.

Suitable Applications

Use at construction sites:

- Where dirt or mud can be tracked onto public roads.
- Adjacent to water bodies.
- Where poor soils are encountered.
- Where dust is a problem during dry weather conditions.

Limitations

- Entrances and exits require periodic top dressing with additional stones.
- This BMP should be used in conjunction with street sweeping on adjacent public right of way.
- Entrances and exits should be constructed on level ground only.
- Stabilized construction entrances are rather expensive to construct and when a wash rack is included, a sediment trap of some kind must also be provided to collect wash water

Categories

EC	Erosion Control	<input checked="" type="checkbox"/>
SE	Sediment Control	<input checked="" type="checkbox"/>
TC	Tracking Control	<input checked="" type="checkbox"/>
WE	Wind Erosion Control	
NS	Non-Stormwater Management Control	
WM	Waste Management and Materials Pollution Control	

Legend:

- Primary Objective
- Secondary Objective

Targeted Constituents

Sediment	<input checked="" type="checkbox"/>
Nutrients	
Trash	
Metals	
Bacteria	
Oil and Grease	
Organics	

Potential Alternatives

None



Stabilized Construction Entrance/Exit TC-1

runoff.

Implementation

General

A stabilized construction entrance is a pad of aggregate underlain with filter cloth located at any point where traffic will be entering or leaving a construction site to or from a public right of way, street, alley, sidewalk, or parking area. The purpose of a stabilized construction entrance is to reduce or eliminate the tracking of sediment onto public rights of way or streets. Reducing tracking of sediments and other pollutants onto paved roads helps prevent deposition of sediments into local storm drains and production of airborne dust.

Where traffic will be entering or leaving the construction site, a stabilized construction entrance should be used. NPDES permits require that appropriate measures be implemented to prevent tracking of sediments onto paved roadways, where a significant source of sediments is derived from mud and dirt carried out from unpaved roads and construction sites.

Stabilized construction entrances are moderately effective in removing sediment from equipment leaving a construction site. The entrance should be built on level ground. Advantages of the Stabilized Construction Entrance/Exit is that it does remove some sediment from equipment and serves to channel construction traffic in and out of the site at specified locations. Efficiency is greatly increased when a washing rack is included as part of a stabilized construction entrance/exit.

Design and Layout

- Construct on level ground where possible.
- Select 3 to 6 in. diameter stones.
- Use minimum depth of stones of 12 in. or as recommended by soils engineer.
- Construct length of 50 ft minimum, and 30 ft minimum width.
- Rumble racks constructed of steel panels with ridges and installed in the stabilized entrance/exit will help remove additional sediment and to keep adjacent streets clean.
- Provide ample turning radii as part of the entrance.
- Limit the points of entrance/exit to the construction site.
- Limit speed of vehicles to control dust.
- Properly grade each construction entrance/exit to prevent runoff from leaving the construction site.
- Route runoff from stabilized entrances/exits through a sediment trapping device before discharge.
- Design stabilized entrance/exit to support heaviest vehicles and equipment that will use it.

Stabilized Construction Entrance/Exit TC-1

- Select construction access stabilization (aggregate, asphaltic concrete, concrete) based on longevity, required performance, and site conditions. Do not use asphalt concrete (AC) grindings for stabilized construction access/roadway.
- If aggregate is selected, place crushed aggregate over geotextile fabric to at least 12 in. depth, or place aggregate to a depth recommended by a geotechnical engineer. A crushed aggregate greater than 3 in. but smaller than 6 in. should be used.
- Designate combination or single purpose entrances and exits to the construction site.
- Require that all employees, subcontractors, and suppliers utilize the stabilized construction access.
- Implement SE-7, Street Sweeping and Vacuuming, as needed.
- All exit locations intended to be used for more than a two-week period should have stabilized construction entrance/exit BMPs.

Inspection and Maintenance

- Inspect and verify that activity-based BMPs are in place prior to the commencement of associated activities. While activities associated with the BMPs are under way, inspect weekly during the rainy season and of two-week intervals in the non-rainy season to verify continued BMP implementation.
- Inspect local roads adjacent to the site daily. Sweep or vacuum to remove visible accumulated sediment.
- Remove aggregate, separate and dispose of sediment if construction entrance/exit is clogged with sediment.
- Keep all temporary roadway ditches clear.
- Check for damage and repair as needed.
- Replace gravel material when surface voids are visible.
- Remove all sediment deposited on paved roadways within 24 hours.
- Remove gravel and filter fabric at completion of construction

Costs

Average annual cost for installation and maintenance may vary from \$1,200 to \$4,800 each, averaging \$2,400 per entrance. Costs will increase with addition of washing rack, and sediment trap. With wash rack, costs range from \$1,200 - \$6,000 each, averaging \$3,600 per entrance.

References

Manual of Standards of Erosion and Sediment Control Measures, Association of Bay Area Governments, May 1995.

Stabilized Construction Entrance/Exit TC-1

National Management Measures to Control Nonpoint Source Pollution from Urban Areas, USEPA Agency, 2002.

Proposed Guidance Specifying Management Measures for Sources of Nonpoint Pollution in Coastal Waters, Work Group Working Paper, USEPA, April 1992.

Stormwater Quality Handbooks Construction Site Best Management Practices (BMPs) Manual, State of California Department of Transportation (Caltrans), November 2000.

Stormwater Management of the Puget Sound Basin, Technical Manual, Publication #91-75, Washington State Department of Ecology, February 1992.

Virginia Erosion and Sedimentation Control Handbook, Virginia Department of Conservation and Recreation, Division of Soil and Water Conservation, 1991.

Guidance Specifying Management Measures for Nonpoint Pollution in Coastal Waters, EPA 840-B-9-002, USEPA, Office of Water, Washington, DC, 1993.

Water Quality Management Plan for the Lake Tahoe Region, Volume II, Handbook of Management Practices, Tahoe Regional Planning Agency, November 1988.

Stabilized Construction Entrance/Exit TC-1

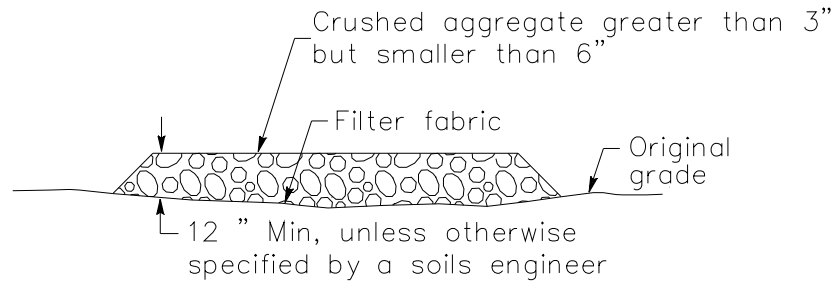

SECTION B-B
NTS

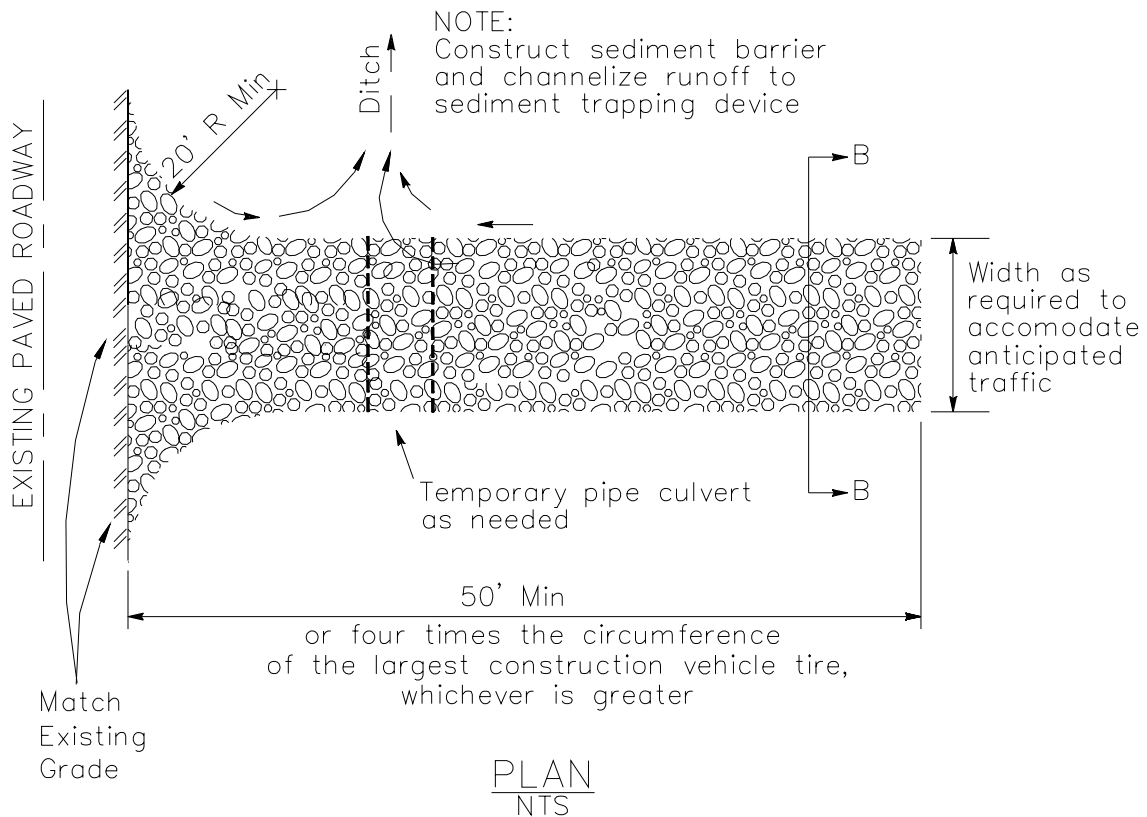

Stabilized Construction Entrance/Exit TC-1

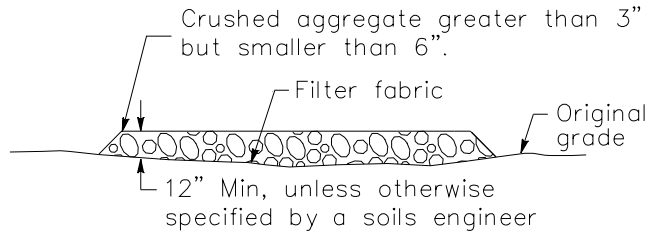

SECTION B-B
NTS

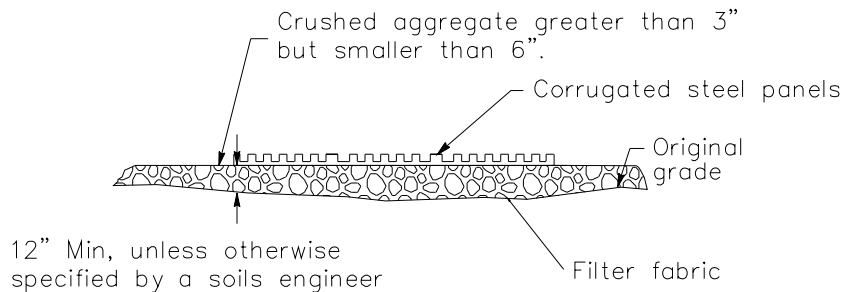

SECTION A-A
NOT TO SCALE

NOTE:
Construct sediment barrier and channelize runoff to sediment trapping device

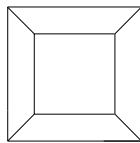

Sediment trapping device

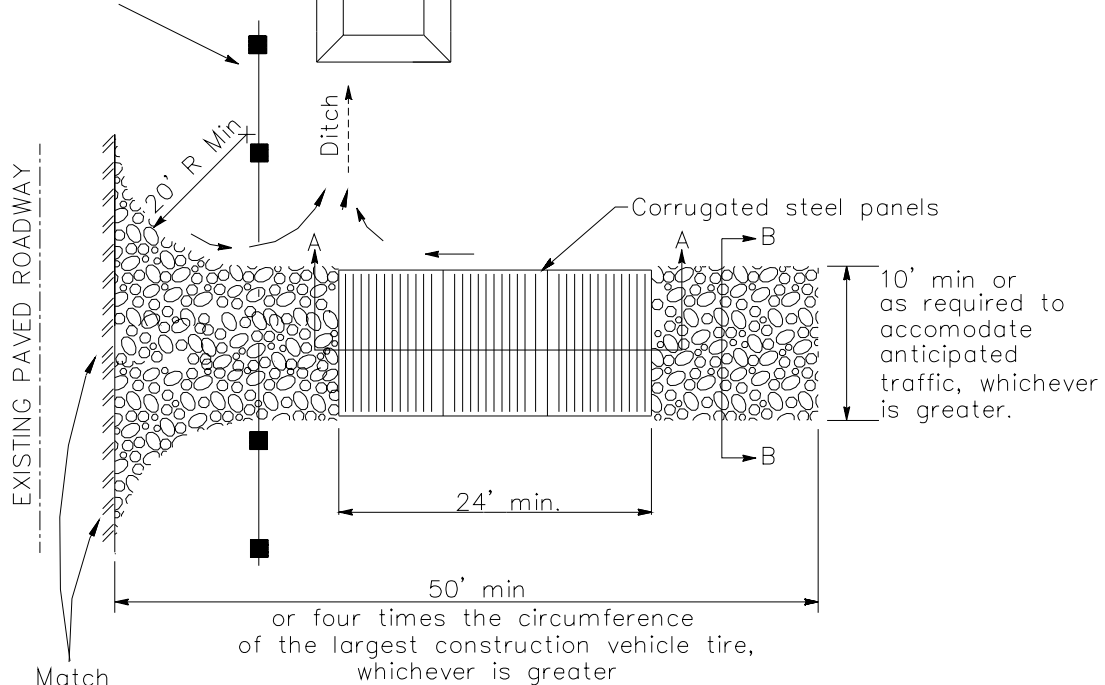

PLAN
NTS

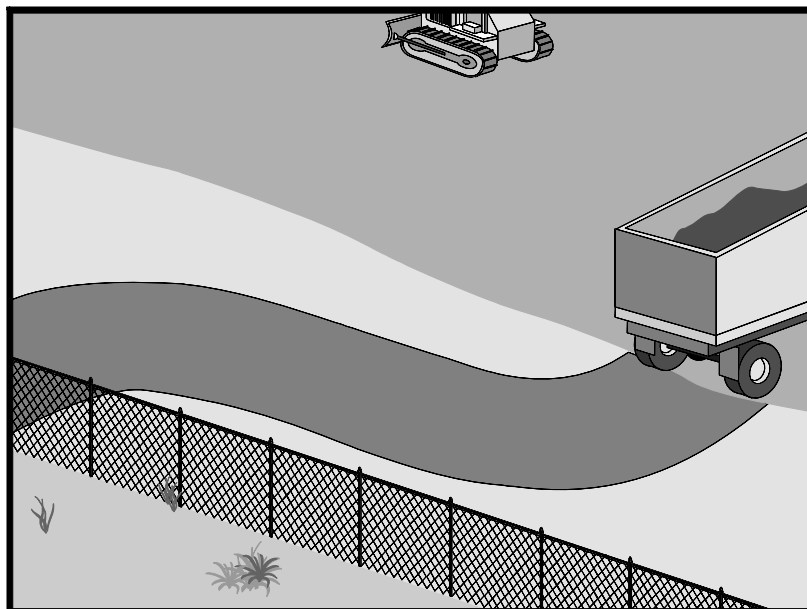

Description and Purpose

Access roads, subdivision roads, parking areas, and other onsite vehicle transportation routes should be stabilized immediately after grading, and frequently maintained to prevent erosion and control dust.

Suitable Applications

This BMP should be applied for the following conditions:

- Temporary Construction Traffic:
 - Phased construction projects and offsite road access
 - Construction during wet weather
- Construction roadways and detour roads:
 - Where mud tracking is a problem during wet weather
 - Where dust is a problem during dry weather
 - Adjacent to water bodies
 - Where poor soils are encountered

Limitations

- The roadway must be removed or paved when construction is complete.
- Certain chemical stabilization methods may cause stormwater or soil pollution and should not be used. See WE-1, Wind Erosion Control.

Categories

EC	Erosion Control	<input checked="" type="checkbox"/>
SE	Sediment Control	<input checked="" type="checkbox"/>
TC	Tracking Control	<input checked="" type="checkbox"/>
WE	Wind Erosion Control	
NS	Non-Stormwater Management Control	
WM	Waste Management and Materials Pollution Control	

Legend:

- Primary Objective
- Secondary Objective

Targeted Constituents

Sediment	<input checked="" type="checkbox"/>
Nutrients	
Trash	
Metals	
Bacteria	
Oil and Grease	
Organics	

Potential Alternatives

None



- Management of construction traffic is subject to air quality control measures. Contact the local air quality management agency.
- Materials will likely need to be removed prior to final project grading and stabilization.
- Use of this BMP may not be applicable to very short duration projects.

Implementation

General

Areas that are graded for construction vehicle transport and parking purposes are especially susceptible to erosion and dust. The exposed soil surface is continually disturbed, leaving no opportunity for vegetative stabilization. Such areas also tend to collect and transport runoff waters along their surfaces. During wet weather, they often become muddy quagmires that generate significant quantities of sediment that may pollute nearby streams or be transported offsite on the wheels of construction vehicles. Dirt roads can become so unstable during wet weather that they are virtually unusable.

Efficient construction road stabilization not only reduces onsite erosion but also can significantly speed onsite work, avoid instances of immobilized machinery and delivery vehicles, and generally improve site efficiency and working conditions during adverse weather

Installation/Application Criteria

Permanent roads and parking areas should be paved as soon as possible after grading. As an alternative where construction will be phased, the early application of gravel or chemical stabilization may solve potential erosion and stability problems. Temporary gravel roadway should be considered during the rainy season and on slopes greater than 5%.

Temporary roads should follow the contour of the natural terrain to the maximum extent possible. Slope should not exceed 15%. Roadways should be carefully graded to drain transversely. Provide drainage swales on each side of the roadway in the case of a crowned section or one side in the case of a super elevated section. Simple gravel berms without a trench can also be used.

Installed inlets should be protected to prevent sediment laden water from entering the storm sewer system (SE-10, Storm Drain Inlet Protection). In addition, the following criteria should be considered.

- Road should follow topographic contours to reduce erosion of the roadway.
- The roadway slope should not exceed 15%.
- Chemical stabilizers or water are usually required on gravel or dirt roads to prevent dust (WE-1, Wind Erosion Control).
- Properly grade roadway to prevent runoff from leaving the construction site.
- Design stabilized access to support heaviest vehicles and equipment that will use it.

- Stabilize roadway using aggregate, asphalt concrete, or concrete based on longevity, required performance, and site conditions. The use of cold mix asphalt or asphalt concrete (AC) grindings for stabilized construction roadway is not allowed.
- Coordinate materials with those used for stabilized construction entrance/exit points.
- If aggregate is selected, place crushed aggregate over geotextile fabric to at least 12 in. depth. A crushed aggregate greater than 3 in. but smaller than 6 in. should be used.

Inspection and Maintenance

- Inspect and verify that activity-based BMPs are in place prior to the commencement of associated activities. While activities associated with the BMP are under way, impact weekly during the rainy season and of two-week intervals in the non-rainy season to verify continued BMP implementation.
- Keep all temporary roadway ditches clear.
- When no longer required, remove stabilized construction roadway and re-grade and repair slopes.
- Periodically apply additional aggregate on gravel roads.
- Active dirt construction roads are commonly watered three or more times per day during the dry season.

Costs

Gravel construction roads are moderately expensive, but cost is often balanced by reductions in construction delay. No additional costs for dust control on construction roads should be required above that needed to meet local air quality requirements.

References

Blueprint for a Clean Bay: Best Management Practices to Prevent Stormwater Pollution from Construction Related Activities; Santa Clara Valley Nonpoint Source Pollution Control Program, 1995.

Coastal Nonpoint Pollution Control Program; Program Development and Approval Guidance, Working Group, Working Paper; USEPA, April 1992.

Manual of Standards of Erosion and Sediment Control Measures, Association of Bay Area Governments, May 1995.

Stormwater Quality Handbooks Construction Site Best Management Practices (BMPs) Manual, State of California Department of Transportation (Caltrans), November 2000.

Stormwater Management for Construction Activities, Developing Pollution Prevention Plans and Best Management Practices, EPA 832-R-92005; USEPA, April 1992.

Stormwater Management of the Puget Sound Basin, Technical Manual, Publication #91-75, Washington State Department of Ecology, February 1992.

Stabilized Construction Roadway **TC-2**

Virginia Erosion and Sedimentation Control Handbook, Virginia Department of Conservation and Recreation, Division of Soil and Water Conservation, 1991.

Water Quality Management Plan for the Lake Tahoe Region, Volume II, Handbook of Management Practices, Tahoe Regional Planning Agency, November 1988.

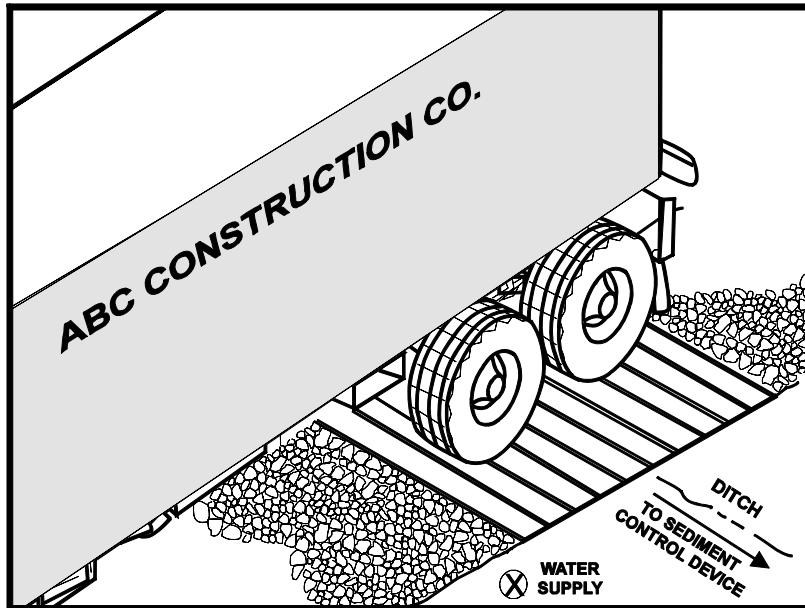

Categories

EC	Erosion Control	
SE	Sediment Control	<input checked="" type="checkbox"/>
TC	Tracking Control	<input checked="" type="checkbox"/>
WE	Wind Erosion Control	
NS	Non-Stormwater Management Control	
WM	Waste Management and Materials Pollution Control	

Legend:

- Primary Objective
- Secondary Objective

Targeted Constituents

Sediment	<input checked="" type="checkbox"/>
Nutrients	
Trash	
Metals	
Bacteria	
Oil and Grease	
Organics	

Potential Alternatives

TC-1 Stabilized Construction Entrance/Exit

Description and Purpose

A tire wash is an area located at stabilized construction access points to remove sediment from tires and undercarriages and to prevent sediment from being transported onto public roadways.

Suitable Applications

Tire washes may be used on construction sites where dirt and mud tracking onto public roads by construction vehicles may occur.

Limitations

- The tire wash requires a supply of wash water.
- A turnout or doublewide exit is required to avoid having entering vehicles drive through the wash area.
- Do not use where wet tire trucks leaving the site leave the road dangerously slick.

Implementation

- Incorporate with a stabilized construction entrance/exit. See TC-1, Stabilized Construction Entrance/Exit.
- Construct on level ground when possible, on a pad of coarse aggregate greater than 3 in. but smaller than 6 in. A geotextile fabric should be placed below the aggregate.
- Wash rack should be designed and constructed/manufactured for anticipated traffic loads.



- Provide a drainage ditch that will convey the runoff from the wash area to a sediment trapping device. The drainage ditch should be of sufficient grade, width, and depth to carry the wash runoff.
- Use hoses with automatic shutoff nozzles to prevent hoses from being left on.
- Require that all employees, subcontractors, and others that leave the site with mud caked tires and undercarriages to use the wash facility.
- Implement SC-7, Street Sweeping and Vacuuming, as needed.

Costs

Costs are low for installation of wash rack.

Inspection and Maintenance

- Inspect and verify that activity-based BMPs are in place prior to the commencement of associated activities. While activities associated with the BMP are under way, inspect weekly during the rainy season and of two-week intervals in the non-rainy season to verify continued BMP implementation.
- Inspect BMPs subject to non-stormwater discharge daily while non-stormwater discharges occur.
- Remove accumulated sediment in wash rack and/or sediment trap to maintain system performance.
- Inspect routinely for damage and repair as needed.

References

Blueprint for a Clean Bay: Best Management Practices to Prevent Stormwater Pollution from Construction Related Activities; Santa Clara Valley Nonpoint Source Pollution Control Program, 1995.

Coastal Nonpoint Pollution Control Program; Program Development and Approval Guidance, Working Group, Working Paper; USEPA, April 1992.

Manual of Standards of Erosion and Sediment Control Measures, Association of Bay Area Governments, May 1995.

Stormwater Quality Handbooks Construction Site Best Management Practices (BMPs) Manual, State of California Department of Transportation (Caltrans), November 2000.

Stormwater Management for Construction Activities, Developing Pollution Prevention Plans and Best Management Practices, EPA 832-R-92005; USEPA, April 1992.

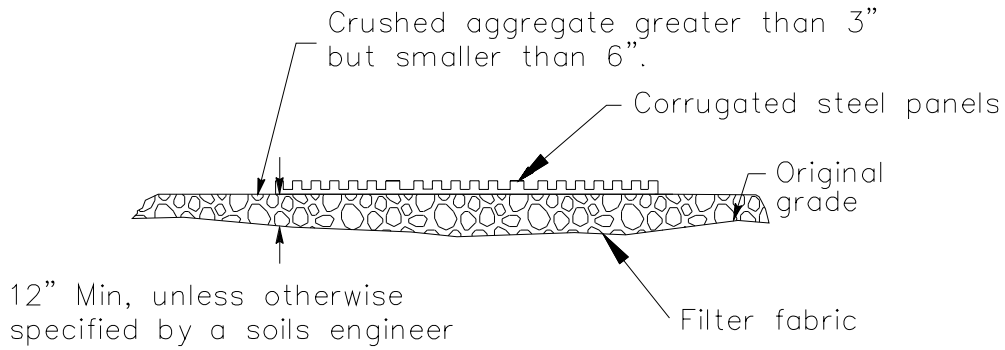

SECTION A-A
NOT TO SCALE

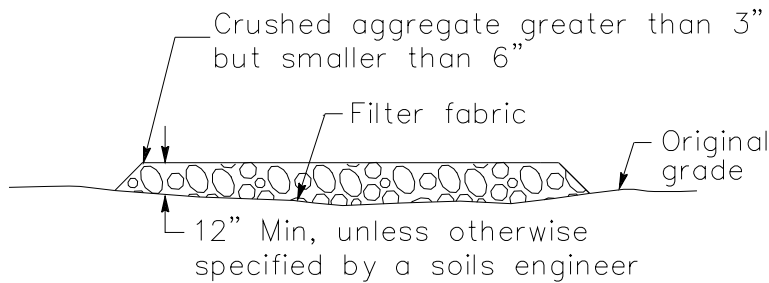

SECTION B-B
NTS

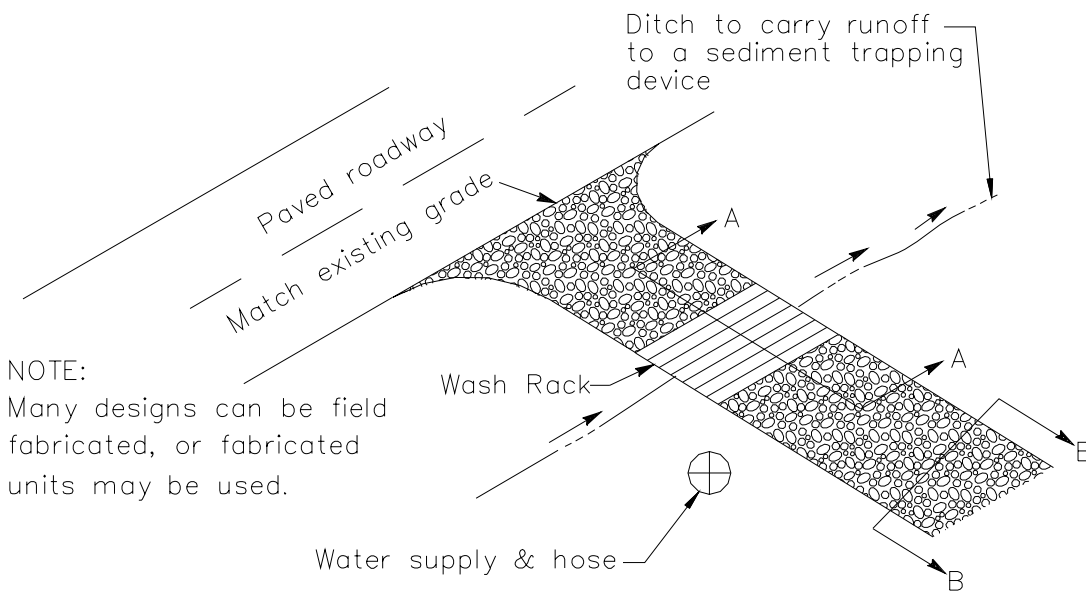

NOTE:
Many designs can be field fabricated, or fabricated units may be used.

TYPICAL TIRE WASH
NOT TO SCALE

This page intentionally left blank

Waste & Materials Management Control [WM]

This page intentionally left blank.

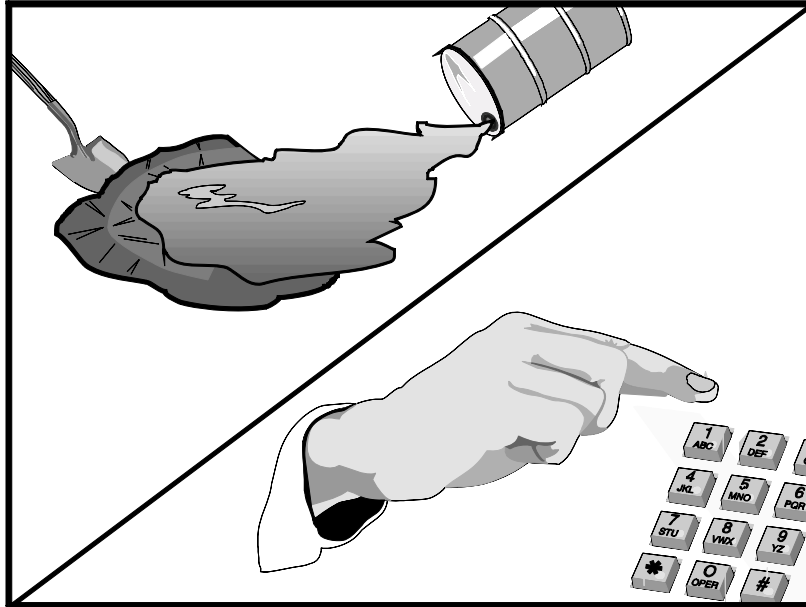

Description and Purpose

Prevent or reduce the discharge of pollutants to drainage systems or watercourses from leaks and spills by reducing the chance for spills, stopping the source of spills, containing and cleaning up spills, properly disposing of spill materials, and training employees.

This best management practice covers only spill prevention and control. However, WM-1, Materials Delivery and Storage, and WM-2, Material Use, also contain useful information, particularly on spill prevention. For information on wastes, see the waste management BMPs in this section.

Suitable Applications

This BMP is suitable for all construction projects. Spill control procedures are implemented anytime chemicals or hazardous substances are stored on the construction site, including the following materials:

- Soil stabilizers/binders
- Dust palliatives
- Herbicides
- Growth inhibitors
- Fertilizers
- Deicing/anti-icing chemicals

Categories

EC	Erosion Control	
SE	Sediment Control	
TC	Tracking Control	
WE	Wind Erosion Control	
NS	Non-Stormwater Management Control	
WM	Waste Management and Materials Pollution Control	<input checked="" type="checkbox"/>

Legend:

- Primary Objective**
- Secondary Objective**

Targeted Constituents

Sediment	<input checked="" type="checkbox"/>
Nutrients	<input checked="" type="checkbox"/>
Trash	<input checked="" type="checkbox"/>
Metals	<input checked="" type="checkbox"/>
Bacteria	
Oil and Grease	<input checked="" type="checkbox"/>
Organics	<input checked="" type="checkbox"/>

Potential Alternatives

None



- Fuels
- Lubricants
- Other petroleum distillates

Limitations

- In some cases it may be necessary to use a private spill cleanup company.
- This BMP applies to spills caused by the contractor and subcontractors.
- Procedures and practices presented in this BMP are general. Contractor should identify appropriate practices for the specific materials used or stored onsite

Implementation

The following steps will help reduce the stormwater impacts of leaks and spills:

Education

- Be aware that different materials pollute in different amounts. Make sure that each employee knows what a “significant spill” is for each material they use, and what is the appropriate response for “significant” and “insignificant” spills.
- Educate employees and subcontractors on potential dangers to humans and the environment from spills and leaks.
- Hold regular meetings to discuss and reinforce appropriate disposal procedures (incorporate into regular safety meetings).
- Establish a continuing education program to indoctrinate new employees.
- Have contractor’s superintendent or representative oversee and enforce proper spill prevention and control measures.

General Measures

- To the extent that the work can be accomplished safely, spills of oil, petroleum products, substances listed under 40 CFR parts 110,117, and 302, and sanitary and septic wastes should be contained and cleaned up immediately.
- Store hazardous materials and wastes in covered containers and protect from vandalism.
- Place a stockpile of spill cleanup materials where it will be readily accessible.
- Train employees in spill prevention and cleanup.
- Designate responsible individuals to oversee and enforce control measures.
- Spills should be covered and protected from stormwater runoff during rainfall to the extent that it doesn’t compromise clean up activities.
- Do not bury or wash spills with water.

- Store and dispose of used clean up materials, contaminated materials, and recovered spill material that is no longer suitable for the intended purpose in conformance with the provisions in applicable BMPs.
- Do not allow water used for cleaning and decontamination to enter storm drains or watercourses. Collect and dispose of contaminated water in accordance with WM-10, Liquid Waste Management.
- Contain water overflow or minor water spillage and do not allow it to discharge into drainage facilities or watercourses.
- Place proper storage, cleanup, and spill reporting instructions for hazardous materials stored or used on the project site in an open, conspicuous, and accessible location.
- Keep waste storage areas clean, well organized, and equipped with ample cleanup supplies as appropriate for the materials being stored. Perimeter controls, containment structures, covers, and liners should be repaired or replaced as needed to maintain proper function.

Cleanup

- Clean up leaks and spills immediately.
- Use a rag for small spills on paved surfaces, a damp mop for general cleanup, and absorbent material for larger spills. If the spilled material is hazardous, then the used cleanup materials are also hazardous and must be sent to either a certified laundry (rags) or disposed of as hazardous waste.
- Never hose down or bury dry material spills. Clean up as much of the material as possible and dispose of properly. See the waste management BMPs in this section for specific information.

Minor Spills

- Minor spills typically involve small quantities of oil, gasoline, paint, etc. which can be controlled by the first responder at the discovery of the spill.
- Use absorbent materials on small spills rather than hosing down or burying the spill.
- Absorbent materials should be promptly removed and disposed of properly.
- Follow the practice below for a minor spill:
 - Contain the spread of the spill.
 - Recover spilled materials.
 - Clean the contaminated area and properly dispose of contaminated materials.

Semi-Significant Spills

- Semi-significant spills still can be controlled by the first responder along with the aid of other personnel such as laborers and the foreman, etc. This response may require the cessation of all other activities.

- Spills should be cleaned up immediately:
 - Contain spread of the spill.
 - Notify the project foreman immediately.
 - If the spill occurs on paved or impermeable surfaces, clean up using "dry" methods (absorbent materials, cat litter and/or rags). Contain the spill by encircling with absorbent materials and do not let the spill spread widely.
 - If the spill occurs in dirt areas, immediately contain the spill by constructing an earthen dike. Dig up and properly dispose of contaminated soil.
 - If the spill occurs during rain, cover spill with tarps or other material to prevent contaminating runoff.

Significant/Hazardous Spills

- For significant or hazardous spills that cannot be controlled by personnel in the immediate vicinity, the following steps should be taken:
 - Notify the local emergency response by dialing 911. In addition to 911, the contractor will notify the proper county officials. It is the contractor's responsibility to have all emergency phone numbers at the construction site.
 - Notify the Governor's Office of Emergency Services Warning Center, (916) 845-8911.
 - For spills of federal reportable quantities, in conformance with the requirements in 40 CFR parts 110,119, and 302, the contractor should notify the National Response Center at (800) 424-8802.
 - Notification should first be made by telephone and followed up with a written report.
 - The services of a spills contractor or a Haz-Mat team should be obtained immediately. Construction personnel should not attempt to clean up until the appropriate and qualified staffs have arrived at the job site.
 - Other agencies which may need to be consulted include, but are not limited to, the Fire Department, the Public Works Department, the Coast Guard, the Highway Patrol, the City/County Police Department, Department of Toxic Substances, California Division of Oil and Gas, Cal/OSHA, etc.

Reporting

- Report significant spills to local agencies, such as the Fire Department; they can assist in cleanup.
- Federal regulations require that any significant oil spill into a water body or onto an adjoining shoreline be reported to the National Response Center (NRC) at 800-424-8802 (24 hours).

Use the following measures related to specific activities:

Vehicle and Equipment Maintenance

- If maintenance must occur onsite, use a designated area and a secondary containment, located away from drainage courses, to prevent the runoff of stormwater and the runoff of spills.
- Regularly inspect onsite vehicles and equipment for leaks and repair immediately
- Check incoming vehicles and equipment (including delivery trucks, and employee and subcontractor vehicles) for leaking oil and fluids. Do not allow leaking vehicles or equipment onsite.
- Always use secondary containment, such as a drain pan or drop cloth, to catch spills or leaks when removing or changing fluids.
- Place drip pans or absorbent materials under paving equipment when not in use.
- Use absorbent materials on small spills rather than hosing down or burying the spill. Remove the absorbent materials promptly and dispose of properly.
- Promptly transfer used fluids to the proper waste or recycling drums. Don't leave full drip pans or other open containers lying around
- Oil filters disposed of in trashcans or dumpsters can leak oil and pollute stormwater. Place the oil filter in a funnel over a waste oil-recycling drum to drain excess oil before disposal. Oil filters can also be recycled. Ask the oil supplier or recycler about recycling oil filters.
- Store cracked batteries in a non-leaking secondary container. Do this with all cracked batteries even if you think all the acid has drained out. If you drop a battery, treat it as if it is cracked. Put it into the containment area until you are sure it is not leaking.

Vehicle and Equipment Fueling

- If fueling must occur onsite, use designate areas, located away from drainage courses, to prevent the runoff of stormwater and the runoff of spills.
- Discourage "topping off" of fuel tanks.
- Always use secondary containment, such as a drain pan, when fueling to catch spills/ leaks.

Costs

Prevention of leaks and spills is inexpensive. Treatment and/ or disposal of contaminated soil or water can be quite expensive.

Inspection and Maintenance

- Inspect and verify that activity-based BMPs are in place prior to the commencement of associated activities. While activities associated with the BMP are under way, inspect weekly during the rainy season and of two-week intervals in the non-rainy season to verify continued BMP implementation.
- Inspect BMPs subject to non-stormwater discharge daily while non-stormwater discharges occur.

- Keep ample supplies of spill control and cleanup materials onsite, near storage, unloading, and maintenance areas.
- Update your spill prevention and control plan and stock cleanup materials as changes occur in the types of chemicals onsite.

References

Blueprint for a Clean Bay: Best Management Practices to Prevent Stormwater Pollution from Construction Related Activities; Santa Clara Valley Nonpoint Source Pollution Control Program, 1995.

Stormwater Quality Handbooks - Construction Site Best Management Practices (BMPs) Manual, State of California Department of Transportation (Caltrans), November 2000.

Stormwater Management for Construction Activities; Developing Pollution Prevention Plans and Best Management Practice, EPA 832-R-92005; USEPA, April 1992.

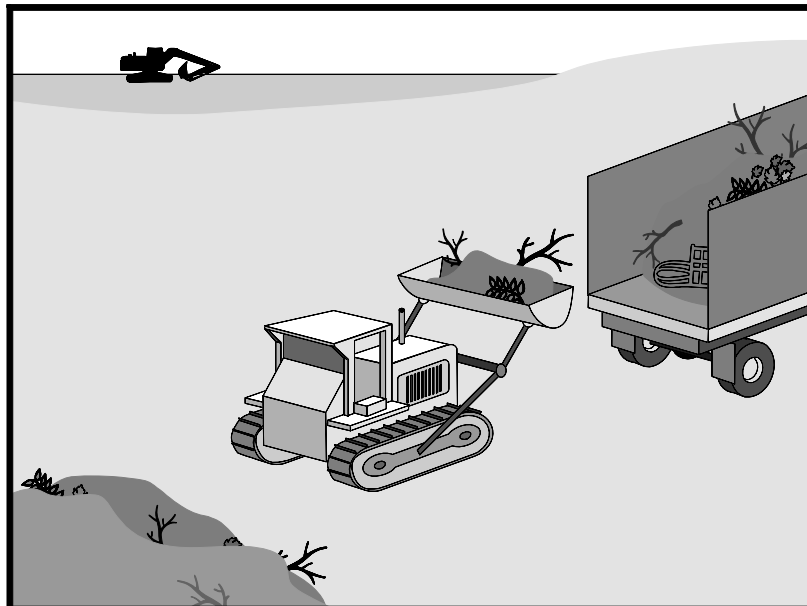

Description and Purpose

Solid waste management procedures and practices are designed to prevent or reduce the discharge of pollutants to stormwater from solid or construction waste by providing designated waste collection areas and containers, arranging for regular disposal, and training employees and subcontractors.

Suitable Applications

This BMP is suitable for construction sites where the following wastes are generated or stored:

- Solid waste generated from trees and shrubs removed during land clearing, demolition of existing structures (rubble), and building construction
- Packaging materials including wood, paper, and plastic
- Scrap or surplus building materials including scrap metals, rubber, plastic, glass pieces and masonry products
- Domestic wastes including food containers such as beverage cans, coffee cups, paper bags, plastic wrappers, and cigarettes
- Construction wastes including brick, mortar, timber, steel and metal scraps, pipe and electrical cuttings, non-hazardous equipment parts, styrofoam and other materials used to transport and package construction materials
- Highway planting wastes, including vegetative material,

Categories

EC	Erosion Control	
SE	Sediment Control	
TC	Tracking Control	
WE	Wind Erosion Control	
NS	Non-Stormwater Management Control	
WM	Waste Management and Materials Pollution Control	<input checked="" type="checkbox"/>

Legend:

- Primary Objective
- Secondary Objective

Targeted Constituents

Sediment	<input checked="" type="checkbox"/>
Nutrients	<input checked="" type="checkbox"/>
Trash	<input checked="" type="checkbox"/>
Metals	<input checked="" type="checkbox"/>
Bacteria	
Oil and Grease	<input checked="" type="checkbox"/>
Organics	<input checked="" type="checkbox"/>

Potential Alternatives

None



plant containers, and packaging materials

Limitations

Temporary stockpiling of certain construction wastes may not necessitate stringent drainage related controls during the non-rainy season or in desert areas with low rainfall.

Implementation

The following steps will help keep a clean site and reduce stormwater pollution:

- Select designated waste collection areas onsite.
- Inform trash-hauling contractors that you will accept only watertight dumpsters for onsite use. Inspect dumpsters for leaks and repair any dumpster that is not watertight.
- Locate containers in a covered area or in a secondary containment.
- Provide an adequate number of containers with lids or covers that can be placed over the container to keep rain out or to prevent loss of wastes when it is windy.
- Plan for additional containers and more frequent pickup during the demolition phase of construction.
- Collect site trash daily, especially during rainy and windy conditions.
- Remove this solid waste promptly since erosion and sediment control devices tend to collect litter.
- Make sure that toxic liquid wastes (used oils, solvents, and paints) and chemicals (acids, pesticides, additives, curing compounds) are not disposed of in dumpsters designated for construction debris.
- Do not hose out dumpsters on the construction site. Leave dumpster cleaning to the trash hauling contractor.
- Arrange for regular waste collection before containers overflow.
- Clean up immediately if a container does spill.
- Make sure that construction waste is collected, removed, and disposed of only at authorized disposal areas.

Education

- Have the contractor's superintendent or representative oversee and enforce proper solid waste management procedures and practices.
- Instruct employees and subcontractors on identification of solid waste and hazardous waste.
- Educate employees and subcontractors on solid waste storage and disposal procedures.
- Hold regular meetings to discuss and reinforce disposal procedures (incorporate into regular safety meetings).

- Require that employees and subcontractors follow solid waste handling and storage procedures.
- Prohibit littering by employees, subcontractors, and visitors.
- Minimize production of solid waste materials wherever possible.

Collection, Storage, and Disposal

- Littering on the project site should be prohibited.
- To prevent clogging of the storm drainage system, litter and debris removal from drainage grates, trash racks, and ditch lines should be a priority.
- Trash receptacles should be provided in the contractor's yard, field trailer areas, and at locations where workers congregate for lunch and break periods.
- Litter from work areas within the construction limits of the project site should be collected and placed in watertight dumpsters at least weekly, regardless of whether the litter was generated by the contractor, the public, or others. Collected litter and debris should not be placed in or next to drain inlets, stormwater drainage systems, or watercourses.
- Dumpsters of sufficient size and number should be provided to contain the solid waste generated by the project.
- Full dumpsters should be removed from the project site and the contents should be disposed of by the trash hauling contractor.
- Construction debris and waste should be removed from the site biweekly or more frequently as needed.
- Construction material visible to the public should be stored or stacked in an orderly manner.
- Stormwater runoff should be prevented from contacting stored solid waste through the use of berms, dikes, or other temporary diversion structures or through the use of measures to elevate waste from site surfaces.
- Solid waste storage areas should be located at least 50 ft from drainage facilities and watercourses and should not be located in areas prone to flooding or ponding.
- Except during fair weather, construction and highway planting waste not stored in watertight dumpsters should be securely covered from wind and rain by covering the waste with tarps or plastic.
- Segregate potentially hazardous waste from non-hazardous construction site waste.
- Make sure that toxic liquid wastes (used oils, solvents, and paints) and chemicals (acids, pesticides, additives, curing compounds) are not disposed of in dumpsters designated for construction debris.
- For disposal of hazardous waste, see WM-6, Hazardous Waste Management. Have hazardous waste hauled to an appropriate disposal and/or recycling facility.

- Salvage or recycle useful vegetation debris, packaging and surplus building materials when practical. For example, trees and shrubs from land clearing can be used as a brush barrier, or converted into wood chips, then used as mulch on graded areas. Wood pallets, cardboard boxes, and construction scraps can also be recycled.

Costs

All of the above are low cost measures.

Inspection and Maintenance

- Inspect and verify that activity-based BMPs are in place prior to the commencement of associated activities. While activities associated with the BMP are under way, inspect weekly during the rainy season and of two-week intervals in the non-rainy season to verify continued BMP implementation.
- Inspect BMPs subject to non-stormwater discharge daily while non-stormwater discharges occur
- Inspect construction waste area regularly.
- Arrange for regular waste collection.

References

Processes, Procedures and Methods to Control Pollution Resulting from All Construction Activity, 430/9-73-007, USEPA, 1973.

Stormwater Quality Handbooks - Construction Site Best Management Practices (BMPs) Manual, State of California Department of Transportation (Caltrans), November 2000.

Stormwater Management for Construction Activities; Developing Pollution Prevention Plans and Best Management Practice, EPA 832-R-92005; USEPA, April 1992.

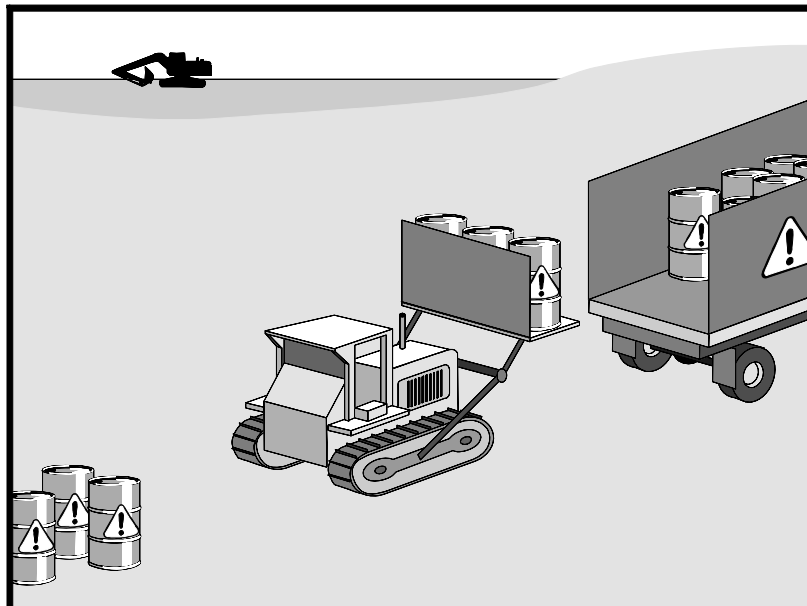

Categories

EC	Erosion Control	
SE	Sediment Control	
TC	Tracking Control	
WE	Wind Erosion Control	
NS	Non-Stormwater Management Control	
WM	Waste Management and Materials Pollution Control	<input checked="" type="checkbox"/>

Legend:

- Primary Objective**
- Secondary Objective**

Description and Purpose

Prevent or reduce the discharge of pollutants to stormwater from hazardous waste through proper material use, waste disposal, and training of employees and subcontractors.

Suitable Applications

This best management practice (BMP) applies to all construction projects. Hazardous waste management practices are implemented on construction projects that generate waste from the use of:

- Petroleum Products
- Concrete Curing Compounds
- Palliatives
- Septic Wastes
- Stains
- Wood Preservatives
- Asphalt Products
- Pesticides
- Acids
- Paints
- Solvents
- Roofing Tar
- Any materials deemed a hazardous waste in California, Title 22 Division 4.5, or listed in 40 CFR Parts 110, 117, 261, or 302

Targeted Constituents

Sediment	
Nutrients	<input checked="" type="checkbox"/>
Trash	<input checked="" type="checkbox"/>
Metals	<input checked="" type="checkbox"/>
Bacteria	<input checked="" type="checkbox"/>
Oil and Grease	<input checked="" type="checkbox"/>
Organics	<input checked="" type="checkbox"/>

Potential Alternatives

None



In addition, sites with existing structures may contain wastes, which must be disposed of in accordance with federal, state, and local regulations. These wastes include:

- Sandblasting grit mixed with lead-, cadmium-, or chromium-based paints
- Asbestos
- PCBs (particularly in older transformers)

Limitations

- Hazardous waste that cannot be reused or recycled must be disposed of by a licensed hazardous waste hauler.
- Nothing in this BMP relieves the contractor from responsibility for compliance with federal, state, and local laws regarding storage, handling, transportation, and disposal of hazardous wastes.
- This BMP does not cover aerially deposited lead (ADL) soils. For ADL soils refer to WM-7, Contaminated Soil Management.

Implementation

The following steps will help reduce stormwater pollution from hazardous wastes:

Material Use

- Wastes should be stored in sealed containers constructed of a suitable material and should be labeled as required by Title 22 CCR, Division 4.5 and 49 CFR Parts 172, 173, 178, and 179.
- All hazardous waste should be stored, transported, and disposed as required in Title 22 CCR, Division 4.5 and 49 CFR 261-263.
- Waste containers should be stored in temporary containment facilities that should comply with the following requirements:
 - Temporary containment facility should provide for a spill containment volume equal to 1.5 times the volume of all containers able to contain precipitation from a 25 year storm event, plus the greater of 10% of the aggregate volume of all containers or 100% of the capacity of the largest tank within its boundary, whichever is greater.
 - Temporary containment facility should be impervious to the materials stored there for a minimum contact time of 72 hours.
 - Temporary containment facilities should be maintained free of accumulated rainwater and spills. In the event of spills or leaks, accumulated rainwater and spills should be placed into drums after each rainfall. These liquids should be handled as a hazardous waste unless testing determines them to be non-hazardous. Non-hazardous liquids should be sent to an approved disposal site.
 - Sufficient separation should be provided between stored containers to allow for spill cleanup and emergency response access.

- Incompatible materials, such as chlorine and ammonia, should not be stored in the same temporary containment facility.
- Throughout the rainy season, temporary containment facilities should be covered during non-working days, and prior to rain events. Covered facilities may include use of plastic tarps for small facilities or constructed roofs with overhangs.
- Drums should not be overfilled and wastes should not be mixed.
- Unless watertight, containers of dry waste should be stored on pallets.
- Do not over-apply herbicides and pesticides. Prepare only the amount needed. Follow the recommended usage instructions. Over application is expensive and environmentally harmful. Apply surface dressings in several smaller applications, as opposed to one large application. Allow time for infiltration and avoid excess material being carried offsite by runoff. Do not apply these chemicals just before it rains. People applying pesticides must be certified in accordance with federal and state regulations.
- Paint brushes and equipment for water and oil based paints should be cleaned within a contained area and should not be allowed to contaminate site soils, watercourses, or drainage systems. Waste paints, thinners, solvents, residues, and sludges that cannot be recycled or reused should be disposed of as hazardous waste. When thoroughly dry, latex paint and paint cans, used brushes, rags, absorbent materials, and drop cloths should be disposed of as solid waste.
- Do not clean out brushes or rinse paint containers into the dirt, street, gutter, storm drain, or stream. "Paint out" brushes as much as possible. Rinse water-based paints to the sanitary sewer. Filter and reuse thinners and solvents. Dispose of excess oil-based paints and sludge as hazardous waste.
- The following actions should be taken with respect to temporary contaminant:
 - Ensure that adequate hazardous waste storage volume is available.
 - Ensure that hazardous waste collection containers are conveniently located.
 - Designate hazardous waste storage areas onsite away from storm drains or watercourses and away from moving vehicles and equipment to prevent accidental spills.
 - Minimize production or generation of hazardous materials and hazardous waste on the job site.
 - Use containment berms in fueling and maintenance areas and where the potential for spills is high.
 - Segregate potentially hazardous waste from non-hazardous construction site debris.
 - Keep liquid or semi-liquid hazardous waste in appropriate containers (closed drums or similar) and under cover.

- Clearly label all hazardous waste containers with the waste being stored and the date of accumulation.
- Place hazardous waste containers in secondary containment.
- Do not allow potentially hazardous waste materials to accumulate on the ground.
- Do not mix wastes.
- Use all of the product before disposing of the container.
- Do not remove the original product label; it contains important safety and disposal information.

Waste Recycling Disposal

- Select designated hazardous waste collection areas onsite.
- Hazardous materials and wastes should be stored in covered containers and protected from vandalism.
- Place hazardous waste containers in secondary containment.
- Do not mix wastes, this can cause chemical reactions, making recycling impossible and complicating disposal.
- Recycle any useful materials such as used oil or water-based paint.
- Make sure that toxic liquid wastes (used oils, solvents, and paints) and chemicals (acids, pesticides, additives, curing compounds) are not disposed of in dumpsters designated for construction debris.
- Arrange for regular waste collection before containers overflow.
- Make sure that hazardous waste (e.g., excess oil-based paint and sludge) is collected, removed, and disposed of only at authorized disposal areas.

Disposal Procedures

- Waste should be disposed of by a licensed hazardous waste transporter at an authorized and licensed disposal facility or recycling facility utilizing properly completed Uniform Hazardous Waste Manifest forms.
- A Department of Health Services certified laboratory should sample waste to determine the appropriate disposal facility.
- Properly dispose of rainwater in secondary containment that may have mixed with hazardous waste.
- Attention is directed to "Hazardous Material", "Contaminated Material", and "Aerially Deposited Lead" of the contract documents regarding the handling and disposal of hazardous materials.

Education

- Educate employees and subcontractors on hazardous waste storage and disposal procedures.
- Educate employees and subcontractors on potential dangers to humans and the environment from hazardous wastes.
- Instruct employees and subcontractors on safety procedures for common construction site hazardous wastes.
- Instruct employees and subcontractors in identification of hazardous and solid waste.
- Hold regular meetings to discuss and reinforce hazardous waste management procedures (incorporate into regular safety meetings).
- The contractor's superintendent or representative should oversee and enforce proper hazardous waste management procedures and practices.
- Make sure that hazardous waste is collected, removed, and disposed of only at authorized disposal areas.
- Warning signs should be placed in areas recently treated with chemicals.
- Place a stockpile of spill cleanup materials where it will be readily accessible.
- If a container does spill, clean up immediately.

Costs

All of the above are low cost measures.

Inspection and Maintenance

- Inspect and verify that activity-based BMPs are in place prior to the commencement of associated activities. While activities associated with the BMP are under way, inspect weekly during the rainy season and of two week intervals in the non-rainy season to verify continued BMP implementation.
- Inspect BMPs subject to non-stormwater discharge daily while non-stormwater discharges occur
- Hazardous waste should be regularly collected.
- A foreman or construction supervisor should monitor onsite hazardous waste storage and disposal procedures.
- Waste storage areas should be kept clean, well organized, and equipped with ample cleanup supplies as appropriate for the materials being stored.
- Perimeter controls, containment structures, covers, and liners should be repaired or replaced as needed to maintain proper function.
- Hazardous spills should be cleaned up and reported in conformance with the applicable Material Safety Data Sheet (MSDS) and the instructions posted at the project site.

- The National Response Center, at (800) 424-8802, should be notified of spills of federal reportable quantities in conformance with the requirements in 40 CFR parts 110, 117, and 302. Also notify the Governors Office of Emergency Services Warning Center at (916) 845-8911.
- A copy of the hazardous waste manifests should be provided.

References

Blueprint for a Clean Bay: Best Management Practices to Prevent Stormwater Pollution from Construction Related Activities; Santa Clara Valley Nonpoint Source Pollution Control Program, 1995.

Processes, Procedures and Methods to Control Pollution Resulting from All Construction Activity, 430/9-73-007, USEPA, 1973.

Stormwater Quality Handbooks - Construction Site Best Management Practices (BMPs) Manual, State of California Department of Transportation (Caltrans), November 2000.

Stormwater Management for Construction Activities; Developing Pollution Prevention Plans and Best Management Practice, EPA 832-R-92005; USEPA, April 1992.



Categories

EC	Erosion Control	
SE	Sediment Control	
TC	Tracking Control	
WE	Wind Erosion Control	
NS	Non-Stormwater Management Control	
WM	Waste Management and Materials Pollution Control	<input checked="" type="checkbox"/>

Legend:

- Primary Objective
- Secondary Objective

Description and Purpose

Prevent or reduce the discharge of pollutants to stormwater from contaminated soil and highly acidic or alkaline soils by conducting pre-construction surveys, inspecting excavations regularly, and remediating contaminated soil promptly.

Suitable Applications

Contaminated soil management is implemented on construction projects in highly urbanized or industrial areas where soil contamination may have occurred due to spills, illicit discharges, aerial deposition, past use and leaks from underground storage tanks.

Limitations

Contaminated soils that cannot be treated onsite must be disposed of offsite by a licensed hazardous waste hauler. The presence of contaminated soil may indicate contaminated water as well. See NS-2, Dewatering Operations, for more information.

The procedures and practices presented in this BMP are general. The contractor should identify appropriate practices and procedures for the specific contaminants known to exist or discovered onsite.

Implementation

Most owners and developers conduct pre-construction environmental assessments as a matter of routine. Contaminated soils are often identified during project planning and development with known locations identified in the plans, specifications and in the SWPPP. The contractor should review applicable reports and investigate appropriate call-outs in the

Targeted Constituents

Sediment	
Nutrients	<input checked="" type="checkbox"/>
Trash	<input checked="" type="checkbox"/>
Metals	<input checked="" type="checkbox"/>
Bacteria	<input checked="" type="checkbox"/>
Oil and Grease	<input checked="" type="checkbox"/>
Organics	<input checked="" type="checkbox"/>

Potential Alternatives

None



plans, specifications, and SWPPP. Recent court rulings holding contractors liable for cleanup costs when they unknowingly move contaminated soil highlight the need for contractors to confirm a site assessment is completed before earth moving begins.

The following steps will help reduce stormwater pollution from contaminated soil:

- Conduct thorough, pre-construction inspections of the site and review documents related to the site. If inspection or reviews indicated presence of contaminated soils, develop a plan before starting work.
- Look for contaminated soil as evidenced by discoloration, odors, differences in soil properties, abandoned underground tanks or pipes, or buried debris.
- Prevent leaks and spills. Contaminated soil can be expensive to treat and dispose of properly. However, addressing the problem before construction is much less expensive than after the structures are in place.
- The contractor may further identify contaminated soils by investigating:
 - Past site uses and activities
 - Detected or undetected spills and leaks
 - Acid or alkaline solutions from exposed soil or rock formations high in acid or alkaline forming elements
 - Contaminated soil as evidenced by discoloration, odors, differences in soil properties, abandoned underground tanks or pipes, or buried debris.
 - Suspected soils should be tested at a certified laboratory.

Education

- Have employees and subcontractors complete a safety training program which meets 29 CFR 1910.120 and 8 CCR 5192 covering the potential hazards as identified, prior to performing any excavation work at the locations containing material classified as hazardous.
- Educate employees and subcontractors in identification of contaminated soil and on contaminated soil handling and disposal procedures.
- Hold regular meetings to discuss and reinforce disposal procedures (incorporate into regular safety meetings).

Handling Procedures for Material with Aerially Deposited Lead (ADL)

- Materials from areas designated as containing (ADL) may, if allowed by the contract special provisions, be excavated, transported, and used in the construction of embankments and/or backfill.
- Excavation, transportation, and placement operations should result in no visible dust.
- Caution should be exercised to prevent spillage of lead containing material during transport.

- Quality should be monitored during excavation of soils contaminated with lead.

Handling Procedures for Contaminated Soils

- Minimize onsite storage. Contaminated soil should be disposed of properly in accordance with all applicable regulations. All hazardous waste storage will comply with the requirements in Title 22, CCR, Sections 66265.250 to 66265.260.
- Test suspected soils at an approved certified laboratory.
- Work with the local regulatory agencies to develop options for treatment or disposal if the soil is contaminated.
- Avoid temporary stockpiling of contaminated soils or hazardous material.
- Take the following precautions if temporary stockpiling is necessary:
 - Cover the stockpile with plastic sheeting or tarps.
 - Install a berm around the stockpile to prevent runoff from leaving the area.
 - Do not stockpile in or near storm drains or watercourses.
- Remove contaminated material and hazardous material on exteriors of transport vehicles and place either into the current transport vehicle or into the excavation prior to the vehicle leaving the exclusion zone.
- Monitor the air quality continuously during excavation operations at all locations containing hazardous material.
- Procure all permits and licenses, pay all charges and fees, and give all notices necessary and incident to the due and lawful prosecution of the work, including registration for transporting vehicles carrying the contaminated material and the hazardous material.
- Collect water from decontamination procedures and treat or dispose of it at an appropriate disposal site.
- Collect non-reusable protective equipment, once used by any personnel, and dispose of at an appropriate disposal site.
- Install temporary security fence to surround and secure the exclusion zone. Remove fencing when no longer needed.
- Excavate, transport, and dispose of contaminated material and hazardous material in accordance with the rules and regulations of the following agencies (the specifications of these agencies supersede the procedures outlined in this BMP):
 - United States Department of Transportation (USDOT)
 - United States Environmental Protection Agency (USEPA)
 - California Environmental Protection Agency (CAL-EPA)

- California Division of Occupation Safety and Health Administration (CAL-OSHA)
- Local regulatory agencies

Procedures for Underground Storage Tank Removals

- Prior to commencing tank removal operations, obtain the required underground storage tank removal permits and approval from the federal, state, and local agencies that have jurisdiction over such work.
- To determine if it contains hazardous substances, arrange to have tested, any liquid or sludge found in the underground tank prior to its removal.
- Following the tank removal, take soil samples beneath the excavated tank and perform analysis as required by the local agency representative(s).
- The underground storage tank, any liquid or sludge found within the tank, and all contaminated substances and hazardous substances removed during the tank removal and transported to disposal facilities permitted to accept such waste.

Water Control

- All necessary precautions and preventive measures should be taken to prevent the flow of water, including ground water, from mixing with hazardous substances or underground storage tank excavations. Such preventative measures may consist of, but are not limited to, berms, cofferdams, grout curtains, freeze walls, and seal course concrete or any combination thereof.
- If water does enter an excavation and becomes contaminated, such water, when necessary to proceed with the work, should be discharged to clean, closed top, watertight transportable holding tanks, treated, and disposed of in accordance with federal, state, and local laws.

Costs

Prevention of leaks and spills is inexpensive. Treatment or disposal of contaminated soil can be quite expensive.

Inspection and Maintenance

- Inspect and verify that activity-based BMPs are in place prior to the commencement of associated activities. While activities associated with the BMP are under way, inspect weekly during the rainy season and of two-week intervals in the non-rainy season to verify continued BMP implementation.
- Arrange for contractor's Water Pollution Control Manager, foreman, and/or construction supervisor to monitor onsite contaminated soil storage and disposal procedures.
- Monitor air quality continuously during excavation operations at all locations containing hazardous material.
- Coordinate contaminated soils and hazardous substances/waste management with the appropriate federal, state, and local agencies.

- Implement WM-4, Spill Prevention and Control, to prevent leaks and spills as much as possible.

References

Blueprint for a Clean Bay: Best Management Practices to Prevent Stormwater Pollution from Construction Related Activities; Santa Clara Valley Nonpoint Source Pollution Control Program, 1995.

Processes, Procedures and Methods to Control Pollution Resulting from All Construction Activity, 430/9-73-007, USEPA, 1973.

Stormwater Quality Handbooks - Construction Site Best Management Practices (BMPs) Manual, State of California Department of Transportation (Caltrans), November 2000.

Stormwater Management for Construction Activities; Developing Pollution Prevention Plans and Best Management Practice, EPA 832-R-92005; USEPA, April 1992.

This page intentionally left blank

General Stormwater Management [SC]

This page intentionally left blank.

Description

Promote efficient and safe housekeeping practices (storage, use, and cleanup) when handling potentially harmful materials such as fertilizers, pesticides, cleaning solutions, paint products, automotive products, and swimming pool chemicals. Related information is provided in BMP fact sheets SC-11 Spill Prevention, Control & Cleanup and SC-34 Waste Handling & Disposal.

Approach

Pollution Prevention

- Purchase only the amount of material that will be needed for foreseeable use. In most cases this will result in cost savings in both purchasing and disposal. See SC-61 Safer Alternative Products for additional information.
- Be aware of new products that may do the same job with less environmental risk and for less or the equivalent cost. Total cost must be used here; this includes purchase price, transportation costs, storage costs, use related costs, clean up costs and disposal costs.

Suggested Protocols

General

- Keep work sites clean and orderly. Remove debris in a timely fashion. Sweep the area.
- Dispose of wash water, sweepings, and sediments, properly.
- Recycle or dispose of fluids properly.
- Establish a daily checklist of office, yard and plant areas to confirm cleanliness and adherence to proper storage and security. Specific employees should be assigned specific inspection responsibilities and given the authority to remedy any problems found.
- Post waste disposal charts in appropriate locations detailing for each waste its hazardous nature (poison, corrosive, flammable), prohibitions on its disposal (dumpster, drain, sewer) and the recommended disposal method (recycle, sewer, burn, storage, landfill).
- Summarize the chosen BMPs applicable to your operation and post them in appropriate conspicuous places.

Objectives

- Cover
- Contain
- Educate
- Reduce/Minimize
- Product Substitution

Targeted Constituents

Sediment	<input checked="" type="checkbox"/>
Nutrients	<input checked="" type="checkbox"/>
Trash	<input checked="" type="checkbox"/>
Metals	<input checked="" type="checkbox"/>
Bacteria	<input checked="" type="checkbox"/>
Oil and Grease	<input checked="" type="checkbox"/>
Organics	<input checked="" type="checkbox"/>
Oxygen Demanding	<input checked="" type="checkbox"/>



- Require a signed checklist from every user of any hazardous material detailing amount taken, amount used, amount returned and disposal of spent material.
- Do a before audit of your site to establish baseline conditions and regular subsequent audits to note any changes and whether conditions are improving or deteriorating.
- Keep records of water, air and solid waste quantities and quality tests and their disposition.
- Maintain a mass balance of incoming, outgoing and on hand materials so you know when there are unknown losses that need to be tracked down and accounted for.
- Use and reward employee suggestions related to BMPs, hazards, pollution reduction, work place safety, cost reduction, alternative materials and procedures, recycling and disposal.
- Have, and review regularly, a contingency plan for spills, leaks, weather extremes etc. Make sure all employees know about it and what their role is so that it comes into force automatically.

Training

- Train all employees, management, office, yard, manufacturing, field and clerical in BMPs and pollution prevention and make them accountable.
- Train municipal employees who handle potentially harmful materials in good housekeeping practices.
- Train personnel who use pesticides in the proper use of the pesticides. The California Department of Pesticide Regulation license pesticide dealers, certify pesticide applicators and conduct onsite inspections.
- Train employees and contractors in proper techniques for spill containment and cleanup. The employee should have the tools and knowledge to immediately begin cleaning up a spill if one should occur.

Spill Response and Prevention

- Refer to SC-11, Spill Prevention, Control & Cleanup.
- Keep your Spill Prevention Control and Countermeasure (SPCC) plan up-to-date, and implement accordingly.
- Have spill cleanup materials readily available and in a known location.
- Cleanup spills immediately and use dry methods if possible.
- Properly dispose of spill cleanup material.

Other Considerations

- There are no major limitations to this best management practice.
- There are no regulatory requirements to this BMP. Existing regulations already require municipalities to properly store, use, and dispose of hazardous materials

Requirements

Costs

- Minimal cost associated with this BMP. Implementation of good housekeeping practices may result in cost savings as these procedures may reduce the need for more costly BMPs.

Maintenance

- Ongoing maintenance required to keep a clean site. Level of effort is a function of site size and type of activities.

Supplemental Information

Further Detail of the BMP

- The California Integrated Waste Management Board's Recycling Hotline, 1-800-553-2962, provides information on household hazardous waste collection programs and facilities.

Examples

There are a number of communities with effective programs. The most pro-active include Santa Clara County and the City of Palo Alto, the City and County of San Francisco, and the Municipality of Metropolitan Seattle (Metro).

References and Resources

British Columbia Lake Stewardship Society. Best Management Practices to Protect Water Quality from Non-Point Source Pollution. March 2000.

<http://www.nalms.org/bclss/bmphome.html#bmp>

King County Stormwater Pollution Control Manual - <http://dnr.metrokc.gov/wlr/dss/spcm.htm>

Model Urban Runoff Program: A How-To Guide for Developing Urban Runoff Programs for Small Municipalities, Prepared by City of Monterey, City of Santa Cruz, California Coastal Commission, Monterey Bay National Marine Sanctuary, Association of Monterey Bay Area Governments, Woodward-Clyde, Central Coast Regional Water Quality Control Board. July, 1998, Revised by California Coastal Commission, February 2002.

Orange County Stormwater Program

http://www.ocwatersheds.com/stormwater/swp_introduction.asp

San Mateo STOPPP - (<http://stoppp.tripod.com/bmp.html>)

This page intentionally left blank

Appendix B Project Water Diversion Plan Form

This page intentionally left blank.

APPENDIX B
PROJECT WATER DIVERSION PLAN FORM
 LOS ANGELES COUNTY DEPARTMENT OF PUBLIC WORKS
 FLOOD CONTROL DISTRICT

PROJECT INFORMATION

Project Name:	Reach No:
Location:	Channel:
Project Cost:	Watershed:
Project Type: <input type="checkbox"/> Maintenance <input type="checkbox"/> Repair <input type="checkbox"/> Emergency	
Project Description/Scope (including planning decisions, short narrative of water flow through the diversion, etc.):	

PROJECT SCHEDULE

Plan Completion Date:	Plan Approval Date:
Project Start Date:	Project Completion Date:
Water Quality Monitoring Start:	Water Quality Monitoring End:
DIVERSION	
<u>Description (Phase/Component 1):</u>	

Diversion Start:	Diversion End:
<u>Description (Phase/Component 2):</u>	

Diversion Start:	Diversion End:
<u>Description (Phase/Component 3):</u>	

APPENDIX B
PROJECT WATER DIVERSION PLAN FORM
 LOS ANGELES COUNTY DEPARTMENT OF PUBLIC WORKS
 FLOOD CONTROL DISTRICT

PROJECT DETAIL

<p>Channel Type:</p> <p><input type="checkbox"/> Concrete-Lined <input type="checkbox"/> Trap <input type="checkbox"/> U-Shape</p> <p><input type="checkbox"/> Soft-Bottom</p> <p>Tidal Zone: <input type="checkbox"/> Yes <input type="checkbox"/> No</p>	<p>Containment Type:</p> <p><input type="checkbox"/> Transverse Barrier</p> <p><input type="checkbox"/> Longitudinal Barrier</p>
<p>Channel Specifics:</p> <p>Bottom Width (feet): _____</p> <p>Bank Height (feet): _____</p> <p>Flow Rate (cfs): _____</p>	<p>Barrier Type:</p> <p><input type="checkbox"/> Earthen Berm</p> <p><input type="checkbox"/> Sand/Gravel Bag Berm</p> <p><input type="checkbox"/> Aqua-Barrier</p> <p><input type="checkbox"/> Portadam™</p> <p><input type="checkbox"/> K-Rail</p> <p><input type="checkbox"/> Sheet-Pile</p>
<p>Conveyance Requirement:</p> <p><input type="checkbox"/> Pipe (diameter: _____ feet)</p> <p><input type="checkbox"/> Channel (width: _____ feet (depth: _____ feet (freeboard: _____ feet)</p>	

PROJECT PLANNING

<p><input type="checkbox"/> "Sensitive species restrictions" have been identified in the Project reach:</p> <p>List of sensitive species:</p> <p>_____</p> <p>_____</p> <p>_____</p> <p>_____</p> <p>_____</p> <p>_____</p> <p>_____</p> <p>_____</p>	<p>Discussion of how other identified concerns are being addressed:</p> <p>_____</p> <p>_____</p> <p>_____</p> <p>_____</p> <p>_____</p> <p>_____</p> <p>_____</p> <p>_____</p>
<p><input type="checkbox"/> A water diversion has been conducted in the Project reach previously.</p> <p>Discussion of how prior water diversion information was used in the planning of this Project:</p> <p>_____</p> <p>_____</p> <p>_____</p> <p>_____</p>	

APPENDIX B
PROJECT WATER DIVERSION PLAN FORM
 LOS ANGELES COUNTY DEPARTMENT OF PUBLIC WORKS
 FLOOD CONTROL DISTRICT

WORK REQUIREMENTS

<p>Work Area:</p> <p><input type="checkbox"/> Whole Channel Bottom (feet: _____)</p> <p><input type="checkbox"/> Left Side of Channel (feet: _____)</p> <p><input type="checkbox"/> Right Side of Channel (feet: _____)</p> <p><input type="checkbox"/> Center of Channel (feet: _____)</p>	<p>Maintenance Activity:</p> <p><input type="checkbox"/> Sediment Removal</p> <p><input type="checkbox"/> Vegetation Clearance</p> <p><input type="checkbox"/> Invert Repair</p> <p><input type="checkbox"/> Other: _____</p>		
<p>Activity:</p> <table style="width: 100%;"> <tr> <td style="width: 50%; vertical-align: top;"> <p><input type="checkbox"/> Channel Wall Repair</p> <p><input type="checkbox"/> Drop-Structure Repair</p> <p><input type="checkbox"/> Invert Repair</p> <p><input type="checkbox"/> Other: _____</p> </td> <td style="width: 50%; vertical-align: top;"> <p><input type="checkbox"/> Sediment Removal</p> <p><input type="checkbox"/> Undercut Levees</p> <p><input type="checkbox"/> Outlet Structure Repair</p> </td> </tr> </table>		<p><input type="checkbox"/> Channel Wall Repair</p> <p><input type="checkbox"/> Drop-Structure Repair</p> <p><input type="checkbox"/> Invert Repair</p> <p><input type="checkbox"/> Other: _____</p>	<p><input type="checkbox"/> Sediment Removal</p> <p><input type="checkbox"/> Undercut Levees</p> <p><input type="checkbox"/> Outlet Structure Repair</p>
<p><input type="checkbox"/> Channel Wall Repair</p> <p><input type="checkbox"/> Drop-Structure Repair</p> <p><input type="checkbox"/> Invert Repair</p> <p><input type="checkbox"/> Other: _____</p>	<p><input type="checkbox"/> Sediment Removal</p> <p><input type="checkbox"/> Undercut Levees</p> <p><input type="checkbox"/> Outlet Structure Repair</p>		

BEST MANAGEMENT PRACTICES

<p><input type="checkbox"/> EC-1 Scheduling</p> <p><input type="checkbox"/> EC-2 Preservation of Existing Vegetation</p> <p><input type="checkbox"/> EC-9 Earth Dikes & Drainage Swales</p> <p><input type="checkbox"/> EC-10 Velocity Dissipation Devices</p> <p><input type="checkbox"/> EC-12 Streambank Protection</p> <p><input type="checkbox"/> SE-1 Silt Fence</p> <p><input type="checkbox"/> SE-2 Sedimentation Basin</p> <p><input type="checkbox"/> SE-3 Sediment Trap</p> <p><input type="checkbox"/> SE-4 Check Dam</p> <p><input type="checkbox"/> SE-6 Gravel Bag Berm</p> <p><input type="checkbox"/> SE-7 Street Sweeping & Vacuuming</p> <p><input type="checkbox"/> SE-8 Sandbag Barrier</p> <p><input type="checkbox"/> SE-9 Straw Bale Barrier</p> <p><input type="checkbox"/> WE-1 Wind Erosion Control</p> <p><input type="checkbox"/> _____ Other: _____</p> <p><input type="checkbox"/> _____ Other: _____</p>	<p><input type="checkbox"/> NS-2 Dewatering Operations</p> <p><input type="checkbox"/> NS-4 Temporary Stream Crossing</p> <p><input type="checkbox"/> NS-5 Clear Water Diversion</p> <p><input type="checkbox"/> NS-8 Vehicle & Equipment Cleaning</p> <p><input type="checkbox"/> NS-10 Vehicle & Equipment Maintenance</p> <p><input type="checkbox"/> NS-15 Demolition Adjacent of Water</p> <p><input type="checkbox"/> TC-1 Stabilized Construction Entrance/Exit</p> <p><input type="checkbox"/> TC-2 Stabilized Construction Roadway</p> <p><input type="checkbox"/> TC-3 Entrance/Outlet Tire Wash</p> <p><input type="checkbox"/> WM-4 Spill Prevention & Control</p> <p><input type="checkbox"/> WM-5 Solid Waste Management</p> <p><input type="checkbox"/> WM-6 Hazardous Waste Control</p> <p><input type="checkbox"/> WM-7 Contaminated Soil Management</p> <p><input type="checkbox"/> SC-60 Housekeeping Practices</p> <p><input type="checkbox"/> _____ Other: _____</p> <p><input type="checkbox"/> _____ Other: _____</p>
--	--

APPENDIX B
PROJECT WATER DIVERSION PLAN FORM
LOS ANGELES COUNTY DEPARTMENT OF PUBLIC WORKS
FLOOD CONTROL DISTRICT

For more information regarding Los Angeles County Flood Control Districts' (LACFCD) water monitoring and diversion procedures, please refer to LACFCD: Water Diversion Manual and Best Management Practices, July 2016 and Water Quality Monitoring Guide, July 2016.

PROJECT SITE DRAWINGS

Provide a site layout drawing in 8.5" x 11" or 11" x 17" format (using AutoCAD or a sketch/hand drawing with dimensions). The plan will contain the following:

- Entire Project Reach
- Work area(s); by activity
- Restricted work area(s)
- Barrier locations
- Diversion locations
- Location of all planned BMPs
- Access considerations, route, and methods
- Locations of temporary access methods
- Utilities-subsurface (if available) and overhead
- Drawing to scale (if in AutoCAD format)

Appendix C Soft-Bottom Channel Reaches

This page intentionally left blank.

TABLE A-1. Soft-Bottom Channel Reach Description

Waters Name	Hydrological Code	Beneficial Uses	Area (acres)	Length (feet)	Upstream Cross Streets	Downstream Cross Streets	Local Waterway
1 - Bell Creek- MTD 963 M.C.I.	180701050210	MUN, GWR, REC-1, REC-2, WARM, WILD	0.9	197	962' u/s of Highlander Rd	766' u/s of Highlander Rd	Bell Creek
2 - Dry Canyon Creek (Calabasas) PD T1845	180701050208	MUN, GWR, REC-1, REC-2, WARM, WILD	1.24	1549	676' u/s Park Ora	870' d/s Park Ora	Dry Canyon
3 - Santa Susana Creek tributary to Browns Canyon Creek M.C.I.	180701050208	MUN, GWR, REC-1, REC-2, WARM, WILD	0.06	99	5560' N of Devonshire St	5635' N or Devonshire St	Santa Susana Creek
4 - Browns Canyon Creek	180701050208	MUN, GWR, REC-1, REC-2, WARM, WILD.	3	1303	1895' u/s of Rinaldi St	556' u/s of Rinaldi St	Browns Creek
5 - Caballero Creek M.C.I. (West Fork)	180701050208	MUN, GWR, REC-1, REC-2, WARM, WILD	1.3	654	890' u/s of Reseda Blvd	238' u/s of Reseda Blvd	Caballero Creek
6 - Caballero Creek M.C.I. (East Fork)	180701050208	MUN, GWR, REC-1, REC-2, WARM, WILD	0.35	164	588' u/s of Reseda Blvd	428' u/s of Reseda Blvd	Caballero Creek
7 - Bull Creek M.C.O.	180701050208	MUN, GWR, REC-1, REC-2, WARM, WILD	5.61	2704	165' d/s of c/l of Victory Blvd	Confluence w/ Los Angeles River	Bull Creek
8 - Hayvenhurst Drain, trib. to Sepulveda Flood Control Basin Project	180701050208	MUN, GWR, REC-1, REC-2, WARM, WILD, WET	0.3	218	Havenhurst	Ventura Fwy	Tributary of LA River
9 -Tributary to the Sepulveda Flood Control Basin, Project 106 Outlet	180701050208	MUN, GWR, REC-1, REC-2, WARM, WILD, WET	0.12	120	400' d/s of Victory Blvd	520' d/s of Victory Blvd	Sepulveda Basin
10 - Tributary to the Sepulveda Flood Control Basin, Project No 469	180701050208	MUN, GWR, REC-1, REC-2, WARM, WILD, WET.	7.12	4084	751' d/s of Victory Blvd	LA River (4945' d/s of Victory Blvd)	Tributary of LA River
12 - Haines Canyon Creek M.C.O.	180701050105	MUN, GWR, REC-1, REC-2, WARM, WILD, RARE	0.4	400	791' d/s of Wentworth St	1228' d/s of Wentworth St	Haines Canyon
13 - Tributary to Hansen Lake, Project No 5215 unit 1	180701050205	MUN, GWR, REC-1, REC-2, WARM, WILD, RARE	0.55	591	1030' d/s of Foothill Blvd	1535' d/s of Foothill Blvd	Tributary of Tujunga Wash
14 - May Channel (M.C.O. into Pacoima Cyn)	180701050206	MUN, GWR, REC-1, REC-2, WARM, WILD, RARE	0.63	588	3038' d/s of Hubbard St	3728' d/s of Hubbard St/Conf. W/ Pacoima Cyn	May Channel
15 - Pacoima Wash	180701050204	MUN, GWR, REC-1, REC-2, WARM, WILD, RARE	5.25	4656	159' d/s of Parthenia	1187' d/s of Lanark St	Pacoima Wash
16 - Verdugo Wash-Las Barras Cyn (chnl inlet)	180701050207	MUN, GWR, REC-1, REC-2, WARM, WILD.	0.07	131	157' u/s of conf. w/Las Barras Cyn Chnl	27' u/s of conf. w/Las Barras Cyn Channel	Verdugo Wash
18 - Engleheard Channel, tributary to Verdugo Wash	180701050207	MUN, GWR, REC-1, REC-2, WARM, WILD	1.1	744	800' u/s of conf. w/ Verdugo Wash	Conf. w/ Verdugo Wash	Verdugo Wash
19 - Pickens Canyon, tributary to Verdugo Wash	180701050207	MUN, GWR, REC-1, REC-2, WARM, WILD	3.42	2461	Crib dam No.7	Pickens Debris Basin	Picken's Canyon
20 - Webber Channel, tributary to Halls Canyon Channel (strm @ private bridge)	180701050207	MUN, IND, PROC, GWR, REC-1, REC-2, WARM, WILD	0.13	123	861' u/s of Los Amigos St	746' u/s of Los Amigos St	Webber Channel
21 - Webber Channel, tributary to Halls Canyon Channel (main chnl inlet d/s bridge)	180701050207	MUN, IND, PROC, GWR, REC-1, REC-2, WARM, WILD	0.03	25	496' u/s of Los Amigos St	471' u/s of Los Amigos St	Webber Channel
22 - Halls Canyon Channel	180701050207	MUN, IND, PROC, GWR, REC-1, REC-2, WARM, WILD	2.63	2465	1370' u/s of Jessen Dr	Halls Cyn Debris Basin	Halls Canyon
24 - Compton Creek	180701060606	MUN, GWR, REC-1, REC-2, WARM, WILD, WET	30.3	13495	COE Station 199+31.00	Los Angeles River	Los Angeles River
25a - Los Angeles River - Willow to PCH (East/Left bank)	180701060606	MUN, IND, PROC, GWR, NAV, REC-1, REC-2, COMM, WARM, EST, MAR, WILD, RARE, MIGR, SPWN, SHELL, WET	56.2	5127	Willow St	Pacific Coast Hwy	Los Angeles River
25b - Los Angeles River - Willow to PCH (West/Right bank)				5127	Willow St	Pacific Coast Hwy	Los Angeles River
26 - Tributary to Dominguez Channel, Project 740	180701060606	MUN, NAV, REC-1, REC-2, COMM, WARM, EST, MAR, WILD, RARE, MIGR, SPWN.	0.35	947	500' u/s of Artesia Blvd	400' d/s Artesia Blvd	Unnamed Tributary of Dominguez Channel
27 - Wilmington Drain	180701060606	MUN, REC-1, REC-2, WARM, WILD, RARE, WET.	7.87	3045	110 Fwy	Pacific Coast Hwy	Wilmington Drain
28 - Triunfo Ck (PD T2200)	180701050402	MUN, GWR, REC-1, REC-2, WARM, WILD, RARE	23	431	384' u/s of Mulholland Hwy	D/s edge of Mulholland Hwy	Triunfo Creek
29 - Las Virgenes Creek (PD T1684) M.C.I.	180701050205	MUN, REC-1, REC-2, WARM, COLD, WILD, RARE, MIGR, SPWN, WET	1.16	357	Los Angeles/Ventura County Boundary	3006' u/s of Thousand Oaks Blvd	Las Virgenes Creek

TABLE A-1. Soft-Bottom Channel Reach Description

Waters Name	Hydrological Code	Beneficial Uses	Area (acres)	Length (feet)	Upstream Cross Streets	Downstream Cross Streets	Local Waterway
32 - Stokes Cyn Channel (PD T043)	180701050205	MUN, REC-1, REC-2, WARM, COLD, WILD, RARE, MIGR, SPWN, WET	1.4	2178	Int. of Quad Sheet blue line w/east bdy Sec 6	1600' u/s Mulholland Hwy & Stokes Cyn Rd	Stokes Canyon
33 - Medea Creek (PD T1378 u.2)	180701060606	MUN, GWR, REC-1, REC-2, WARM, COLD, WILD, RARE, WET.	0.69	818	731' u/s of Thousand Oaks Blvd.	215' d/s of Thousand Oaks Blvd	Medea Creek
34 - Medea Creek (PD T1005) Main Channel Outlet (Chumasa Park)	180701060606	MUN, ND, PROC, AGR, GWR, REC-1, REC-2, WARM, COLD; WILD, RARE	0.19	413	535' d/s of Kanan	940' d/s of Kanan	Medea Creek
35 - Medea Creek M.C.I.-under Route 101	180701060606	MUN, GWR, REC-1, REC-2, WARM, COLD, WILD, RARE, WET	0.14	99	98' u/s of u/s side of Roadside Dr	13' u/s of u/s side of Roadside Dr	Medea Creek
36 - Cheseboro Main Channel Inlet	180701060606	MUN, GWR, REC-1, REC-2, WARM, COLD, WILD, RARE, WET	0.08	61	100' u/s of Driver Ave	44' u/s of Driver Ave	Cheseboro Main Channel inlet
37 - Medea Ck/Cheseboro Ck Outlet	180701060606	MUN, GWR, REC-1, REC-2, WARM, COLD, WILD, RARE, WET	0.47	228	614' d/s of Agoura Road	784' d/s Agoura Road	Medea Creek
38 - Lindero Creek M.C.O.	180701060606	MUN, REC-1, REC-2, WARM, WILD	0.19	205	83' d/s of Agoura Rd	270' d/s of Agoura Road	Lindero Main Channel Outlet
39 - San Gabriel River, Beatty Channel Outlet @ SGR 25+99.00	180701060601	MUN, IND, PROC, AGR, GWR, REC-1, REC-2, WARM, COLD, WILD, RARE	0.26	406	2323' d/s of Todd Ave	2415' d/s of Todd Ave	Beatty Channel Outlet
40a - San Gabriel River - Santa Fe Dam to I-10 Freeway	180701060601	MUN, IND, PROC, AGR, GWR, REC-1, REC-2, WARM, COLD, WILD, RARE	0.32	20996	Santa Fe Dam	I-10 Freeway	San Gabriel River
40b - San Gabriel River - I-10 Freeway to Thienes Ave	180701060601	MUN, GWR, REC-1, REC-2, WARM, WILD, RARE	254.22	12374	El Monte	Thienes Ave	San Gabriel River
41 - Walnut Creek	180701060601	MUN, GWR, REC-1, REC-2, WARM, WILD, WET	40.9	6090	N Baldwin Park Blvd	San Gabriel River	San Gabriel River
42 - San Jose Creek d/s 1000' from end of concrete channel	180701060601	MUN, GWR, REC1, REC2, WILD, WET	2.75	801	COE Station 87+25.00	COE Station 79+25.00	San Jose Creek
43a - San Gabriel River - Upper	180701060601	MUN, ND, PROC, AGR, GWR, REC-1, REC-2, WARM, COLD; WILD, RARE	74.61	3586	Whittier Narrows Dam	San Gabriel River Parkway	San Gabriel River
43b- San Gabriel River- Lower	180701060601	MUN, ND, PROC, AGR, GWR, REC-1, REC-2, WARM, COLD; WILD, RARE		3068	San Gabriel River Parkway	Beverly Blvd	San Gabriel River
44 - San Gabriel River- Rubber Dams	180701060601	MUN, ND, PROC, AGR, GWR, REC-1, REC-2, WARM, COLD; WILD, RARE	175.76	30895	Beverly Blvd	Firestone Blvd	San Gabriel River
45 - Sand Canyon (PD T1307) Main Channel Inlet	180701020201	MUN, IND, PROC, AGR, GWR, FRSH, REC-1, REC-2, WARM, WILD, RARE, WET	0.05	102	2018' u/s of Soledad Cyn Rd	1916' u/s of Soledad Cyn Rd	Sand Canyon
46 - Sand Canyon (PD T1307) Main Channel Outlet	180701020201	MUN, IND, PROC, AGR, GWR, FRSH, REC-1, REC-2, WARM, WILD, RARE, WET	0.03	84	1100' u/s of Soledad Cyn Rd	1020' u/s of Soledad Cyn Rd	Sand Canyon
47 - Santa Clara River Main Chnl. (PD 1733 unit 1)	180701020201	MUN, IND, PROC, AGR, GWR, FRSH, REC-1, REC-2, WARM, WILD, RARE, WET	0.76	1658	D/s edge of State Route 14	1875' d/s of State Route 14	Santa Clara River
48 - Mint Cyn Channel b/w Sierra Hwy & Adon Ave	180701020201	MUN, IND, PROC, AGR, GWR, FRSH, REC-1, REC-2, WARM, WILD.	3.1	2501	Sierra Hwy	1800' d/s of Sierra Hwy	Mint Cyn Channel
49 - Mint Cyn Channel b/w Adon Ave & Scherzinger	180701020201	MUN, IND, PROC, AGR, GWR, FRSH, REC-1, REC-2, WARM, WILD	0.68	385	Under Adon Ave	382' d/s of Adon Ave	Mint Cyn Channel
50 - Mint Cyn Channel b/w Solomint & Soledad	180701020201	MUN, IND, PROC, AGR, GWR, FRSH, REC-1, REC-2, WARM, WILD, RARE, WET	1.54	735	768' u/s of Soledad Cyn Rd	99' u/s of Soledad Cyn Rd	Mint Cyn Channel
51 - Mint Cyn M.C.O. (PD 1894)/Santa Clara River - Main Channel	180701020201	MUN, IND, PROC, AGR, GWR, FRSH, REC-1, REC-2, WARM, WILD	6.4	931	1044' d/s of Soledad Cyn Rd	SCR on d/s side of Sierra Hwy	Mint Cyn Channel
52 - Sierra Hwy Rd Drainage (CDR 523.203)	180701020201	MUN, IND, PROC, AGR, GWR, FRSH, REC-1, REC-2, WARM, WILD.	0.4	772	253' s/w of Dolan & east edge of Sierra Hwy	Confluence w/ Mint Cyn Channel	Sierra Hwy Rd Drainage

TABLE A-1. Soft-Bottom Channel Reach Description

Waters Name	Hydrological Code	Beneficial Uses	Area (acres)	Length (feet)	Upstream Cross Streets	Downstream Cross Streets	Local Waterway
53 - Santa Clara River Non-main Chnl. (PD 832) M.C.I.	180701020201	MUN, IND, PROC, AGR, GWR, FRSH, REC-1, REC-2, WARM, WILD, RARE, WET	0.03	35	25' d/s of Sierra Hwy	70' d/s of Sierra Hwy	Santa Clara River
54 - Santa Clara River Non-main Chnl. (PD 832) M.C.I.	180701020201	MUN, IND, PROC, AGR, GWR, FRSH, REC-1, REC-2, WARM, WILD, RARE, WET	0.31	316	821' d/s of Sierra Hwy	1098' d/s of Sierra Hwy	Santa Clara River
55 - Santa Clara River Main Chnl. Right Bank Reach (PD's 910, 832, 1758, 1562)	180701020201	MUN, IND, PROC, AGR, GWR, FRSH, REC-1, REC-2, WARM, WILD, RARE, WET	1.63	3518	Sierra Hwy	3049' d/s Sierra Hwy	Santa Clara River
56 - Santa Clara River Main Chnl - Left Bank Reach (PD 832)	180701020201	MUN, IND, PROC, AGR, GWR, FRSH, REC-1, REC-2, WARM, WILD, RARE, WET	0.47	2346	3049' d/s Sierra Hwy	3501' d/s of Sierra Hwy (Hidaway Ave, produced)	Santa Clara River
57 - Whites Cyn (PD T704 M.C.I.)	180701020201	MUN, IND, PROC, AGR, GWR, FRSH, REC-1, REC-2, WARM, WILD, RARE, WET	2.64	695	1449' u/s of Foxlane	753' u/s of Foxlane	Whites Cyn
58 - Santa Clara River Main Channel - Right Bank (PD 374)	180701020201	MUN, IND, PROC, AGR, GWR, FRSH, REC-1, REC-2, WARM, WILD, RARE, WET	1.21	2644	2114' u/s of old Soledad Cyn Rd bridge	U/s of old Soledad Cyn Rd bridge	Santa Clara River
60 - Santa Clara River Main Channel - Right Bank Reach (PD's 1339 & 374)	180701020201	MUN, IND, PROC, AGR, GWR, FRSH, REC-1, REC-2, WARM, WILD, RARE, WET	1.5	3166	D/s side of new Soledad Cyn Rd bridge	Conf. w/PD 313 (d/s Newhouse St, produced)	Santa Clara River
61 - Santa Clara River Main Channel (PD 659 & 754)	180701020201	MUN, IND, PROC, AGR, GWR, FRSH, REC-1, REC-2, WARM, WILD, RARE, WET	4.3	4715	D/s side of new Soledad Cyn Rd bridge	1634' d/s of new Soledad Cyn Rd bridge	Santa Clara River
63 - Oak Ave Rd Drainage (CDR 523.081)	180701020201	MUN, IND, PROC, AGR, GWR, FRSH, REC-1, REC-2, WARM, WILD, RARE, WET	2.8	914	1400' N of Soledad Cyn Rd @ SCE lines	2300' N of Soledad Cyn Rd @ SCE lines	Oak Ave Rd Drainage
64 - Soledad Cyn Rd Drain (CDR 523.071 D outlet)	180701020201	MUN, IND, PROC, AGR, GWR, FRSH, REC-1, REC-2, WARM, WILD, RARE, WET	0.85	574	(E side of) LA Aqueduct N of Soledad Cyn Rd	1250' NW/o Soledad Cyn Rd & LA Aqueduct	Soledad Cyn Rd Drain
67 - Bouquet Cyn Upper (PD's 1201, 802, 700B, & 625)	180701020201	MUN, IND, PROC, AGR, GWR, FRSH, REC-1, REC-2, WARM, COLD, WILD, SPWN,WET	16.3	6344	63' d/s of Hob Ave, produced	153' u/s of Urbandale Ave	Bouquet Cyn Upper
69 - Bouquet Cyn Middle (PD's 722, 773, 1365, 1065, & 451)	180701020201	MUN, IND, PROC, AGR, GWR, FRSH, REC-1, REC-2, WARM, COLD, WILD, SPWN,WET	12.51	7326	122' d/s of Urbandale Ave	54' d/s of middle crossing, Bouquet Cyn Rd	Bouquet Cyn Mid
70 - Bouquet Cyn Lower (PD's 544 & 345)	180701020201	MUN, IND, PROC, AGR, GWR, FRSH, REC-1, REC-2, WARM, COLD, WILD, SPWN,WET	8.54	3503	2866' u/s lower crossing. Bouquet Cyn Rd	d/s side of lower crossing. Bouquet Cyn Rd	Bouquet Cyn Lower
71 - Santa Clara River Main Channel (PD 1946)	180701020201	MUN, IND, PROC, AGR, GWR, FRSH, REC-1, REC-2, WARM, WILD, RARE, WET	1.01	242	276' u/s of McBean Pkwy (conf w/ SF-SCR)	d/s edge of McBean Parkway	Santa Clara River
72 - South Fork- SCR (Smizer Ranch M.C.I.)	180701020201	MUN, IND, PROC, AGR, GWR, FRSH, REC-1, REC-2, WARM, WILD, RARE, WET	0.14	101	1150' u/s of Wiley Canyon Road	1050' u/s Wiley Canyon Road	Santa Clara River
73 - Wildwood Cyn Chnl (PD T361) M.C.I.	180701020201	MUN, IND, PROC, AGR, GWR, FRSH, REC-1, REC-2, WARM, WILD	0.05	83	109' u/s of Cedartown St	u/s side of Cedartown St	Wildwood Canyon
74 - Wildwood Cyn Chnl (PD T361)	180701020201	MUN, IND, PROC, AGR, GWR, FRSH, REC-1, REC-2, WARM, WILD	0.02	365	161' d/s of Cedartown St	277' d/s of Cedartown St	Wildwood Canyon
75 - South Fork-SCR (PD's 725, 916, 1041, &1300)	180701020201	MUN, IND, PROC, AGR, GWR, FRSH, REC-1, REC-2, WARM, WILD	18.92	14075	255' d/s of Lyons Ave	d/s edge of Magic Mtn Parkway	Santa Clara River
76 - Pico Cyn (PD 813)	180701020201	MUN, IND, PROC, AGR, GWR, FRSH, REC-1, REC-2, WARM, WILD	4.26	4116	Vista Valencia Golf Course	South Fork Santa Clara River	Pico Canyon
77 - Newhall Ck Outlet	180701020201	MUN, IND, PROC, AGR, GWR, FRSH, REC-1, REC-2, WARM, WILD	6.29	2092	1040' d/s of 15th St	Confluence w/SCR-South Fork	Newhall Creek Outlet
78 - Placerita Creek	180701020201	MUN, IND, PROC, AGR, GWR, FRSH, REC-1, REC-2, WARM, WILD	1.16	376	D/s edge of San Fernando Rd	Confluence w/ Newhall Creek	Placerita Creek
79 - South Fork- SCR (Valencia Blvd Bridge Stabilizer)	180701020201	MUN, IND, PROC, AGR, GWR, FRSH, REC-1, REC-2, WARM, WILD	1.17	168	D/s edge of Valencia Blvd	167' d/s of Valencia Blvd	Santa Clara River

TABLE A-1. Soft-Bottom Channel Reach Description

Waters Name	Hydrological Code	Beneficial Uses	Area (acres)	Length (feet)	Upstream Cross Streets	Downstream Cross Streets	Local Waterway
80 - South Fork-SCR (PD's 1947 & 1946)	180701020201	MUN, IND, PROC, AGR, GWR, FRSH, REC-1, REC-2, WARM, WILD	8.18	2686	3080'u/s of McBean Parkway	276' u/s of McBean Pkwy (conf.w/SCR)	Santa Clara River
82 - Santa Clara River Main Chnl (PD 2278)	180701020201	MUN, IND, PROC, AGR, GWR, FRSH, REC-1, REC-2, WARM, WILD, RARE, WET.	4.8	849	740' s/e of Ave. Hopkins & Ave. Rockefeller	S/o Avenue Hopkins & Avenue Rockefeller	Santa Clara River
86 - Violin cyn M.C.O.	180701020201	MUN, IND, PROC, AGR, GWR, FRSH, REC-1, REC-2, WARM, WILD, RARE, WET.	1.3	1006	1021' d/s Ridge Route Rd	Conf w/ Castaic Creek	Violin Canyon
87 - Castaic- Old Road Drainage (CDR 525.021D) Outlet	180701020201	MUN, IND, PROC, AGR, GWR, FRSH, REC-1, REC-2, WARM, WILD, RARE, WET.	0.19	225	610' d/s of Hasley Cyn Rd, w/o The Old Rd	Conf w/ Castaic Creek	Castaic Creek
88 - Hasley Cyn Upper (PD T1496)	180701020201	MUN, IND, PROC, AGR, GWR, FRSH, REC-1, REC-2, WARM, WILD, RARE, WET.	0.42	1051	755' u/s of Sharp Rd	330' d/s of Sharp Rd	Hasley Canyon Upper
89 - Hasley Cyn South Fork (PD T1496)	180701020201	MUN, IND, PROC, AGR, GWR, FRSH, REC-1, REC-2, WARM, WILD, RARE, WET.	0.28	341	331' u/s of Romero Cyn Rd along South Fork	160'u/s of Romero Cyn Rd	Hasley Canyon South Fork
90 - Hasley Cyn Lower (North Fork PD T1496)	180701020201	MUN, IND, PROC, AGR, GWR, FRSH, REC-1, REC-2, WARM, WILD, RARE, WET.	0.68	1051	1089' u/s of Romero Cyn Rd along Main Line	100' d/s of Romero Cyn Rd	Hasley Canyon Lower
91 - San Martinez Chiquito Cyn u/s Keningston Rd	180701020201	MUN, IND, PROC, AGR, GWR, FRSH, REC-1, REC-2, WARM, WILD, RARE, WET.	0.31	599	530' u/s of San Martinez Rd (w/o Borton St)	Keningston Rd	San Martinez Chiquito Canyon
92 - San Martinez Chiquito Cyn (N. Fork) unnamed	180701020201	MUN, IND, PROC, AGR, GWR, FRSH, REC-1, REC-2, WARM, WILD, RARE, WET.	0.29	768	920' u/s of c/l of San Martinez Rd	Conf. w/ San Martinez Chiquito Cyn Chnl	San Martinez Chiquito Canyon
93 - S.M.C.C. b/w Keningston/Val Verde Park	180701020201	MUN, IND, PROC, AGR, GWR, FRSH, REC-1, REC-2, WARM, WILD, RARE, WET.	0.56	1072	400' d/s of Keningston Rd	1054' d/s of Keningston Rd	San Martinez Chiquito Canyon
94 - S.M.C.C. b/w Val Verde Park/ d/s of Madison St	180701020201	MUN, IND, PROC, AGR, GWR, FRSH, REC-1, REC-2, WARM, WILD, RARE, WET.	1.57	2446	1092' u/s of Chiquito Cyn Rd	268' d/s of Madison St	San Martinez Chiquito Canyon
95 - Project No 1224	180701020201	MUN, AGR, GWR, REC1, REC2, WARM, WILD.	7.95	1823	Ave T	Confluence of Little rock Creek	Unnamed Tributary of Little Rock Wash
96 - PD 1591, Calabasas	180701020201	MUN, AGR, GWR, REC1, REC2, WARM, WILD.	0.92	532	85' u/s of culvert under Vicasa Drive	360' d/s of culvert under Vicasa Drive	Dry Canyon
97 - PD 1982, Castaic Creek	180701020201	MUN, IND, PROC, AGR, GWR, FRSH, REC-1, REC-2, WARM, WILD, RARE, WET.	2.3	2002	300' d/s of The Old Road	2300' d/s of The Old Road	Castaic Creek
98 - Walnut Creek - Channel Inlet	180701020201	MUN, ND, PROC, AGR, GWR, REC-1, REC-2, WARM, COLD; WILD, RARE	0.14	51	30' u/s of perpendicular ext. of Chaparro Rd	Perpendicular extension of Chaparro Road	Walnut Creek
99 - Kagel Canyon - Tujung Wash	180701020201	MUN, GWR, REC-1, REC- 2, WARM, WILD	1.67	4844	Blue Sage Drive	City of Los Angeles Boundary	Kagel Canyon
100 - Dry Canyon Calabasas Creek Inlet	180701020201	MUN, GWR, REC-1, REC- 2, WARM, WILD	0.05	114	1835' u/s of Ave San Luis	1775' u/s of Ave San Luis	Dry Canyon
101 - Violin Cyn (PD 2312)	180701020201	MUN, IND, PROC, AGR, GWR, FRSH, REC-1, REC-2, WARM, WILD, RARE	5.04	1818	2637' u/s of Lake Hughes Road	820' u/s of Lake Hughes Road	Violin Canyon
102 - Violin Cyn (PD 2275)	180701020201	MUN, IND, PROC, AGR, GWR, FRSH, REC-1, REC-2, WARM, WILD, RARE	1.76	975	1072' u/s of d/s face of Sierra Oak Trail RCB	94' u/s of d/s face of Sierra Oak Trail RCB	Violin Canyon
103 - Bouquet Cyn Channel (PD 2225)	180701020201	MUN, IND, PROC, AGR, GWR, FRSH, REC-1, REC-2, WARM, COLD, WILD, SPWN,WET	7.31	1348	173' d/s of centerline of Newhall Ranch Road (Begin. of Grouted Stone Toe)	MWD Fee R/W on the Right Bank. Embankment turn at Santa Clara River Left Bank	Bouquet Canyon Channel
104 - Castaic Creek (PD 2441 Unit 2)	180701020201	MUN, IND, PROC, AGR, GWR, FRSH, REC-1, REC-2, WARM, WILD, RARE, WET.	38.12	2223	669' u/s of Muirfield Lane Centerline	478' d/s of Turnberry Lane Centerline	Castaic Creek
105 - San Francisquito Cyn Channel (PD 2456)	180701020201	MUN, IND, PROC, AGR, GWR, FRSH, REC-1, REC-2, WARM, WILD, RARE, WET	13.8	833	417' u/s of Decoro Drive Centerline	416' d/s of Decoro Drive Centerline	San Francisquito Canyon Channel
106 - Castaic Drain Outlet	180701020201	MUN, IND, PROC, AGR, GWR, FRSH, REC-1, REC-2, WARM, WILD, RARE, WET.	1.46	751	Toe of Grouted Riprap Apron	147' d/s of Grouted Rip Rap Apron	Castaic Drain Outlet

TABLE A-1. Soft-Bottom Channel Reach Description

Waters Name	Hydrological Code	Beneficial Uses	Area (acres)	Length (feet)	Upstream Cross Streets	Downstream Cross Streets	Local Waterway
107 - The Old Road Channel	180701020201	MUN, IND, PROC, AGR, GWR, FRSH, REC-1, REC-2, WARM, WILD, RARE, WET.	0.51	1028	230' u/s of Driveway into 24136 the Old Road	U/S of Concrete Lined Channel	Unnamed Tributary u/s of South Fork of Santa Clara R.
108 - Pico Canyon (PD 2528)	180701020201	MUN, IND, PROC, AGR, GWR, FRSH, REC-1, REC-2, WARM, WILD	1.38	3100	Stevenson Ranch DB	The Old Road	Pico Canyon
109 - Santa Clara River - S. Bank W. of McBean Pkwy (MTD1510)	180701020201	MUN, AGR, GWR, FRSH, REC1, REC2, WARM, WILD, WET	5.34	372	371' u/s McBean Pkwy centerline	PD 1946	Santa Clara River
110 - Hasley Canyon Channel(PD2262)	180701020201	MUN, AGR, GWR, FRSH, REC1, REC2, WARM, WILD, WET	7.79	3737	PD 2508	Castaic Creek	Hasley Canyon Channel

BENEFICIAL USES	
AGR	Agricultural Supply
COLD	Cold Freshwater Habitat
COMM	Commercial and Sport Fishing
EST	Estuarine Habitat
FRSH	Freshwater Replenishment
GWR	Ground Water Recharge
IND	Industrial Service Supply
MAR	Marine Habitat
MIGR	Migration of Aquatic Organisms
MUN	Municipal and Domestic Supply
NAV	Navigation
PROC	Industrial Process Supply
RARE	Rare, Threatened, or Endangered Species Habitat
REC-1	Contact Recreation
REC-2	Non-contact Recreation
SHELL	Shellfish Harvesting
SPWN	Spawning, Reproduction and/or Early Development
WARM	Warm Freshwater Habitat
WET	Wetland Habitat
WILD	Wildlife Habitat

ABBREVIATIONS	
b/w	below
CDR	concrete drain
Chnl	channel
Ck	creek
Cyn	canyon
d/s	downstream
M.C.I.	main channel inlet
M.C.O.	main channel outlet
Mtd	miscellaneous transferred drain
MWD	Municipal Water District
PCH	Pacific Coast Highway
PD	private drain
Pkwy	Parkway
R/W	Right-of-way
RCB	reinforced concrete pipe
SCE	Southern California Edison
Strm	stream
u/s	upstream

STREAM GAGE LOCATIONS					
Station	SBC Reach	Watershed	Name	Latitude	Longitude
F262C	44	San Gabriel	San Gabriel River above Florence Av	33.943047	-118.0997
F263C	43	San Gabriel	San Gabriel River below San Gabriel River Pkwy	34.012976	-118.06409
E281	40	San Gabriel	San Gabriel River below Santa Fe Dam	34.112385	-117.97011
F88	79	Santa Clara	South Fork Santa Clara River at Valencia Bl	34.418783	-118.54852
F89	75	Santa Clara	South Fork Santa Clara River at Newhall	34.391378	-118.54217
F377B	70	Santa Clara	Bouquet Creek above Bouquet Canyon Rd	34.431025	-118.5331
F328B	48	Santa Clara	Mint Canyon Creek at Sierra Hwy	34.430868	-118.44311

TABLE A-2. Permit Requirements for Soft-Bottom Channel Reaches

No.	Reach Name	Permit Status	Federal Reach Sensitivity (May Require USFWS Consultation)	Last Focused Survey	Previously Authorized or Proposed 2015 Maintenance Activities by Reach; Permit Conditions from Agencies to be Included	Explanation of Changes to Proposed 2015 Activity and/or Biological Resources Since Last Approved Maintenance Plan And Results of Los Angeles River Feasibility Study
1	Bell Creek- MTD 963 M.C.I.	Approved	Non-sensitive	N/A	The reach clearing work will involve hand cutting a 15-foot wide "tunnel" through the vegetation to the right-of-way boundary to train flows to the center of the reach inlet.	No change. The hydrological studies identify that this reach as able to contain more vegetation. The Biological Technical Report (BTR) for the Feasibility Study (FS) recommends allowing the willow canopy to spread outside the channel on the left bank and to allow native shrubs such as coyote brush and mule fat to become established in this area. Furthermore, the BTR recommends that the existing chain-link fence be relocated to protect the native vegetation in this area (approximately 0.06 acre).
2	Dry Canyon (Calabasas) PD T1845	Approved	Non-sensitive	N/A	The reach clearing work will involve maintaining and clearing a 20-foot-wide path along the centerline of the reach. Trees within and on the channel banks will not be allowed to mature. Hand clearing will be performed annually to keep the center portion of the reach clear and vegetation will be removed from the openings in the crib walls to the extent necessary to prevent structural damage to the crib walls.	The new language ("trees within and on the channel banks will not be allowed to mature") is required because the banks are vertical crib walls which large trees damage. Most, if not all of the trees on the crib walls are ornamental species. Hydrological studies identified this reach as hydraulically deficient and requiring an additional 0.39 acre of vegetation to be removed.
3	Santa Susana Creek M.C.I.	Approved	Non-sensitive	N/A	Hand cutting and clearing vegetation and trees will be done in an 18-foot-wide area by 75-foot long area at the inlet to the reach. Oak trees will be left in place.	No change. The hydrological studies identified this reach as hydraulically sufficient, but without the capacity for any additional vegetation. The existing maintenance plan has been fully implemented and there are no outstanding issues.
4	Browns Creek	Approved	Non-sensitive	N/A	Mechanical equipment will be used to keep clear all vegetation from bank to bank within the rail and timber revetment.	No change. The hydrological studies identified this reach as hydraulically sufficient, but without the capacity for any additional vegetation. The maintenance plan has been fully implemented and there are no outstanding issues.
5	Caballero Creek M.C.I. (West Fork)	Approved	Non-sensitive	N/A	The vegetation clearing work will involve hand clearing a 20-foot-wide path along the centerline of the reach.	No change. The hydrological studies identified these two reaches as hydraulically sufficient, but without the capacity for any additional vegetation. The maintenance plan has been fully implemented and there are no outstanding issues.
6	Caballero Creek M.C.I. (East Fork)	Approved	Non-sensitive	N/A	The vegetation clearing work will involve hand clearing a 20-foot-wide path along the centerline of the reach.	No change. The hydrological studies identified these two reaches as hydraulically sufficient, but without the capacity for any additional vegetation. The maintenance plan has been fully implemented and there are no outstanding issues.
7*	Bull Creek M.C.O.	Pending	Sensitive	2007 - least Bell's vireo (negative) and southwestern willow flycatcher (negative)	The work will involve hand clearing of vegetation and debris from the invert to ensure unimpeded flow within the reach. This work will be done only in the first 275 feet (between the outlet and the pedestrian bridge) of the reach downstream from the concrete reach outlet to ensure that flow does not back up into the concrete reach upstream of Victory Boulevard.	The overall character of this reach has changed due to the USACE restoration project in Balboa Park that covered the earthen banks of this reach with riprap. Note that the area and length of the work was reduced to 275' due to the installation of the restoration project. Vegetation on invert was not allowed to remain prior to the restoration project, so updated maintenance activities do not represent a change. This reach has nuisance flows on a continuous basis (making it a "wet reach"), and additional vegetation on the bank may interfere with mosquito abatement activities of the Los Angeles County Vector Control District. Note that the ACOE USACE Bull Creek Channel Ecosystem Restoration Project initiated in 2008 removed the 1.45 acres of "protected" vegetation in this reach. Focused surveys not conducted since 2007 as Bull Creek including the Reach 7 segment became a riparian restoration site managed by the Army Corps of Engineers. The LACFCD also suspended clearing activities at that time. The pre-clearing habitat assessments conducted in 2014 indicated potentially suitable habitat for the LBV is once again present at Reach 7 and a resumption of these focused surveys is warranted. The hydrological studies identified this reach as able to contain more vegetation. The BTR recommended allowing willows to grow at the toe of both levees.

TABLE A-2. Permit Requirements for Soft-Bottom Channel Reaches

No.	Reach Name	Permit Status	Federal Reach Sensitivity (May Require USFWS Consultation)	Last Focused Survey	Previously Authorized or Proposed 2015 Maintenance Activities by Reach; Permit Conditions from Agencies to be Included	Explanation of Changes to Proposed 2015 Activity and/or Biological Resources Since Last Approved Maintenance Plan And Results of Los Angeles River Feasibility Study
8	Hayvenhurst Drain - Project 470 Outlet	Approved	Non-sensitive	N/A	All vegetation in this reach will be cleared annually using mechanical or manual methods.	No change. The hydrological studies identified this reach as hydraulically sufficient, but without the capacity for any additional vegetation. The maintenance plan has been fully implemented and there are no outstanding issues. Since the dry season in southern California overlaps the breeding season for birds, the phrase "cleared annually" is preferred.
9	Project 106 Outlet	Approved	Non-sensitive	N/A	Brush and tree trimming will be performed where needed to keep growth at the levels that were left in November 1997. Brush and tree trimming will be performed annually to keep the invert free of vegetation.	The hydrological studies identified this reach as able to contain more native vegetation. The BTR recommended replacing the non-native ash trees with native trees on both banks of this channel reach. Based on the physical parameters of this channel reach and its location, the BTR recommended that native sycamore trees be planted on both banks instead of willows. This recommendation would result in a net gain of native vegetation in this channel reach (approx. 0.12 acre).
10	Project No. 469	Approved	Non-sensitive	N/A	Vegetation will be cleared annually to the extent necessary to prevent restricting flows in the storm drain upstream of Victory Boulevard. This will require mechanical clearing of vegetation in the reach for approximately 4,000 feet downstream of Victory Boulevard. Reach work will also include mechanical grading to train flows to centerline of reach.	The vegetation in this reach consists almost entirely of non-native ruderal (weedy) vegetation. The maintenance plan has not been fully implemented for this reach because of a conflict between the maintenance plan and the permits. Issuance of the 1997 CDFW permit coincided with a toxic spill in this reach and resulted in the incorrect conclusion that "no work was done in 1997." Since that time, the monitoring biologist has worked with LACFCD personnel to implement partial clearing strategies designed to meet flood-control concerns and to retain as much vegetation as possible. A rotating pattern of clearing was implemented that allowed ruderal vegetation to remain on one bank each year. As a result, the ruderal vegetation cleared each year was two years old. After several years, however, the monitoring biologist found that the bank of mowed ruderal vegetation responded favorably to the mowing and provided more "biological value" than the older (two year old) ruderal vegetation. Therefore, the monitoring biologist discontinued the rotating clearing pattern at this reach and full clearing was resumed. The hydrological studies identified this reach as hydraulically sufficient, but without the capacity for any additional vegetation. The BTR identified less than 0.06 acre of native cattail wetland in this channel reach.
12*	Haines Canyon M.C.O.	Pending	Sensitive	2013 - Santa Ana sucker (negative), least Bell's vireo (negative), and southwestern willow flycatcher (negative)	Hand clearing of all vegetation will be used to keep the reach clear of vegetation, except for the vegetation that was allowed to remain in 1997. This process will be repeated annually to prevent growth from restricting flows at the outlet to the reach.	No change. Hydrological studies identified this reach as hydraulically deficient and requiring an additional 0.14 acre of vegetation to be removed. The additional vegetation to be removed has not been identified, but most of the additional vegetation within this reach would be native and require mitigation.
13*	Project No. 5215 Unit 1	Approved	Non-sensitive	N/A	The reach clearing work involves mechanically clearing the earthen outlet reach with a backhoe and hand cutting all vegetation from the first 250 feet of the reach bottom (12- feet wide) downstream at the end of Christie Avenue. Bank vegetation and the remaining 300 feet of the reach will not be cleared. The channel clearing work involves mechanical (backhoe) and hand clearing of a 12-foot wide path throughout its length (537 ft).	Identified as a potential SAS reach during initial informal consultation with the USFWS, but surveys by Dr. Baskin and Dr. Haglund determined that this reach has no potentially suitable habitat for SAS. Hydrological studies identified this reach as hydraulically deficient and requiring an additional 0.29 acre of vegetation to be removed. The additional vegetation to be removed has not been identified, but most of the additional vegetation within this reach would be native and require mitigation.
14*	May Channel (M.C.O. Into Pacoima Canyon)	Pending	Sensitive	2013- least Bell's vireo (positive) and southwestern willow flycatcher (negative)	Hand clearing work will be performed to keep the reach invert clear of all vegetation.	This updated language reflects the actual maintenance activities that have been conducted at this reach, which have always been confined to the invert. The riparian vegetation that was allowed to remain on the banks had been the "protected" vegetation in this reach. The surveys then determined that this vegetation is occupied by the least Bell's vireo. Hydrological studies identified this reach as hydraulically deficient and requiring an additional 0.44 acre of vegetation to be removed.

TABLE A-2. Permit Requirements for Soft-Bottom Channel Reaches

No.	Reach Name	Permit Status	Federal Reach Sensitivity (May Require USFWS Consultation)	Last Focused Survey	Previously Authorized or Proposed 2015 Maintenance Activities by Reach; Permit Conditions from Agencies to be Included	Explanation of Changes to Proposed 2015 Activity and/or Biological Resources Since Last Approved Maintenance Plan And Results of Los Angeles River Feasibility Study
15	Pacoima Wash	Approved	Non-sensitive	N/A	Mechanical equipment and hand cutting will be used to keep the reach cleared of all vegetation.	No change. The hydrological studies identified this reach as hydraulically sufficient, but without the capacity for any additional vegetation. The maintenance plan has been fully implemented and there are no outstanding issues. The 0.01 acre of vegetation allowed to remain in the channel was upstream of the pedestrian bridge. This 0.01 acre consisted of cattails that was taken over by invasive species (e.g., ornamental trees and Washingtonia palms) and was relocated, at the direction of the monitoring biologist, to the downstream terminus of the channel reach.
16	Verdugo Wash - Las Barras Canyon (channel inlet)	Approved	Non-sensitive	N/A	Hand clearing work will be used to keep the reach clear of all vegetation.	No change. The hydrological studies identified this reach as hydraulically sufficient, but without the capacity for any additional vegetation. The maintenance plan has been fully implemented and there are no outstanding issues.
18	Engleheard Channel	Approved	Non-sensitive	N/A	Hand clearing work will only involve dead vegetation and tree branches from the area between the pipe and wire revetments. All vegetation will be cleared by manual methods during the dry season. All vegetation will be cleared annually by manual methods.	The hydrological studies identified this reach as hydraulically deficient and additional vegetation needs to be removed. No vegetation, however, within the LACFCD's right-of-way is allowed to remain.
19*	Pickens Canyon	Approved	Non-sensitive	N/A	Manual removal of all vegetation adjacent to or growing out of the crib structures will be performed.	No change. Identified as a potential LBV reach during initial informal consultation with the USFWS, but surveys by BonTerra biologist Brian E. Daniels determined no potential habitat for this species existed at the reach and focused LBV surveys were not warranted. The hydrological studies identified this reach as able to contain more native vegetation. The BTR recommended allowing native shrubs to grow on the invert of the reach from the upstream end to the pedestrian bridge at Mountain Avenue. Furthermore, the BTR recommended protecting the native shrubs by removing non-natives species. No native trees would be allowed to grow on the invert. The maintenance plan has been fully implemented and there are no outstanding issues.
20	Webber Channel (Storm @ Private Bridge)	Approved	Non-sensitive	N/A	Mechanical equipment will be used to keep the reach clear of all vegetation. Mechanical equipment will be used to keep the channel clear of all vegetation except for the native species on the right bank (looking downstream). Under the guidance of the monitoring biologist, native shrubs will be allowed to grow on the right bank and non-native species will be selectively removed.	Hydrological studies identified this reach as able to contain more native vegetation. The new maintenance plan allows for additional native vegetation to grow on the right bank (looking downstream).
21	Webber Channel (Main Channel Inlet d/s Bridge)	Approved	Non-sensitive	N/A	Hand clearing work will be performed to keep the reach clear of all vegetation. Mechanical equipment will be used to keep the channel clear of all vegetation except for the native species on the left bank (looking downstream). Under the guidance of the monitoring biologist, native shrubs will be allowed to grow on the left bank and non-native species will be selectively removed.	Identified as a potential LBV reach; results of focused surveys have been negative to date. The hydrological studies identified this reach as able to contain more native vegetation. The BTR recommended allowing native herbaceous and shrub species to grown on the left bank looking downstream and to selectively protect the native species by removing non-native species. No native trees would be allowed to grown on the right bank. The maintenance plan has been fully implemented and there are no outstanding issues.

TABLE A-2. Permit Requirements for Soft-Bottom Channel Reaches

No.	Reach Name	Permit Status	Federal Reach Sensitivity (May Require USFWS Consultation)	Last Focused Survey	Previously Authorized or Proposed 2015 Maintenance Activities by Reach; Permit Conditions from Agencies to be Included	Explanation of Changes to Proposed 2015 Activity and/or Biological Resources Since Last Approved Maintenance Plan And Results of Los Angeles River Feasibility Study
22	Halls Canyon	Approved	Non-sensitive	N/A	Manual removal of all vegetation adjacent to or growing out of the crib structures will be performed.	No change. The hydrological studies identified this reach as able to contain more native vegetation. The BTR recommended allowing native shrubs (but not trees) to grow on the invert of the entire reach except for on the crib structures. The native species would be protected by selective removal of non-native species. The maintenance plan has been fully implemented and there are no outstanding issues.
24	Compton Creek	Approved	Non-sensitive	N/A	Removal of all vegetation from reach and/or restore hydraulic conveyance capacity of channel by driving tracked equipment over vegetated areas.	No change. Years of scraping the vegetation has resulted in small amounts of the soil on the invert being removed. As this minor removal happened year after year, it resulted in the invert being lower than intended and beginning to expose the toe of the grouted rip rap slopes. To compensate for this, the proposed maintenance activity will leave the "tracked" vegetation in place (which will eventually break down naturally and turn into soil). The slight roughness of the vegetation and root systems allow some sediment flowing downstream to be trapped. All invasive plants are removed before tracking to reduce them from spreading. The hydrological studies identified this reach as hydraulically sufficient, but without the capacity for any additional vegetation. The maintenance plan has been fully implemented and there are no outstanding issues.
25	(a) Los Angeles River - Willow to PCH (East/Left Bank)	Approved	Non-sensitive	N/A	Using mechanical equipment, all exotic vegetation will be removed throughout this reach. Riparian vegetation will be kept in place at the level that was left in November 1997.	No change. Reach has been split into (a) and (b) components.
25	(b) Los Angeles River - Willow to PCH (West/Right Bank)	Approved	Non-sensitive	N/A	Using mechanical equipment, all exotic vegetation will be removed throughout this reach. Riparian vegetation will be kept in place at the level that was left in November 1997.	No change. Reach has been split into (a) and (b) components. Hydrological studies identified this reach as able to contain more native vegetation. The new maintenance plan allows for additional native vegetation to grow on the left bank (looking downstream).
26	Project 740	Approved	Non-sensitive	N/A	The reach will be cleared using hand clearing only. Hand labor will be used to trim the vegetation which has been allowed to remain since 1997. New growth will not be allowed to become established and will be removed annually by manual methods.	No change.
27*	Wilmington Drain	Pending	Sensitive	2013- least Bell's vireo (positive) and southwestern willow flycatcher (negative)	All vegetation from the reach in the area upstream of Lomita Boulevard will be kept cleared. Between Lomita Boulevard and Pacific Coast Highway, vegetation will be kept clear from the two channels on either side of the island, but vegetation on the island and on the reach banks will remain. Clearing work in the reach invert will be done with mechanical equipment; vegetation on the banks will be trimmed with hand tools so that it does not impede flow on the invert.	Construction for the City of Los Angeles's Wilmington Drain Multi-Use Project (Proposition O Clean Water Bond) began in spring 2013. Construction included the removal of sediment and non-native vegetation throughout the length of this reach. The channel reach provides potential habitat for the least Bell's vireo and southwestern willow flycatcher and surveys have determined that it is occupied by the vireo. The City of Los Angeles obtained the necessary "take" permits under FESA and CESA. A solitary male vireo was present during the 2013 breeding season. Construction activities were allowed to continue under the terms and conditions of the permits. Prior to this year, the maintenance plan had been fully implemented and the vireo was protected by terms and conditions under permits held by the LACFCD.
28*	Triunfo Creek (PD T2200)	Pending	Sensitive	2013- least Bell's vireo (negative) and southwestern willow flycatcher (negative)	The reach clearing work will involve removing all vegetation from the ungrouted rock levee and hand clearing of all vegetation along the levee from the base to an outward distance of 20 feet.	No change. Previous CDFW comments have indicated a concern for the western pond turtle (<i>Emys marmorata</i>) at this reach. The monitoring biologist has not yet detected any western pond turtles during annual pre-clearing visits to this reach; however, these pre-clearing visits are not performed in conjunction with the actual clearing activities. Identified as a potential LBV reach; results of focused surveys have been negative to date. The maintenance plan has been fully implemented.

TABLE A-2. Permit Requirements for Soft-Bottom Channel Reaches

No.	Reach Name	Permit Status	Federal Reach Sensitivity (May Require USFWS Consultation)	Last Focused Survey	Previously Authorized or Proposed 2015 Maintenance Activities by Reach; Permit Conditions from Agencies to be Included	Explanation of Changes to Proposed 2015 Activity and/or Biological Resources Since Last Approved Maintenance Plan And Results of Los Angeles River Feasibility Study
29*	Las Virgenes Creek (PD T1684) M.C.I.	Approved	Non-sensitive	N/A	The reach clearing work will involve hand clearing a 30-foot-wide strip along the watercourse low flow reach from the debris posts to the right-of-way boundary.	No change. Previous CDFW comments have indicated a concern for the western pond turtle at this reach. The monitoring biologist has not yet detected any western pond turtles during annual pre-clearing visits to this reach; however, these pre-clearing visits are not performed in conjunction with the actual clearing activities. In order to comply with the HACCP plan developed by the LACFCD for the WDR and adopted on February 4, 2010, by the Los Angeles RWQCB, pre-clearing aquatic invasive species surveys will be conducted in the reaches of the Malibu Creek Watershed. The maintenance plan has been fully implemented.
32	Stokes Canyon Channel (PD T043)	Approved	Non-sensitive	N/A	The work will involve hand clearing of all vegetation between the pipe and wire. Embankment vegetation outside the pipe and wire channel will be left in place.	No change. In order to comply with the HACCP plan developed by the LACFCD for the WDR and adopted on February 4, 2010, by the Los Angeles RWQCB, pre-clearing aquatic invasive species surveys will be conducted in the reaches of the Malibu Creek Watershed. The maintenance plan has been fully implemented.
33*	Medea Creek (PD T1378 U.2)	Approved	Non-sensitive	N/A	The work will involve mechanical or manual clearing of all vegetation in the concrete-lined part of the reach.	The maintenance plan has not been implemented in this reach since 1999 due to sensitive resources and expected mitigation requirements. The western pond turtle potentially occurs at this reach. The cattails in this reach were cleared in 1998 and were included in the overall mitigation under the agreement signed in 1997. As a result, the cattails and other vegetation in the concrete-lined part of this reach can be cleared without any additional mitigation. However, the willow dominated riparian vegetation upstream has not been cleared post-1997. A one-time vegetation clearing and repair project is in the process of approval under CDFW Streambed Alteration Agreement Number 1600-2012-0193-R5. A special condition of this agreement includes a qualified biologist conducting trapping surveys for the western pond turtle, a California special species of concern potentially present in the reach, prior to the commencement of maintenance activities in the reach. Blocking nets shall be utilized upstream to prevent wildlife from entering the project site.
34*	Medea Creek (PD T1005) Main Channel Outlet (Chumasa Park)	Approved	Non-sensitive	N/A	Hand clearing work will be performed to keep the reach clear of all vegetation.	No change. Identified as a potential LBV reach during initial informal consultation with the USFWS. Focused surveys conducted with negative results in 2002 and 2003. Private development outside the reach eliminated upland habitats necessary at this location to provide potential habitat for LBV. BonTerra biologist Brian E. Daniels therefore determined potential habitat for LBV no longer existed at this reach and further focused LBV surveys were not warranted. In order to comply with the HACCP plan developed by the LACFCD for the WDR and adopted on February 4, 2010, by the Los Angeles RWQCB, pre-clearing aquatic invasive species surveys will be conducted in the reaches of the Malibu Creek Watershed. Maintenance plan has been fully implemented.
35	Medea Creek M.C.I. - Under Route 101	Approved	Non-sensitive	N/A	Hand clearing will be performed to keep the reach clear of all vegetation.	No change. In order to comply with the HACCP plan developed by the LACFCD for the WDR and adopted on February 4, 2010, by the Los Angeles RWQCB, pre-clearing aquatic invasive species surveys will be conducted in the reaches of the Malibu Creek Watershed. Maintenance plan has been fully implemented.
36	Cheseboro Main Channel Inlet	Approved	Non-sensitive	N/A	The clearing work will involve clearing dead vegetation and trimming riparian vegetation that would obstruct flows. Tree canopy will remain, but with a clear "tunnel" path to convey flows. New vegetation will be cleared annually to prevent blockage of the inlet.	Language changed to reflect current on-site conditions. In order to comply with the HACCP plan developed by the LACFCD for the WDR and adopted on February 4, 2010, by the Los Angeles RWQCB, pre-clearing aquatic invasive species surveys will be conducted in the reaches of the Malibu Creek Watershed. Maintenance plan has been fully implemented.

TABLE A-2. Permit Requirements for Soft-Bottom Channel Reaches

No.	Reach Name	Permit Status	Federal Reach Sensitivity (May Require USFWS Consultation)	Last Focused Survey	Previously Authorized or Proposed 2015 Maintenance Activities by Reach; Permit Conditions from Agencies to be Included	Explanation of Changes to Proposed 2015 Activity and/or Biological Resources Since Last Approved Maintenance Plan And Results of Los Angeles River Feasibility Study
37	Medea Creek/ Cheseboro Creek Outlet	Approved	Non-sensitive	N/A	Hand clearing work will be performed to keep the reach clear of all vegetation.	No change. In order to comply with the HACCP plan developed by the LACFCD for the WDR and adopted on February 4, 2010, by the Los Angeles RWQCB, pre-clearing aquatic invasive species surveys will be conducted in the reaches of the Malibu Creek Watershed.
38	Lindero M.C.O.	Approved	Non-sensitive	N/A	Hand clearing work will be performed to keep the reach clear of all vegetation.	No change. In order to comply with the HACCP plan developed by the LACFCD for the WDR and adopted on February 4, 2010, by the Los Angeles RWQCB, pre-clearing aquatic invasive species surveys will be conducted in the reaches of the Malibu Creek Watershed. Maintenance plan has been fully implemented.
39*	Beatty Channel Outlet @ SGR 25+99.00	Pending	Sensitive	2013- Santa Ana sucker (negative), least Bell's vireo (positive) and southwestern willow flycatcher (negative)	Mechanical equipment will be used to keep the reach outlet clear of all vegetation.	No change. Maintenance plan has been fully implemented. This reach provides potential habitat for the Santa Ana sucker, but it has not been found in annual pre-clearing surveys conducted since 2002. This reach also provides potential habitat for the least Bell's vireo and southwestern willow flycatcher and the surveys have determined that it is occupied by the vireo.
40	(a) San Gabriel River – Santa Fe Dam to I-10 Freeway	Approved	Non-sensitive	N/A	From Santa Fe Dam to the San Bernardino Freeway (Reach 40a), most of the vegetation consists of mule fat interspersed with various exotic species. In this reach, 10-foot-wide strips were hand cleared along the toe of each levee to provide room to maintain and inspect the levee. The 10-foot-wide strips along the levee toes will be kept clear of all vegetation annually using a combination of mechanical equipment and hand labor. In the center of the reach, the mule fat was mowed using various types of mowing equipment. The root structures of the plants were not disturbed. Two strips of vegetation, 50 and 75 feet in width, were allowed to remain along each side of the reach invert. In subsequent years, mowing will be accomplished in alternate cycles between the center portion of the reach and the two strips of vegetation. Grading to reestablish baseline conditions will be performed on an as-needed basis to maintain access ramps and low-flow reaches from side outlets.	No change. Reach is split into (a) and (b) components. 40a does not contain potential habitat for LBV. The maintenance plan has been fully implemented.
40*	(b) San Gabriel River – I-10 Freeway to Thienes Avenue	Pending	Sensitive	2013- least Bell's vireo (positive) and southwestern willow flycatcher (negative)	From San Bernardino Freeway to Thienes Avenue (Reach 40b), this portion of the reach will be kept clear of all vegetation using mechanical equipment and hand labor, except for the riparian vegetation allowed to remain in place in November 1997. This process will be repeated annually and will be monitored by a biologist familiar with least Bell's vireo habitat requirements. Grading to reestablish baseline conditions will be performed on an as-needed basis to maintain access ramps and low-flow reaches from side outlets.	No change. Reach is split into (a) and (b) components. The maintenance plan has been fully implemented. The riparian habitats downstream of Valley Boulevard (Reach 40b) have been occupied by the least Bell's vireo since the 2002 focused bird surveys were completed. The vireo is protected by terms and conditions contained in the permits held by the LACFCD that require flagging of "seasonally occupied habitat" to protect it and that a qualified biological monitor be present during clearing activities.
41	Walnut Creek	Approved	Non-sensitive	N/A	Mechanical clearing of vegetation will be used to keep the channel clear of all vegetation, except for the riparian habitat allowed to remain in November 1997. Hand work will be necessary to remove some of the vegetation growing in the rock riprap along the reach sides and on the riprap at the downstream end of the concrete reach. Some trimming of the riparian vegetation may be necessary to reduce the impact on flow in the reach as future growth occurs.	No change. The maintenance plan has been fully implemented. Some of the riparian vegetation allowed to remain in place in November 1997 has been lost due to natural causes. Due to drought conditions, several willow trees were stressed and became susceptible to a wood borer infestation.

TABLE A-2. Permit Requirements for Soft-Bottom Channel Reaches

No.	Reach Name	Permit Status	Federal Reach Sensitivity (May Require USFWS Consultation)	Last Focused Survey	Previously Authorized or Proposed 2015 Maintenance Activities by Reach; Permit Conditions from Agencies to be Included	Explanation of Changes to Proposed 2015 Activity and/or Biological Resources Since Last Approved Maintenance Plan And Results of Los Angeles River Feasibility Study
42	San Jose Creek d/s 1000' from end of concrete channel	Approved	Non-sensitive	N/A	The vegetation will be cleared using mechanical equipment, except for riparian vegetation allowed to remain in November 1997. Trimming of the riparian vegetation may be necessary in the future as growth occurs. This process will be repeated annually.	No change. The maintenance plan has been fully implemented. Some of the riparian vegetation allowed to remain in place in November 1997 has been lost due to natural causes. Willow trees were lost due to high storm flows during the 2004–2005 rainy season. The monitoring biologist in conjunction with LACFCD personnel identified young willow trees within the same “line” for protection. However, the sediment islands had been scoured and these young willow trees did not survive subsequent rainy seasons.
43*	(a) San Gabriel River-Upper	Pending	Sensitive	2013- least Bell's vireo (positive) and southwestern willow flycatcher (negative)	Mechanical equipment will be used to keep the reach clear of all vegetation, except riparian vegetation allowed to remain in November 1997. Trimming of the riparian vegetation may be necessary in the future as growth occurs. The vegetation that is seasonally occupied by the least Bell's vireo will be flagged and a qualified biological monitor will be present during clearing activities.	No change. Reach has been split into (a) and (b) components. Maintenance plan has been fully implemented. The riparian habitat in this reach has been occupied by the least Bell's vireo. It is a migratory species that is not present during the fall/winter when the LACFCD's annual clearing activities occur. The vireo is protected by terms and conditions contained in the permits held by the LACFCD that require flagging of “seasonally occupied habitat” to protect it and that a qualified biological monitor be present during clearing activities.
43*	(b) San Gabriel River-Lower	Pending	Sensitive	2013- least Bell's vireo (negative) and southwestern willow flycatcher (negative)	Mechanical equipment will be used to keep the reach clear of all vegetation, except riparian vegetation allowed to remain in November 1997. Trimming of the riparian vegetation may be necessary in the future as growth occurs. The vegetation that is seasonally occupied by the least Bell's vireo will be flagged and a qualified biological monitor will be present during clearing activities.	No change. Reach has been split into (a) and (b) components. Maintenance plan has been fully implemented. The riparian habitat in this reach has been occupied by the least Bell's vireo. It is a migratory species that is not present during the fall/winter when the LACFCD's annual clearing activities occur. The vireo is protected by terms and conditions contained in the permits held by the LACFCD that require flagging of “seasonally occupied habitat” to protect it and that a qualified biological monitor be present during clearing activities.
44*	San Gabriel River - Rubber Dams	Approved	Non-sensitive	N/A	Mechanical equipment will be used to keep the reach clear of all vegetation, except for the riparian vegetation allowed to remain in November 1997. Trimming of the riparian vegetation may be necessary in the future as growth occurs.	No change. Identified as a potential LBV reach during initial informal consultation with the USFWS, but surveys by BonTerra biologist Brian E. Daniels have found a lack of suitable nesting habitat (except for large trees, all vegetation is mowed which removes the dense layer of understory shrubs necessary for nesting LBV); it was therefore determined that focused LBV surveys were not warranted at this reach.
45*	Sand Canyon (PD T1307) Main Channel Inlet	Approved	Non-sensitive	N/A	Mechanical clearing will be performed to keep reach clear of all vegetation.	No change. Identified as a potential LBV reach during initial informal consultation with the USFWS, but surveys by BonTerra biologist Brian E. Daniels determined no potential habitat for this species existed at the reach and focused LBV surveys were not warranted.
46	Sand Canyon (PD T1307) Main Channel Outlet	Approved	Non-sensitive	N/A	Mechanical clearing will be performed to keep reach clear of all vegetation.	No change.
47*	Santa Clara River Main Channel (PD T1733 Unit 1)	Pending	Sensitive	2013-unarmored threespine stickleback (negative)	The reach clearing work will involve mechanical removal of all vegetation within 20 feet from the levee slope lining along the entire reach.	No change.
48	Mint Canyon Channel between Sierra Highway & Adon Avenue	Approved	Non-sensitive	N/A	Mechanical and hand clearing work will be performed to keep reach clear of all vegetation.	No change.
49	Mint Canyon Channel between Adon Avenue & Scherzinger Lane	Approved	Non-sensitive	N/A	All vegetation in this reach will be cleared annually using mechanical and manual methods.	No change. Maintenance plan has been fully implemented and there are no outstanding issues.

TABLE A-2. Permit Requirements for Soft-Bottom Channel Reaches

No.	Reach Name	Permit Status	Federal Reach Sensitivity (May Require USFWS Consultation)	Last Focused Survey	Previously Authorized or Proposed 2015 Maintenance Activities by Reach; Permit Conditions from Agencies to be Included	Explanation of Changes to Proposed 2015 Activity and/or Biological Resources Since Last Approved Maintenance Plan And Results of Los Angeles River Feasibility Study
50	Mint Canyon Channel between Solamint Road & Soledad Canyon Road	Approved	Non-sensitive	N/A	Mechanical and hand clearing work will be performed to keep reach clear of all vegetation.	No change.
51*	Mint Canyon M.C.O. (PD 1894)/Santa Clara River – Main Channel	Pending	Sensitive	2013-unarmored threespine stickleback (negative)	The reach clearing work will involve mechanical removal of all vegetation within 20 feet from the levee slope lining along the entire reach.	No change.
52	Sierra Highway Road Drainage (CDR 523.203)	Approved	Non-sensitive	N/A	Mechanical and hand clearing work will be performed to keep reach clear of all vegetation.	No change.
53*	Santa Clara River Non-Main Channel (PD 832) Main Channel Inlet	Approved	Non-sensitive	N/A	Mechanical and hand clearing work will be performed to keep reach clear of all vegetation.	No change. Identified as a potential UTS reach during initial informal consultation with the USFWS, but surveys by Dr. Baskin and Dr. Haglund determined that this reach has no potentially suitable habitat for UTS.
54*	Santa Clara River Non-Main Channel (PD 832) Main Channel Outlet	Pending	Sensitive	2013-unarmored threespine stickleback (negative)	Mechanical and hand clearing work will be performed to keep reach clear of all vegetation.	No change.
55*	Santa Clara River Main Channel – Right Bank Reach (PD’s 910, 832, 1758, & 1562 Unit 2)	Pending	Sensitive	2013-unarmored threespine stickleback (negative)	The reach clearing work will involve mechanical removal of all vegetation within 20 feet from the levee slope lining along the entire reach.	No change. Reaches 60, 59, and 58 are no longer combined with 55.
56*	Santa Clara River Main Channel – Left Bank Reach (PD 832)	Pending	Sensitive	2013-unarmored threespine stickleback (negative)	The reach clearing work will involve mechanical removal of all vegetation within 20 feet from the levee slope lining along the entire reach.	No change.
57	Whites Canyon (PD T704 M.C.I.)	Approved	Non-sensitive	N/A	Mechanical or hand clearing work will be performed to keep reach clear of all vegetation.	No change.
58*	Santa Clara River Main Channel – Right Bank Reach (PD 374)	Pending	Sensitive	2013-unarmored threespine stickleback (negative)	The reach clearing work will involve mechanical removal of all vegetation within 20 feet from the levee slope lining along the entire reach.	No change. Reaches 60, 59, and 58 are no longer combined with 55. Reach 59 is now combined with Reach 58.
60*	Santa Clara River Main Channel – Right Bank Reach (PD’s 1339 and 374)	Pending	Sensitive	2013-unarmored threespine stickleback (negative)	The reach clearing work will involve mechanical removal of all vegetation within 20 feet from the levee slope lining along the entire reach.	No change. Reaches 60, 59, and 58 are no longer combined with 55.
61*	Santa Clara River Main Channel (PD 659 & 754)	Pending	Sensitive	2013-unarmored threespine stickleback (negative)	The reach clearing work will involve mechanical removal of all vegetation within 20 feet from the levee slope lining along the entire reach.	No change. Reach 62 is now combined with 61.
63*	Oak Ave Road Drainage (CDR 523.081)	Pending	Sensitive	2013-unarmored threespine stickleback (negative)	The reach clearing work will involve mechanized removal of all vegetation bank to bank.	No change.
64*	Soledad Canyon Road Drain (CDR 523.071 D outlet)	Pending	Sensitive	2013-unarmored threespine stickleback (negative)	The reach clearing work will involve mechanical (rubber-tire equipment) and manual methods to clear an 8-foot-wide path along the centerline of the channel.	The use of rubber-tire equipment will be implemented. Maintenance activities revised to allow for additional removal techniques. Maintenance plan has been fully implemented.
66*	Santa Clara River Main Channel (PD 1538)	Pending	Sensitive	2013-unarmored threespine stickleback (negative)	The reach clearing work will involve mechanical removal of all vegetation within 20 feet from the levee slope lining along the entire reach.	No change.

TABLE A-2. Permit Requirements for Soft-Bottom Channel Reaches

No.	Reach Name	Permit Status	Federal Reach Sensitivity (May Require USFWS Consultation)	Last Focused Survey	Previously Authorized or Proposed 2015 Maintenance Activities by Reach; Permit Conditions from Agencies to be Included	Explanation of Changes to Proposed 2015 Activity and/or Biological Resources Since Last Approved Maintenance Plan And Results of Los Angeles River Feasibility Study
67*	Bouquet Canyon Upper (PD's 1201, 802, 700B, & 625)	Pending	Sensitive	2013-unarmored threespine stickleback (negative)	<p>The reach clearing work will involve an alternating pattern of mechanical clearing of vegetation. Only one-half of the reach will be cleared each year. The other one-half of the reach will be cleared the following year. Reach clearing work will also include mechanical grading of sediment to train flows to the centerline of the reach. Outlet structures will be graded to drain each year.</p> <p>The preferred methodology would be to clear the vegetation on the left bank on even years and the right bank on odd years. If water is present on the scheduled bank, however, the work will proceed with the opposite bank.</p>	<p>Reach 67 and 69 are no longer combined. Additional scheduling language added.</p> <p>The 2002 focused surveys did not find the unarmored threespine stickleback in this reach; however, it was determined that this reach could support the stickleback in subsequent years. Therefore, if suitable habitat is present (i.e. water), stickleback surveys are required prior to clearing activities. The stickleback was found during pre-clearing surveys conducted in 2005, 2006, and 2007, and no clearing activities occurred.</p> <p>After the October 2007 Buckweed Wildfire in the Bouquet Canyon Watershed, the LACFCD applied for a Regional General Permit (RGP) 63 permit with the USACE to authorize emergency vegetation and sediment clearing in the Bouquet Canyon flood-control reaches. The USACE issued the RGP 63 on January 22, 2008, following consultations with the U.S. Fish and Wildlife Service (USFWS), the CDFW, and the RWQCB. The pre-clearing survey conducted in January 2008 found just one stickleback. This fish was left in the reach during clearing activities, but protected with a buffer of at least 10 feet around the pool that contained it. These survey results show that without annual clearing activities, the habitat in the flood-control reach becomes less suitable for the stickleback. In particular, the annual clearing activities maintain a well-defined low flow reach that provides suitable habitat for the stickleback.</p> <p>Since 2008, the LACFCD has performed annual clearing activities that use a rotational pattern where half the reach is cleared one year and the other half is cleared the following year. This clearing pattern will consequently clear vegetation that is two years old. This clearing pattern will produce a dense growth of riparian herb vegetation and not allow the tall growth that can become a liability under high flow conditions. This maintenance pattern appears to be optimal for stickleback in this man- made flood-control reach.</p>
69*	Bouquet Canyon Middle (PD's 722, 773, 1365, 1065, & 451)	Pending	Sensitive	2013-unarmored threespine stickleback (positive)	<p>The reach clearing work will involve an alternating pattern of mechanical clearing of vegetation. Only one-half of the reach will be cleared each year. The other one-half of the reach will be cleared the following year. Reach clearing work will also include mechanical grading of sediment to train flows to the centerline of the reach. Outlet structures will be graded to drain each year.</p> <p>The preferred methodology would be to clear the vegetation on the left bank on even years and the right bank on odd years. If water is present on the scheduled bank, however; the work will proceed with the opposite bank.</p>	<p>Reach 67 and 69 are no longer combined. Additional scheduling language added.</p> <p>The 2002 focused surveys did not find the unarmored threespine stickleback in this channel reach; however, it was determined that this channel reach could support the stickleback in subsequent years. Therefore, if suitable habitat is present (i.e. b water), stickleback surveys are required prior to clearing activities. The stickleback was found during pre-clearing surveys conducted in 2005, 2006, and 2007, and no clearing activities occurred.</p> <p>After the October 2007 Buckweed Wildfire in the Bouquet Canyon Watershed, the LACFCD applied for a Regional General Permit (RGP) 63 permit with the USACE to authorize emergency vegetation and sediment clearing in the Bouquet Canyon flood-control reaches. The USACE issued the RGP 63 on January 22, 2008, following consultations with the USFWS, CDFW, and the RWQCB. The pre-clearing survey conducted in January 2008 found just one stickleback. This fish was left in reach 67 during clearing activities, but protected with a buffer of at least 10 feet around the pool that contained it.</p> <p>These survey results show that without annual clearing activities, the habitat in the flood-control reach becomes less suitable for the stickleback. In particular, the annual clearing activities maintain a well-defined low flow reach that provides suitable habitat for the stickleback.</p> <p>Since 2008, the LACFCD has performed annual clearing activities that use a rotational pattern where half the reach is cleared one year and the other half is cleared the following year. This clearing pattern will consequently clear vegetation that is two years old. This clearing pattern will produce a dense growth of riparian herb vegetation and not allow the tall growth that can become a liability under high flow conditions. This maintenance pattern appears to be optimal for stickleback in this man- made flood-control reach.</p>

TABLE A-2. Permit Requirements for Soft-Bottom Channel Reaches

No.	Reach Name	Permit Status	Federal Reach Sensitivity (May Require USFWS Consultation)	Last Focused Survey	Previously Authorized or Proposed 2015 Maintenance Activities by Reach; Permit Conditions from Agencies to be Included	Explanation of Changes to Proposed 2015 Activity and/or Biological Resources Since Last Approved Maintenance Plan And Results of Los Angeles River Feasibility Study
70*	Bouquet Canyon Lower (PD's 544 & 345)	Pending	Sensitive	2013-unarmored threespine stickleback (negative)	<p>The reach clearing work will involve an alternating pattern of mechanical clearing of vegetation. Only one-half of the reach will be cleared each year. The other one-half of the reach will be cleared the following year. Reach clearing work will also include mechanical grading of sediment to train flows to the centerline of the reach. Outlet structures will be graded to drain each year.</p> <p>The preferred methodology would be to clear the vegetation on the left bank on even years and the right bank on odd years. If water is present on the scheduled bank, however; the work will proceed with the opposite bank.</p>	<p>Maintenance language revised to account for current conditions post-emergency clearing. Additional scheduling language added.</p> <p>Reach 70 and 68 are no longer combined, as 68 was removed. Note that Reach 70 is not concrete-lined but is soft-bottomed.</p> <p>Maintenance plan has been fully implemented. The 2002 focused surveys did not find the unarmored threespine stickleback in this reach; however, it was determined that the upper end of this channel reach could support the unarmored threespine stickleback in subsequent years (this is a mostly dry channel). Therefore, if suitable habitat is present (i.e. water), unarmored threespine stickleback surveys are required prior to any clearing activities. The upper end of this reach was occupied in 2005, 2006, and 2007 as the water is continuous with Reaches 67 and 69. See those two reaches for further background information.</p>
71*	Santa Clara River Main Channel (PD 1946)	Pending	Sensitive	2013-unarmored threespine stickleback (negative), arroyo toad (negative), least Bell's vireo (negative) and southwestern willow flycatcher (negative)	<p>The reach clearing work will involve mechanized removal of all vegetation within 20 feet from the base of the slope lining along the entire reach.</p>	<p>No change.</p> <p>Identified as a potential LBV reach by BonTerra/Psomas biologists Brian Daniels and focused surveys for this species are conducted biannually. Focused surveys found a transitory male in 2013, but no breeding has yet been documented in this reach.</p> <p>The 2003 focused surveys found the arroyo toad within one kilometer of this reach. Since the USFWS defines occupied habitat for this species as any suitable habitat within one kilometer of an arroyo toad sighting, this reach was considered to be occupied by the toad.</p> <p>Maintenance plan has been fully implemented. After the arroyo toad detection in 2003, the USACE did not authorize clearing activities in Reaches 71 and 82 in the permit dated December 9, 2003, because these reaches are considered occupied by the arroyo toad. A formal Biological Opinion dated October 21, 2004, was rendered by the USFWS for the channel clearing activities in Reaches 71 and 82. This Biological Opinion provided "take" to the USACE in order to permit the LACFCD to conduct these clearing activities as long as they were in compliance with the terms and conditions of the incidental take statement. The 2004 BO has since expired, and consultation will be reinitiated to determine if maintenance will require a new formal BO.</p>
72*	South Fork- SCR (Smizer Ranch M.C.I.)	Approved	Non-sensitive	N/A	<p>The reach clearing work will involve hand clearing dead vegetation and cutting invasive and trimming riparian vegetation that would obstruct flows. Tree canopy will be retained, yet a clear "tunnel" path will be provided to convey flows.</p>	<p>No change.</p> <p>Identified as a potential UTS reach during initial informal consultation with the USFWS, but surveys by Dr. Baskin and Dr. Haglund determined that this reach has no potentially suitable habitat for UTS (the drop structure under the Valencia Bridge prevents UTS from migrating upstream in the South Fork Santa Clara River).</p>
73	Wildwood Canyon Channel (PD T361) Main Channel Inlet	Approved	Non-sensitive	N/A	<p>Mechanical and hand clearing work will be performed to keep reach clear of all vegetation.</p>	<p>No change.</p>
74	Wildwood Canyon Channel (PD T361)	Approved	Non-sensitive	N/A	<p>Mechanical or hand clearing work will be performed to keep reach clear of all vegetation.</p>	<p>No change.</p>

TABLE A-2. Permit Requirements for Soft-Bottom Channel Reaches

No.	Reach Name	Permit Status	Federal Reach Sensitivity (May Require USFWS Consultation)	Last Focused Survey	Previously Authorized or Proposed 2015 Maintenance Activities by Reach; Permit Conditions from Agencies to be Included	Explanation of Changes to Proposed 2015 Activity and/or Biological Resources Since Last Approved Maintenance Plan And Results of Los Angeles River Feasibility Study
75*	South Fork - Santa Clara River (PD's 725, 916, 1041, & 1300)	Pending	Sensitive	2013- arroyo toad (negative), least Bell's vireo (negative), and southwestern willow flycatcher (negative)	The reach clearing work will involve mechanical clearing and grading of all vegetation bank to bank from Lyons Avenue to Orchard Village Road. Mechanical grading and clearing of invasive vegetation from bank to bank will be performed from Orchard Village Road to the confluence with Newhall Creek. Mechanical clearing of all vegetation will be done along the base of the concrete levee from the confluence with Newhall Creek to Magic Mountain Parkway. A 20-foot-wide strip will be maintained clear along the entire length of the levee and 45 degree grading of low flow channels from side outlets to the center of the watercourse will be maintained clear of all vegetation to minimize ponding and blockage of side outlet flows. A 12' wide centerline low flow channel will be maintained clear of all vegetation and will be graded along the entire length in this reach. Two island areas supporting mature trees will be left in place as well as the riparian vegetation. Tree pruning of dead branches and limbs that could obstruct flow will be removed by hand labor.	No change. Identified as a potential UTS reach during initial informal consultation with the USFWS, but surveys by Dr. Baskin and Dr. Haglund determined that this reach has no potentially suitable habitat for UTS (the drop structure under the Valencia Bridge prevents UTS from migrating upstream in the South Fork Santa Clara River).
76	Pico Canyon (PD 813)	Approved	Non-sensitive	N/A	The reach clearing work will involve bank-to-bank removal of vegetation using mechanical equipment.	No change.
77*	Newhall Creek Outlet	Approved	Non-sensitive	N/A	Mechanical equipment will be used to maintain the reach clear of all vegetation.	No change. Identified as a potential LBV reach during initial informal consultation with the USFWS, but surveys by BonTerra biologist Brian E. Daniels determined no potential habitat for this species existed at the reach and focused LBV surveys were not warranted.
78*	Placerita Creek	Approved	Non-sensitive	N/A	Mechanical equipment will be used to maintain the reach clear of all vegetation.	No change. Identified as a potential LBV reach during initial informal consultation with the USFWS, but surveys by BonTerra biologist Brian E. Daniels determined no potential habitat for this species existed at the reach and focused LBV surveys were not warranted.
79*	South Fork - Santa Clara River (Valencia Boulevard Bridge Stabilizer)	Pending	Sensitive	2013-unarmored threespine stickleback (negative), arroyo toad (negative), least Bell's vireo (negative) and southwestern willow flycatcher (negative)	Mechanical equipment will be used to maintain the reach clear of all vegetation.	No change. Identified as a potential LBV reach by BonTerra Psomas biologists Brian Daniels and focused surveys for this species are conducted biannually. Focused surveys have been negative through 2013. The unarmored threespine stickleback cannot move upstream past the stabilizer under the Valencia Blvd. bridge. All waters upstream are unoccupied by the stickleback; all of the fish that have been observed occur only up to the base of the stabilizer.
80*	South Fork - Santa Clara River (PD's 1947 & 1946)	Pending	Sensitive	2013-unarmored threespine stickleback (negative), arroyo toad (negative), least Bell's vireo (negative) and southwestern willow flycatcher (negative)	The reach clearing work will involve mechanical removal of all vegetation within 20 feet from the toe of the concrete levee along the entire length.	No change. Identified as a potential LBV reach by BonTerra Psomas biologists Brian Daniels and focused surveys for this species are conducted biannually. Focused surveys have been negative through 2013.

TABLE A-2. Permit Requirements for Soft-Bottom Channel Reaches

No.	Reach Name	Permit Status	Federal Reach Sensitivity (May Require USFWS Consultation)	Last Focused Survey	Previously Authorized or Proposed 2015 Maintenance Activities by Reach; Permit Conditions from Agencies to be Included	Explanation of Changes to Proposed 2015 Activity and/or Biological Resources Since Last Approved Maintenance Plan And Results of Los Angeles River Feasibility Study
82*	Santa Clara River Main Channel (PD 2278)	Pending	Sensitive	2013-unarmored threespine stickleback (negative), arroyo toad (negative), least Bell's vireo (negative) and southwestern willow flycatcher (negative)	The reach clearing work will involve mechanized removal of all vegetation within 20 feet from the base of the slope lining along the entire reach.	<p>No change.</p> <p>Maintenance plan has been fully implemented.</p> <p>Identified as a potential LBV reach by BonTerra Psomas biologists Brian Daniels and focused surveys for this species are conducted biannually. Focused surveys have been negative through 2013.</p> <p>The 2003 focused surveys found the arroyo toad within one kilometer of this reach. Since the USFWS defines occupied habitat for this species as any suitable habitat within one kilometer of an arroyo toad sighting, this reach was considered to be occupied by the toad.</p> <p>After the arroyo toad detection in 2003, the USACE did not authorize clearing activities in Reaches 71 and 82 in the permit dated December 9, 2003, because these reaches are considered occupied by the arroyo toad. A formal Biological Opinion dated October 21, 2004, was rendered by the USFWS for the channel clearing activities in Reaches 71 and 82. This Biological Opinion provided "take" to the ACOE USACE in order to permit the LACFCD to conduct these clearing activities as long as they were in compliance with the terms and conditions of the incidental take statement. The 2004 BO has since expired, and consultation will be reinitiated to determine if maintenance will require a new formal BO.</p>
86*	Violin Canyon Main Channel Outlet	Pending	Sensitive	2013 - unarmored threespine stickleback (negative) and arroyo toad (negative)	Mechanical equipment will be used to maintain the reach clear of all vegetation.	<p>No change.</p> <p>Maintenance plan has been fully implemented.</p> <p>Identified as a potential LBV reach by BonTerra Psomas biologists Brian Daniels and focused surveys for this species are conducted biannually. Focused surveys have been negative through 2013.</p> <p>The 2002 focused surveys did not find the unarmored threespine stickleback in this reach; however, it was determined that this reach could support the unarmored threespine stickleback in subsequent years. Therefore, if suitable habitat is present (i.e. water), unarmored threespine stickleback surveys are required prior to any clearing activities.</p>
87*	Castaic - Old Road Drainage (CDR 525.021D) Outlet	Pending	Sensitive	2013 - unarmored threespine stickleback (negative), arroyo toad (negative), least Bell's vireo (negative) and southwestern willow flycatcher (negative)	The reach clearing work will involve hand cutting and clearing a 20-foot path from the riprap outlet to the main watercourse, Castaic Creek.	<p>No change.</p> <p>Identified as a potential LBV reach by BonTerra Psomas biologists Brian Daniels and focused surveys for this species are conducted biannually. Focused surveys have been negative through 2013.</p>
88*	Hasley Canyon Upper (PD T1496)	Approved	Non-sensitive	N/A	The reach clearing work will involve mechanical equipment to remove all vegetation from bank to bank from Sharp Road to 755 feet upstream. From 330 feet downstream of Sharp Road to Sharp Road, hand clearing will be done.	<p>No change.</p> <p>Identified as a potential LBV reach during initial informal consultation with the USFWS, but surveys by BonTerra biologist Brian E. Daniels determined no potential habitat for this species existed at the reach and focused LBV surveys were not warranted.</p>
89*	Hasley Canyon South Fork (PD T1496)	Approved	Non-sensitive	N/A	The reach clearing work will involve hand labor clearing of alluvial sage scrub.	<p>No change.</p> <p>Identified as a potential LBV reach during initial informal consultation with the USFWS, but surveys by BonTerra biologist Brian E. Daniels determined no potential habitat for this species existed at the reach and focused LBV surveys were not warranted.</p>
90	Hasley Canyon Lower (North Fork PD T1496)	Approved	Non-sensitive	N/A	The reach clearing work will involve hand clearing and mechanized removal of vegetation. Portions of the reach bottom will be denuded of vegetation while leaving the earthen bank vegetated, clusters of mature growth in the reach bottom will remain to the level it was left in November 1997.	<p>No change.</p>

TABLE A-2. Permit Requirements for Soft-Bottom Channel Reaches

No.	Reach Name	Permit Status	Federal Reach Sensitivity (May Require USFWS Consultation)	Last Focused Survey	Previously Authorized or Proposed 2015 Maintenance Activities by Reach; Permit Conditions from Agencies to be Included	Explanation of Changes to Proposed 2015 Activity and/or Biological Resources Since Last Approved Maintenance Plan And Results of Los Angeles River Feasibility Study
91	San Martinez Chiquito Canyon Channel u/s of Kenningston Road	Approved	Non-sensitive	N/A	The reach clearing work will involve removal of all the vegetation within the pipe and wire reach using hand labor, but the embankment vegetation will be left in place.	No change.
92*	San Martinez Chiquito Canyon (North Fork) unnamed	Approved	Non-sensitive	N/A	The reach clearing work will involve removal of all the vegetation within the pipe and wire reach using hand labor, but the embankment vegetation will be left in place.	No change. Identified as a potential LBV reach during initial informal consultation with the USFWS, but surveys by BonTerra biologist Brian E. Daniels determined no potential habitat for this species existed at the reach and focused LBV surveys were not warranted.
93	San Martinez Chiquito Canyon between Kenningston Road and Val Verde Park	Approved	Non-sensitive	N/A	The reach clearing work will involve removal of all the vegetation within the pipe and wire reach using hand labor, but the embankment vegetation will be left in place.	No change.
94	San Martinez Chiquito Canyon between Val Verde Park to d/s of Madison Street	Approved	Non-sensitive	N/A	The reach clearing work will involve removal of all the vegetation within the pipe and wire reach using hand labor, but the embankment vegetation will be left in place.	No change.
95	Project No. 1224	Approved	Non-sensitive	N/A	The reach clearing work will involve removal of all the vegetation within the pipe and wire reach using mechanical equipment, but the embankment vegetation will be left in place.	No change.
96	PD 1591, Calabasas	Approved	Non-sensitive	N/A	The reach clearing will involve removing all the vegetation from the inlet and outlet approaches to the box culvert under Vicasa Drive. Clearing work will be done by hand labor and only within the dedicated right of way.	No change.
97*	PD T1982, Castaic Creek	Pending	Sensitive	2013-unarmored threespine stickleback (negative), arroyo toad (negative), least Bell's vireo (negative) and southwestern willow flycatcher (negative)	The reach clearing work will involve hand cutting and mechanized removal of all vegetation and trees along the entire length of the levee at a width of 20 feet and clearing and grading 45-degree, 12-foot-wide low flows from the side outlets to the center of the main watercourse.	No change. Identified as a potential LBV reach by BonTerra/Psomas biologists Brian Daniels and focused surveys for this species are conducted biannually. Focused surveys have been negative through 2013.
98	Walnut Creek – Channel Inlet	Approved	Non-sensitive	N/A	To the extent that storm flows do not keep the inlet free of vegetation, mechanical equipment will be used to keep the inlet clear of all vegetation. No regrowth will be allowed to remain.	No change.
99	Kagel Canyon – Tujung Wash	Approved	Non-sensitive	N/A	Hand clearing work will be performed to keep all the vegetation clear in this reach.	No change.
100	Dry Canyon, Calabasas Creek Inlet	Approved	Non-sensitive	N/A	The reach clearing work will involve hand clearing all the vegetation at the reach inlet. Bank vegetation will be left in place.	No change.
101*	Violin Canyon (PD 2312)	Pending	Sensitive	2003 - plant surveys (negative) 2007 - arroyo toad (negative) 2014-Santa Clara River feasibility Study plant surveys (negative)	LACFCD will mechanically remove vegetation along a 12-foot wide path along the toe of the reach slope lining and clear a 12-foot training channel at 45 degree angles from the outlet to the centerline of the reach.	The proposed 2015 maintenance activities affect less area than the proposed 2005 maintenance activities. All of the reach was proposed for clearing in 2005, in alternating halves, but in 2015 the clearing is limited to 12-foot wide path at toe of the reach slope lining on both banks.

Note:

* Sensitive Species identified in Table 3-3.

Appendix D Concrete-Lined Channel Reaches

This page intentionally left blank.

TABLE B-1. Concrete-Lined Channels List

(revised July 2014)

REACH No.	DESCRIPTION	UPSTREAM LIMIT (U/P)	DOWNSTREAM LIMIT (D/S)	HYDRO UNIT CODE	CITY	TG	LF	CHANNEL TYPE	NOTES
WEST AREA - HANSEN YARD									
1	ALISO (UPPER)	ALISO DEBRIS BASIN	WILBUR DEBRIS BASIN	180701050203	GRANADA HILLS - NORTHRIDGE	501-A2 to 500-G7	17380	RECTANGULAR	
2	ALISO (LOWER)	WILBUR DEBRIS BASIN	LOS ANGELES RIVER	180701050203	NORTHRIDGE - RESEDA	530-G1 to 530-H6	15939	RECTANGULAR	
3	BELL CREEK	BELL DEBRIS RET INLET	LOS ANGELES RIVER	180701050201	WEST HILLS - CANOGA PARK	529-D6 to 529-H6	13912	RECT / TRAP	
4	BELL CREEK - SOUTH BRANCH	HAYNES STREET	BELL CREEK	180701050201	WOODLAND HILLS	529-G6 to 529-G5	3312	TRAPEZOIDAL	
5	BELL CREEK - SOUTH FORK	CALVERT STREET	BELL CREEK	180701050201	WOODLAND HILLS	529-D7 to 529-F6	7910	TRAPEZOIDAL	
6	BROWNS CREEK	583 FT U/S OF RINALDI	LOS ANGELES RIVER	180701050202	CHATSWORTH-WINNETKA	500-B2 to 530-D6	30054	RECTANGULAR	TG ... to530-C6
7	BULL CREEK	RINALDI STREET	VICTORY BLVD	180701050204	GRANADA HILLS-LAKE BALBOA	481-E1 to 531-D7	37109	RECT / TRAP	TG 481-E5
8	BULL CREEK - RESERVOIR BRANCH	SAN FERN. RESERVOIR	BULL CREEK	180701050204	GRANADA HILLS	481-E6 to 501-E1	6616	RECT / TRAP	
9	BULL CREEK TRIBUTARY- (GRANADA CHANNEL & PROJECT 5216)	355 FT U/S OF LASSEN STREET	BULL CREEK	180701060102	NORTH HILLS	501-D5 to 501-E5	1089	RECTANGULAR	
10	BURBANK EASTERN - BRAND CHANNEL	BRAND DEBRIS BASIN	220 FT D/S OF BRAND D.B.	180701050208	GLENDALE	534-B7	220	RECTANGULAR	
11	BURBANK WESTERN SYSTEM	LA TUNA CANYON CHANNEL	VICTORY BOULEVARD	180701050208	SUN VALLEY-BURBANK	533-B1 to 563-H2	27253	RECTANGULAR	
12	CABALLERO CREEK	228 FT U/S OF RESEDA BOULEVARD	LOS ANGELES RIVER	180701050208	TARZANA	560-J4 to 531-A7	13903	RECTANGULAR	
13	CALABASAS CREEK	VALLEY CIRCLE BOULEVARD	LOS ANGELES RIVER	180701050201	WOODLAND HILLS-CANOGA PARK	559-F3 to 530-A6	16270	RECTANGULAR	
14	CHANDLER CANYON CHANNEL	CHANDLER DEBRIS BASIN	GLENCREST AVENUE	180701050208	SUN VALLEY	533-C1 to 533-B2	3295	RECTANGULAR	
15	CHATSWORTH CREEK	D/S FACE OF ROSCOE BOULEVARD	DAYTON CREEK	180701050201	WEST HILLS	529-G2 to 529-G3	1027	RECTANGULAR	
16	CHESEBORO CANYON CHANNEL	DRIVER AVENUE	CORNELL ROAD	180701040102	AGOURA HILLS	558-C6 to 558-A6	6368	RECTANGULAR	
17	DAYTON CREEK	VALLEY CIRCLE BLVD	BELL CREEK	180701050201	WEST HILLS - CANOGA PARK	499-E2 to 499-H5	10718	RECT / TRAP	
18	DRY CANYON (CALABASAS)	1812 FT U/S OF SAN LUIS AVENUE	CALABASAS CREEK	180701050201	WOODLAND HILLS	559-G4 to 559-F3	3223	RECTANGULAR	
19	EAST CANYON CHANNEL	CONFLUENCE OF SYLMAR & STETSON CHANNEL	PACOIMA WASH	180701050206	SLYMAR-PACOIMA	481-G4 to 502-A3	13566	RECTANGULAR	
20	HANSEN HEIGHTS CHANNEL	STONEHURST AVENUE	BURBANK WESTERN SYSTEM	180701050208	SUN VALLEY	503-A5 to 533-B1	8511	RECTANGULAR	
21	LAS VIRGENES CREEK (PD's 492, 1463, 1522, & 1684)	VENTURA COUNTY LINE	190 FT D/S OF PARKMOR	180701040103	CALABASAS	558-H3 to 558-H5	6205	RECTANGULAR	
22	LAS VIRGENES CREEK (PD 2055) - UNIT A	300' U/S OF LOST HILLS RD	600' D/S OF LOST HILLS RD	180701040103	CALABASAS	588-G1	1100	RECTANGULAR	Formerly SBC Reach 31
23	LAS VIRGENES CREEK (PD 2055) - UNIT B	475' UPSTREAM OF MEADOW CREEK LN	222' U/S OF MEADOW CREEK LN	180701040103	CALABASAS	588-G1	253	TRAPEZOIDAL	Formerly SBC Reach 31
24	LIBERTY CANYON CHANNEL (PD's 571 & 572)	757 FT U/S OF COUNTRY GLEN ROAD	1611 FT D/S OF COUNTRY GLEN ROAD	180701040103	AGOURA HILLS	588-E1 to 558-E7	2368	TRAPEZOIDAL	
25	LIMEKILN CREEK	LIMEKILN DEBRIS BASIN	WILBUR DEBRIS BASIN	180701050203	NORTHRIDGE	500-F4 to 500-G7	15798	RECTANGULAR	
26	LINDERO CANYON CHANNEL	LAKE LINDERO ROAD	221 FT D/S OF LAKE LINDERO ROAD	180701040102	AGOURA HILLS	557-G5	221	RECTANGULAR	
27	LOPEZ CANYON CHANNEL	916 FT U/S OF FILMORE STREET	1585 FT D/S OF FOOTHILL BOULEVARD	180701050105	LAKE VIEW TERRACE	482-F6 to 502-G2	8136	RECTANGULAR	
28	LOS ANGELES RIVER (LOWER)	3,369 FT D/S OF SEPULVEDA BASIN	1700 FT D/S LANKERSHIM	180701050208	SHERMAN OAKS-TOLUCA LAKE	561-G2 to 563-B5	37749	RECTANGULAR	
29	LOS ANGELES RIVER (UPPER)	CONFLUENCE OF BELL & CALABASAS CREEKS	100 FT U/S OF MTA TRACKS	180701050208	CANOGA PARK-RESEDA	531-A6 to 531-C7	28986	TRAPEZOIDAL	
30	MANSFIELD CANYON CHANNEL	SCHOOLHOUSE CANYON DEBRIS BASIN	APARAT STREET	180701050206	SYLMAR	481-H2 to 482-J2	1300	RECTANGULAR	must be ARARAT ST.
31	MAY CANYON CHANNEL	MAY DEBRIS BASIN	125 FT D/S OF EGBERT STREET	180701050206	OLIVE VIEW	482-C1	1750	RECTANGULAR	
32	MEDEA CREEK-UPPER (PD'S 1005 & 1231)	THOUSAND OAKS BLVD	535 FT D/S OF KANAN RD	180701040102	AGOURA HILLS	558-A4 to 558-A5	1894	RECT / TRAP	
33	MEDEA CREEK (LOWER)	ROADSIDE DRIVE	613 FT D/S OF AGOURA ROAD	180701040102	AGOURA HILLS	558-A6	1345	RECTANGULAR	
34	TUJUNGA WASH CENTRAL BRANCH (MTD'S 30 & 117 & PD 462)	VANOWEN STREET	LOS ANGELES RIVER	180701050208	NORTH HOLLYWOOD-STUDIO CITY	532-F5 to 563-A5	15252	RECTANGULAR	
35	MTD 646	150 FT U/S OF ROMERO DRIVE	150 FT D/S OF ROMERO DRIVE	180701050208	TARZANA	560-G5	308	RECTANGULAR	
36	MTD 963	1530 FT U/S OF VALLEY CIRCLE BOULEVARD	VALLEY CIRCLE BOULEVARD	180701050201	WEST HILLS	529-D5	1530	RECTANGULAR	

TABLE B-1. Concrete-Lined Channels List

(revised July 2014)

REACH No.	DESCRIPTION	UPSTREAM LIMIT (U/P)	DOWNSTREAM LIMIT (D/S)	HYDRO UNIT CODE	CITY	TG	LF	CHANNEL TYPE	NOTES
WEST AREA - HANSEN YARD									
37	MTD 1008 (F1789)	ACCESS ROAD TO INLET	ACCESS ROAD TO HAVENWAY DEBRIS BASIN	180701050208	BURBANK	533-G3	440	TRAPEZOIDAL	
38	PACOIMA DIVERSION CHANNEL	PACOIMA SPREADING GROUNDS	TUJUNGA WASH	180701050208	PACOIMA-ARLETA	502-A3 to 532-D1	15874	TRAPEZOIDAL	
39	PACOIMA WASH (UPPER)	LOPEZ DEBRIS BASIN	PACOIMA SPREADING GROUNDS	180701050206	SAN FERNANDO-PACOIMA	482-E4 to 502-A4	18681	TRAPEZOIDAL	
40	PACOIMA WASH (LOWER)	PLUMMER STREET	VAN NUYS BOULEVARD	180701050206	PACOIMA-VAN NUYS	502-A4 to 532-A6	16384	TRAP / RECT	
41	PARTHENIA STREET DRAIN	RAYMER STREET	WHITE OAK AVENUE	180701050208	NORTHRIDGE	531-B1 to 531-B2	1233	ASPHALT	
42	PRIVATE DRAIN 1410	181 FT D/S OF RED BLUFF DRIVE	888 FT U/S OF RED BLUFF DRIVE	180701040103	CALABASAS	558-J4	1068	TRAPEZOIDAL	
43	PRIVATE DRAINS 728 & 936 (RUSSELL AND TRIUNFO CREEKS)	914 FT U/S OF LA TIENDA ROAD	62 FT U/S OF FOXFIELD DRIVE	180701040104	WESTLAKE VILLAGE	557-D5 to 557-C7	6127	TRAPEZOIDAL	
44	PROJECT 107	SAN FERNANDO ROAD	PACOIMA DIVERSION CHANNEL	180701050208	ARLETA-SUN VALLEY	502-F5 to 502-D7	7840	TRAPEZOIDAL	
45	PROJECT 112 (KELVIN CHANNEL)	487 FT U/S OF VENTURA FRWY	LOS ANGELES RIVER	180701050208	WARNER CENTER	560-C2 to 530-C6	3974	RECT / TRAP	
46	PROJECT 461	714 FT D/S OF PIERCE STREET	SAN FERNANDO ROAD	180701050208	PACOIMA	502-D3 to 502-F5	5764	RECTANGULAR	
47	PROJECT 472 & 5226	BALBOA BOULEVARD	LOUISE AVENUE	180701050208	NORTHRIDGE	531-C2	1947	RECTANGULAR	
48	PROJECT 85	PACOIMA WASH	TUJUNGA WASH	180701050206	NORTH HILLS-VAN NUYS	531-J3 to 532-C4	6135	RECT / TRAP	
49	PROJECT 88	BURNETT AVENUE	PACOIMA WASH	180701050206	NORTH HILLS	531-H1	1595	RECTANGULAR	
50	SANTA SUSANA CREEK	1998 FT U/S OF TULSA STREET	BROWNS CREEK	180701050202	CHATSWORTH	499-J2 to 530-B1	19918	RECTANGULAR	
51	STETSON CANYON CHANNEL	FOOTHILL BOULEVARD	EAST CANYON CHANNEL	180701050204	SYLMAR	481-G2 to 481-G4	4019	RECTANGULAR	
52	TUJUNGA WASH	HANSEN DAM	LOS ANGELES RIVER	180701050208	SUN VALLEY-STUDIO CITY	502-H4 to 562-H5	49938	RECTANGULAR	
54	WILBUR CREEK	CHATSWORTH STREET	ALISO CREEK	180701050203	NORTHRIDGE	500-H3 to 500-H6	7569	RECTANGULAR	
55	WILSON CANYON CHANNEL	WILSON DEBRIS BASIN	ASTORIA STREET	180701050206	OLIVE VIEW	482-A1 to 482-A3	7320	RECTANGULAR	
56	WILSON CANYON CHANNEL - MAY CANYON LATERAL	FOOTHILL BOULEVARD	WILSON CANYON CHANNEL	180701050206	SYLMAR	482-C4	537	RECTANGULAR	
294	PROJECT 470 HAYVENHURST DRAIN	HAYVENHURST AVE	316' U/S OF HAYVENHURST AVE	180701050208	ENCINO	561-E3	316	TRAPEZOIDAL	
WEST AREA - PICKENS YARD									
57	BLANCHARD CANYON CHANNEL	BLANCHARD DEBRIS BASIN	VERDUGO WASH	180701050207	TUJUNGA	504-C4 to 504-C7	5,283	RECTANGULAR	
58	BLUE GUM CANYON CHANNEL	BLUE GUM DEBRIS BASIN	90 FT D/S OF BLUE GUM DEBRIS BASIN	180701050105	TUJUNGA	504-B4	90	RECTANGULAR	
59	CLOUD CREEK CHANNEL	CLOUD CREEK DEBRIS BASIN	950 FT D/S OF CLOUD CREEK DEBRIS BASIN	180701050207	LA CRESCENTA	504-F5	978	RECTANGULAR	
60	COOKS CANYON CHANNEL	COOKS DEBRIS BASIN	VERDUGO WASH	180701050207	GLENDALE-TUJUNGA	504-D5 to 504-C7	5,743	RECTANGULAR	
61	DUNSMUIR CANYON CHANNEL	DUNSMUIR DEBRIS BASIN	VERDUGO WASH	180701050207	GLENDALE	504-E5 to 534-E1	8,303	RECTANGULAR	
62	EAGLE CANYON CHANNEL-UPPER (PD's 503, 607, 670, & 1081)	STARFALL DEBRIS BASIN	EAGLE CANYON DEBRIS BASIN	180701050207	LA CRESCENTA	504-G5 to 504-G6	4,397	RECTANGULAR	
63	EAGLE CANYON CHANNEL-LOWER (ACOE PROJECT)	EAGLE CANYON DEBRIS BASIN	VERDUGO WASH	180701050207	LA CRESCENTA-GLENDALE	504-G6 to 534-E2	6,962	RECTANGULAR	
64	FLINT CANYON CHANNEL	WOODLEIGH AVENUE	800 FT D/S OF PARADISE CANYON CHANNEL CONFLUENCE	180701050209	LA CANADA FLINTRIDGE	535-C5 to 535-D5	2,026	RECTANGULAR	
65	FLINT CYN CHNL - WOODLEIGH DRAIN	BERKSHIRE AVENUE	FLINT CANYON CHANNEL	180701050209	LA CANADA FLINTRIDGE	535-C5 to 535-D5	323	RECTANGULAR	
66	GOULD CANYON CHANNEL	GOULD CANYON DEBRIS BASIN	PARADISE CANYON CHANNEL	180701050209	LA CANADA FLINTRIDGE	535-C2 to 535-D3	4,297	RECTANGULAR	
67	HAINES CANYON CHANNEL	40 FT U/S OF PLAINVIEW AVENUE	833 FT D/S OF WENTWORTH STREET	180701050208	TUJUNGA-SUNLAND	503-J4 to 503-F2	9,481	RECTANGULAR	
68	HALLS CANYON CHANNEL	HALLS CANYON DEBRIS BASIN	OAKMONT DEBRIS BASIN	180701050207	LA CANADA FLINTRIDGE-GLENDALE	534-J1 to 534-G4	8,076	RECTANGULAR	
69	HAY CANYON CHANNEL	HAY CANYON DEBRIS BASIN	FLINT CANYON CHANNEL	180701050209	LA CANADA FLINTRIDGE	535-A1 to 535-B4	9,674	RECTANGULAR	
70	OAK CREEK	138 FT D/S OF OAK CREEK DEBRIS BASIN	QUAIL CREEK	180701050207	LA CRESCENTA	504-F5	1,726	RECTANGULAR	
71	PARADISE CANYON CHANNEL	FOOTHILL BOULEVARD	FLINT CANYON CHANNEL	180701050209	LA CANADA FLINTRIDGE	535-D4 to 535-D5	2,043	RECTANGULAR	

TABLE B-1. Concrete-Lined Channels List

(revised July 2014)

REACH No.	DESCRIPTION	UPSTREAM LIMIT (U/P)	DOWNSTREAM LIMIT (D/S)	HYDRO UNIT CODE	CITY	TG	LF	CHANNEL TYPE	NOTES
WEST AREA - PICKENS YARD									
72	PICKENS CANYON CHANNEL	PICKENS DEBRIS BASIN	VERDUGO WASH	180701050207	LA CRESCENTA-GLENDALE	534-H1 to 534-G3	6,247	RECTANGULAR	
73	QUAIL CREEK CHANNEL	CONFLUENCE OF OAK CREEK AND CLOUD CREEK	EL CAMINITO	180701050207	LA CRESCENTA	504-F6	2,336	RECTANGULAR	
74	ROWLEY CANYON CHANNEL	ROWLEY DEBRIS BASIN	TUJUNGA CANYON BOULEVARD	180701050105	TUJUNGA	504-A2 to 504-J2	533	RECTANGULAR	TG ... 503-J2
75	SHIELDS CANYON CHANNEL	SHIELDS DEBRIS BASIN	EAGLE CANYON SPS	180701050207	LA CRESCENTA	504-F6 to 504-G6	1,488	RECTANGULAR	
76	SNOVER CANYON CHANNEL	SNOVER CANYON DEBRIS BASIN	HALLS CANYON DEBRIS BASIN	180701050207	LA CANADA FLINTRIDGE	504-J7 to 534-J1	2,236	RECTANGULAR	
77	SYCAMORE CANYON CHANNEL	DOLORES STREET	FLETCHER DRIVE	180701050210	ATWATER VILLAGE	594-F1	388	RECTANGULAR	FIVE SMALL OPEN SECTIONS OF CHANNEL PLACED FOR EQUIPMENT ACCESS INTO MUCH LARGER UNDERGROUND FACILITY
78	VERDUGO WASH (LOWER)	OAKMONT VIEW DEBRIS BASIN	LOS ANGELES RIVER	180701050207	GLENDALE	534-G4 to 564-B4	24,328	RECT / TRAP	
79	VERDUGO WASH (UPPER)	CONFLUENCE OF BLANCHARD AND COOKS	OAKMONT DEBRIS BASIN	180701050207	TUJUNGA-GLENDALE	504-C7 to 534-G4	16,823	RECTANGULAR	
80	WEBBER CANYON CHANNEL	912 FT U/S OF SNOVER CANYON CHANNEL	SNOVER CANYON CHANNEL	180701050207	LA CANADA-FLINTRIDGE	504-J7 to 534-J1	912	RECTANGULAR	
81	WINERY CANYON CHANNEL	WINERY CANYON DEBRIS BASIN	FLINT CANYON CHANNEL	180701050209	LA CANADA- FLINTRIDGE	535-A1 to 535-A4	8,215	RECTANGULAR	INCLUDES BOTH ARMY CORP AND LACFCD PORTIONS
82	ZACHAU CANYON CHANNEL	ZACHAU DEBRIS BASIN	423 FT D/S OF ZACHAU DEBRIS BASIN	180701050105	SUNLAND	503-J1	1,323	RECTANGULAR	TG ... J2
WEST AREA - SANTA CLARA YARD									
83	BOUQUET CANYON CHANNEL (PD 2225)	BOUQUET CANYON ROAD	173 FT D/S OF NEWHALL RANCH ROAD	180701020202	SANTA CLARITA	4550-H2	2,078	RECTANGULAR	
84	CDR 523.071-C & 523.071-D	550 FT SOUTH OF WISHBONE LANE	1050 FT NORTH OF GOLDEN OAK ROAD	180701020107	SANTA CLARITA	4551-C3 to 4551-B3	1,327	TRAPEZOIDAL	
85	CDR 523.071-E	EAST OF GLADDING WAY	EAST OF SQUIB STREET	180701020107	SANTA CLARITA	4551-B3 to 4551-A3	1,815	TRAPEZOIDAL	
86	CDR 523.081	OAK AVENUE	COTTONWOOD AVENUE	180701020107	SANTA CLARITA	4551-C2	2,418	TRAPEZOIDAL	
87	CDR 525.014	CASTAIC ROAD	LAKE HUGHES ON RAMP TO THE GOLDEN STATE FREEWAY	180701020301	CASTAIC	4369-G6	115	TRAPEZOIDAL	
88	DRY CANYON-SAUGUS (PD'S 928, 1106, 1256, 1954, 1971, & 2225)	920 FT U/S OF BOXWOOD LANE	BOUQUET CANYON CHANNEL	180701020202	SANTA CLARITA	4460-J2 to 4550-H1	16,941	RECT / TRAP	
89	HASKELL CANYON CHANNEL	COPPER HILL DRIVE	BOUQUET CANYON CHANNEL	180701020202	SAUGUS-SANTA CLARITA	4461-B4 to 4461-B6	5,404	RECT / TRAP	
90	LYON CHANNEL	576 FT U/S OF SANTA CLARA RIVER-SOUTH FORK	SANTA CLARA RIVER-SOUTH FORK	180701020401	SANTA CLARITA	4640-F2	576	RECT / TRAP	
91	NEWHALL CREEK	SAN FERNANDO ROAD	1069 FT D/S OF 15TH STREET	180701020401	SANTA CLARITA	4550-J7 to 4550-H7	3,188	RECTANGULAR	
92	PLUM CANYON CHANNEL (PD's 625-B & 1540)	1339 FT U/S OF RODGERS DRIVE	BOUQUET CANYON CHANNEL	180701020202	SANTA CLARITA	4461-E6 to 4461-C5	3,975	TRAPEZOIDAL	PD 1540(Sta. 41+75.37 - Sta. 11+58.54) PD 625-B(Sta. 11+58.54 - Sta. 2+00.19)
93	PORRETTA CHANNEL (PD's 246, 266, & 313)	VICCI STREET	SANTA CLARA RIVER	180701020107	SANTA CLARITA	4551-G2 to 4551-E2	5,903	TRAPEZOIDAL	PD 246 (Sta. 31+77.42 - Sta. 2+36.21) PD 266 (Sta. 14+24.21 - Sta. 1+96) PD 313 (Sta. 17+33.15 - 0+00)
94	PRIVATE DRAIN 1089 - CROCKER CHANNEL	CROCKER DEBRIS BASIN	1138 FT D/S OF CROCKER DEBRIS BASIN	180701020202	SANTA CLARITA	4460-B7	1,384	TRAPEZOIDAL	Sta. 14+84 to Sta. 1+00
95	PRIVATE DRAIN 1621	133 FT U/S OF RUE ENTRÉE	OAK SPRING CANYON RAOD	180701020107	SANTA CLARITA	4552-D1	1,323	RECTANGULAR	Sta./ 22+36.88 to Sta. 9+13.83
96	PRIVATE DRAIN 1821	HASLEY CANYON ROAD	SALEM COURT	180701020306	CASTAIC	4459-H5	533	TRAPEZOIDAL	PD 1821 (Sta. 18+13 to Sta. 11+90) PD 2484 (Sta. 12+79.69 - Sta. 11+90) reconstructed as RCB
97	PRIVATE DRAIN 1869	SHEFFIELD LANE	SAN FERNANDO ROAD	180701020403	SANTA CLARITA	4550-H5 to 4550-J6	2,480	TRAPEZOIDAL	Line A (Sta. 21+28.59 - Sta. 8+87), Line B (Sta. 12+38.04 to Sta. 0+00)
98	PRIVATE DRAIN 1894 - MINT CANYON CHANNEL	270 FT U/S OF SOLEDAD CANYON ROAD	SANTA CLARA RIVER	180701020106	SANTA CLARITA	4551-J3	1,377	RECTANGULAR	108 FEET OF GROUTED ROCK AT UPSTREAM END Sta. 20+51.88 - Sta. 6+75
WEST AREA - SANTA CLARA YARD									
99	PRIVATE DRAIN 1991 - MINT CANYON CHANNEL	SOLAMINT ROAD	483 FT D/S OF SOLAMINT ROAD	180701020106	SANTA CLARITA	4551-J2 to 4551-J3	203	RECTANGULAR	Sta. 26+82.80 to Sta. 24+80
100	PRIVATE DRAIN 2012- OUTLET	200' NW of intersection of Technology Dr. & Stanford Ave.		180701020202	SANTA CLARITA	4460-A7	85	SWALE	BIOLOGICAL SURVEY OF LOCATION INCLUDED IN APPLI CATION
101	PRIVATE DRAIN 771 & 911	1840 FT U/S OF GRANDIFLORAS ROAD	620 FT D/S OF BEGONIAS LANE	180701020107	SANTA CLARITA	4462-G5 to 4462-G6	5,176	TRAPEZOIDAL	PD 771 (Sta. 37+43 - Sta. 4+37.15) PD 911 (Sta. 55+57.89 Sta. 36+88.23)
102	PRIVATE DRAIN 832	SIERRA HIGHWAY	SANTA CLARA RIVER	180701020106	SANTA CLARITA	4551-H4	827	TRAPEZOIDAL	Sta. 4+86 to Sta. 13+13.41

TABLE B-1. Concrete-Lined Channels List

(revised July 2014)

REACH No.	DESCRIPTION	UPSTREAM LIMIT (U/P)	DOWNSTREAM LIMIT (D/S)	HYDRO UNIT CODE	CITY	TG	LF	CHANNEL TYPE	NOTES
103	PROJECT 1224	727 FT D/S OF PEARLBLOSSOM HIGHWAY	AVENUE T	180701020201	LITTLE ROCK	4377-H1 to 4287-H5	7,329	RECTANGULAR	Sta. 93+70 to Sta. 20+41.06
104	RYE CANYON CHANNEL	RYE CANYON ROAD	CALTRANS RECTANGULAR CHANNEL	180701020202	SANTA CLARITA	4460-D7 to 4460-B7	5,590	RECT / TRAP	
105	SANTA CLARA RIVER SOUTH FORK - GAVIN CHANNEL	1105 FT U/S OF CONFLUENCE WITH LYON CHANNEL	374 FT D/S OF LYONS AVENUE	180701020401	SANTA CLARITA	4640-F2 to 4640-F1	4,800	RECTANGULAR	
106	VIOLIN CANYON CHANNEL-LOWER (LACFCD & PD 2275)	867 FT U/S OF LAKE HUGHES ROAD	1463 FT D/S OF RIDGE ROUTE ROAD	180701020306	CASTAIC	4369-G6 to 4369-H7	4,534	RECT / TRAP	380 FEET OF GROUTED ROCK AT DOWNSTREAM END
107	VIOLIN CANYON CHANNEL-UPPER (PD 2275)	138 FT U/S OF SIEERA OAK TRAIL	THE OLD ROAD	180701020306	CASTAIC	4369-F5	983	TRAPEZOIDAL	
108	WHITES CANYON CHANNEL (PD 453, 704, & 758)	870 FT U/S OF FOXLANE DRIVE	GLASSER AVENUE	180701020107	SANTA CLARITA	4551-G1 to 4551-F1	4,874	RECT / TRAP	
EAST AREA - LONGDEN YARD									
109	ALVARDO CHANNEL	Honore St	60 Fwy	180701060502	ROWLAND HTS	679 B4-B5	2,689	RECTANGULAR/ TRAPEZOIDAL	
110	BADILLO CREEK	Grand Ave	Charter Oak Wash	180701060402	COVINA	599 D5	1,215	RECTANGULAR	
111	BAKER WASH	Azusa Ave	Merced Ave	180701060502	WEST COVINA	639 A3	1,250	TRAPEZOIDAL	
112	BASSETT CHANNEL (BI 528)	3rd Avenue	San Gabriel River	180701060601	INDUSTRY	637 J4	6,881	RECTANGULAR	
113	BATSON CHANNEL (PD 275)	Batson Ave	Mescal St	180701060502	ROWLAND HTS	679 A6	695	TRAPEZOIDAL	
114	BEATTY CHANNEL	Beatty Ave.	San Gabriel River	180701060601	AZUSA	568 F4	324	TRAPEZOIDAL	
115	BIG DALTON WASH	Big Dalton DB	Walnut Creek	180701060402	GLENDORA	569 H2	56,880	RECTANGULAR	
116	BRADBURY CHANNEL	Bradbury DB	Santa Fe SG	180701050302	BRADBURY	568 B3	4,601	RECTANGULAR	
117	BREA CANYON CHANNEL	Pathfinder Rd	Castle Rock Rd	180701060502	DIAMOND BAR	679 J5-H7	9,650	TRAPEZOIDAL	
118	BUENA VISTA CHANNEL	Santa Fe Channel	Sawpit Wash	180701050302	IRWINDALE	598 A1	6,100	TRAPEZOIDAL	
119	CHARTER OAK CHANNEL	Covina Blvd	Bonnie Cove Ave	180701060402	COVINA	599 G3, F4	2,080	RECTANGULAR/ TRAPEZOIDAL	
120	CHARTER OAK WASH	San Bernardino Rd	Walnut Creek	180701060402	COVINA	599 D4-B7	5,816	RECTANGULAR	
121	CHIMES CHANNEL	Huntington Drive	Highland Avenue	180701050302	DUARTE	568 B5	1,050	RECTANGULAR	
122	CHINO CREEK	Garey Ave	Riverside Drive	180701060501	POMONA	641 A6-7	4,404	RECTANGULAR	
123	CLARK CHANNEL (PD 58)	Clark Ave	Folkstone Ave	180701060603	INDUSTRY	637 J7	901	TRAPEZOIDAL	
124	DIAMOND BAR CHANNEL	Prospectors Rd	Sunset Crossing Rd	180701060501	DIAMOND BAR	640 B6	3,826	TRAPEZOIDAL	
125	DOUBLEGROVE CHANNEL	Mill Creek	Indian Summer Ave	180701060502	WEST COVINA	638 J3-G3	4,788	TRAPEZOIDAL	
126	DOVE CREEK	Renault St	Hurley St	180701060502	INDUSTRY	678 J1-J2	3,651	TRAPEZOIDAL	
127	DUARTE CHANNEL (BI 30)	Duarte Road	Buena Vista	180701050302	DUARTE	568 A5	3,254	TRAPEZOIDAL	
128	EMERALD WASH	Emerald DB	Live Oak Wash	180701060402	LA VERNE	600 F2	10,886	RECTANGULAR	
129	ENGLEWILD CHANNEL	Englewild DB	Sierra Madre Ave	180701060402	GLENDORA	569 F2-4	4,055	RECTANGULAR	
130	FIREY AVENUE CHANNEL	Arrow Hwy	Puddingstone Channel	180701060402	LAVERNE	600 D3	804	RECTANGULAR	
131	FRANKTON CHANNEL	Folkstone Ave	Seventh Ave	180701060502	HACIENDA HTS	677 H1	1,704	TRAPEZOIDAL	
132	FULLERTON CHANNEL	Galatina St	Sunrise Dr	180701060604	ROWLAND HTS	678 J6	6,675	TRAPEZOIDAL	
133	GIANO CHANNEL	Gendel Dr	La Seda Rd	180701060502	WEST COVINA	679 A1-B1	7,955	TRAPEZOIDAL	
134	HACIENDA CHANNEL	Newton St	San Jose	180701060502	INDUSTRY	678 B1	14,055	RECTANGULAR/ TRAPEZOIDAL	
135	HOOK CANYON CHANNEL (BI 1120)	Hook Canyon DB	Little Dalton Wash	180701060402	GLENDORA	569 C3	2,920	RECTANGULAR	
136	LAWRENCE CHANNEL (PD 51)	Halliburton Rd	Stimson Ave	180701060502	INDUSTRY	678 C3	1,200	TRAPEZOIDAL	
137	LENORE CHANNEL	Wildflower Rd	Rio Hondo Channel	180701050303	ARCADIA	597 E4	1,050	TRAPEZOIDAL	

TABLE B-1. Concrete-Lined Channels List

(revised July 2014)

REACH No.	DESCRIPTION	UPSTREAM LIMIT (U/P)	DOWNSTREAM LIMIT (D/S)	HYDRO UNIT CODE	CITY	TG	LF	CHANNEL TYPE	NOTES
EAST AREA - LONGDEN YARD									
138	LITTLE DALTON DIVERSION	Little Dalton Diversion DB	Big Dalton Wash	180701060402	GLENDORA	569 H3	2,014	RECTANGULAR	
139	LITTLE DALTON WASH	Loraine Ave	Big Dalton Wash	180701060402	GLENDORA	598 H2	32,700	RECTANGULAR	
140	LIVE OAK WASH	Live Oak DB	Puddingstone Dam	180701060402	LA VERNE	571A6-600E4	18,444	RECTANGULAR	
141	LYCOMING CHANNEL	Brea Canyon Rd	Dryander Dr	180701060502	DIAMOND BAR	679 G2	3,529	TRAPEZOIDAL	
142	MARSHALL CANYON CHANNEL	East and West Fork Inlets	Live Oak Wash	180701060402	LA VERNE	600 F2	13,265	RECTANGULAR	
143	MORGAN CREEK	Morgan DB	Palopinto Rd	180701060402	GLENDORA	569 J6	3,989	RECTANGULAR	
144	MTD 184	Campus Dr	57 Frwy	180701060501	POMONA	558 B6	1,570	RECTANGULAR	
145	NOGALES CHANNEL (BI 4350)	Nogales St	San Jose Creek	180701060502	INDUSTRY	679 C3	551	RECTANGULAR	
146	PD 215	Peck Road	60 Frwy	180701060606	EL MONTE	637 C5	666	RECTANGULAR	
147	PECK ROAD CHANNEL (BI 25)	Duarte Road	Peck Road	180701050302	MONROVIA	567 G6	2,133	RECTANGULAR	
148	PEPPERBROOK CHANNEL	Colima Rd	Rail Road Track	180701060502	ROWLAND HTS	678 F3	8,176	TRAPEZOIDAL	
149	PIERRE CHANNEL (PD 564)	Pierre Rd	Divonne Dr	180701060502	WALNUT	639 F7	908	TRAPEZOIDAL	
150	PUDDINGSTONE CHANNEL	Puddingstone Diversion Dam	Live Oak Wash	180701060402	LAVERNE	600 D2	14,170	RECTANGULAR	
151	PUENTE CREEK	Azusa Ave	San Jose Creek	180701060502	INDUSTRY	638 G6-A7	25,698	RECTANGULAR	
152	PUENTE CREEK - SOUTH FORK (PD 37 & 211)	Temple Ave	Puente Creek	180701060502	VALINDA	638 G6	2,130	TRAPEZOIDAL	
153	SAN DIMAS WASH	Foothill Blvd	Big Dalton Wash	180701060402	COVINA--ETC	599 A3	35,863	RECTANGULAR	
154	SAN JOSE CREEK - SOUTH FORK	Mission Blvd	San Jose Creek	180701060501	POMONA	639 H7	13,901	RECTANGULAR/ TRAPEZOIDAL	
155	SAN JOSE CREEK	Ganeshia	San Gabriel River	180701060502	INDUSTRY	679 D3	92,511	RECTANGULAR	Permit excludes soft-bottom portion
156	SANDALWOOD CHANNEL (PD 64)	Sandalwood Ave	Salais St	180701060502	LA PUENTE	678 H1	1,054	TRAPEZOIDAL	
157	SANTA ANITA WASH	Santa Anita SB	Peck Road SB	180701050302	ARCADIA	567 E1	25,700	RECTANGULAR	
158	SANTA FE DIVERSION CHANNEL	San Gabriel River	Buena Vista Channel	180701050302	IRWINDALE	598 A1	4,105	TRAPEZOIDAL	
159	SAWPIT WASH	Sawpit DB	Peck Road SB	180701050302	MONROVIA	567 H1	26,132	TRAPEZOIDAL	
160	STIMSON CHANNEL	Fieldgate Ave	Stimson Ave	180701060502	HACIENDA HEIGHTS	678 D3	7,097	TRAPEZOIDAL	
161	THOMPSON CREEK	Thomson Creek Dam	White Ave	180701060501	CLAREMONT	571 D4 -600 H6	30,800	RECTANGULAR	
162	VALLECITO CHANNEL (PD 164)	Gale Ave	Shadybend Dr	180701060502	HACIENDA HEIGHTS	678 B2	1,329	TRAPEZOIDAL	
163	VALLEY CHANNEL	Valley Blvd	Fenmead St	180701060502	WEST COVINA	679 A2 - B2	4,132	TRAPEZOIDAL	
164	VERNON CHANNEL	Batson Ave	Sierra Leone Ave	180701060502	ROWLAND HEIGHTS	679 A4-5	3,602	TRAPEZOIDAL	
165	WALNUT CREEK	Covina Hills Rd	San Gabriel River	180701060403	COVINA	638 A1	41,160	RECTANGULAR	Permit excludes soft-bottom portion
166	WARRINGWOOD CHANNEL	Waringwood Rd	Valley Blvd	180701060502	LA PUENTE	678 E1	1,644	TRAPEZOIDAL	
EAST AREA - EATON YARD									
167	ALHAMBRA WASH	Valley Blvd	Rio Hondo Wash	180701050303	SAN GABRIEL&ROSE	596 D6	15,160	RECTANGULAR	
168	ARCADIA WASH - EAST BRANCH	Orange Grove	Huntington Dr	180701050302	ARCADIA	567 B5	7,192	RECTANGULAR	
169	ARCADIA WASH - LIMA STREET	Carter Ave	Foothill Blvd	180701050302	ARCADIA-SIERRA M	566 J2	11,861	RECTANGULAR	
170	ARCADIA WASH - MAIN BRANCH	Campus Dr	Rio Hondo Channel	180701050302	ARCADIA	567 B5	14,736	RECTANGULAR	
171	ARROYO SECO CHANNEL	Devils Gate Dam	LA River	180701050209	PASADENA	535 E6	47,780	RECTANGULAR/ TRAPEZOIDAL	
172	DORCHESTER AVENUE CHANNEL (BI 65)	Gravois Ave	Valley Blvd	180701050303	EL SERENO	635 G1	1,375	RECTANGULAR	
173	EATON WASH	Eaton Dam	Rio Hondo Wash	180701050301	PAS.,T.C.,EL MON	566 EF1	42,366	RECTANGULAR	
174	GOOSEBERRY CREEK	Gooseberry Inlet	Gooseberry DB	180701050301	ALTADENA	536 C5	1,519	RECTANGULAR	
175	HASTINGS CHANNEL	Hastings Channel Inlet	Sierra Madre Villa DB	180701050301	PASADENA	536 H7	646	RECTANGULAR	
176	KINNELOA CHANNEL (PD 84)	Kinneloa DB	Kinclair Dr	180701050301	PASADENA	536 F6-7	3,376	RECTANGULAR/ TRAPEZOIDAL	
177	KINNELOA CHANNEL WEST BRANCH	Kinneloa DB West Branch	Kinneloa Channel	180701050301	PASADENA	536 F6	422	RECTANGULAR	
178	LAS FLORES DIVERSION	Las Flores DB	Rubio	180701050301	ALTADENA	536 B4	85	RECTANGULAR	

TABLE B-1. Concrete-Lined Channels List

(revised July 2014)

REACH No.	DESCRIPTION	UPSTREAM LIMIT (U/P)	DOWNSTREAM LIMIT (D/S)	HYDRO UNIT CODE	CITY	TG	LF	CHANNEL TYPE	NOTES
179	MILL CREEK	South of Sherwood Rd	Mill Creek	180701050303	SAN GABRIEL	596 C2	2,510	RECTANGULAR	
180	RIO HONDO CHANNEL	Peck Road SB	Rosemead Blvd	180701050303	EL MONTE	597 F3-B7	19,150	TRAPEZOIDAL	
181	RUBIO DIVERSION	Rubio Wash	Altadena Drive	180701050303	ALTADENA	536 B4	1,928	TRAPEZOIDAL	
182	RUBIO WASH	Rubio DB	Rio Hondo Channel	180701050303	ALTADENA/ROSEMEAD	536B4-636J2	22,155	RECTANGULAR	
EAST AREA - EATON YARD									
183	SIERRA MADRE VILLA CHANNEL	Sierra Madre Villa Channel SB	Eaton Wash	180701050301	PASADENA	566 G2	3,465	RECTANGULAR	
184	SIERRA MADRE WASH	South Madre Dam	Santa Anita Wash	180701050302	SIERRA MADRE	537 C7 - 567 D3	9,979	RECTANGULAR	
SOUTH AREA - IMPERIAL YARD									
185	BALLONA CREEK	btwn La Salle Ave & Overland	Centinela Ave	180701060606	LOS ANGELES	672 D7	22,175	RECTANGULAR	
186	CENTINELA CREEK	Jefferson	Ballona	180701040300	LOS ANGELES	672 D7	9,600	RECTANGULAR	
187	COYOTE CREEK	North Fork Coyote Creek	San Gabriel River	180701060606	LONG BEACH	738 A1	34,510	TRAPEZOIDAL	
188	COYOTE CREEK NORTH FORK	Candlewood Country Club	Coyote Creek	180701060602	CERRITOS	707 C6	21,346	TRAPEZOIDAL	
189	DOMINGUEZ CHANNEL [120th St. to Henry Ford]	120th St.	Vermont Ave	180701060102	GARDENA	763 J1	67,992	TRAPEZOIDAL	
190	EAST LA COLLEGE DRAIN	Dorner	First St	180701050303	LOS ANGELES CO	635 H6	617	RECTANGULAR	
191	PD 21 [Holly Park Drain]	Crenshaw	El Segundo	180701060102	GARDENA	733 H2	7,619	TRAPEZOIDAL	
192	LEFFINGWELL CREEK	Santa Fe St	Hawes St	180701060602	LOS ANGELES CO	707 G5	3,445	RECTANGULAR	
193	LOS ANGELES RIVER	Southern Ave.	Willow Street	180701050402	LONG BEACH	735	67,261	TRAPEZOIDAL	
194	LOS CERRITOS CHANNEL	Candlewood St	PCH	180701060606	LONG BEACH	766 D7	18,182	RECTANGULAR	
195	SAN GABRIEL RIVER	Firestone Blvd	Coyote Creek Confluence	180701060606	LONG BEACH	637 F4	110,458	TRAPEZOIDAL	
196	SANTA MONICA CYN CHANNEL [Pacific Ocean to Sunset Blvd]	Adolfo Dr.	PCH	180701040402	LOS ANGELES	631 D5	16,432	RECTANGULAR	
197	SEPULVEDA CHANNEL	Sunset (Orange County)	Ballona Creek (Venice)	180701040300	LOS ANGELES	672 D1- F5	10,639	RECTANGULAR	
198	COMPTON CREEK EAST BRANCH No. 2	Santa FE	Compton Creek/Artesia	180701050402	COMPTON	735 B7	3,452	TRAPEZOIDAL	
199	EAST COMPTON CREEK No. 1	Main St	120th st	180701050402	COMPTON	735 B7	2,102	TRAPEZOIDAL	
200	CENTINELA CREEK LOWER	La Tijera	Jefferson	180701040300	LOS ANGELES	672 D7	5,530	RECTANGULAR	
202	DDI 9	Scott Ave	Coyote NF	180701060602	LOS ANGELES CO	707 G5	5,610	RECTANGULAR	
203	Milan Creek	Valley View	PD 212 / Collamer Dr	180701060602	LA MIRADA	737 D3	10,066	TRAPEZOIDAL	
204	McKinley ave Drain	Avalon Blvd	Walnut St	180701060102	CARSON	678D4	1,120	TRAPEZOIDAL	
205	PD 1 [La Mirada Creek]	La Mirada Blvd	Rosecrans	180701060602	LA MIRADA	737 G3	1,017	TRAPEZOIDAL	
206	PD 20 [La Mirada Creek]	Elmbrook Dr.	San Feliciano Dr./PD 31	180701060602	LA MIRADA	737 F4	3,669	TRAPEZOIDAL	
207	PD 31 [La Mirada Creek]	Excelsior	Stage Rd	180701060602	LA MIRADA	737 F4	963	TRAPEZOIDAL	
209	PD 40 [DDI 9]	LA RR	Starbuck St.	180701060602	WHITTIER	707 J4	1,906	TRAPEZOIDAL	
210	PD 52 [Tacobi Creek]	Cole Rd	Bluefield Ave	180701060602	WHITTIER	707 G5	874	TRAPEZOIDAL	
211	Tacobi Creek	Bluefield Ave	Leffingwell Creek	180701060602	WHITTIER	707 G5	873	TRAPEZOIDAL	
213	PD 132 [Los Cerritos Drn System]	Allington St	PD 154	180701060602	LAKEWOOD	766 D2	1,310	TRAPEZOIDAL	
214	PD 138 [Proj No 1201]	232nd	Galavan st	180701060701	CARSON	794B1	336	TRAPEZOIDAL	
215	PD 142 [La Mirada Creek]	Stage Rd	Coyote Creek	180701060602	LA MIRADA	737 D4	3,792	TRAPEZOIDAL	
216	PD 154 [Los Cerritos Drain System]	PD 132/Mayfair HS	Esther Lindstorn Elem School	180701060602	LAKEWOOD	766 D2	289	TRAPEZOIDAL	
217	PD 162 [La Canada Verde]	Enramada ave.	Mar Vista St.	180701060602	WHITTIER	707 G1	1,108	TRAPEZOIDAL	
218	PD 168 [208Th St Drain]	Normandie	New Hampshire	180701060102	LOS ANGELES CO	764 A6	1,985	TRAPEZOIDAL	
219	PD 181 [208Th St Drain]	New Hampshire	Torrance/Vermont	180701060102	LOS ANGELES CO	764 B5	2,547	TRAPEZOIDAL	
220	PD 187 [La Mirada Creek]	First Ave	Ocean Ave	180701060602	LAC	708 A7	649	TRAPEZOIDAL	

TABLE B-1. Concrete-Lined Channels List

(revised July 2014)

REACH No.	DESCRIPTION	UPSTREAM LIMIT (U/P)	DOWNSTREAM LIMIT (D/S)	HYDRO UNIT CODE	CITY	TG	LF	CHANNEL TYPE	NOTES
221	PD 190 [Gridley Drain]	Chadwell Rd	San Gabriel River	180701060606	LAKEWOOD	766 G4	3,922	TRAPEZOIDAL	
222	PD 192 [La Mirada Creek]	Ocean/PD 187	Breezewood Ave	180701060602	LAC	707 J7	1,137	TRAPEZOIDAL	
223	PD 204 [La Mirada Creek]	PD 132	Santa Gertrude	180701060602	LOS ANGELES CO	707 J7	1,105	TRAPEZOIDAL	
224	PD 212 [Mc Kinley ave Drain]	E. 192st	Victoria St	180701060102	CARSON	764 D2	3,189	TRAPEZOIDAL	
225	PD 214 [La Mirada Creek]	Victoria St	E. 192nd St	180701060602	LOS ANGELES CO	708 A7	1,050	TRAPEZOIDAL	
226	PD 220 [La Mirada Creek]	Union Pac RR	Lambert	180701060602	LOS ANGELES CO	708 A6	691	TRAPEZOIDAL	
227	PD 221 [La Mirada Creek]	Maybrook Ave	Union Pac RR	180701060602	LA MIRADA	708 A6	563	TRAPEZOIDAL	
228	PD 243 [Rue La Havre Drn]	888' U/S of Palos Verdes	Palos Verdes Dr. W	180701060701	RANCHO PALOS VERDES	822 F3	888	TRAPEZOIDAL	
SOUTH AREA - IMPERIAL YARD									
229	PD 306 [Trancas Creek]	Paseo Cyn Dr	Paseo Cyn Dr	180701040203	MALIBU	627 A7	1,988	TRAPEZOIDAL	
230	PD 536 [Gridley Drain]	Tangent	Chadwell St./PD 190	180701060606	LAKEWOOD	766 F4	609	TRAPEZOIDAL	
231	PD 654 [Del Amo Channel]	Del Amo	Avalon PP	180701060102	CARSON	764-E4	904	TRAPEZOIDAL	
232	PD 658 [Trancas Creek]	Del Mar Azul	Paseo Cyn Dr	180701040203	MALIBU	627 A7	977	TRAPEZOIDAL	
233	PD 669 [Del Amo Channel]	Central	Del Amo	180701060102	CARSON	764G4	5,780	TRAPEZOIDAL	
234	PD 674 [Del Amo Channel]	Tillman	PD 654	180701060102	CARSON	764 G4	2,195	TRAPEZOIDAL	
235	PD 882 [Compton Creek]	Las Hermanas	Reyes Ave	180701050402	RANCHO DOMINGUEZ	765 B2	643	TRAPEZOIDAL	
236	PD 947 [U-B Rolling Hills Estates]	500 D/S N. Palos Verde Dr.	Crenshaw	180701060701	LOS ANGELES CO	793 C7	1,100	TRAPEZOIDAL	
237	PD 1130 [Agua Amarga Cyn]	Crest Verde Rd	Crest Verde Rd	180701040500	ROLLING HILLS	822 H2	857	TRAPEZOIDAL	
238	PD 1686 [Pacific Ocean]	S/L Seacove Dr. /30 RLP	Pacific Ocean	180701060701	RANCHO PALOS VERDES	822 H5	35	TRAPEZOIDAL	
239	RIO HONDO CHANNEL	Whittier Narrow Dam	LA River	180701050303	SOUTH GATE	676 E3	43,004	RECTANGULAR	
240	PROJ 9 [Los Cerritos U-1 Line F] - Bouton Creek	Clark Ave	Los Cerritos Channel/ Anaheim St	180701060606	LONG BEACH	796 B2	27,209	RECTANGULAR	
241	PROJ 15 [A-2 Sorenson Ave]	Slauson	Telegraph	180701060603	LOS ANGELES CO	707 C5	16,063	RECTANGULAR	
242	PROJ 16 [U-A Cerritos-MAP]	Trabuco St	San Gabriel River	180701060606	BELLFLOWER	736 D6	3,649	RECTANGULAR	
243	PROJ 17 [Calmada Ave to Oak St]	Mulberry Dr.	Calamada/ Sorenson Av. Dam	180701060603	LOS ANGELES CO	706 H5	1,426	RECTANGULAR	
244	PROJ 17 [U-2 Michigan Ave]	Mulberry Dr.	Oak St	180701060603	LOS ANGELES CO	707 C4	4,263	RECTANGULAR	
245	PROJ 21 [Artesia Norwalk Unit 2 Line A]	Garyland Ave.	Del Amo/ Coyote Creek	180701060602	CERRITOS	767 A4	5,097	RECTANGULAR	
246	PROJ 21 [Artesia Norwalk Line C]	Centralia	Coyote Creek	180701060603	LONG BEACH	795 J1	12,773	TRAPEZOIDAL	
247	PROJ 21 [Artesia Norwalk Line D]	Norwalk	Line C/213th St	180701060603	HAWAIIAN GARDENS	707 H5	944	TRAPEZOIDAL	
249	PROJ 74 [Redondo Beach]	168th St	200 U/S Vermont	180701060102	LOS ANGELES	734 B7	2,028	RECTANGULAR	
250	PROJ 76 [U-2 212th Street]	Western	Normandie	180701060102	LOS ANGELES	763 J6	3,992	RECTANGULAR	
251	PROJ 79 [A-2 Gaffey Street]	Gatum St	Harbor FWY	180701060701	LOS ANGELES	824 B3	741	RECTANGULAR	NO open channel(s) in vicinity of limits
252	PROJ 79 [A-2 Gaffey Street]	Westmont Dr	Gatun St	180701060701	LOS ANGELES	824 B3	2,672	RECTANGULAR	
253	PROJ 130 [Pump Dist 7 - Unit 2]	RR/Rose Ave	LA River	180701050402	LONG BEACH	765 C,D	11,077	RECTANGULAR	
254	PROJ 133 [Bouton Creek Line A Unit 2]	405 FWY	Project 9 - Atheron	180701060606	LONG BEACH	795 A2	5,902	RECTANGULAR	
255	PROJ 133 [B-2 Bouton Creek]	PCH	Park Ave	180701060606	LONG BEACH	795 A5	987	RECTANGULAR	
256	PROJ 446 [Lakewood - Line B]	3 blocks n/o South	Candlewood St	180701060602	LAKEWOOD	766 D3	2,562	RECTANGULAR	
257	PROJ 447 [W Lakewood] Line A	St. Pancrantius Pl	Proj 9 Yearling	180701060606	LAKEWOOD	765 J3	3,393	RECTANGULAR	
258	PROJ 532 [Whittwood St] Unit 1 Line C	RR/ Lambert	Scott Ave.	180701060602	LOS ANGELES CO	707 H5	818	RECTANGULAR	
259	PROJ 1153 [Rectangular Channel]	Torrance/Vermont	Main St	180701060102	CARSON, LOS ANGELES COUNTY	764 B5	2,949	RECTANGULAR	
260	PROJ 1232 [Line A]	Main St	Dominguez Channel	180701060102	CARSON	764 D5	6,620	TRAPEZOIDAL	
261	PROJ 4601 [Lakewood]	Hayter	Project 447	180701060606	LAKEWOOD	766 C3	1,215	TRAPEZOIDAL	
262	PROJ 6001 [Palos Verdes Unit 3 Line F]	Palos Verde Dr N	Palos Verde Dr. W	180701040500	PALOS VERDES ESTATES	792 J4	48	TRAPEZOIDAL	

TABLE B-1. Concrete-Lined Channels List

(revised July 2014)

REACH No.	DESCRIPTION	UPSTREAM LIMIT (U/P)	DOWNSTREAM LIMIT (D/S)	HYDRO UNIT CODE	CITY	TG	LF	CHANNEL TYPE	NOTES
264	PD 553 [Torrance]	Normandie	Harbor Fwy	180701060701	LOS ANGELES CO	794 A2	3,408	TRAPEZOIDAL	
265	RDD 206 - SITE 7 [Pacific Ocean]	300' U/S Malibu Rd	Malibu Rd	180701040204	MALIBU	628 G2	300	RECTANGULAR	
266	BEVERLY PICO DRAIN [LINE A - Channel south of Beverly Blvd.]	S/O UPRR	S/O UPRR	180701060606	PICO RIVERA	676 H2	102	RECTANGULAR	
268	SANTA MONICA CHANNEL (Doni Rd - Riviera Country Club)	Nimrod Ave.	100 D/S PCH	180701040402	LOS ANGELES	631 B7	2,699	RECTANGULAR	
269	PROJ 76	Torrance Blvd.	Normandie Ave.	180701060102	LOS ANGELES	764 A6	2,631	RECTANGULAR	
270	PD 668	Del Amo	Dominguez Channel	180701060102	CARSON	736 A4	925	RECTANGULAR	
271	PROJ 509	228th	Harbor Fwy	180701060701	LOS ANGELES	794 A1	1,244	TRAPEZOIDAL	
272	PROJ 455	Airport	Pro. 9	180701060606	Long Beach	796 A1	275	RECTANGULAR	
274	DDI 9 - LA CANADA VERDE	Lambert Road	Broadway	180701060602	LOS ANGELES CNTY	707 E5	2,640	RECTANGULAR	
SOUTH AREA - IMPERIAL YARD									
275	DDI 9 - 1200' U/S Victoria - 800' D/S Hawes	Mulberry Dr.	Mystic St.	180701060602	LOS ANGELES CNTY	707 E5	2,835	RECTANGULAR	
278	PD 867	Harcourt	SPRR	180701050402	RANCHO DOMINGUEZ	765 B1	264	RECTANGULAR	
279	PD 996	SP RR	Victoria	180701050402	RANCHO DOMINGUEZ	765 C1	444	RECTANGULAR	
280	Sawtelle Channel	Palms	Sepulveda Channel	180701040300	LOS ANGELES	672 B1	463	RECTANGULAR	
281	Wilmington Drain (East Channel)	Sepulveda	Lomita	180701060701	CARSON	794 B2	3576	RECTANGULAR	
282	Wilmington Drain (West Channel)	Sepulveda	Lomita	180701060701	CARSON	794 B2	3007	RECTANGULAR	
293	Rustic Channel	10' North of Rustic Ave. Bridge	Santa Monica Channel Confluence South of W Channel Rd	180701040402	Los Angeles	631 B6-B7	2390	RECTANGULAR	
ADDITIONAL CONCRETE-LINED CHANNELS									
283	Denivelle drain	Denivelle rd	Ellenbogen st	180701050103	SUNLAND	503 H1	213	RECTANGULAR	
284	La tuna canyon channel	La tuna db	Burbank channel	180701050208	SUN VALLEY	503 B6 TO 533 B1	12067	RECTANGULAR	
285	Las barras channel	La tuna canyon rd	Verdugo wash	180701050208	TUJUNGA	504 C7	424	RECTANGULAR	
286	Mtd 0806	Oakmont view dr db	Country club dr	180701050208	GLENDALE	534 G4	1258	TRAPEZOIDAL	
287	Pd 0769	Upper shields db	Markridge rd	180701050207	LA CRESCENTA	504 G5	656	RECTANGULAR	
288	Pd 0361	Cedartown st	150' n/o cedartown st	180701050208	SANA CLARITA	4640 H2	135	RECTANGULAR	
289	Pico canyon channel	200' w/o pico canyon road	Pd 2495 double rc box	180701020401	STEVENSON RANCH	4640 B1	1007	RECTANGULAR	
290	Stanford channel	100' n/o ave stanford	Rye canyon channel	180701020402	SANTA CLARITA	4550 C1 , 4460 C7	1280	RECTANGULAR	
ROAD MAINTENANCE DIVISION									
292	Castaic Drain	E/side of Castaic Rd	E/side of Castaic Rd	180701060602	LOS ANGELES COUNTY	4459 H1	250	RECTANGULAR	