

**WDID No. 1B82005OSON  
WASTE DISCHARGE REQUIREMENTS  
for  
KEYSIGHT TECHNOLOGIES, INC.  
FOUNTAIN GROVE SITE  
SONOMA COUNTY**

**The following Discharger is subject to waste discharge requirements (WDRs) as set forth in this Order:**

**Table 1. Discharger Information**

<b>Discharger</b>	Keysight Technologies, Inc.
<b>Name of Facility</b>	Keysight Technologies, Inc. Fountain Grove Site
<b>Facility Address</b>	1400 Fountain Grove Parkway
	Santa Rosa, CA 95403
<b>CIWQS Place ID</b>	225161
<b>ECM Primary Indexing Number</b>	CW-225161
<b>Global ID</b>	WDR100030954

The discharge by the Keysight Technologies, Inc. Fountain Grove Site (Facility) from the discharge point identified below is subject to waste discharge requirements as set forth in this Order.

**Table 2. Discharge Locations**

<b>Discharge Point</b>	<b>Effluent Description</b>	<b>Discharge Point Latitude</b>	<b>Discharge Point Longitude</b>	<b>Discharge Location</b>
001	Treated Industrial Wastewater	N 38.48174	W 122.71026	Irrigation Areas <sup>1</sup>

---

<sup>1</sup> Existing permanent spray and drip irrigation distribution system prior to adoption of this Order, as described in Order section II.B.

IT IS HEREBY ORDERED, that Order No. 89-140 is rescinded upon the effective date of this Order except for enforcement purposes, and, in order to meet the provisions contained in division 7 of the Water Code (commencing with section 13000) and regulations adopted thereunder, the Discharger shall comply with the requirements in this Order.

This Order was adopted on: April 4, 2024.

This Order shall become effective on: June 1, 2024.

I, Valerie Quinto, Executive Officer, do hereby certify that this Order with all attachments is a full, true, and correct copy of an Order adopted by the California Regional Water Quality Control Board, North Coast Region, on **April 4, 2024**.

---

Valerie Quinto  
Executive Officer

24\_0006\_keysight-technologies\_wdr

## I. FACILITY INFORMATION

The following Discharger is subject to waste discharge requirements as set forth in this Order:

**Table 3. Facility Information**

<b>Discharger</b>	Keysight Technologies, Inc.
<b>Name of Facility</b>	Keysight Technologies Inc. Fountain Grove Site
<b>Facility Address</b>	1400 Fountain Grove Parkway
	Santa Rosa, CA 95403
	Sonoma County
<b>Facility Contact, Title, Phone, and email</b>	Karen Bouvier, Facility Operator, (707) 547-5325 <a href="mailto:Karen.Bouvier@Keysight.com">Karen.Bouvier@Keysight.com</a>
<b>Mailing Address</b>	1400 Fountain Grove Parkway, Santa Rosa, CA 95403
<b>Type of Facility</b>	Industrial Manufacturing
<b>Facility Design Flow</b>	0.20 million gallons per day (mgd) Average Dry Weather Flow (ADWF)
	0.20 <sup>1</sup> mgd Peak Wet Weather Flow (PWWF)
<b>Facility Permitted Influent Flow</b>	0.20 mgd ADWF
	0.20 mgd PWWF
<b>Facility Permitted Effluent Flow</b>	0.07 mgd <sup>2</sup> Maximum Effluent Flow
<p>Table Notes:</p> <ol style="list-style-type: none"> <li>PWWF same as the ADWF: a) the influent is sourced from city water supply, b) storage of wastewater during treatment and reclaimed water prior to reuse is in storage tanks (not in ponds), and c) rainwater does not typically increase influent flow during wet weather.</li> <li>The maximum permitted effluent discharge at Discharge Point 001 for this Facility is limited to 0.07 mgd. This maximum considers the design capacity of the storage tanks, the irrigation system's capacity to discharge to land at hydraulic and agronomic rates, and that some of the treated industrial wastewater is diverted to the City of Santa Rosa wastewater treatment system.</li> </ol>	

## II. FINDINGS

The California Regional Water Quality Control Board, North Coast Region (hereinafter Regional Water Board), finds:

### A. Basis and Rationale for Requirements

The Regional Water Board developed the requirements in this Order based on information submitted as part of the Discharger's application for permit renewal, monitoring data submitted during the term of the Discharger's previous Order, and other available information.

## **B. Background and Facility Description**

Keysight Technologies Inc. is currently discharging pursuant to Waste Discharge Requirements Order No. 89-140.

The renewal of these waste discharge requirements is for the discharge to land of up to 0.07 mgd of treated industrial process wastewater from the existing manufacturing Facility (Maximum Effluent Flow). The Facility design flow is 0.20 mgd (AWWF and PWWF).

The discharger currently treats up to 200,000 gallons per day of industrial wastewater. Treated industrial wastewater is used to irrigate landscaped areas on the Discharger's property and is also discharged to the City of Santa Rosa wastewater treatment system. All domestic wastewater is discharged to the City of Santa Rosa wastewater treatment system.

The Discharger diverts and stores up to 150,000 gallons per day of treated industrial wastewater for irrigation of approximately 26 acres of landscaped land (irrigation areas) owned by the Discharger and located in the NE 1/4 of Section 2, T7N, R9W, MDB&M, as identified in Attachment A incorporated herein and made a part of this Order.

Wastewater from the manufacturing processes is treated to remove contaminants and neutralize the pH prior to discharge to either the irrigation system or the sanitary sewer.

The irrigation facilities consist of two 75,000 gallon storage tanks and a permanent spray and drip irrigation distribution system.

Attachments A through C provide Facility location and schematics. Attachment D is the Monitoring and Reporting Program.

For the last consecutive 25 years, metals and cyanide have been analyzed annually in soil collected from four locations typically within the same irrigation areas at the Facility. The sampling results reported were consistent with naturally occurring background levels as identified for similar soils in California<sup>2</sup>. Cyanide was not reported above detection limits. Groundwater monitoring wells located 500 feet south of the Facility record groundwater at an elevation of between 400

---

<sup>2</sup> [Background Concentrations of Trace and Major Elements in California Soils, Kearney Foundation of Soil Science Division of Agriculture and Natural Resources, University of California, March 1989](https://ucanr.edu/sites/poultry/files/297094.pdf) (https://ucanr.edu/sites/poultry/files/297094.pdf)



to 420 feet msl with a hydraulic gradient on the order of 0.02 feet per foot. Groundwater may be anticipated to occur at a depth of approximately 80 feet below ground surface at the Facility. Regional Water Board finds that historical sampling data of the soil collected at the Facility has demonstrated no indication of sampled constituents occurring above typical background levels for similar soils.

### **C. Legal Authorities**

This Order serves as Waste Discharge Requirements (WDRs) pursuant to article 4, chapter 4, division 7 (commencing with section 13260) of the California Water Code (Water Code) and water recycling requirements pursuant to article 4, chapter 4, division 7 (commencing with section 13500) of the Water Code.

### **D. Basin Plan**

As required by Water Code section 13263(a), these WDRs are crafted to implement the Water Quality Control Plan for the North Coast Region (Basin Plan), and in so doing, the Regional Water Board has taken into consideration the beneficial uses to be protected, the water quality objectives (both numeric and narrative) reasonably required for that purpose, other (including previous) waste discharges, the need to prevent nuisance, and the provisions of Water Code section 13241. The Basin Plan contains implementation plans and policies for protecting waters of the basin. The Basin Plan implements State Water Resources Control Board (State Water Board) Resolution No. 88-63, which established state policy that all waters, with certain exceptions, should be considered suitable or potentially suitable for municipal or domestic supply.

Thus, beneficial uses applicable to area groundwater within the Santa Rosa Hydrologic Subarea of the Russian River Hydrologic Unit to be protected are as follows: municipal and domestic supply (MUN), agricultural water supply (AGR), industrial service supply (IND), industrial process supply (PRO), aquaculture (AQUA), freshwater replenishment to surface waters (FRSH), and Native American culture (CUL).

### **E. Water Code**

The Water Code establishes the authority for the Regional Water Board to establish water quality objectives, impose discharge prohibitions, and prescribe waste discharge and reclamation requirements. Water Code section 13241 requires each regional board to “establish such water quality objectives in water quality control plans as in its judgment will ensure the reasonable protection of beneficial uses and the prevention of nuisance [...]”. The control of waste is established through effluent limitations and other requirements in Waste Discharge Requirement permits. Water Code section 13243 provides that “A regional board, in a water quality control plan or in waste discharge

requirements, may specify certain conditions or areas where the discharge of waste, or certain types of waste, will not be permitted.”

Water Code section 13260 establishes regulations associated with the prescription of waste discharge requirements and Water Code Chapter 7 (Wat. Code § 13500 et seq) establishes regulations associated with the prescription of reclamation requirements.

It is the Regional Water Board’s intent that this Order shall ensure attainment of water quality standards, applicable water quality objectives, and protection of beneficial uses of receiving waters. The Discharger must comply with this Order in its entirety. The Order prohibits discharges from causing violations of water quality objectives or causing conditions to occur that create a condition of nuisance or water quality impairment in receiving waters as a result of the discharge.

#### **F. Title 27 Exemption**

The wastewater treatment, storage, and disposal activities described in this Order are exempt from the requirements of Consolidated Regulations for Treatment, Storage, Processing, or Disposal of Solid Waste in California Code of Regulations, title 27, division 2, Subdivision 1, section 20005, et seq. The activities are exempt from the requirements of title 27 so long as the activity meets, and continues to meet, all preconditions listed below. (Cal. Code Regs., tit. 27, § 20090.)

1. Wastewater—Discharges of wastewater to land, including but not limited to evaporation ponds, percolation ponds, or subsurface leach fields if the following conditions are met:
  - a. the applicable regional water board has issued WDRs, reclamation requirements, or waived such issuance;
  - b. the discharge is in compliance with the applicable water quality control plan; and
  - c. the wastewater does not need to be managed according to, California Code of Regulations, title 22, division 4.5, chapter 11, as a hazardous waste. (Cal. Code Regs., tit. 27, § 20090(b).
2. Soil Amendments—Use of nonhazardous decomposable waste as a soil amendment pursuant to applicable best management practices, provided that Regional Water Boards may issue waste discharge or reclamation requirements for such use. (Cal. Code Regs., tit. 27, § 20090(f).)

## **G. Groundwater Protection and the Antidegradation Policy**

### Groundwater Protection

Resolution No. R1-2022-0040 acknowledges the Regional Water Board is committed to the protection of high-quality groundwater and the restoration of degraded groundwater to support all beneficial uses now and in the future especially given increasing reliance on groundwater in the North Coast Region. Groundwater supplies in the North Coast Region are currently beneficially used for: 1) drinking water, sanitation, and hygiene consistent with the Human Right to Water described in Regional Water Board Resolution No. R1-2019-0024; 2) agriculture and industry which are major economic drivers in the region, 3) Native American ceremonies and traditions; 4) aquaculture operations; and 5) replenishment of flows to streams (e.g. contribution to instream flows) to maintain beneficial uses of surface water, especially cold freshwater habitat, migration of aquatic specifics, wildlife habitat, and spawning, reproduction, and early development of fish.

### Antidegradation Policy

State Water Board Resolution 68-16, the Statement of Policy with Respect to Maintaining High Quality Waters of California (hereafter the Antidegradation Policy) requires the disposal of waste be regulated to achieve the highest water quality consistent with the maximum benefit to the people of the state. The Regional Water Board's Basin Plan implements, and incorporates by reference, the State antidegradation policy. The Antidegradation Policy applies when a discharge may degrade high quality waters<sup>3</sup> and requires the following:

1. Higher quality water will be maintained until it has been demonstrated to the state that any change will be consistent with the maximum benefit to the people of the state, will not unreasonably affect present and anticipated beneficial use of the water, and will not result in water quality less than prescribed in the policies.
2. Any activity that produces a waste and discharges to existing high quality waters will be required to meet waste discharge requirements that will result in the best practicable treatment or control of the discharge necessary to assure pollution or nuisance will not occur, and the highest water quality

---

<sup>3</sup> The Board interprets "high quality waters" as the best water quality that has existed since the Policy was adopted in 1968 after considering any subsequently authorized degradation that has been allowed in compliance with the Policy.

consistent with the maximum benefit to the people of the state will be maintained.

This Order is consistent with the maximum benefit to people of the State because: (i) it allows continued operation of an existing industrial wastewater treatment/water reclamation facility; (ii) it requires implementation of hydraulic and agronomic rates and Best Management Practices (BMPs) to ensure protection of groundwater and surface water beneficial uses, and (iii) it requires monitoring to ensure that the water quality of the treated wastewater effluent meets State requirements (title 22 and Water Code) and is protective of groundwater.

Limited degradation of groundwater by some waste constituents associated with industrial wastewater effluent, after effective treatment and control measures are implemented, is consistent with the maximum benefit to the people of the state. The technology, energy, and water reclamation advantages of industrial process wastewater treatment systems for water reuse far exceed benefits derived from reliance on disposal to city wastewater treatment systems and potential overburden to the centralized receiving wastewater treatment system. The economic prosperity of a community and associated industry is of maximum benefit to the people of the state and provides sufficient justification for allowing the limited groundwater degradation that may occur pursuant to this Order provided the terms of the Basin Plan, and other applicable State Water Board and Regional Water Board policies are consistently met.

This Order provides protection of beneficial uses of groundwater with no discharge to surface water. This Order is consistent with Resolution No. 68-16 because implementation of the Order will result in the application of management measures to treat the discharge of waste that constitutes the best practicable treatment or control of the discharge and lead to a net benefit to water quality by improving and monitoring existing conditions currently impacted by this activity. Best Practicable Treatment and Control at the Facility consists of a treatment plant, storage tanks, and irrigation areas. Treatment includes multiple processes to the wastewater. Wastewater from semiconductor etching and cleaning processes is neutralized. Various rinsewater streams with trace metals are neutralized and then processed through an ion exchange unit to remove the metals. Wastewater streams with higher metals content are processed to precipitate out the metals; the supernatant is then neutralized. Rinsewaters with low levels of cyanide are oxidized to cyanate with hypochlorite, then neutralized. The combined waste stream goes through a final neutralization process prior to discharge. Solid waste is dewatered for offsite disposal. Reclaimed water is stored in storage tanks and applied to onsite irrigation areas. This Order contains discharge prohibitions, effluent limitations, water reclamation requirements, receiving water limitations, and monitoring requirements. This Order does not authorize an increased volume or concentration of waste, or a decreased level of

treatment and will ensure that the discharge does not result in degradation of groundwater, exceedances of water quality standards, or impacts to the beneficial uses of groundwater within the Santa Rosa Hydrologic Subarea of the Russian River Hydrologic Unit.

Section V.A.3 of this Order requires the Discharger to develop and implement an Irrigation Management Plan to ensure that reclaimed water is applied at or below hydraulic and agronomic rates and that BMPs are implemented to ensure protection of the beneficial uses of groundwater and surface waters and of public health. The MRP in Attachment D of this Order requires monitoring of the reclaimed water for pollutants of concern, including salts (as measured by total dissolved solids), metals, and phenols, and to report hydraulic and agronomic application rates on an annual basis to demonstrate that the Discharger's use of best practicable treatment or control is effective for the protection of groundwater in areas of reclaimed water use.

#### **H. Human Right to Water**

It is the policy of the State of California that every human being has the right to safe, clean, affordable, and accessible water adequate for human consumption, cooking, and sanitary purposes (Wat. Code §106.3, subd. (a)). State Water Board Resolution No. 2016-0010 identifies the human right to water as a top priority and core value of the State and Regional Water Boards and affirms the Water Boards' commitment to consider how its activities impact and advance the human right to safe, affordable and clean water to support basic human needs. The Safe Drinking Water Act provides that all Californians have a right to pure and safe drinking water (Health & Safety Code § 116270, subd. (a)). This Order promotes that policy by requiring the Discharger to handle and dispose of waste in a manner that will protect water quality objectives, including those that protect drinking water supplies.

#### **I. Endangered Species Act**

This Order does not authorize any act that results in the taking of a threatened or endangered species or any act that is now prohibited, or becomes prohibited in the future, under either the California Endangered Species Act (Fish and Game Code sections 2050 to 2097) or the Federal Endangered Species Act (16 U.S.C.A sections 1531 to 1544). The Discharger is responsible for meeting all requirements of the applicable Endangered Species Act.

#### **J. Recycled Water**

The State Water Board adopted the *Policy for Water Quality Control for Recycled Water* (Recycled Water Policy) on February 3, 2009, and then amended the Policy on January 22, 2013. The State Water Board approved a second

amendment to the Recycled Water Policy on December 11, 2018, with an effective date of April 8, 2019. This Order implements the Recycled Water Policy.

It is the intent of the Recycled Water Policy that salts and nutrients from all sources be managed on a basin-wide or watershed-wide basis in a manner that ensures attainment of water quality objectives and protection of beneficial uses. The State Water Board found that the appropriate way to address salt and nutrient management is through developing regional or sub-regional salt and nutrient management plans rather than through imposing requirements solely on individual projects. The Recycled Water Policy calls for the development of locally driven and controlled collaborative processes open to all stakeholders that will prepare salt and nutrient management plans for each basin/sub-basin in California.

The Regional Water Board finds that a combination of regional management plans and individual or programmatic project requirements are necessary to protect beneficial uses. The Recycled Water Policy recognizes the fact that some groundwater basins in the state contain salts and nutrients that exceed or threaten to exceed water quality objectives in the applicable Basin Plans and that not all Basin Plans include adequate implementation procedures for achieving or ensuring compliance with the water quality objectives for salt or nutrients. However, in the absence of an approved salt and nutrient management plan (SNMP), the Regional Water Board may impose specific requirements to ensure the preservation and maintenance of high-quality groundwater. The Regional Water Board has incorporated requirements recommended by the Department of Drinking Water (DDW) in accordance with the 1996 Memorandum of Agreement (MOA) that sets forth principles, procedures, and agreements to which the agencies committed themselves relative to permitting the use of reclaimed water in California.

This Order includes water reclamation requirements that apply to the production and storage of industrial reclaimed wastewater, as well as the Discharger's distribution and use of reclaimed water on the Discharger's property.

#### **K. Monitoring and Reporting**

Water Code section 13267 authorizes the Regional Water Board to require technical and monitoring reports. The MRP (Attachment D) establishes monitoring and reporting requirements to implement State requirements. The MRP is necessary to determine compliance with the conditions of this Order and to determine impacts of the discharge, if any, on groundwater. As such, the burden, including costs, of this monitoring bears a reasonable relationship to the need for that information and the benefits to be obtained from that information. The Executive Officer is delegated the authority to modify the MRP as appropriate to protect water quality.

**L. California Environmental Quality Act (CEQA)**

The discharges covered under this permit are exempt pursuant to California Code of Regulations, title 14, section 15301 (ongoing or existing projects). The Facility is an existing manufacturing facility with no expansion of use or industrial wastewater flow beyond existing use or design capacity.

**M. Notification of Interested Parties**

The Regional Water Board has notified the Discharger and interested agencies and persons of its intent to prescribe WDRs for the discharge and has provided them with an opportunity to submit their written comments and recommendations.

**N. Consideration of Public Comment**

The Regional Water Board provided a 30-day written comment period and in a public meeting, heard and considered all comments pertaining to the discharge.

**O. Petition of Action**

Any person aggrieved by this action of the Regional Water Board may petition the State Water Board to review the action in accordance with Water Code section 13320 and California Code of Regulations, title 23, sections 2050 and following.

The State Water Board must receive the petition by 5:00 p.m., 30 days after the date of this Order, except that if the thirtieth day following the date of this Order falls on a Saturday, Sunday, or state holiday, the petition must be received by the State Water Board by 5:00 p.m. on the next business day. Copies of the law and regulations applicable to filing petitions may be found on the Internet at the [North Coast Regional Water Quality Control Board Website](https://www.waterboards.ca.gov/public_notices/petitions/water_quality/) ([https://www.waterboards.ca.gov/public\\_notices/petitions/water\\_quality/](https://www.waterboards.ca.gov/public_notices/petitions/water_quality/)) for notices or will be provided upon request.

**P. AB 2108 Requirements**

The Regional Water Board publicly noticed the Order and provided opportunities for public comment. Public notice was provided to interested persons and public agencies in the region with jurisdiction over natural resources in the affected area, including the Sonoma County Health Department. The Regional Water Board conducted outreach in potentially affected disadvantaged communities and tribal communities. The discharge regulated by this Order is prohibited from

causing surface water impacts and contamination of drinking water<sup>4</sup> and is not expected to result in a disproportionate impact to tribal or disadvantaged communities. The Regional Water Board has satisfied the outreach requirements set forth in Water Code section 189.7.

#### **Q. Health and Safety Code**

Pursuant to sections 116407 and 116555.5 of the California Health and Safety Code (CHSC), the State Water Board chose to adopt standards for backflow protection and cross-connection control through the adoption of the Cross-Connection Control Policy Handbook (CCCPH), under California's Safe Drinking Water Act<sup>5</sup> (SDWA), to establish enforceable standards applicable to California's public water systems. The CCCPH is intended to ensure a public water system's (PWS) drinking water distribution system will not be subject to the backflow of liquids, gases, or other substance. The CCCPH and its standards apply to all California PWS's, as defined in CHSC, section 11675 (h).

Aside from the mandates of AB 1671 related to the State Water Board's need and authority to develop and adopt an enforceable CCCPH, there are long-standing statutory mandates in California's SDWA concerning backflow protection and cross-connection control. Prior to AB 1671 and the adoption of this CCCPH, California's regulations pertaining to cross-connection control were set forth in regulations in CCR Title 17, which were adopted in 1987 with minor revisions in 2000. Although still protective to public health, the CCR Title 17 cross-connection regulations required updating as both the drinking water and cross-connection control industries had evolved. The CCCPH updates those regulations. The State Water Board may update its standards for backflow protection and cross-connection control through revisions of the CCCPH.

### **III. DISCHARGE PROHIBITIONS**

- A.** The direct or indirect discharge of waste to surface waters is prohibited.
- B.** The discharge of any waste not disclosed by the Discharger or not within the reasonable contemplation of the Regional Water Board is prohibited.

---

<sup>4</sup> [State Water Resources Control Board Contaminants in Drinking Water](https://www.waterboards.ca.gov/drinking_water/certlic/drinkingwater/Chemicalcontaminants.html) (https://www.waterboards.ca.gov/drinking\_water/certlic/drinkingwater/Chemicalcontaminants.html)

<sup>5</sup> CHSC, div. 104, pt. 12, ch. 4, section 116270 et seq.



- C.** Creation of pollution, contamination, or nuisance as defined by section 13050 of the Water Code is prohibited.
- D.** The discharge or reclamation of untreated or partially treated wastewater (receiving a lower level of treatment than described in this Order) from anywhere within the collection, treatment, reclamation, or disposal system is prohibited.
- E.** The discharge of waste or distribution of reclaimed water to land that is not owned by or under agreement to use by the Discharger is prohibited, except as authorized under Order section VI (Solids Disposal and Handling Requirements).
- F.** The discharge of waste at any point not indicated in Table 2 and Attachment A (Facility Location and Irrigation Areas Map) of this Order, or authorized by a permit issued by the State Water Board or Regional Water Board is prohibited.
- G.** The average daily dry-weather flow (ADWF) of influent into the treatment plant shall not exceed 0.20 mgd. The peak wet-weather (PWWF) flow of influent into the treatment plant shall not exceed 0.20 mgd. Compliance with this prohibition shall be determined as defined in Order sections IX.B and IX.C.
- H.** The maximum flow of treated effluent from the treatment plant and discharged at Discharge Point 001 shall not exceed 0.07 mgd. Compliance with this prohibition shall be determined as defined in Order section IX.D.
- I.** Discharges of waste that violate any narrative or numerical water quality objectives are prohibited.
- J.** The discharge of collected screenings, sludges, and other solid waste is prohibited, except as authorized under Order section VI (Solids Disposal and Handling Requirements).
- K.** Discharge of waste classified as "hazardous," as defined in title 23, section 2521 of the California Code of Regulations (CCR), or classified as "designated," as defined in Water Code section 13173, is prohibited.

**IV. EFFLUENT LIMITATIONS**

**A. Effluent Limitations – Discharge to Irrigation Areas<sup>6</sup> (Discharge Point 001)**

1. The Discharger shall maintain compliance with the following effluent limitations for industrial wastewater prior to irrigation, with compliance measured at Monitoring Location EFF-001 as described in the MRP.

**Table 4. Effluent Limitations – Discharge to Irrigation Areas (Discharge Point 001)**

Parameter	Units	Average Monthly Effluent Limitation	Average Daily Effluent Limitation	Instantaneous Minimum Effluent Limitation	Instantaneous Maximum Effluent Limitation
Biochemical Oxygen Demand (5-day @ 20°C) (BOD)	mg/L	10	15	--	--
Total Dissolved Solids	mg/L	250	350	--	--
Total Suspended Solids (TSS)	mg/L	10	15	--	--
pH	mg/L	--	--	6.5	8.5
Arsenic	mg/L	--	0.05	--	--
Cadmium	mg/L	--	0.01	--	--
Chromium	mg/L	--	0.05	--	--
Copper	mg/L	--	0.5	--	--
Lead	mg/L	--	0.05	--	--
Silver	mg/L	--	0.05	--	--
Cyanide	mg/L	--	0.2	--	--
Phenols	mg/L	--	0.1	--	--

---

<sup>6</sup> Existing permanent spray and drip irrigation distribution system prior to adoption of this Order, as described in Order section II.B.

Parameter	Units	Average Monthly Effluent Limitation	Average Daily Effluent Limitation	Instantaneous Minimum Effluent Limitation	Instantaneous Maximum Effluent Limitation
Table Notes: See Order Section IX. Compliance Determination regarding compliance with average monthly, average weekly, maximum daily, and instantaneous effluent limitations.					

2. Total Coliform Bacteria. Industrial wastewater discharged at Discharge Point 001 shall not contain coliform bacteria in excess of the following concentrations:
  - a. The median concentration shall not exceed an MPN of 2.2 per 100 milliliters (mL), using the bacteriological results of the last 7 days for which analyses have been completed<sup>7</sup>; and
  - b. The number of coliform bacteria shall not exceed an MPN of 23 per 100 mL in more than one sample in any 30-day period.
  - c. No single sample shall exceed an MPN of 240 total coliform bacteria per 100 mL.

**V. OTHER SPECIFICATIONS**

**A. Water Reclamation Specifications**

The following water reclamation requirements apply to the Discharger’s distribution and use of reclaimed water on the Discharger’s property.

1. This Order authorizes the Discharger to reuse treated industrial wastewater that complies with effluent limitations and specifications contained in this Order for uses as identified in this Order accordingly:
  - a. The Discharger shall be responsible for ensuring that all reclaimed water meets all terms and conditions of this Order; and
  - b. Any applicable Salt and Nutrient Management Plan adopted by the Regional Water Board as a Basin Plan amendment; and

---

<sup>7</sup> See Order section IX.H regarding compliance with bacteriological limitations.

- c. Any applicable water quality related CEQA mitigation measure; and
- d. State Water Board Recycled Water Policy.

2. The Discharger shall notify the Regional Water Board in writing by submitting an updated Report of Waste Discharge in anticipation of reclaimed water use at a new location. The Discharger is subject to waste discharge requirements as set forth in this Order. Prior to commencement of water reclamation activities at the new location the Discharger must obtain Regional Water Board approval.
3. The Discharger shall submit an Irrigation Management Plan to the Regional Water Board within 18 months of the adoption of this Order. The plan shall be implemented, maintained, and revised as necessary to ensure that it is current regarding the following elements:
  - a. A description of the reclaimed water use areas, including: site location, acreage involved, County Assessor Parcel number(s), name of property owner, name of use site supervisor, estimation of the anticipated volume of reclaimed water to be used.
  - b. Information and calculations to demonstrate that reclaimed water irrigation does not exceed the hydraulic and nutrient agronomic needs of the vegetation being irrigated. The assessment of hydraulic and agronomic rates shall account for the following:
    - i. Soil characteristics;
    - ii. Reclaimed water characteristics (nutrients, including nitrogen and phosphorus content; specific ion toxicity, including chloride, boron, sodium, bicarbonate, and other parameters);
    - iii. General requirements of the major plant species being irrigated (e.g., seasonal demand, climate, nutrient requirements);
    - iv. Climatic conditions (e.g., precipitation, evapotranspiration rate, wind); and
    - v. Other supplemental nutrient additions (e.g., land-applied chemical fertilizers) generally used within the areas.
  - c. Describe BMPs that are implemented at the reclaimed water use areas to prevent runoff, ensure application at hydraulic and agronomic rates, and to address erosion control in the event of a break or leak in the reclaimed water distribution system. The description should include reclaimed water management facilities and other BMPs that will be used to ensure compliance with the requirements of this Order.

- d. A copy of the Discharger's established rules and/or regulations governing the use of reclaimed water in accordance with the criteria established in this Order.
4. The Discharger shall conduct inspections of the irrigation system, facilities, and operations at least semi-annually to monitor and ensure compliance with the conditions of this Order.
5. The Discharger shall discontinue all delivery of reclaimed water for irrigation during any period that there is reason to believe that the requirements for use as specified in this Order are not being met. The delivery of reclaimed water for irrigation shall not resume until all conditions have been corrected.
6. Any discharge of untreated or partially treated wastewater to any portion of the use areas, and the cessation of same, shall be reported immediately by telephone to the Regional Water Board, DDW, and the local health officer.
7. The Discharger shall be responsible for the operation and maintenance of transport facilities and associated appurtenances necessary to convey and distribute the reclaimed water from the point of production to the point of use.
8. The Discharger shall properly install, operate, and maintain the irrigation system to ensure compliance with all requirements of this Order.
9. The Discharger shall designate a Reclaimed Water Use Supervisor to operate and maintain the reclaimed water use areas. The Reclaimed Water Use Supervisor shall be responsible for the reclaimed water system. Specific responsibilities of the Reclaimed Water Use Supervisor, at a minimum, shall include the following:
  - a. Proper installation, operation, and maintenance of the irrigation system;
  - b. Control of onsite piping to prevent any cross-connections with potable water supplies;
  - c. Development and implementation of a set of procedures to verify on an ongoing basis that cross-connections have not occurred between potable water supplies and reclaimed water supplies;
  - d. Routine inspection and maintenance of backflow prevention devices installed to protect potable water supplies, consistent with section 7605 of title 17 of the CCR; and
  - e. General responsibilities to ensure compliance with this Order and continuous implementation of any BMPs identified as necessary to prevent potential hazards to public health and to protect the environment.

10. The use of reclaimed water for irrigation shall not result in unreasonable waste of water.

## **B. Reclaimed Water Use Site Specifications**

The following reclaimed water use site specifications apply to the Discharger's use of reclaimed water on the Discharger's property:

1. Reclaimed water shall not be irrigated within 50 feet of any domestic water supply well or domestic water supply surface intake, unless the technical requirements specified in CCR title 22, section 60310(a) have been met and approved by DDW. (Cal. Code Regs., tit. 22, § 60310(a)).
2. Reclaimed water irrigation runoff shall be confined to the reclaimed water use areas (irrigation areas).
3. Direct or windblown spray, mist, or runoff from irrigation areas shall not enter dwellings, designated outdoor eating areas, or food handling facilities, roadways, or any other area where the public would accidentally be exposed to reclaimed water.
4. Drinking water fountains must be protected against contact with reclaimed water spray, mist, or runoff.
5. All reclaimed water use areas must be posted with signs that are visible to the public, in a size no less than 4 inches high by 8 inches wide, that states the following: "RECLAIMED WATER - DO NOT DRINK". Each sign must display an international symbol like that shown in Figure 60310-A, §60310, title 22 of CCR. These signs need to be placed in conspicuous places including at each entrance to the reclaimed water irrigated area.
6. No physical connection can be made or allowed to exist between the reclaimed water system and any separate system conveying potable water. [Cal. Code Regs., tit. 22, § 60310(h)] If a swivel-ell device is planned to be used, the construction plan must be submitted to DDW and the Regional Water Board for review and approval.
7. The areas of the reclaimed water system that are in areas subject to access by the general public shall not include hose bibs. Only quick couplers that differ from those used on the potable water system can be used on the portions of the reclaimed water piping system in areas subject to public access.
8. Reclaimed water shall be applied at hydraulic and agronomic rates as described in this Order. Maximum allowable hydraulic and agronomic rates for each reclaimed water use site will be calculated as follows:

$$\text{Irrigation Water Requirements (Inches)} = \frac{(\text{ETo} * \text{Kc}) - \text{Peff}}{(1 - \text{LR}) * \text{Eu}}$$

Where:

ETo = Reference evapotranspiration (in inches) is defined as the amount of water used by the plants (transpiration) and evaporated from the soil (evaporation)(and is based on the consumptive water use of a local grass field, measured by the California Department of Water Resources, CIMIS database for CIMIS Zone 1 at [CIMIS website](https://cimis.water.ca.gov/App_Themes/images/etozonemap.jpg) (https://cimis.water.ca.gov/App\_Themes/images/etozonemap.jpg) Real time ETo data for CIMIS Zone 1 is collected from CIMIS Station 259 located in the Ferndale Plain.

Kc = Crop growth coefficient

Peff = Effective precipitation (amount of rainfall in inches available to pasture grasses, UC Davis Bodega Ocean Observing Node (BOON) station)

LR = Leaching Requirement, 0% (a conservative estimate) is the fraction of irrigation water (irrigation plus precipitation), required to leach the excess salt out of the root zone, to reduce salt stress on the plant root zone. LR is based on the salt concentration of the applied water and the salt tolerance of the crop.

Eu = Unit application irrigation efficiency

9. Reclaimed water shall not be applied during periods when soils are saturated. Specifically, reclaimed water application to land is prohibited during the following times:
  - a. Within 24 hours prior to a forecasted precipitation event with a greater than 50-percent probability of occurring. The Discharger must obtain the precipitation forecast information from the National Weather Service Forecast Office;
  - b. During a precipitation event;
  - c. Within 24 hours after a precipitation event of ½ inch or more precipitation (as measured within a 24-hour period) that results in a storm water discharge of precipitation from the irrigation areas
10. Areas irrigated with reclaimed water shall be managed to prevent ponding and conditions conducive to the proliferation of mosquitoes and other

disease vectors, and to avoid creation of a public nuisance or health hazard. The following practices shall be implemented, at a minimum:

- a. Reclaimed water used to irrigate shall infiltrate completely within a 48-hour period; and
  - b. Low-pressure and unpressurized pipelines and ditches that may be accessible to mosquitoes shall not be used to store reclaimed water.
11. The Discharger shall prevent surface runoff of reclaimed water. The Regional Water Board recognizes that even with diligent implementation of BMPs, incidental runoff events may occur on occasion. Incidental runoff is defined as unintended small amounts of runoff from reclaimed water use areas where hydraulic rates and appropriate BMPs are being implemented. Examples of incidental runoff include unintended, infrequent, minimal over-spray from sprinklers that escapes the reclaimed water use area or accidental breakage of a sprinkler head on a properly maintained irrigation system. Water leaving an irrigation/reclaimed water use area is not considered incidental if it is part of the facility design, if it is due to excessive application, if it is frequent, if it is due to intentional overflow or application, or if it is due to negligence. Incidental runoff events are typically infrequent, low volume, accidental, not due to a pattern of neglect or lack of oversight and are promptly addressed. At a minimum, the following measures shall be implemented to minimize the potential for surface runoff:
- a. A minimum 50-foot setback to all surface waters or provide written documentation of appropriate BMPs that will be implemented to prevent or minimize the potential for runoff discharging to surface water;
  - b. Implementation of an Operations and Maintenance Plan that provides for detection of leaks (for example from sprinkler heads), and correction within 72 hours of learning that runoff, or prior to release of 1,000 gallons, whichever comes first;
  - c. Proper design and aim of sprinkler heads;
  - d. Proper design and operation of the irrigation system;
  - e. Refraining from application during precipitation events;
  - f. Application at hydraulic and agronomic rates that does not exceed the water or nutrient demand of the crop or vegetation being irrigated;
  - g. Use of repeat start times and/or multiple water days with short run times to increase irrigation efficiency and reduce runoff potential. The goal of this BMP is to apply the volume of water needed to meet the needs of the crop



- or vegetation being irrigated by breaking the volume up into smaller volumes. For example, apply one hour of irrigation in four 15-minute applications, separated by an hour each. This will allow more water to soak into the ground and reduce runoff;
- h. Maintenance of irrigation infrastructure (pipelines, pumps, etc.) to prevent and minimize breakage and leaks; and
  - i. Adequate protection of all effluent storage tanks against overflow, structural damage, or a reduction in efficiency, and notification of the Executive Officer, if a discharge occurs.
12. Use areas that are spray irrigated and allow public access shall be irrigated during periods of minimal use. Consideration shall be given to allow maximum drying time prior to subsequent public use.
  13. All irrigation equipment, pumps, piping, valves, quick couplers and outlets shall be a type or secured in a manner that only permits operation by authorized personnel and shall be appropriately marked to differentiate them from potable facilities.
  14. The main shutoff valve of the irrigation system meter shall be tagged with a reclaimed water warning sign. The valve shall be equipped with an appropriate locking device to prevent unauthorized operation of the valve.

### **C. Cross-Connection Control**

The following cross-connection control requirements apply to the Discharger's production, storage, and use of reclaimed water on the Discharger's property.

1. The use of reclaimed water for irrigation shall not cause degradation of any water supply.
2. There shall be no cross-connection between a potable water supply and piping containing reclaimed water. The Discharger shall provide for appropriate backflow protection for potable water supplies as specified in CCR, title 17, section 7604 or as determined by the State Water Board on a case-by-case basis to protect public health.
3. The Discharger shall be responsible for ensuring that all reclaimed water meets all terms and conditions of this Order and the State Water Board's Cross-Connection Control Policy Handbook.
4. The Discharger shall consult with City of Santa Rosa Water and allow the City to conduct a hazard assessment of the Facility's distribution system to evaluate the potential for backflow into the PWS. The hazard assessment must consider:

- a. The existence of cross-connections;
  - b. The type and use of materials handled and present, or likely to be, at the Facility;
  - c. The degree of piping system complexity and accessibility;
  - d. Access to auxiliary water supplies, pumping systems, or pressure systems;
  - e. Distribution system conditions that increase the likelihood of a backflow event (e.g., hydraulic gradient differences impacted by main breaks and high-water demand situations, multiple service connections that may result in flow-through conditions, etc.);
  - f. User premises accessibility;
  - g. Any previous backflow incidents on the Discharger's premises; and
  - h. The requirements and information provided in the CCCPH.
5. In the annual self-monitoring report, the Discharger shall provide documentation of the degree of hazard to the PWS's distribution system as established by the City's hazard assessment and defined in Appendix D of the CCCPH (high, low, or no hazard).
  6. The Discharger shall conduct inspections of the irrigation system, facilities, and operations at least semi-annually to monitor and ensure compliance with the conditions of this Order.

**D. Storage Tanks.** The following requirements apply to treatment, effluent, and reclaimed water storage tanks.

1. **Storage Tank Management, Operation, and Maintenance.** Storage tanks shall be managed, operated, and maintained to protect containment integrity, prevent leaking and structural failure, and prevent damage from animals and atmospheric elements. Storage tank containment damage shall be repaired as soon as possible.
2. **Storage Tank Construction.** Tanks used for the storage of wastewater and reclaimed water shall be constructed in a manner that protects groundwater and surface water.
3. **Storage Tank Freeboard.** The Discharger shall always maintain at least 10 percent of capacity, or 2 feet, whichever is greater, of freeboard in all reclaimed water storage tanks.

- E. Objectionable Odor.** The Discharger shall prevent objectionable odors originating at the Facility from being perceivable beyond the limits of the wastewater treatment and disposal areas.
- F. Discharge.** No waste constituent shall be released or discharged or placed where it could be released or discharged in a concentration or in a mass that causes violation of the Basin Plan's water quality objectives for surface water or groundwater.
- G. Public Contact.** The Discharger shall preclude or control public contact with wastewater and reclaimed water through such means as fences and signs, or other applicable alternatives.
- H. Vector Control.** The Discharger shall manage the Facility and effluent disposal area to prevent the breeding of mosquitos. All open containment structures shall be managed to prevent breeding of mosquitoes or other vectors. Specifically:
1. An erosion control program shall be implemented to ensure that small coves and irregularities are not created around the perimeter of the irrigation surface areas.
  2. Weeds shall be minimized through control of water depth, harvesting, or herbicides.
  3. Dead algae, vegetation, and debris shall not accumulate on the irrigation areas.
  4. The Discharger shall consult and coordinate with the local Mosquito Abatement District to minimize the potential for mosquito breeding as needed to supplement the above measures.
- I. Technical Reports.** All technical reports required herein that involve planning, investigation, evaluation, or design, or other work requiring interpretation and proper application of engineering or geologic sciences, shall be prepared by or under the direction of person registered to practice in California pursuant to California Business and Professions Code (sections 6735, 7835, and 7835.1).

To demonstrate compliance with sections 415 and 3065 of title 16, CCR, all technical reports must contain a statement of the qualifications of the responsible registered professional(s). As required by these laws, completed technical reports must bear the signature(s) and seal(s) of the registered professional(s) in a manner that demonstrates that all work can be clearly attributed to the professional responsible for the work.

## **VI. SOLIDS DISPOSAL AND HANDLING REQUIREMENTS**

- A.** All collected screenings, sludges, and other solid waste removed from liquid wastes shall be removed from screens, sumps, and tanks as needed to ensure optimal plant operation and disposed of in accordance with applicable federal and State regulations.
- B.** Collected screenings, sludges, and other solid waste removed shall be disposed of in a manner approved by the Executive Officer and consistent with requirements in title 27, division 2 of the CCR (Consolidated Requirements for Treatment, Storage, Processing, or Disposal of Solid Waste).
- C.** In the annual self-monitoring report, the Discharger shall report the volume and mass of collected screenings, sludges, and other solid waste disposed of, or transferred to another party, including the name of the landfill or disposal site or the third party that received the screenings, sludges or other solid waste. For the purposes of this provision, volume shall be given in cubic meters and mass shall be given in kilograms.
- D.** The treatment, storage, transport, and disposal of collected screenings, sludges, and other solid waste shall not cause or threaten to cause pollution or nuisance, such as objectionable odors or flies, and shall not adversely affect human health or beneficial uses of groundwater or cause an exceedance of any applicable Basin Plan water quality objectives for groundwater or surface water.
- E.** The storage of collected screenings, sludges, and other solid waste shall not cause waste material to be in a position where it is, or can be, conveyed from the storage site and deposited in waters of the state.
- F.** All sludge applied to land must meet the ceiling concentrations for pollutants in the first column of Table 2-1 of 40 CFR Part 503. The ceiling concentrations are the maximum concentration limits for 10 heavy metal pollutants in biosolids; specifically, arsenic, cadmium, chromium, copper, lead, mercury, molybdenum, nickel, selenium, and zinc. If a limit for any one of the pollutants is exceeded, the sludge cannot be applied to land until such time as the ceiling concentrations limits are no longer exceeded.
- G.** There shall be no discharge of solid waste from the storage or application areas to adjacent land areas not regulated by this Order, to surface waters, or to surface water drainage courses.
- H.** If solid wastes are stored for over two years from the time they are generated by the Discharger, the Discharger must submit a written notification to U.S. EPA with the information in 40 CFR Part 503.20 (b), demonstrating the need for longer temporary storage.

## **VII. RECEIVING WATER LIMITATIONS**

- A.** The collection, treatment, storage, and disposal of the wastewater shall not cause degradation of groundwater quality unless a technical evaluation is performed that demonstrates that any degradation that could reasonably be expected to occur, after implementation of reasonable best management practices, will not violate groundwater quality objectives or cause impacts to beneficial uses of groundwater.
- B.** The collection, treatment, storage and disposal of the wastewater shall not cause or contribute to levels of chemical constituents in groundwater that exceed the primary and secondary maximum contaminant levels (MCL and SMCL, respectively) specified in California Code of Regulations, title 22, Table 64431-A, Table 64444-A, Table 64449-A, and Table 64449-B. (Cal. Code Regs., tit. 22, § 64431, 64444 and § 64449.).
- C.** The collection, treatment, storage and disposal of the wastewater shall not cause or contribute to levels of radionuclides in groundwater in concentrations that cause nuisance or adversely affect beneficial uses, nor in excess of the limits specified in California Code of Regulations, title 22, Table 64442 and Table 64443. (Cal. Code Regs., tit. 22, § 64442, and § 64443.).
- D.** The collection, treatment, storage, and disposal of the wastewater shall not cause groundwater to contain taste- or odor-producing substances in concentrations that cause nuisance or adversely affect beneficial uses.
- E.** The collection, treatment, storage and disposal of the wastewater shall not cause the median concentration of coliform organisms over any 7-day period to exceed 1.1 MPN per 100 milliliters or 1 colony per 100 milliliters in groundwater used or potentially used for domestic and municipal supply (MUN).
- F.** The collection, treatment, storage and disposal of the wastewater shall not cause groundwater to contain toxic substances in concentrations that are toxic to, or that produce detrimental physiological responses in humans, or that adversely affects beneficial uses. This limitation applies regardless of whether the toxicity is caused by a single substance or the synergistic effect of multiple substances.

## **VIII. GENERAL PROVISIONS**

Failure to comply with provisions or requirements of this Order, or violation of other applicable laws or regulations governing discharges from this Facility may subject the Discharger to administrative or civil liabilities, criminal penalties, and/or other enforcement remedies. Additionally, certain violations may subject the Discharger to civil or criminal enforcement from appropriate local, state, or federal law enforcement entities. The Discharger shall comply with the following provisions:

**A. Availability**

A copy of this Order and the associated MRP shall be maintained at the Facility and be available at all times to operating personnel.

**B. Enforcement**

The Discharger shall operate and maintain the Facility as described in this Order. Violation of any requirements contained in this Order subject the Discharger to enforcement action, including administrative civil liability or civil liability, under the Water Code.

**C. Severability**

Provisions of these waste discharge requirements are severable. If any provision of these requirements is found invalid, the remainder of these requirements shall not be affected.

**D. Operation and Maintenance**

1. The Discharger shall at all times properly operate and maintain all facilities and systems of collection, treatment and control (and related appurtenances) that are installed or used by the Discharger to achieve compliance with this Order. Proper operation and maintenance includes adequate laboratory control and appropriate quality assurance procedures. This provision requires the operation of backup or auxiliary facilities or similar systems that are installed by a Discharger only when necessary to achieve compliance with the conditions of this Order.
2. The Discharger shall maintain an updated Operation and Maintenance Manual (O&M Manual) for the operational components of the Facility. The Discharger shall update the O&M Manual, as necessary, to conform to changes in operation and maintenance of the Facility. The next O&M Manual update shall be completed and submitted to the Regional Water Board electronically **by July 1, 2025**, to ensure it is consistent with current operating requirements, procedures, and maintenance needs. O&M Manual revisions shall be submitted to DDW and the Regional Water Board for approval upon any changes or modifications to the Facility process and/or its operations. The Discharger shall operate and maintain the Facility in accordance with the most recently updated O&M Manual. The O&M Manual shall be readily available to operating personnel on-site and for review by state inspectors.
3. A preventive maintenance program must be maintained for the Facility to ensure all equipment is kept in a reliable operating condition.

#### **E. Change in Discharge**

The Discharger shall promptly report to the Regional Water Board any material change in the character, location, or volume of the discharge.

#### **F. Change in Control or Ownership**

In the event of any change in control or ownership of land or waste discharge facilities presently owned, controlled, or used by the Discharger, the Discharger shall notify the Regional Water Board of such changes in writing, and shall also notify the succeeding owner or operator of the existence of this Order and current compliance status in writing.

The succeeding owner or operator, in order to obtain authorization for discharges regulated by this Order, must apply in writing to the Executive Officer, requesting transfer of the Order. This request must include complete identification of the new owner or operator, the reasons for the change, and effective date of the change. Discharges conducted without submittal of this request will be considered discharges without waste discharge requirements, which are violations of the Water Code.

#### **G. Vested Rights**

This Order does not convey any property rights of any sort or any exclusive privileges. The requirements prescribed herein do not authorize the commission of any act causing injury to persons or property, nor protect the Discharger from liability under federal, state, or local laws, nor create a vested right for the Discharger to continue the waste discharge.

#### **H. Monitoring and Reporting**

The Discharger shall comply with the MRP (Attachment D), and any modifications to these documents as specified by the Executive Officer. Chemical, bacteriological, and bioassay analyses shall be conducted at a laboratory certified for such analyses by the State of California Environmental Laboratory Accreditation Program. The Discharger may analyze pollutants with short hold times (e.g., pH, dissolved oxygen, electrical conductivity, etc.) with field equipment or its on-site laboratory provided that the Discharger comply with the specifications in the MRP.

#### **I. Records Retention**

The Discharger shall maintain records of all operating and monitoring information required by this Order, including calibration and maintenance records and all strip chart recordings for continuous monitoring instrumentation, analyses specified in the MRP in Attachment D of this Order, records of operational problems, plant

and equipment breakdowns, diversions to emergency storage or disposal, and all corrective or preventive action(s) taken, copies of all reports required by this Order, and records of all data used to complete the application for this Order, for a period of at least three (3) years from the date of the sample, measurement, report, or application. This period may be extended upon notification of extension by the Executive Officer.

## **J. Signatory Requirements**

All reports shall be signed by persons identified below:

1. For a corporation: by a principal executive officer of at least the level of senior vice-president.
2. For a partnership or sole proprietorship: by a general partner or the proprietor.
3. For a municipality, state, federal or other public agency: by either a principal executive officer or ranking elected or appointed official.
4. A duly authorized representative of a person designated in L1, L2 or L3 of this requirement if;
  - a. the authorization is made in writing by a person described in L1, L2 or L3 of this requirement;
  - b. the authorization specifies either an individual or a position having responsibility for the overall operation of the regulated facility or activity, such as the position of plant manager, operator of a waste management unit, superintendent, or position of equivalent responsibility. (A duly authorized representative may thus be either a named individual or any individual occupying a named position);
  - c. the written authorization is submitted to the Regional Water Board prior to or together with any reports, information, or applications signed by the authorized representative.
5. Any person signing a document under paragraph (a) or (b) of this provision shall make the following certification:

"I certify under penalty of law that this document and all attachments were prepared under my direction or supervision in accordance with a system designed to assure that qualified personnel properly gather and evaluate the information submitted. Based on my inquiry of the person or persons who manage the system, or those persons directly responsible for gathering the information, the information submitted, is, to the best of my knowledge and



belief, true, accurate, and complete. I am aware that significant penalties may be assessed for submitting false information."

#### **K. Inspections**

The Discharger shall permit authorized staff of the Regional Water Board the following:

1. Entrance to the premises in which treatment, collection or management of waste occurs, where an effluent source is located or in which any records required by this Order are kept;
2. Access to inspect and copy any monitoring equipment or records required for compliance with terms and conditions of this Order; and
3. Access to sample any discharge or monitoring location associated with the Facility.

#### **L. Noncompliance**

1. In the event the Discharger is unable to comply with any of the conditions of this Order due to breakdown of waste treatment equipment, accidents caused by human error or negligence, or other causes such as acts of nature, the Discharger shall notify Regional Water Board staff by telephone as soon as it or its agents have knowledge of the incident and confirm this notification in writing within five (5) business days of the telephone notification. The written notification shall include pertinent information explaining reasons for the noncompliance and shall indicate the steps taken to correct the problem and the dates thereof, and the steps being taken to prevent the problem from recurring.
2. Process or equipment failures triggering an alarm must be recorded and maintained as a separate record file. The recorded information must include the time and cause of failure and corrective action taken.
3. Any discharge of untreated or partially treated wastewater to the use area, and the cessation of same, must be reported immediately by telephone to the Regional Water Board, DDW, and the local health officer.
4. The Discharger shall report all violations of this Order in the Discharger's reclaimed water/irrigation monitoring reports, including incidental runoff events that the Discharger is aware of.

#### **M. Revision of Requirements**

The Regional Water Board will review this Order periodically and may revise requirements when necessary.

#### **N. Operator Certification and Adequate Staffing**

The Discharger must always provide a sufficient number of qualified personnel to operate the Facility effectively to achieve the required level of treatment.

#### **O. Adequate Capacity**

If the Facility will reach capacity within 4 years, the Discharger shall notify the Regional Water Board. The Discharger shall demonstrate that adequate steps are being taken to address the capacity problem. The Discharger shall submit a technical report to the Regional Water Board showing how flow volumes will be prevented from exceeding capacity, or how capacity will be increased, within 120 days after providing notification to the Regional Water Board, or within 120 days after receipt of Regional Water Board notification, that the Facility will reach capacity within 4 years.

#### **P. New Tanks**

New tanks associated with the treatment and or storage of treated wastewater shall be constructed in a manner that protects groundwater and surface water. The Discharger shall submit design proposals for new wastewater storage tanks to the Executive Officer for review prior to construction, complete any necessary environmental review to comply with the California Environmental Quality Act (CEQA), and demonstrate that the tank design and maintenance plan includes features and BMPs to protect groundwater and surface waters and prevent exceedances of water quality objectives.

### **IX. COMPLIANCE DETERMINATION**

Compliance with this Order will be determined as specified below.

#### **A. Multiple Sample Data**

When determining compliance with an average effluent limitation, and more than one sample result is available, the Discharger shall compute the arithmetic mean unless the data set contains one or more reported determinations of "Detected, but Not Quantified" (DNQ) or "Not Detected" (ND). In those cases, the Discharger shall compute the median in place of the arithmetic mean in accordance with the following procedure:

1. The data set shall be ranked from low to high, ranking the ND concentrations lowest, DNQ determinations next, followed by quantified values (if any). The order of the individual ND and DNQ determinations is not important.
2. The median value of the data set shall be determined. If the data set has an odd number of data points, then the median is the middle value. If the data set has an even number of data points, the median is the average of the two

middle values, unless one or both of the points are ND or DNQ, in which case a value of zero shall be used for the ND or DNQ value in the median calculation for compliance purposes only. Using a value of zero for DNQ or ND samples does not apply when performing reasonable potential or antidegradation analyses.

**B. Average Daily Dry Weather Flow (ADWF)**

Compliance with the ADWF prohibition in section III.G of this Order will be determined once each calendar year by evaluating all flow data collected in a calendar year. The flow through the Facility, measured daily and averaged monthly, must be 0.20 mgd or less for the month with the lowest average monthly flow. Compliance with this prohibition shall be measured continuously at Monitoring Location INF-001 and calculated daily.

**C. Peak Wet Weather Flow (PWWF)**

The PWWF is the maximum flow rate that occurs over a 24-hour period. Compliance with the prohibition in section III.G of this Order concerning PWWF will be determined daily by measuring the daily average flow at Monitoring Location INF-001. If the measured daily average flow exceeds 0.20 mgd, the discharge is not in compliance with the prohibition.

**D. Maximum Effluent Flow**

The maximum effluent flow is this maximum flow rate that occurs over a 24-hour period. Compliance with the prohibition in section III.G of this Order will be determined daily by measuring the daily average flows at Monitoring Location EFF-001. If the measured daily average flow exceeds 0.07 mgd, the discharge is not in compliance with the prohibition.

**E. Average Monthly Effluent Limitation (AMEL)**

1. The arithmetic mean of all samples collected in a calendar month, calculated as the sum of all samples in a calendar month divided by the number of samples. If only one sample is collected in a calendar month, that sample result will constitute the monthly average and daily maximum results for the purpose of determining compliance with effluent limitations.
2. If the average of daily discharges over a calendar month exceeds the AMEL for a given parameter, this will represent a single violation, though the Discharger will be considered out of compliance for each day of that month for that parameter (e.g., resulting in 31 days of non-compliance in a 31-day month). If only a single sample is taken during the calendar month and the analytical results for that sample exceeds the AMEL, the Discharger will be

considered out of compliance for that calendar month. The Discharger will only be considered out of compliance for days when the discharge occurs.

3. If there are ND or DNQ results for a specific constituent in a calendar month, the Discharger shall calculate the median of all sample results within that month for compliance determination with the AMEL as described in Order section IX.A, above.
4. For any one calendar month during which no sample (daily discharge) is taken, no compliance determination can be made for that calendar month.

#### **F. Average Weekly Effluent Limitation (AWEL)**

1. The arithmetic mean of all samples collected over a calendar week, calculated as the sum of all samples in a calendar week divided by the number of samples. If only one sample is collected in a calendar week, that sample result will constitute the weekly average and daily maximum results for the purpose of determining compliance with effluent limitations.
2. If the average of daily discharges over a calendar week exceeds the AWEL for a given parameter, this will represent a single violation, though the Discharger will be considered out of compliance for each day of that week for that parameter.

If only a single sample is taken during the calendar week and the analytical results for that sample exceeds the AWEL, the Discharger will be considered out of compliance for that calendar week. The Discharger will only be considered out of compliance for days when the discharge occurs.

3. If there are ND or DNQ results for a specific constituent in a calendar week, the Discharger shall calculate the median of all sample results within that week for compliance determination with the AWEL as described in Order section IX.A, above.
4. For any calendar week during which no sample (daily discharge) is taken, no compliance determination can be made for that calendar week.

#### **G. Instantaneous Minimum Effluent Limitations**

If the analytical result of a single grab sample is lower than the instantaneous minimum effluent limitation for a parameter, the Discharger will be considered out of compliance for that parameter for that single sample. Non-compliance for each sample will be considered separately (e.g., the results of two grab samples taken within a calendar day that both are lower than the instantaneous minimum effluent limitation would result in two instances of non-compliance with the instantaneous minimum effluent limitation).

## H. Bacteriological Limitations

1. The median is the central tendency concentration of the pollutant. The data set shall be ranked from low to high, ranking the ND concentrations lowest, DNQ determinations next, followed by quantified values. The order of the individual ND and DNQ determinations is not important. The median value is determined based on the number of data points in the data set. If the data set has an odd number of data points, then the median is the middle value. If the data set has an even number of data points, the median is the average of the two middle values, unless one or both points are ND or DNQ, in which case the median value shall be the lower of the two middle data points. DNQ is lower than a detected value, and ND is lower than DNQ.
2. Compliance with the 7-day median will be determined as a rolling median during periods when sampling occurs more frequently than weekly. During periods when sampling is weekly, this requirement shall apply to each weekly sample.

**ATTACHMENT A - FACILITY LOCATION AND IRRIGATION AREAS MAP**

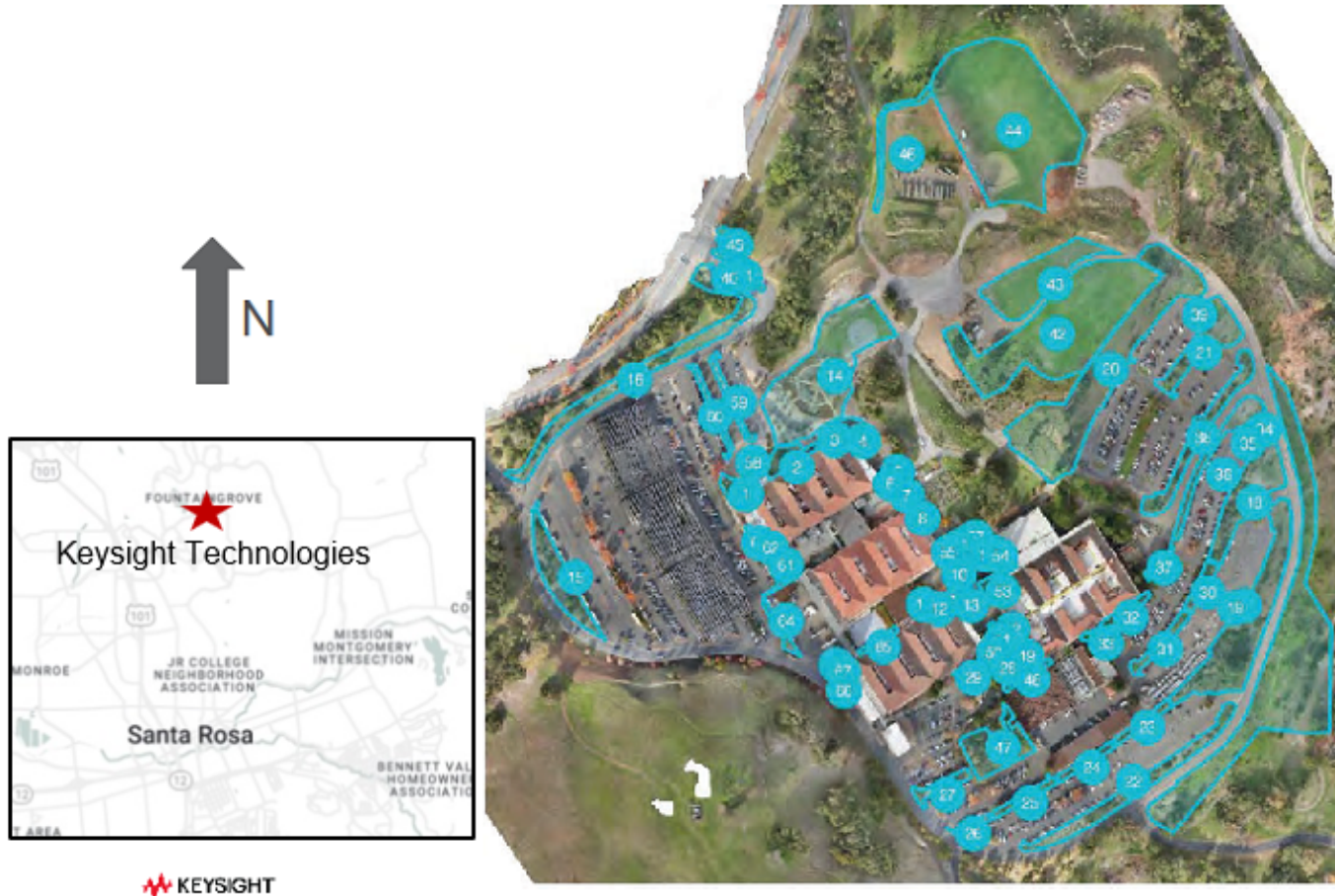

**Keysight  
Technologies**  
1400 Fountaingrove  
Pkwy, Santa Rosa  
  
**Irrigation Area Map**

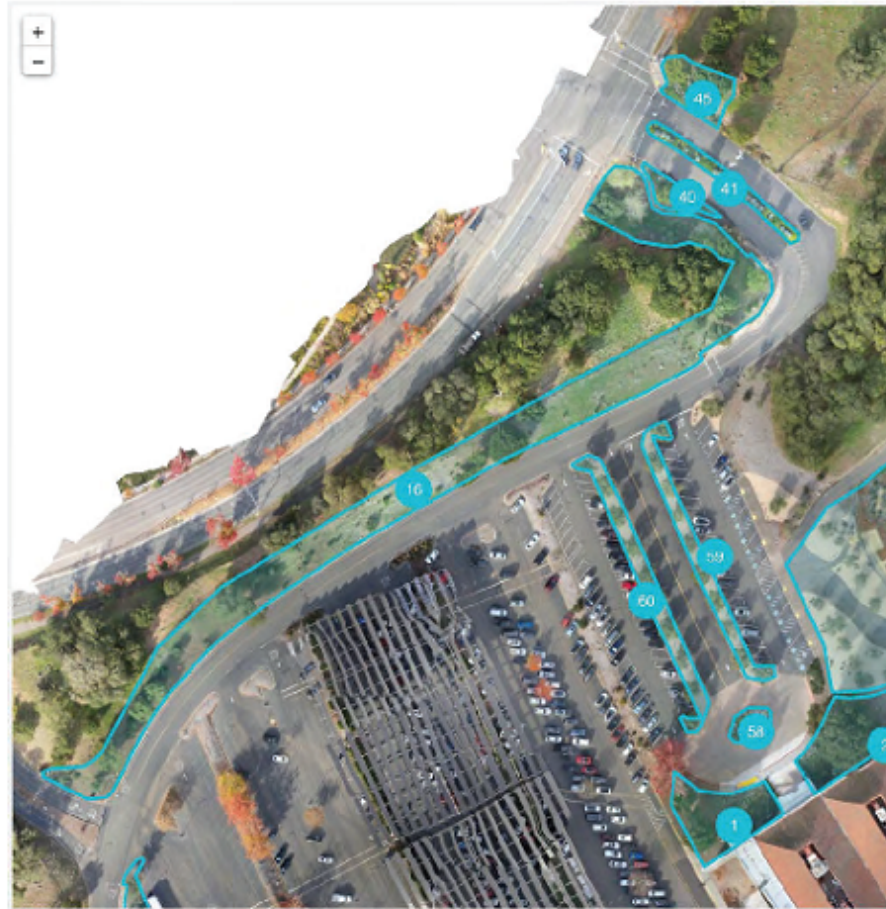
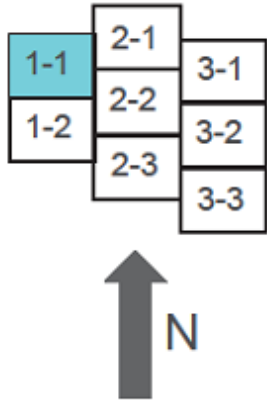

1-1





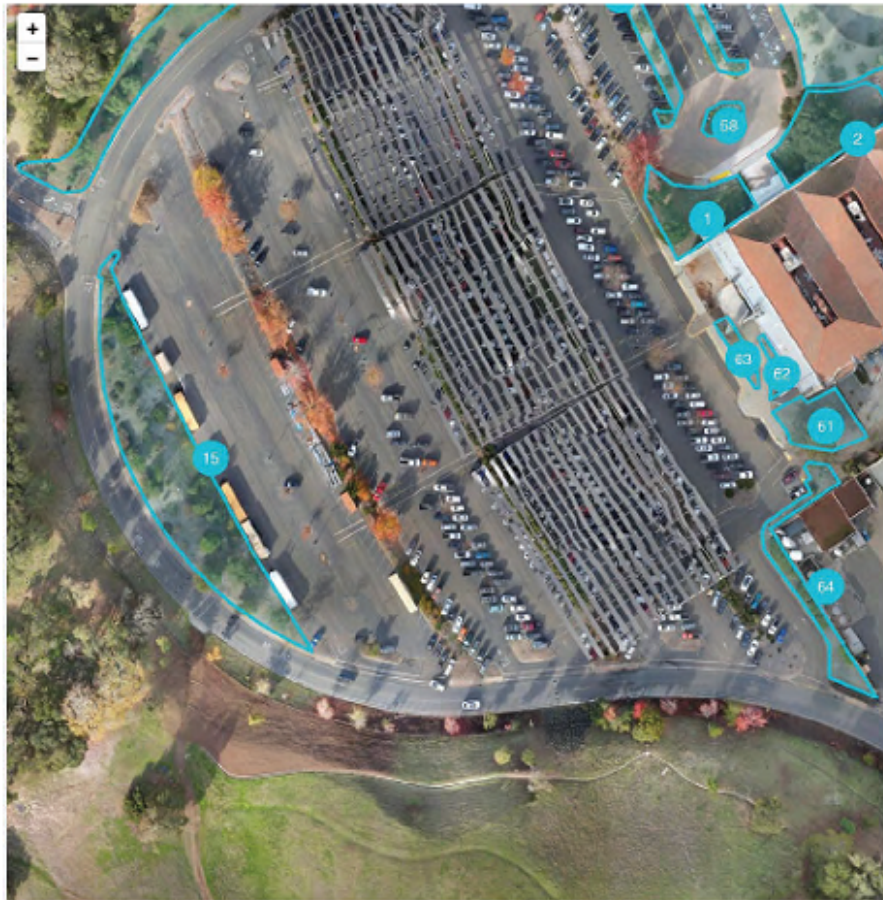
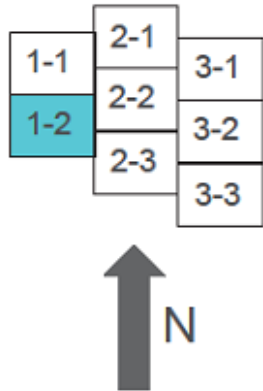

1-2

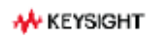



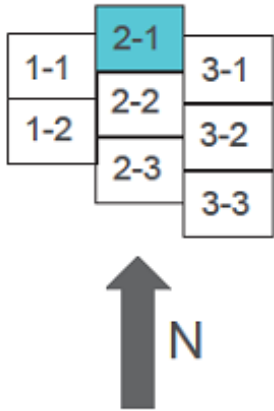

2-1

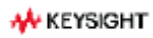

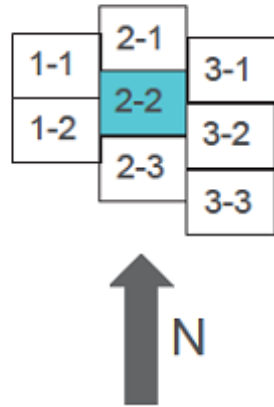

2-2





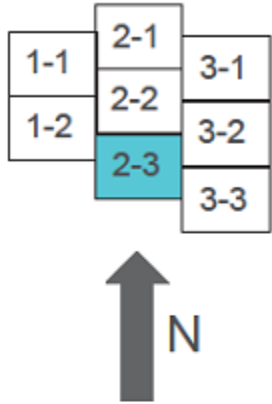

2-3

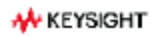

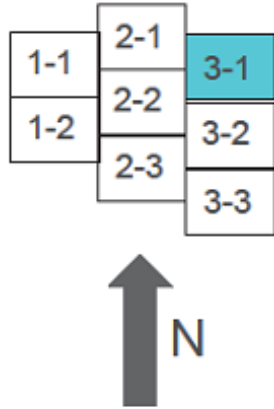

3-1

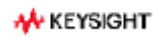



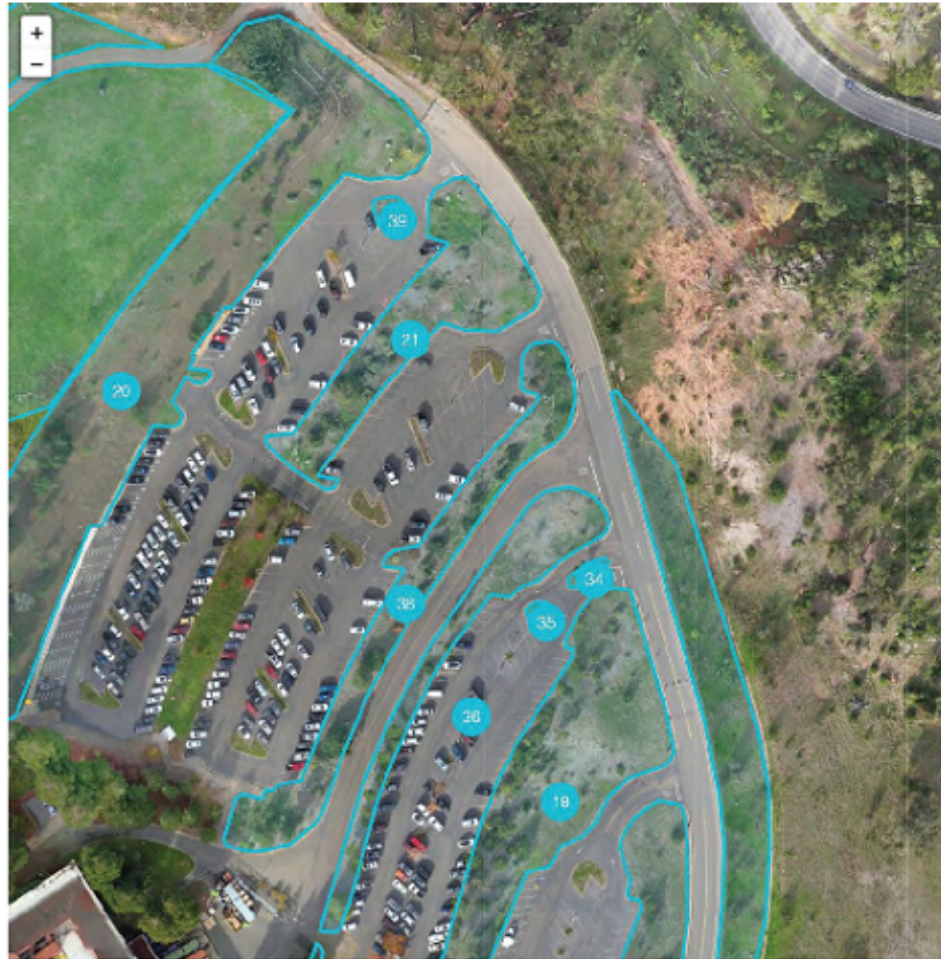
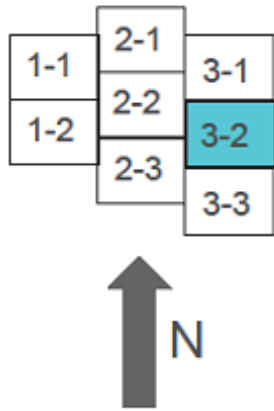

3-2

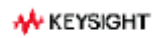

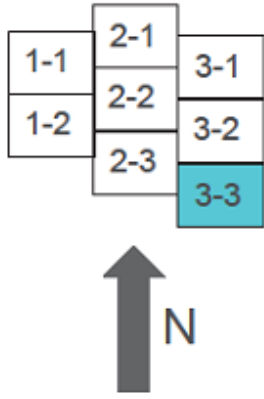

3-3



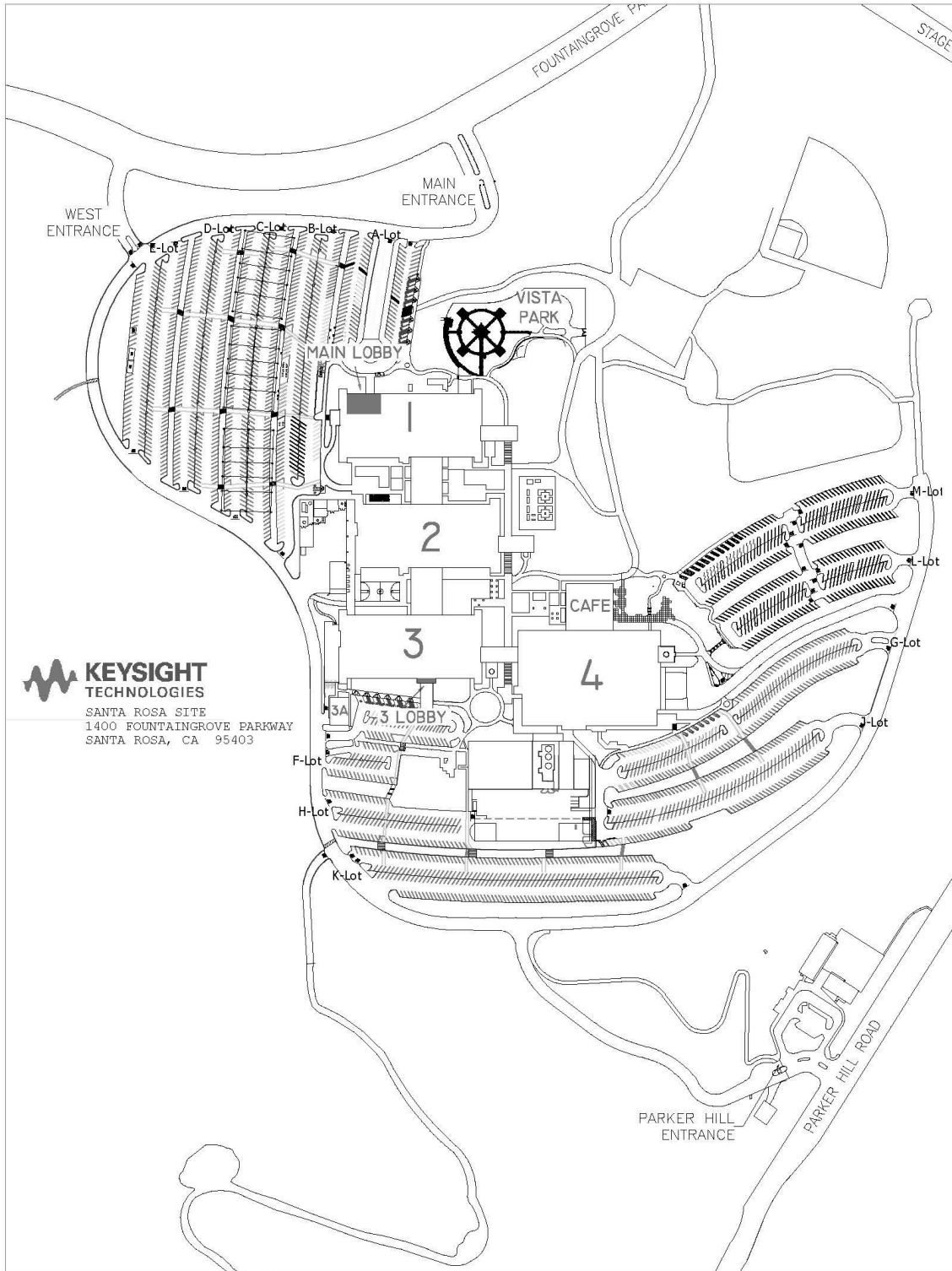

**ATTACHMENT C - FACILITY FLOW SCHEMATICS**

**Figure 1**  
**Tech Center - Semiconductor 469**

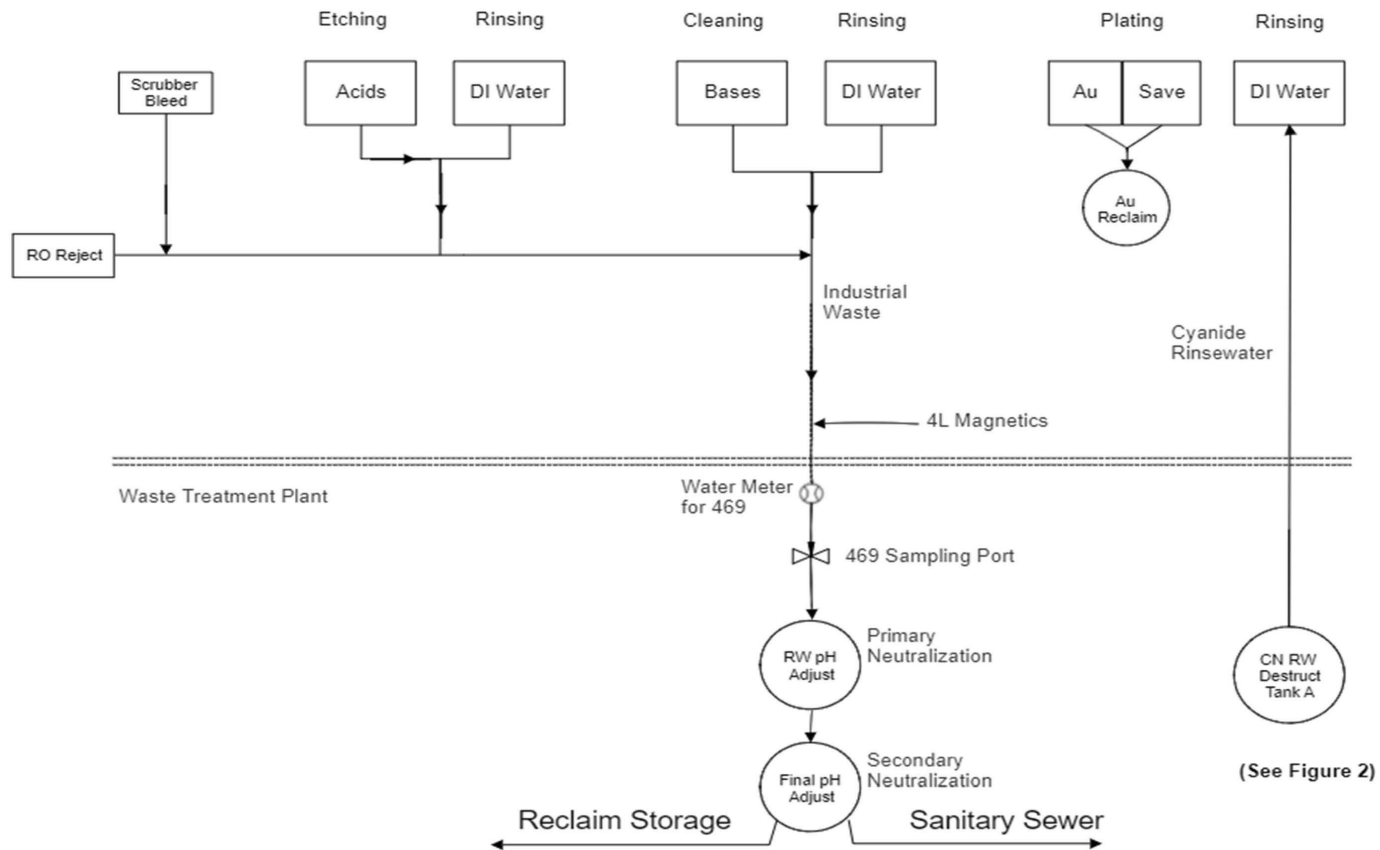



ATTACHMENT C - FACILITY FLOW SCHEMATICS

Figure 2  
Plating Shop - Metal Finishing 433

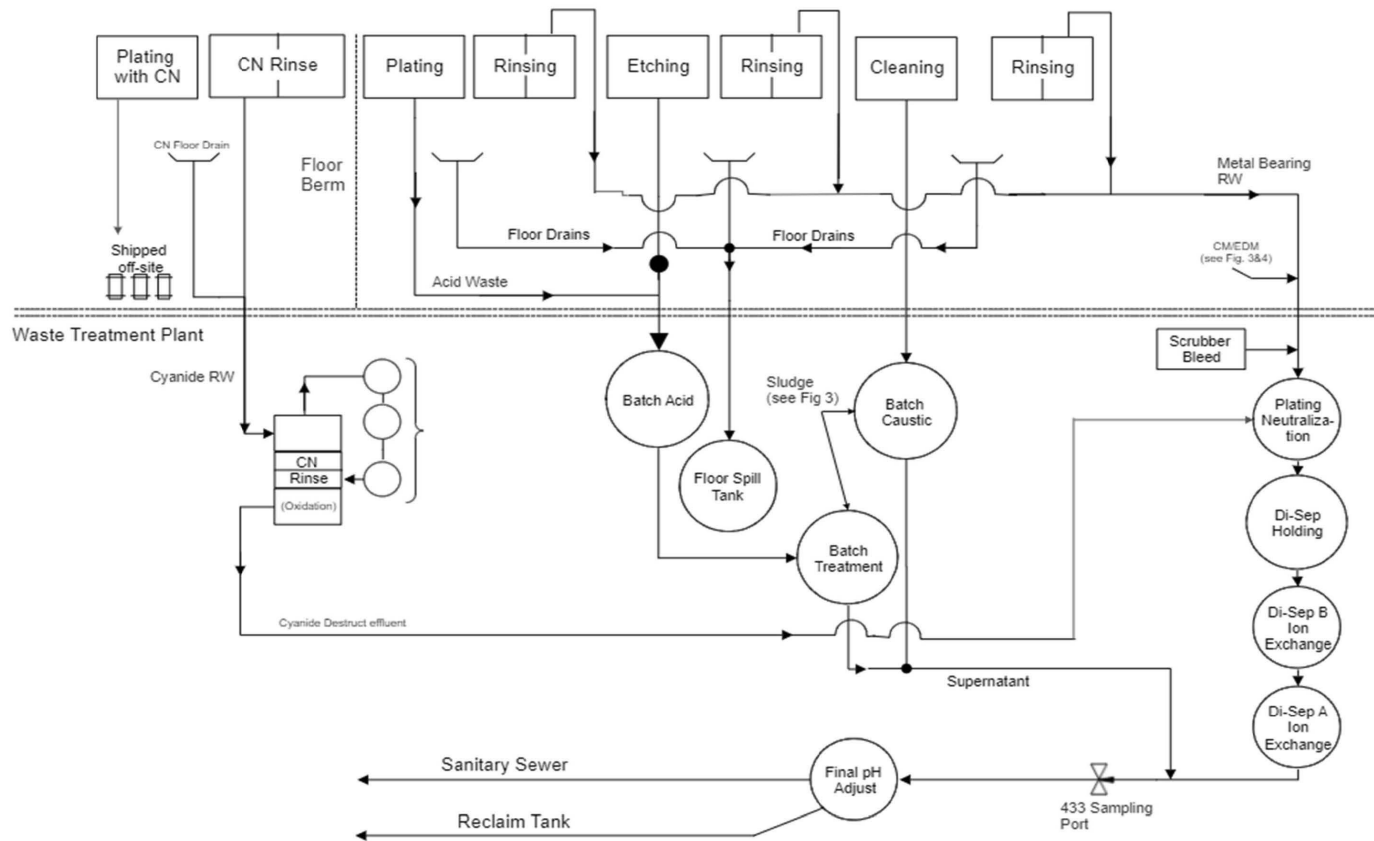

ATTACHMENT C - FACILITY FLOW SCHEMATICS

Figure 3  
Chemical Milling - Metal Finishing 433

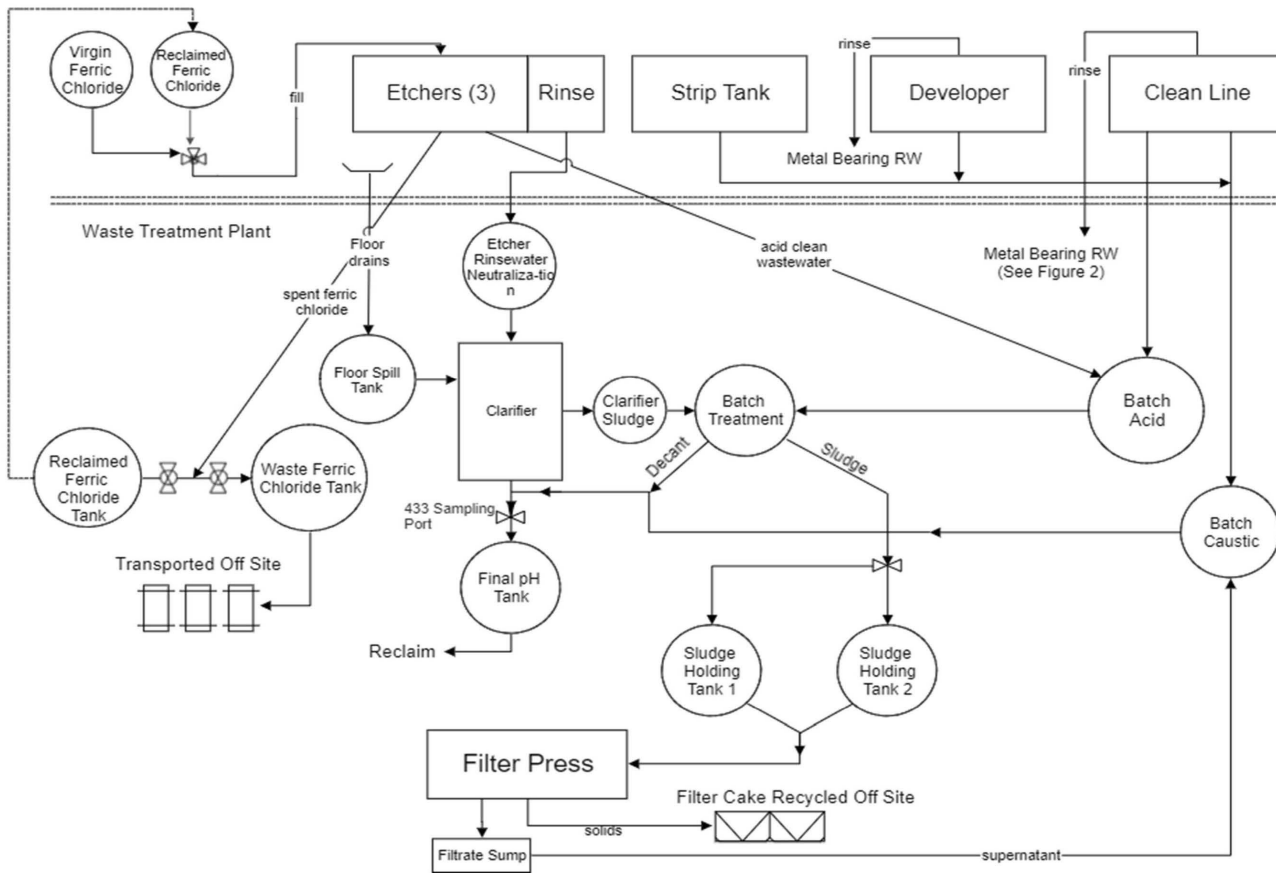

ATTACHMENT C - FACILITY FLOW SCHEMATICS

Figure 4  
EDM / Machine Shop - Metal Finishing 433

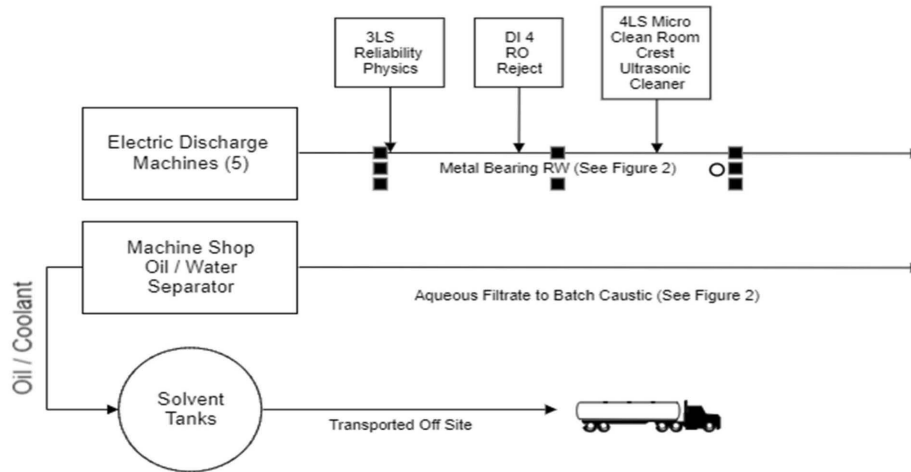

## **ATTACHMENT D - MONITORING AND REPORTING PROGRAM**

This Monitoring and Reporting Program (MRP) is issued pursuant to California Water Code (Water Code) section 13267 which authorizes the Regional Water Quality Control Board (Regional Water Board) to require technical and monitoring reports. The technical and monitoring reports required by this Order are necessary to ensure compliance with Order No. R1-2024-0006 and to protect human health and waters of the state. The costs of the technical or monitoring reports required by this Order bear a reasonable relationship to the need for these reports and the benefit to be gained by these reports.

This MRP establishes monitoring and reporting requirements, which are necessary to assure the discharges of waste that could impact water quality complies with waste discharge requirements and water quality objectives. This MRP may be modified, as necessary by the Executive Officer. Pursuant to Water Code section 13268, failure to submit the report(s) as described by this Order is a misdemeanor and may subject the Discharger to an administrative civil liability if the reports are not received by the deadline.

### **I. GENERAL MONITORING PROVISIONS**

#### **A. Wastewater Monitoring Provision**

Composite samples may be taken by a proportional sampling device or by grab samples composited in proportion to flow. In compositing grab samples, the sampling interval shall not exceed 1 hour.

#### **B. Supplemental Monitoring Provision**

If the Discharger monitors any pollutant more frequently than required by this Order, the results of this monitoring shall be included in the calculation and reporting of the data submitted in the monthly and annual self-monitoring reports.

#### **C. Laboratory Certification**

1. Laboratories analyzing monitoring samples shall be certified by the State of California Environmental Laboratory Accreditation Program (ELAP), in accordance with Water Code section 13176, and must include quality assurance/quality control data with their reports.
2. The Discharger may analyze pollutants with short hold times (e.g., pH, dissolved oxygen, settleable solids, electrical conductivity, temperature etc.) in its on-site laboratory provided that the Discharger has standard operating procedures (SOPs) that identify quality assurance/quality control procedures

to be followed to ensure accurate results. assurance/quality control procedures to be followed to ensure accurate results.

The Discharger shall keep a manual onsite containing the steps followed in this program and must demonstrate sufficient capability to adequately perform these field tests (e.g., qualified and trained employees, properly calibrated and maintained field instruments). The program shall conform to approved guidelines or procedures (i.e., U.S. EPA, Standard Methods, etc.).

#### **D. Minimum Levels**

Compliance and reasonable potential monitoring analyses shall be conducted using commercially available and reasonably achievable detection limits that are lower than the applicable effluent limitation. If no minimum level (ML) value is below the effluent limitation, the lowest ML shall be selected as the reporting level (RL).

#### **E. Monitoring Equipment Calibration Provision**

All monitoring and analysis instruments and devices used by the Discharger to fulfill this MRP shall be properly maintained and calibrated as recommended by the manufacturer to ensure their continued accuracy. All flow measurement devices shall be calibrated no less than the manufacturer's recommended intervals or one-year intervals (whichever comes first), to ensure continued accuracy of the devices.

#### **F. Sample Documentation**

All samples shall be representative of the volume and nature of the discharge or matrix of material sampled. The name of the sampler, sample type (grab or composite), time, date, location, bottle type, and any preservative used for each sample shall be recorded on the sample chain of custody form. The chain of custody form must also contain all custody information including date, time, and to whom samples were relinquished. If composite samples are collected, the basis for sampling (time or flow weighted) shall be approved by Regional Water Board staff.

#### **G. Field Test Instruments**

Field test instruments (such as those used to test pH, dissolved oxygen, and electrical conductivity) may be used provided that they are used by an ELAP certified laboratory or:

1. The user is trained in proper use and maintenance of the instruments;

2. The instruments are field calibrated prior to monitoring events at the frequency recommended by the manufacturer;
3. Instruments are serviced by the manufacturer or authorized representative at the recommended frequency; and
4. Field calibration reports are maintained and available for at least three years.

#### **H. Duplicative Monitoring Requirements**

If monitoring requirements listed below duplicate existing monitoring requirements under other orders including WDRs or waivers of WDRs, then duplication of sampling and monitoring activities are not required if the monitoring activity satisfies the requirements of this MRP. In addition to submitting the results under another order, the results shall be submitted in the reports required by this MRP.

#### **I. Approved Test Methods**

All monitoring must be conducted using approved test methods or other test methods specified in this MRP.

#### **J. Sampling Method**

Collecting composite samples is acceptable in most cases. Due to short holding times, bacteriological samples collected to verify disinfection effectiveness must be grab samples.

### **II. MONITORING LOCATIONS**

The Discharger shall establish the following monitoring locations to demonstrate compliance with the discharge prohibitions, discharge specifications, and other requirements in this Order:

**Table G-1. Monitoring Station Locations**

<b>Discharge Point Name</b>	<b>Monitoring Location Name</b>	<b>Monitoring Location Description</b>
--	INF-001	Influent monitoring location prior to wastewater treatment
001	EFF-001	Effluent monitoring location following wastewater treatment and prior to discharge to irrigation areas <sup>8</sup>
--	TNK-001, TNK-002	Reclaimed water storage tank monitoring locations

**III. MONITORING REQUIREMENTS**

**A. Influent Monitoring – Monitoring Location INF-001**

The Discharger shall monitor influent wastewater to the Facility at Monitoring Location INF-001 as follows:

**Table G-2. Influent Flow – Monitoring Location INF-001**

<b>Parameter</b>	<b>Units</b>	<b>Sample Type</b>	<b>Minimum Sampling Frequency</b>
Influent Flow <sup>1</sup>	mgd	Meter	Continuous

Table Notes:

1. The Discharger shall report the daily average and monthly average flows.

**B. Reclaimed Industrial Wastewater (Effluent) Monitoring – Monitoring Locations EFF-001**

The Discharger shall measure and record the volume of reclaimed industrial wastewater effluent and monitor reclaimed water at Monitoring Location EFF-001 as follows:

<sup>8</sup> Existing permanent spray and drip irrigation distribution system prior to adoption of the Order, as described in Order section II.B.

**Table G-3. Reclaimed Industrial Wastewater Effluent Monitoring – Monitoring Location EFF-001**

Parameter	Units	Sample Type	Minimum Sampling Frequency
Flow <sup>1</sup>	mgd	Meter	Continuous
BOD	mg/L	18-hour composite <sup>2</sup>	Monthly
TSS	mg/L	18-hour composite <sup>2</sup>	Monthly
pH	Standard Units	Grab	Monthly
Total Dissolved Solids	mg/L	18-hour composite <sup>2</sup>	Quarterly <sup>4</sup>
Arsenic	mg/L	18-hour composite <sup>2</sup>	Quarterly
Cadmium	mg/L	18-hour composite <sup>2</sup>	Quarterly
Chromium	mg/L	18-hour composite <sup>2</sup>	Quarterly
Copper	mg/L	18-hour composite <sup>2</sup>	Quarterly
Lead	mg/L	18-hour composite <sup>2</sup>	Quarterly
Silver	mg/L	18-hour composite <sup>2</sup>	Quarterly
Cyanide	mg/L	18-hour composite <sup>2</sup>	Quarterly
Phenols	mg/L	18-hour composite <sup>2</sup>	Quarterly
Title 22 Pollutants	ug/L	Grab	Annually <sup>3,4</sup>

**Table Notes:**

1. Each month, the Discharger shall report the daily average and monthly average reclaimed industrial wastewater effluent flows.
2. Samples shall be taken a minimum of hourly over an 18 hour period and composited.
3. The first sampling event must take place in May 2025. After the third annual sample, the frequency and requirements for subsequent monitoring events maybe be modified by the Executive Officer.
4. The monitoring frequency for these parameters may be reduced or eliminated by the Executive Officer through the modification of this MRP if



Parameter	Units	Sample Type	Minimum Sampling Frequency
monitoring data demonstrates that concentrations of these constituents are consistently lower than water quality objectives for protecting groundwater.			

**C. Storage Tank Monitoring – Monitoring Locations TNK-001 and TNK-002**

The Discharger shall monitor all reclaimed water storage tanks at Monitoring Locations TNK-001 and TNK-002 as follows:

**Table G-4. Storage Tank Monitoring Requirements**

Parameter	Units	Sample Type	Minimum Sampling Frequency	Reporting Frequency
Freeboard	0.1 feet	Measurement	Weekly	Quarterly
Odors	---	Observation	Weekly	Quarterly

**IV. REPORTING REQUIREMENTS**

**A. Self-Monitoring Reports (SMRs)**

1. The Discharger shall submit quarterly SMRs including the results for all monitoring specified in this MRP. If the Discharger monitors any pollutant more frequently than required by this Order, the results of this monitoring shall be included in the calculations and reporting of the data submitted in the SMR. Nothing in this MRP prohibits additional monitoring or reporting.
2. Quarterly SMRs shall be submitted no later than the first day of the second calendar month, following the month of sampling. All monitoring results shall include complete laboratory data sheets for each analysis and be submitted in conjunction with the monthly SMR. Annual summary reports shall be submitted by March 1st each year.
3. Monitoring periods for all required monitoring shall be completed according to the following schedule:

**Table G-5. Monitoring Periods and Reporting Schedule**

<b>Sampling Frequency</b>	<b>Monitoring Period Begins On</b>	<b>Monitoring Period</b>	<b>SMR Due Date</b>
Continuous	Permit Effective Date	(Midnight through 11:59 PM) or any 24-hour period that reasonably represents a calendar day for purposes of sampling.	Submit with quarterly SMR
Daily	Permit Effective Date	(Midnight through 11:59 PM) or any 24-hour period that reasonably represents a calendar day for purposes of sampling.	Submit with quarterly SMR
Weekly	Sunday following permit effective date or on permit effective date if on a Sunday	Sunday through Saturday	Submit with quarterly SMR
Monthly	First day of calendar month following permit effective date or on permit effective date if that date is first day of the month	1 <sup>st</sup> day of calendar month through last day of calendar month	Submit with quarterly SMR
Quarterly	Closest of January 1, April 1, July 1, or October 1 following (or on) permit effective date	January 1 - March 31 April 1 - June 30 July 1 - September 30 October 1 - December 31	First day of second calendar month following the end of each quarter (February 1, May 1, August 1, November 1)
Annually	January 1 following (or on) permit effective date	January 1 through December 31	March 1, each year (with annual report)

- The Discharger shall report with each sample result the applicable ML, the RL and the current MDL, as determined by the procedure in Standard Methods.

5. The Discharger shall report the results of analytical determinations for the presence of chemical constituents in a sample using the following reporting protocols:
  - a. Sample results greater than or equal to the reported ML shall be reported as measured by the laboratory (i.e., the measured chemical concentration in the sample).
  - b. Sample results less than the RL, but greater than or equal to the laboratory's MDL, shall be reported as "Detected, but Not Quantified," or DNQ. The estimated chemical concentration of the sample shall also be reported.
  - c. For the purposes of data collection, the laboratory shall write the estimated chemical concentration next to DNQ as well as the words "Estimated Concentration" (may be shortened to "Est. Conc."). The laboratory may, if such information is available, include numerical estimates of the data quality for the reported result. Numerical estimates of data quality may be percent accuracy (+ a percentage of the reported value), numerical ranges (low to high), or any other means considered appropriate by the laboratory.
  - d. Sample results less than the laboratory's MDL shall be reported as "Not Detected," or ND.
  - e. The Discharger shall instruct laboratories to establish calibration standards so that the ML value (or its equivalent if there is differential treatment of samples relative to calibration standards) is the lowest calibration standard. At no time is the Discharger to use analytical data derived from extrapolation beyond the lowest point of the calibration curve.
6. The Discharger shall submit quarterly SMRs in accordance with the following requirements:
  - a. The Discharger shall arrange all reported data in a tabular format. The data shall be summarized to clearly illustrate whether the Facility is operating in compliance with effluent limitations and other WDR requirements.
  - b. The Discharger shall attach a cover letter to the SMR. The information contained in the cover letter shall clearly identify:
    - i. Facility name and address;

- ii. WDID number;
  - iii. Applicable period of monitoring and reporting;
  - iv. Violations of the WDRs (identified violations must include a description of the requirement that was violated and a description of the violation);
  - v. Corrective actions taken or planned; and
  - vi. The proposed time schedule for corrective actions.
- c. The Quarterly SMRs, Annual Report, and Source Control Activity Report shall be submitted to the Regional Water Board, signed and certified as required by the General Provisions, to: [NorthCoast@waterboards.ca.gov](mailto:NorthCoast@waterboards.ca.gov) or on disk (CD or DVD) in a Portable Document Format (PDF) file in lieu of paper-sourced documents. The guidelines for electronic submittal of documents can be found on the [Regional Water Board website](https://www.waterboards.ca.gov/northcoast/publications_and_forms/available_documents/pdf/2014/ECM_Letter-Guidelines.pdf). ([https://www.waterboards.ca.gov/northcoast/publications\\_and\\_forms/available\\_documents/pdf/2014/ECM\\_Letter-Guidelines.pdf](https://www.waterboards.ca.gov/northcoast/publications_and_forms/available_documents/pdf/2014/ECM_Letter-Guidelines.pdf))
- d. At any time during the term of this permit, the Regional Water Board may notify the Discharger to electronically submit both technical and Self-Monitoring Reports (SMRs) to the State Water Board's GeoTracker database in searchable Portable Document Format (pdf). In addition, analytical data will be required to be uploaded to the GeoTracker database under a site-specific global identification number that will be assigned to the Discharger. Information on the GeoTracker database is provided on the [State Water Board website](https://www.waterboards.ca.gov/resources/data_databases/groundwater.html). ([https://www.waterboards.ca.gov/resources/data\\_databases/groundwater.html](https://www.waterboards.ca.gov/resources/data_databases/groundwater.html))

## B. Other Reports

1. **Special Study Reports and Progress Reports.** As specified in this Order, special study and progress reports shall be submitted in accordance with the following reporting requirements.

**Table G-6. Reporting Requirements for non-SMR Reports Specified in the Order and MRP**

Order Section	Special Provision Requirement	Reporting Requirements
Water Reclamation Specifications Order Section V.A.3	Submit Irrigation Management Plan. Update and maintain Irrigation Management Plan.	<b>Within 18 months of adoption of this Order.</b> As necessary thereafter.
Provision VIII.D.2	Submit Updated O&M Manual	<b>By July 1, 2025</b> As necessary thereafter.
Provision VIII.E	Any material change in discharge	Promptly
Provision VIII.F	Any change in control or ownership	Promptly
Provision VIII.L	Non-compliance reporting	Verbal – as soon as aware of incident  Written – within 5 business days of telephone notification
Provision VIII.O	Adequate Capacity, Technical Report	Within 120 days of notification that the Facility will reach capacity within 4 years
Provision VIII.P	New Tanks	As necessary
MRP Reporting Requirement IV.C	Notification of spills and unauthorized discharges	Oral reporting as soon as possible after becoming aware of spill
MRP Reporting Requirement IV.D	Submit Disaster Preparedness Assessment Report and Action Plan	<b>By July 1, 2025</b>

2. **Annual Report.** The Discharger shall submit an annual report to the Regional Water Board for each calendar year. The report shall be submitted **by March 1 of the following year**. The report shall, at a minimum, include the following:
  - a. **Monitoring Data Summaries.** Both tabular and, where appropriate, graphical summaries of the monitoring data and disposal records from the previous year.
    - i. If the Discharger monitors any pollutant more frequently than required by this Order, the results of this monitoring shall be included in the calculation and report of the data submitted in the SMR.
    - ii. The Discharger shall include trucked waste (e.g., leachate) monitoring data in accordance with a trucked waste management program approved by the Executive Officer to demonstrate that accepted trucked wastes are appropriate for discharge to the Facility.
  - b. **Compliance Reporting.** A comprehensive discussion of the Facility's compliance (or lack thereof) with all effluent limitations and other WDRs, and the corrective actions taken or planned, which may be needed to bring the discharge into full compliance with the Order.
  - c. **Staffing and Emergency Contacts.**
    - i. The names and general responsibilities of all persons employed at the Facility.
    - ii. The names, telephone numbers, and email addresses of persons to contact regarding the Facility for emergency and routine situations.
  - d. **Instrumentation Calibration Reporting.** A statement certifying when the flow meter(s) and other monitoring instruments and devices were last calibrated, including identification of who performed the calibration.
  - e. **Reclaimed Water Report.** The Discharger shall submit a Reclaimed Water Report to the Regional Water Board for each calendar year. The report shall describe recycled water activities performed by the Discharger during the calendar year to demonstrate compliance with Order, including:
    - i. A compliance summary and discussion of the compliance record for the prior calendar year including a comparison of total volumes to ensure compliance with the prohibitions in Order section III.G and III.H;

- ii. In the event of noncompliance, the report shall also discuss the corrective actions taken and planned to bring the reclaimed water program into full compliance with this Order;
  - iii. Certification that all reasonable BMPs and management practices were implemented to ensure efficient and compliant operation of the reclaimed water system;
  - iv. Identification of any other problems that occurred in the reclaimed water system during the prior year, including repeated occurrences of incidental runoff of which the Discharger is aware, and plans to rectify those problems in the coming year.
  - v. A description of hydraulic and agronomic rate compliance, to ensure compliance with Order sections V.A and V.B;
  - vi. A summary of major repairs scheduled or completed that affected the reclaimed water system appurtenances and irrigation areas;
  - vii. Monitoring activities that occurred during the previous year and identification of any problems and how the problems were addressed; and
  - viii. A summary of all cross-connection testing and back-flow prevention activities (inspections, maintenance) and a summary of any problems identified, or certification that no problems occurred to ensure compliance with Order section V.C.
- f. **Annual Volumetric Reporting.** The Discharger shall electronically certify and submit an annual volumetric report, containing monthly data in electronic format, to State Water Board's GeoTracker system by April 30 of each year. Required data shall be submitted to the GeoTracker database under a site-specific global identification number. The Discharger shall report in accordance with each of the items in Section 3 of the Recycled Water Policy as described below:
- i. **Influent.** Monthly volume of wastewater collected and treated by the Facility.
  - ii. **Production.** Monthly volume of water treated, specifying level of treatment.
  - iii. **Discharge.** Monthly volume of treated wastewater discharged to each of the following, specifying level of treatment:

- (a) Inland surface waters, specifying volume required to maintain minimum instream flow, if any; and
- (b) Land, where beneficial use is not taking place, including evaporation or percolation ponds, overland flow, or spray irrigation disposal, excluding pasture or fields with harvested crops.

iv. **Reuse.**

- (a) Monthly Volume of treated wastewater distributed.
- (b) Annual volume of treated wastewater distributed for beneficial use in compliance with California Code of Regulations, title 22 in each of the use categories listed below:
  - (i) Agricultural irrigation: pasture or crop irrigation.
  - (ii) Landscape irrigation: irrigation of parks, greenbelts, and playgrounds; school yards; athletic fields; cemeteries; residential landscaping, common areas; commercial landscaping; industrial landscaping; and freeway, highway, and street landscaping.
- (c) Golf course irrigation: irrigation of golf courses, including water used to maintain aesthetic impoundments within golf courses.
- (d) Commercial application: commercial facilities, business use (such as laundries and office buildings), car washes, retail nurseries, and appurtenant landscaping that is not separately metered.
- (e) Industrial application: manufacturing facilities, cooling towers, process water, and appurtenant landscaping that is not separately metered.
- (f) Geothermal energy production: augmentation of geothermal fields.
- (g) Other non-potable uses: including but not limited to dust control, flushing sewers, fire protection, fill stations, snow making, and recreational impoundments.



- g. **Solids Handling and Disposal Activity Reporting.** The Discharger shall submit a description of the solids handling, disposal, and reuse activities during the calendar year to demonstrate compliance with Order section VI, Solids Disposal and Handling Requirements. At a minimum, the report should include:
- i. A schematic showing solids handling facilities (e.g., screens, drying beds, storage, land application areas, etc.), if any, and solids flow diagram;
  - ii. The quantity of solids generated and disposed during the year, in dry metric tons and percent solids, and the amount used or disposed by each use site and/or disposal practice;
  - iii. Results of all monitoring conducted to demonstrate compliance with Order section VI. All results must be reported on a 100% dry weight basis. Locations of sample collection shall be reported on a map of the land application area.
  - iv. Documentation of those operational parameters used to demonstrate compliance with vector attraction reduction and certifications.
  - v. For land application sites (unless submitted separately by land application contractor):
    - (a) Name of each field; location, ownership, size in acres;
    - (b) Actual dates of applications, seedings, harvesting;
    - (c) Number of truckloads to each field;
    - (d) Actual tonnage applied to field, in actual and dry weight; and
    - (e) Calculated agronomic rate.
  - vi. Identification of any violations and corrective actions taken or planned to bring the discharge into compliance with WDRs.

### C. Spill Notification

1. **Spills and Unauthorized Discharges.** Information regarding all spills and unauthorized discharges that may endanger health or the environment shall

be provided verbally to the Regional Water Board <sup>9</sup> within 24 hours from the time the Discharger becomes aware of the circumstances and a written report shall also be provided within five (5) days of the time the Discharger becomes aware of the circumstances of the spill or unauthorized discharge.

Information to be provided verbally to the Regional Water Board includes:

- a. Name and contact information of caller;
- b. Date, time and location of spill occurrence;
- c. Estimates of spill volume, rate of flow, and spill duration, if available and reasonably accurate;
- d. Surface water bodies impacted, if any;
- e. Cause of spill, if known at the time of the notification;
- f. Cleanup actions taken or repairs made at the time of the notification;
- g. Actions taken to prevent the spill or unauthorized discharge from reoccurring; and
- h. Responding agencies.

#### **D. Disaster Preparedness Assessment Report and Action Plan**

Natural disasters, extreme weather events, sea level rise, and shifting precipitation patterns, some of which are projected to intensify due to climate change, have significant implications for wastewater treatment and operations. Some natural disasters are expected to become more frequent and extreme according to the current science on climate change. In order to ensure that Facility operations are not disrupted, compliance with conditions of this Order are achieved, and receiving waters are not adversely impacted by permitted and

---

<sup>9</sup> The contact number of the Regional Water Board during normal business hours is (707) 576-2220. After normal business hours, spill reporting to the California Governor's Office of Emergency Services Warning Center (CalOES) will satisfy the 24 hour spill reporting requirement for the Regional Water Board. The contact number for spill reporting for the CalEMA is (800) 852-7550.

unpermitted discharges, the Discharger shall submit a Disaster Preparedness Assessment Report and Action Plan to the Regional Water Board by **July 1, 2025**, for Executive Officer review and approval.

The Discharger shall: (1) conduct an assessment of the wastewater treatment facility, operations, collection, and discharge systems to determine areas of short and long-term vulnerabilities related to natural disasters and extreme weather, and other conditions projected by climate change science, if applicable; the assessment shall consider, as applicable, impacts to plant operations due to changing influent and receiving water quality, rising sea level, storm surges, fires, floods, earthquakes, tsunamis, back-to-back severe storms, and other extreme conditions that pose a risk to plant operations and water quality; (2) identify control measures needed to protect, improve, and maintain wastewater infrastructure, waste discharge compliance, and receiving water quality in the event of a natural disaster or, if applicable, under conditions resulting from climate change; (3) develop a schedule to implement necessary control measures. Control measures shall include, but are not limited to, emergency procedures, contingency plans, alarm/notification systems, training, backup power and equipment, and the need for planned mitigations to ameliorate potential risks associated with extreme weather events and changing conditions resulting from climate change; and (4) implement the necessary control measures per the approved schedule of implementation.