

Alamitos Bay/Los Cerritos Channel

Watershed Management Program

Submitted to:

**California Regional Water
Quality Control Board
Los Angeles Region
320 West 4th Street, Suite 200
Los Angeles, CA 90013-2343**

Submitted by:

**Los Angeles County
Flood Control District
900 S. Fremont Avenue
Alhambra, CA 91803-1331**

**County of Los Angeles
Department of Public Works
900 S. Fremont Avenue
Alhambra, CA 91803-1331**



Revised January 27, 2015

[This page intentionally left blank]

Table of Contents

SECTION 1. INTRODUCTION.....	1
1.1 BACKGROUND.....	1
1.2 AB/LCC WATERSHED MANAGEMENT AREA.....	2
1.3 COUNTY ISLAND	4
1.4 WMP GEOGRAPHIC SCOPE.....	4
SECTION 2. EXISTING TMDLS APPLICABLE TO COUNTY ISLAND.....	5
2.1 LOS CERRITOS CHANNEL METALS TMDL	5
2.2 DOMINGUEZ CHANNEL TOXICS TMDL	5
2.3 BENEFICIAL USES.....	6
2.4 INTERIM AND FINAL TMDL DEADLINES.....	6
SECTION 3. WATER QUALITY PRIORITIES	8
3.1 OBJECTIVE	8
3.2 STEARNS STREET MASS EMISSION SITE	10
3.3 CATEGORY 1 (HIGHEST PRIORITY).....	11
3.4 CATEGORY 2 (HIGH PRIORITY).....	11
3.5 CATEGORY 3 (MEDIUM PRIORITY)	11
3.6 LOW PRIORITY POLLUTANTS.....	12
3.7 SUMMARY	13
SECTION 4. SOURCE ASSESSMENT	14
4.1 OBJECTIVE	14
4.2 CATEGORY 1 (HIGHEST PRIORITY).....	14
4.3 CATEGORY 2 (HIGH PRIORITY).....	14
4.4 CATEGORY 3 (MEDIUM PRIORITY)	15
SECTION 5. WATERSHED CONTROL MEASURES	16
5.1 OBJECTIVE	16
5.2 CONTROL MEASURES.....	16
5.3 MINIMUM CONTROL MEASURES	16
5.3.1 MCM Requirements for the LACFCD	16
5.3.2 MCM Requirements for the County of Los Angeles	17
SECTION 6. REASONABLE ASSURANCE ANALYSIS.....	18
6.1 OBJECTIVE	18

6.2	NON-STORMWATER APPROACH	18
6.3	STORMWATER QUALITY MODEL/APPROACH	19
6.3.1	Land Area Identification	20
6.3.2	WMMS Analysis.....	21
6.3.3	Critical Storm	22
6.3.4	Critical Condition Daily Pollutant Load.....	23
6.3.5	Identification of Potential Non-Structural and Structural BMPs	25
6.3.6	Schedule to Meet Needed Percent Reductions.....	33
	SECTION 7. STAKEHOLDER INPUT.....	37
	SECTION 8. ADAPTIVE MANAGEMENT PROCESS	38
8.1	OBJECTIVE	38
	SECTION 9. REPORTING.....	39
9.1	ANNUAL MONITORING REPORT	39
	SECTION 10. REFERENCES	40

List of Tables

Table 1: Beneficial Uses in AB/LCC Watershed Management Area	6
Table 2: Category 2: High Priority Pollutants- Freshwater Portion of Los Cerritos Channel.....	11
Table 3: Category 3: Medium Priority Pollutants - Freshwater Portion of Los Cerritos Channel.....	12
Table 4: Water Quality Priorities for the Freshwater Portion of the Los Cerritos Channel	13
Table 5: HRU Breakdown for County Island.....	21
Table 6: Wet-Weather Stormwater Allocations per LCC Metals TMDL	23
Table 7: Critical Condition and Allowable Daily Load Calculation.....	23
Table 8: Analysis Based on WMMS Results	25
Table 9: LCC Metals TMDL, Stormwater Volumes to be Mitigated	34

List of Figures

Figure 1: The Alamitos Bay/LCC Watershed Management Area.....	3
Figure 2: Unincorporated County Island.....	4
Figure 3: LCC Metals TMDL, DC Toxics TMDL Deadlines and Notable Permit Dates ...	7
Figure 4: Los Cerritos Channel Watershed Group (LCCWG).....	9
Figure 5: Stearns Street MES Location.....	10
Figure 6: Catch Basins, Flow Direction and Outfalls in County Island.....	19
Figure 7: County Island, WMMS Sub Basin 5505 and Neighboring Sub Basins.....	20
Figure 8: Unincorporated County Island HRU Map.....	21
Figure 9: Daily Flows Originating from County Island.....	22
Figure 10: County Island Storms Ordered by Storm Volume.....	22
Figure 11: County’s Low Impact Development Manual.....	26
Figure 12: Typical Biofiltration System.....	31
Figure 13: Potential Biofiltration System Location.....	31
Figure 14: Drainage Filtration Catch Basin Typical Section.....	32
Figure 15: Potential Drainage Filtration Catch Basin Locations.....	32
Figure 16: Potential Right of Way Project along Palo Verde Drain.....	33
Figure 17: Zinc % Pollutant Reduction vs. Percent Flow Reduction from SUSTAIN.....	34
Figure 18: Needed Stormwater Mitigation Volumes.....	35
Figure 19: County’s Compliance Approach.....	36
Figure 20: Stakeholder Outreach Notification.....	37

List of Abbreviations

AB/LCC	Alamitos Bay/Los Cerritos Channel
ARS	Automatic Retractable Screen
BPA	Basin Plan Amendment
BMP	Best Management Practice
CIMP	Coordinated Integrated Monitoring Program
CPS	Connector Pipe Screen
DEHP	Bis(2-ethylhexyl) phthalate
EPA	Environmental Protection Agency
EWMP	Enhanced Watershed Management Program
GIS	Geographic Information System
HRU	Hydrologic Response Unit
IC/ID	Illicit Connections and Illicit Discharges
LACFCD	Los Angeles County Flood Control District
LARWCQB	Los Angeles Regional Water Quality Control Board
LID	Low Impact Development
LCCWG	Los Cerritos Channel Watershed Group
MBAS	Methylene Blue Active Substances
MCM	Minimum Control Measure
MDL	Minimum Detection Limit
MES	Mass Emissions Station
MS4	Municipal Separate Storm Sewer System
MRP	Monitoring and Reporting Program
NPDES	National Pollutant Discharge Elimination System
PCBs	Polychlorinated Biphenyls
PIPP	Public Information and Participation Program
QA/QC	Quality Assurance/Quality Control
RAA	Reasonable Assurance Analysis
TMDL	Total Maximum Daily Load
USEPA	United State Environmental Protection Agency
WLA	Waste Load Allocation
WMMS	Watershed Management Modeling System
WMP	Watershed Management Program
WQDS	Water Quality Design Storm

[This page intentionally left blank]

Section 1. Introduction

1.1 BACKGROUND

The Alamos Bay/Los Cerritos Channel (AB/LCC) Watershed Management Program (WMP) is a collaborative effort between the County of Los Angeles (County) and the Los Angeles County Flood Control District (LACFCD). The geographic scope of the this WMP includes a 95-acre County Island, the LACFCD infrastructure within that island, and the LACFCD infrastructure within the Los Cerritos Channel estuary and Alamos Bay watersheds. The geographic area of this WMP is shown in Figure 1. It is important to note that the 95-acre County Island is located within the separate Los Cerritos Channel Freshwater Watershed.

This WMP is being submitted to meet the requirements outlined in section VI.C of the National Pollutant Discharge Elimination System (NPDES) Municipal Separate Storm Sewer System (MS4) Permit No. R4-2012-0178 (Permit). The Permit was adopted on November 8, 2012 and became effective December 28, 2012.

Section VI.C.1.f of the Permit requires that the WMP shall:

- Be consistent with Part VI.C.5-C.8 of the Permit (see below),
- Prioritize water quality issues resulting from storm water and non-storm water discharges from the MS4 to receiving waters within each Watershed Management Area (WMA),
- Identify and implement strategies, control measures, and BMPs to achieve the outcomes specified in Part VI.C.1.d of the Permit,
- Execute an integrated monitoring program and assessment program pursuant to Attachment E, Part IV of the Permit to determine progress towards achieving applicable limitations and/or action levels in Attachment G of the Permit (See Coordinated Integrated Monitoring Program (CIMP) for the AB/LCC Group),
- Modify strategies, control measures, and Best Management Practices (BMPs) as necessary based on analysis of monitoring data collected pursuant to the Monitoring and Reporting Plan to ensure that applicable water quality-based effluent limitations and receiving water limitations and other milestones set forth in the WMP are achieved in the required timeframes,
- Provide appropriate opportunity for meaningful stakeholder input, including but not limited to, a permit-wide WMP technical advisory committee (TAC) that will advise and participate in the development of the WMPs and enhanced WMPs from month 6 through the date of program approval.

Part VI.C.5-C.8 of the Permit requires the WMP contain:

- Identification of Water Quality Priorities
- Selection of Watershed Control Measures including:
 - Minimum control measures
 - Non-storm water discharge measures
 - TMDL Control measures
 - Identification of specific structural and non-structural BMPs
 - Reasonable assurance analysis
 - Compliance schedules

- Integrated watershed monitoring and assessment (See CIMP for the AB/LCC Group)
- Adaptive management process

1.2 AB/LCC WATERSHED MANAGEMENT AREA

The AB/LCC Watershed Management Area is located in southern Los Angeles County and has a drainage area of approximately 37.5 square miles. The AB/LCC Watershed Management Area encompasses the Los Cerritos Channel freshwater watershed (which includes all or portions of the Cities of Bellflower, Cerritos, Downey, Lakewood, Long Beach, Paramount and Signal Hill, and a 95-acre County Island), the Los Cerritos Channel estuary watershed (located in Long Beach) and the Alamitos Bay watershed (located in Long Beach).

This AB/LCC WMP only includes the 95 acre County Island, the LACFCD infrastructure within that island, and the LACFCD infrastructure within the Los Cerritos Channel estuary watershed, and the Alamitos Bay watershed. The geographic area of the AB/LCC WMP is shown in Figure 1. It is important to note that the AB/LCC WMP has very limited jurisdiction in the overall Watershed Management Area since the County only has land use jurisdiction over the 95 acre County Island, and the LACFCD does not own or operate any municipal sanitary sewer systems, public streets, roads, or highways – the LACFCD only operates and maintains storm drains and other appurtenant drainage infrastructure. A detailed description of the LACFCD can be found in Attachment A.

In the Alamitos Bay and Los Cerritos Channel Estuary watersheds these areas are under the jurisdiction of the City of Long Beach and will be addressed under Long Beach's WMP which will be submitted in March 2015. Through adaptive management, the LACFCD will review Long Beach's WMP and consider on a case-by-case basis opportunities for collaboration on future projects.

A detailed description of the Los Cerritos Channel freshwater watershed, the Los Cerritos Channel estuary watershed, and the Alamitos Bay watershed can be found in the AB/LCC Group's CIMP.

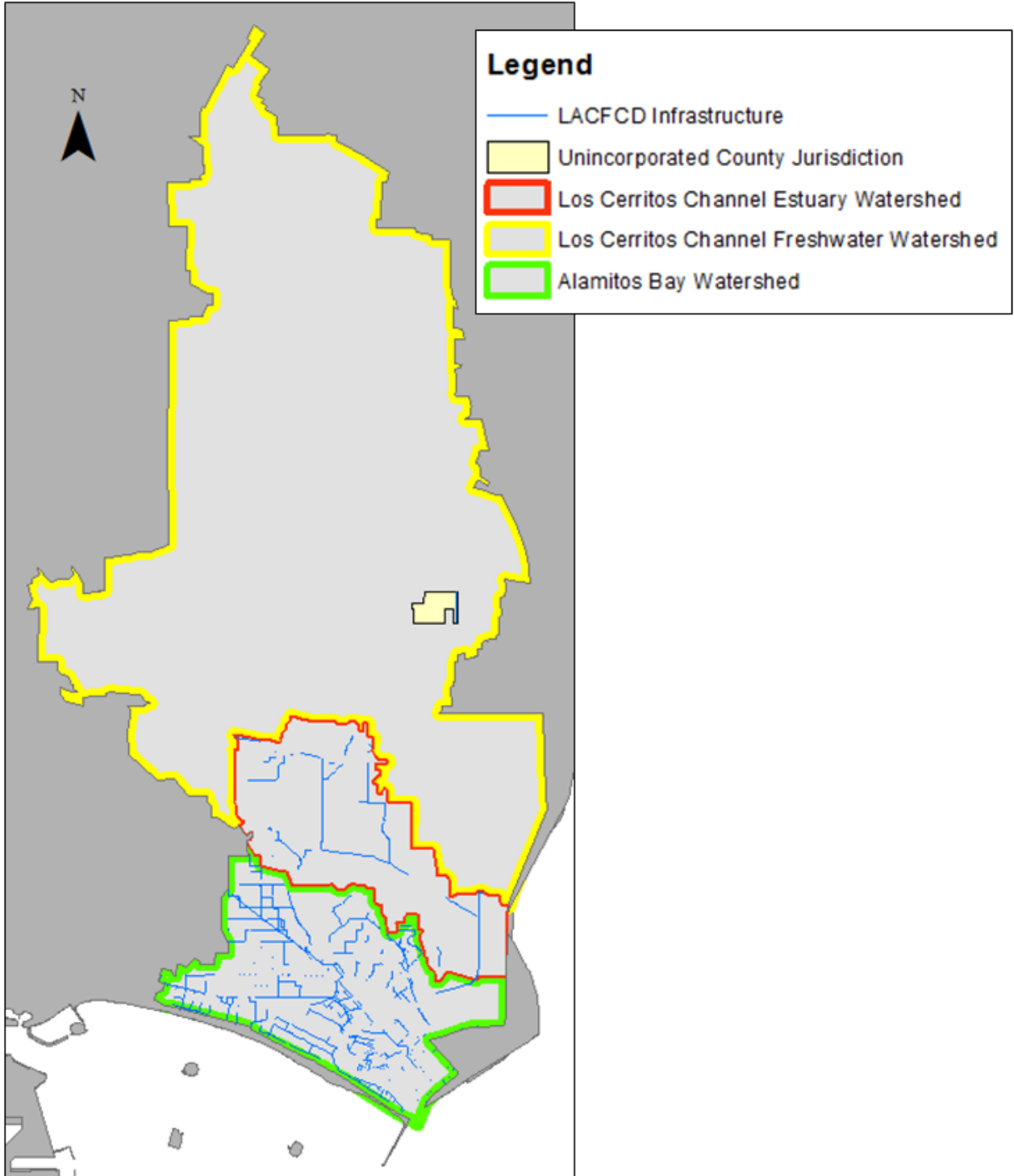

Figure 1: The Alamos Bay/LCC Watershed Management Area (The Unincorporated County Island Is Located Within the Separate Los Cerritos Channel Freshwater Watershed)

1.3 COUNTY ISLAND

Within the AB/LCC Watershed Management Area, the County Island is known as the “North Long Beach Island”. The County Island is landlocked within the City of Long Beach (Figure 2). The County Island is 95 acres (0.15 square miles) and is predominantly Single Family Residential Land Use.



Figure 2: Unincorporated County Island

Within the County Island, is the LACFCD maintained Palo Verde Drain. The Palo Verde Drain is an open channel, rectangular storm drain which discharges into the Los Cerritos Channel.

1.4 WMP GEOGRAPHIC SCOPE

This WMP is focused on areas in which the County has land use jurisdiction. The LACFCD does not have jurisdiction over the land uses which its storm drains and other appurtenant drainage infrastructure serve. Those areas will be addressed through other WMPs.

Section 2. Existing TMDLs Applicable to County Island

Within the AB/LCC Watershed Management Area, there are 2 existing TMDLs which apply to the County Island.

2.1 LOS CERRITOS CHANNEL METALS TMDL

The Total Maximum Daily Load for Metals in Los Cerritos Channel (LCC Metals TMDL) was approved by the United States Environmental Protection Agency (USEPA) on March 17, 2010. The Metals TMDL was developed to address beneficial use impairments due to Copper, Zinc and Lead in the freshwater portion of the Los Cerritos Channel. The freshwater portion of Los Cerritos Channel has the existing beneficial use of Wildlife Habitat (WILD), the potential beneficial uses of Municipal and Domestic Supply (MUN), Water Contact Recreation (REC1) and the intermittent beneficial uses of Warm Freshwater Habitat (WARM), and Non-contact Water Recreation (REC2).

On June 6, 2013, the Los Angeles Regional Water Quality Control Board (LARWQCB) adopted a resolution which includes an Implementation Schedule for the LCC Metals TMDL. The Implementation Schedule states that MS4 permittees

“shall provide a written report to the Regional Los Angeles Water Board outlining how they will achieve compliance with the WLAs. The report shall include implementation methods, an implementation schedule, proposed milestones, and any revisions to the TMDL monitoring plan. An Enhanced Watershed Management Program or Watershed Management Program, including the Reasonable Assurance Analysis, submitted in fulfillment of requirements in Order No. R4-2012-0175 may be used by permittees subject to that Order to satisfy the TMDL implementation plan requirements.”

This WMP is being submitted to satisfy the Implementation Plan requirements of the LCC Metals TMDL.

2.2 DOMINGUEZ CHANNEL TOXICS TMDL

The Total Maximum Daily Load for Toxic Pollutants in Dominguez Channel and Greater Los Angeles and Long Beach Harbor Waters (DC Toxics TMDL) was adopted by the LARWQCB on May 5, 2011. The DC Toxics TMDL became effective on March 23, 2012. The goal of the TMDL is to protect and restore fish tissue, water and sediment quality in Dominguez Channel and Greater Los Angeles and Long Beach Harbor (Greater Harbors) waters by remediating contaminated sediment and controlling the sediment loading and accumulation of contaminated sediment in the Greater Harbors.

The County and the LACFCD are both listed as responsible parties for the Greater Harbors waterbody. An Implementation Plan is not required for parties tributary to the Greater Harbors; however, this WMP will help improve the quality of water discharged to the Greater Harbors.

As recognized by the footnote in Attachment K-7 of the Permit, the County and the LACFCD have entered into an Amended Consent Decree with the United States and the State of California, including the LARWQCB, pursuant to which the LARWQCB has released the County and the LACFCD from responsibility for Toxic pollutants in the Dominguez Channel and the Greater

Harbors. Accordingly, no inference should be drawn from the submission of this WMP or from any action or implementation taken pursuant to it that the County or the LACFCD is obligated to implement the DC Toxics TMDL, including this WMP or any of the DC Toxics TMDL's other obligations or plans, or that the County or the LACFCD have waived any rights under the Amended Consent Decree.

2.3 BENEFICIAL USES

The County Island is tributary to the freshwater portion of the Los Cerritos Channel, which has beneficial uses identified in Table 1.

Table 1: Beneficial Uses in AB/LCC Watershed Management Area

Water Body	Beneficial Uses	
Los Cerritos Channel Freshwater Portion	Existing	Wildlife Habitat (WILD)
	Potential	Municipal and Domestic Supply (MUN) Water Contact Recreation (REC1)
	Intermittent	Warm Freshwater Habitat (WARM) Non-contact Water Recreation (REC2)

2.4 INTERIM AND FINAL TMDL DEADLINES

Figure 3 shows the interim and final deadlines for the TMDLs applicable to the County Island along with notable deadlines related to the Permit.

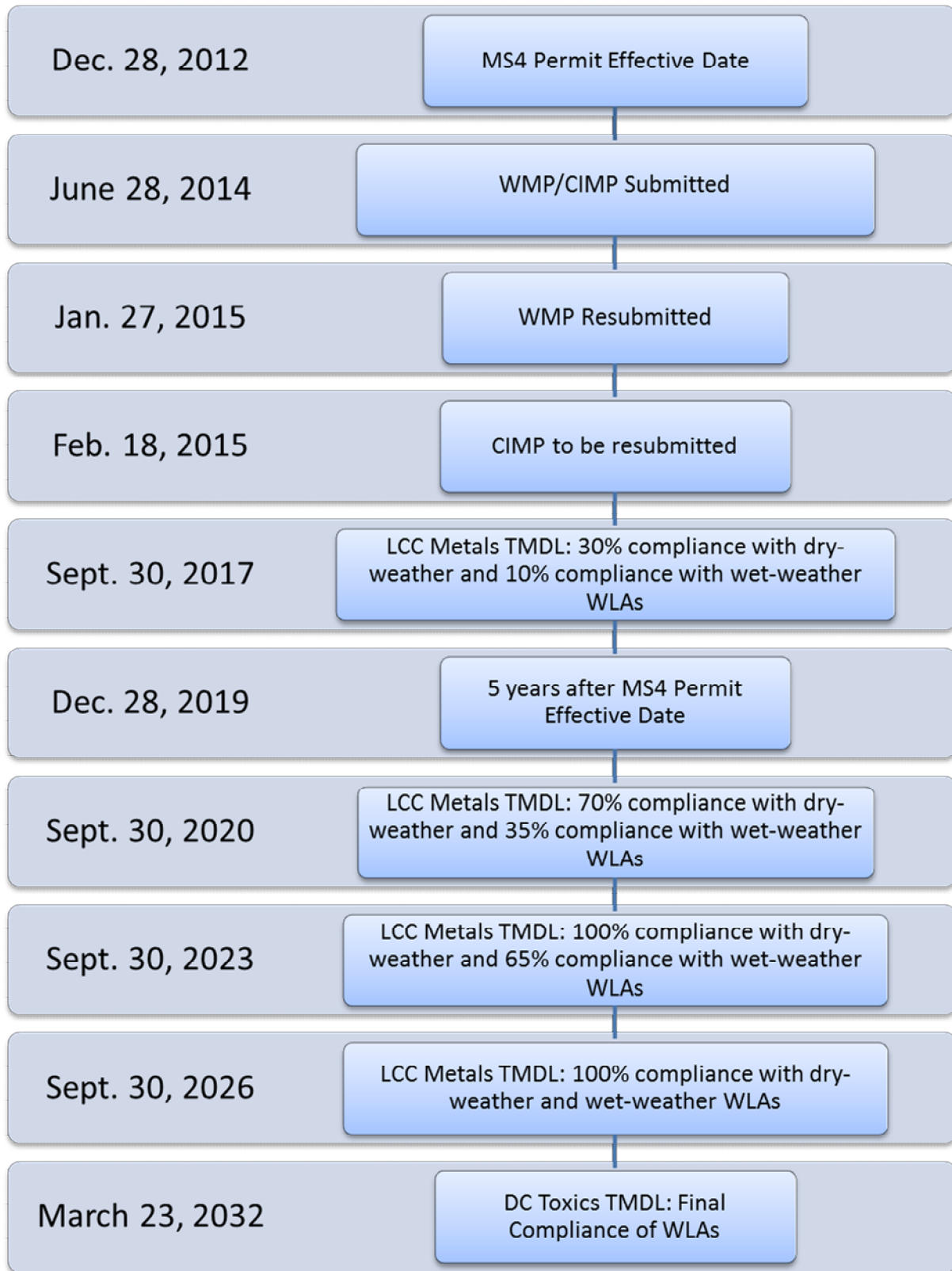

Figure 3: LCC Metals TMDL, DC Toxics TMDL Deadlines and Notable Permit Dates

Section 3. Water Quality Priorities

3.1 OBJECTIVE

Per Section VI.C.5 of the Permit, three categories of pollutants are identified to aid in the evaluation of existing water quality conditions. These classifications consist of:

- Category 1 (Highest Priority): Water body-pollutant combinations for which water quality-based effluent limitations and/or receiving water limitations are established in Part VI.E and Attachments L through R of this Order.
- Category 2 (High Priority): Pollutants for which data indicate water quality impairment in the receiving water according to the State's Water Quality Control Policy for Developing California's Clean Water Act Section 303(d) List (State Listing Policy) and for which MS4 discharges may be causing or contributing to the impairment.
- Category 3 (Medium Priority): Pollutants for which there are insufficient data to indicate water quality impairment in the receiving water according to the State's Listing Policy, but which exceed applicable receiving water limitations contained in this Order and for which MS4 discharges may be causing or contributing to the exceedance

This WMP Group is coordinating portions of its monitoring efforts, where feasible with the Los Cerritos Channel Watershed Group (LCCWG). This includes receiving and stormwater outfall monitoring efforts for the freshwater portion of the Los Cerritos Channel. The LCCWG consists of the cities of Bellflower, Cerritos, Downey, Lakewood, Long Beach, Paramount and Signal Hill. Additionally, the LCCWG contains the LACFCD's infrastructure within these cities' jurisdiction. See Figure 4 for the geographical boundaries of the LCCWG.

The LACFCD does not have jurisdiction of the land uses that create the pollutants of concern in the Alamitos Bay, Colorado Lagoon and Los Cerritos Channel Estuary watersheds. These areas are under the jurisdiction of the City of Long Beach and will be addressed under Long Beach's WMP which will be submitted in March 2015. Accordingly, Water Quality Priorities for the Alamitos Bay, Colorado Lagoon and Los Cerritos Channel Estuary will be addressed in Long Beach's WMP. Through adaptive management, the LACFCD will review Long Beach's WMP and consider on a case-by-case basis opportunities for collaboration on future projects.

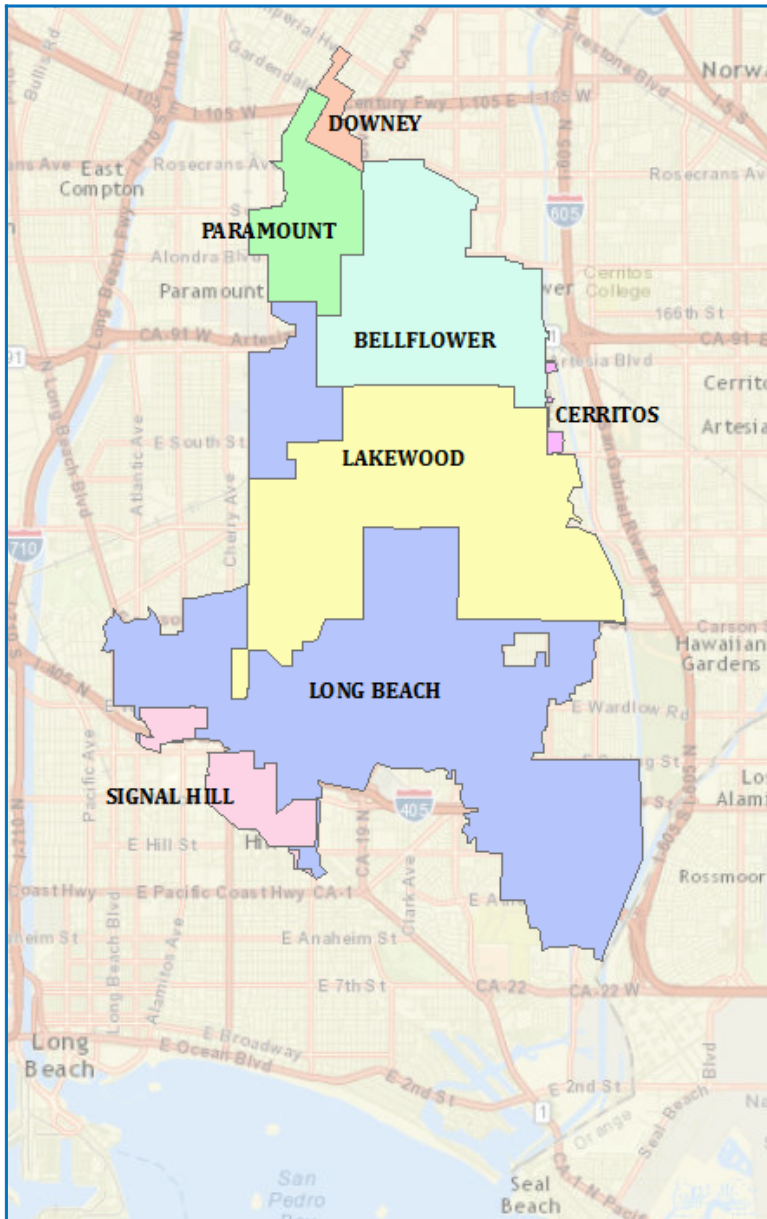

Figure 4: Los Cerritos Channel Watershed Group (LCCWG)

For consistency with the LCCWG, this WMP Group has also identified Low Priority Pollutants. These pollutants fall below the requirements of Category 3, however, there has been at least one exceedance of these pollutants within the past 10 years. Consistent with the requirements of the Permit; existing TMDLs and the 303(d) list were used to determine Category 1 and 2 pollutants. Historic monitoring data collected from the Stearns Street Mass Emission Station (Stearns Street MES) was used to determine Category 3 and low priority pollutants. Table 2 lists the high priority pollutants of concern for the freshwater portion of the Los Cerritos Channel.

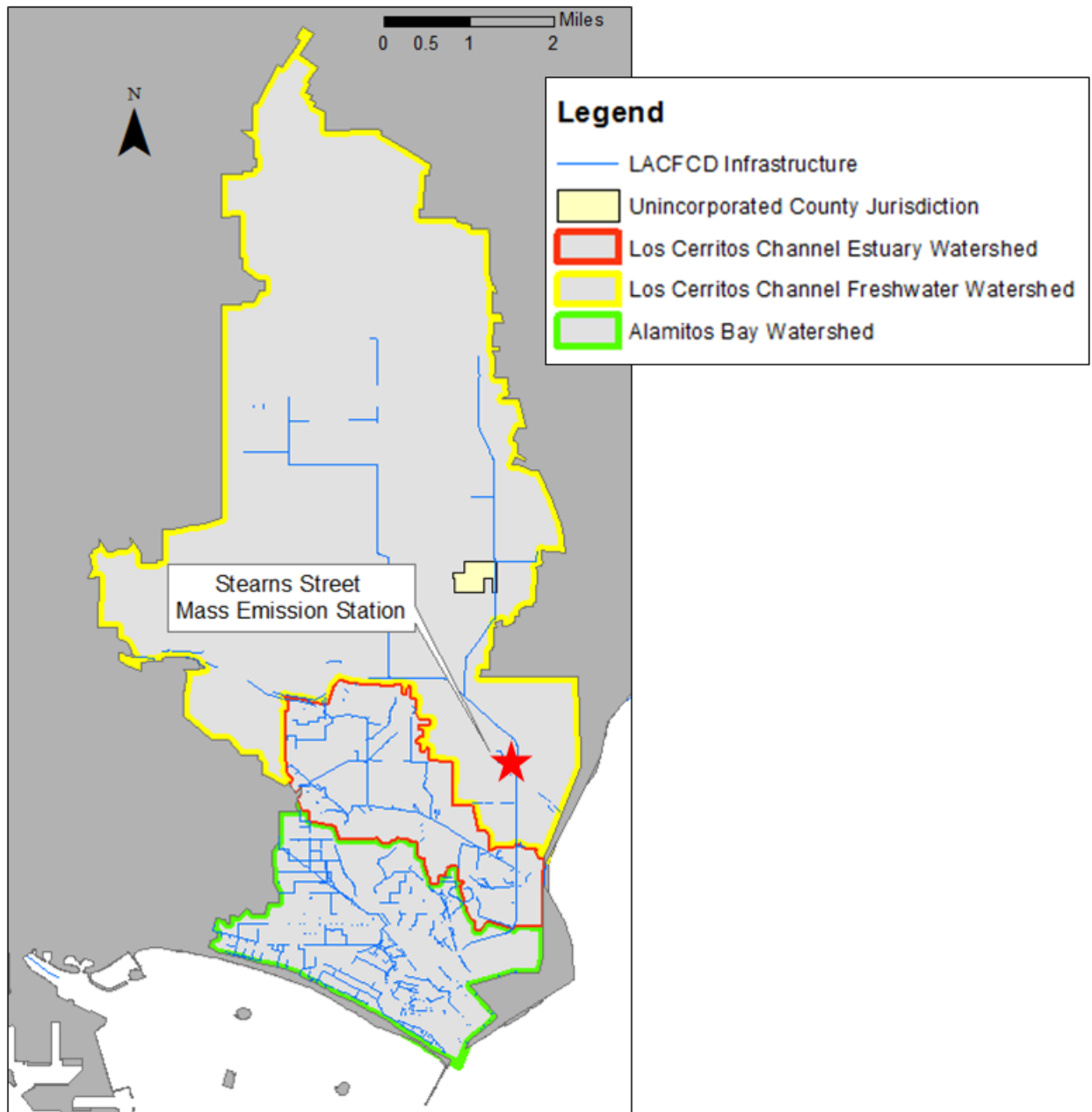

Figure 5: Stearns Street MES Location

3.2 STEARNS STREET MASS EMISSION SITE

This WMP Group has completed a detailed review of monitoring data from the Stearns Street MES. The City of Long Beach has maintained this mass emission station since 2000. Upon implementation of the LCCWG and the AB/LCC Group’s CIMPs, the City of Long Beach will coordinate with other agencies for the operation and maintenance of the Stearns Street MES. Figure 5 shows the location of the Stearns Street MES within the Los Cerritos Channel Watershed. The County Island’s discharge is comingled with other Permittees’ discharge at this location. Appendix B provides a summary of data from the past 10 years.

3.3 CATEGORY 1 (HIGHEST PRIORITY)

For the County Island, the highest priority pollutants are identified in the Los Cerritos Channel Total Maximum Daily Loads for Metals (LCC Metals TMDL) and the Total Maximum Daily Load for Toxic Pollutants in Dominguez Channel and Greater Los Angeles and Long Beach Harbor Waters (DC Toxics TMDL). A complete list of Category 1 pollutants can be found in Table 4.

3.4 CATEGORY 2 (HIGH PRIORITY)

The high priority pollutants are those identified on the 303(d) list for Los Cerritos Channel. Note that the Unincorporated County Island is tributary to the Freshwater Portion of the Los Cerritos Channel via the Palo Verde Drain. Category 2 pollutants are identified in Table 2. Copper, Lead and Zinc have been promulgated and are categorized as Category 1 pollutants per their listing in the LCC Metals TMDL. Additionally, Chlordane is 303(d) listed for the Los Cerritos Channel; however, it is included as a Category 1 pollutant per its listing in the DC Toxics TMDL.

Table 2: Category 2: High Priority Pollutants- Freshwater Portion of Los Cerritos Channel

Water Body	Category 2 (High Priority)	Receiving Water Limitations
Freshwater Portion of Los Cerritos Channel	Ammonia	0.1 mg/L
	Bis(2-ethylhexyl) phthalate (DEHP)	5.9 mg/L
	Coliform Bacteria	235 MPN/100ml
	Trash	N/A
	pH	6.5-8.5

3.5 CATEGORY 3 (MEDIUM PRIORITY)

A thorough analysis was conducted on data collected at the Stearns Street MES from 2003 to 2013. The Permit defines Category 3 pollutants as those

“for which there are insufficient data to indicate water quality impairment in the receiving water according to the State’s Listing Policy, but which exceed applicable receiving water limitations contained in this Order and for which MS4 discharges may be causing or contributing to the exceedance.”

The pollutants that meet the criteria for Category 3 are methylene blue active substances (MBAS) and enterococcus. Enterococcus is considered a concern for marine environments. The Stearns Street MES is located in the freshwater portion of the Los Cerritos Channel, however, this section of channel discharges to a marine environment. Thus enterococcus was included and compared to saltwater standards. A detailed summary of data from the Stearns Street MES is found in Appendix B

Review of the monitoring data for Aluminum at the Stearns Street MES between 2003 and 2013 shows samples exceeded minimum levels. The native soil in this region has naturally high Aluminum levels, therefore it is expected that an elevated level of Aluminum is found in stormwater samples. Additionally, the minimum level for Aluminum is established for drinking water criteria and is not appropriate for comparison to stormwater samples. As noted in Table 2-1 of the “Water Quality Control Plan Los Angeles Region – Basin Plan for the Coastal Watersheds of Los Angeles and Ventura Counties” the Municipal and Domestic Supply

Beneficial Use designation for the Los Cerritos Channel may be considered for exemption at a later date. Due to these concerns, Aluminum is excluded from Category 3 pollutants.

Table 3: Category 3: Medium Priority Pollutants - Freshwater Portion of Los Cerritos Channel

Water Body	Category 3 (Medium Priority)	Receiving Water Limitations
Freshwater Portion of Los Cerritos Channel	MBAS	0.5 mg/L
	Enterococcus*	104 MPN/100 ml

*Enterococcus uses a saltwater standard. This is included as the freshwater portion of Los Cerritos Channel discharges to an estuary.

3.6 LOW PRIORITY POLLUTANTS

Low Priority pollutants of concern for the freshwater portion of the Los Cerritos Channel are identified as those that fall below the requirements of Category 3, however there has been at least one exceedance of these pollutants within the past 10 years. In review of the data from the Stearns Street MES, Cadmium, Chlorpyrifos, Chromium and Dissolved Silver meet this criteria for wet weather and Diazinon meets this criteria for wet and dry weather.

3.7 SUMMARY

In summary, Table 4 lists all pollutant categories applicable to the County Island.

Table 4: Water Quality Priorities for the Freshwater Portion of the Los Cerritos Channel

Waterbody	Category 1 (Highest Priority)		Category 2 (High Priority) Pollutants	Category 3 (Medium Priority) Pollutants	Low Priority Pollutants
	Pollutant	TMDL			
Freshwater Portion of Los Cerritos Channel	Copper (wet and dry)	LCC Metals	Ammonia	MBAS	Cadmium (wet)
	Lead	LCC Metals/DC Toxics	Bis(2-ethylhexyl) phthalate (DEHP)	Enterococcus	Chlorpyrifos (wet)
	Zinc	LCC Metals/DC Toxics	Coliform Bacteria		Chromium (wet)
	DDT (fish tissue)	DC Toxics	Trash		Diazinon (wet and dry)
	PCBs (fish tissue)	DC Toxics	pH		Dissolved Silver (wet)
	Chlordane	DC Toxics			
	PAHs (sediment)	DC Toxics			
	Toxicity (sediment)	DC Toxics			

Section 4. Source Assessment

4.1 OBJECTIVE

Per Section VI.C.5.a.iii of the Permit, this section identifies potential sources of Category 1-3 pollutants.

4.2 CATEGORY 1 (HIGHEST PRIORITY)

Category 1 pollutants are derived from the LCC Metals TMDL and the DC Toxics TMDL. The LCC Metals TMDL dated March 17, 2010 states that sources of metals in stormwater include *“automobile brake pads, vehicle wear, building materials, pesticides, erosion of paint and deposition of air emissions from fuel combustion and industrial facilities.”* Within the AB/LCC Group’s jurisdiction there are no industrial facilities.

The remaining Category 1 pollutants are identified in the DC Toxics TMDL. The Final Staff Report for the DC Toxics TMDL, dated May 5, 2011 states *“Metals and PAHs are currently generated or deposited in the watersheds and are then washed into storm drains and channels that discharge to the Dominguez Channel and Greater Harbor Waters. PCBs, DDT, dieldrin, toxaphene, and chlordane are legacy pollutants for the most part, yet, they remain ubiquitous in the environment, bound to fine-grained particles. When these particles become waterborne, the chemicals are often transported downstream and deposited within estuarine or marine waters.”*

As described in Section 6.3.4, Zinc is the controlling agent for this WMP Group. Zinc in stormwater is mainly the result of tires and galvanized metals. Other metals constituents have the same fate and transport as Zinc, therefore treatment of Zinc will address other metal constituents in Category 1.

4.3 CATEGORY 2 (HIGH PRIORITY)

Category 2 includes five pollutants. Of these Bis(2-ethylhexyl) phthalate (DEHP) and trash share the same source. DEHP is a plasticizer which is used in plastic and can enter the receiving water through trash. The State Water Resources Control Board’s Draft Amendment to Statewide Water Quality Control Plans to Control Trash states that:

“A major source of trash is either intentionally or accidentally improperly discarded waste, thrown or deposited on land and in water bodies. If trash occurs on land, it is commonly transported to nearby water bodies by wind and/or rain or dry season runoff.”

During three quarters of dry weather screening, there has been no significant dry season runoff originating from the County Island. Also, as described in Section 6.3.5.5 the AB/LCC Group will install full capture devices on the catch basins within its jurisdiction. This will help prevent trash from entering the receiving water.

Sources of Bacteria in the AB/LCC Group’s jurisdiction can be broken up into anthropogenic and non-anthropogenic sources. Anthropogenic sources are those resulting from the influence of human beings on nature. These sources include sanitary sewer overflows, organic debris from food waste and other sources such as illegal dumping. Non-anthropogenic sources include animal wastes and decay of vegetation.

Possible sources of Ammonia are animal waste, fertilizer and other landscaping activities. It should be noted that the LCCWG is proposing Ammonia and pH for de-listing in the freshwater portion of the Los Cerritos Channel. The appendices of the LCCWG's "Los Cerritos Channel Watershed Management Program" provide a detailed analysis of the natural process which creates elevated pH and Ammonia levels. High Ammonia concentrations in the Los Cerritos Channel are directly related to high levels of pH. Elevated pH levels are caused by a naturally occurring cycle; however, this cycle is amplified by the small volume of dry weather flow sheet flowing across the concrete channel bottom. In recent years, there has been a significant decrease in dry weather flow in the Los Cerritos Channel. In agreement with the LCCWG, this WMP Group supports the effort for delisting Ammonia and pH.

4.4 CATEGORY 3 (MEDIUM PRIORITY)

This WMP Group has two Category 3 pollutants, MBAS and enterococcus. MBAS is typically linked to detergents and other cleaning products. Enterococcus has similar sources to those of coliform bacteria which are listed above (Section 4.3).

Section 5. Watershed Control Measures

5.1 OBJECTIVE

Per Section VI.C.5 of the Permit, permittees shall provide documentation that they have the necessary legal authority to implement the Watershed Control Measures identified in the plan, or that other legal authority exists to compel implementation of the Watershed Control Measures. The legal authority for the County and LACFCD to implement Watershed Control Measures can be found in Appendix C and D respectively.

Additionally, Section VI.5.b.i of the Permit requires Permittees to identify strategies, control measures, and to implement BMPs through their individual storm water management programs, and collectively on a watershed scale, with the goal of creating an efficient program to focus individual and collective resources on watershed priorities. The objectives of the Watershed Control Measures include:

- (1) Prevent or eliminate non-storm water discharges to the MS4 that are a source of pollutants from the MS4 to receiving waters.
- (2) Implement pollutant controls necessary to achieve all applicable interim and final water quality-based effluent limitations and/or receiving water limitations pursuant to corresponding compliance schedules.
- (3) Ensure that discharges from the MS4 do not cause or contribute to exceedances of receiving water limitations.

5.2 CONTROL MEASURES

This WMP Group has identified numerous control measures, or BMPs for the County Island. Due to the limited area of the County Island, there is little room for large-scale BMPs although this WMP Group will investigate opportunities to collaborate with other permittees. Potential non-structural BMPs applicable to the County Island include enhanced street sweeping, and increased catch basin cleanouts. Potential structural BMPs would be those that require a small footprint such as drainage filtration catch basins and full capture devices. A detailed evaluation of potential BMPs for the County Island can be found in the Section 6 of this WMP.

5.3 MINIMUM CONTROL MEASURES

Section VI.D.4 of the Permit provides requirements for minimum control measures for the LACFCD and Section VI.D.5-10 provides requirements for each permittee.

5.3.1 MCM Requirements for the LACFCD

In general, the requirements for the LACFCD involve:

- Implementing a Public Information and Participation Program (PIPP),
- For LACFCD Industrial or Commercial Facilities, complying with section VI.D.6 of the Permit,
- Implementing a Public Agency Activities Program,

- Continuing to implement an Illicit Connection and Illicit Discharge Program.

The LACFCD is currently implementing all of these requirements and will continue to do so for the duration of this Permit.

5.3.2 MCM Requirements for the County of Los Angeles

In general, the requirements for each permittee involve:

- Implementing a Public Information and Participation Program (PIPP)
- For each Permittee's Industrial or Commercial Facilities, complying with section VI.D.6 of the Permit
- Implementing a Planning and Land Development Program pursuant to Section VI.D.7.b for all New Development and Redevelopment projects subject to the Permit
- Developing a Construction Program subject to Section VI.D.8 of the Permit
- Implementing a Public Agency Activities Program
- Continuing to implement an Illicit Connection and Illicit Discharge Program

The County will implement all of these requirements upon approval of this WMP and will continue to do so for the duration of this Permit.

Section 6. Reasonable Assurance Analysis

6.1 OBJECTIVE

Per Section VI.C.5.b.iv.5 of the Permit, this WMP Group has conducted a Reasonable Assurance Analysis (RAA) for the areas in which it has jurisdiction of the land use. The Permit requires:

- The RAA shall be quantitative and performed using a peer-reviewed model in the public domain.
- The RAA shall commence with assembly of all available, relevant subwatershed data collected within the last 10 years, including land use and pollutant loading data, establishment of quality assurance/quality control (QA/QC) criteria, QA/QC checks of the data, and identification of the data set meeting the criteria for use in the analysis.
- Data on performance of watershed control measures needed as model input shall be drawn only from peer-reviewed sources. These data shall be statistically analyzed to determine the best estimate of performance and the confidence limits on that estimate for the pollutants to be evaluated.
- The objective of the RAA shall be to demonstrate the ability of Watershed Management Programs and EWMPs to ensure that Permittees' MS4 discharges achieve applicable water quality based effluent limitations and do not cause or contribute to exceedances of receiving water limitations.

Additionally, the LARWQCB has released "Guidelines for Conducting Reasonable Assurance Analysis in Watershed Management Program, including an Enhanced Watershed Management Program dated March 25, 2014" (RAA Guidelines). The RAA Guidelines were prepared to provide clarification of the permit requirements regarding the RAA, along with recommended criteria for the permittees to prepare an appropriate RAA for LARWQCB approval.

This section documents the analysis and results of the RAA effort to address stormwater and non-stormwater discharges originating from the County Island. Further, a comprehensive phased approach of BMP implementation is provided. The benefits of BMPs are estimated, in terms of pollutant load reductions, to meet applicable wasteload allocations (WLAs).

This WMP Group has land use jurisdiction over the County Island. The LACFCD does not have jurisdiction of the land uses that create the pollutants of concern in the Alamitos Bay and Los Cerritos Channel Estuary watersheds. These areas are under the jurisdiction of the City of Long Beach and the associated RAA will be addressed under Long Beach's WMP which will be submitted in March 2015. Through adaptive management, the LACFCD will review Long Beach's WMP and consider on a case-by-case basis opportunities for collaboration on future projects.

6.2 NON-STORMWATER APPROACH

This WMP Group has begun to implement a thorough Non-Stormwater Outfall Monitoring Program. Details of this program can be found in the AB/LCC CIMP. Based on suggestion from the LARWCQB, the program includes quarterly screening of outfalls in the Group's jurisdiction for the duration of 1 year. This WMP Group has identified significant dry weather flow as: 1) flow which is greater than a garden hose originating from the County Island 2) Flow

that is seen 2 out of the 4 screening events. Screenings for the Spring, Fall and Winter seasons have taken place. These screenings have found no significant dry weather flow originating from the County Island. As no significant flow has been found originating from the County Island, dry weather runoff from the County Island is not a concern and does not need to be modeled. A Summer screening is scheduled for 2015. Figure 6 shows the catch basins, flow direction of surface runoff, major and other outfalls in the County Island.

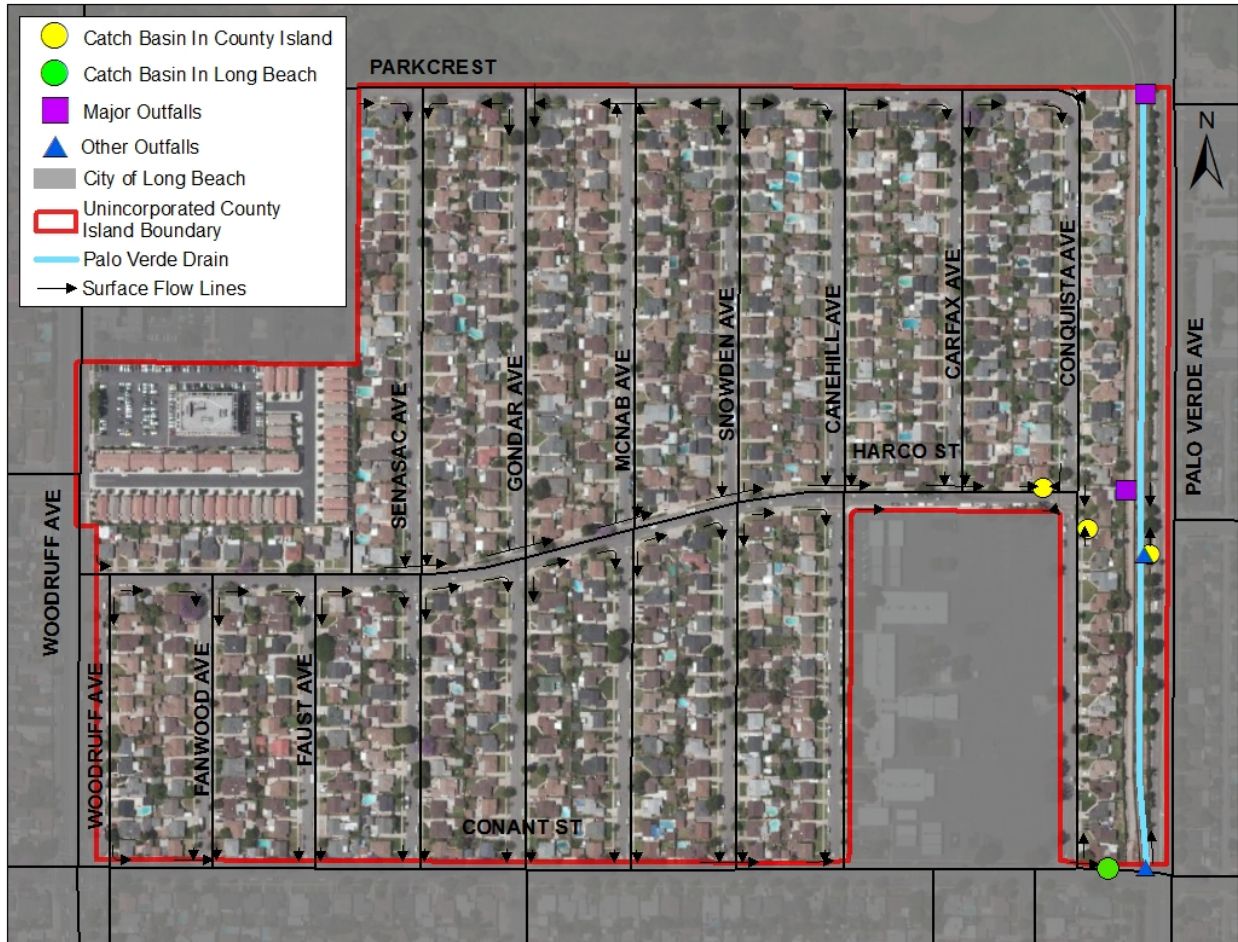

Figure 6: Catch Basins, Flow Direction and Outfalls in County Island

6.3 STORMWATER QUALITY MODEL/APPROACH

This WMP Group utilized the Watershed Management Modeling System (WMMS) to model flows and pollutant loading originating from the County Island. WMMS is a LARWQCB approved model developed as a comprehensive decision support system to help select BMPs, to aid watershed planning and development of strategic TMDL compliance plans.

The following approach was used for conducting the RAA:

1. Identify land area for analysis
2. Run WMMS for identified land area for a 10-year period (October 15, 2000 to April 15, 2011)

3. Select Critical Condition storm
4. Determine Critical Condition Daily Pollutant Load
5. Compare Critical Condition Daily Pollutant Loads to WLA limits
6. Identify non-structural and structural BMPs
7. Develop schedule to meet needed percent reductions

6.3.1 Land Area Identification

The RAA was conducted for areas in which the WMP Group has jurisdiction over the land use. Accordingly, the 95-acre County Island was modeled. The County Island is located completely within WMMS sub basin 5505. The WMMS model was prepared to isolate only those land uses of the County Island. For reference, sub basin 5505 and neighboring WMMS sub basins are shown in Figure 7.

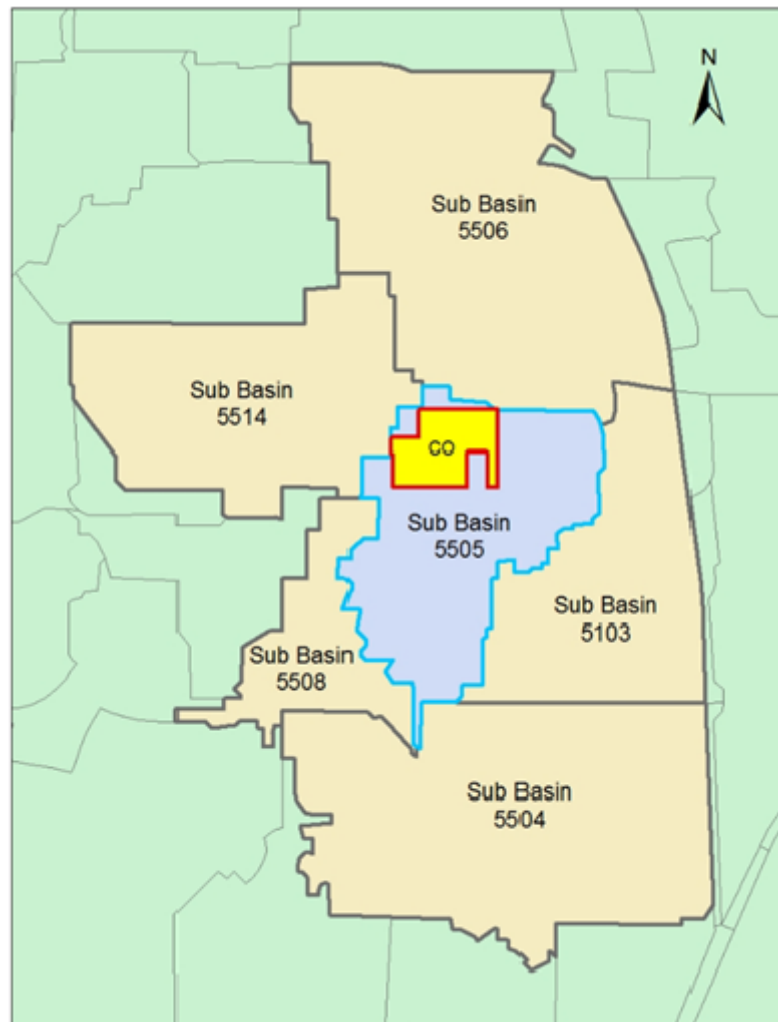

Figure 7: County Island, WMMS Sub Basin 5505 and Neighboring Sub Basins

The Unincorporated County Island Hydrologic Response Units (HRU) and associated Impervious Area distribution is presented in Figure 8 and Table 5.

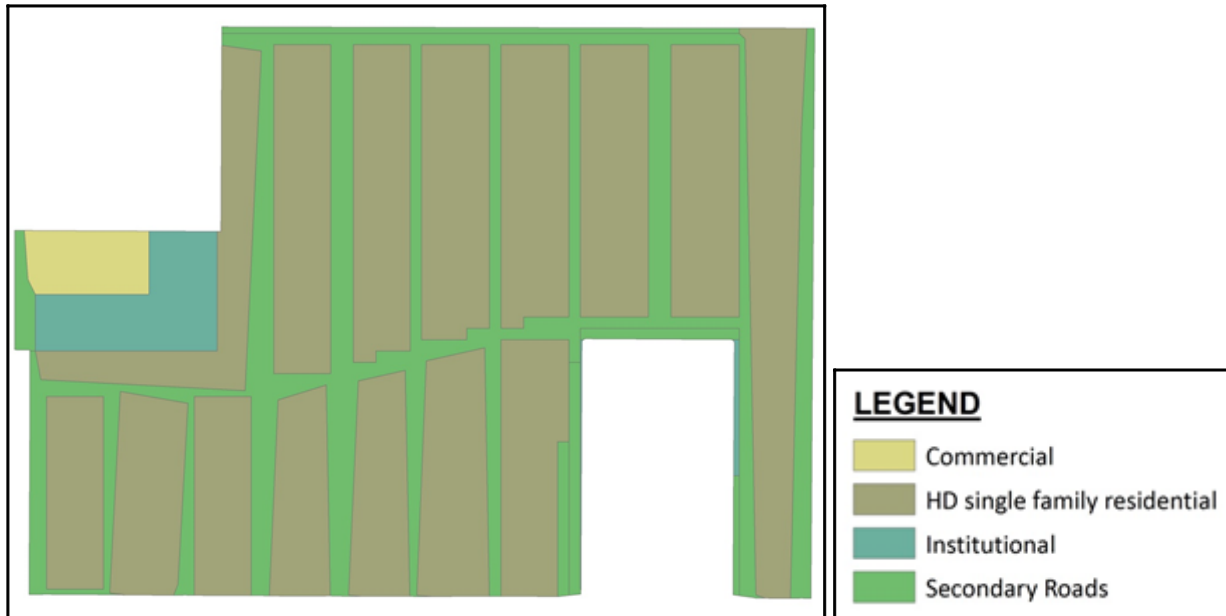

Figure 8: Unincorporated County Island HRU Map

Table 5: HRU Breakdown for County Island

HRU ID	HRU Description	Area (acre)	Impervious Area Percentage	Impervious Area (acre)
1	High Density, Single Family Residential	63.27	42%	26.57
5	Commercial	1.98	96%	1.90
6	Institutional	4.01	75%	3.01
9	Secondary Roads	25.39	44%	11.17

6.3.2 WMMS Analysis

WMMS was populated with the most current information available for input into model. At the time of analysis, data from the 2000-2001 to the 2010-2011 Storm Seasons (October 15, 2001 to April 15, 2011) was available. Figure 9 shows the WMMS output of daily storm volumes. As there is no specific monitoring data for the County Island, or the surrounding subwatershed, WMMS analysis was conducted utilizing built-in parameters. As data is collected during the implementation of this Group’s CIMP, WMMS will be calibrated, if necessary. The WMMS output utilizing the built-in parameters included hourly/daily storm volumes as well as hourly/daily pollutant loading. The WMMS input files used for analysis have been submitted to the LARWQCB.

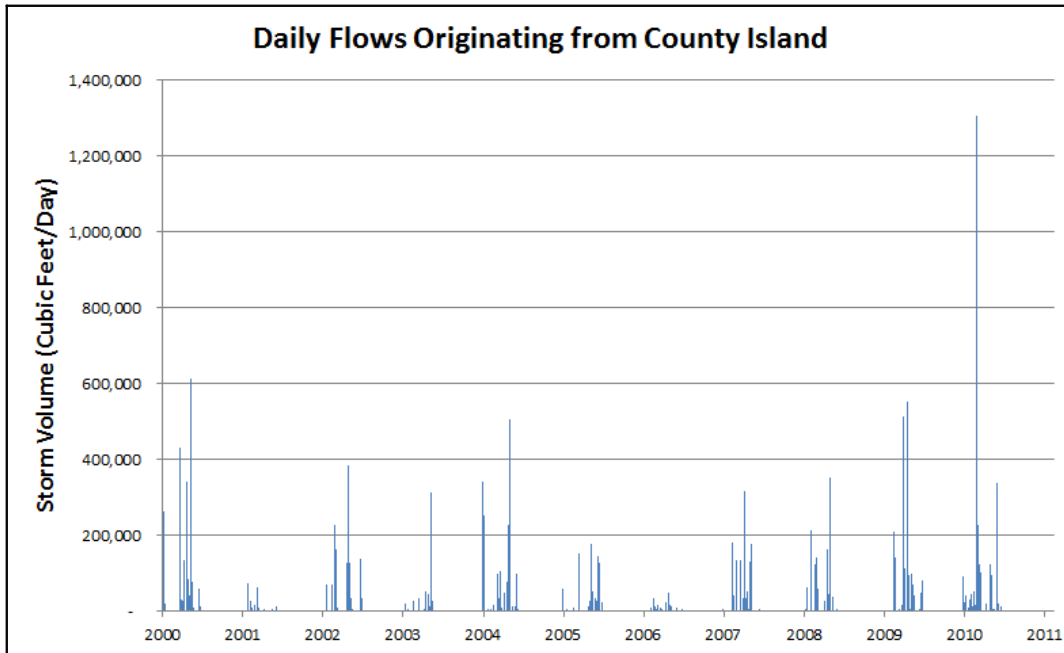

Figure 9: Daily Flows Originating from County Island

6.3.3 Critical Storm

Per the RAA Guidelines, the 90th percentile flow volume was to be determined. Accordingly, all storms occurring from October 15, 2001 to April 15th 2011 were ordered based on the magnitude of their storm volume as shown in Figure 10. The 90th percentile (Critical Condition) storm was then selected. For the County Island, the Critical Condition storm was selected as a storm event which occurred on February 5, 2009. Appendix E contains the dates of storms analyzed and their associated storm volumes in a tabular format.

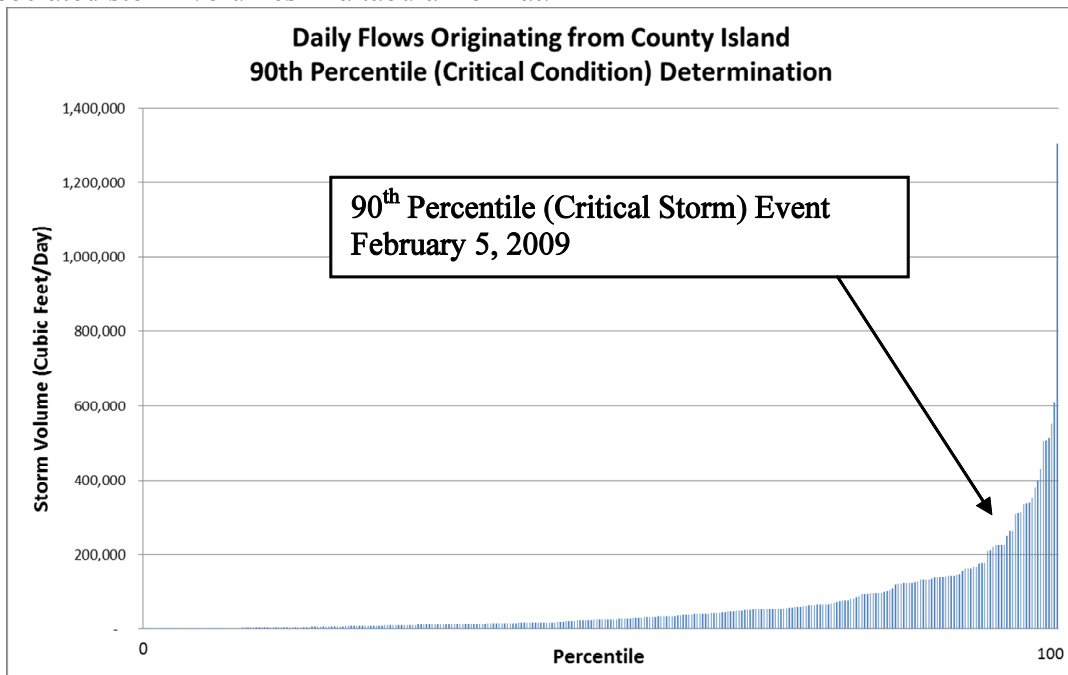

Figure 10: County Island Storms Ordered by Storm Volume

6.3.4 Critical Condition Daily Pollutant Load

The WMMS output was then analyzed and the Critical Condition Daily Pollutant Load and the allowable loading per the LCC Metals TMDL were calculated. This analysis used the 90th Percentile Critical storm event volume (3.7 acre-feet) and the LCC Metals TMDL allowable concentrations found in Table 6-7 of the LCC Metals TMDL (as shown in Table 6 below).

Table 6: Wet-Weather Stormwater Allocations per LCC Metals TMDL

Metal	Los Angeles County MS4 Permittee (g/day)
Copper	4.709 x daily storm volume (L) x 10 ⁻⁶
Lead	26.852 x daily storm volume (L) x 10 ⁻⁶
Zinc	46.027 x daily storm volume (L) x 10 ⁻⁶

The Critical Condition Daily Pollutant Load was calculated as:

$$\text{Critical Condition Daily Pollutant Load} = \text{Critical Condition Storm Event Volume} \times \text{Modeled Critical Condition Concentration}$$

Similarly, the LLC Metals TMDL Allowable Daily Load was calculated as:

$$\text{TMDL Allowable Daily Load} = \text{Critical Condition Storm Event Volume} \times \text{LCC Metals TMDL Allowable Concentration}$$

As shown in Table 7, the modeled Critical Condition Daily Pollutant Loads of Copper, Lead and Zinc were calculated:

- Critical Condition Daily Pollutant Copper Loading: 0.080 kg
- Critical Condition Daily Pollutant Lead Loading: 0.078 kg
- Critical Condition Daily Pollutant Zinc Loading: 0.764 kg

Table 7: Critical Condition and Allowable Daily Load Calculation

LCC Metals TMDL Pollutant	Critical Condition Storm Event Volume (acre-ft.)	Critical Condition Storm Event Volume (L)	LCC Metals TMDL Allowable Conc. (micrograms/L)	Modeled Critical Cond. Conc. (micrograms/L)	TMDL Allowable Daily Load (kg)	Modeled Critical Cond. Daily Pollutant Load (kg)
Copper	3.7	4,593,216	4.709	17.52	0.022	0.080
Lead	3.7	4,593,216	26.852	16.897	0.123	0.078
Zinc	3.7	4,593,216	46.027	166.225	0.211	0.764

A time series analysis for LCC Metals TMDL constituents can be found in Appendix G. Other Category 1 pollutants identified in the DC Toxics TMDL were considered. These pollutants have similar fate and transport as the LCC Metals TMDL constituents, i.e. the toxics and metals move through and are transformed physically, chemically and biologically the same in the environment. The DC Toxics TMDL's final compliance date is over 5 years after the LCC

Metal TMDL's. By using the limiting pollutant approach in this RAA, treatment of the Critical LCC Metals Condition will address the DC Toxics TMDL.

Category 2 and 3 pollutants were then analyzed for their Critical Condition. As discussed in Section 4.3, Ammonia and pH are proposed for delisting and do not need to be modeled. Ammonia is directly related to sediment; therefore, proposed BMPs to treat Metals will also reduce Ammonia.

As discussed in Section 4.3, Bis(2-ethylhexyl) phthalate (DEHP) and trash share the same source. DEHP is a plasticizer which is used in plastic and is typically associated with trash. As discussed in Section 6.3.5.5, this WMP Group will install full capture devices on the catch basins in their jurisdiction to significantly reduce trash. Therefore, trash and DEHP do not need to be modeled.

To address Bacteria and in particular Coliform Bacteria, WMMS was used to analyze Fecal Coliform. As seen in Table F.1 of Appendix F, the 2004-2005 storm season is the 90th percentile year for Bacteria. Page 4 of the RAA guidelines state:

“For pollutants included in the RAA but for which there is no TMDL, permittees should consider expressing pollutant loading in terms of averaging periods/duration/critical conditions consistent with those used in TMDLs for that pollutant in order to proactively address the water quality problem in such a way as to avoid the need for a TMDL in the future if possible.”

This WMP Group utilized the methodology outlined by the Ballona Creek, Ballona Estuary and Sepulveda Channel Bacteria TMDL. This TMDL allows for 17 wet weather exceedance days. Storms during the 2004-2005 season were arranged based on magnitude and the 18th largest storm was selected as the Critical Condition Bacteria storm event. This storm produces a 1.09 acre-feet volume. The Critical Condition Bacteria storm volume is far below the 90th Percentile Critical Storm Volume (3.7 acre-feet) chosen for the LCC Metals TMDL. Therefore, treatment of the LCC Metals TMDL will also meet applicable Bacteria limits.

MBAS is typically linked to detergents and other cleaning products. The County Island's contribution of MBAS will be determined based on actual monitoring results from implementation of the Group's CIMP. Enterococcus is a bacteria similar to Fecal Coliform and will be addressed through the previously discussed Bacteria analysis.

6.3.4.1 Comparison of Daily Pollutant Loads to WLA Limits

WLA's for Copper, Lead and Zinc were identified in the LCC Metals TMDL. Limits in the DC Toxics TMDL were identified; however, due to the County's minimal land area tributary to the San Pedro Bay (less than 0.5% of the watershed) reasonable allocations could not be determined. The County Island's contribution to the San Pedro Bay will be determined based on actual monitoring results from implementation of the AB/LCC Group's CIMP. The Critical Condition Daily Pollutant Loads from WMMS were then compared to the WLA from the LCC Metals TMDL (Table 8).

Table 8: Analysis Based on WMMS Results

Critical Condition Storm	Copper			Lead			Zinc		
	Daily Pollutant Load (kg)	TMDL Allowable Daily Load (kg)	Required Daily Load Reduction (kg)	Daily Pollutant Load (kg)	TMDL Allowable Daily Load (kg)	Required Daily Load Reduction (kg)	Daily Pollutant Load (kg)	TMDL Allowable Daily Load (kg)	Required Daily Load Reduction (kg)
February 5, 2009 (3.7 acre-feet)	0.080	0.022	0.059	0.078	0.123	0.000	0.764	0.211	0.552
% Reduction Required	73%			0%			72%		

Key conclusions from the comparison are:

- Lead is within the required TMDL limits
- Copper requires the highest reduction; however, based on an analysis of SB 346 it will not be the controlling agent (see Section 6.3.5.2 for more information)
- Zinc will be the controlling agent

The RAA is conducted under the assumption that if the controlling agent is reduced to the required WLA, all other metals will also be in compliance.

6.3.5 Identification of Potential Non-Structural and Structural BMPs

The implementation of non-structural and structural BMPs aims to build a reasonable approach to achieve the required percent reduction of the controlling agent. For this WMP Group, the controlling agent is Zinc, which requires a 72% reduction. The WMP Group plans to achieve this reduction through a combination of existing and planned control measures, then, if necessary through additional BMP implementation. It should be noted that the LCC Metals TMDL has a final compliance milestone of September 2026; accordingly, the implementation of BMPs will rely heavily on the results of monitoring data provided by the CIMP.

The sections below list existing and planned BMPs as well as identify potential BMPs for this WMP Group.

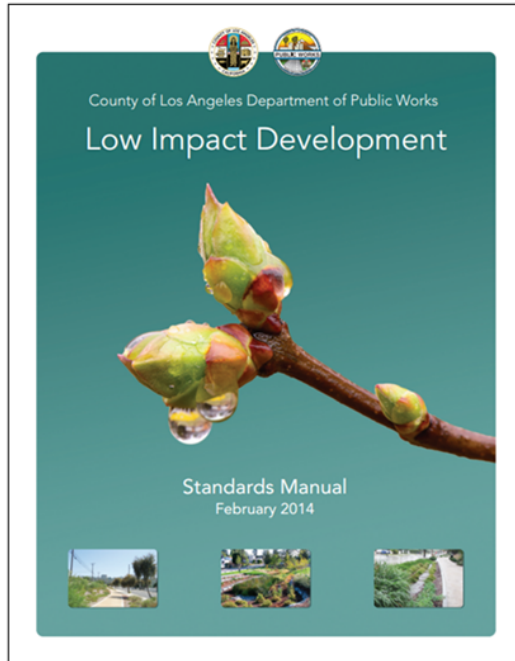

Figure 11: County's Low Impact Development Manual

6.3.5.1 Low Impact Development (Existing Non-Structural BMP)

The County's revised Low Impact Development (LID) Ordinance was adopted by the Los Angeles County Board of Supervisors in November 2013. Shortly after the adoption of the Ordinance, the County developed a LID Manual.

The LID Manual details two types of projects, Designated Projects and Non-Designated Projects. Designated Projects must infiltrate the entire volume of the Water Quality Design Storm (WQDS). The WQDS is calculated to be either the 0.75 inch storm or the 85th percentile storm, whichever is greater. The WQDS is intended to be the design storm which provides the maximum benefit for minimal cost. Designated projects include:

- Sites disturbing 1 acre or more and adding 10,000 sq. ft. + impervious area
- Industrial parks 10,000 sq. ft. + impervious area
- Commercial malls 10,000 sq. ft. + impervious area
- Gas outlets 5,000 sq. ft. + impervious area
- Restaurants 5,000 sq. ft. + impervious area
- Parking lots 5,000 sq. ft. + impervious area or 25 + parking spaces
- Auto facilities 5,000 sq. ft. + impervious area
- Redevelopment projects adding, replacing, creating 5,000 sq. ft. + impervious area
- Sites within Significant Ecological Area that impact sensitive species or habitat and create 2,500 sq. ft. + impervious area

If infiltration is not feasible at the designated projects sites, the LID Manual provides other options for meeting compliance.

The LID Manual also provides requirements for Non-Designated Projects. These requirements are residential projects of 4 units or less that do not fall under the designated project thresholds. The property developer must choose 2 of the following BMPs:

- Porous Pavement
- Cistern/Rain Barrel
- Rain Garden/Planter Box
- Disconnect Impervious Surfaces
- Dry Well

- Landscaping and Landscape Irrigation
- Green Roof

Non-Designated Projects that are residential projects of 5 units or more or a non-residential project must infiltrate the post-development WQDS runoff minus pre-development WQDS runoff. The LID Manual also provides additional compliance requirements for special cases such as single family hillside homes. Further details can be found in the County of Los Angeles' Low Impact Development Manual, dated February 2014.

A majority of the County Island is high-density single family residential. The County's LID Ordinance requires:

- Redevelopment of an existing single family house would be a "non-designated project". LID would be required if there is "addition or alteration" of impervious surfaces.
- If a property owner adds or alters 50% of the impervious surface, then property owner would have to treat the WQDS for the entire site.
- If the property owner adds or alters less than 50% of their site, then the property owner would need LID only for the portion that has been altered.
- Redevelopment of a property over 5,000 square feet would be a "designated project". The property owner would need to infiltrate the volume of runoff created. If they are unable to infiltrate, the proper owner would be subject to other mitigation options.

Assuming a limited rate of implementation of LID for the County Island, a 1% reduction for Zinc is applied to the Critical Condition Daily Pollutant Load prior to the LCC Metals Final Compliance Date (September 2026). A 0.2% reduction is applied before the first LCC Metals TMDL interim deadline (September 2017).

6.3.5.2 Senate Bill 346 (Existing Non-Structural BMP)

In 2010, California Senate Bill SB 346 (SB 346) was enacted to nearly eliminate the use of Copper in brake pads. In 2012, TDC Environmental LLC prepared a draft detailed memo (TDC memo) describing the expected percent reduction of Copper reductions. The TDC memo identifies 3 possible implementation scenarios:

- One Step Reduction
 - All new vehicles and replacement brake pads are reformulated to contain less than 0.5% Copper by January 1, 2021 (first SB 346 compliance deadline).
- Two Step Reduction
 - New vehicle brake pads are reformulated to contain less than 5% copper by January 1, 2021 and less than 0.5% Copper by 2025. It would be assumed that all higher Copper replacement brakes would be sold within two years of each compliance date.
- Aftermarket Exemption
 - New vehicle brake pads are reformulated to contain less than 5% copper by January 1, 2021 and less than 0.5% copper by 2025. This scenario assumes that higher Copper replacement brakes would continue to be sold indefinitely.

Of these cases, Scenario 1 is considered to be the most optimistic and Scenario 3 the most conservative. All scenarios were then analyzed over a fourteen-year period. The TDC memo determines the following copper reductions by the year 2032:

- Scenario 1: 61% Copper reduction
- Scenario 2: 61% Copper reduction
- Scenario 3: 55% Copper reduction

Per the LCC Metals TMDL, the County Island must attain 100% dry weather compliance by September 2023 and 100% wet weather compliance by September 2026. Using Scenario 3 (the most conservative approach), and interpolating values identified in the TDC memo, it is assumed that there will be a 33.5% reduction in Copper by 2023 and a 44% reduction in Copper by 2026. Copper requires the highest reduction; however, based on the projected outcomes of SB 346, Copper will not be the controlling agent. Copper has the same fate and transport as the controlling pollutant Zinc. Therefore, BMPs which address Zinc will also enhance the treatment of Copper in the County Island jurisdiction.

6.3.5.3 Enhanced Street Sweeping (Planned Non-Structural BMP)

Street sweeping is a well-known, non-structural BMP, which removes trash, natural debris and sediment from roads and parking lots. Street sweeping can improve the quality of stormwater runoff by reducing the amount of sediment-bound pollutants that enter catch basins, storm drains and eventually receiving waters.

The County Island is currently swept once a week, historically, this was done mostly by mechanical broom sweepers. The County Island is currently swept by a contractor using a vacuum sweeper. This WMP Group reviewed numerous studies related to street sweeping including:

- Potential Effects of Structural Controls and Street Sweeping on Stormwater Loads to the Lower Charles River, Massachusetts Study
- City of San Diego, Targeted Aggressive Street Sweeping Pilot Study

These studies show that efficient street sweepers such as assisted-vacuum or regenerative-air sweepers are the best machines at removing finer-grained contaminants bound to sediment. Also, the City of San Diego Study found that the assisted vacuum sweeper outperformed the regenerative-air sweeper. The County will ensure that either through in-house forces or through contractors, the County Island continues to be swept by a Vacuum Sweeper.

The County currently maintains a fleet of 48 street sweepers, 38 of which are mechanical broom sweepers and 10 are regenerative-air sweepers. Over the next few years, the County will upgrade a portion of its mechanical broom street sweepers with new high efficiency vacuum street sweepers. Additionally, the County will be conducting a special study to demonstrate the High-Efficiency Vacuum Street Sweepers effect on water quality.

Based on thorough literature review, this WMP Group determined a 5% reduction of Zinc for its efforts in upgrading its fleet to high efficiency vacuum sweepers. This reduction considers the fact that the County Island has very little slope and it is assumed that sediment is retained in the curb and gutter of the County Island. Accordingly, it is expected that the vacuum sweeper will

collect a large amount of sediment that would otherwise be mobilized into the receiving water during a storm event.

6.3.5.4 Irrigation Ordinance (Existing/Potential Non-Structural BMP)

On October 7, 2008, the County of Los Angeles Board of Supervisors adopted Ordinance No. 2008-00052U, which states that:

- *“No person shall hose water or wash down any sidewalks, walkways, driveways, parking areas of other paved surfaces, except as is required for the benefit of public health and safety.”*
- *“No person shall water or cause to be watered any lawn or landscaping to such an extent that runoff into adjoining streets, parking lots or alleys occurs due to incorrectly directed or maintained sprinklers or excessive watering.”*
- *“No motor vehicle, boat, trailer, or other type of mobile equipment may be washed, except at a commercial carwash or with reclaimed water, unless such vehicle is washed by using a hand-held bucket or a water-hose equipped with an automatic shutoff nozzle.”*

Violations of the subject ordinance are subject to fines. This is an existing BMP; however, depending on budgetary needs, the County may allocate additional resources to increase enforcement of this ordinance.

6.3.5.5 Full Capture Devices (Planned Structural BMP)

In April 2007, after extensive research, testing, and development, the County submitted a Full-Capture Device Technical Report for the connector pipe screen (CPS) device to the LARWCQB. The CPS device was subsequently certified by the LARWCQB as an approved full-capture device on August 1, 2007. The LARWCQB has stated:

“a full-capture system is any single device or series of devices that traps all particles retained by a 5-millimeter mesh screen (100 percent trash removal) and has a design treatment capacity of not less than the peak-flow rate resulting from a one-year, one-hour, storm in the subdrainage area.”

CPS devices are designed to reduce trash, but also provide the ancillary benefit of reducing sediment from entering the storm drain system.

The County has successfully implemented CPS units in many of unincorporated County Islands. Additionally, the County has implemented Automatic Retractable Screens (ARS) in numerous locations. ARS devices are placed at the curb inlet of the catch basin adjacent to the roadway. During dry weather and low flow conditions, trash, plastics, vegetative debris and other objects are prevented from entering the catch basin. During routine street sweeping, this material is swept from the curb inlet and removed from the watershed. To prevent localized flooding during heavy runoff, the ARS device is automatically opened via pressure from stormwater on the face of the ARS device. Debris that may enter the catch basin is then filtered by the CPS unit.

Design of the CPS and ARS devices is underway and the County plans to implement this BMP on the 3 catch basins within its jurisdiction by Spring 2016. Design of the CPS and ARS devices is currently underway. Construction of the devices is contingent upon appropriate field

conditions. CPS devices cannot be installed in areas where they may adversely affect flood protection or in catch basins that are too shallow to house CPS devices.

To quantify the benefit of Full Capture Devices this WMP Group reviewed the:

- County of Los Angeles's "Multi-Pollutant TMDL Implementation Plan for the Unincorporated County Area of Ballona Creek" (Ballona Creek IP)
- Center for Watershed Protection's "Research in Support of an Interim Pollutant Removal Rate for Street Sweeping and Storm Drain Cleanout Activities" dated October 2006 (CWP Memo).

The CWP Memo developed a conceptual model to assess pollutant load reduction for catch basin cleanouts. The installation of full capture devices greatly increases the volume of material retained in catch basins which will then be removed during routine cleanouts. Building on information in the CWP Memo, the Ballona Creek IP applied an annual removal rate of 5% to sediments and metals generated in the transportation network. This 5% removal rate within the transportation corridor translated to an *overall* reduction in load of up to 2.1% for the County Islands in the Ballona Creek watershed. Accordingly, this WMP Group has assumed a 2% overall reduction of Zinc.

6.3.5.5.1 Increased Catch Basin Cleanout (Planned Non-Structural BMP)

As a function of installing CPS devices, the County will increase its cleaning frequency of the catch basins in this County Island. Currently catch basins within this County Island are cleaned on a yearly basis. Once CPS devices are installed, the County maintenance will be increased to:

- Bimonthly inspection during Storm Season (October 1 to April 30)
- Inspection after Major Storms
- Cleanouts will be done as needed following these inspections
- One inspection/cleanout during Dry Season (May 1 to September 30)

Visual inspection of catch basin cleanouts has shown significant amounts of sediment captured within catch basins. Based on this increased frequency, a 2% of Zinc reduction has been assumed. This percentage will be considered and may be refined during the adaptive management process.

6.3.5.6 Biofiltration System (Potential Structural BMP)

If needed, the County has identified Biofiltration Systems as potential structural BMPs that would benefit water quality in this County Island. These systems would be installed in road parkways upstream of existing catch basins. The Biofiltration system utilizes screening, hydrodynamic separation, media filtration and bio retention to treat storm water and dry weather flows (Figure 12).

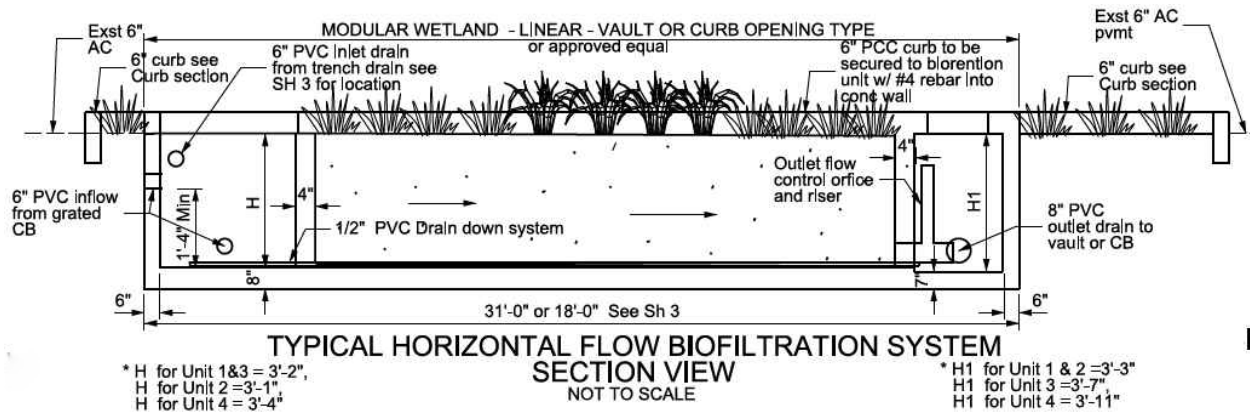

Figure 12: Typical Biofiltration System

Biofiltration Systems have demonstrated 79% efficiency in Zinc removal (Modular Wetlands). The County is currently installing these systems as part of water quality projects in other watersheds, and is evaluating their effectiveness.



Figure 13: Potential Biofiltration System Location

The County has identified the need for appropriate water quality monitoring data before determining the number and location of Biofiltration Systems to be installed. This schedule is outlined in Section 6.3.6.

6.3.5.7 Drainage Filtration Catch Basin (Potential Structural BMP)

Drainage Filtration Catch Basins (Figure 14) may potentially be used to reduce the amount of runoff which leaves the County Island.

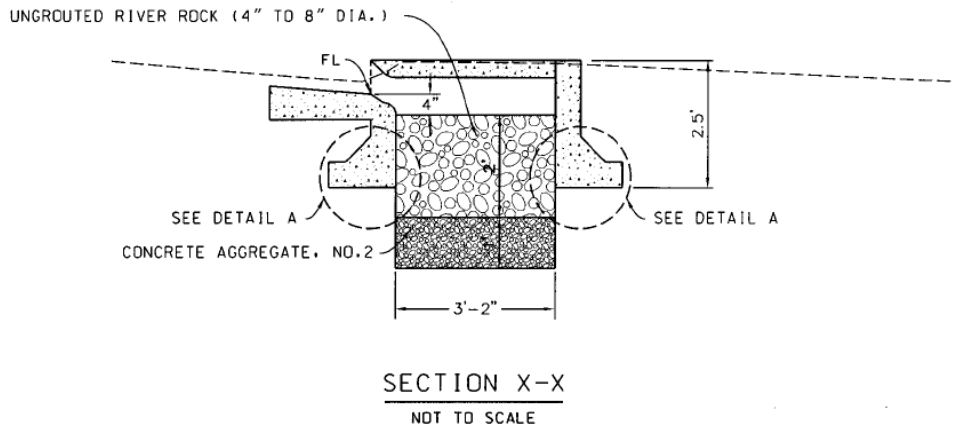

Figure 14: Drainage Filtration Catch Basin Typical Section

Drainage Filtration Catch Basin Systems have been utilized in numerous locations around the County. Their implementation is dependent on the local soils infiltration capacity as well as available space in the public road parkway. Preliminary analysis of nearby groundwater wells shows adequate infiltration depths may be available. However, before feasibility is determined a site-specific analysis is required on soil infiltration rates.



Figure 15: Potential Drainage Filtration Catch Basin Locations

The County has identified the need for appropriate water quality monitoring data before determining the number and location of Drainage Filtration Catch Basins to be installed. A schedule of monitoring and BMP implementation is presented in in Section 6.3.6.

6.3.5.8 LACFCD Right of Way Infiltration (Potential BMP)

The AB/LCC Group has identified a potential project along the Palo Verde Drain.



Figure 16: Potential Right of Way Project along Palo Verde Drain

The LACFCD's right of way along the Palo Verde Drain is frequently used by pedestrians. A potential greenway project incorporating habitat, water quality and recreation features could be implemented at this location. Implementation of all BMPs including this potential right of way project is contingent upon the results of monitoring from the Group's CIMP as well as budgetary considerations. If results of monitoring determine the need for additional BMPs, the LACFCD and County will collaboratively investigate the feasibility of this project.

6.3.6 Schedule to Meet Needed Percent Reductions

By September 2026, an estimated 72% reduction of Zinc is needed to meet the appropriate WLAs. Stormwater volumes to be mitigated to meet interim and final deadlines were calculated utilizing the 90th Percentile Critical Condition storm volume of 3.7 acre-feet and the System for Urban Stormwater Treatment and Analysis IntegratiON (SUSTAIN) component of WMMS. To meet the needed pollutant load reduction, this volume of Stormwater would need to be mitigated, either through infiltration, nonstructural BMPs or a flow-through BMP system. The correlation between the needed percentage of pollutant reduction and the associated percent flow reduction can be seen in Figure 17. For example a 72% reduction of Zinc by September 2026 would require 43.9% reduction in flow or 1.62 acre-feet of stormwater volume mitigated (43.9% x 3.7 acre-feet).

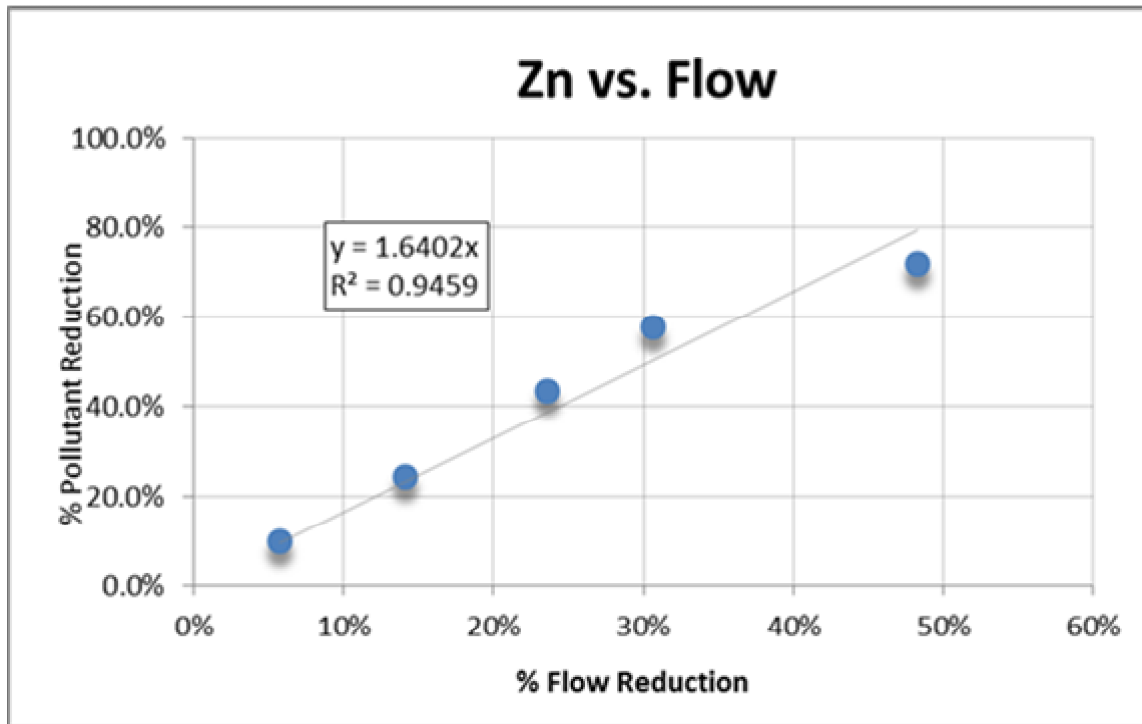

Figure 17: Zinc % Pollutant Reduction vs. Percent Flow Reduction from SUSTAIN

Table 9 is generated using the Critical Condition storm volume and the interim and final deadlines from the LCC Metals TMDL. Figure 18 shows the needed stormwater volumes to be mitigated and the expected mitigation from planned BMPs to be implemented prior to the first LCC Metals interim deadline (September 30, 2017).

Table 9: LCC Metals TMDL, Stormwater Volumes to be Mitigated

Date	Wet Weather Compliance Milestone	Stormwater Volume to be Mitigated (acre-feet)
September 30, 2017	10% compliance with wet weather WLAs	0.16
September 30, 2020	35% compliance with wet weather WLAs	0.57
September 30, 2023	65% compliance with wet weather WLAs	1.06
September 30, 2026	100% compliance with wet weather WLAs	1.62

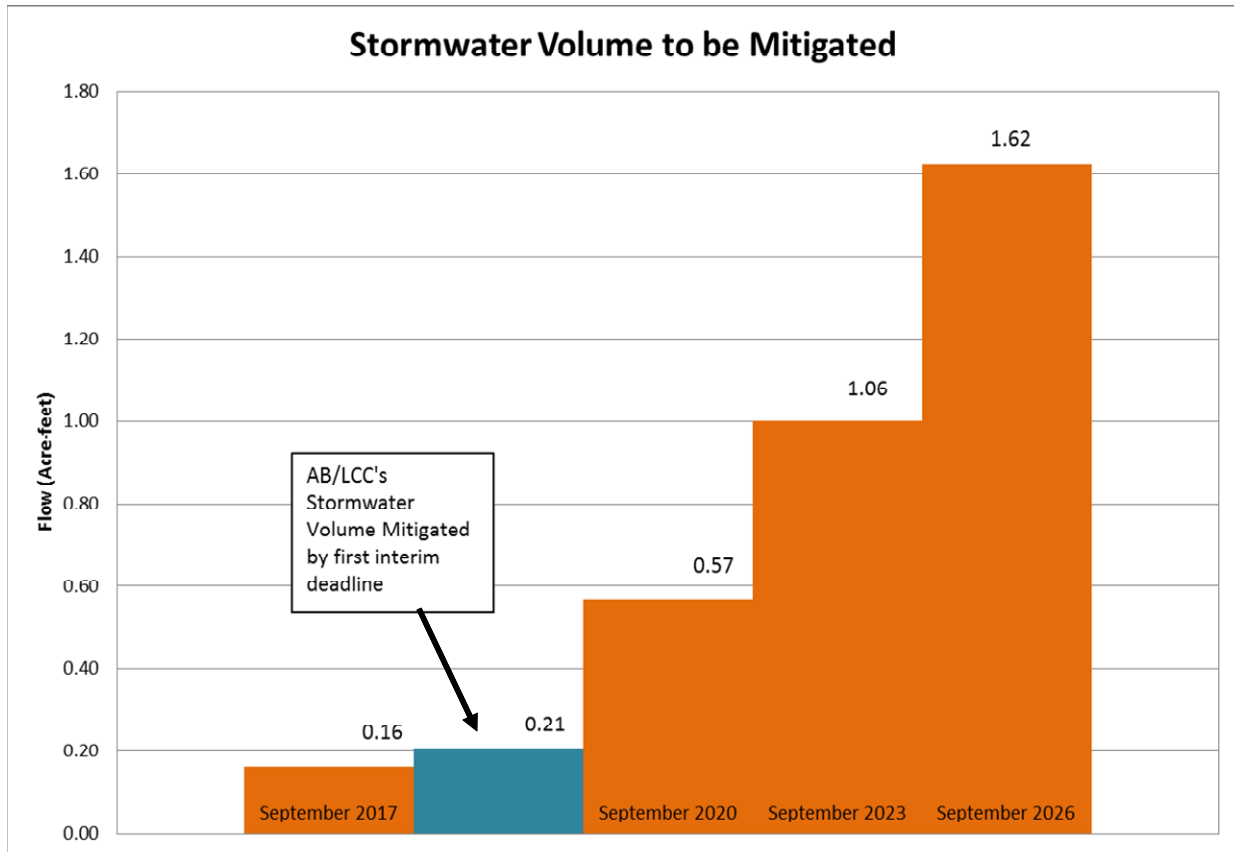

Figure 18: Needed Stormwater Mitigation Volumes

This WMP Group will implement the BMPs below prior to the first interim compliance date for the LCC Metals TMDL (September 30, 2017). The group assumes the following reductions for these existing and planned BMPs:

- Low Impact Development Ordinance 0.2%
 - A 1% reduction is assumed by September 2026
- Enhanced Street Sweeping 5%
- Full Capture Devices 2%
- Increased Catch Basin Cleanout 2%

After implementation of these BMPs a 62.8% reduction of Zinc is required. This reduction in Pollutant Load from 72% to 62.8% translates to 0.21 acre-feet mitigation of stormwater, which brings this WMP Group into compliance with interim milestones in this Permit term.

The WMP Group will determine the need for additional structural BMPs based on the results of monitoring identified in the CIMP. The CIMP presents a phased monitoring approach of:

1. Identifying receiving water quality of commingled discharges
2. If commingled discharges lead to exceedances of WLAs, then a County specific monitoring program will be implemented

3. If County specific discharges produce exceedances of WLAs, structural BMPs will be planned and implemented contingent upon available funding.
4. Upon effectiveness monitoring of potential BMPs, monitoring of the County Island would cease.

Figure 19 presents a flow chart outlining the WMP Group’s approach. Implementation of the future monitoring is dependent upon LARWQCB approval of appropriate CIMPs and is subject to change. Details on monitoring can be found in the AB/LCC CIMP.

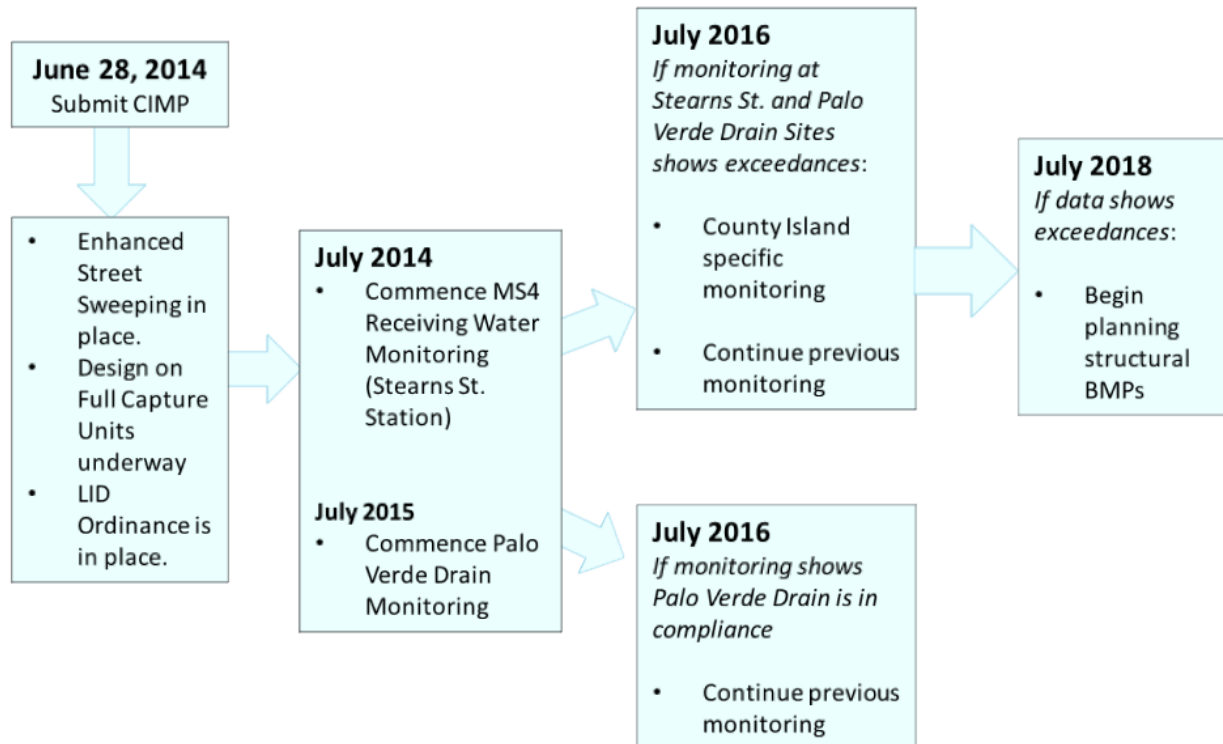

Figure 19: County’s Compliance Approach

Notable compliance milestones are presented below:

- September 2017: 30% dry weather, 10% wet weather reduction (LCC Metals TMDL)
- September 2020: 70% dry weather, 35% wet weather (LCC Metals TMDL)
- September 2023: 100% dry weather, 65% wet weather (LCC Metals TMDL)
- September 2026 Final Compliance (LCC Metals TMDL)
- March 2032 Final Compliance (DC Toxics TMDL)

Through the RAA process this WMP Group has identified potential structural BMPs locations including roadway parkways and the LACFCD’s right of way along the Palo Verde Drain. The implementation of a selected structural BMP is subject to its necessity based on water quality monitoring as well as the availability of adequate funding.

Section 7. Stakeholder Input

On April 30, 2014, this WMP Group partnered with the Lower San Gabriel River and Los Cerritos Channel Groups to host a stakeholder outreach meeting. The purpose of the meeting was to provide Stakeholders an update on the WMP/CIMP planning process and allow Stakeholders to provide input on the plans. In general, the three watershed groups received positive remarks from the Stakeholders. The notification which was sent to appropriate stakeholders is shown in Figure 20.

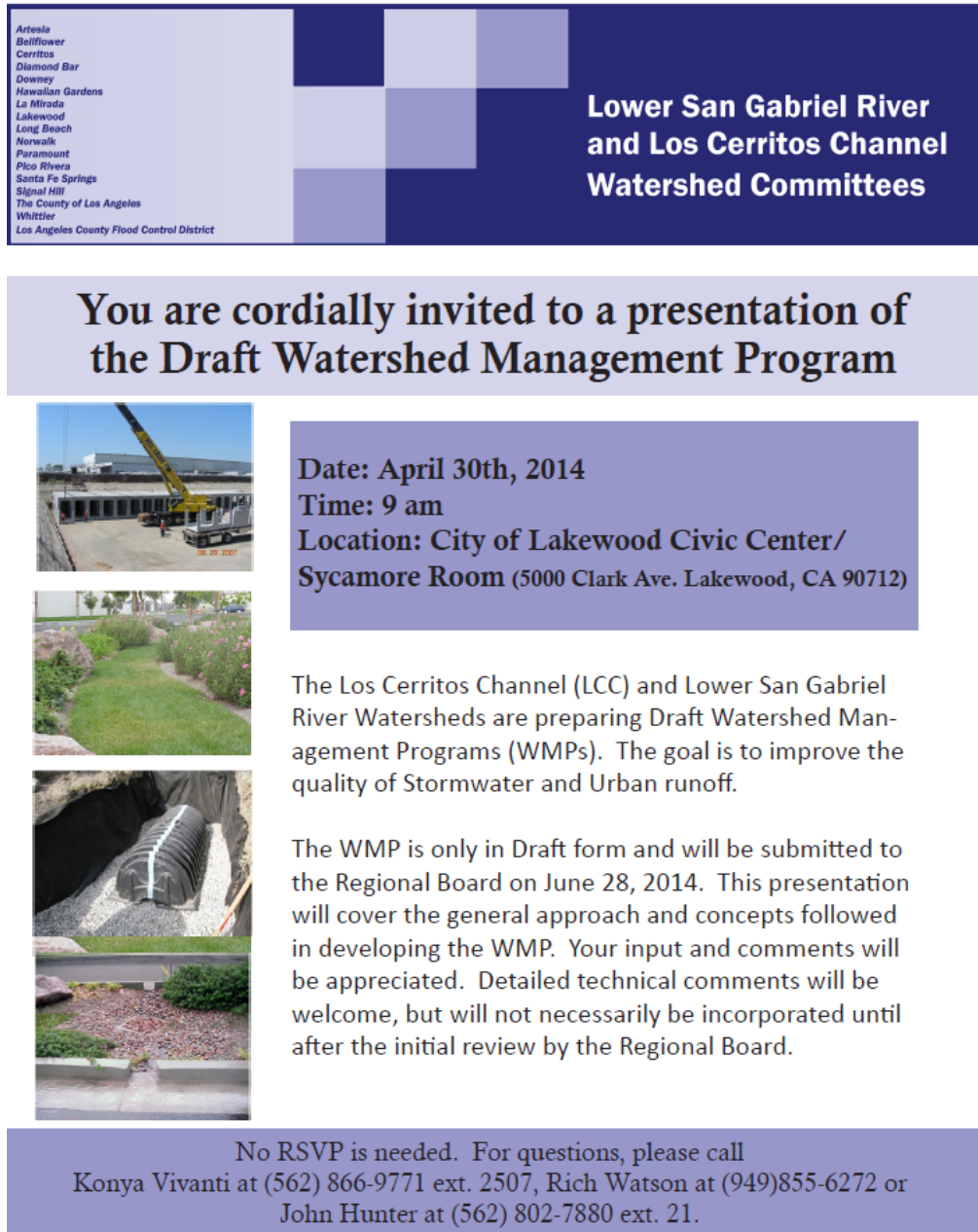

The graphic is a stakeholder outreach notification. At the top, it features a dark blue header with a grid pattern. On the left side of the header, a list of participating organizations is provided: Artesia, Bellflower, Cerritos, Diamond Bar, Downey, Hawaiian Gardens, La Mirada, Lakewood, Long Beach, Norwalk, Paramount, Pico Rivera, Santa Fe Springs, Signal Hill, The County of Los Angeles, Whittier, and Los Angeles County Flood Control District. On the right side of the header, the text reads "Lower San Gabriel River and Los Cerritos Channel Watershed Committees". Below the header is a light blue banner with the text "You are cordially invited to a presentation of the Draft Watershed Management Program". To the left of the main text area are three small images: a construction site with a crane, a garden with various plants, and a stormwater management structure. To the right of these images is a dark blue box containing the event details: "Date: April 30th, 2014", "Time: 9 am", and "Location: City of Lakewood Civic Center/ Sycamore Room (5000 Clark Ave. Lakewood, CA 90712)". Below this box is a paragraph of text explaining the purpose of the draft WMPs and the goal of improving stormwater and urban runoff. Another paragraph explains that the WMP is in draft form and will be submitted to the Regional Board on June 28, 2014, and that the presentation will cover the general approach and concepts. At the bottom of the graphic is a dark blue box with the text: "No RSVP is needed. For questions, please call Konya Vivanti at (562) 866-9771 ext. 2507, Rich Watson at (949)855-6272 or John Hunter at (562) 802-7880 ext. 21."

Artesia
Bellflower
Cerritos
Diamond Bar
Downey
Hawaiian Gardens
La Mirada
Lakewood
Long Beach
Norwalk
Paramount
Pico Rivera
Santa Fe Springs
Signal Hill
The County of Los Angeles
Whittier
Los Angeles County Flood Control District

**Lower San Gabriel River
and Los Cerritos Channel
Watershed Committees**

**You are cordially invited to a presentation of
the Draft Watershed Management Program**

**Date: April 30th, 2014
Time: 9 am
Location: City of Lakewood Civic Center/
Sycamore Room (5000 Clark Ave. Lakewood, CA 90712)**

The Los Cerritos Channel (LCC) and Lower San Gabriel River Watersheds are preparing Draft Watershed Management Programs (WMPs). The goal is to improve the quality of Stormwater and Urban runoff.

The WMP is only in Draft form and will be submitted to the Regional Board on June 28, 2014. This presentation will cover the general approach and concepts followed in developing the WMP. Your input and comments will be appreciated. Detailed technical comments will be welcome, but will not necessarily be incorporated until after the initial review by the Regional Board.

No RSVP is needed. For questions, please call Konya Vivanti at (562) 866-9771 ext. 2507, Rich Watson at (949)855-6272 or John Hunter at (562) 802-7880 ext. 21.

Figure 20: Stakeholder Outreach Notification

Section 8. Adaptive Management Process

8.1 OBJECTIVE

Per Section VI.C.8 of the Permit, this WMP Group will implement an adaptive management process every two years from the approval date of the WMP. The adaptive management process will allow the WMP to become more effective and is based on considerations such as:

- Progress toward achieving interim and/or final water-quality based effluent limitations and/or receiving water limitations, according to established compliance schedules
- Progress towards achieving improved water quality in MS4 discharges and achieving receiving water limitations through implementation of the watershed control measures based on an evaluation of outfall-based monitoring data and receiving water monitoring data
- Achievement of interim milestones
- Re-evaluation of the water quality priorities based on more recent water quality data
- Availability of new information from other sources
- Recommendations from the LARWQCB
- Recommendations made during the public participation process for the WMP

A key component of adaptive management is the results from this Group's CIMP. This process will be implemented every two years and any modifications to the WMP will be reported in the permittees' Annual Report.

Additionally, the LACFCD doesn't have jurisdiction of the land uses that create the pollutants of concern in the Colorado Lagoon, Alamitos Bay, San Pedro Bay and Los Cerritos Channel Estuary watersheds. These areas are under the jurisdiction of the City of Long Beach and will be addressed under Long Beach's WMP which will be submitted in March 2015. Through adaptive management, the LACFCD will review Long Beach's WMP and consider on a case-by-case basis opportunities for collaboration on future projects.

Section 9. Reporting

9.1 ANNUAL MONITORING REPORT

Monitoring results for this Group's CIMP will be reported semi-annually to the LARWCB. On December 15th of each year, an annual report will be submitted to the LARWCQB summarizing the monitoring through June 30th. Details of the Annual Monitoring Report can be found this Group's CIMP.

Section 10. References

Los Angeles Regional Water Quality Control Board, “Final Waste Discharge Requirements for Municipal Separate Storm Sewer System (MS4) Discharges within the Coastal Watersheds of Los Angeles County, Except Those Discharges Originating from the City of Long Beach MS4 (posted December 5, 2012)”. Final Order R4-2012-0175, http://www.waterboards.ca.gov/losangeles/water_issues/programs/stormwater/municipal/index.shtml (November 2013)

State of California Water Resources Control Board. “2010 Integrated Report (Clean Water Act Section 303(d) List” April 2010, http://www.waterboards.ca.gov/water_issues/programs/tmdl/integrated2010.shtml. (January 2014)

Los Angeles Regional Water Quality Control Board, “Total Maximum Daily Load for Toxic Pollutants in Dominguez Channel and Greater Los Angeles and Long Beach Harbor Waters”. Resolution No. R11-008, Effective Date: March 23, 2012, http://www.waterboards.ca.gov/losangeles/board_decisions/basin_plan_amendments/technical_documents/bpa_66_R11-008_td.shtml (June 2013)

Anchor QEA, L.P., “Coordinated Compliance, Monitoring, and Reporting Plan Incorporating Quality Assurance Project Plan Components” June, 2013, http://www.waterboards.ca.gov/losangeles/board_decisions/basin_plan_amendments/technical_documents/66_New/09232013/1aDraftCCMRP62413.pdf (January 2014)

United States Environmental Protection Agency, “Los Cerritos Channel Total Maximum Daily Loads for Metals”. March 2010

Los Angeles Regional Water Quality Control Board, “Total Maximum Daily Load for Organochlorine (OC) Pesticides, Polychlorinated Biphenyls (PCBs), Sediment Toxicity, Polycyclic Aromatic Hydrocarbons (PAHs), and Metals for Colorado Lagoon”. Resolution No. R09-05, Adopted Date: October 1, 2009, http://www.waterboards.ca.gov/losangeles/board_decisions/basin_plan_amendments/technical_documents/bpa_65_R09-005_td.shtml (January 2014)

Kinnetic Laboratories, Inc., “Final Colorado Lagoon TMDL Monitoring Plan (CLTMP) Colorado Lagoon Organochlorine Pesticides, PCBs, Sediment Toxicity, PAHs, and Metals TMDL” December, 2012

Los Cerritos Channel Watershed Group, “Los Cerritos Channel Watershed Management Program” January 2015

County of Los Angeles, “Multi-Pollutant TMDL Implementation Plan for the Unincorporated County Area of Ballona Creek” October 2010

County of Los Angeles Department of Public Works, “Low Impact Development Standards Manual” February 2014,

<http://dpw.lacounty.gov/idd/lib/fp/Hydrology/Low%20Impact%20Development%20Standards%20Manual.pdf> (May 2014)

State Water Resources Control Board, “Draft Amendments to Statewide Water Quality Control Plans to Control Trash, Draft Staff Report”. June 2014

Center for Watershed Protection. Research in Support of an Interim Pollutant Removal Rate for Street Sweeping and Storm Drain Cleanout Activities. Technical Memorandum 1 – Literature Review: Final Draft. October 2006.

California Regional Water Quality Control Board Los Angeles Region, “Water Quality Control Plan Los Angeles Region – Basin Plan for the Coastal Watersheds of Los Angeles and Ventura Counties”

APPENIDX A. LACFCD Background Information

In 1915, the Los Angeles County Flood Control Act established the LACFCD and empowered it to manage flood risk and conserve stormwater for groundwater recharge. In coordination with the United States Army Corps of Engineers, the LACFCD developed and constructed a comprehensive system that provides for the regulation and control of flood waters through the use of reservoirs and flood channels. The system also controls debris, collects surface storm water from streets, and replenishes groundwater with storm water and imported and recycled waters. The LACFCD covers the 2,753 square-mile portion of Los Angeles County south of the east-west projection of Avenue S, excluding Catalina Island. It is a special district governed by the County of Los Angeles Board of Supervisors, and its functions are carried out by the Los Angeles County Department of Public Works. The LACFCD service area is shown in Figure A-1.

Unlike cities and counties, the LACFCD does not own or operate any municipal sanitary sewer systems, public streets, roads, or highways. The LACFCD operates and maintains storm drains and other appurtenant drainage infrastructure within its service area. The LACFCD has no planning, zoning, development permitting, or other land use authority within its service area. The permittees that have such land use authority are responsible under the Permit for inspecting and controlling pollutants from industrial and commercial facilities, development projects, and development construction sites. (Permit, Part II.E, p. 17.)

The MS4 Permit language clarifies the unique role of the LACFCD in storm water management programs:

“[g]iven the LACFCD’s limited land use authority, it is appropriate for the LACFCD to have a separate and uniquely-tailored storm water management program. Accordingly, the storm water management program minimum control measures imposed on the LACFCD in Part VI.D of this Order differ in some ways from the minimum control measures imposed on other Permittees. Namely, aside from its own properties and facilities, the LACFCD is not subject to the Industrial/Commercial Facilities Program, the Planning and Land Development Program, and the Development Construction Program. However, as a discharger of storm and non-storm water, the LACFCD remains subject to the Public Information and Participation Program and the Illicit Connections and Illicit Discharges Elimination Program. Further, as the owner and operator of certain properties, facilities and infrastructure, the LACFCD remains subject to requirements of a Public Agency Activities Program.” (Permit, Part II.F, p. 18.)

Consistent with the role and responsibilities of the LACFCD under the Permit, the [E]WMPs and CIMPs reflect the opportunities that are available for the LACFCD to collaborate with permittees having land use authority over the subject watershed area. In some instances, the opportunities are minimal, however the LACFCD remains responsible for compliance with certain aspects of the MS4 permit as discussed above.

As part of the WMP planning process, LACFCD infrastructure was considered for potential project opportunities. However, because of the LACFCD's limited land use authority discussed above, the responsible jurisdictions with land use jurisdiction over the WMP area will be the lead for the development of any structural controls.

In some instances, in recognition of the increased efficiency of implementing certain programs regionally, the LACFCD has committed to responsibilities above and beyond its obligations under the 2012 Permit. For example, although under the 2012 Permit the Public Information and Participation Program is a responsibility of each Permittee, the LACFCD is committed to implementing certain regional elements of the PIPP on behalf of all Permittees at no cost to the Permittees. These regional elements include:

- Maintaining a countywide hotline (888-CLEAN-LA) and website (www.888cleanla.com) for public reporting and general stormwater management information at an estimated annual cost of \$250,000. Each Permittee can utilize this hotline and website for public reporting within its jurisdiction.
- Broadcasting public service announcements and conducting regional advertising campaigns at an estimated annual cost of \$750,000.
- Facilitating the dissemination of public education and activity specific stormwater pollution prevention materials at an estimated annual cost of \$100,000.
- Maintaining a stormwater website at an estimated annual cost of \$10,000.

The LACFCD will implement these elements on behalf of all Permittees starting July 2015 and through the Permit term. With the LACFCD handling these elements regionally, Permittees can better focus on implementing local or watershed-specific programs, including student education and community events, to fully satisfy the PIPP requirements of the 2012 Permit.

Similarly, although water quality monitoring is a responsibility of each Permittee under the 2012 Permit, the LACFCD is committed to implementing certain regional elements of the monitoring program. Specifically, the LACFCD will continue to conduct monitoring at the seven existing mass emissions stations required under the previous Permit. The LACFCD will also participate in the Southern California Stormwater Monitoring Coalition's Regional Bioassessment Program on behalf of all Permittees. By taking on these additional responsibilities, the LACFCD wishes to increase the efficiency and effectiveness of these programs.



Figure A-1 Los Angeles County Flood Control District Service Area

[This page intentionally left blank]

APPENIDX B. Water Qualities Priorities

SUMMARY

Wet weather and dry weather samples between 2003 and 2013 at the Stearns Street MES were compared to applicable numeric limits in the Los Angeles Basin Plan, California Ocean Plan, California Toxics Rule or California Fish and Game. The Permit states that parameters in Table E-2 shall be monitored in the first year of monitoring and if a parameter is not detected at the MDL or if the result is below the lowest applicable water quality objective, it need not be further analyzed. It's important to note that some of the laboratory reporting limits (RLs) were above the limits used for a number of constituents. Those samples were not counted as being above the numeric limits in this analysis.

TABLE B.1 – WET WEATHER SAMPLES ABOVE NUMERIC TARGETS

CONSTITUENTS	NO. OF SAMPLES ABOVE ML	TOTAL NO. OF SAMPLES
Aroclors		
Aroclor 1016	0	34
Aroclor 1221	0	34
Aroclor 1232	0	34
Aroclor 1242	0	34
Aroclor 1248	0	34
Aroclor 1254	0	26
Aroclor 1260	0	34
Chlorinated Pesticides		
4,4'-DDT	0	34
Aldrin	0	34
Dieldrin	0	34
Endosulfan I	0	34
Endosulfan II	0	34
Endrin	0	34
gamma-BHC (Lindane)	0	34
Heptachlor	0	34
Heptachlor epoxide	0	34
Total Chlordane ¹	--	34
Toxaphene	0	34
Conventionals		
MBAS	3	34
Nitrate (as N)	0	33
Nitrite (as N)	0	33
Total Ammonia (as N) ¹	--	34
Dissolved Metals (CTR Fresh CMC)*		
Arsenic	0	34
Cadmium	0	34
Copper	31	34
Lead	0	34
Nickel	0	34
Silver	1	34
Zinc	24	34
Microbiology		
Enterococcus	32	32
Fecal Coliform	31	32
Total Coliform	30	32
Organophosphates (CFG FRESH CMC)		
Chlorpyrifos	2	34
Total Metals		
Aluminum	30	34
Arsenic	0	34
Cadmium	1	34
Chromium	1	34
Nickel	0	34
Selenium	0	34

TABLE B.2 – DRY WEATHER SAMPLES ABOVE NUMERIC TARGETS

CONSTITUENTS	NO. OF SAMPLES ABOVE ML	TOTAL NO. OF SAMPLES
Aroclors		
Aroclor 1016	0	20
Aroclor 1221	0	20
Aroclor 1232	0	20
Aroclor 1242	0	20
Aroclor 1248	0	20
Aroclor 1254	0	20
Aroclor 1260	0	20
Chlorinated Pesticides		
4,4'-DDT	0	20
Aldrin	0	20
Dieldrin	0	20
Endosulfan I	0	20
Endosulfan II	0	20
Endrin	0	20
gamma-BHC (Lindane)	0	20
Heptachlor	0	20
Heptachlor epoxide	0	20
Total Chlordane ¹	--	20
Toxaphene	0	20
Conventionals		
MBAS	1	20
Nitrate (as N)	0	20
Nitrite (as N)	0	20
Total Ammonia (as N) ¹	--	20
Dissolved Metals (CTR Fresh CMC)		
Arsenic	0	20
Cadmium	0	20
Copper	8	20
Lead	0	20
Nickel	0	20
Silver	0	20
Zinc	0	20
Microbiology		
Enterococcus	18	20
Fecal Coliform	12	20
Total Coliform	9	20
Organophosphates (CFG FRESH CMC)		
Chlorpyrifos	0	20
Diazinon	2	20
Total Metals		
Aluminum	1	20
Arsenic	0	20
Cadmium	0	20
Chromium	0	20
Nickel	0	20

CONSTITUENTS	NO. OF SAMPLES ABOVE ML	TOTAL NO. OF SAMPLES
Selenium	0	20

¹ Refer to the Los Cerritos Channel Watershed Management Group CIMP for analysis of exceedances.

APPENIDX C. County of Los Angeles Legal Authority



COUNTY OF LOS ANGELES
OFFICE OF THE COUNTY COUNSEL

648 KENNETH HAHN HALL OF ADMINISTRATION
500 WEST TEMPLE STREET
LOS ANGELES, CALIFORNIA 90012-2713

TELEPHONE
(213) 974-1923
FACSIMILE
(213) 687-7337
TDD
(213) 633-0901

JOHN F. KRATTLI
County Counsel

December 16, 2013

Mr. Samuel Unger, P.E., Executive Officer
California Regional Water Quality Control Board – Los Angeles Region
320 West 4th Street, Suite 200
Los Angeles, CA 90013-2343

Attention: Mr. Ivar Ridgeway

**Re: Certification By Legal Counsel For County of Los Angeles'
Annual Report**

Dear Mr. Unger:

Pursuant to the requirements of Part VI(A)(2)(b) of Order No. R4-2012-0175 (the "Order"), the Office of the County Counsel of the County of Los Angeles makes the following certification in support of the Annual Report of the County of Los Angeles ("County"):

Certification Pursuant To Order Part VI(A)(2)(b)

"Each Permittee must submit a statement certified by its chief legal counsel that the Permittee has the legal authority within its jurisdiction to implement and enforce the requirements contained in 40 CFR §122.26(d)(2)(i)(A-F) and this Order."

The County has the legal authority within its jurisdiction to implement and enforce each of the requirements contained in 40 CFR §122.26(d)(2)(i)(A-F) and the Order.

Order Part VI(A)(2)(b)(i)

"Citation of applicable municipal ordinances or other appropriate legal authorities and their relationship to the requirements of 40 CFR §122.26(d)(2)(i)(A-F) and this Order"

Citations Of Applicable Ordinances Or Other Legal Authorities

Although many portions of State law, the Charter of the County of Los Angeles and the Los Angeles County Code are potentially applicable to the implementation and enforcement of these requirements, the primary applicable laws and ordinances are as follows:

Los Angeles County Code, Title 12, Chapter 12.80 STORMWATER AND RUNOFF POLLUTION CONTROL, including:

§12.80.010 - §12.80.360 Definitions

§12.80.370 Short title.

§12.80.380 Purpose and intent.

§12.80.390 Applicability of this chapter.

§12.80.400 Standards, guidelines and criteria.

§12.80.410 Illicit discharges prohibited.

§12.80.420 Installation or use of illicit connections prohibited.

§12.80.430 Removal of illicit connection from the storm drain system.

§12.80.440 Littering and other discharge of polluting or damaging substances prohibited.

§12.80.450 Stormwater and runoff pollution mitigation for construction activity.

§12.80.460 Prohibited discharges from industrial or commercial activity.

§12.80.470 Industrial/commercial facility sources required to obtain a NPDES permit.

§12.80.480 Public facility sources required to obtain a NPDES permit.

§12.80.490 Notification of uncontrolled discharges required.

§12.80.500 Good housekeeping provisions.

§12.80.510 Best management practices for construction activity.

- §12.80.520 Best management practices for industrial and commercial facilities.
- §12.80.530 Installation of structural BMPs.
- §12.80.540 BMPs to be consistent with environmental goals.
- §12.80.550 Enforcement—Director's powers and duties.
- §12.80.560 Identification for inspectors and maintenance personnel.
- §12.80.570 Obstructing access to facilities prohibited.
- §12.80.580 Inspection to ascertain compliance—Access required.
- §12.80.590 Interference with inspector prohibited.
- §12.80.600 Notice to correct violations—Director may take action.
- §12.80.610 Violation a public nuisance.
- §12.80.620 Nuisance abatement—Director to perform work when—Costs.
- §12.80.630 Violation—Penalty.
- §12.80.635 Administrative fines.
- §12.80.640 Penalties not exclusive.
- §12.80.650 Conflicts with other code sections.
- §12.80.660 Severability.
- §12.80.700 Purpose.
- §12.80.710 Applicability.
- §12.80.720 Registration required.
- §12.80.730 Exempt facilities.
- §12.80.740 Certificate of inspection—Issuance by the director.
- §12.80.750 Certificate of inspection—Suspension or revocation.

§12.80.760 Certificate of inspection—Termination.

§12.80.770 Service fees.

§12.80.780 Fee schedule.

§12.80.790 Credit for overlapping inspection programs.

§12.80.800 Annual review of fees.

Los Angeles County Code, Title 12, Chapter 12.84 LOW IMPACT
DEVELOPMENT STANDARDS, including:

§12.84.410 Purpose.

§12.84.420 Definitions.

§12.84.430 Applicability.

§12.84.440 Low Impact Development Standards.

§12.84.445 Hydromodification Control.

§12.84.450 LID Plan Review.

§12.84.460 Additional Requirements.

Los Angeles County Code, Title 22 PLANNING AND ZONING, Part 6
ENFORCEMENT PROCEDURES, including:

§22.60.330 General prohibitions.

§22.60.340 Violations.

§22.60.350 Public nuisance.

§22.60.360 Infractions.

§22.60.370 Injunction.

§22.60.380 Enforcement.

§22.60.390 Zoning enforcement order and noncompliance fee.

Los Angeles County Code, Title 26 BUILDING CODE, including:

§26.103 Violations And Penalties

§26.104 Organization And Enforcement

§26.105 Appeals Boards

§26.106 Permits

§26.107 Fees

§26.108 Inspections

California Government Code §6502

California Government Code §23004

Relationship Of Applicable Ordinances Or Other Legal Authorities To
 The Requirements of 40 CFR §122.26(d)(2)(i)(A-F) And The Order

Although, depending upon the particular issue, there may be multiple ways in which particular sections of the County's ordinances and State law relate to the requirements contained in 40 CFR §122.26(d)(2)(i)(A-F) and the Order, the table below indicates the basic relationship with Part VI(A)(2)(a) of the Order:

Order Part VI(A)(2)(a) Items	Primary Applicable Ordinance/Statute
i. Control the contribution of pollutants to its MS4 from storm water discharges associated with industrial and construction activity and control the quality of storm water discharged from industrial and construction sites. This requirement applies both to industrial and construction sites with coverage under an NPDES permit, as well as to those sites that do not have coverage under an NPDES permit.	§12.80.410 [illicit discharge prohibited]; §12.80.450 [construction] §12.80.460 [industrial and commercial] §12.80.470 and .480 [industrial and commercial NPDES requirements] §12.84.440 [LID standards] §12.84.445 [hydromodification control] §12.84.450 [LID Plan Review] §22.60.330 [general prohibitions]

Order Part VI(A)(2)(a) Items	Primary Applicable Ordinance/Statute
	§22.60.340 [violations] §22.60.350 [public nuisance] §22.60.360 [infractions] §22.60.370 [injunction] §22.60.380 [enforcement.] §22.60.390 [zoning enforcement order] §26.103 [violations and penalties] §26.104 [enforcement] §26.106 [permits] §26.108 [inspections]
ii. Prohibit all non-storm water discharges through the MS4 to receiving waters not otherwise authorized or conditionally exempt pursuant to Part III.A.	§12.80.410 [illicit discharge prohibited]
iii. Prohibit and eliminate illicit discharges and illicit connections to the MS4.	§12.80.410 [illicit discharge prohibited]; §12.80.420 [illicit connections prohibited]
iv. Control the discharge of spills, dumping, or disposal of materials other than storm water to its MS4.	§12.80.410 [illicit discharge prohibited]; §12.80.440 [littering and other polluting prohibited]

Order Part VI(A)(2)(a) Items	Primary Applicable Ordinance/Statute
v. Require compliance with conditions in Permittee ordinances, permits, contracts or orders (i.e., hold dischargers to its MS4 accountable for their contributions of pollutants and flows).	§12.80.490 [notification of uncontrolled discharge] §12.80.570 [obstructing access to facilities] §12.80.580 [compliance inspection] §12.80.610 [violation a nuisance] §12.620 [nuisance abatement] §12.80.635 [violation penalty] §12.80.640 [penalties not exclusive] §12.84.440 [LID standards] §12.84.445 [hydromodification control] §12.84.450 [LID Plan Review] §22.60.330 [general prohibitions] §22.60.340 [violations] §22.60.350 [public nuisance] §22.60.360 [infractions] §22.60.370 [injunction] §22.60.380 [enforcement.] §22.60.390 [zoning enforcement order] §26.103 [violations and penalties] §26.104 [enforcement] §26.106 [permits] §26.108 [inspections]
vi. Utilize enforcement mechanisms to require compliance with applicable ordinances, permits, contracts, or orders.	Same as item v., above

Order Part VI(A)(2)(a) Items	Primary Applicable Ordinance/Statute
vii. Control the contribution of pollutants from one portion of the shared MS4 to another portion of the MS4 through interagency agreements among Copermittees.	California Government Code §6502 and §23004
viii. Control of the contribution of pollutants from one portion of the shared MS4 to another portion of the MS4 through interagency agreements with other owners of the MS4 such as the State of California Department of Transportation.	California Government Code §6502 and §23004
ix. Carry out all inspections, surveillance, and monitoring procedures necessary to determine compliance and noncompliance with applicable municipal ordinances, permits, contracts and orders, and with the provisions of this Order, including the prohibition of non-storm water discharges into the MS4 and receiving waters. This means the Permittee must have authority to enter, monitor, inspect, take measurements, review and copy records, and require regular reports from entities discharging into its MS4.	§12.80.490 [notification of uncontrolled discharge] §12.80.570 [obstructing access to facilities] §12.80.580 [compliance inspection] §12.80.610 [violation a nuisance] §12.80.620 [nuisance abatement] §12.80.635 [violation penalty] §12.80.640 [penalties not exclusive] §22.60.380 [enforcement.] §26.106 [permits] §26.108 [inspections]

Order Part VI(A)(2)(a) Items	Primary Applicable Ordinance/Statute
<p>x. Require the use of control measures to prevent or reduce the discharge of pollutants to achieve water quality standards/receiving water limitations.</p>	<p>§12.80.450 [construction mitigation] §12.80.500 [good housekeeping practices] §12.80.510 [construction BMPs] §12.80.520 [industrial/commercial BMPs] §12.84.440 [LID standards] §12.84.450 [LID Plan Review] §22.60.330 [general prohibitions] §22.60.380 [enforcement.] §22.60.390 [zoning enforcement order] §26.106 [permits] §26.108 [inspections]</p>
<p>xi. Require that structural BMPs are properly operated and maintained.</p>	<p>§12.80.530 [installation of structural BMPs] §22.60.380 [enforcement.] §22.60.390 [zoning enforcement order] §26.106 [permits] §26.108 [inspections]</p>
<p>xii. Require documentation on the operation and maintenance of structural BMPs and their effectiveness in reducing the discharge of pollutants to the MS4.</p>	<p>§12.80.530 [installation of structural BMPs] §22.60.380 [enforcement.] §22.60.390 [zoning enforcement order] §26.106 [permits] §26.108 [inspections]</p>

Order Part VI(A)(2)(b)(ii)

"Identification of the local administrative and legal procedures available to mandate compliance with applicable municipal ordinances identified in subsection (i) above and therefore with the conditions of this Order, and a statement as to whether enforcement actions can be completed administratively or whether they must be commenced and completed in the judicial system."

The local administrative and legal procedures available to mandate compliance with the above ordinances are specified in those ordinances, particularly in:

- §12.80.550 Enforcement—Director's powers and duties.
- §12.80.600 Notice to correct violations—Director may take action.
- §12.80.610 Violation a public nuisance.
- §12.80.620 Nuisance abatement—Director to perform work when—Costs.
- §12.80.630 Violation—Penalty.
- §12.80.635 Administrative fines.
- §12.80.640 Penalties not exclusive.
- §12.84.450 LID Plan Review.
- §12.84.460 Additional Requirements.
- Title 26, §103 Violations And Penalties
- Title 26, §104 Organization And Enforcement
- Title 26, §105 Appeals Boards
- Title 26, §106 Permits

- Title 22 PLANNING AND ZONING, Part 6 ENFORCEMENT PROCEDURES, including:
 - §22.60.330 General prohibitions.

§22.60.340 Violations.

§22.60.350 Public nuisance.

§22.60.360 Infractions.

§22.60.370 Injunction.

§22.60.380 Enforcement.

§22.60.390 Zoning enforcement order and noncompliance fee.

The County attempts to first resolve each enforcement action administratively. However, the above cited ordinances also provide the County with the authority to pursue such actions in the judicial system as necessary.

Very truly yours,

JOHN F. KRATTLI
County Counsel

By 
JUDITH A. FRIES
Principal Deputy County Counsel
Public Works Division

JAF:jjj

APPENIDX D. LACFCD Legal Authority



COUNTY OF LOS ANGELES
OFFICE OF THE COUNTY COUNSEL

648 KENNETH HAHN HALL OF ADMINISTRATION
500 WEST TEMPLE STREET
LOS ANGELES, CALIFORNIA 90012-2713

TELEPHONE
(213) 974-1923
FACSIMILE
(213) 687-7337
TDD
(213) 633-0901

JOHN F. KRATTLI
County Counsel

December 16, 2013

Mr. Samuel Unger, P.E., Executive Officer
California Regional Water Quality Control Board – Los Angeles Region
320 West 4th Street, Suite 200
Los Angeles, CA 90013-2343

Attention: Mr. Ivar Ridgeway

**Re: Certification By Legal Counsel For Los Angeles County Flood
Control District's Annual Report**

Dear Mr. Unger:

Pursuant to the requirements of Part VI(A)(2)(b) of Order No. R4-2012-0175 (the "Order"), the Office of the County Counsel of the County of Los Angeles makes the following certification in support of the Annual Report of the Los Angeles County Flood Control District ("LACFCD"):

Certification Pursuant To Order Part VI(A)(2)(b)

"Each Permittee must submit a statement certified by its chief legal counsel that the Permittee has the legal authority within its jurisdiction to implement and enforce the requirements contained in 40 CFR §122.26(d)(2)(i)(A-F) and this Order."

LACFCD has the legal authority within its jurisdiction to implement and enforce each of the requirements contained in 40 CFR §122.26(d)(2)(i)(A-F) and the Order.

Order Part VI(A)(2)(b)(i)

"Citation of applicable municipal ordinances or other appropriate legal authorities and their relationship to the requirements of 40 CFR §122.26(d)(2)(i)(A-F) and this Order"

Citations Of Applicable Ordinances Or Other Legal Authorities

Although many portions of State law, the Charter of the County of Los Angeles, the Los Angeles County Code and LACFCD's Flood Control District Code ("Code") are potentially applicable to the implementation and enforcement of these requirements, the primary applicable laws and ordinances are as follows:

Los Angeles County Code, Title 12, Chapter 12.80 STORMWATER AND RUNOFF POLLUTION CONTROL, including:

§12.80.010 - §12.80.360 Definitions

§12.80.370 Short title.

§12.80.380 Purpose and intent.

§12.80.390 Applicability of this chapter.

§12.80.400 Standards, guidelines and criteria.

§12.80.410 Illicit discharges prohibited.

§12.80.420 Installation or use of illicit connections prohibited.

§12.80.430 Removal of illicit connection from the storm drain system.

§12.80.440 Littering and other discharge of polluting or damaging substances prohibited.

§12.80.450 Stormwater and runoff pollution mitigation for construction activity.

§12.80.460 Prohibited discharges from industrial or commercial activity.

§12.80.470 Industrial/commercial facility sources required to obtain a NPDES permit.

§12.80.480 Public facility sources required to obtain a NPDES permit.

§12.80.490 Notification of uncontrolled discharges required.

§12.80.500 Good housekeeping provisions.

§12.80.510 Best management practices for construction activity.

- §12.80.520 Best management practices for industrial and commercial facilities.
- §12.80.530 Installation of structural BMPs.
- §12.80.540 BMPs to be consistent with environmental goals.
- §12.80.550 Enforcement—Director's powers and duties.
- §12.80.560 Identification for inspectors and maintenance personnel.
- §12.80.570 Obstructing access to facilities prohibited.
- §12.80.580 Inspection to ascertain compliance—Access required.
- §12.80.590 Interference with inspector prohibited.
- §12.80.600 Notice to correct violations—Director may take action.
- §12.80.610 Violation a public nuisance.
- §12.80.620 Nuisance abatement—Director to perform work when—Costs.
- §12.80.630 Violation—Penalty.
- §12.80.635 Administrative fines.
- §12.80.640 Penalties not exclusive.
- §12.80.650 Conflicts with other code sections.
- §12.80.660 Severability.
- §12.80.700 Purpose.
- §12.80.710 Applicability.
- §12.80.720 Registration required.
- §12.80.730 Exempt facilities.
- §12.80.740 Certificate of inspection—Issuance by the director.
- §12.80.750 Certificate of inspection—Suspension or revocation.

§12.80.760 Certificate of inspection—Termination.

§12.80.770 Service fees.

§12.80.780 Fee schedule.

§12.80.790 Credit for overlapping inspection programs.

§12.80.800 Annual review of fees.

Los Angeles County Code, Title 12, Chapter 12.84 LOW IMPACT
DEVELOPMENT STANDARDS, including:

§12.84.410 Purpose.

§12.84.420 Definitions.

§12.84.430 Applicability.

§12.84.440 Low Impact Development Standards.

§12.84.445 Hydromodification Control.

§12.84.450 LID Plan Review.

§12.84.460 Additional Requirements.

Los Angeles County Code, Title 22 PLANNING AND ZONING, Part 6
ENFORCEMENT PROCEDURES, including:

§22.60.330 General prohibitions.

§22.60.340 Violations.

§22.60.350 Public nuisance.

§22.60.360 Infractions.

§22.60.370 Injunction.

§22.60.380 Enforcement.

§22.60.390 Zoning enforcement order and noncompliance fee.

Los Angeles County Code, Title 26 BUILDING CODE, including:

§26.103 Violations And Penalties

§26.104 Organization And Enforcement

§26.105 Appeals Boards

§26.106 Permits

§26.107 Fees

§26.108 Inspections

LACFCD Code Chapter 21 - STORMWATER AND RUNOFF
POLLUTION CONTROL including:

§21.01 Purpose and Intent

§21.03 Definitions

§21.05 Standards, Guidelines, and Criteria

§21.07 Prohibited Discharges

§21.09 Installation or Use of Illicit Connections Prohibited

§21.11 Littering Prohibited

§21.13 Evidence of Compliance With Permit Requirements for Industrial
or Commercial Activity

§21.15 Notification of Uncontrolled Discharges Required

§21.17 Requirement to Monitor and Analyze

§21.19 Conflicts With Other Code Sections

§21.21 Severability

§21.23 Violation a Public Nuisance

California Government Code §6502

California Government Code §23004

California Water Code §8100 *et. seq.*

Relationship Of Applicable Ordinances Or Other Legal Authorities To
 The Requirements of 40 CFR §122.26(d)(2)(i)(A-F) And The Order

Although, depending upon the particular issue, there may be multiple ways in which particular sections of the County of Los Angeles' ordinances, LACFCD's ordinances, and statutes relate to the requirements contained in 40 CFR §122.26(d)(2)(i)(A-F) and the Order, the table below indicates the basic relationship with Part VI(A)(2)(a) of the Order:

Order Part VI(A)(2)(a) Items	Primary Applicable Ordinance/Statute
<p>i. Control the contribution of pollutants to its MS4 from storm water discharges associated with industrial and construction activity and control the quality of storm water discharged from industrial and construction sites. This requirement applies both to industrial and construction sites with coverage under an NPDES permit, as well as to those sites that do not have coverage under an NPDES permit.</p>	<p>Los Angeles County Code: §12.80.410 [illicit discharge prohibited]; §12.80.450 [construction] §12.80.460 [industrial and commercial] §12.80.470 and .480 [industrial and commercial NPDES requirements] §12.84.440 [LID standards] §12.84.445 [hydromodification control] §12.84.450 [LID Plan Review] §22.60.330 [general prohibitions] §22.60.340 [violations] §22.60.350 [public nuisance] §22.60.360 [infractions] §22.60.370 [injunction] §22.60.380 [enforcement.] §22.60.390 [zoning enforcement order] §26.103 [violations and penalties]</p>

Order Part VI(A)(2)(a) Items	Primary Applicable Ordinance/Statute
	§26.104 [enforcement] §26.106 [permits] §26.108 [inspections] LACFCD Code: §21.05 Standards, Guidelines, and Criteria §21.07 Prohibited Discharges §21.13 Evidence of Compliance With Permit Requirements for Industrial or Commercial Activity §21.15 Notification of Uncontrolled Discharges Required §21.17 Requirement to Monitor and Analyze §21.23 Violation a Public Nuisance
ii. Prohibit all non-storm water discharges through the MS4 to receiving waters not otherwise authorized or conditionally exempt pursuant to Part III.A.	Los Angeles County Code: §12.80.410 [illicit discharge prohibited] LACFCD Code: §21.07 Prohibited Discharges
iii. Prohibit and eliminate illicit discharges and illicit connections to the MS4.	Los Angeles County Code: §12.80.410 [illicit discharge prohibited]; §12.80.420 [illicit connections prohibited] LACFCD Code: §21.05 Standards, Guidelines, and Criteria §21.07 Prohibited Discharges §21.09 Installation or Use of Illicit Connections Prohibited §21.23 Violation a Public Nuisance

Order Part VI(A)(2)(a) Items	Primary Applicable Ordinance/Statute
<p>iv. Control the discharge of spills, dumping, or disposal of materials other than storm water to its MS4.</p>	<p>Los Angeles County Code: §12.80.410 [illicit discharge prohibited]; §12.80.440 [littering and other polluting prohibited]</p> <p>LACFCD Code: §19.07 Interference With or Placing Obstructions, Refuse, Contaminating Substances, or Invasive Species in Facilities Prohibited §21.05 Standards, Guidelines, and Criteria §21.07 Prohibited Discharges §21.09 Installation or Use of Illicit Connections Prohibited §21.11 Littering Prohibited §21.13 Evidence of Compliance With Permit Requirements for Industrial or Commercial Activity §21.15 Notification of Uncontrolled Discharges Required §21.17 Requirement to Monitor and Analyze §21.23 Violation a Public Nuisance</p>
<p>v. Require compliance with conditions in Permittee ordinances, permits, contracts or orders (i.e., hold dischargers to its MS4 accountable for their contributions of pollutants and flows).</p>	<p>Los Angeles County Code: §12.80.490 [notification of uncontrolled discharge] §12.80.570 [obstructing access to facilities] §12.80.580 [compliance inspection] §12.80.610 [violation a nuisance] §12.620 [nuisance abatement] §12.80.635 [violation penalty]</p>

Order Part VI(A)(2)(a) Items	Primary Applicable Ordinance/Statute
	§12.80.640 [penalties not exclusive] §12.84.440 [LID standards] §12.84.445 [hydromodification control] §12.84.450 [LID Plan Review] §22.60.330 [general prohibitions] §22.60.340 [violations] §22.60.350 [public nuisance] §22.60.360 [infractions] §22.60.370 [injunction] §22.60.380 [enforcement.] §22.60.390 [zoning enforcement order] §26.103 [violations and penalties] §26.104 [enforcement] §26.106 [permits] §26.108 [inspections] LACFCD Code: §19.11 Violation a Public Nuisance §21.05 Standards, Guidelines, and Criteria §21.07 Prohibited Discharges §21.09 Installation or Use of Illicit Connections Prohibited §21.11 Littering Prohibited §21.13 Evidence of Compliance With Permit Requirements for Industrial or Commercial Activity §21.15 Notification of Uncontrolled Discharges Required §21.17 Requirement to Monitor and Analyze

Order Part VI(A)(2)(a) Items	Primary Applicable Ordinance/Statute
	§21.19 Conflicts With Other Code Sections §21.23 Violation a Public Nuisance
vi. Utilize enforcement mechanisms to require compliance with applicable ordinances, permits, contracts, or orders.	Same as item v., above
vii. Control the contribution of pollutants from one portion of the shared MS4 to another portion of the MS4 through interagency agreements among Copermittees.	California Government Code §6502 California Government Code §23004
viii. Control of the contribution of pollutants from one portion of the shared MS4 to another portion of the MS4 through interagency agreements with other owners of the MS4 such as the State of California Department of Transportation.	California Government Code §6502 California Government Code §23004
ix. Carry out all inspections, surveillance, and monitoring procedures necessary to determine compliance and noncompliance with applicable municipal ordinances, permits, contracts and orders, and with the provisions of this Order, including the prohibition of non-storm water discharges into the MS4 and receiving waters. This means the Permittee must have authority to enter, monitor, inspect, take measurements, review and copy records, and require regular reports from entities discharging into its MS4.	Los Angeles County Code: §12.80.490 [notification of uncontrolled discharge] §12.80.570 [obstructing access to facilities] §12.80.580 [compliance inspection] §12.80.610 [violation a nuisance] §12.80.620 [nuisance abatement] §12.80.635 [violation penalty] §12.80.640 [penalties not exclusive] §22.60.380 [enforcement.] §26.106 [permits] §26.108 [inspections]

Order Part VI(A)(2)(a) Items	Primary Applicable Ordinance/Statute
	LACFCD Code: §21.05 Standards, Guidelines, and Criteria §21.07 Prohibited Discharges §21.09 Installation or Use of Illicit Connections Prohibited §21.11 Littering Prohibited §21.13 Evidence of Compliance With Permit Requirements for Industrial or Commercial Activity §21.15 Notification of Uncontrolled Discharges Required §21.17 Requirement to Monitor and Analyze §21.23 Violation a Public Nuisance
x. Require the use of control measures to prevent or reduce the discharge of pollutants to achieve water quality standards/receiving water limitations.	Los Angeles County Code: §12.80.450 [construction mitigation] §12.80.500 [good housekeeping practices] §12.80.510 [construction BMPs] §12.80.520 [industrial/commercial BMPs] §12.84.440 [LID standards] §12.84.450 [LID Plan Review] §22.60.330 [general prohibitions] §22.60.380 [enforcement.] §22.60.390 [zoning enforcement order] §26.106 [permits] §26.108 [inspections] LACFCD Code: §21.05 Standards, Guidelines, and Criteria

Order Part VI(A)(2)(a) Items	Primary Applicable Ordinance/Statute
	§21.07 Prohibited Discharges §21.09 Installation or Use of Illicit Connections Prohibited §21.11 Littering Prohibited §21.13 Evidence of Compliance With Permit Requirements for Industrial or Commercial Activity §21.15 Notification of Uncontrolled Discharges Required §21.17 Requirement to Monitor and Analyze §21.23 Violation a Public Nuisance
xi. Require that structural BMPs are properly operated and maintained.	Los Angeles County Code: §12.80.530 [installation of structural BMPs] §22.60.380 [enforcement.] §22.60.390 [zoning enforcement order] §26.106 [permits] §26.108 [inspections] LACFCD Code: §21.05 Standards, Guidelines, and Criteria §21.07 Prohibited Discharges §21.09 Installation or Use of Illicit Connections Prohibited §21.11 Littering Prohibited §21.13 Evidence of Compliance With Permit Requirements for Industrial or Commercial Activity §21.15 Notification of Uncontrolled Discharges Required §21.17 Requirement to Monitor and Analyze

Order Part VI(A)(2)(a) Items	Primary Applicable Ordinance/Statute
	§21.23 Violation a Public Nuisance
<p>xii. Require documentation on the operation and maintenance of structural BMPs and their effectiveness in reducing the discharge of pollutants to the MS4.</p>	<p>Los Angeles County Code: §12.80.530 [installation of structural BMPs] §22.60.380 [enforcement.] §22.60.390 [zoning enforcement order] §26.106 [permits] §26.108 [inspections]</p> <p>LACFCD Code: §21.05 Standards, Guidelines, and Criteria §21.07 Prohibited Discharges §21.09 Installation or Use of Illicit Connections Prohibited §21.11 Littering Prohibited §21.13 Evidence of Compliance With Permit Requirements for Industrial or Commercial Activity §21.15 Notification of Uncontrolled Discharges Required §21.17 Requirement to Monitor and Analyze §21.23 Violation a Public Nuisance</p>

Order Part VI(A)(2)(b)(ii)

"Identification of the local administrative and legal procedures available to mandate compliance with applicable municipal ordinances identified in subsection (i) above and therefore with the conditions of this Order, and a statement as to whether enforcement actions can be completed administratively or whether they must be commenced and completed in the judicial system."

The local administrative and legal procedures available to mandate compliance with the above ordinances are specified in those ordinances, particularly in:

Los Angeles County Code:

§12.80.550 Enforcement—Director's powers and duties.

§12.80.600 Notice to correct violations—Director may take action.

§12.80.610 Violation a public nuisance.

§12.80.620 Nuisance abatement—Director to perform work when—Costs.

§12.80.630 Violation—Penalty.

§12.80.635 Administrative fines.

§12.80.640 Penalties not exclusive.

§12.84.450 LID Plan Review.

§12.84.460 Additional Requirements.

Title 26, §103 Violations And Penalties

Title 26, §104 Organization And Enforcement

Title 26, §105 Appeals Boards

Title 26, §106 Permits

§22.60.330 General prohibitions.

§22.60.340 Violations.

§22.60.350 Public nuisance.

§22.60.360 Infractions.

§22.60.370 Injunction.

§22.60.380 Enforcement.

§22.60.390 Zoning enforcement order and noncompliance fee.

LACFCD Code:

§21.05 Standards, Guidelines, and Criteria

§21.07 Prohibited Discharges

§21.09 Installation or Use of Illicit Connections Prohibited

§21.11 Littering Prohibited

§21.13 Evidence of Compliance With Permit Requirements for Industrial
or Commercial Activity

§21.15 Notification of Uncontrolled Discharges Required

§21.17 Requirement to Monitor and Analyze

§21.23 Violation a Public Nuisance

LACFCD attempts to first resolve each enforcement action
administratively. However, the above cited ordinances also provide LACFCD
with the authority to pursue such actions in the judicial system as necessary.

Very truly yours,

JOHN F. KRATTLI
County Counsel

By 
JUDITH A. FRIES
Principal Deputy County Counsel
Public Works Division

JAF:jjj

APPENIDX E. 90th Percentile Determination

The modeled results of daily flows originating from the County Island are presented below. The 90th Percentile Critical Storm Event is also highlighted.

Storm Year	Wet Weather Storm Date (Date where Precipitation output > 0, Oct 15 thru April 15)	Storm Volume (Cubic Feet)	Storm Volume (Acre-Feet)
2010-2011	12/19/2010	1,304,589	29.9
2000-2001	02/23/2001	610,393	14.0
2009-2010	02/05/2010	549,879	12.6
2009-2010	01/18/2010	512,014	11.8
2010-2011	12/17/2010	506,158	11.6
2004-2005	02/19/2005	503,293	11.6
2000-2001	01/08/2001	429,567	9.9
2009-2010	01/19/2010	402,123	9.2
2002-2003	02/11/2003	381,169	8.8
2008-2009	02/16/2009	351,933	8.1
2000-2001	02/10/2001	341,174	7.8
2004-2005	10/17/2004	339,169	7.8
2010-2011	03/20/2011	336,904	7.7
2007-2008	01/23/2008	316,225	7.3
2003-2004	02/23/2004	310,674	7.1
2009-2010	01/20/2010	305,364	7.0
2000-2001	10/24/2000	261,665	6.0
2004-2005	02/21/2005	261,612	6.0
2004-2005	10/24/2004	249,846	5.7
2004-2005	02/20/2005	225,866	5.2
2004-2005	02/09/2005	225,242	5.2
2002-2003	12/15/2002	225,044	5.2
2010-2011	12/25/2010	223,929	5.1
2010-2011	12/20/2010	218,780	5.0
2008-2009	11/25/2008	210,709	4.8
2009-2010	12/07/2009	208,484	4.8
2007-2008	11/30/2007	177,468	4.1
2007-2008	02/22/2008	176,395	4.0
2005-2006	02/25/2006	174,154	4.0
2009-2010	01/17/2010	167,565	3.8
2004-2005	02/17/2005	166,091	3.8
2008-2009	02/05/2009	162,208	3.7
2010-2011	12/22/2010	162,194	3.7
2002-2003	12/17/2002	161,984	3.7
2007-2008	01/25/2008	156,863	3.6

Storm Year	Wet Weather Storm Date (Date where Precipitation output > 0, Oct 15 thru April 15)	Storm Volume (Cubic Feet)	Storm Volume (Acre-Feet)
2005-2006	12/31/2005	149,576	3.4
2008-2009	11/24/2008	147,225	3.4
2005-2006	03/26/2006	145,105	3.3
2000-2001	02/25/2001	144,352	3.3
2004-2005	02/16/2005	144,039	3.3
2010-2011	12/21/2010	141,812	3.3
2009-2010	12/12/2009	141,527	3.2
2008-2009	12/17/2008	139,101	3.2
2007-2008	01/27/2008	138,717	3.2
2002-2003	04/12/2003	137,848	3.2
2010-2011	03/23/2011	133,734	3.1
2004-2005	02/18/2005	133,014	3.1
2000-2001	01/24/2001	132,890	3.1
2007-2008	12/18/2007	132,786	3.0
2007-2008	01/04/2008	132,691	3.0
2007-2008	02/20/2008	128,975	3.0
2002-2003	02/22/2003	126,273	2.9
2008-2009	12/15/2008	125,318	2.9
2005-2006	04/02/2006	124,580	2.9
2002-2003	02/09/2003	124,026	2.8
2010-2011	12/29/2010	123,786	2.8
2008-2009	02/06/2009	122,792	2.8
2010-2011	02/18/2011	121,686	2.8
2008-2009	12/14/2008	120,883	2.8
2009-2010	01/21/2010	111,090	2.6
2000-2001	02/24/2001	107,072	2.5
2004-2005	01/09/2005	103,780	2.4
2010-2011	01/02/2011	102,116	2.3
2004-2005	12/26/2004	97,932	2.2
2007-2008	01/22/2008	97,887	2.2
2004-2005	03/20/2005	97,096	2.2
2009-2010	02/26/2010	96,607	2.2
2003-2004	02/28/2004	95,413	2.2
2009-2010	02/09/2010	93,948	2.2
2009-2010	01/22/2010	93,695	2.2
2010-2011	02/25/2011	93,493	2.1
2010-2011	10/19/2010	89,186	2.0

Storm Year	Wet Weather Storm Date (Date where Precipitation output > 0, Oct 15 thru April 15)	Storm Volume (Cubic Feet)	Storm Volume (Acre-Feet)
2007-2008	01/06/2008	87,035	2.0
2000-2001	02/12/2001	82,455	1.9
2009-2010	12/11/2009	81,998	1.9
2009-2010	04/11/2010	78,979	1.8
2008-2009	12/13/2008	78,591	1.8
2004-2005	02/08/2005	77,145	1.8
2000-2001	03/03/2001	76,116	1.7
2007-2008	01/03/2008	74,027	1.7
2001-2002	11/11/2001	71,218	1.6
2004-2005	01/08/2005	70,472	1.6
2000-2001	01/06/2001	68,422	1.6
2007-2008	01/26/2008	67,325	1.5
2009-2010	02/27/2010	67,298	1.5
2002-2003	11/05/2002	67,294	1.5
2002-2003	11/28/2002	67,230	1.5
2004-2005	10/25/2004	66,378	1.5
2000-2001	01/09/2001	66,031	1.5
2005-2006	12/29/2005	65,408	1.5
2008-2009	02/15/2009	64,185	1.5
2010-2011	12/16/2010	63,424	1.5
2008-2009	11/02/2008	62,878	1.4
2000-2001	10/25/2000	62,172	1.4
2010-2011	03/22/2011	61,647	1.4
2001-2002	12/27/2001	59,865	1.4
2009-2010	02/08/2010	59,080	1.4
2010-2011	12/28/2010	57,931	1.3
2008-2009	02/04/2009	57,174	1.3
2008-2009	12/22/2008	56,814	1.3
2010-2011	01/01/2011	56,719	1.3
2000-2001	04/04/2001	56,198	1.3
2005-2006	10/15/2005	56,080	1.3
2009-2010	02/25/2010	54,679	1.3
2010-2011	02/24/2011	53,643	1.2
2000-2001	02/27/2001	52,135	1.2
2004-2005	02/10/2005	51,902	1.2
2007-2008	02/03/2008	51,755	1.2
2005-2006	03/01/2006	51,184	1.2

Storm Year	Wet Weather Storm Date (Date where Precipitation output > 0, Oct 15 thru April 15)	Storm Volume (Cubic Feet)	Storm Volume (Acre-Feet)
2007-2008	01/24/2008	51,098	1.2
2010-2011	12/05/2010	49,550	1.1
2004-2005	10/19/2004	49,385	1.1
2003-2004	01/31/2004	49,310	1.1
2000-2001	10/27/2000	48,739	1.1
2004-2005	01/26/2005	47,626	1.1
2006-2007	02/10/2007	47,252	1.1
2000-2001	02/26/2001	46,797	1.1
2009-2010	04/05/2010	46,735	1.1
2007-2008	01/05/2008	45,778	1.1
2008-2009	02/09/2009	44,082	1.0
2010-2011	11/20/2010	43,225	1.0
2008-2009	02/14/2009	42,402	1.0
2003-2004	02/16/2004	41,672	1.0
2010-2011	02/17/2011	41,244	0.9
2008-2009	02/17/2009	41,192	0.9
2010-2011	12/27/2010	40,479	0.9
2005-2006	02/26/2006	40,313	0.9
2007-2008	12/06/2007	39,703	0.9
2009-2010	03/06/2010	39,662	0.9
2010-2011	10/28/2010	39,615	0.9
2000-2001	02/21/2001	39,015	0.9
2009-2010	04/10/2010	38,773	0.9
2004-2005	01/05/2005	37,669	0.9
2000-2001	02/08/2001	37,303	0.9
2010-2011	12/15/2010	36,859	0.8
2008-2009	03/04/2009	35,648	0.8
2008-2009	02/13/2009	34,745	0.8
2002-2003	02/23/2003	34,079	0.8
2002-2003	02/08/2003	34,059	0.8
2006-2007	12/07/2006	33,828	0.8
2007-2008	02/02/2008	33,251	0.8
2002-2003	04/13/2003	33,127	0.8
2000-2001	02/17/2001	32,962	0.8
2004-2005	01/01/2005	32,916	0.8
2005-2006	03/27/2006	32,228	0.7
2005-2006	03/15/2006	31,849	0.7

Storm Year	Wet Weather Storm Date (Date where Precipitation output > 0, Oct 15 thru April 15)	Storm Volume (Cubic Feet)	Storm Volume (Acre-Feet)
2003-2004	12/31/2003	31,466	0.7
2007-2008	01/21/2008	31,426	0.7
2000-2001	03/04/2001	30,729	0.7
2002-2003	02/12/2003	30,391	0.7
2010-2011	11/19/2010	30,112	0.7
2000-2001	01/10/2001	29,973	0.7
2005-2006	04/03/2006	29,113	0.7
2002-2003	02/10/2003	28,534	0.7
2000-2001	01/11/2001	28,062	0.6
2004-2005	02/15/2005	27,211	0.6
2004-2005	01/04/2005	26,913	0.6
2005-2006	02/16/2006	26,886	0.6
2005-2006	03/25/2006	26,332	0.6
2008-2009	01/23/2009	25,757	0.6
2004-2005	03/21/2005	25,722	0.6
2007-2008	01/28/2008	25,634	0.6
2010-2011	12/04/2010	25,391	0.6
2000-2001	01/21/2001	25,355	0.6
2005-2006	03/19/2006	25,128	0.6
2001-2002	11/27/2001	24,987	0.6
2003-2004	02/29/2004	24,805	0.6
2008-2009	02/07/2009	24,590	0.6
2008-2009	12/25/2008	24,264	0.6
2003-2004	12/04/2003	23,896	0.5
2008-2009	12/24/2008	23,603	0.5
2004-2005	12/27/2004	23,529	0.5
2006-2007	01/30/2007	22,794	0.5
2010-2011	01/03/2011	22,429	0.5
2004-2005	01/02/2005	21,975	0.5
2005-2006	04/12/2006	21,253	0.5
2010-2011	10/24/2010	20,841	0.5
2010-2011	03/21/2011	20,434	0.5
2000-2001	04/05/2001	18,827	0.4
2010-2011	01/30/2011	18,646	0.4
2007-2008	02/01/2008	18,532	0.4
2010-2011	03/25/2011	18,194	0.4
2006-2007	02/09/2007	18,169	0.4

Storm Year	Wet Weather Storm Date (Date where Precipitation output > 0, Oct 15 thru April 15)	Storm Volume (Cubic Feet)	Storm Volume (Acre-Feet)
2000-2001	01/07/2001	18,063	0.4
2002-2003	11/29/2002	18,024	0.4
2010-2011	10/23/2010	17,887	0.4
2002-2003	02/25/2003	17,772	0.4
2005-2006	12/30/2005	17,292	0.4
2000-2001	10/28/2000	17,245	0.4
2003-2004	11/01/2003	16,872	0.4
2002-2003	11/06/2002	16,869	0.4
2005-2006	10/16/2005	16,859	0.4
2009-2010	01/16/2010	16,835	0.4
2001-2002	12/12/2001	16,606	0.4
2006-2007	12/27/2006	16,528	0.4
2009-2010	01/12/2010	16,424	0.4
2007-2008	02/24/2008	16,296	0.4
2005-2006	03/02/2006	16,296	0.4
2009-2010	01/25/2010	16,294	0.4
2001-2002	12/28/2001	16,165	0.4
2009-2010	01/26/2010	15,926	0.4
2003-2004	02/01/2004	15,424	0.4
2008-2009	03/03/2009	14,839	0.3
2008-2009	02/12/2009	14,787	0.3
2004-2005	12/05/2004	14,561	0.3
2006-2007	02/18/2007	14,503	0.3
2010-2011	03/26/2011	14,433	0.3
2000-2001	02/22/2001	14,386	0.3
2000-2001	02/18/2001	13,381	0.3
2006-2007	12/24/2006	13,342	0.3
2009-2010	03/05/2010	13,287	0.3
2010-2011	02/15/2011	13,285	0.3
2010-2011	12/14/2010	13,206	0.3
2004-2005	10/18/2004	13,190	0.3
2004-2005	03/16/2005	13,032	0.3
2000-2001	02/09/2001	13,011	0.3
2007-2008	02/23/2008	12,880	0.3
2005-2006	03/04/2006	12,783	0.3
2007-2008	12/05/2007	12,113	0.3
2004-2005	01/06/2005	11,951	0.3

Storm Year	Wet Weather Storm Date (Date where Precipitation output > 0, Oct 15 thru April 15)	Storm Volume (Cubic Feet)	Storm Volume (Acre-Feet)
2000-2001	04/07/2001	11,715	0.3
2010-2011	03/27/2011	11,556	0.3
2010-2011	04/07/2011	11,409	0.3
2010-2011	11/27/2010	11,386	0.3
2006-2007	02/22/2007	11,296	0.3
2006-2007	02/26/2007	11,215	0.3
2003-2004	10/29/2003	11,038	0.3
2005-2006	03/29/2006	10,844	0.2
2003-2004	02/17/2004	10,556	0.2
2004-2005	02/28/2005	10,532	0.2
2005-2006	02/15/2006	10,470	0.2
2006-2007	12/14/2006	10,452	0.2
2001-2002	03/20/2002	10,347	0.2
2004-2005	03/01/2005	10,210	0.2
2004-2005	02/11/2005	10,010	0.2
2005-2006	03/16/2006	9,939	0.2
2006-2007	12/08/2006	9,707	0.2
2007-2008	01/20/2008	9,314	0.2
2008-2009	02/08/2009	9,134	0.2
2002-2003	02/24/2003	9,027	0.2
2003-2004	01/01/2004	8,827	0.2
2010-2011	11/08/2010	8,770	0.2
2001-2002	01/01/2002	8,401	0.2
2002-2003	12/26/2002	8,147	0.2
2006-2007	01/29/2007	8,086	0.2
2000-2001	01/22/2001	7,581	0.2
2005-2006	04/13/2006	7,579	0.2
2000-2001	03/07/2001	7,530	0.2
2006-2007	11/25/2006	7,456	0.2
2005-2006	02/17/2006	7,433	0.2
2001-2002	11/28/2001	7,358	0.2
2007-2008	12/07/2007	7,332	0.2
2005-2006	03/31/2006	6,916	0.2
2006-2007	01/04/2007	6,882	0.2
2006-2007	03/21/2007	6,856	0.2
2004-2005	01/10/2005	6,519	0.1
2010-2011	01/29/2011	6,072	0.1

Storm Year	Wet Weather Storm Date (Date where Precipitation output > 0, Oct 15 thru April 15)	Storm Volume (Cubic Feet)	Storm Volume (Acre-Feet)
2005-2006	12/06/2005	5,994	0.1
2003-2004	12/05/2003	5,794	0.1
2004-2005	03/26/2005	5,768	0.1
2009-2010	03/03/2010	5,505	0.1
2006-2007	04/15/2007	5,332	0.1
2004-2005	03/22/2005	5,254	0.1
2009-2010	02/19/2010	5,121	0.1
2006-2007	02/11/2007	4,900	0.1
2000-2001	02/20/2001	4,651	0.1
2003-2004	11/02/2003	4,546	0.1
2010-2011	02/16/2011	4,453	0.1
2009-2010	02/20/2010	4,441	0.1
2010-2011	11/18/2010	4,302	0.1
2001-2002	12/13/2001	4,276	0.1
2010-2011	03/02/2011	4,251	0.1
2007-2008	02/15/2008	4,246	0.1
2006-2007	02/27/2007	4,222	0.1
2004-2005	03/17/2005	3,817	0.1
2004-2005	11/26/2004	3,799	0.1
2005-2006	04/04/2006	3,711	0.1
2005-2006	03/05/2006	3,347	0.1
2005-2006	11/07/2005	3,285	0.1
2004-2005	11/12/2004	3,148	0.1
2007-2008	02/13/2008	3,030	0.1
2002-2003	03/02/2003	2,985	0.1
2009-2010	04/04/2010	2,922	0.1
2009-2010	12/10/2009	2,817	0.1
2009-2010	02/24/2010	2,757	0.1
2010-2011	03/06/2011	2,609	0.1
2007-2008	04/02/2008	2,607	0.1
2004-2005	01/24/2005	2,605	0.1
2008-2009	03/21/2009	2,589	0.1
2006-2007	12/25/2006	2,532	0.1
2010-2011	02/14/2011	2,525	0.1
2008-2009	03/22/2009	2,453	0.1
2001-2002	01/26/2002	2,430	0.1
2009-2010	01/11/2010	2,400	0.1

Storm Year	Wet Weather Storm Date (Date where Precipitation output > 0, Oct 15 thru April 15)	Storm Volume (Cubic Feet)	Storm Volume (Acre-Feet)
2006-2007	12/19/2006	2,384	0.1
2001-2002	03/04/2002	2,322	0.1
2005-2006	02/28/2006	2,297	0.1
2004-2005	10/16/2004	2,240	0.1
2007-2008	02/19/2008	2,189	0.1
2008-2009	01/22/2009	2,176	0.0
2004-2005	12/03/2004	2,129	0.0
2005-2006	04/01/2006	2,087	0.0
2004-2005	12/04/2004	2,069	0.0
2005-2006	03/23/2006	1,764	0.0
2006-2007	11/24/2006	1,379	0.0
2003-2004	11/10/2003	1,151	0.0
2002-2003	12/11/2002	958	0.0
2006-2007	12/20/2006	826	0.0
2010-2011	11/23/2010	809	0.0
2009-2010	01/13/2010	802	0.0
2010-2011	10/22/2010	793	0.0
2007-2008	10/17/2007	785	0.0
2008-2009	10/31/2008	765	0.0
2010-2011	10/18/2010	763	0.0
2006-2007	01/03/2007	753	0.0
2008-2009	11/01/2008	748	0.0
2006-2007	03/20/2007	737	0.0
2003-2004	01/25/2004	724	0.0
2009-2010	12/30/2009	705	0.0
2001-2002	12/26/2001	654	0.0
2006-2007	01/11/2007	628	0.0
2010-2011	11/26/2010	557	0.0
2007-2008	12/17/2007	553	0.0
2006-2007	02/17/2007	532	0.0
2009-2010	12/06/2009	523	0.0
2006-2007	02/19/2007	490	0.0
2006-2007	02/21/2007	481	0.0
2006-2007	02/25/2007	356	0.0

APPENIDX F. Bacteria RAA Analysis

Bacteria was modeled using WMMS's Fecal Coliform output. The analysis followed the process discussed in Section 6.3 of this WMP. The WMMS output was divided into storm years and the number of exceedances per year was determined to identify the 90th Percentile Year.

Table F.1 Number of Days Exceeding Fecal Limit per Storm Year

Storm Year	Number of Days Exceeding Fecal Limit
2001-2002	11
2002-2003	18
2003-2004	14
2004-2005	35
2005-2006	28
2006-2007	20
2007-2008	26
2008-2009	24
2009-2010	26
2010-2011	41

<- 90th Percentile Year

Table F.2 highlights the 18th exceedance day for the Bacteria 90th Percentile Year.

Table F.2 2004-2005 Storm Season Output

Event #	Storm Season	Date	Storm Volume (L)	Storm Volume (acre-feet)	WMMS Modeled Fecal Concentration (#/100ml)	Allowable Single Sample Fecal Concentration (4000/100mL) per Ballona Bacteria TMDL	Storm In Compliance ?
1	2004-2005	02/19/2005	14,251,668.28	11.554	6216.286	400.00	NO
2	2004-2005	10/17/2004	9,604,186.92	7.786	6197.080	400.00	NO
3	2004-2005	02/21/2005	7,408,016.98	6.006	6189.070	400.00	NO
4	2004-2005	10/24/2004	7,074,831.90	5.736	6145.598	400.00	NO
5	2004-2005	02/20/2005	6,395,815.97	5.185	6136.808	400.00	NO
6	2004-2005	02/09/2005	6,378,132.57	5.171	6093.167	400.00	NO
7	2004-2005	02/17/2005	4,703,163.20	3.813	6089.579	400.00	NO
8	2004-2005	02/16/2005	4,078,716.10	3.307	6041.617	400.00	NO
9	2004-2005	02/18/2005	3,766,528.00	3.054	5997.282	400.00	NO
10	2004-2005	01/09/2005	2,938,705.72	2.382	5987.072	400.00	NO
11	2004-2005	12/26/2004	2,773,134.69	2.248	5963.007	400.00	NO
12	2004-2005	03/20/2005	2,749,450.33	2.229	5946.077	400.00	NO
13	2004-2005	02/08/2005	2,184,497.03	1.771	5888.622	400.00	NO
14	2004-2005	01/08/2005	1,995,533.88	1.618	5787.903	400.00	NO
15	2004-2005	10/25/2004	1,879,606.05	1.524	5711.886	400.00	NO
16	2004-2005	02/10/2005	1,469,700.37	1.192	5488.234	400.00	NO
17	2004-2005	10/19/2004	1,398,418.64	1.134	5441.486	400.00	NO
18	2004-2005	01/26/2005	1,348,628.33	1.093	5430.532	400.00	NO
19	2004-2005	01/05/2005	1,066,654.05	0.865	5350.975	400.00	NO
20	2004-2005	01/01/2005	932,070.77	0.756	5336.375	400.00	NO
21	2004-2005	02/15/2005	770,518.15	0.625	5274.477	400.00	NO

Event #	Storm Season	Date	Storm Volume (L)	Storm Volume (acre-feet)	WMMS Modeled Fecal Concentration (#/100ml)	Allowable Single Sample Fecal Concentration (4000/100mL) per Ballona Bacteria TMDL	Storm In Compliance ?
22	2004-2005	01/04/2005	762,101.16	0.618	5195.947	400.00	NO
23	2004-2005	03/21/2005	728,363.62	0.590	5158.511	400.00	NO
24	2004-2005	12/27/2004	666,275.05	0.540	4984.984	400.00	NO
25	2004-2005	01/02/2005	622,262.23	0.504	4917.418	400.00	NO
26	2004-2005	12/05/2004	412,313.41	0.334	4758.954	400.00	NO
27	2004-2005	10/18/2004	373,504.43	0.303	4726.039	400.00	NO
28	2004-2005	03/16/2005	369,014.72	0.299	4503.673	400.00	NO
29	2004-2005	01/06/2005	338,414.06	0.274	3297.191	400.00	NO
30	2004-2005	02/28/2005	298,244.41	0.242	2574.722	400.00	NO
31	2004-2005	03/01/2005	289,100.67	0.234	1700.535	400.00	NO
32	2004-2005	02/11/2005	283,440.27	0.230	1538.307	400.00	NO
33	2004-2005	01/10/2005	184,608.91	0.150	1296.498	400.00	NO
34	2004-2005	03/26/2005	163,336.58	0.132	1214.059	400.00	NO
35	2004-2005	03/22/2005	148,784.46	0.121	414.237	400.00	NO
36	2004-2005	03/17/2005	108,098.26	0.088	29.155	400.00	YES
37	2004-2005	11/26/2004	107,574.38	0.087	0.251	400.00	YES
38	2004-2005	11/12/2004	89,144.02	0.072	0.098	400.00	YES
39	2004-2005	01/24/2005	73,763.34	0.060	0.023	400.00	YES
40	2004-2005	10/16/2004	63,432.46	0.051	0.021	400.00	YES
41	2004-2005	12/03/2004	60,299.64	0.049	0.009	400.00	YES
42	2004-2005	12/04/2004	58,588.55	0.047	0.006	400.00	YES

APPENIDX G. Time Series Analysis

The following graphs present the time series difference between baseline and allowable concentrations modeled using WMMMS.

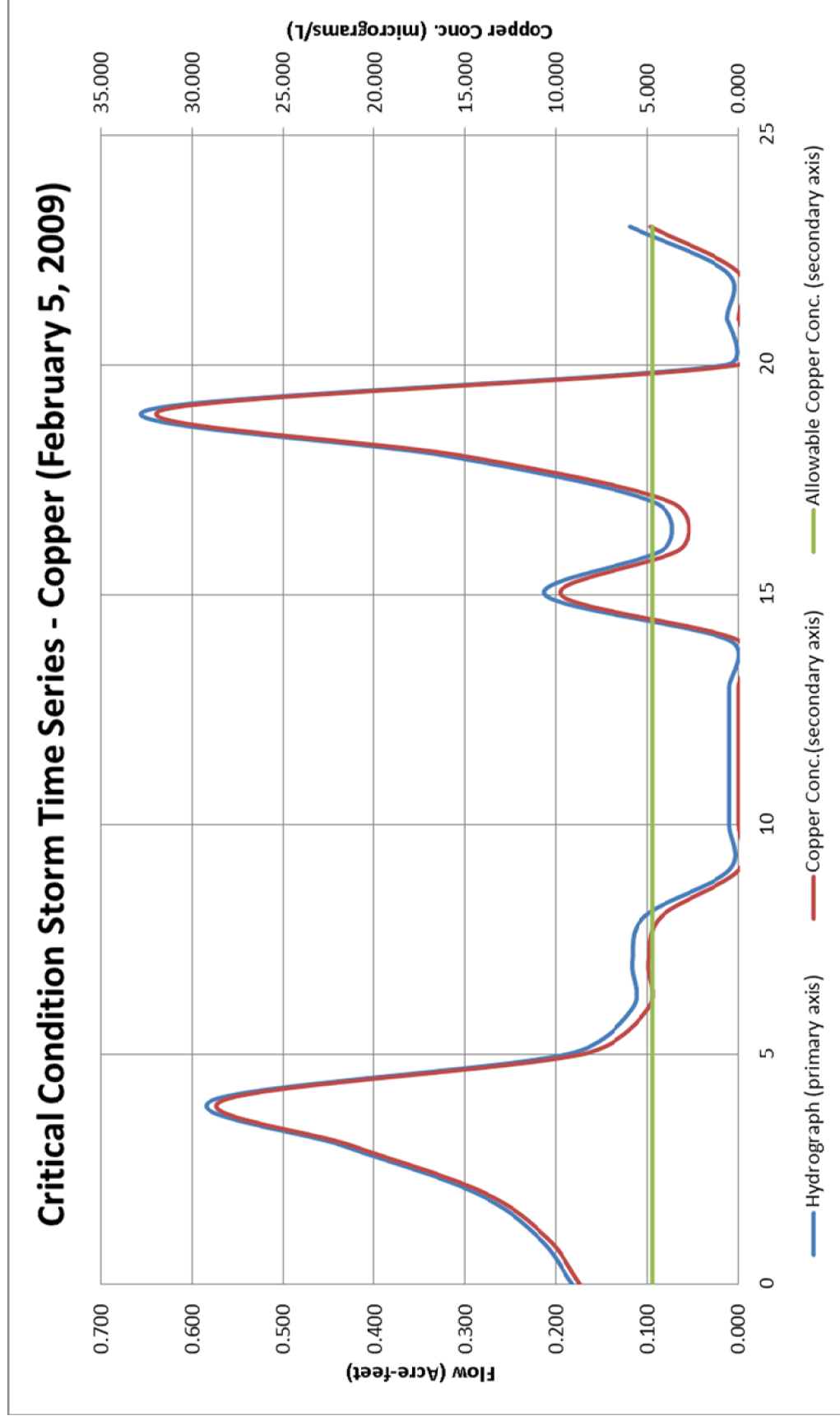

Figure G-1: Critical Condition Storm Hydrograph (Feb 5, 2009) with Modeled Copper Conc. and TMDL Allowable Copper Conc.

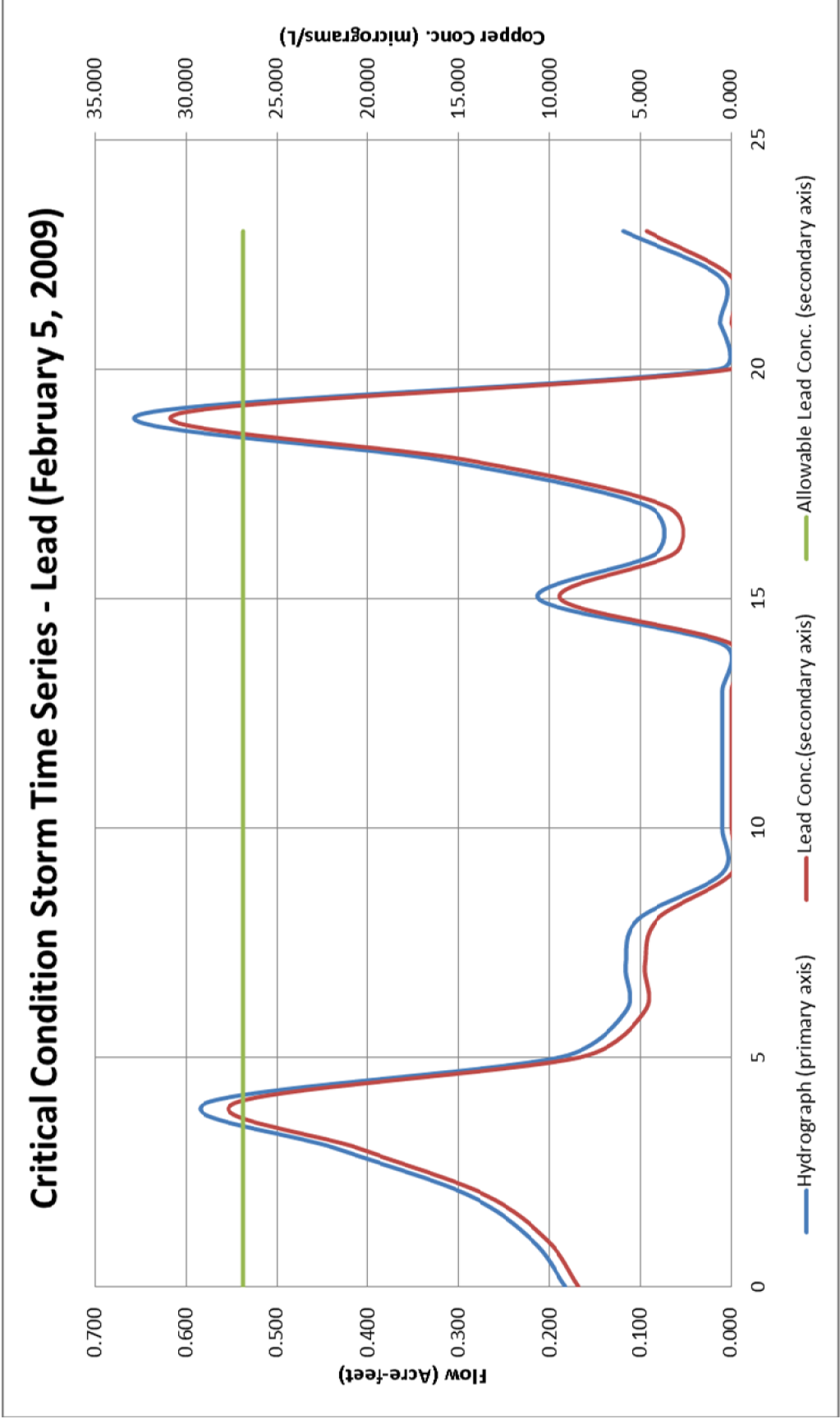

Figure G-2: Critical Condition Storm Hydrograph (Feb 5, 2009) with Modeled Lead Conc. and TMDL Allowable Lead Conc.

Critical Condition Storm Time Series - Zinc. (February 5, 2009)

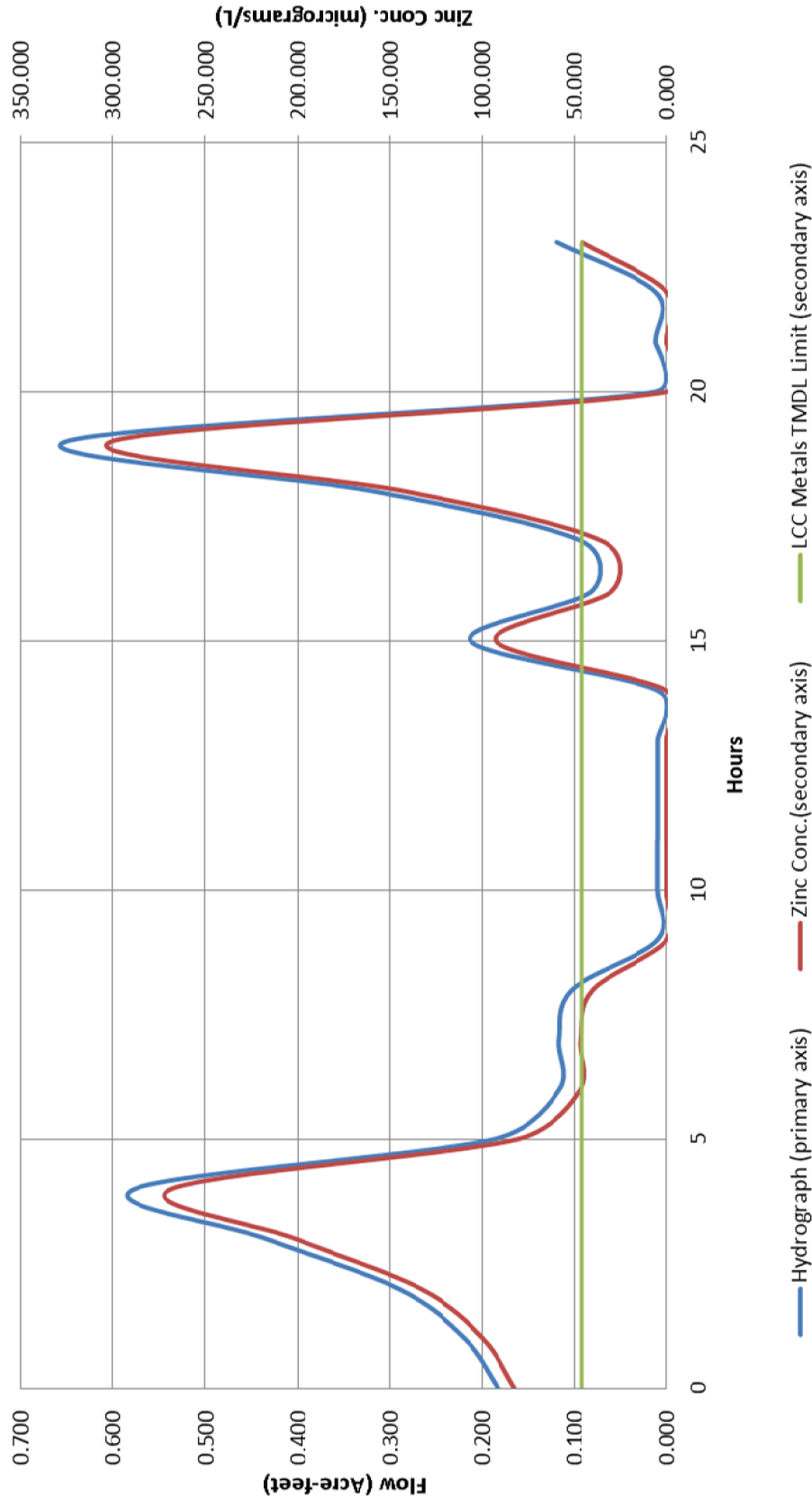

Figure G-3: Critical Condition Storm Hydrograph (Feb 5, 2009) with Modeled Zinc Conc. and TMDL Allowable Zinc Conc.

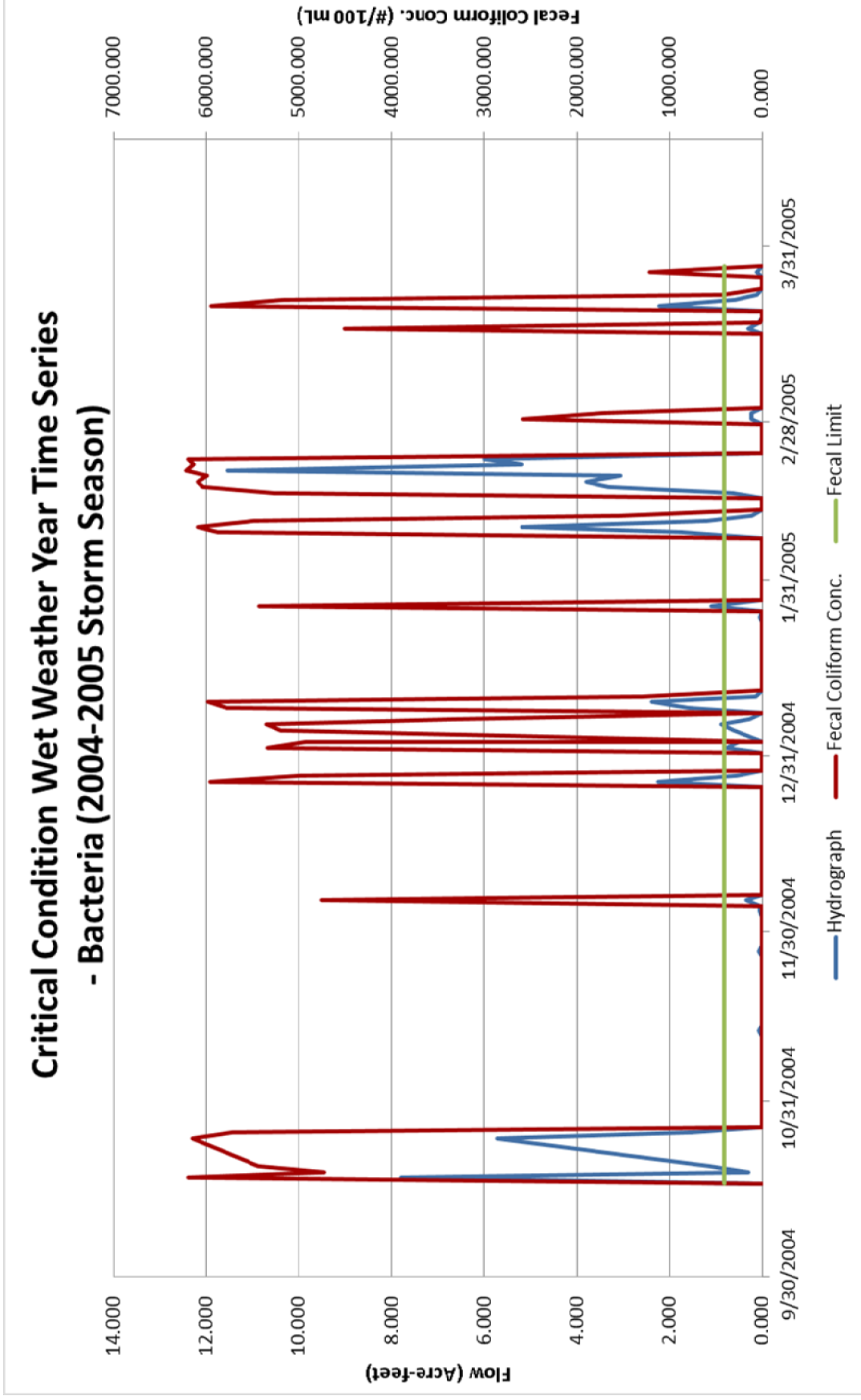

Figure G-4: Critical Condition Bacteria Year (2004-2005) with Modeled Fecal Coliform, and TMDL Allowable Fecal Conc.

[This page intentionally left blank]