

**California Regional Water Quality Control Board
San Diego Region**

**Total Maximum Daily Loads for Indicator Bacteria
Baby Beach in Dana Point Harbor and
Shelter Island Shoreline Park in
San Diego Bay**



**Draft Technical Report
February 22, 2008**

**CALIFORNIA REGIONAL WATER QUALITY CONTROL BOARD
SAN DIEGO REGION**

9174 Sky Park Court, Suite 100, San Diego, California 92123-4340

Phone • (858) 467-2952 • Fax (858) 571-6972

<http://www.waterboards.ca.gov/sandiego>.

To request copies of the Basin Plan Amendment and Technical Report for Total Maximum Daily Loads for Indicator Bacteria, Baby Beach in Dana Point Harbor and Shelter Island Shoreline Park in San Diego Bay, please contact Mr. Wayne Chiu at (858) 637-5558, or by email at wchiu@waterboards.ca.gov.

Documents also are available at: <http://www.waterboards.ca.gov/sandiego>.

Total Maximum Daily Loads for Indicator Bacteria Baby Beach in Dana Point Harbor and Shelter Island Shoreline Park in San Diego Bay

Draft Technical Report

Adopted by the
California Regional Water Quality Control Board
San Diego Region
on _____, 200x

Approved by the
State Water Resources Control Board
on _____, 200 x
and the
Office of Administrative Law
on _____, 200 x
and the
United States Environmental Protection Agency
on _____, 200 x.

**CALIFORNIA REGIONAL WATER QUALITY CONTROL BOARD
SAN DIEGO REGION
9174 Sky Park Court, Suite 100
San Diego, California 92123-4340**

Telephone (858) 467-2952

STATE OF CALIFORNIA

ARNOLD SCHWARZENEGGER, Governor
LINDA S. ADAMS, Agency Secretary, California Environmental Protection Agency



State Water Resources Control Board

Tam Doduc, <i>Chair</i>	Civil Engineer, Water Rights
Gary Wolff, <i>Vice Chair</i>	Professional Engineer, Water Quality
Charles R. Hoppin	Water Quality
Arthur G. Baggett, Jr.	Attorney, Water Supply & Water Rights
Frances Spivey-Weber	Public Member

Dorothy Rice, *Executive Director*

California Regional Water Quality Control Board San Diego Region

Susan Ritschel, <i>Chair</i>	Public
Richard Wright, <i>Vice Chair</i>	County Government
Eric Anderson	Irrigated Agriculture
David King	Recreation, Fish or Wildlife
Elizabeth Pearson-Schneider	Municipal Government
Kris Weber	Industrial Water Use
Wayne Rayfield	Water Quality
<i>Vacant</i>	Water Quality
<i>Vacant</i>	Water Supply

John H. Robertus, *Executive Officer*

Michael McCann, P.E., *Assistant Executive Officer*

This report was prepared under the direction of

David T. Barker P.E., *Chief, Water Resource Protection Branch*
Julie Chan P.G., *Chief, Water Quality Standards Unit*

by

Wayne Chiu, P.E., *Water Resource Control Engineer*

with the assistance of

Phil Hammer, *Environmental Scientist*
Lesley Dobalian, *Environmental Scientist*
Lisa Honma, *Environmental Scientist*
Alan Monji, *Environmental Scientist*
Christina Arias, *Water Resource Control Engineer*

and technical support provided by

Tetra Tech, Inc., led by Stephen Carter, P.E.

Table of Contents

Executive Summary	1
1 Introduction.....	4
1.1 Technical Approach	7
2 Problem Statement.....	9
2.1 Project Area Description	10
2.2 Applicable Water Quality Standards	14
2.3 Impairment Overview	15
2.3.1 Baby Beach Overview.....	15
2.3.2 Shelter Island Shoreline Park Overview.....	16
3 Numeric Target Selection	17
3.1 Wet-Weather Targets.....	18
3.2 Dry-Weather Targets	18
4 Data Inventory and Analysis.....	19
4.1 Data Inventory	19
4.1.1 Water Quality Data.....	20
4.1.2 Waterbody Characteristics	20
4.1.3 Meteorological Data	22
4.1.4 Land Characteristic Data.....	23
4.2 Review of Shoreline Water Quality	23
4.2.1 Baby Beach Water Quality	23
4.2.2 Shelter Island Shoreline Park Water Quality	24
5 Source Analysis.....	25
5.1 Nonpoint Sources	25
5.1.1 Natural Sources	26
5.1.2 Encampments (Homeless Persons).....	26
5.2 Point Sources	27
5.2.1 Wastewater Treatment Plants.....	27
5.2.2 Illegal Sewage Discharge from Boats	27
5.2.3 Municipal Separate Storm Sewer Systems (Urban Runoff)	27
6 Linkage Analysis.....	29
6.1 Model Selection Criteria.....	30
6.1.1 Technical Criteria	30
6.1.2 Regulatory Criteria	33
6.2 Receiving Water Modeling Approach.....	33
6.2.1 Wet Weather Modeling Approach	34
6.2.2 Dry Weather Modeling Approach	35
7 Identification of Load Allocations and Reductions	37
7.1 Wet Weather Loading Analysis.....	37
7.1.1 Identification of the Critical Wet Weather and Tidal Conditions... 37	
7.1.2 Critical Locations for Wet Weather Load Calculations	38
7.1.3 Wet Weather Load Calculations.....	39
7.1.4 Application of Wet Weather Numeric Targets	40

	7.1.5	Calculation of Existing Wet Weather Bacteria Loads and TMDLs	40
	7.1.6	Allocation of Wet Weather TMDLs and Calculation of Load Reductions for WLAs	41
	7.1.7	Margin of Safety	41
	7.1.8	Seasonality	42
	7.2	Dry Weather Loading Analysis	42
	7.2.1	Identification of the Critical Dry Weather and Tidal Conditions	42
	7.2.2	Critical Locations for Dry Weather Load Calculations	42
	7.2.3	Dry Weather Load Calculations	43
	7.2.4	Application of Dry Weather Numeric Targets	44
	7.2.5	Calculation of Existing Dry Weather Bacteria Loads and TMDLs	44
	7.2.6	Allocation of Dry Weather TMDLs and Calculation of Load Reductions for WLAs	46
	7.2.7	Margin of Safety	46
	7.2.8	Seasonality	47
8		Total Maximum Daily Loads and Allocations	48
	8.1	Wasteload Allocations	48
	8.2	Load Allocations	49
	8.3	Wet Weather Results	49
	8.4	Dry Weather Results	53
9		Legal Authority For TMDL Implementation Plan	56
	9.1	Controllable Water Quality Factors	56
	9.2	Regulatory Framework	56
	9.2.1	Point Sources	57
	9.2.2	Nonpoint Sources	58
	9.3	Persons Responsible for Point Source Discharges	58
	9.3.1	Municipal Phase I Dischargers of Urban Runoff	59
	9.3.2	Illicit Discharges from Boats	59
	9.3.3	Publicly Owned Treatment Works	59
	9.4	Persons Responsible for Controllable Nonpoint Source Discharges	60
10		Implementation Plan	61
	10.1	Regulatory Authority for Implementation Plans	61
	10.2	Implementation Plan Objectives	62
	10.3	Allocations and Identification of Dischargers	62
	10.3.1	Point Source Discharges	62
	10.3.2	Nonpoint Source Discharges	63
	10.3.3	Responsible Municipal Dischargers	63
	10.4	Compliance Schedule for Achieving Allocations	64
	10.4.1	Compliance Schedule	64
	10.5	San Diego Water Board Actions	67
	10.5.1	Process and Schedule for Issuing NPDES Requirements	67
	10.5.2	Actions with respect to Phase I Municipal Dischargers	69
	10.5.3	Additional Actions	74
	10.6	Specific Implementation Objectives	74
	10.7	Coordination and Execution of Special Studies	75

	10.7.1	Collect Data Useful for Model Improvement.....	76
	10.7.2	Improve Understanding Between Bacteria Levels and Health Effects	76
	10.7.3	Identification of Method for Direct Pathogen Measurement	77
	10.8	TMDL Implementation Milestones	78
11		Environmental Analysis, Environmental Checklist, and Economic Factors	79
	11.1	California Environmental Quality Act Requirements	79
	11.2	Analysis of Reasonably Foreseeable Methods of Compliance	80
	11.3	Possible Environmental Impacts.....	81
	11.4	Alternative Means of Compliance	81
	11.5	Reasonably Foreseeable Methods of Compliance at Specific Sites	81
	11.6	Economic Factors	82
	11.7	Reasonable Alternatives to the Proposed Activity	82
12		Necessity of Regulatory Provisions	84
13		Public Participation	86
14		References	87

Appendices

Appendix A.	Water Quality Objectives for Bacteria Indicators
Appendix B.	Peer Review Comments and Responses
Appendix C.	Tentative Resolution No. R9-2008-0027 and Basin Plan Amendment
Appendix D.	Data Sources
Appendix E.	Review of Shoreline Bacteria Data
Appendix F.	Wet Weather and Dry Weather Model Configuration, Calibration, and Validation
Appendix G.	Assumptions for Model Development and TMDL Calculation
Appendix H	Existing and Reduced Concentrations-Wet Weather
Appendix I.	EFDC Modeling Results
Appendix J.	Maps of Watersheds for Shoreline Segments
Appendix K.	Load Reduction Analyses
Appendix L.	Existing and Reduced Concentrations-Dry Weather
Appendix M.	Environmental Analysis and Checklist

Figures

Figure 2-1. Location of Shelter Island Shoreline Park within San Diego Bay	12
Figure 2-2. Location of Baby Beach within Dana Point Harbor	13
Figure 4-1. Shelter Island Shoreline Park Bacteria Monitoring Station.....	21
Figure 4-2. Baby Beach Bacteria Monitoring Stations	22

Tables

Table E-1. Percent Wasteload Reductions for Impaired Shoreline Segments at Baby Beach and Shelter Island Shoreline Park	2
Table 2-1. Watershed Areas and Land Use	11
Table 2-2. Beneficial Uses of Shoreline Segments Evaluated	14
Table 2-3. Impaired Waterbodies Addressed in this Analysis	15
Table 3-1. Wet Weather Numeric Targets.....	18
Table 3-2. Dry Weather Numeric Targets.....	18
Table 4-1. Inventory of Data and Information Used for the Source Assessment of Bacteria.....	19
Table 8-1. REC-1 Wet Weather TMDLs for Total Coliform for BB and SISP Shoreline Segments.....	51
Table 8-2. REC-1 Wet Weather TMDLs for Fecal Coliform for BB and SISP Shoreline Segments.....	51
Table 8-3. REC-1 Wet Weather TMDLs for <i>Enterococcus</i> for BB and SISP Shoreline Segments.....	52
Table 8-4. REC-1 Dry Weather TMDLs for Total Coliform for BB and SISP Shoreline Segments.....	54
Table 8-5. REC-1 Dry Weather TMDLs for Fecal Coliform for BB and SISP Shoreline Segments.....	54
Table 8-6. REC-1 Dry Weather TMDLs for <i>Enterococcus</i> for BB and SISP Shoreline Segments.....	55
Table 10-1. State and San Diego Water Board Orders Regulating Applicable MS4 Discharges	63
Table 10-2. Responsible Municipalities.....	64
Table 10-3. Compliance Schedule for Baby Beach to Achieve Wet Weather TMDLs	Error! Bookmark not defined.
Table 10-4. Compliance Schedule for Baby Beach to Achieve Dry Weather TMDLs	Error! Bookmark not defined.
Table 10-5. Compliance Schedule for Shelter Island Shoreline Park to Achieve Wet and Dry Weather TMDLs	Error! Bookmark not defined.
Table 10-4. TMDL Implementation Milestones.....	78
Table 14-1. Public Participation Milestones.....	86

Executive Summary

The purpose of this technical report is to present the development of the Total Maximum Daily Loads (TMDLs) for the shorelines of Baby Beach (BB) within Dana Point Harbor (DPH) and Shelter Island Shoreline Park (SISP) within San Diego Bay (SDB) impaired by indicator bacteria. Baby Beach and Dana Point Harbor are located in southern Orange County and Shelter Island Shoreline Park and San Diego Bay are located within San Diego County. Bacteria densities at these locations have historically exceeded the numeric water quality objectives (WQOs) for total coliform (TC), fecal coliform (FC), and/or *Enterococcus* (ENT) indicator bacteria as defined in the San Diego Water Board's *Water Quality Control Plan for the San Diego Basin (9)* (Basin Plan). These exceedances threaten or impair the water contact (REC-1), non-water contact (REC-2), and shellfish harvesting (SHELL) beneficial uses of these waterbodies.

Fecal bacteria originate from the intestinal flora of warm-blooded animals, and their presence in surface water is used as an indicator of human pathogens. Pathogens can cause illness in recreational water users and people who harvest and eat filter-feeding shellfish. Bacteria have been historically used as indicators of human pathogens because bacteria are easier and less costly to measure than the pathogens themselves. As required by Clean Water Act section 303(d), TMDLs for indicator bacteria were developed to address the bacteria-impaired shoreline segments of BB and SISP.

A TMDL represents the maximum amount of the pollutant of concern that the waterbody can receive and still attain water quality standards. For this indicator bacteria TMDL analysis, only the REC-1 beneficial use was evaluated. Waters that can meet the REC-1 WQOs will also meet the REC-2 WQOs. Waterbodies that are impaired for the SHELL beneficial use will be addressed in a separate SHELL TMDL and/or standards action pending the outcome of the work of the statewide task force involving the Ocean Planning Unit of the State Water Board, the California Department of Public Health, the USEPA, and the coastal Regional Water Boards.

Because the climate in southern California has two distinct hydrological patterns, for the BB and SISP shoreline segments of this project, TMDLs were developed for wet weather and dry weather conditions. For wet weather TMDL calculations, single sample maximum WQOs were used as numeric targets because wet weather conditions, or storm events with precipitation runoff, are episodic and short in duration, and characterized by rapid wash-off and transport of high bacteria loads, with short residence times, from all land use types to receiving waters. For dry weather TMDL calculations, geometric mean or median WQOs were used as numeric targets, because dry weather runoff is not generated from precipitation runoff, is not uniformly linked to every land use, and is more uniform than precipitation runoff, with lower flows, lower loads, and slower transport, making die-off and/or amplification processes more important. Once calculated, the TMDL is set equal to the sum of individual wasteload allocations (WLAs) for point sources, and load allocations (LAs) for nonpoint sources and natural or background sources.

The only point sources identified to affect the shoreline segments of BB and SISP were municipal separate storm sewer systems (MS4s), although other point sources of bacteria may exist. The USEPA's stormwater regulations require municipalities to obtain permits for all stormwater discharges from MS4s. The existing loads estimated were solely the result of watershed runoff, not other types of point sources. Only MS4s were assigned a WLA for each shoreline segment.

Nonpoint sources identified were primarily associated with natural or background sources such as direct inputs from birds, terrestrial and aquatic wildlife, or other unidentified sources within the receiving waters. No controllable nonpoint sources were identified within the watersheds contributing to the receiving waters. Until more information is obtained through further study to provide identification of the relative loading from each of these potential nonpoint sources, they were combined into a single existing load and LA for each shoreline segment.

Because loads from nonpoint sources are not controllable, no load reduction is required from nonpoint sources. However, wasteloads from MS4s are considered controllable and therefore a wasteload reduction was calculated for point sources. Wasteload reductions were calculated for each shoreline segment as the difference between the existing wasteload and WLA divided by the existing wasteload. Table E-1 summarizes the percent wasteload reductions calculated for each shoreline segment of BB and SISP.

Table E-1. Percent Wasteload Reductions for Impaired Shoreline Segments at Baby Beach and Shelter Island Shoreline Park

Waterbody	Shoreline Segment	Percent Wasteload Reduction					
		ENT REC-1		FC REC-1		TC REC-1	
		Wet ¹	Dry ²	Wet ¹	Dry ²	Wet ¹	Dry ²
Dana Point Harbor	Baby Beach	62.2%	96.2%	0%	82.7%	0%	90.4%
San Diego Bay	Shelter Island Shoreline Park	0%	0%	0%	0%	0%	0%

Notes:

¹ Percent wasteload reduction for wet weather conditions.

² Percent wasteload reduction for dry weather conditions.

Abbreviations:

ENT REC-1: *Enterococcus* reduction for water contact beneficial use

FC REC-1: Fecal coliform reduction for water contact beneficial use

TC REC-1: Total coliform reduction for water contact beneficial use

In order to ensure that the TMDL requirements are met, an Implementation Plan was developed and describes the regulatory and/or enforcement actions the San Diego Water Board can take to compel dischargers to reduce pollutant loading and monitor effluent and/or receiving water. The TMDLs will be implemented primarily by reissuing or revising the existing NPDES requirements for MS4 discharges to include WQBELs that are consistent with the assumptions and requirements of the bacteria WLAs for MS4 discharges. WQBELs for MS4 stormwater discharges can be either numeric or non-numeric. Non-numeric WQBELs typically are a program of expanded or better-tailored BMPs. The USEPA expects that most WQBELs for NPDES-regulated MS4 discharges will be in the form of BMPs. Additionally, a compliance schedule for meeting the required pollutant reductions is included in the Implementation Plan. The

Implementation Plan also identifies several special studies that the dischargers can conduct to fill data gaps, which can be used to refine the TMDLs and required load reductions, and/or modify compliance requirements. The Implementation Plan requires the dischargers to conduct monitoring to assess the effectiveness of the implementation measures in achieving the wasteload reductions.

1 Introduction

Fecal bacteria originate from the intestinal flora of warm-blooded animals, and their presence in surface water is used as an indicator of human pathogens. Pathogens can cause illness in recreational water users and people who harvest and eat filter-feeding shellfish. The purpose of this technical report is to present the development of the Total Maximum Daily Loads (TMDLs) for the shorelines at Baby Beach (BB) within Dana Point Harbor (DPH) and Shelter Island Shoreline Park (SISP) within San Diego Bay (SDB) impaired by indicator bacteria.

Section 303(d) of the Clean Water Act requires that each State identify waterbodies within its boundaries for which the effluent limitations are not stringent enough to meet applicable water quality standards, which are based on beneficial uses and water quality objectives (WQOs). The Clean Water Act also requires states to establish a priority ranking for these impaired waters, known as the *Clean Water Act Section 303(d) List of Water Quality Limited Segments* (List), and to establish TMDLs for the identified waterbodies.

Disease-causing pathogens include bacteria, viruses, and protozoa. Most disease-causing pathogens exist in very small amounts and are very difficult and expensive to detect in water samples. However, the presence of disease-causing pathogens in water can be often be correlated to “indicator organisms.” Therefore, indicator organisms are used to help detect the presence of these disease-causing pathogens in water.

Indicator organisms have been used for more than a century to help identify where disease-causing pathogens may be present. These indicator organisms generally do not cause illness themselves, but they have characteristics that make them good indicators that harmful pathogens may present be in the water. Fecal bacteria are often used as indicators for the presence of pathogens. When fecal bacteria are present in surface water in high quantities, this indicates a higher risk of pathogens being present in the water. Total coliform (TC), fecal coliform (FC), *Enterococcus* (ENT), and *Escherichia coli* (*E. coli*), which are fecal bacteria indicators, are often used as indicator organisms, or indicator bacteria, when evaluating the quality of water.

To protect the health of human recreational water users, the Basin Plan contains numeric WQOs for indicator bacteria for water contact recreation (REC-1), non-water contact recreation (REC-2), and shellfish harvesting (SHELL) beneficial uses. For coastal waters, including bays and estuaries, the Basin Plan includes numeric WQOs for TC, FC, and ENT. For saline waters, there are no WQOs for *E. coli*. Exceedances of the bacteria WQOs are common in throughout the San Diego Region coastal area. For a complete discussion of WQOs for each beneficial use, see Appendix A.

TMDLs are being developed to meet the WQOs and protect recreational beneficial uses in the bacteria-impaired waterbodies for the San Diego Region. In a previous analysis reported in *Total Maximum Daily Loads for Indicator Bacteria Project I - Beaches and*

Creeks in the San Diego Region (Bacteria TMDL Project I) (San Diego Water Board, 2007), the California Regional Water Quality Control Board, San Diego Region (San Diego Water Board) developed TMDLs to address 19 of the 38 bacteria-impaired waterbodies in the San Diego Region, as identified on the *2002 Clean Water Act Section 303(d) List of Water Quality Limited Segments*. Regional watershed models were developed to calculate of TMDLs for multiple beaches and creeks in the region.

The present analysis, *Total Maximum Daily Loads for Indicator Bacteria, Baby Beach and Shelter Island Shoreline Park Shorelines*, is based on this previous work, and includes an expansion of the regional modeling approach to represent bacteria loads from the watersheds draining to the impaired BB and SISP shorelines. The bacteria loads from the watershed were used as inputs into a second model used to calculate the assimilative capacity of receiving waters at the impaired BB and SISP shorelines. As in Bacteria TMDLs Project I, TMDLs were calculated for each receiving water body included in this report for both wet and dry weather conditions.

The purpose of a TMDL is to attain WQOs that support beneficial uses in the waterbody. A TMDL is defined as the sum of the individual waste load allocations (WLAs) for point sources and load allocations (LAs) for nonpoint sources and natural background such that the capacity of the waterbody to assimilate pollutant loading (i.e., the loading capacity) is not exceeded.¹ Therefore, a TMDL represents the maximum amount of the pollutant of concern that the waterbody can receive and still attain water quality standards. Additionally, a TMDL represents a strategy for meeting WQOs by allocating quantitative limits for point and nonpoint pollution sources. Once this total maximum pollutant load has been calculated, it is divided up and allocated among all of the contributing sources in the watershed.

The TMDL process begins with the development of a technical analysis which includes the following 7 components:

- (1) **Problem Statement** - describes which WQOs are not being attained and which beneficial uses are threatened or impaired (section 2);
- (2) **Numeric Targets** – identifies numeric targets for densities of indicator bacteria which will result in attainment of the WQOs and protection of beneficial uses (section 3);
- (3) **Source Analysis** - identifies all of the point sources and nonpoint sources of the impairing pollutant (section 5);
- (4) **Linkage Analysis** - calculates the **Loading Capacity** (i.e., the maximum load of the pollutant that may be discharged to the waterbody without causing exceedances of WQOs and impairment of beneficial uses) of the waterbody for the pollutant (sections 6 and 7);
- (5) **Margin of Safety** (MOS) - accounts for uncertainties in the analysis (section 7);
- (6) **Seasonal Variation and Critical Conditions** – describes how these factors are accounted for in the TMDL determination (section 7); and

¹ Code of Federal Regulations Title 40 section 1302.

- (7) **Allocation of the TMDL** – division of the TMDL among each of the contributing sources in the watershed; wasteload allocations (WLAs) for point sources and load allocations (LAs) for nonpoint and background sources (sections 7 and 8).

The write-up of the above components is generally referred to as the technical TMDL analysis. The scientific basis of this TMDL has undergone external peer review pursuant to Health and Safety Code section 57-004. The San Diego Water Board has considered and responded to all comments submitted by the peer review panel. The peer reviewer's comments and the San Diego Water Board's responses to comments are contained in Appendix B.

This technical report also includes an **Implementation Plan** (section 10). In order to meet the TMDL, an Implementation Plan is developed that describes the regulatory and/or enforcement actions the San Diego Water Board can take to compel dischargers to reduce pollutant loading and monitor effluent and/or receiving water. The TMDLs will be implemented primarily by reissuing or revising the existing NPDES requirements for MS4 discharges to include WQBELs that are consistent with the assumptions and requirements of the bacteria WLAs for MS4 discharges. WQBELs for municipal stormwater discharges can be either numeric or non-numeric. Non-numeric WQBELs typically are a program of expanded or better-tailored BMPs. The USEPA expects that most WQBELs for NPDES-regulated municipal discharges will be in the form of BMPs. Additionally, a compliance schedule for meeting the required pollutant reductions is included in the Implementation Plan. The Implementation Plan also identifies several special studies that the dischargers can conduct to fill data gaps, which can be used to refine the TMDLs and required load reductions, and/or modify compliance requirements. The Implementation Plan requires the dischargers to conduct monitoring to assess the effectiveness of the implementation measures in achieving the load and wasteload reductions.

Once established, the regulatory provisions of the TMDLs are incorporated into the *Water Quality Control Plan for the San Diego Basin (9)* (Basin Plan). Typically, the San Diego Water Board, following a public comment period and hearing process, adopts a resolution amending the Basin Plan to incorporate the TMDLs, allocations, reductions, compliance schedule, and Implementation Plan. Basin Plan amendments, including TMDL amendments, must also undergo an evaluation of the environmental impacts of complying with the amendment, and an evaluation of the costs of complying with the amendment. As with any Basin Plan amendment involving surface waters, a TMDL amendment will not take effect until it has undergone subsequent agency approvals by the State Water Resource Control Board (State Water Board) and the Office of Administrative Law (OAL). The U.S. Environmental Protection Agency (USEPA) must also approve the amendment; however, it will take effect following approval by the OAL. The tentative Resolution and draft Basin Plan amendment associated with this project are contained in Appendix C.

Following these approvals, the San Diego Water Board is required to incorporate the regulatory provisions of the TMDL into all applicable orders prescribing waste discharge requirements (WDRs), or other regulatory or enforcement mechanisms. For point sources, the San Diego Water Board will issue, reissue or amend existing WDRs that implement National Pollutant Discharge Elimination System (NPDES) regulations. For nonpoint sources, the San Diego Water Board will issue, reissue, amend, or enforce WDRs, waivers of WDRs, or adopt discharge prohibitions. Water Quality Based Effluent Limitations (WQBELs) for the impairing pollutant in the applicable watersheds are incorporated in the appropriate WDRs to implement and make the TMDLs enforceable. WQBELs can consist of either numeric effluent limitations, or a Best Management Practice (BMP) approach of expanded or better-tailored BMPs.

The final and most important step in the process is the implementation of the TMDLs by the dischargers. Per the governing WDR order (or other regulatory or enforcement mechanism), each discharger must reduce its current loading of the pollutant to its assigned allocation in accordance with the time schedule specified in the TMDL. When each discharger has achieved its required load reduction, water quality standards for the impairing pollutants should be restored in the receiving waters.

Public participation is a key element of the TMDL process, and stakeholder involvement is encouraged and required. The San Diego Water Board formed a Stakeholder Advisory Group (SAG), made up of key stakeholders to assist in the development of this TMDL report. The SAG was comprised of representatives from Municipal Separate Storm Sewer System (MS4) owners/operators discharging to BB and SISF, environmental groups, and business and industry interests, including Orange County, San Diego County, the City of Dana Point, the City of San Diego, San Diego Coastkeeper, Sierra Club and the San Diego Unified Port District.

1.1 Technical Approach

The San Diego Water Board and the USEPA coordinated a watershed and receiving water assessment and modeling study to support the development of TMDLs. In order to assist the San Diego Water Board in the development of the technical analysis, the USEPA used Clean Water Act section 106 funds to contract the environmental consulting firm, Tetra Tech, Inc. (Tetra Tech). Tetra Tech provided the San Diego Water Board with technical assistance in calculating the TMDLs for the impaired waterbodies through the development of region-wide watershed models.

The general approach utilized a watershed model and a receiving water model. The watershed model simulated the pollutant loads draining from the watersheds into the receiving waters. The receiving water model uses the output of the watershed model as a boundary condition, or bacteria load input into the receiving water. The receiving water model was used to calculate the assimilative capacity of the receiving waters at the impaired shorelines. For these TMDLs, the receiving waters are the impaired shoreline segments of BB and SISF, and the watershed are the areas of the watershed that drain directly to those receiving waters.

Because the climate in southern California has two distinct hydrological patterns, two watershed models were developed for estimating bacteria loads. One watershed model was developed to specifically quantify loading from a watershed during wet weather conditions (storm events), which tend to be episodic and short in duration, and characterized by rapid wash-off and transport of very high pollutant loads from all land use types. The wet weather modeling approach is consistent with the methodologies used for bacteria TMDL development for impaired coastal areas of the Los Angeles Region, specifically Santa Monica Bay beaches (Los Angeles Water Board, 2002) and also Malibu Creek (Los Angeles Water Board, 2003), as well as for the bacteria impaired beaches and creeks in the San Diego Region (San Diego Water Board, 2007). A dynamic modeling system that simulates the build-up and wash-off of bacteria and the hydrologic and hydraulic processes that affect delivery was used to model bacteria loads from precipitation-based runoff (stormwater runoff) during wet weather events.

A separate dry weather watershed model was developed to quantify bacteria loading from a watershed during dry weather conditions. Dry weather loading is expected to be much smaller in magnitude, does not occur from all land use types, and exhibits less variability over time. A low-flow, steady-state model was used to estimate bacteria loads during dry weather conditions. The steady-state aspect of the model resulted in estimation of a constant bacteria load from each watershed. This load is representative of the average flow and bacteria loading conditions resulting from various urban land use practices (e.g., runoff from lawn irrigation or sidewalk washing).

The modeled wet weather and dry weather runoff flows and bacteria levels from the watersheds were used in a receiving water model that was developed to include the diurnal effects of tidal flushing, and bacterial die-off during wet and dry weather conditions, and ultimately to simulate the assimilative capacity of the receiving waters of the impaired shoreline segments.

The assimilative capacity, or TMDL that was calculated by the receiving water model was allocated to point sources as WLAs and nonpoint sources as LAs.

2 Problem Statement

The presence of high quantities of bacteria in surface waters can pose a risk to human health. Sources of bacteria under all conditions vary widely and include natural sources such as feces from aquatic and terrestrial wildlife, and anthropogenic sources such as sewer line breaks, illegal sewage disposal from boats along the coastline, trash, and pet waste. Once in the environment, bacteria can also re-grow and multiply.

Of particular concern are disease-causing pathogens. Disease-causing pathogens are a risk to human health in surface waters. When the risk to human health from pathogens in the water is so great that beaches are posted with health advisories or closure signs the quality and beneficial uses of the water are impaired.

At present, analyzing water for specific disease-causing pathogens directly is very difficult and expensive. However, the presence of disease-causing pathogens in water can be often correlated to indicator bacteria, such as TC, FC, and ENT. When these indicator bacteria are present in surface waters in high quantities, this indicates a higher risk of pathogens being present in the water.

Bacteria quantities, written in terms of densities of bacteria colonies (most probable number per 100 milliliters of water [MPN/100 mL]), within specific shoreline segments of BB and SISP reportedly have exceeded the numeric WQOs for TC, FC, and/or ENT indicator bacteria. These exceedances threaten and/or impair the water contact (REC-1), non-water contact (REC-2), and shellfish harvesting (SHELL) beneficial uses of these shorelines. A discussion of WQOs for each beneficial use is provided in Appendix A.

All surface and marine waters in the Region are designated with REC-1, REC-2, and SHELL beneficial uses. REC-1 includes uses of water for recreational activities involving body contact with water (such as swimming or other water sports) where ingestion of water is reasonably possible. REC-2 includes the uses of water for recreational activities involving proximity to water, but not normally involving body contact with water (such as picnicking and sunbathing), and where ingestion of water is not reasonably possible. SHELL includes uses of water that support habitats suitable for the collection of filter-feeding shellfish for human consumption, commercial, or sport purposes.

For this TMDL analysis, only the REC-1 beneficial use was evaluated. Waters that can meet the REC-1 WQOs will also meet the REC-2 WQOs. Waterbodies that are impaired for the SHELL beneficial use will be addressed in a separate SHELL TMDL and/or standards action pending the outcome of the work of the statewide task force involving the Ocean Planning Unit of the State Water Board, the California Department of Public Health, the USEPA, and the coastal Regional Water Boards. The following sub-sections provide additional information about the environmental settings, the

beneficial uses and WQOs, and overview of the reported impairments of the waterbodies evaluated in this technical report.

2.1 Project Area Description

When this project was initiated in 2004, there were six bacteria-impaired shoreline segments on the 2002 List which were to be addressed in this TMDL project: Shelter Island Shoreline Park, B Street Pier, G Street, Chula Vista Marina, and Tidelands Park within SDB, and Baby Beach within DPH. However, since then, additional information provided to the San Diego Water Board resulted in the removal of four shoreline segments from this TMDL project.

The shoreline segments at Chula Vista Marina and Tidelands Park were removed from the 2006 List for indicator bacteria based on REC-1 WQOs. According to the Chula Vista Marina fact sheet for the 2006 List, the area initially placed on the 1998 List was actually south of the Chula Vista Marina, rather than within the marina itself. The area south of the marina was placed on the 1998 List due to posting by the San Diego County Department of Public Health. According to fact sheet, the San Diego County Department of Public Health posted warning signs in the area as a precaution because of a nearby storm drain outlet, not because they had data showing elevated bacteria levels. There are no known data that have been collected to support the listing. Therefore, due to the inaccuracy of the area listed and the lack of data to support the listing, the shoreline segment at Chula Vista Marina within SDB was removed from the 2006 List as impaired for indicator bacteria based on REC-1 beneficial use. The shoreline segment at Chula Vista Marina within SDB was subsequently removed from this TMDL project.

Tidelands Park was also removed from the 2006 List. According to the Tidelands Park fact sheet for the 2006 List, the number of exceedances of the REC-1 WQOs for indicator bacteria from the data collected by the City of San Diego from 1999 to 2003 did not surpass the allowable number of exceedances. Because the available data indicate that the exceedance frequency of the applicable REC-1 WQOs are acceptable, the shoreline segment at Tidelands Park within SDB was removed from the 2006 List as impaired for indicator bacteria based on REC-1 beneficial use. The shoreline segment at Tidelands Park within SDB was subsequently removed from this TMDL project.

In 2007, the San Diego Unified Port District provided analytical data for evaluation to support removing the shoreline segments at B Street Pier and G Street within SDB from the 2008 List based on the WQOs for REC-1 beneficial use. Samples collected from four locations at B Street Pier and four locations at G Street between March 2006 and January 2007 were analyzed. During that sampling period, there were 48 samples collected from each shoreline segment. Of the samples collected between March 2006 and January 2007, the number of exceedances of the REC-1 WQOs for indicator bacteria did not surpass the allowable number of exceedances. Based on these data and findings, the San Diego Water Board will recommend removal of B Street Pier and G Street from the 2008 List for indicator bacteria for REC-1 beneficial use. Therefore,

the shoreline segments at B Street Pier and G Street within SDB were removed from this TMDL project.

The remaining two shoreline segments are addressed in this technical report. They are located in Orange and San Diego Counties in southern California. Shelter Island Shoreline Park is located within SDB, which is located in southern San Diego County (Figure 2-1). Baby Beach is located within DPH, which is located in southern Orange County, just north of San Diego County (Figure 2-2).

Impairment of these shorelines is likely due to local sources of bacteria such as humans, domestic animals, and urban runoff. The assimilative capacity of BB and SISF is increased due to tidal flushing and the likelihood of bacteria die-off due to salinity.

The climate in the region is generally mild with annual temperatures averaging around 65 degrees Fahrenheit near the coastal regions. Annual average rainfall ranges from 9 to 11 inches along the coast to more than 30 inches in the eastern mountains. There are two distinct climatic periods: a dry period from late April to mid-October and a wet period from mid-October through late April. The wet period provides 85 to 90 percent of the annual rainfall in the region (County of San Diego, 2000).

The land use of the region is highly variable. Table 2-1 lists the total areas of each watershed draining to the impaired shoreline segments, as well as their distribution of land uses. The coastline areas are highly concentrated with residential and other urban land uses and the inland areas consist primarily of open space. Most of the contributing areas are residential, commercial or industrial land uses, followed by open space and parks/recreation land uses (Appendix D, No. 14).

Table 2-1. Watershed Areas and Land Use

Watershed		Total Area (Acres)	Land Use Percentages (%)												
			Low Density Residential	High Density Residential	Commercial/ Institutional	Industrial/ Transportation	Military	Parks/ Recreation	Open Recreation	Agriculture	Dairy/ Intensive Livestock	Horse Ranches	Open Space	Water	Transitional
Dana Point Harbor	Baby Beach	522.6	37.1	31.7	15.8	0.7	0.0	3.3	5.7	0.0	0.0	0.0	5.8	0.0	0.0
San Diego Bay	Shelter Island Shoreline Park	10.2	0.0	8.3	0.0	0.0	0.0	91.3	0.0	0.0	0.0	0.0	0.0	0.0	0.0

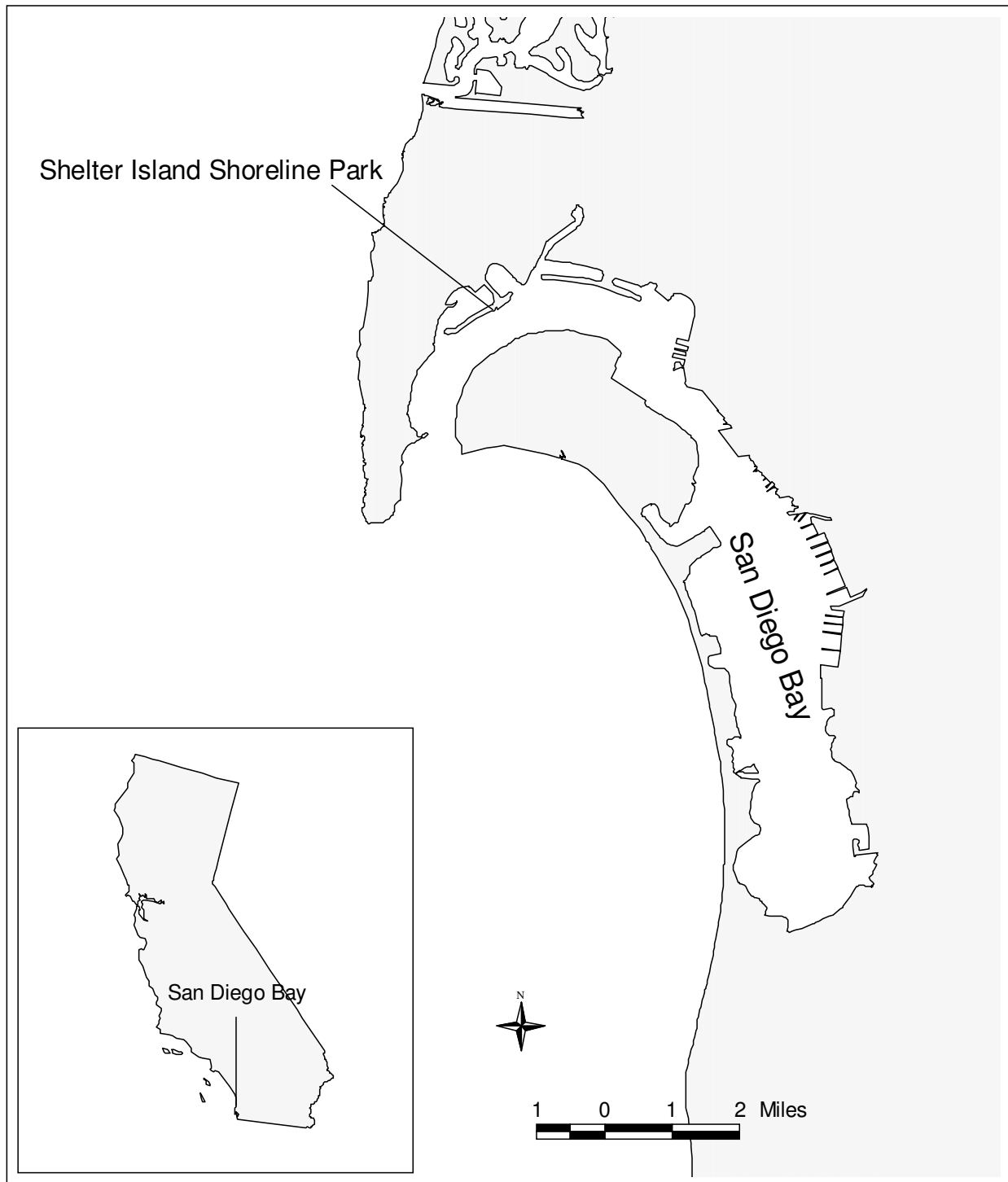

Figure 2-1. Location of Shelter Island Shoreline Park within San Diego Bay

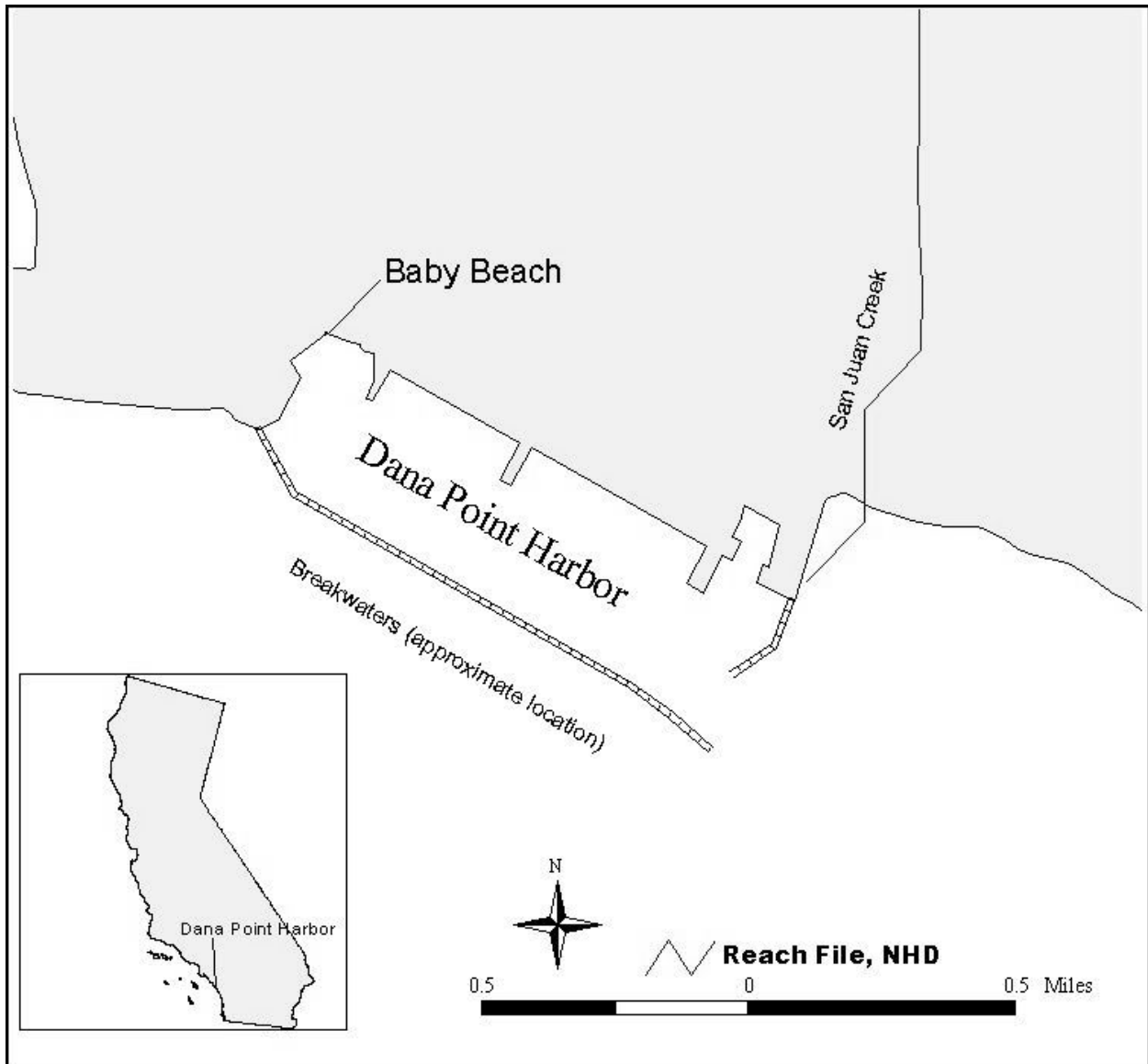

Figure 2-2. Location of Baby Beach within Dana Point Harbor

2.2 Applicable Water Quality Standards

Water quality standards consist of WQOs, beneficial uses, and an antidegradation policy. WQOs are defined under Water Code section 13050(h) as “limits or levels of water quality constituents or characteristics which are established for the reasonable protection of beneficial uses of water.” Under section 304(a)(1) of the Clean Water Act, the USEPA is required to publish water quality criteria that incorporate ecological and human health assessments based on current scientific information. WQOs must be based on scientifically sound water quality criteria, and be at least as stringent as those Clean Water Act criteria.

The Basin Plan identifies beneficial uses and WQOs for each waterbody type. Table 2-2 lists the beneficial uses for each of the shoreline segments evaluated in this technical report.

Table 2-2. Beneficial Uses of Shoreline Segments Evaluated

Waterbody Type	Waterbody	Shoreline Segment Evaluated	Beneficial Uses*
Coastal Water	Dana Point Harbor	Baby Beach	IND, NAV, REC-1, REC-2, COMM, WILD, RARE, MAR, MIGR, SPWN, SHELL
Coastal Water	San Diego Bay	Shelter Island Shoreline Park	IND, NAV, REC-1, REC-2, COMM, BIOL, EST, WILD, RARE, MAR, MIGR, SPWN, SHELL

* Beneficial uses defined in the Basin Plan (San Diego Water Board, 1994)

Only REC-1, REC-2, and SHELL beneficial uses have WQOs for bacteria, which are defined in the Basin Plan. For coastal waters, including bays and estuaries, the Basin Plan contains REC-1 WQOs for TC, FC, and ENT, REC-2 WQOs for FC,² and a SHELL WQO for TC. The objectives are derived from water quality criteria promulgated by the USEPA in 1986. Compliance to numeric WQOs must be assessed and maintained throughout a waterbody to protect beneficial uses, including the shorelines. For a complete discussion of WQOs for each beneficial use, see Appendix A.

As discussed previously, only the REC-1 beneficial use is evaluated in this TMDL project. Waters that can meet the REC-1 WQOs will also meet the REC-2 WQOs. Waterbodies that are impaired for the SHELL beneficial use will be addressed in a separate SHELL TMDL and/or standards action pending the outcome of the work of the statewide task force involving the Ocean Planning Unit of the State Water Board, the California Department of Public Health, the USEPA, and the coastal Regional Water Boards. The numeric WQOs selected as numeric targets for TC, FC, and ENT to calculate TMDLs under wet weather and dry weather conditions are discussed further in section 3.

² Where REC-1 use is not designated.

2.3 Impairment Overview

As discussed in section 2.1, of the six shoreline segments initially considered for this TMDL project, only two segments are now included. These two segments were initially placed on the 303(d) List in 2002. For the 2002 List, coastal waterbodies were evaluated based on the number of days health advisory and closure postings were placed at coastal areas by county health departments. These postings, based on weekly analytical data collected by the county health departments, indicated when waters along a shoreline segment could not be used for recreational purposes, and were thus impaired for REC-1 beneficial use. Beaches with health advisory and/or beach closure signs posted 10 or more days per year were placed on the 2002 List as impaired for REC-1 beneficial use due to indicator bacteria. The raw analytical data were not evaluated during the assembly of the 2002 List.

For this project, the most recent water quality data available at the time of model development in 2004 were used to develop the models. However, because a significant amount of time has elapsed since then, the most recent analytical data at this time were also evaluated against REC-1 WQOs to confirm that the impairments continue to exist. Guidance provided in the State Water Board's *Water Quality Control Policy for Developing California's Clean Water Act Section 303(d) List* was used to confirm impairment of a water body. According to the *Water Quality Control Policy for Developing California's Clean Water Act Section 303(d) List* (Listing Policy), a minimum sample size of 26 samples, with no more than 4 exceedances of the applicable WQOs is needed for recommending the removal of a water body from the 303(d) List. Additionally, there must be enough samples to be temporally and spatially representative.

Table 2-3 lists the impaired waterbodies addressed in this report.

Table 2-3. Impaired Waterbodies Addressed in this Analysis

Waterbody	Hydrologic Descriptor	Segment / Area	Pollutant / Stressor	Extent of Impairment	Year Listed
Dana Point Harbor	Dana Point HSA (901.14)	Baby Beach	Indicator bacteria*	0.4 miles	2002
San Diego Bay	Point Loma HA (908.10)	Shelter Island Shoreline Park	Indicator bacteria*	0.4 miles	2002

* Placed on the 2002 Section 303(d) List based on reported exceedances of TC, FC, and/or ENT REC-1 water quality objectives.

An overview of the rationale for confirming each shoreline segment addressed in this technical report as impaired is provided in the following sub-sections.

2.3.1 Baby Beach Overview

In 2000, the Orange County Environmental Health Care Agency reported that beach closure and/or health risk advisory signs were posted at BB for 54 days. Based on this information, the shoreline segment at BB was placed on the 2002 List as impaired by indicator bacteria for REC-1 beneficial use.

Analytical data were available from the Orange County Environmental Health Care Agency for evaluation. Samples collected from four locations at BB between January 2002 and December 2006 were analyzed. During that sampling period, there were 1,160 samples collected, of which 1,160 samples were analyzed for TC and ENT, and 1,159 samples were analyzed for FC. According to the Listing Policy, to remove a water body from the 303(d) List based on a sample size of 1,159 or 1,160, the number of exceedances allowed is equal to or less than 193.

Of the samples collected between January 2002 to December 2006, indicator bacteria densities exceeded the single sample maximum numeric WQOs for REC-1 beneficial use in 11 of 1,160 samples analyzed for TC, 131 of 1,159 samples analyzed for FC, and 283 of 1,160 samples analyzed for ENT. The number of exceedances for TC and FC are within the number of allowed exceedances to delist for REC-1 beneficial use. However, the number of exceedances for ENT are greater than the number of allowed exceedances to recommend removal from the 303(d) List. This information confirms that BB is impaired for indicator bacteria for REC-1 beneficial use.

2.3.2 Shelter Island Shoreline Park Overview

In 2000, the San Diego County Department of Environmental Health reported that beach closure and/or health risk advisory signs were posted at SISP for 24 days. Based on this information, SISP was placed on the 2002 List as impaired for REC-1 by indicator bacteria.

Analytical data were available from the San Diego Unified Port District and San Diego County Department of Environmental Health for evaluation. Samples collected at SISP between January 2003 and November 2006 were analyzed. During that sampling period, there were 143 samples collected, of which 143 samples were analyzed for TC and ENT, and 105 samples were analyzed for FC. According to the Listing Policy, to remove a water body from the 303(d) List based on a sample size of 105 or 143, the number of exceedances allowed is equal to or less than 17 or 23, respectively.

Of the samples collected between January 2003 and November 2006, indicator bacteria densities exceeded the single sample maximum numeric WQOs for REC-1 beneficial use in 1 of 143 samples analyzed for TC, 16 of 105 samples analyzed for FC, and 24 of 143 samples analyzed for ENT. The number of exceedances for TC and FC are within the number of allowed exceedances to delist for REC-1 beneficial use, however, the number of exceedances for ENT are greater than the number of allowed exceedances to recommend removal from the 303(d) List. This information confirms that SISP is impaired for indicator bacteria for REC-1 beneficial use.

3 Numeric Target Selection

When calculating TMDLs, numeric targets are selected to meet WQOs for a waterbody and subsequently ensure the restoration and/or protection of beneficial uses. TMDLs were calculated for each impaired waterbody. The numeric targets used in the TMDL calculations were selected from the single sample maximum and geometric mean WQOs for REC-1 beneficial uses, as applicable, for TC, FC, and/or ENT indicator bacteria. Because these are saline waterbodies, there are no applicable WQOs for *E. coli* indicator bacteria.

The selected numeric targets were different for wet and dry weather³ because the bacteria transport mechanisms are different under each weather condition. Wet weather runoff, or stormflow runoff, occurs in episodic events that are short in duration, and characterized by rapid wash-off and transport of high bacteria loads, with short residence times, from all land use types to receiving waters. Bacteria densities from a wet weather event are best represented by the single sample maximum WQOs. These WQOs also apply when evaluating shorelines.

During dry weather conditions, dry weather runoff is not generated from stormflows. In contrast, flow during dry weather is typically more uniform than wet weather stormflow, is not uniformly linked to every land use, and has lower flows, lower loads, and slower transport, making bacteria die-off and/or amplification processes more important. Therefore, bacteria densities are usually best represented by the geometric mean WQOs.

However, the bacteria densities along the impaired shoreline segments of BB and SISP are not influenced solely by bacteria loads from watershed runoff flows. Tidal effects for some shorelines have been observed to result in extreme diurnal variations in bacteria densities that can range by orders of magnitude. So, even if the shoreline bacteria densities are in compliance with the 30-day geometric mean, in some cases the maximum hourly concentration predicted in a model could regularly exceed the single sample maximum WQO. Therefore, the single sample maximum WQOs were used in addition to the geometric mean WQOs to set maximum daily bacteria densities allowed under dry weather conditions.

The selected wet and dry weather numeric targets used for calculating TMDLs for the shoreline segments evaluated in this technical report are discussed in the following sub-sections.

³ Wet weather is defined as any day when rainfall results in stormwater runoff, typically the days that precipitation occurs and the 72 hours following the end of the precipitation event. Dry weather is any day of no rainfall and therefore no stormwater runoff. However, runoff may occur during dry periods as a result of urban runoff resulting from irrigation practices or other water uses (e.g., car or sidewalk washing).

3.1 Wet-Weather Targets

All shorelines of SDB and DPH are designated with the REC-1 and REC-2 beneficial uses. Therefore, the shoreline segments evaluated in this technical report are subject to the applicable REC-1 and REC-2 WQOs for TC, FC, and ENT. Waters that can meet the REC-1 WQOs will also meet the REC-2 WQOs. The REC-1 single sample maximum WQOs were selected as numeric targets for wet weather.

The goal of establishing TMDLs is to restore and/or protect the quality and beneficial uses of a waterbody. For REC-1 beneficial use, WQOs have been established in the Basin Plan for TC, FC, and ENT in saline waters. The numeric targets selected for FC, ENT, and TC to calculate wet weather TMDLs are listed in Table 3-1.

Table 3-1. Wet Weather Numeric Targets

Basis for Numeric Target	Total Coliform (TC) (MPN/100mL)	Fecal Coliform (FC) (MPN/100mL)	<i>Enterococcus</i> (ENT) (MPN/100mL)
Beneficial Use	REC-1	REC-1	REC-1
Single sample maximum	10,000	400	104

Abbreviations:

ml: milliliter

MPN: most probable number

REC-1: Contact Water Recreation beneficial use, defined in the Basin Plan (San Diego Water Board, 1994)

3.2 Dry-Weather Targets

As with the numeric targets selected for wet weather, numeric targets for dry weather were selected to be protective of REC-1 and REC-2 beneficial uses. As discussed above, dry weather numeric targets are typically best represented by geometric mean WQOs. However, due to extreme diurnal variations in bacteria densities resulting from tidal effects, in some cases the maximum hourly concentration predicted in a model could regularly exceed the single sample maximum WQOs. Therefore, both the REC-1 30-day geometric mean and single sample maximum WQOs were selected as numeric targets for dry weather.

The numeric targets selected for FC, ENT, and TC to calculate dry weather TMDLs are listed in Table 3-2.

Table 3-2. Dry Weather Numeric Targets

Basis for Numeric Target	Total Coliform (TC) (MPN/100mL)	Fecal Coliform (FC) (MPN/100mL)	<i>Enterococcus</i> (ENT) (MPN/100mL)
Beneficial Use	REC-1	REC-1	REC-1
30-day geometric mean	1,000	200	35
Single sample maximum	10,000	400	104

Abbreviations:

ml: milliliter

MPN: most probable number

REC-1: Contact Water Recreation beneficial use, defined in the Basin Plan (San Diego Water Board, 1994)

4 Data Inventory and Analysis

For the development of the wet weather and dry weather models, data from numerous sources (Appendix D) were used to characterize the watersheds and water quality conditions, identify sources of bacteria, and support the TMDL calculations. There were no new data collected as part of this data analysis effort. The data analysis provided an understanding of the conditions that resulted in the reported impairments (Appendix E).

4.1 Data Inventory

The categories of data used in developing these TMDLs include physiographic data that describe the physical conditions of the watershed, and environmental monitoring data that identify past and current conditions and support the identification of potential pollutant sources. Table 4-1 presents the various data types and data sources used in the development of these TMDLs. The following sub-sections describe the key data sets used for TMDL development.

Table 4-1. Inventory of Data and Information Used for the Source Assessment of Bacteria

Data Set	Type of Information	Data Source(s)
Watershed physiographic data	Location of dams	USEPA BASINS
	Stream network	USEPA BASINS (Reach File, Versions 1 and 3); USGS NHD reach file; special studies of Aliso Creek, Tecolote Creek, and Rose Creek; SANGIS
	Land use	2000 land use coverage for San Diego County (SANDAG); 1993 land use coverage of Orange and portions of Riverside Counties (SCAG)
	Counties	USEPA BASINS
	Cities/populated places	USEPA BASINS, U.S. Census Bureau's Tiger Data
	Soils	USEPA BASINS (USDA-NRCS STATSGO)
	Watershed boundaries	USEPA BASINS (8-digit hydrologic cataloguing unit); CALWTR 2.2 (1995)
Topographic and digital elevation models (DEMs)	USEPA BASINS; USGS	

Table 4-1. Inventory of Data and Information Used for the Source Assessment of Bacteria (Cont'd)

Data Set	Type of Information	Data Source(s)
Environmental monitoring data	Water quality monitoring data	USEPA STORET; California Department of Environmental Health; County of San Diego Department of Environmental Health; Orange County Public Facilities and Resources Department; City of San Diego; Orange County Public Health Laboratory, San Diego Water Board; NAVFAC-SW; SPAWAR; San Diego Unified Port District
	Streamflow data	USGS; Orange County Public Facilities and Resources Department; City of San Diego
	Meteorological station locations	BASINS; NOAA-NCDC; CIMIS; ALERT Flood Warning System; California DWR, Division of Flood Management

Abbreviations/Acronyms:

ALERT: Automatic Local Evaluation in Real-Time
 BASINS: Better Assessment Science Integrating Point and Nonpoint Sources System
 CALWTR: Calwater
 CIMIS: California Irrigation Management Information System
 DWR: Department of Water Resources
 NAVFAC-SW: Naval Facilities Engineering Command, Southwest Division
 NCDC: National Climatic Data Center
 NHD: National Hydrography Dataset
 NOAA: National Oceanic and Atmospheric Administration

NRCS: National Resources Conservation Service
 SANDAG: San Diego Association of Governments
 SANGIS: San Diego Geographic Information Source
 SCAG: Southern California Association of Governments
 SPAWAR: Space and Naval Warfare
 STATSGO: State Soil Geographic database
 STORET: Storage and Retrieval environmental data system
 USDA: United States Department of Agriculture
 USEPA: United States Environmental Protection Agency
 USGS: United States Geological Survey

4.1.1 Water Quality Data

For the development of the wet weather and dry weather models, water quality data available at the time of model development for the shoreline segments of SDB and DPH were obtained from the County of San Diego and the Orange County Public Health Laboratory, respectively (Appendix D, No. 3-4), for use in wet weather and dry weather model calibration and validation processes. At the time of model development, analytical data were available for SISP (one sampling location) and BB (four sampling locations). See Figures 4-1 and 4-2 for sampling locations. Bacteria data from these shoreline segments (including FC, TC, and ENT) used in the development of the models were collected at various times from 1996 through 2004, and the amount of data varied among sampling locations.

4.1.2 Waterbody Characteristics

The assessment of waterbody characteristics involved the evaluation of physical data such as bathymetry and water surface elevations and hydrodynamic data including currents, tidal velocities, and BB and SISP outflows. This information was used to determine the volume and hydrodynamic features of the waterbodies, which were included in the calculation of the assimilative capacity and identification of the physical processes that affect bacteria loading.

No recorded streamflow data were identified for the watersheds draining to the impaired shorelines. However, regionally calibrated hydrologic models developed in Bacteria TMDL Project I were able to be used to provide much information regarding the hydrologic characteristics in these watersheds.

Bathymetry data for BB and SISP were based on Digital Raster Graphs (DRG), obtained from California Spatial Information Library (CASIL) (Appendix D, No. 12). A complete discussion of the data is provided in the modeling report in Appendix F.

Hydraulic data, such as water surface elevations, used for the hydrodynamic model were obtained from the National Oceanic and Atmospheric Administration (NOAA) Center for Operational Oceanographic Products and Services (COOPS) (Appendix D, No. 2).

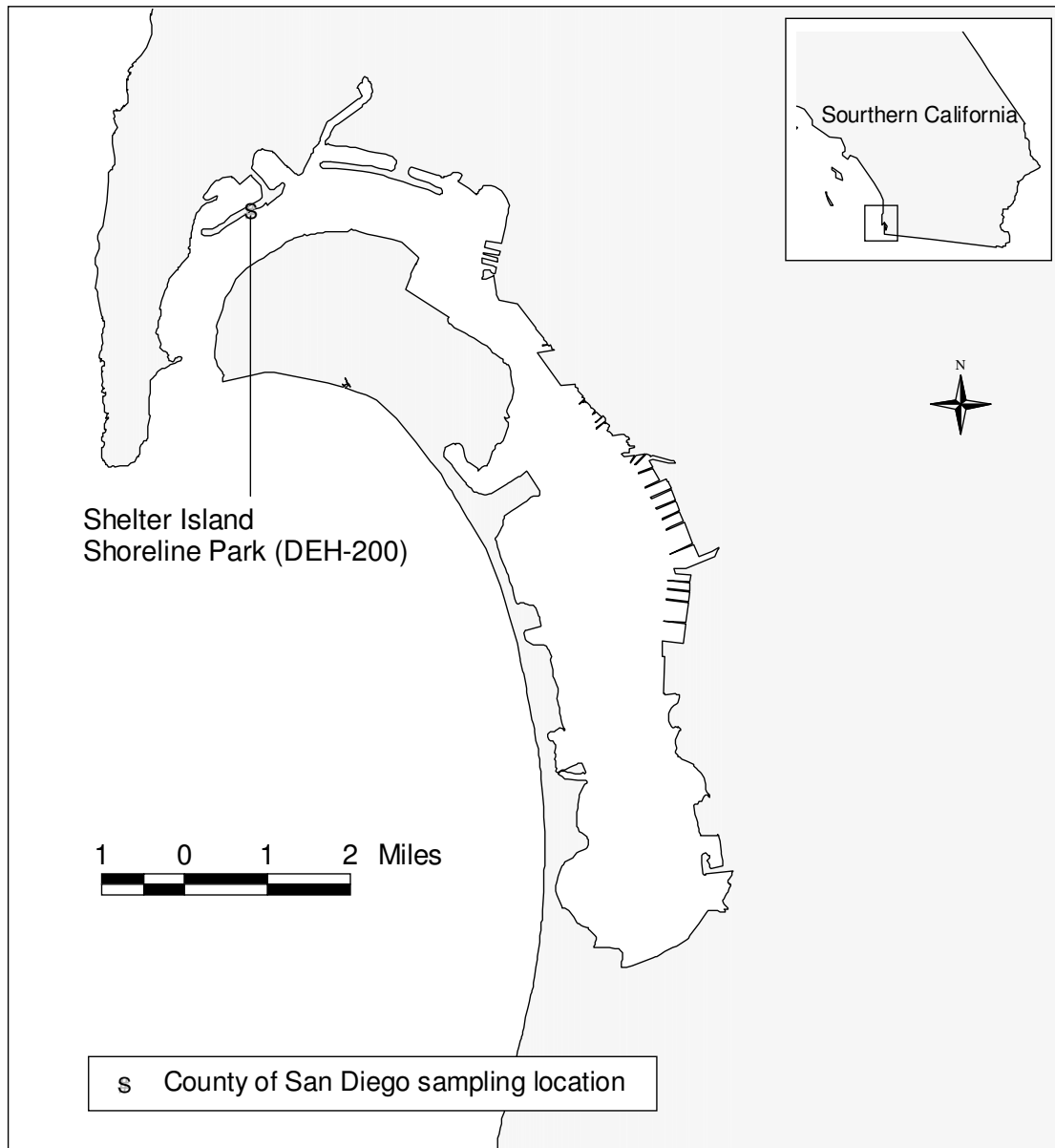

Figure 4-1. Shelter Island Shoreline Park Bacteria Monitoring Station

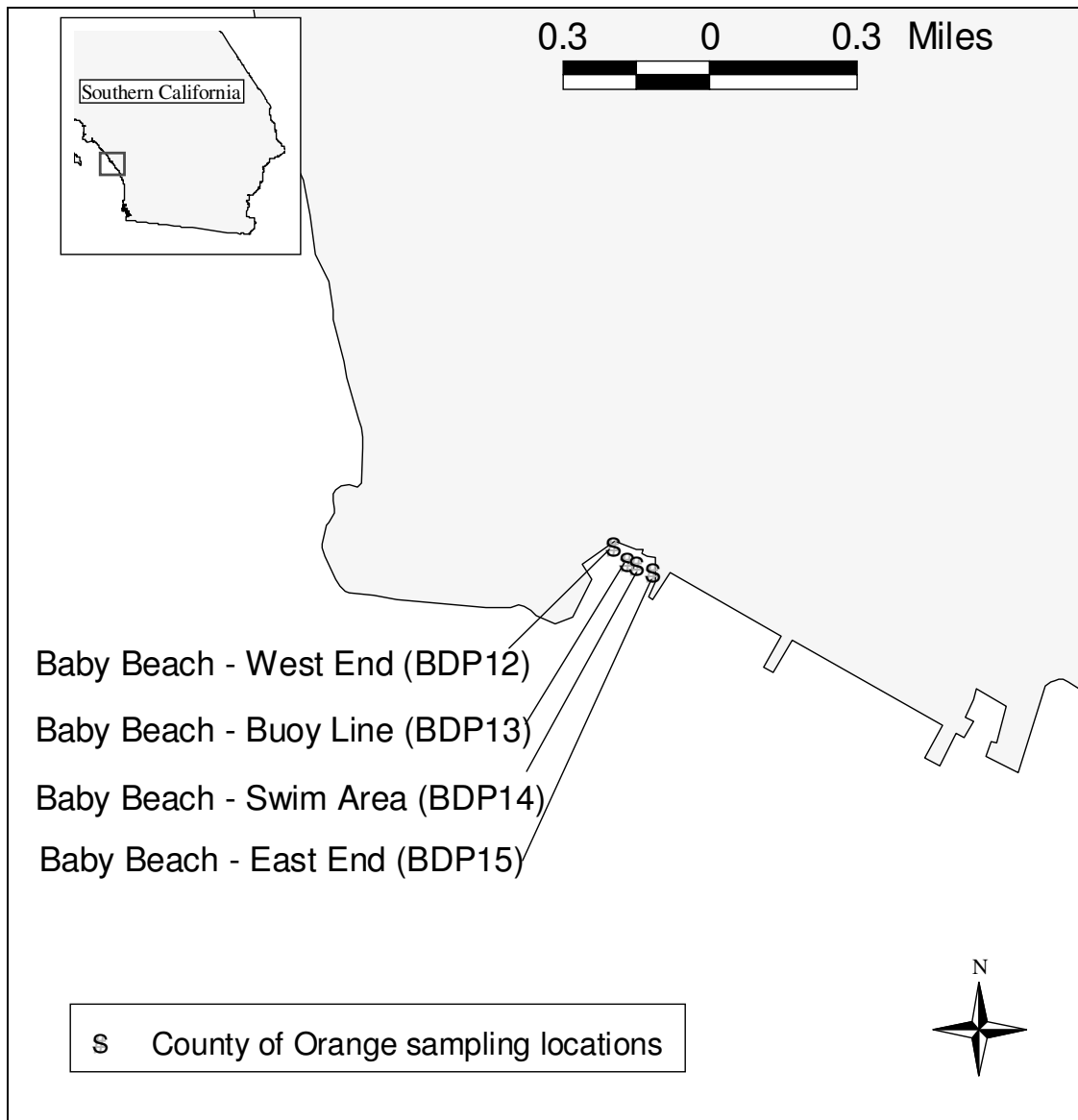

Figure 4-2. Baby Beach Bacteria Monitoring Stations

4.1.3 Meteorological Data

Hourly rainfall data were obtained from the National Climatic Data Center (NCDC) of the NOAA. To augment the NCDC data, hourly rainfall data were obtained from the Automatic Local Evaluation in Real-Time (ALERT) Flood Warning System. In addition, hourly evapotranspiration data were obtained from the California Irrigation Management Information System (CIMIS) (Appendix D, No. 9-11).

Apart from rainfall and evapotranspiration data, other meteorological data such as temperature, humidity, wind speed, wind direction, atmospheric pressure and cloud cover data were obtained from NOAA-NCDC (Appendix D, No. 9). These data were used to drive the hydrodynamic receiving water models.

4.1.4 Land Characteristic Data

Available land use data to support this study included the San Diego Association of Governments (SANDAG) Regional Planning Agency's land use data set that covers San Diego County, and the Southern California Association of Governments (SCAG) land use data set for Orange County. A combination of SANDAG and SCAG data was used to provide the most complete and up-to-date land use representation of the region at the time of model development (Appendix D, No. 14).

In addition, soil data were obtained from the U.S. Department of Agriculture (USDA) Natural Resources Conservation Service (NRCS) State Soil Geographic (STATSGO) database and topographic information was obtained from the USEPA's Better Assessment Science Integrating Point and Nonpoint Sources (BASINS) system (Appendix D, No. 15-16).

4.2 Review of Shoreline Water Quality

Bacteria water quality data for BB and SISP shorelines available at the time of model development (Appendix D, No. 3-4) were analyzed to provide insight into the spatial extent of impairment and the timing of any exceedances of WQOs. Results of this analysis were also used in the source assessment to identify the proximity of listed coastal segments to tributaries, outfalls, and other potential sources (see section 5).

The timing of exceedances of WQOs and the relationship to wet and dry conditions are important considerations for evaluation of impairments. Monitoring data from both BB and SISP shorelines were reviewed based on their association with wet or dry periods to better understand variability during periods when transport methods differ (wet weather runoff versus dry weather runoff). For each monitoring station, sampling dates were compared to rainfall data collected at the closest rainfall gage to determine whether bacteria water quality samples had been collected during wet or dry weather periods. Once the data for all sampling stations were identified as wet or dry, they were evaluated against the associated single sample maximum and/or 30-day geometric mean WQOs.

Results of analyses at SISP and four locations at BB are illustrated in Appendix E. These results show multiple exceedances of WQOs during both wet and dry weather periods. Typically, higher levels of indicator bacteria appear correlated with wet weather periods, although peak concentrations during dry weather also exceeded WQOs. Specific results of the data analysis for BB and SISP are discussed in the following sub-sections.

4.2.1 Baby Beach Water Quality

Water quality data were available from four locations along BB (Figure 4-2). At the time of model development, both wet weather and dry weather conditions appeared to be well represented and trends were found for bacteria densities with relation to weather. Exceedances of both the single sample maximum and 30-day geometric mean REC-1 WQOs were observed at all four sampling locations and for all indicator bacteria.

Results of the water quality data analysis show that, with the exception of geometric means calculated for TC bacteria densities at BB-West End, the percentage of wet weather samples in exceedance of wet weather WQOs was consistently greater than the percentage of dry samples in exceedance at all sampling locations along BB and for all measured indicator bacteria (Appendix E). This was true for indicator bacteria densities compared to both the single sample maximum and the 30-day geometric mean REC-1 WQOs. In addition, spatial trends show that percent exceedances of both the single sample maximum and 30-day geometric mean REC-1 WQOs tend to be higher at the western locations of BB than in the eastern locations.

4.2.2 Shelter Island Shoreline Park Water Quality

Water quality data were available from one location for SISP (Figure 4-1). Most water quality samples were collected during dry weather conditions at SISP. A small number (approximately 1.5 percent) of the samples were collected during wet weather conditions (Appendix E).

With regards to wet weather, water quality data collected at SISP were limited. Those samples collected during wet weather and the geometric means that were calculated over a wet weather period tended to be higher than many of the dry weather samples and geometric means calculated over a dry weather period (Appendix E). Wet weather bacteria densities were not well represented, making it difficult to document the trends in bacteria densities with regards to wet weather periods at the SISP location.

Exceedances of the single sample maximum REC-1 WQOs were observed for all indicator bacteria under both wet and dry weather conditions. Also for both weather conditions, exceedances of the 30-day geometric mean REC-1 WQOs for TC and/or ENT were observed. However, no exceedances of the 30-day geometric mean REC-1 WQOs were observed for FC at either location under wet or dry weather conditions.

5 Source Analysis

This section presents the approach used to identify and quantify the sources of bacteria that can contribute to the bacteria loading along the BB and SISP shorelines. Bacteria can enter surface waters from both nonpoint and point sources. Nonpoint sources are typically diffuse sources that have multiple routes of entry into surface waters. Nonpoint sources can include encampments of homeless persons, or direct input to waterbodies from birds, terrestrial and aquatic wildlife, or other unidentified sources within the receiving waters. Point sources typically discharge at a specific location from pipes, outfalls, and conveyance channels from municipal wastewater treatment plants, industrial waste treatment facilities, or Municipal Separate Storm Sewer System (MS4) discharges. Point sources can include residential sewage disposal from illicit connections to stormwater conveyance systems and illegal discharge of sewage from boats along the coastline.

Sources of bacteria are the same under both wet weather and dry weather conditions. For both wet weather and dry weather conditions, there are natural and background sources of bacteria within the receiving waters at the impaired shoreline segments. However, for sources of bacteria that originate from the watersheds draining into the receiving waters, the method of transport for the two conditions is very different. Wet weather loading originating from the watersheds is dominated by episodic storm flows that wash off bacteria that build up on the surface of all land use types in a watershed during dry periods. Dry weather loading originating from the watersheds is dominated by nuisance flows from urban land use activities such as car washing, sidewalk washing, and lawn over-irrigation, which pick up bacteria and deposit it into receiving waters. These types of nuisance flows are generally referred to as urban runoff. Because the relative loads from bacteria sources vary significantly between wet weather events and dry weather conditions, load assessment required separate wet and dry weather analyses. For this reason, two distinct modeling approaches were used to assess bacteria loading and TMDLs. These modeling approaches are described in the Linkage Analysis in section 6.

The following sub-sections discuss nonpoint and point sources and their relative significance as contributors of bacteria to surface waters during wet and dry weather conditions as they were incorporated into the TMDL calculations.

5.1 Nonpoint Sources

The primary nonpoint sources identified for the BB and SISP shorelines were associated with natural sources (such as birds, terrestrial and aquatic wildlife, or other sources within the water), as well as the potential contribution from encampments of homeless persons. These nonpoint sources are discussed below.

5.1.1 Natural Sources

Direct input of waste from birds, terrestrial and aquatic wildlife, and other sources within the water to the waterbodies can be a significant source of bacteria during both wet and dry weather conditions. Studies have shown that waterfowl can potentially contribute significant loads of bacteria directly to coastal waters (Fleming and Fraser, 2001; Grant et al., 2001; City of San Diego, 2004). In a study of bacteria levels in Mission Bay during dry weather conditions conducted by the City of San Diego (2004), results of DNA typing showed that waterfowl were the main source of indicator bacteria in the bay and stormwater conveyance system discharge. Although birds were the primary type of wildlife observed in Mission Bay, the results also showed that marine mammals contribute at least 5 percent of indicator bacteria found in the bay. This percentage likely would be higher if the marine mammal population density is higher.

In the San Diego Region, shorelines are frequented by large populations of waterfowl that can contribute fecal matter directly to the shoreline areas. Bacteria loads from this fecal matter can be transported to the coastal waters from tidal fluctuations during dry weather conditions, as well as during wet weather stormflows. In addition, marine mammals (such as seals) have been observed at impaired shorelines in numbers that suggest they could also be a significant source of bacteria.

For dry weather TMDL calculations, when incoming flows from the watershed are relatively low, impacts to the BB and SISP shorelines were considered to be primarily due to direct contribution of fecal bacteria from waterfowl on to the shorelines, which are washed into the shoreline surface water by tidal fluctuations. For wet weather TMDL calculations, in addition to the bacteria that have accumulated in the watershed and are washed off with stormflow runoff, the contribution of fecal bacteria from waterfowl on to the shorelines would also be a relatively significant source.

Other sources of bacteria within the water (such as aquatic plants and aquatic wildlife) may contribute to the bacteria levels within the waterbodies during both wet and dry weather conditions. All of these natural sources of bacteria discussed above can be significant, but are largely uncontrollable.

5.1.2 Encampments (Homeless Persons)

Encampments of homeless persons were identified as a potential nonpoint source of bacteria in the watersheds of BB and SISP. Bacteria loads from homeless encampment populations are usually inland and not right on the shore, where tidal fluctuations can wash human fecal matter into the shoreline surface water. Therefore, this nonpoint source was not included in the dry weather TMDL calculations.

However, during wet weather (storm) periods, wash-off from encampments of homeless persons can potentially contribute elevated bacteria loads to waterbodies due to improper disposal of human waste. Such bacteria contributions are extremely difficult to quantify from analysis of homeless encampment populations. Instead, bacteria loads from homeless encampments were considered to be included within the urban runoff

characterized through the watershed modeling analysis of wet weather conditions (Appendix F). Urban runoff from these areas was considered along with stormwater runoff and was categorized as point source discharges through National Pollutant Discharge Elimination System (NPDES) requirements for MS4 discharges, as discussed in section 5.2.

Direct discharges of fecal matter from homeless encampments were not included explicitly in wet weather TMDL calculations. If bacteria loads from encampments of homeless persons result from direct discharge of human fecal matter to the shoreline waterbodies, a 100 percent reduction would be required for implementation of the dry and wet weather TMDLs.

5.2 Point Sources

A point source, according to federal regulations [Code of Federal Regulations Title 40 section 122.3], is defined as “any discernable, confined, and discrete conveyance, including but not limited to, any pipe, ditch, channel, tunnel, conduit, well, discrete fissure, container, rolling stock, concentrated animal feeding operation, landfill leachate collection system, vessel, or other floating craft from which pollutants are or may be discharged.” Potential point sources identified for the BB and SISP shorelines are discussed below.

5.2.1 Wastewater Treatment Plants

There are no direct point source discharges of bacteria from wastewater treatment plants to the BB and SISP shorelines. However, bacteria loads periodically occur as a result of sewage spills. Although these loads potentially result in contamination of the waterbodies and bacterial concentrations that exceed WQOs, the loads attributed to these sources were not quantified for TMDL development. Because loads from sewage spills are accidental, estimation of the load reductions required to meet TMDLs is not required. One hundred percent reduction of bacteria loads from sewage spills is required for implementation of the dry and wet weather TMDLs.

5.2.2 Illegal Sewage Discharge from Boats

Illegal discharge of sewage from boats has been identified as a potential point source of bacteria in the receiving waters of the BB and SISP shorelines. While these bacteria loads may potentially be a large source of the existing bacteria in these waterbodies, the loads attributed to these sources were not quantified for the TMDL. Because loads from sewage discharge directly to BB and SISP are illegal, 100 reduction of bacteria loads from boats would be required for implementation of the dry and wet weather TMDLs.

5.2.3 Municipal Separate Storm Sewer Systems (Urban Runoff)

Urban runoff discharges from MS4s are a leading cause of receiving water quality impairments in the San Diego Region. A direct linkage has been established between

human illness and recreating near the outfalls of urban stormwater conveyance systems (San Diego Water Board, 2001 and 2002a).

For the San Diego Region, all discharges of urban runoff are covered by MS4 NPDES waste discharge requirements. For the watersheds of San Diego County, the incorporated cities of San Diego County (18 cities), the San Diego Unified Port District, and the San Diego County Regional Airport Authority, Order No. R9-2007-0001 defines the NPDES waste discharge requirements for MS4s. For the watersheds of Orange County, the incorporated cities of Orange County (11 cities), and the Orange County Flood Control District, Order No. R9-2008-0001 defines the NPDES waste discharge requirements for MS4s.

The watersheds draining into the impaired shoreline segments addressed in this TMDL discharge directly from the MS4 storm drain systems into BB and SISF, and not via any streams or creeks. Urban runoff discharged by MS4s is different depending on wet or dry weather conditions. Runoff under these weather conditions are discussed below.

5.2.3.1 Wet Weather Urban Runoff

During wet weather conditions (storm events), wash-off of bacteria from various land uses is considered to be the primary mechanism for transport of bacteria. After bacteria build up on the land surface as a result of various land use sources and associated management practices (e.g., pet waste in residential areas), much of the bacteria is washed off of the land surface during storm events into the MS4 storm drain systems. The amount of runoff and associated bacteria densities are therefore highly dependent on land use.

5.2.3.2 Dry Weather Urban Runoff

During dry weather conditions, many streams in the San Diego Region exhibit a sustained flow even if no rainfall has occurred for a significant period to provide precipitation-based runoff or groundwater flows. These dry weather flows are generally understood to result from various urban land use practices that cause water to enter MS4s. Such land use practices include landscape irrigation, car washing, sidewalk washing, and the like. As these urban runoff flows travel across lawns and urban surfaces, bacteria are carried from these areas to the receiving waterbody.

Studies performed at other waterbodies (Aliso Creek, San Juan Creek, Tecolote Creek, and Rose Creek) for Bacteria TMDLs Project I (San Diego Water Board, 2007) found that urban runoff and associated bacteria levels during dry weather conditions could be estimated from land use information in a given watershed. This observance was validated in Bacteria TMDLs Project I through an analysis of dry weather data collected throughout the San Diego Region that led to development of a regional model for estimation of dry weather flows and bacteria levels.

6 Linkage Analysis

The analysis of the relationship between bacteria loading and the waterbody response to this loading is referred to as the linkage analysis. The linkage analysis results in the calculation of a numeric value for the total amount of loading of a pollutant that a waterbody can receive and still meet water quality standards. This numeric value becomes the TMDL of a pollutant for a waterbody. Because the TMDL calculations are based on numeric WQOs that support the beneficial uses, attainment of the TMDL numeric values will result in attainment of water quality standards. Likewise, attainment of the water quality standards, specifically WQOs that support the beneficial uses, will result in attainment of the TMDL.

After the TMDL for a waterbody is calculated, the allowable pollutant loading is allocated among the sources that contribute a pollutant load to the waterbody. The TMDL is allocated to nonpoint sources and point sources. The pollutant loads that are attributed and allocated to nonpoint sources are known as load allocations (LAs). The pollutant loads that are attributed and allocated to point sources are known as wasteload allocations (WLAs).

Existing pollutant loads are compared to the TMDL. If the existing pollutant loading exceeds the TMDL, load reductions are required to meet the water quality standards. Controllable sources of pollutants are identified, and load reductions are calculated in order to meet the LA or WLA for each controllable pollutant source.

Due to the complex interactions that bacteria can have with the environment, a model is typically required to perform the linkage analysis and TMDL calculation. A model mathematically represents environmental processes, which can be used to evaluate the way pollutants interact with the environment.

A model can be very simple or extremely complex, requiring more time and resources as more parameters are included in the model. The simpler a model is the fewer model parameters and the higher the uncertainty in the results, which means a larger explicit margin of safety is required to account for the uncertainties. As more parameters are included in the model, the uncertainty may be reduced and the explicit margin of safety required may be reduced or eliminated. Unfortunately, uncertainty in a model can never be completely removed, just like in reality. However, models can be developed with enough parameters to approximate a system and provide results that can help in the management of a system. Therefore a model must include enough parameters that can be meaningfully used in the management of a system.

Models require some parameter data to develop a modeling system. For TMDL calculation, the model parameters are used in mathematical equations that provide the instructions for how the pollutants and environmental processes interact with each other. The model is used to simulate reality as well as possible. How well a model

simulates reality is assessed by comparing the output the model produces to actual measurements.

Actual measurements are used to calibrate the model, meaning setting up the model to have an output that closely approximates the actual measurements. Then another set of actual measurements is used to validate the model, meaning the results of the calibrated model are examined to see how well the calibrated model output compares to actual measurements. The more actual data available for model calibration and validation, the better a model can be used to predict and represent reality. So, a model can be developed and compared to available hydrologic and water quality data to calibrate and validate it for use in calculating a TMDL for a waterbody.

For the BB and SISP shoreline segments, modeling approaches were evaluated for calculating the bacteria loading from nonpoint and point sources, and simulating the effects on the receiving waterbody. As discussed in section 5, the bacteria loading from nonpoint and point sources to the BB and SISP shorelines can vary significantly depending on wet weather or dry weather conditions. Therefore, for the calculation of these TMDLs, a distinction is made between wet weather and dry weather periods, because bacteria density and implementation measures will vary between the two conditions. As a result, separate modeling approaches were used for calculating bacteria loads and TMDLs under each weather condition. The criteria considered for model selection, and the wet weather and dry weather models selected for TMDL calculations are discussed in the following sub-sections.

6.1 Model Selection Criteria

In selecting an appropriate modeling approach for TMDL calculation, technical and regulatory criteria were considered. Technical criteria include the physical system in question (watershed and receiving water characteristics and processes) and the pollutant or constituent of interest (bacteria). Regulatory criteria include water quality standards (beneficial uses and numeric WQOs). Based on these criteria, modeling approaches were identified for both wet weather and dry weather conditions to be used in the TMDL calculations for the BB and SISP shorelines. These criteria are discussed in detail below.

6.1.1 Technical Criteria

There are four main criteria considered when selecting a model for TMDL calculation: 1) physical domain, 2) source contributions, 3) critical conditions, and 4) model variables. Consideration of each criterion is critical in selecting the most appropriate modeling approach to address the types of sources and the numeric targets associated with the listed waters.

6.1.1.1 Physical Domain

Representation of the physical domain is perhaps the most important consideration in model selection. The physical domain is the focus of the modeling effort. The physical domain typically consists of either the receiving water itself or a combination of the

contributing watershed and the receiving water. Selection of the appropriate physical domain for modeling depends on the constituents and the conditions under which the waterbody exhibits impairment.

In the environmental setting found in the San Diego Region, two physical domains have been recognized that require specific model requirements to address key physical and environmental conditions. As discussed above, sources of pollutant loading can vary significantly depending on wet weather or dry weather conditions. The physical domain and processes differ significantly between wet weather and dry weather conditions.

Under dry weather conditions, pollutant loads are typically generated by discharges from specific land uses with low-flow conditions. Under this setting, a steady-state approach is typically used, which assumes a constant or average flow and pollutant load. If a system also includes tidal influences, a quasi-steady-state approach may be used, which includes the variability in hydrodynamics due to tidal effects in addition to the steady-state point source inputs. The steady-state and quasi-steady-state modeling approaches primarily focus on receiving water processes during a user-specified condition.

Under wet weather conditions (storm events), most of the pollutant loads are generated by storm water runoff discharges from all land uses that can vary over the course of a storm. Under this setting, a dynamic modeling approach is typically most appropriate. Dynamic models can consider time-variable pollutant contributions from a watershed surface and/or subsurface, as well as the hydrodynamic response of the receiving water. Some dynamic models consider monthly or seasonal variability, while others enable assessment of conditions immediately before, during, and after individual rainfall events. Dynamic models require a substantial amount of information regarding input parameters and data for calibration and validation processes.

6.1.1.2 Source Contributions

Primary pollutant sources must be considered in the model selection process. Representing contributions from nonpoint and point sources as accurately as possible is critical in properly representing the system and assigning LAs and WLAs.

6.1.1.3 Critical Conditions

The goal of a TMDL analysis is to determine the loading capacity, or assimilative capacity, of a waterbody and to identify potential allocation scenarios that will enable that waterbody to achieve water quality standards (numeric WQOs that support applicable beneficial uses). The TMDL must be conservative enough to be protective of water quality under the most critical conditions. In other words, a TMDL must be protective of the period of time and location in which the waterbody exhibits the most vulnerability.

For dry weather conditions, dry weather models typically are assumed to have a steady-state flow and pollutant load. Therefore, a dry weather model may not have a specific

period of time in which a waterbody is most vulnerable. However, there may be a location where the pollutant loading may be expected to be the most concentrated, thus most vulnerable to violating water quality standards. Additionally, with tidally influenced systems, there may be a tidal period when a waterbody is most vulnerable.

For wet weather conditions, critical conditions are typically associated with extreme rainfall conditions, when the highest pollutant loads may be washed off of land surfaces to the receiving water and the receiving water is most vulnerable to violating water quality standards. Critical conditions under wet weather conditions will also have a location where the pollutant loading may be expected to be the most concentrated and most vulnerable to violating water quality standards. Therefore, for our modeling purposes, critical conditions include a critical period of time and a critical location when and where a modeled system is most vulnerable to violating the water quality standards.

6.1.1.4 Model Variables

Another important consideration in model selection and application are the model variables required to assess and simulate the fate and transport of pollutant(s) in the watershed and/or waterbody. Selection of the model state variables is a critical part of developing the model. A state variable is any variable which represents the state of an object or system. The more state variables included, the more complex the model becomes, and the more difficult the model will be to apply and calibrate. However, if key state variables are omitted from the model, the simulation might not include all the necessary aspects of the modeled system and might produce unrealistic results. A delicate balance must be met between minimal number of variables and maximum applicability of the model.

The focus of this TMDL analysis is on indicator bacteria. Receiving water bacteria dynamics can be extremely complex, and accurate estimation of bacteria densities relies on a host of interrelated environmental variables. Environmental variables that can affect the survival of bacteria include soil moisture content, pH, solar radiation, available nutrients, and salinity, among others. Bacteria densities in the water column are also influenced by die-off, regrowth, partitioning of bacteria between water and sediment during transport, as well as bacteria and sediment settling and resuspension of bottom materials.

First-order die-off is likely the most important dynamic to simulate in the watersheds and receiving waters. Salinity in the tidally influenced BB and SISP shoreline segments would also require simulation to represent the impact of salinity on bacterial die-off rates. The impact of temperature on bacterial die-off rates can also be considered. However, the limited available data provide few insights into which of the other environmental variables mentioned above might be most influential on bacterial behavior for the models. To account for these other environmental variables, certain assumptions were made for the model. A description of assumptions regarding these environmental variables is described in Appendix G.

6.1.2 Regulatory Criteria

The Basin Plan establishes, for all waters in the San Diego Region, the beneficial uses for each waterbody to be protected, the numeric WQOs that are considered protective of those beneficial uses, and an implementation plan that accomplishes those objectives. A properly designed and applied model provides the source-response linkage component of the TMDL calculation, and enables an accurate assessment of the assimilative capacity of a waterbody. The assimilative capacity, or TMDL, of a receiving water is based on the assumption that the numeric WQOs are met.

The selected modeling approach must enable direct comparison of model results to actual measurements of receiving water bacteria densities and allow for the analysis of the duration of those densities. For the watershed loading analysis and implementation of measures required to reduce pollutant loads, it is also important that the modeling approach enable examination of gross land use loading as well as urban runoff bacteria densities.

6.2 Receiving Water Modeling Approach

Based on the criteria discussed above, separate modeling systems were selected to simulate pollutant loading to the receiving waters during dry weather and wet weather conditions. Different watershed models were selected and developed to simulate the pollutant loads discharging from the watershed under wet weather and dry weather conditions to the receiving waters of the impaired shorelines. The watershed model outputs were used as inputs to a receiving water model.

For the receiving water model, the Environmental Fluid Dynamics Code (EFDC) model (Hamrick, 1992 and 1996) was selected for both wet weather and dry weather conditions to simulate the assimilative capacity of the receiving waters at the impaired shorelines of BB and SISP. The EFDC model can be used to conduct a dynamic or quasi-steady-state simulation of flushing and intrusion of waters high in salinity resulting from tidal hydrodynamics. The EFDC model can also include assumptions for influence of salinity and temperature on bacteria die-off rate formulations.

Sufficient water quality data were available for BB and SISP to perform model calibration and validation and analyses of loading conditions to the receiving waters. Appendix F provides more details regarding model formulations and assumptions.

For the present study, the EFDC models were used for estimation of the assimilative capacity of the shoreline segments evaluated and the resulting TMDLs based on numeric WQOs, simulation of the response of the receiving waters to varying external loading scenarios, and estimation of loads from sources not associated with watershed runoff. As more hydrology and/or water quality data are collected, the EFDC model formulations for each of the shoreline segments can be refined through additional model calibration and validation. In addition, further study regarding relative sources of bacteria from within the receiving waters (e.g., waterfowl) can be quantified and configured into the EFDC models for simulation of water quality, comparison to

observed data, and refined calculation of load allocations and load reductions (discussed in section 7). The wet weather and dry weather watershed modeling approaches selected for simulating the pollutant loads in the receiving waters are discussed in more detail below.

6.2.1 Wet Weather Modeling Approach

During wet weather conditions, sources of bacteria are usually associated with wash-off of bacteria accumulated, or built up, on the land surface. Specifically, during rainy periods, or storm events, the bacteria are washed off the land surface and delivered to the waterbody through creeks and/or stormwater collection systems. Once the bacteria loads reach the receiving waters of the shoreline, tidal flushing and water conditions can influence the die-off rates of the bacteria loads and assimilative capacity of the receiving waters. Therefore, to assess the linkage between sources of bacteria and the effect on receiving waters at BB and SIS, a modeling approach was needed that could simulate the build-up and wash-off of bacteria from land surfaces, the hydrologic and hydraulic processes that affect delivery of the bacteria load to the waterbody, the assimilative capacity of the waterbody, and the effects of tidal flushing.

Understanding and modeling of these processes provided the necessary decision support for the calculated TMDLs and the allocation of the bacteria loads to the identified nonpoint and point sources. The wet weather modeling approach assumed the following:

- All sources can be represented through build-up/wash-off of bacteria from specific land use types.
- The discharge of sewage is zero. Sewage spill information was reserved for use during the calibration process to account for observed spikes in bacteria, as applicable; however, the calibration process did not necessitate removal of any wet weather data considered to be affected by sewage spill information. In other words, data from wet weather conditions used for calibration were not indicative of sewage spills.
- For numeric TMDL target assessment, the critical locations were assumed to be along the length of each shoreline segment.

The wet weather modeling approach selected for use in this project is based on the application of two separate models: 1) the USEPA's Loading Simulation Program in C++ (LSPC) model (Shen et al., 2004; USEPA, 2003) to estimate bacteria loading in the watersheds that are delivered to the receiving waterbodies, and 2) the EFDC model (Hamrick, 1992 and 1996), to simulate the assimilative capacity of the receiving waterbodies, as described in section 6.2. Both models are included in the USEPA's TMDL Modeling Toolbox recommended by the USEPA for use in development of TMDLs.

LSPC is a recoded C++ version of the USEPA's Hydrological Simulation Program—FORTRAN (HSPF) that relies on fundamental (and USEPA-endorsed) algorithms.

Insufficient hydrology and water quality data were available for the BB and SISP watersheds to perform site-specific LSPC model calibration and validation. However, LSPC has been successfully applied and calibrated in multiple watersheds in the San Diego Region for Bacteria TMDL Project I (San Diego Water Board, 2007). These regionally calibrated modeling parameters were transferred and applied to the watersheds that deliver bacteria loads to the BB and SISP shoreline segments. For a complete discussion of the LSPC model configuration, validation, and application refer to Appendix F.

Wet weather watershed flows and bacteria levels based on the LSPC model output from the watersheds of the respective shoreline segments modeled were used as boundary conditions to the receiving waters of the impaired shoreline segments in the EFDC model. Assumptions for the wet weather modeling approach can be found in Appendix G.

6.2.2 Dry Weather Modeling Approach

Bacteria densities during dry weather conditions are extremely variable in nature. For modeling of dry weather watershed sources of bacteria for the shoreline segments of BB and SISP, the approach for Bacteria TMDLs Project I was used. This approach relied on detailed analysis of available data to better identify and characterize sources. Data collected from dry weather samples were used to develop empirical relationships that represent water quantity and water quality associated with dry weather runoff from various land uses. For each monitoring station, a watershed was delineated and the land use was related to flow and bacteria concentrations. A statistical relationship was established between flow, bacteria densities, and area of each land use. A complete discussion of the statistical analysis of data and development of the empirical framework for estimating watershed bacterial loads is provided in Appendix F.

To represent the linkage between source contributions and effect on receiving waters, steady-state mass balance models were developed to simulate transport of bacteria from the watershed to the streams and stormdrains flowing to the BB and SISP shorelines; and the EFDC model (Hamrick, 1992 and 1996) was used to simulate the assimilative capacity of the receiving waterbodies, as described in section 6.2.

The steady-state mass balance models were used to represent the streams/stormdrains as a series of plug-flow reactors, with each reactor having a constant, steady-state flow and bacteria load. Bacteria concentrations in each segment were simulated based on regionally calibrated values for a first-order die-off rate and stream infiltration. A complete description of configuration and calibration of the transport modeling network is provided in Appendix F.

Dry weather receiving water models of BB and SISP were consistent with EFDC models developed for wet weather model analyses (section 6.2.1). Dry weather flows and bacteria levels based on the output from the steady-state mass balance models used for the watersheds of the respective shoreline segments modeled were used as

Draft Technical Report
TMDLs for Indicator Bacteria
Baby Beach and Shelter Island Shoreline Park

February 22, 2008

boundary conditions to the EFDC model. Assumptions for the dry weather modeling approach can be found in Appendix G.

7 Identification of Load Allocations and Reductions

The models selected for wet and dry weather analysis provided the first step in developing the tools for a framework to assist in regulatory and management decisions for the BB and SISP shoreline segments and their respective watersheds. Estimated current existing loads were compared to the TMDLs. The comparison was used to identify controllable sources requiring load reductions. Methodologies for determining load reductions to the identified controllable nonpoint and point sources are described in the following sub-sections.

7.1 Wet Weather Loading Analysis

After calibrating and validating the LSPC and EFDC models with existing flow and water quality data, the models were used to calculate existing wet weather bacteria loading and TMDLs under critical conditions. The LSPC model was used to calculate existing bacteria loads for each watershed that delivers bacteria loads to the impaired shoreline segments of BB and SISP during critical wet weather conditions. The EFDC model was used to calculate the existing bacteria loads and TMDLs for the receiving waters under critical tidal conditions at a critical location. The difference between the existing wet weather bacteria loads and TMDLs for the impaired shoreline segments was used to determine the load reductions required. The wet weather loading analysis is discussed in the following sub-sections.

7.1.1 Identification of the Critical Wet Weather and Tidal Conditions

To ensure the receiving waters are protected during extremely wet periods of weather, a critical wet weather period associated with extreme wet conditions was selected for loading analysis and TMDL calculations. This extreme wet period, or critical wet weather condition, was selected by reviewing data from multiple rainfall gages in the San Diego Region over a recent 14-year period (1990 through 2004) (Appendix D, No.9).

The wettest year, 1993, was selected as the critical wet year for assessment of wet weather loading conditions. Statistically, 1993 is in the 92nd percentile of annual rainfalls observed from 1990 to 2004. This observation is consistent with studies performed by the Southern California Coastal Research Project (SCCWRP), where a 90th percentile year was selected based on rainfall data for the Los Angeles Airport (LAX) from 1947 to 2000, also resulting in selection of 1993 as the critical wet year (Los Angeles Water Board, 2002).

To assess the response of the receiving waters to variable critical watershed loads, a critical 30-day period of the critical wet year was selected for detailed assessment by the LSPC model to calculate bacteria loads delivered from the watersheds to the shoreline segments of BB and SISP. This shortened period facilitated detailed analyses of the hourly or diurnal conditions that impact the water quality, rather than a longer-term, daily evaluation of loads. January 7 through February 5 was identified as a 30-

day critical wet weather period in 1993. During this 30-day critical wet weather period, five to ten of the top 1st percentile of flow magnitudes (daily averages) were observed in the flow data collected between January 1, 1990 and May 31, 2004, depending on location. Additionally, of these higher flows, all the bacteria levels within the top 10th percentile of magnitude were simulated by the LSPC model over that same period.

Besides bacteria loading from the watersheds calculated by the LSPC model during the 30-day critical wet weather period, assessment of the assimilative capacities of the receiving waters at the shoreline segments by the EFDC model was also highly dependent on tidal effects. The degree of variation between high and low tides impacts the amount of flushing that occurs along the shorelines. Lower tides are associated with reduced assimilative capacities, and higher tides, in turn, are associated with increased assimilative capacities. Because the variation of tide elevations are so important to the assimilative capacities of the shorelines, a period of tidal fluctuation dominated by lower tide elevations, which are associated with reduced assimilative capacities, was also considered in the assessment of critical conditions for wet weather TMDL development. Tidal elevation data were available for the period from 2001 to 2002. Within that period, March 7 to April 7, 2001 was identified as the 30-day period with the lowest tide elevation. Therefore, March 7 to April 7, 2001 was selected as the 30-day critical tidal period.

The 30-day critical wet weather period and the 30-day critical tidal period do not fall within the same time period. However, the rainfall and tidal elevation data from these two periods were used together in the wet weather model analysis to represent the most conservative potential critical condition for the wet weather loading conditions and TMDL calculations.

7.1.2 Critical Locations for Wet Weather Load Calculations

Bacteria loading during critical wet weather and tidal conditions is calculated at a critical location in the physical domain of the model. The critical location is the point or area in the waterbody that is most vulnerable to bacteria loading under the critical wet weather and tidal conditions. This critical location is selected based on high bacteria levels predicted at that location and considered to be a conservative assumption for the assessment of water quality conditions. If the water quality at the critical location is protective of beneficial uses under critical conditions, the water quality in the rest of the waterbody is expected to be protective of beneficial uses as well. Although water quality is predicted only at this critical location in the wet weather model, in reality, water quality must be assessed and maintained throughout a waterbody to support beneficial uses.

For the BB and SISP shoreline segments, the critical location is the entire length of each impaired shoreline segment. For the development of the wet weather model, receiving waters at these shoreline segments were represented in the model with multiple grid cells (see Appendix F). For each shoreline segment evaluated, a weighted average of bacteria density was calculated based on the respective length of shoreline

of each model grid cell located adjacent to that shoreline. This resulted in a single representative bacteria density for each shoreline segment addressed in this TMDL. The representative bacteria density is calculated by the following equation:

$$(\text{Avg. Dens.} = \sum [\text{Length} * \text{Dens.}] / \sum \text{Length})$$

Where: Avg. Dens. = weighted average bacteria density
 Length = length of the shoreline segment
 Dens. = bacteria density of each grid cell

7.1.3 Wet Weather Load Calculations

Calculations of bacteria loading from the watersheds to the receiving shoreline segments under wet weather conditions required the use of the LSPC model to predict watershed flows and bacteria densities. The dynamic model-simulated watershed processes, based on observed rainfall data as model input, provided temporally variable load estimates for the 30-day critical wet weather period. These bacteria loads from the watersheds were simulated using calibrated, land use-specific processes associated with hydrology and build-up and wash-off of bacteria from the land surface. Transport processes of bacteria loads from the watershed sources to the receiving waterbodies were also simulated in the LSPC model with a first-order loss rate based on values taken from literature sources (see Appendix F).

In addition to bacteria loads from the watershed sources delivered to the receiving waterbodies, additional sources within the receiving waters were quantified. Limited data were available for identification of non-precipitation-based runoff sources at the receiving waters and their relative load contributions. These non-precipitation-based and non-urban runoff sources include waterfowl or other local sources within the receiving waters and at the shoreline, which will impact water quality during wet and dry weather conditions.

No available data were identified regarding waterfowl populations or other non-precipitation-based and non-urban runoff sources at the BB and SISP shorelines to directly estimate associated bacteria loads. However, if the loads from these sources are assumed to be constant in both wet weather and dry weather conditions, allowable loads attributed to these sources may be inversely-derived, or back-calculated. The EFDC model of the receiving waters developed for the dry weather modeling analysis was used to back-calculate the allowable loads from these non-precipitation-based and non-urban runoff sources, which is discussed in section 7.2.5, and Appendix F.

The total calculated loads to the receiving waters is the sum of the bacteria loads attributed to non-precipitation-based and non-urban runoff sources back-calculated using the dry weather EFDC model and the bacteria loads attributed to the watershed that were calculated based on the LSPC model for the 30-day critical wet weather period.

7.1.4 Application of Wet Weather Numeric Targets

As discussed in section 3, the wet weather numeric targets are based on the single sample maximum WQOs which are given in the Basin Plan. For REC-1 beneficial uses, single sample maximum WQOs were established in the Basin Plan for TC, FC, and ENT. The wet weather numeric targets for the indicator bacteria evaluated for this project are provided in Table 3-1.

7.1.5 Calculation of Existing Wet Weather Bacteria Loads and TMDLs

For each LSPC-modeled watershed discharging to a shoreline segment of BB or SISP (watersheds and proximity to impaired shorelines are shown in Appendix J), wet weather watershed flows and bacteria loads were calculated for the 30-day critical wet weather period. Bacteria from non-precipitation-based and non-urban runoff sources (e.g., waterfowl and other local sources) were back-calculated for the 30-day critical tidal period using the dry weather EFDC model (see section 7.2.5).

Hourly bacteria densities within critical locations of the wet weather model were simulated with the EFDC model over the combined 30-day critical wet weather and tidal period. Using the hourly EFDC model-predicted bacteria densities, daily arithmetic means for existing bacteria loads were calculated and compared to the wet weather numeric targets for each indicator bacteria at each shoreline segment evaluated. Graphical comparisons of the calculated daily arithmetic means for existing bacteria loads under critical conditions with the wet weather numeric target are shown in Appendix H.

As shown in Appendix H, there were some cases where the existing bacteria loads modeled using the combined 30-day critical wet weather and tidal period showed no exceedances of the wet weather numeric targets. For these cases, no load reductions are required from any sources of bacteria to meet the REC-1 WQOs, and the existing bacteria load was set as the TMDL.

For the other cases, where the model shows that the wet weather numeric targets have been exceeded one or more days under critical conditions, the wet weather model was used to calculate the loading capacity, or TMDL, of the receiving water. Because the bacteria loads from non-precipitation-based and non-urban runoff sources (e.g., waterfowl and other local sources) back-calculated for the 30-day critical tidal period are assumed to be constant, only the bacteria loads from the watershed could be adjusted. The wet weather LSPC and EFDC models were used to determine the maximum bacteria density that can be discharged in the 30-day critical wet weather period runoff to the receiving water and not result in any exceedances of wet weather numeric targets at the critical locations. This bacteria density was then assigned to all the storm water runoff flows in the watershed discharging to an impaired shoreline segment over the 30-day critical wet weather period. This analysis resulted in a bacteria load that was added to the bacteria loads from non-precipitation-based and non-urban runoff sources to represent the TMDL of the receiving water. The loading capacities, or TMDLs, calculated for each modeled shoreline segment are graphically shown in Appendix H.

7.1.6 Allocation of Wet Weather TMDLs and Calculation of Load Reductions for WLAs

Because the bacteria loads from non-urban runoff sources (e.g., waterfowl and other local sources within the receiving waters) are assumed uncontrollable nonpoint sources and constant, only the bacteria loads from the watershed, which are assumed to be from controllable point sources, can be reduced. To determine load reductions to meet the TMDLs, analyses were performed for each indicator bacteria and shoreline segment based on the following steps:

1. Calculate the existing wet weather watershed bacteria load for each day of the 30-day critical wet weather period (represented as bars in loading curves in Appendix K);
2. Determine the daily loads attributed to non-urban runoff sources of bacteria (e.g., waterfowl and other local sources within the receiving water) based on dry weather EFDC modeling analyses (see sections 7.2.3 and 7.2.5) and set as load allocation (LA) for uncontrollable natural or background sources;
3. Calculate the wet weather TMDL – the loading capacities of the receiving waters for each day were calculated using the daily flows multiplied by maximum allowable watershed bacteria densities determined through modeling analyses described above (section 7.1.5), plus the daily bacteria load attributed to the non-urban runoff sources (from step 2);
4. Calculate wasteload allocation (WLA) for controllable point sources as the difference between the wet weather TMDL (from step 3) and the LA for uncontrollable natural or background sources (from step 2); and;
5. Calculate load reductions required to meet WLA for controllable point sources, represented by the portion of the bars above loading capacity curves in Appendix K (i.e., the difference between step 1 and step 4). Load reduction calculations are discussed in more detail in section 8.

7.1.7 Margin of Safety

There are two ways to incorporate the margin of safety, or MOS (USEPA, 1991): (1) implicitly incorporate the MOS using conservative model assumptions to develop allocations; and/or, (2) explicitly specify a portion of the total TMDL as the MOS and use the remainder for allocations. For the wet weather bacteria TMDL calculations, only an implicit MOS was incorporated.

Throughout the wet weather TMDL development process, conservative assumptions were employed. For example, the critical conditions included the combination of a critical wet weather period and a critical tidal period that resulted in a scenario that assumes maximum bacteria loading will occur when the assimilative capacity of the receiving waterbody is at its lowest. Also, the critical location for TMDL calculation was at the shallow shoreline within the model's physical domain where volumes are lower

and the resulting assimilative capacities are therefore reduced. Additional conservative assumptions are listed in Appendix G.

Based on the incorporation of all these conservative assumptions, no explicit MOS was necessary.

7.1.8 Seasonality

Seasonal analyses of bacteria levels in the receiving waters at the BB and SISP shorelines were specific to wet and dry seasons, when loadings to the receiving waters can vary considerably. For the wet season, a 30-day critical wet weather period was selected and assessed to determine conditions that can occur for high watershed flows during rainfall events. This 30-day critical wet weather period can occur during any month throughout the wet season (mid-October to early April).

For estimating bacteria loads during dry weather conditions, a separate dry weather modeling approach was used (see section 7.2).

7.2 Dry Weather Loading Analysis

After calibrating and validating the dry weather steady-state watershed model and EFDC receiving water model with existing flow and water quality data, the models were used to calculate existing dry weather bacteria loading and TMDLs under critical conditions. A steady-state model (see Appendix F) was used to calculate existing dry weather bacteria loads for each watershed that delivers bacteria loads to the impaired shoreline segments of BB and SISP during dry weather conditions. As with the wet weather loading analysis, the EFDC model (see Appendix F) was used to calculate the existing bacteria loads and TMDLs for the receiving waters under critical tidal conditions at a critical location. The difference between the existing dry weather bacteria loads and TMDLs for the impaired shoreline segments was used to determine the load reductions required. The dry weather loading analysis is discussed in the following subsections.

7.2.1 Identification of the Critical Dry Weather and Tidal Conditions

Because the dry weather watershed model assumes steady-state conditions for bacteria loading to the receiving waterbody, there is no critical dry weather period. However, as with the wet weather modeling approach, assessment of the assimilative capacities of the shoreline segments by the EFDC model was highly dependent on tidal effects (see section 7.1.1). The same 30-day critical tidal period, March 7 to April 7, 2001, was identified. This critical tidal period was used as the 30-day critical tidal period in the dry weather model analysis.

7.2.2 Critical Locations for Dry Weather Load Calculations

As was the case with the wet weather load calculations (see section 7.1.2), the critical location selected is the entire length of each impaired shoreline segment of BB and SISP. For the development of the dry weather model, receiving waters at these

shoreline segments were represented in the model with multiple grid cells (see Appendix F). For each shoreline segment evaluated, a weighted average of bacteria density was calculated as in the wet weather analysis based on respective length of shoreline ($\text{Avg. Dens.} = \frac{\sum [\text{Length} * \text{Dens.}]}{\sum \text{Length}}$) of each model grid cell located adjacent to that shoreline. This resulted in a single representative bacteria density for each shoreline segment addressed in this TMDL.

7.2.3 Dry Weather Load Calculations

Calculation of bacteria loading from the watershed to the receiving shoreline segments under dry weather conditions was based on empirical relationships established between both flow and bacteria densities and land use distribution in the watershed. Transport of bacteria loads was simulated using standard plug-flow equations to describe steady-state losses resulting from first-order die-off and stream infiltration (Appendix F). Steady-state estimates of bacteria loads were assumed constant for all dry weather days. Assumptions incorporated in the dry weather loading analysis are described in Appendix G.

In addition to bacteria loads from the watershed sources delivered to the receiving waterbodies, additional sources within the receiving waters needed to be quantified. As discussed in section 7.1.2, no available data were identified regarding waterfowl populations or other non-urban runoff sources at the BB and SISP shorelines to directly estimate associated bacteria loads. However, if the loads from these sources are assumed to be constant in both wet weather and dry weather conditions, allowable loads attributed to these sources may be inversely-derived, or back-calculated.

BB and SISP had sufficient bacteria water quality data collected from the receiving waters for EFDC models to be set up using bacteria loads from the dry weather steady-state watershed model as the only load input to the receiving waterbodies. The EFDC modeling analyses of those receiving waters determined that loads predicted from the dry weather steady-state watershed models were generally too low to result in the observed bacteria levels in the receiving waters without additional non-urban runoff source loads considered.

This discrepancy could be due to the under-prediction of bacteria loading from dry weather urban runoff, or additional non-urban runoff sources at the shoreline, such as waterfowl or other sources within the receiving water. Further analyses using the EFDC models were performed to calculate loads from non-urban runoff sources of bacteria that could have theoretically resulted in the water quality observed in the receiving waters. These analyses determined that such additional non-urban runoff sources varied considerably over time, and this variation could not be predicted with accuracy for other periods when data were not available. A complete discussion of these modeling analyses is provided in Appendix F.

The above analyses were used to try and verify and predict the additional loading from non-urban runoff sources that was not accounted for in the steady-state model-

predicted dry weather urban runoff from the watershed. However, the observed data varied significantly, both temporally and spatially, and the model could not predict the additional loading from non-urban runoff sources with any accuracy. Thus, these estimates were not used directly in TMDL analyses.

Instead, the dry weather EFDC model was used to back-calculate the allowable loads of dry weather non-urban runoff sources that can be assimilated by the receiving waters and still meet dry weather numeric targets. A full discussion of this back-calculation is provided in section 7.2.5.

7.2.4 Application of Dry Weather Numeric Targets

As discussed in section 3, the dry weather numeric targets are based on the 30-day geometric mean as well as the single sample maximum WQOs established in the Basin Plan. The application of both the 30-day geometric mean and single sample maximum WQOs is due to the fact that tidal effects for some shorelines have been observed to result in extreme diurnal variations in bacteria densities that can range by orders of magnitude. So, even if the shoreline bacteria densities are in compliance with the 30-day geometric mean, in some cases the daily arithmetic mean predicted in a model could exceed the single sample maximum WQO. Therefore, the single sample maximum WQOs were also used to set maximum daily bacteria densities allowed under dry weather conditions.

For comparison to the 30-day geometric mean WQOs, the hourly EFDC model-predicted bacteria densities occurring within critical locations (see section 7.2.2) for all days during the 30-day critical period were used to calculate a geometric mean. Including all the hourly EFDC model-predicted bacteria densities in the calculation of the 30-day geometric mean for each shoreline segment allowed consideration of diurnal variations in water quality resulting from tidal fluctuations. For comparison to the single sample maximum WQOs, the hourly EFDC model-predicted bacteria densities occurring within critical locations were used to calculate daily arithmetic averages for each day in the 30-day critical tidal period. Use of the 30-day geometric mean and single sample maximum WQOs in calculating dry weather TMDLs is discussed further in section 7.2.5.

For REC-1 beneficial uses, 30-day geometric mean and single sample maximum WQOs have been established in the Basin Plan for TC, FC, and ENT. The dry weather numeric targets for the indicator bacteria evaluated for this project are provided in Table 3-2.

7.2.5 Calculation of Existing Dry Weather Bacteria Loads and TMDLs

As discussed in section 7.2.3, due to lack of available data, sources of bacteria during dry periods are difficult to quantify and require further study for complete identification. Modeling analyses that were performed and compared to available water quality data indicated that the bacteria loads predicted by the dry weather steady-state watershed model were generally too low to result in the observed bacteria levels in the receiving waters without additional bacteria source loads considered. These additional sources

may include localized inputs such as waterfowl or other sources within the receiving waters, or could result from under-prediction of the watershed model on specific days when loadings are high (dry weather model-predicted loads are steady-state, and assumed constant for each day). Further study is recommended to identify and quantify these other sources that may be contributing to bacteria loads to the receiving waters. In the meantime, steady-state dry weather watershed flows and bacteria densities were used to calculate bacteria loading from the watershed, which are assumed to be from controllable point sources. Bacteria from non-urban runoff sources (e.g, waterfowl and other local sources within the receiving water) were lumped into a single load and assumed to be from natural and uncontrollable nonpoint sources.

Because bacteria loads predicted by the watershed runoff models were generally too low to result in the observed bacteria levels in the receiving waters, and no information is currently available for quantification of existing loads attributed to non-urban runoff sources (e.g, waterfowl and other local sources), another approach was taken to account for loading from non-precipitation-based and non-urban runoff sources. The receiving waters were modeled using the EFDC model to back-calculate the allowable loading from the nonpoint sources that would still meet the assimilative capacities of those waterbodies, while accounting for the allowable loading calculated using the dry weather steady-state watershed model.

The dry weather steady-state watershed model was used to calculate the allowable loading from dry weather urban runoff by calculating the dry weather flow and multiplying it by the dry weather 30-day geometric mean numeric targets. This allowable bacteria load from the watershed was used as a boundary condition in the receiving water (EFDC) model. Nonpoint, non-urban runoff sources of bacteria that may be attributed to waterfowl or other unidentified sources were added to the allowable load calculated from the dry weather steady-state watershed model. These loads were modeled on an hourly basis during the 30-day critical tidal period by the EFDC model. The hourly model-predicted bacteria densities allowed the consideration of diurnal variations in water quality resulting from tidal fluctuations, which may vary by orders of magnitude.

The hourly EFDC model-predicted bacteria densities were used to calculate a geometric mean bacteria density for the 30-day critical tidal period. Additionally, the hourly EFDC model-predicted bacteria densities were used to calculate daily arithmetic averages for each day of the 30-day critical tidal period. The 30-day critical tidal period geometric mean was compared to the 30-day geometric mean numeric target. The daily arithmetic averages were compared to the single sample maximum numeric target.

Bacteria loads attributed to non-urban runoff sources (e.g., waterfowl or other unidentified sources) were increased until either the 30-day critical tidal period geometric mean was equal to the 30-day geometric mean numeric target, or one or more daily arithmetic means was equal to the single sample maximum numeric target. This was considered the allowable load attributed to non-urban runoff sources that

could still meet the assimilative capacity of the receiving water, while accounting for the allowable loads from urban runoff sources.

Results of these analyses are shown in Appendix L for the dry weather 30-day critical tidal period evaluated. Results show the hourly EFDC model-predicted bacteria densities and the calculated daily arithmetic means compared to dry weather numeric targets. The 30-day critical tidal period geometric means are not shown in Appendix L, but are less than or equal to the 30-day geometric mean numeric targets. For each shoreline segment evaluated, the EFDC model-predicted TC, FC and ENT bacteria densities were compared to REC-1 WQOs for development of TMDLs.

7.2.6 Allocation of Dry Weather TMDLs and Calculation of Load Reductions for WLAs

Because the bacteria loads from non-urban runoff sources (e.g., waterfowl and other local sources) are assumed uncontrollable nonpoint sources and constant, only the bacteria loads from the watershed, which are assumed to be from controllable point sources, can be reduced. To determine load reductions to meet the TMDLs, analyses were performed for each indicator bacteria and shoreline segment based on the following steps:

1. Calculate the existing dry weather watershed bacteria load using the steady-state modeled daily flow multiplied by the average observed bacteria densities;
2. Determine the daily loads attributed to non-urban runoff sources of bacteria (e.g., waterfowl and other local sources) based on dry weather EFDC modeling analyses (see sections 7.2.3 and 7.2.5) and set as LA for uncontrollable natural or background sources;
3. Calculate the dry weather TMDL – the daily loading capacities of the receiving waters were calculated using the steady-state modeled daily flow from the watersheds multiplied by the dry weather 30-day geometric mean numeric targets (section 7.2.5), plus the daily bacteria load attributed to the non-urban runoff sources (from step 2);
4. Calculate WLA for controllable point sources as the difference between the dry weather TMDL (from step 3) and the LA for uncontrollable natural or background sources (from step 3); and;
5. Calculate load reductions required to meet WLA for controllable point sources (i.e., the difference between step 1 and step 4). Load reduction calculations are discussed in more detail in section 8.

7.2.7 Margin of Safety

As was the case for the wet weather bacteria TMDL calculations, an implicit MOS was incorporated through application of conservative assumptions throughout the dry weather TMDL development. An important conservative assumption was the application of both the 30-day geometric mean and single sample maximum WQOs as

numeric targets in the TMDL calculations. Compliance with both numeric targets for the 30-day critical tidal period ensured that diurnal variations of bacteria levels resulting from tidal fluctuations, and resulting impacts on receiving water assimilative capacities, would not result in potential detrimental effects to designated beneficial uses. Additional conservative assumptions are listed in Appendix G.

Based on the incorporation of all these conservative assumptions, no explicit MOS was necessary.

7.2.8 Seasonality

Seasonal analyses of bacteria levels in the receiving waters at the BB and SISP shorelines were specific to wet and dry seasons, when loadings to the receiving waters can vary considerably. The dry weather modeling approach only included non-precipitation-based urban runoff from the watershed, because wet weather storm events are not expected during the dry season. Instead, the urban runoff modeled in the dry weather modeling approach was assumed to be steady-state. The steady-state aspect of the dry weather watershed model resulted in estimation of a constant load from each watershed to the receiving water model.

For estimating bacteria loads during wet weather conditions, a separate wet weather modeling approach was used (see section 7.1).

8 Total Maximum Daily Loads and Allocations

The TMDL for a given pollutant within a waterbody is the total amount of the pollutant that can be assimilated by the receiving water while still achieving the WQOs for the designated beneficial uses. TMDLs can be expressed on a mass loading basis (e.g., number of bacteria colony forming units per year) or as a concentration in accordance with Code of Federal Regulations Title 40 section 130.2(i). Once calculated, the TMDL is equal to the sum of individual WLAs (for point sources) and LAs (for nonpoint and natural sources). In addition, the TMDL must include a margin of safety (MOS), either implicitly or explicitly, to account for the uncertainty in the relationship between pollutant loads and the quality of the receiving water. Conceptually, the definition of a TMDL is represented by the following equation:

$$\text{TMDL} = \sum \text{WLAs} + \sum \text{LAs} + \text{MOS}$$

When developing a TMDL, allowable loadings from pollutant sources must be established that do not cumulatively amount to more than the TMDL. This provides the basis for establishing and recommending water quality-based controls.

TMDLs, WLAs, and LAs were developed separately for wet and dry weather conditions. These loads and allocations were reported differently to address the weather conditions used for their determination, as well as to provide guidance for implementation since the numeric targets selected differ between the two weather conditions.

8.1 Wasteload Allocations

Federal regulations⁴ require TMDLs to include an individual WLA for each point source identified. The only point source identified to affect the waterbodies addressed in this study was discharges from MS4s, although other point sources may exist. Discharges from MS4s were modeled and represented with the wet weather LSPC and dry weather steady-state watershed models.

The USEPA's stormwater regulations require municipalities to obtain permits, or discharge requirements, for all stormwater discharges from MS4s.⁵ The discharge requirements that regulate the existing MS4 apply to the watersheds identified as likely to contribute pollutant loads to the shoreline segments addressed in this study.

⁴ Code of Federal Regulations Title 40 section 130.7

⁵In California, to avoid the issuance by the USEPA of separate and duplicative NPDES permits for discharges in California subject to the Clean Water Act, the State's WDRs (Water Code Chapter 5.5) for such discharges implement the NPDES regulations and entail enforcement provisions that reflect the penalties imposed by the Clean Water Act for violation of NPDES permits issued by the USEPA. These State WDRs that implement NPDES regulations serve in lieu of federal NPDES permits.

8.2 Load Allocations

For each nonpoint source identified, an LA is assigned. The only nonpoint sources identified were natural or background sources, such as direct inputs from birds, terrestrial and aquatic animals, or other unidentified sources within the receiving waters. Until more information is obtained through further study to provide identification of the relative loading from each of these potential sources, they were combined into a single LA for each shoreline segment (see section 7.2.5).

Because the loads from non-urban runoff sources (e.g., waterfowl and other unidentified sources) are attributed to uncontrollable sources, no reduction is required to meet the LA at this time. However, if more information is collected in future studies on non-urban runoff sources that indicate a higher loading can be attributed to these sources, load reductions to meet the LA can be recommended, if controllable.

No nonpoint sources were identified within the watersheds contributing to the receiving waters. Until better information is available that describes the spatial coverage of MS4s in the watersheds, no distinction can be made regarding those areas of the watersheds that are drained by the MS4s. If this information becomes available for the watersheds, the WLA assigned to MS4s can be redistributed to nonpoint source runoff, and LAs can be established for those nonpoint sources. Such nonpoint source runoff includes runoff attributed to natural areas not included within coverage of an MS4. The implementation strategy provides sufficient time for collection of information that better distinguishes areas covered by MS4s so that TMDL allocations can potentially be reassigned from WLAs to LAs for nonpoint source runoff from those natural areas.

8.3 Wet Weather Results

TMDLs, LAs, and WLAs for wet weather were developed based on multiple wet days occurring within a 30-day critical wet weather period and compliance to single sample maximum REC-1 WQOs. Thus, the TMDLs, LAs, and WLAs are given in units of billion MPN per 30 days (Billion MPN/30 days). The loading analyses outlined in Appendix K evaluated these wet days to determine the critical loads resulting from the 30-day critical wet weather period.

The only nonpoint source identified was natural or background bacteria. Natural or background sources of bacteria were lumped into one LA. The LA for natural or background sources was based on the loads that were back-calculated for non-urban runoff sources by the dry weather load analysis (see section 7.2.5 and Tables 8-4 through 8-6). The remaining portion of the TMDL is allocated to point sources as WLAs. The portion of the TMDL that can be allocated to point sources as WLAs was calculated as the difference between the TMDL and LA for natural sources (i.e., $WLA_{\text{Point Sources}} = \text{TMDL} - LA_{\text{Natural/Background}}$).

The modeled watersheds that drain into the receiving waters at the impaired shoreline segments are wholly located within urbanized areas. The only point source identified by the source analysis in section 5 was urban runoff from MS4s. The principal MS4s

contributing bacteria to receiving waters are owned or operated by the municipalities located within the watersheds. Therefore, only the municipal MS4s are assigned wet weather WLAs (i.e., $WLA_{\text{Municipal MS4}} = TMDL - LA_{\text{Natural/Background}}$).

If the calculated existing municipal MS4 wasteload from the watershed was less than the municipal MS4 WLA, the existing municipal MS4 wasteload was set to the municipal MS4 WLA. If the calculated existing municipal MS4 wasteload from the watershed was greater than the municipal MS4 WLA, a wasteload reduction (i.e., Existing Municipal MS4 Wasteload – Municipal MS4 WLA) and reduction percentage (i.e., $[\text{Existing Municipal MS4 Wasteload} - \text{Municipal MS4 WLA}] \div [\text{Existing Municipal MS4 Wasteload}] \times 100$ percent) were calculated.

TMDLs were developed for the REC-1 beneficial use designation. According to the Basin Plan, WQOs for TC, FC, and ENT indicator bacteria apply to the REC-1 beneficial use. Appendix K provides a graphical representation of the load reductions required to meet the TMDLs for REC-1 beneficial use for TC, FC, and ENT indicator bacteria. The wet weather TMDLs, WLAs, and LAs for TC, FC, and ENT are listed in Tables 8-1, 8-2, and 8-3, respectively.

Draft Technical Report
TMDLs for Indicator Bacteria
Baby Beach and Shelter Island Shoreline Park

Table 8-1. REC-1 Wet Weather TMDLs for Total Coliform for BB and SISP Shoreline Segments

Waterbody	Shoreline Segment/Area	Hydrologic Descriptor	Model Sub-watershed	TMDL (Billion MPN/ 30 days)	Load Allocations (LAs)	Wasteload Allocations (WLAs)	Existing Wasteloads	Percent Reduction of Municipal MS4 Existing Wasteload ²
					Natural/Background (Billion MPN/ 30 days) ¹	Municipal MS4 (Billion MPN/ 30 days)	Municipal MS4 (Billion MPN/ 30 days)	
Dana Point Harbor	Baby Beach	Dana Point HSA (901.14)	2101,2102 2103,2104	166,111	162,857	3,254	3,254	0%
San Diego Bay	Shelter Island Shoreline Park	Point Loma HA (908.10)	2201	482,598	482,400	198	198	0%

Abbreviations/Acronyms:
TMDL: total maximum daily load
LA: load allocation for nonpoint source
WLA: wasteload allocation for point source
MS4: Municipal Separate Storm Sewer System
MPN: most probable number

Notes:
¹ Calculated by dry weather EFDC model analysis (Dry weather LA from Table 8-4 multiplied by 30 days). No reduction required for natural sources.
² Percent Reduction of Existing Municipal MS4 Wasteload = (Existing Municipal MS4 Wasteload – Municipal MS4 WLA) ÷ (Existing Municipal MS4 Wasteload) x 100%

Table 8-2. REC-1 Wet Weather TMDLs for Fecal Coliform for BB and SISP Shoreline Segments

Waterbody	Shoreline Segment/Area	Hydrologic Descriptor	Model Sub-watershed	TMDL (Billion MPN/ 30 days)	Load Allocations (LAs)	Wasteload Allocations (WLAs)	Existing Wasteloads	Percent Reduction of Municipal MS4 Existing Wasteload ²
					Natural/Background (Billion MPN/ 30 days) ¹	Municipal MS4 (Billion MPN/ 30 days)	Municipal MS4 (Billion MPN/ 30 days)	
Dana Point Harbor	Baby Beach	Dana Point HSA (901.14)	2101,2102 2103,2104	32,585	32,473	112	112	0%
San Diego Bay	Shelter Island Shoreline Park	Point Loma HA (908.10)	2201	41,408	41,400	8	8	0%

Abbreviations/Acronyms:
TMDL: total maximum daily load
LA: load allocation for nonpoint source
WLA: wasteload allocation for point source
MS4: Municipal Separate Storm Sewer System
MPN: most probable number

Notes:
¹ Calculated by dry weather EFDC model analysis (Dry weather LA from Table 8-5 multiplied by 30 days). No reduction required for natural sources.
² Percent Reduction of Existing Municipal MS4 Wasteload = (Existing Municipal MS4 Wasteload – Municipal MS4 WLA) ÷ (Existing Municipal MS4 Wasteload) x 100%

Draft Technical Report
 TMDLs for Indicator Bacteria
 Baby Beach and Shelter Island Shoreline Park

Table 8-3. REC-1 Wet Weather TMDLs for *Enterococcus* for BB and SISP Shoreline Segments

Waterbody	Shoreline Segment/Area	Hydrologic Descriptor	Model Sub-watershed	TMDL (Billion MPN/30 days)	Load Allocations (LAs)	Wasteload Allocations (WLAs)	Existing Wasteloads	Percent Reduction of Municipal MS4 Existing Wasteload ²
					Natural/Background (Billion MPN/30 days) ¹	Municipal MS4 (Billion MPN/30 days)	Municipal MS4 (Billion MPN/30 days)	
Dana Point Harbor	Baby Beach	Dana Point HSA (901.14)	2101,2102 2103,2104	5,730	5,616	114	301	62.2%
San Diego Bay	Shelter Island Shoreline Park	Point Loma HA (908.10)	2201	10,556	10,530	26	26	0%

Abbreviations/Acronyms:

TMDL: total maximum daily load
 LA: load allocation for nonpoint source
 WLA: wasteload allocation for point source
 MS4: Municipal Separate Storm Sewer System
 MPN: most probable number

Notes:

- ¹ Calculated by dry weather EFDC model analysis (Dry weather LA from Table 8-6 multiplied by 30 days). No reduction required for natural sources.
² Percent Reduction of Existing Municipal MS4 Wasteload = (Existing Municipal MS4 Wasteload – Municipal MS4 WLA) ÷ (Existing Municipal MS4 Wasteload) x 100%

8.4 Dry Weather Results

TMDLs, LAs, and WLAs for dry weather were calculated based on quasi-steady-state conditions and compliance with both the 30-day geometric mean and single sample maximum WQOs. Because the dry weather watershed modeling approach is based on average daily flows and loads, the TMDLs, LAs, and WLAs are given in units of billion MPN per day (Billion MPN/day).

The only nonpoint source identified was natural or background bacteria. Natural or background sources of bacteria were lumped into one LA. The LA for natural or background sources was based on the loads that were back-calculated for non-urban runoff sources by the dry weather load analysis (see section 7.2.5). The remaining portion of the TMDL is allocated to point sources as WLAs. The portion of the TMDL that can be allocated to point sources as WLAs was calculated as the difference between the TMDL and LA for natural or background sources (e.g., $WLA_{\text{Point Sources}} = \text{TMDL} - LA_{\text{Natural/Background}}$).

The modeled watersheds that drain into the receiving waters at the impaired shoreline segments are wholly located within urbanized areas. The only point source identified by the source analysis in section 5 was urban runoff from MS4s. The principal MS4s contributing bacteria to receiving waters are owned or operated by the municipalities located within the watersheds. Therefore, only the municipal MS4s are assigned dry weather WLAs (i.e., $WLA_{\text{Municipal MS4}} = \text{TMDL} - LA_{\text{Natural/Background}}$).

If the calculated existing municipal MS4 wasteload from the watershed was less than the municipal MS4 WLA, the existing municipal MS4 wasteload was set to the municipal MS4 WLA. If the calculated existing municipal MS4 wasteload from the watershed was greater than the municipal MS4 WLA, a wasteload reduction (i.e., Existing Municipal MS4 Wasteload – Municipal MS4 WLA) and reduction percentage (i.e., $[\text{Existing Municipal MS4 Wasteload} - \text{Municipal MS4 WLA}] \div [\text{Existing Municipal MS4 Wasteload}] \times 100$ percent) were calculated.

TMDLs were developed for REC-1 beneficial use designation. According to the Basin Plan, WQOs for TC, FC, and ENT indicator bacteria apply to the REC-1 beneficial use. The dry weather TMDLs, WLAs, and LAs for TC, FC, and ENT are listed in Tables 8-4, 8-5, and 8-6, respectively.

Draft Technical Report
 TMDLs for Indicator Bacteria
 Baby Beach and Shelter Island Shoreline Park

Table 8-4. REC-1 Dry Weather TMDLs for Total Coliform for BB and SISP Shoreline Segments

Waterbody	Shoreline Segment/Area	Hydrologic Descriptor	Model Sub-watershed	TMDL (Billion MPN/day)	Load Allocations (LAs)	Wasteload Allocations (WLAs)	Existing Wasteloads	Percent Reduction of Municipal MS4 Existing Wasteload ²
					Natural/Background (Billion MPN/day) ¹	Municipal MS4 (Billion MPN/day)	Municipal MS4 (Billion MPN/day)	
Dana Point Harbor	Baby Beach	Dana Point HSA (901.14)	2101,2102 2103,2104	5,430	5,429	0.86	9.0	90.4%
San Diego Bay	Shelter Island Shoreline Park	Point Loma HA (908.10)	2201	16,080	16,080	0	0	0%

Abbreviations/Acronyms:
 TMDL: total maximum daily load
 LA: load allocation for nonpoint source
 WLA: wasteload allocation for point source
 MS4: Municipal Separate Storm Sewer System
 MPN: most probable number

Notes:
¹ Calculated by dry weather EFDC model analysis. No reduction required for natural sources.
² Percent Reduction of Existing Municipal MS4 Wasteload = (Existing Municipal MS4 Wasteload – Municipal MS4 WLA) ÷ (Existing Municipal MS4 Wasteload) x 100%

Table 8-5. REC-1 Dry Weather TMDLs for Fecal Coliform for BB and SISP Shoreline Segments

Waterbody	Shoreline Segment/Area	Hydrologic Descriptor	Model Sub-watershed	TMDL (Billion MPN/day)	Load Allocations (LAs)	Wasteload Allocations (WLAs)	Existing Wasteloads	Percent Reduction of Municipal MS4 Existing Wasteload ²
					Natural/Background (Billion MPN/day) ¹	Municipal MS4 (Billion MPN/day)	Municipal MS4 (Billion MPN/day)	
Dana Point Harbor	Baby Beach	Dana Point HSA (901.14)	2101,2102 2103,2104	1,083	1,082	0.17	1.0	82.7%
San Diego Bay	Shelter Island Shoreline Park	Point Loma HA (908.10)	2201	1,380	1,380	0	0	0%

Abbreviations/Acronyms:
 TMDL: total maximum daily load
 LA: load allocation for nonpoint source
 WLA: wasteload allocation for point source
 MS4: Municipal Separate Storm Sewer System
 MPN: most probable number

Notes:
¹ Calculated by dry weather EFDC model analysis. No reduction required for natural sources.
² Percent Reduction of Existing Municipal MS4 Wasteload = (Existing Municipal MS4 Wasteload – Municipal MS4 WLA) ÷ (Existing Municipal MS4 Wasteload) x 100%

Draft Technical Report
 TMDLs for Indicator Bacteria
 Baby Beach and Shelter Island Shoreline Park

Table 8-6. REC-1 Dry Weather TMDLs for *Enterococcus* for BB and SISP Shoreline Segments

Waterbody	Shoreline Segment/Area	Hydrologic Descriptor	Model Sub-watershed	TMDL (Billion MPN/day)	Load Allocations (LAs)	Wasteload Allocations (WLAs)	Existing Wasteloads	Percent Reduction of Municipal MS4 Existing Wasteload ²
					Natural/Background (Billion MPN/day) ¹	Municipal MS4 (Billion MPN/day)	Municipal MS4 (Billion MPN/day)	
Dana Point Harbor	Baby Beach	Dana Point HSA (901.14)	2101,2102 2103,2104	187	187	0.03	0.8	96.2%
San Diego Bay	Shelter Island Shoreline Park	Point Loma HA (908.10)	2201	351	351	0	0	0%

Abbreviations/Acronyms:

TMDL: total maximum daily load
 LA: load allocation for nonpoint source
 WLA: wasteload allocation for point source
 MS4: Municipal Separate Storm Sewer System
 MPN: most probable number

Notes:

¹ Calculated by dry weather EFDC model analysis. No reduction required for natural sources.

² Percent Reduction of Existing Municipal MS4 Wasteload = (Existing Municipal MS4 Wasteload – Municipal MS4 WLA) ÷ (Existing Municipal MS4 Wasteload) x 100%

9 Legal Authority For TMDL Implementation Plan

This section presents the legal authority and regulatory framework used as a basis for assigning responsibilities to dischargers to implement and monitor compliance with the requirements set forth in these TMDLs. The laws and policies governing point source⁶ and nonpoint source discharges are described below. A large portion of the bacteria loads generated in the receiving waters of the impaired shorelines comes from natural, nonanthropogenic sources. These nonpoint sources are considered largely uncontrollable and therefore cannot be regulated.

Discharger accountability for attaining bacteria allocations is established in this section. The legal authority and regulatory framework are described in terms of the following:

- Controllable water quality factors;
- Regulatory background;
- Persons accountable for point source discharges; and
- Persons accountable for controllable nonpoint source discharges.

9.1 Controllable Water Quality Factors

The source and linkage analyses (sections 5, 6 and 7) found that a significant portion of the bacteria load to the shoreline segments can be attributed to natural sources (e.g., birds, terrestrial and aquatic animals, and other unidentified sources within the waters). Natural sources of bacteria are most significant during dry weather conditions, though these sources are significant during wet weather conditions as well. Bacteria from these sources are largely considered uncontrollable.

The primary controllable source identified by the source analysis was precipitation-based and non-precipitation-based urban runoff discharged from the watersheds by the MS4s. These bacteria discharges result from controllable water quality factors which are defined as those actions, conditions, or circumstances resulting from human activity that may influence the quality of the waters of the state and that may be reasonably controlled. These TMDLs establish WLAs for controllable point sources and LAs for uncontrollable nonpoint sources.

9.2 Regulatory Framework

The regulatory framework for point sources of pollution differs from the regulatory framework for nonpoint sources. The different regulatory frameworks are described in the subsections below.

⁶ The term "point source" is defined in CWA section 502(6) to mean any discernible, confined and discrete conveyance, including but not limited to any pipe, ditch, channel, tunnel, conduit, well, discrete fissure, container, rolling stock, concentrated animal feeding operation, or vessel or other floating craft, from which pollutants are or may be discharged. This term does not include agricultural storm water discharges and return flows from irrigated agriculture.

9.2.1 Point Sources

Clean Water Act section 402 establishes the National Pollutant Discharge Elimination System (NPDES) program to regulate the “discharge of a pollutant,” other than dredged or fill materials, from a “point source” into “waters of the U.S.” Under section 402, discharges of pollutants to waters of the U.S. are authorized by obtaining and complying with NPDES discharge requirements. These discharge requirements commonly contain effluent limitations consisting of either Technology Based Effluent Limitations (TBELs) or Water Quality Based Effluent Limitation (WQBELs). TBELs represent the degree of control that can be achieved by point sources using various levels of pollution control technology that are defined by the USEPA for various categories of discharges and implemented on a nation-wide basis.

TBELs may not be sufficient to ensure that WQOs will be attained in receiving waters. In such cases, NPDES regulations require the San Diego Water Board to develop WQBELs that derive from and comply with all applicable water quality standards. If necessary to achieve compliance with the applicable water quality standards, NPDES requirements must contain WQBELs more stringent than the applicable TBELs.⁷ WQBELs may be expressed as numeric effluent limitations or as BMP development, implementation, and revision requirements. Numeric effluent limitations require monitoring to assess load reductions while non-numeric provisions, such as BMP programs, require progress reports on BMP implementation and efficacy, and could also require monitoring of the waste stream for conformance with a numeric wasteload allocation requiring a mass load reduction.

In California, state Waste Discharge Requirements (WDRs) for discharges of pollutants from point sources to navigable waters of the U.S. that implement federal NPDES regulations and Clean Water Act requirements serve in lieu of federal NPDES permits. These are referred to as NPDES requirements. Such requirements are issued by the State pursuant to independent state authority described in California’s Porter-Cologne Water Quality Control Act⁸ (not authority delegated by the USEPA or derived from the Clean Water Act).

Within each TMDL, a WLA is determined which is the maximum amount of a pollutant that may be contributed to a waterbody by point source discharges of the pollutant in order to attain WQOs that support designated beneficial uses. NPDES requirements must include conditions that are consistent with the assumptions and requirements of the WLAs. The principal regulatory means of implementing TMDLs for point source discharges regulated under these types of NPDES requirements are:

1. Dividing up and distributing the WLAs for the pollutant entering the waterbody among all the point sources that discharge the pollutant;

⁷ Clean Water Act section 303(b)(1)(c) and Code of Federal Regulations Title 40 section 122.44(d)(1)

⁸ Division 7 of the Water Code, commencing with section 13000

2. Evaluating whether the effluent limitations or conditions within the NPDES requirements are consistent with the WLAs. If not, incorporate WQBELs that are consistent with the WLAs into the NPDES requirements or otherwise revise the requirements⁹ to make them consistent with the assumptions and requirements of the TMDL WLAs.¹⁰ A time schedule to achieve compliance should also be incorporated into the NPDES requirements in instances where the discharger is unable to immediately comply with the required wasteload reductions;
3. Mandate discharger compliance with the WLAs in accordance with the terms and conditions of the new or revised NPDES requirements;
4. Implement a monitoring and/or modeling plan designed to measure the effectiveness of the controls implementing the WLAs and the progress the waterbodies are making toward attaining WQOs; and
5. Establish criteria to measure progress toward attaining WQOs and criteria for determining whether the TMDLs or WLAs need to be revised.

Because bacteria loading within urbanized areas were largely determined to be from urban runoff discharged from MS4s, the primary mechanism for TMDL attainment will be regulation of these discharges. Mechanisms to impose regulations on these discharges are discussed in the Implementation Plan, section 10.

9.2.2 Nonpoint Sources

The TMDL analyses found that natural sources (e.g., birds, terrestrial and aquatic animals, and other unidentified sources within the waters) are the only nonpoint sources of bacteria loading to the receiving waters. Bacteria loads from these sources are largely uncontrollable, and therefore cannot be regulated.

9.3 Persons Responsible for Point Source Discharges

Persons responsible for point source discharges of bacteria include municipal Phase I urban runoff dischargers, and potentially municipal Phase II urban runoff dischargers, boat dischargers, and publicly owned treatment works (POTWs). Each class of discharger is described in the following subsections.

⁹ In the case of NPDES requirements, WQBELs may include best management practices that evidence shows are consistent with the WLAs.

¹⁰ See federal regulations [40 CFR section 122.44(d)(1)(vii)(B)]. NPDES water quality-based effluent limitations must be consistent with the assumptions and requirements of any available TMDL wasteload allocation. The regulations do not require the WQBELs to be identical to the WLAs. The regulations leave open the possibility that the San Diego Water Board could determine that fact-specific circumstances render something other than literal incorporation of the wasteload allocation to be consistent with the TMDL assumptions and requirements. The rationale for such a finding could include a trade amongst dischargers of portions of their LAs or WLAs, performance of an offset program that is approved by the San Diego Water Board, or any number of other considerations bearing on facts applicable to the circumstances of the specific discharger.

9.3.1 Municipal Phase I Dischargers of Urban Runoff

Since the shoreline segments evaluated in this project are in urbanized areas, significant bacteria loads enter these waterbodies through the MS4s within the watersheds. MS4 discharges are point source discharges because they are released from channelized, discrete conveyance pipe systems and outfalls. Discharges from MS4s to navigable waters of the U.S. are considered to be point source discharges and are regulated in California through the issuance of NPDES requirements. Persons owning and/or operating MS4s (herein referred to as Municipal Dischargers) that discharge to shorelines have specific roles and responsibilities assigned to them for achieving compliance with the bacteria WLAs described in section 8.

9.3.2 Illicit Discharges from Boats

Boats that dock along any of the shoreline segments evaluated in this project could potentially discharge sewage waste into the waters. However, waste discharges from boats are illegal and should not occur. Therefore, the WLA for this discharge is zero and all such discharges should stop.

9.3.3 Publicly Owned Treatment Works

Wastewater treatment plants, or POTWs are regulated under various San Diego Water Board orders that contain effluent limitations for point source discharges of bacteria from these facilities. Most effluent from these facilities is discharged to the Pacific Ocean through offshore ocean outfalls. All POTWs are subject to NPDES requirements with effluent limits for various pollutants, including bacteria. Since POTW discharges do not pose a known bacteria threat to surface waters, the WLA for POTW discharges is zero.

Sewage discharges to surface and groundwaters are subject to enforcement actions including fines. Typically surface spills are detected and mitigated quickly, however leaking underground sewer pipes, or sewer pipes that become cross-connected with stormwater pipes, may go undetected for long periods of time. Therefore, both wet and dry weather may bring sewage in contact with MS4s and beaches.

Bacteria levels in sewage spills from sanitary sewer systems are subject to regulation under State Water Board Order No. 2006-0003-DWQ and San Diego Water Board Order No. R9-2007-0005, which establish waste discharge requirements prohibiting sanitary sewer overflows by sewage collection agencies. Order Nos. 2006-0003-DWQ and R9-2007-0005 replace San Diego Water Board Order No. 96-04, which had been successful at reducing the number and volume of spills and protecting water quality, the environment, and public health. While Order No. 2006-0003-DWQ prohibits sanitary overflows to surface or ground waters in general, Order No. R9-2007-0005 is more stringent and prohibits "(t)he discharge of sewage from a sanitary sewer system at any point upstream of a sewage treatment plant..." Together, these orders prohibit most kinds of discharge, including but not limited to sewer overflows and leaking underground sewer pipes. Accordingly, the dry and wet weather WLA for discharges from all sanitary sewer systems is zero.

9.4 Persons Responsible for Controllable Nonpoint Source Discharges

Nonpoint sources identified during the source analysis were natural sources such as birds and other unidentified sources within the waters. Nonpoint source discharges associated with natural sources are largely uncontrollable, and therefore cannot be regulated. Although an LA has been established for these nonpoint source discharges, no reductions are required.

Encampments of homeless persons were also identified during the source analysis as a potential nonpoint source of fecal bacteria. However, bacteria loads from homeless encampments were included within the urban runoff categorized as point source discharges regulated through NPDES requirements for MS4 discharges, as discussed in section 9.3. If an LA were to be assigned to homeless encampments, the LA would be zero.

10 Implementation Plan

This section describes the actions necessary to implement the TMDLs that have been developed to attain WQOs for indicator bacteria in the shoreline segments evaluated for this project. The plan describes implementation responsibilities assigned to point source and nonpoint source dischargers and describes the schedule and key milestones for the actions to be taken.

The goal of the Implementation Plan is to ensure that WQOs¹¹ for indicator bacteria for the shoreline segments at BB and SISP are attained and maintained throughout the waterbody and in all seasons of the year. WQOs are considered “attained” when the waterbody can be removed from the Section 303(d) List of Water Quality Limited Segments (List). WQOs are considered “maintained” when, upon subsequent listing cycles, the waterbody has not returned to an impaired condition and been put back on the List. Attaining and maintaining WQOs will be accomplished by achieving wasteload allocations (WLAs) for point sources and load allocations (LAs) for nonpoint sources.

10.1 Regulatory Authority for Implementation Plans

TMDL implementation plans are not currently required under federal law; however, federal policy is that TMDLs should include implementation plans. Clean Water Act section 303 [and Code of Federal Regulations Title 40 section 130] authorizes the USEPA to require implementation plans for TMDLs. USEPA regulations implementing section 303 do not currently require states to include implementation plans for TMDLs but are likely to be revised in the future. USEPA regulations require states to incorporate TMDLs in the State Water Quality Management Plans (Basin Plans) along with adequate implementation measures to implement all aspects of the plan.¹² According to USEPA policy, states must include implementation plans as an element of TMDL Basin Plan amendments submitted to USEPA for approval.¹³

TMDL implementation plans are required under State law. Basin plans must have a program of implementation to achieve WQOs.¹⁴ The implementation plan must include a description of actions that are necessary to achieve the objectives, a time schedule for these actions, and a description of surveillance to determine compliance with the WQOs.¹⁵ State law requires that a TMDL include an implementation plan since a TMDL supplements, interprets, and/or refines existing WQOs. The TMDLs, LAs, and WLAs must be incorporated into the Basin Plan.¹⁶

¹¹ Code of Federal Regulations Title 40 section 131.38(b)(2)

¹² Code of Federal Regulations Title 40 section 130.6

¹³ See *Guidance for Developing TMDLs in California*, USEPA Region 9, (January 7, 2000).

¹⁴ See Water Code section 13050(j). A “Water Quality Control Plan” or “Basin Plan” consists of a designation or establishment for the waters within a specified area of all of the following: (1) Beneficial uses to be protected, (2) Water quality objectives and (3) A program of implementation needed for achieving water quality objectives.

¹⁵ See Water Code section 13242.

¹⁶ See Clean Water Act section 303(e).

10.2 Implementation Plan Objectives

The specific objectives of this Implementation Plan are as follows:

1. Identify the persons responsible for meeting the WLAs in discharges of bacteria to the impaired shoreline segments of BB and SISP.
2. Establish a time schedule for meeting the LAs and WLAs. The schedule will establish interim milestones that are to be achieved until the LAs and WLAs are achieved.
3. Reissue or revise the various existing statewide and regional NPDES requirements that regulate urban runoff and other point source discharges to the shoreline segments of BB and SISP to implement WLAs set forth in section 8.
4. Establish mechanisms to track best management practice (BMP) implementation, monitor BMP effectiveness in achieving the allocations in bacteria discharges, assess success in achieving TMDL objectives and milestones, and report on TMDL program effectiveness in attaining WQOs for indicator bacteria in the receiving waters at the impaired shoreline segments of BB and SISP.

10.3 Allocations and Identification of Dischargers

Allocations for each watershed are described in Tables 8-1 thru 8-6 and are expressed as “loads” in terms of number of bacteria colonies per 30-day period (billion MPN/30 days) for wet weather loads, and number of bacteria colonies per day (billion MPN/day) for dry weather loads. Allocations are expressed as either WLAs for point sources, or LAs for nonpoint sources. The only persons identified that are responsible for controllable point source discharges include the owners and operators of Phase I MS4 systems within the affected watersheds. There were no controllable nonpoint source discharges identified.

Although allocations are distributed to the identified discharges of bacteria, this is not to say that other potential sources do not exist. Any potential sources in the watersheds not receiving an explicit allocation described in this Technical Report is allowed a zero discharge of bacteria to the impair shoreline segments of BB and SISP.

10.3.1 Point Source Discharges

Because bacteria loading within urbanized areas generally originate from urban runoff discharged from MS4s, the primary mechanism for TMDL attainment will be increased regulation of these discharges. Persons whose point source discharges contribute to the exceedance of WQOs for indicator bacteria (as discussed in section 9) will be required to meet the WLAs in their urban runoff before it is discharged from MS4s to the receiving waters. Municipal Dischargers are responsible for reducing bacteria loads in their urban runoff prior to discharge to impaired receiving waters because they own or operate MS4s that contribute to the impairment of receiving waters. These discharges

are identified in and regulated by NPDES requirements prescribed in the State Water Board and San Diego Water Board orders listed in Table 10-1 below.

Table 10-1. State and San Diego Water Board Orders Regulating Applicable MS4 Discharges

Order Number/Short Name	Order Title
San Diego Water Board Order No. R9-2007-0001 <i>San Diego County MS4 NPDES Requirements</i>	<i>Waste Discharge Requirements for Discharges of Urban Runoff from the Municipal Separate Storm Sewer Systems (MS4s) Draining the Watersheds of the County of San Diego, the Incorporated Cities of San Diego County, the San Diego Unified Port District, and the San Diego County Regional Airport Authority</i>
San Diego Water Board Order No. R9-2008-0001 <i>Orange County MS4 NPDES Requirements</i>	<i>Waste Discharge Requirements for Discharges of Urban Runoff from the Municipal Separate Storm Sewer Systems (MS4s) Draining the Watersheds of the County of Orange, the Incorporated Cities of Orange County, and the Orange County Flood Control District within the San Diego Region</i>

10.3.2 Nonpoint Source Discharges

Nonpoint source discharges from natural sources (e.g., birds, terrestrial and aquatic animals, and other unidentified sources in the waters) are largely uncontrollable, and therefore cannot be regulated. Bacteria loads attributed to natural sources were back-calculated by the dry weather EFDC model, as discussed in section 7.2.5.

The land use information provided in Table 2-1 indicates that controllable nonpoint source discharges from agriculture, livestock operations, and horse ranches do not exist in the watersheds draining into BB and SISP. This is also supported by the source analysis presented in section 5 where controllable nonpoint sources were not identified as contributors of bacteria. Therefore, no controllable nonpoint sources were identified or assigned a LA.

10.3.3 Responsible Municipal Dischargers

One WLA was assigned collectively to the Municipal Dischargers in each watershed. This WLA was not divided up among the individual jurisdictions in each watershed because MS4s under different jurisdictions are often interconnected. The Municipal Dischargers within each watershed are collectively responsible for meeting the WLA and required reductions in bacteria loads for these watersheds and for meeting all of the TMDL requirements. Responsible municipalities in each affected watershed are listed in Table 10-2 below.

Table 10-2. Responsible Municipalities

Waterbody	Hydrologic Descriptor	Shoreline Segment	Responsible Municipalities
Dana Point Harbor	Dana Point HSA (901.14)	Baby Beach	County of Orange City of Dana Point
San Diego Bay	Point Loma HA (908.10)	Shelter Island Shoreline Park	City of San Diego San Diego Unified Port District

10.4 Compliance Schedule for Achieving Allocations

The purpose of these TMDLs is to attain and maintain the applicable WQOs in impaired shoreline segments through incremental mandated reductions of bacteria from point sources discharging to impaired waters. The requirements of this project mandate that dischargers improve water quality conditions in impaired waters by achieving wasteload reductions in their discharges. The bacteria TMDLs shall be implemented in a phased approach with a monitoring component to determine the effectiveness of each phase and guide the selection of BMPs.

10.4.1 Compliance Schedule

In establishing the compliance schedules for achieving the bacteria WLAs, the San Diego Water Board must balance the need of the dischargers for a reasonable amount of time to implement an effective bacteria load reduction program against the broad-based public interest in having water quality standards attained in the waters of the Region as soon as practicable. The public interest is best served when dischargers take all reasonable and immediately feasible actions to reduce pollutant discharges to impaired waters in the shortest possible time. In fact, pursuant to receiving water limitations in the San Diego and Orange County MS4 NPDES requirements (see section 10.5.2), the dischargers should already be planning and implementing a best management practices (BMP) program and monitoring for all MS4 bacteria and other pollutant discharges that cause or contribute to violations of water quality standards in the water quality limited segments within, or receiving pollutant discharges from their jurisdictions. Based on the TMDLs, LAs, WLAs, and water quality monitoring data, compliance schedules were developed for each impaired shoreline segment, as discussed below.

Baby Beach Compliance Schedule

According to Tables 8-1 through 8-3, no wet weather wasteload reductions are required for TC and FC. This means that according to the wet weather models for BB, REC-1 WQOs for TC and FC are not expected to be exceeded due to discharges from the MS4s. The only wet weather wasteload reductions required for MS4s discharging into the receiving waters along the shoreline at BB is for ENT. The compliance schedule for BB to achieve wet weather TMDLs is as shown in Table 10-3.

**Table 10-3. Compliance Schedule for
 Baby Beach to Achieve Wet Weather TMDLs**

Year (after OAL Approval)	Required Wasteload Reduction	TMDL Compliance Action
1	No reduction required	<ul style="list-style-type: none"> ▪ Water Quality Monitoring ▪ Implement BMPs
2	Same as above	<ul style="list-style-type: none"> ▪ Water Quality Monitoring ▪ Implement BMPs
3	Same as above	<ul style="list-style-type: none"> ▪ Water Quality Monitoring ▪ Implement BMPs
4	Same as above	<ul style="list-style-type: none"> ▪ Water Quality Monitoring ▪ Implement BMPs
5	Same as above	<ul style="list-style-type: none"> ▪ Water Quality Monitoring ▪ Implement BMPs
6	Same as above	<ul style="list-style-type: none"> ▪ Water Quality Monitoring ▪ Implement BMPs
7	50 percent ENT reduction	<ul style="list-style-type: none"> ▪ Water Quality Monitoring ▪ Implement BMPs
8	Same as above	<ul style="list-style-type: none"> ▪ Water Quality Monitoring ▪ Implement BMPs
9	Same as above	<ul style="list-style-type: none"> ▪ Water Quality Monitoring ▪ Implement BMPs
10	100 percent ENT reduction	<ul style="list-style-type: none"> ▪ Water Quality Monitoring ▪ Implement BMPs ▪ Submit request for removal from 303(d) List (if not requested and removed earlier)

The phased compliance schedule to achieve wet weather TMDLs will provide the MS4 dischargers time to identify sources, develop plans and implement enhanced and expanded BMPs capable of achieving the mandated decreases in bacteria densities at the BB shoreline.

According to Tables 8-4 through 8-6, dry weather wasteload reductions are required for TC, FC, and ENT. Based on the data reviewed in the impairment overview discussed in section 2.3.1, of the samples collected between January 2002 and December 2006, only the number of exceedances for ENT (283 exceedances) are greater than the number of allowed exceedances to recommend removal from the 303(d) List (193 exceedances). However, most of the exceedances for ENT occurred before 2006. The trend in the water quality data from BB indicate that the number of REC-1 WQO exceedances have declined significantly beginning in 2006. According to the City of Dana Point and County of Orange, several BMPs have been implemented, including a dry weather flow diversion structure on the east end of the beach, that are responsible for the significant improvements in water quality. If the current trend continues, the San Diego Water Board expects that the dry weather TMDLs for BB can be achieved within

the next 5 years. The compliance schedule for BB to achieve dry weather TMDLs is as shown in Table 10-4.

Table 10-4. Compliance Schedule for Baby Beach to Achieve Dry Weather TMDLs

Year (after OAL Approval)	Required Wasteload Reduction	TMDL Compliance Action
1	No reduction required	<ul style="list-style-type: none"> ▪ Water Quality Monitoring ▪ Implement BMPs
2	Same as above	<ul style="list-style-type: none"> ▪ Water Quality Monitoring ▪ Implement BMPs
3	50 percent reduction	<ul style="list-style-type: none"> ▪ Water Quality Monitoring ▪ Implement BMPs
4	Same as above	<ul style="list-style-type: none"> ▪ Water Quality Monitoring ▪ Implement BMPs
5	100 percent reduction	<ul style="list-style-type: none"> ▪ Water Quality Monitoring ▪ Implement BMPs ▪ Submit request for removal from 303(d) List (if not requested and removed earlier)

Shelter Island Shoreline Park Compliance Schedule

According to Tables 8-1 through 8-6, there are no wasteload reductions required for MS4s discharging into the receiving waters along the shoreline at SISP under both wet weather and dry weather conditions. This means that according to the wet weather and dry weather models for SISP, REC-1 WQOs are not expected to be exceeded due to discharges from the MS4s. Additionally, based on the data reviewed in the impairment overview discussed in section 2.3.2, of the samples collected between January 2003 and November 2006, only the number of exceedances for ENT (24 exceedances) are greater than the number of allowed exceedances to recommend removal from the 303(d) List (23 exceedances).

Given that the modeled wasteload reductions for both wet weather and dry weather conditions for all indicator bacteria are zero percent, no compliance schedules were developed to meet wasteload reductions for SISP. However SISP will remain on the 303(d) List until enough data are collected to support removing SISP from the 303(d) List. Therefore, in order to comply with these TMDLs, the responsible municipalities must continue implementing BMPs and collecting data until there are enough data to support the and maintain the removal of SISP from the 303(d) List.

The trend in the water quality data from SISP indicate that the number of REC-1 WQO exceedances have declined significantly since 2003. If the current trend continues, the San Diego Water Board expects that SISP will have enough data to support removal of SISP from the 303(d) List by 2010, and no later than 2012.

10.5 San Diego Water Board Actions

This section describes the actions that the San Diego Water Board will take to implement the TMDLs. The TMDLs will be implemented primarily by reissuing or revising the existing NPDES requirements for MS4 discharges to include WQBELs that are consistent with the assumptions and requirements of the bacteria WLAs for MS4 discharges. The process for issuance of NPDES requirements is distinct from the TMDL process, and is described in section 10.5.1. WQBELs for municipal stormwater discharges can be either numeric or non-numeric. Non-numeric WQBELs typically are a program of expanded or better-tailored BMPs. The USEPA expects that most WQBELs for NPDES-regulated municipal discharges will be in the form of BMPs, and that numeric limitations will be used only in rare instances.¹⁷ WQBELs can be incorporated into NPDES requirements for MS4 discharges by reissuing or revising these requirements.

10.5.1 Process and Schedule for Issuing NPDES Requirements

The public process for issuing NPDES requirements is distinct from but similar to the process for adopting TMDLs. For NPDES requirements, the process begins when the operator of the facility (discharger) submits a report of waste discharge (RoWD) to the San Diego Water Board for review. After reviewing the RoWD, the San Diego Water Board must make a decision to proceed with the NPDES requirements. Using the information and data in the RoWD, the San Diego Water Board develops draft NPDES requirements and the justification for the conditions (referred to as the fact sheet).

The first major step in the development process is to develop numerical effluent limitations on the amounts of specified pollutants that may be discharged and/or specified BMPs designed to minimize water quality impacts. These numerical effluent limitations and BMPs or other non-numerical effluent limitations must implement both technology-based and water quality-based requirements of the Clean Water Act. TBELs represent the degree of control that can be achieved by point sources using various levels of pollution control technology. If necessary to achieve compliance with applicable water quality standards, NPDES requirements must contain WQBELs, derived from the applicable receiving water quality standards, more stringent than the applicable technology-based standards. In the context of a TMDL, the WQBELs must be consistent with the assumptions and requirements of the WLAs of any applicable TMDL. Following the development of effluent limitations, the San Diego Water Board develops appropriate monitoring and reporting conditions, facility-specific special conditions, and includes standard provisions that are the same for all NPDES requirements.

After the draft NPDES requirements are complete, the San Diego Water Board provides an opportunity for public participation in the process. A public notice announces the

¹⁷ USEPA memorandum entitled "Establishing Total Maximum Daily Load (TMDL) Wasteload Allocations (WLAs) for Storm Water Sources and NPDES Permit Requirements Based on Those WLAs," dated November 22, 2002.

availability of the draft requirements, and interested persons may submit comments. Based on the comments, the San Diego Water Board develops the final requirements, documenting the process and decisions in the administrative record. The final NPDES requirements are issued to the facility in an order adopted by the San Diego Water Board.

Although NPDES requirements must contain WQBELs that are consistent with the assumptions and requirements of the TMDL WLAs, the federal regulations¹⁸ do not require the WQBELs to be identical to the WLAs. The regulations leave open the possibility that the San Diego Water Board could determine that fact-specific circumstances render something other than literal incorporation of the WLA into discharge requirements to be consistent with the TMDL assumptions and requirements. For example, the WLAs in Tables 8-1 through 8-6 are expressed as billion MPN per 30 days (or per day); however, the WQBELs prescribed in response to the WLAs may or may not be written using the same metric. WQBELs may be expressed as numeric effluent limitations using a different metric, or, more likely, as BMP development, implementation, and revision requirements.

NPDES requirements should be issued, reissued, or revised “as expeditiously as practicable” to incorporate WQBELs derived from the TMDL WLAs. “As expeditiously as practicable” means the following:

1. **New point sources.** “New” point sources previously unregulated by NPDES requirements must obtain their NPDES requirements before they can lawfully discharge pollutants. For point sources receiving NPDES requirements for the first time, “as expeditiously as practicable” means that the San Diego Water Board incorporates WQBELs that are consistent with the assumptions and requirements of the WLAs into the NPDES requirements and requires compliance with the WQBELs upon the commencement of the discharge.
2. **Point Sources Currently Regulated Under NPDES Requirements.** For point sources currently regulated under NPDES requirements, “as expeditiously as practicable” means that:
 - a. WQBELs that are consistent with the assumptions and requirements of the WLAs should be incorporated into NPDES requirements during their 5-year term, prior to expiration, in accordance with the applicable NPDES requirement reopening provisions, taking into account factors such as available NPDES resources, staff and budget constraints, and other competing priorities.
 - b. In the event the NPDES requirement revisions cannot be considered during the 5-year term, the San Diego Water Board will incorporate

¹⁸ Code of Federal Regulation Title 40 section 122.44(d)(1)(vii)(B)

WQBELs that are consistent with the assumptions and requirements of the WLAs into the NPDES requirements at the end of the 5-year term.

10.5.2 Actions with respect to Phase I Municipal Dischargers

California's Municipal Stormwater Program regulates stormwater discharges from MS4s. NPDES requirements for MS4 discharges were issued in two phases. Under Phase I, which began in 1990, the Regional Water Boards adopted NPDES urban runoff requirements for medium (serving between 100,000 and 250,000 people) and large (serving 250,000 people) municipalities. Most of these requirements are issued to a group of municipalities encompassing an entire metropolitan or county area. These requirements are issued for fixed terms of five years and are reissued upon the request of the discharger as they expire.

The Phase I Municipal Dischargers in San Diego and Orange County are required under Receiving Water Limitations A.3.a.1 and C.2¹⁹ of Orders No. R9-2007-0001 and R9-2002-0001, respectively (San Diego County and Orange County MS4 NPDES requirements) to implement additional BMPs to reduce bacteria discharges in impaired watersheds to the maximum extent practicable and to restore compliance with the bacteria WQOs. This obligation is triggered when either the discharger or the San Diego Water Board determines that MS4 discharges are causing or contributing to an exceedance of an applicable WQO, in this case indicator bacteria WQOs. Designation of the BB and SISP shoreline segments as water quality limited segments under Clean Water Act section 303(d) provided sufficient evidence that that MS4 discharges are causing or contributing to the violation of water quality standards. Thus, the Municipal Dischargers should be implementing the provisions of Receiving Water Limitation C.2 with respect to bacteria discharges into water quality limited segments.

In addition to enforcing the provisions of Receiving Water Limitation C.2, the San Diego Water Board shall reissue or revise Orders No. R9-2007-0001 and R9-2002-0001, to incorporate WQBELs consistent with the assumptions and requirements of the bacteria WLAs, and requirements for monitoring and reporting. In those orders, the Phase I Municipal Dischargers are referred to as "Copermittees."²⁰ WQBELs and other

¹⁹ Receiving Water Limitations A.3.a.1 and C.2.a provide that "[u]pon a determination by either the Copermittee or the San Diego Water Board that MS4 discharges are causing or contributing to an exceedance of an applicable water quality standard, the Copermittee shall promptly notify and thereafter submit a report to the San Diego Water Board that describes BMPs that are currently being implemented and additional BMPs that will be implemented to prevent or reduce any pollutants that are causing or contributing to the exceedance of water quality standards. The report may be incorporated in the annual update to the Jurisdictional URMP unless the San Diego Water Board directs an earlier submittal. The report shall include an implementation schedule. The San Diego Water Board may require modification to the report." Additional requirements are included in sections C.2.b-d.

²⁰ Copermittees own or operate MS4s through which urban runoff discharges into waters of the U.S. within the San Diego Region. These MS4s fall into one or more of the following categories: (1) a medium or large MS4 that services a population of greater than 100,000 or 250,000 respectively; or (2) a small MS4 that is "interrelated" to a medium or large MS4; or (3) an MS4 which contributes to a violation of a water quality standard; or (4) an MS4 which is a significant contributor of pollutants to waters of the United States.

requirements implementing the TMDLs can be incorporated into these NPDES requirements upon the normal renewal cycle or sooner, if appropriate. The requirements implementing the TMDLs shall include the following:

- a. WQBELs consistent with the requirements and assumptions of the bacteria WLAs described in Tables 8-1 through 8-6 and a schedule of compliance applicable to the MS4 discharges into the impaired shoreline segments described in Table 10-3. At a minimum, WQBELs shall include a BMP program of expanded or better-tailored BMPs to attain the WLAs.
- b. If the WQBELs consist of BMP programs, then the reporting requirements shall consist of annual progress reports on BMP planning, implementation, and effectiveness in attaining the WQOs in impaired shoreline segments, and annual water quality monitoring reports. The first progress report shall consist of a Bacteria Load Reduction Plan (BLRP). BLRPs must be specific to each impaired waterbody.

To provide guidance to the dischargers in preparing BLRPs, the following bullets describe components that should be considered for incorporation in the BLRPs.

Bacteria Load Reduction Plans should include the following components:

Comprehensive Watershed Approach

- Dischargers should identify the Lead Watershed Contact for their BLRPs. The Lead Watershed Contact should serve as liaison between all other common watershed dischargers and the San Diego Water Board, where appropriate.
- Dischargers should describe a program for encouraging collaborative, watershed-based, land-use planning in their jurisdictional planning departments.
- Dischargers should develop and periodically update a map of the BLRP watershed, to facilitate planning, assessment, and collaborative decision-making. As appropriate, the map should include features such as receiving waters; Clean Water Act section 303(d) impaired receiving waters; water quality projects; land uses; MS4s; major highways; jurisdictional boundaries; and inventoried commercial, industrial, and municipal sites.
- Dischargers should annually assess the water quality of the impaired water body in their BLRPs in order to identify all water quality problems within the impaired water body. This assessment should use applicable

water quality data, reports, and analysis generated in accordance with the requirements of the applicable NPDES MS4 monitoring and reporting programs, as well as applicable information available from other public and private organizations.

- Dischargers should develop and implement a collective watershed BLRP strategy to meet the bacteria TMDL. The strategy should guide dischargers in developing a Bacteria Compliance Schedule (BCS) which includes BMP planning and scheduling as outlined below.
- Dischargers should collaborate to develop and implement the BLRPs. The BLRP should include a proposal for frequent regularly scheduled meetings among the dischargers in the impaired watershed.
- Each BLRP and BCS should be reviewed annually to identify needed modifications and improvements. The dischargers should develop and implement a plan and schedule, included in the BCS, to address the identified modifications and improvements. All updates to the BLRP should be documented in the BLRP, and submitted to the San Diego Water Board. Individual dischargers should also review and modify their jurisdictional ordinances and activities as necessary so that they are consistent with the requirements of the BLRP.

Bacteria Compliance Schedule - BMP Planning and Scheduling

The BCS should identify the BMPs/water quality projects that are planned for implementation and provide an implementation schedule for each BMP/water quality project. The BCS should demonstrate how the BMPs/water quality projects will address all the bacteria TMDLs. The BCS, at a minimum, should include scheduling for the following:

Non-structural BMP phasing:

- Initial Non-Structural BMP Analysis - Watershed data should be analyzed to identify effective non-structural BMPs for implementation. This should be completed and included in the BCS.
- Scheduled Annual Non-structural BMP Implementation - The above analysis should be used to identify BMPs that will be implemented and to develop an aggressive non-structural BMP implementation schedule. The BCS should include a schedule of the current BMP staffing for each impaired area, and provide a discussion on adjustments to staff scheduling to meet new non-structural BMP demands. Schedules should be realistic and justifiable.

- Scheduled Annual BMP Assessment and Optimizing Adjustments - As the non-structural BMPs are being implemented, a scheduled in-depth assessment of the non-structural BMPs' performance should follow. Non-structural BMPs that are found to be ineffective should be modified to incorporate optimizing adjustments to improve performance or be replaced by other effective non-structural BMPs. The results from this assessment should also be used to determine structural BMP selection and the schedule for structural BMP implementation. The BCS should include an annual schedule for in-depth non-structural BMP assessment and optimizing adjustments.
- Scheduled Continuous Budget and Funding Efforts- Securing budget and funding for non-structural BMP staffing and equipment should be scheduled early and continue until the bacteria TMDLs are met. The BCS should include a schedule for staff time, including position and job description, authorized for securing budget and funding for non-structural BMP implementation.

Structural BMP phasing:

- Scheduled Initial Structural BMP Analysis– Structural BMP analysis should utilize all available information, including the non-structural BMP assessment, to identify, locate, design and build structural BMPs, or a train of BMPs, to meet the these bacteria TMDLs. The BCS should include a schedule for structural BMP analysis.
- Scheduled Annual BMP Construction - The BCS should include a projected general construction schedule with a realistic and justifiable timeline for BMP construction.
- Scheduled Annual BMP Assessment, Optimization Adjustments, and Maintenance - Assessment for structural BMPs should begin immediately upon initial BMP completion, followed by continuously scheduled BMP assessment, optimization adjustments, and maintenance, to both the individual structural BMPs and the structural BMP program as a whole. The BCS should include an annual schedule for in-depth structural BMP assessment.
- Scheduled Continuous Budget and Funding Effort - Securing budget and funding for structural BMPs and additional maintenance staff should be scheduled early and continue until the bacteria TMDLs are met. The BCS should include a schedule for staff time, including position and job description, authorized for securing budget and funding for structural BMP implementation.

Subsequent reports should assess and describe the effectiveness of implementing the Bacteria Load Reduction Plan. Effectiveness assessments should be based on a program effectiveness assessment framework, such as the one developed by the California Stormwater Quality Association (CASQA, no date). Using the CASQA framework as an example, the assessments should address the framework's outcome levels 1-5 on an annual basis, and outcome level 6 once every five years.²¹ Methods used for assessing effectiveness should include the following or their equivalent: surveys, pollutant loading estimations, and receiving water quality monitoring. The long-term strategy should also discuss the role of monitoring data in substantiating or refining the assessment. Once WQOs have been attained, a reduced level of monitoring may be appropriate.

In addition to these requirements, if load-based numerical WQBELs are included in the NPDES requirements, the monitoring requirements should include flow and bacteria density measurements to determine if bacteria loads in effluent are in compliance with WQBELs.

The BLRPs are the municipal dischargers' opportunity to propose methods for assessing compliance with WQBELs that implement TMDLs. The monitoring components included in the BLRPs should be formulated according to particular compliance assessment strategies. The monitoring components are expected to be consistent with, and support whichever compliance assessment methods are proposed. The San Diego Water Board will coordinate with the municipal dischargers during the development of their proposed monitoring components and associated compliance assessment methods.

If NPDES requirements are not likely to be issued, reissued or revised within 6 months of OAL approval of these TMDLs, the San Diego Water Board may issue an investigative/monitoring order to dischargers pursuant to sections 13267 or 13383 of the Water Code. This order would require BMP planning and receiving water quality monitoring in adherence to performance measures described above.

The BLRPs may be re-evaluated at set intervals (such as 5-year renewal cycles for NPDES requirements, or upon request from responsible dischargers, as appropriate and in accordance with the San Diego Water Board priorities). Plans may be iterative and adaptive according to assessments and any special studies.

²¹ Outcome level 1 assesses compliance with activity-based permit requirements. Outcome level 2 assesses changes in attitudes, knowledge, and awareness. Outcome level 3 assesses behavioral change and BMP implementation. Outcome level 4 assesses pollutant load reductions. Outcome level 5 assesses changes in urban runoff and discharge water quality. Outcome level 6 assesses changes in receiving water quality. See CASQA "An Introduction to Stormwater Program Effectiveness Assessment."

10.5.3 Additional Actions

Additional actions that the San Diego Water Board can take to ensure implementation of the bacteria TMDLs are to take enforcement actions, and recommend high prioritization of TMDL implementation projects for grant funds as described below.

Take Enforcement Actions

The San Diego Water Board shall consider enforcement actions,²² as necessary, against any discharger failing to comply with applicable WDRs or discharge prohibitions. Enforcement actions may be taken, as necessary, to control the discharge of bacteria to impaired shorelines to attain compliance with the bacteria WLAs specified in this Technical Report, or to attain compliance with the bacteria WQOs.

Recommend High Priority for Grant Funds

The San Diego Water Board shall recommend that the State Water Board assign a high priority to awarding grant funding²³ for projects to implement the bacteria TMDLs. Special emphasis will be given to projects that can achieve quantifiable bacteria load reductions consistent with the specific bacteria TMDL WLAs and LAs.

10.6 Specific Implementation Objectives

Since this project began in 2002, the dischargers have implemented several non-structural BMP programs and structural BMPs that have apparently resulted in noticeable improvements in water quality at the impaired shoreline segments. Information recently obtained from by the San Diego Unified Port District and the County of Orange indicates that bacteria levels in the waters at BB and SISF have shown significant decreases in the number of exceedances of the REC-1 indicator bacteria WQOs during 2006.

As shown in Tables 8-1 through 8-6, the modeling results indicate that no load reductions are require for TC, FC, and ENT for SISF during wet weather or dry weather conditions. Additionally, the modeling results indicate that no load reductions are required for TC and FC for any of the impaired shoreline segments during wet weather

²² An enforcement action is any formal or informal action taken to address an incidence of actual or threatened noncompliance with existing regulations or provisions designed to protect water quality. Potential enforcement actions including notices of violation (NOVs), notices to comply (NTCs), imposition of time schedules (TSO), issuance of cease and desist orders (CDOs) and cleanup and abatement orders (CAOs), administrative civil liability (ACL), and referral to the attorney general (AG) or district attorney (DA). The San Diego Water Board generally implements enforcement through an escalating series of actions to: (1) assist cooperative dischargers in achieving compliance; (2) compel compliance for repeat violations and recalcitrant violators; and (3) provide a disincentive for noncompliance.

²³ In most cases, the State Water Board administers the awarding of grants funded from Proposition 13, Proposition 50, Clean Water Act section 319(h) and other federal appropriations to projects that can result in measurable improvements in water quality, watershed condition, and/or capacity for effective watershed management. Many of these grant fund programs have specific set-asides for expenditures in the areas of watershed management and TMDL project implementation for non-point source pollution.

conditions. According to the modeling results, only ENT wet weather load reductions are required for BB.

For dry weather, BB requires between approximately 83 percent and 96 percent wasteload reductions for TC, FC, or ENT. However, based only on the water quality data collected during 2006, the number of samples that exceed the REC-1 WQOs are less than the allowable number of exceedances for recommending removal from the 303(d) List. This trend implies that the water quality in the impaired shoreline segments may already meet REC-1 WQOs during dry weather. However, additional monitoring is required to confirm this trend.

While submission of the BLRPs required from the dischargers will still be a requirement, if current trends continue, monitoring and permanent implementation of the current programs and BMPs may be adequate in meeting the wet weather and dry weather TMDLs.

Therefore, assuming the water quality data continue the trend that will support delisting before the NPDES requirement revisions are considered, specific objectives of this Implementation Plan after delisting is found to be appropriate are as follows:

1. Persons responsible for monitoring the impaired shoreline segments of BB and SISP for bacteria will continue with the monitoring program to ensure REC-1 WQOs are maintained.
2. If REC-1 WQOs are exceeded, actions outlined in Attachment B of Order Nos. R9-2007-0001 and R9-2008-0001 in section II.C, Coastal Storm Drain Outfall Monitoring, will be implemented.
3. If sources of bacteria persist at levels that exceed water quality standards, then the persons responsible will take appropriate actions to identify and eliminate the source or sources of the chronic contamination.

If the impaired shoreline segments of BB and SISP remain on or are put back on the List during subsequent iterations of the 303(d) listing process, the San Diego Water Board will revise the NPDES requirements to be consistent with these TMDLs.

10.7 Coordination and Execution of Special Studies

The San Diego Water Board recognizes that coordination and execution of special studies by dischargers and other interested persons could result in improved TMDL analyses that more accurately protect beneficial uses. Areas of study that could benefit TMDL analysis include collection of data that can be used to improve model output, improved understanding of bacteria levels and the relationship to health effects, and identification of an appropriate and affordable method(s) to measure pathogens directly. Additionally, studies designed to measure BMP effectiveness and bacteria source identification (see section 10.5.2) will be useful for dischargers in identifying appropriate strategies to meet the requirements of this TMDL project.

10.7.1 Collect Data Useful for Model Improvement

Calibration and validation of the computer models used for TMDL analysis was based on limited data (water quality and/or flow) and assumed values for input parameters such as rates for bacteria die-off and re-growth. Especially limited are data related to fecal bacteria that can be attributed to natural sources (e.g., waterfowl and other sources within the waters). Studies designed to collect additional data that can be used for model improvement will result in more accurate TMDL results. Also, data from each watershed can be used to construct models that are applicable to the watershed from which the data originated.

10.7.2 Improve Understanding Between Bacteria Levels and Health Effects

The San Diego Water Board recognizes that there are potential problems associated with using indicator bacteria WQOs to indicate the presence of human pathogens in receiving waters free of sewage discharges. The indicator bacteria WQOs were developed, in part, based on epidemiological studies in waters with sewage inputs. The risk of contracting a water-borne illness from contact with urban runoff devoid of sewage, or human-source bacteria is not known. Some pathogens, such as *giardia* and *cryptosporidium* can be contracted from animal hosts. Likewise, domestic animals can pass on human pathogens through their feces. These and other uncertainties need to be addressed through special studies and, as a result, revisions to the TMDLs established in this project may be appropriate.

Indicator bacteria are used to measure the risk of swimmer illness because they have been shown to indicate the presence of human pathogens, such as viruses, when human bacteria sources are present. Indicator bacteria have been historically used because they are easier and less costly to measure than the pathogens themselves (see Appendix A). In recent years, however, questions have been raised regarding the validity of using indicator bacteria to ascertain risk to swimmers in recreational waters, since they appear to be less correlated to viruses when sources are from urban runoff (Jiang et al, 2001). In fact, most epidemiology studies conducted to measure the risk of swimmer illness in the presence of indicator bacteria have taken place in receiving waters containing known sewage impacts.

To date, only two epidemiology studies have been conducted where the bacteria source was primarily urban runoff. The Santa Monica Bay epidemiology study (Haile et al, 1999) reported that there was a direct correlation between swimming related illnesses and densities of indicator bacteria. The sites included in this study were known to contain human sources of fecal contamination. Most recently, the Mission Bay epidemiological study (Colford et al, 2005) showed that there was no correlation between swimmer illness and concentrations of indicator bacteria. Unlike Santa Monica Bay, bacteria sources in Mission Bay were shown to be primarily of nonhuman origin (City of San Diego and MEC/Weston, 2004). The studies caution against extrapolating the results from the Mission Bay study to other locations, since there have been extensive cleanup activities on this waterbody and subsequently bacteria source analyses have shown that human fecal sources are only a minor contributor. The link

between bacteria loads from urban runoff containing mostly nonhuman sources, and risk of illness needs to be better understood.

Recent studies have also shown that bacteria regrowth is a significant phenomenon (City of San Diego and MEC/Weston, 2004; City of Laguna Niguel and Kennedy Jenks, 2003). Such regrowth can cause elevations in bacteria levels that do not correspond to an increase in human pathogens and risk of illness. For example, the Mission Bay Source Identification Study found that bacteria multiply in the wrack line on the beach (eel grass and other debris) during low tide, caused exceedances of the water quality objectives during high tide when the wrack is inundated. This same phenomenon likely occurs inside storm drains, where tidal cycles and freshwater input can cause bacteria to multiply. In both these cases, an increase in bacteria densities does not necessarily correlate to an increase in the presence of human pathogens. The regrowth phenomenon is problematic since responsible parties must expend significant resources to reduce the current bacteria loads to receiving waters to meet the required waste load reductions.

As information is gathered, initiating special studies to understand the uncertainties between bacteria levels and bacteria sources within the watersheds may be useful. Specifically, continuing research may be helpful to answer the following questions:

- What is the risk of illness from swimming in water contaminated with urban/stormwater runoff devoid of sewage?
- Do exceedances of the bacteria water quality objectives from animal sources (wildlife and domestic) increase the risk of illness?
- Are there other, more appropriate surrogates for measuring the risk of illness than the indicator bacteria WQOs currently used?

Addressing these uncertainties is needed to maximize effectiveness of strategies to reduce the risk of illness, which is currently measured by indicator bacteria densities. Dischargers may work with the San Diego Water Board to determine if such special studies are appropriate.

10.7.3 Identification of Method for Direct Pathogen Measurement

Ultimately, the San Diego Water Board supports the idea of measuring pathogens (the agents causing impairment of beneficial uses) rather than indicator bacteria (surrogates for pathogens). However, as stated previously, indicator bacteria have been used to measure water quality historically because measurement of pathogens is both difficult and costly. The San Diego Water Board is supportive of any efforts by the scientific community to perform epidemiological studies and/or investigate the feasibility of measuring pathogens directly. The San Diego Water Board further supports subsequent modification of WQOs as a result of such studies. Ultimately, TMDLs will be recalculated if WQOs are modified due to results from future studies.

10.8 TMDL Implementation Milestones

Accomplishing the goals of the implementation plan will be achieved by cooperative participation from all responsible parties, including the San Diego Water Board. Major milestones are described below in Table 10-4.

Table 10-4. TMDL Implementation Milestones

Item	Implementation Action	Responsible Parties	Date
1	Effective date of San Diego Bay and Dana Point Harbor Bacteria TMDL Waste Load Allocations (WLAs).	San Diego Water Board Municipal Dischargers	Effective date*
2	Issue, reissue, or revise Phase I Municipal NPDES WDRs to include WQBELs consistent with the WLAs.	San Diego Water Board	Within 5 years of effective date
3	Submit annual Progress Report to San Diego Water Board due January 31 of each year.	Phase I Municipal Dischargers	Annually after reissue of NPDES WDRs
4	Recommend TMDL-related projects as high priority for grant funds.	San Diego Water Board	As needed after effective date
5	Coordination and execution of special studies.	San Diego Water Board, Municipal Dischargers	As needed after effective date
6	Meet 50% WLA reductions	Municipal Dischargers	5 years after effective date
7	Meet 100% WLA reductions in all watersheds by meeting all geometric mean & and single sample WQOs for REC-1.	Municipal Dischargers	10 years after effective date
8	Take enforcement actions to attain compliance with the WLAs.	San Diego Water Board	As needed after effective date

* Effective date is date of approval of these TMDLs by the Office of Administrative Law

11 Environmental Analysis, Environmental Checklist, and Economic Factors

The San Diego Water Board must comply with the California Environmental Quality Act (CEQA) when amending the Basin Plan²⁴ as proposed in this project to adopt these TMDLs for bacteria at the impaired shorelines of BB and SISP. Under the CEQA, the San Diego Water Board is the Lead Agency²⁵ for evaluating the environmental impacts of the reasonably foreseeable methods of compliance with the proposed TMDLs. The following section summarizes the environmental analysis conducted to fulfill the CEQA requirements. The complete environmental analysis, including the environmental checklist and discussion of economic factors, are discussed in detail in Appendix M.

11.1 California Environmental Quality Act Requirements

The CEQA authorizes the Secretary of the Resources Agency to certify state regulatory programs, designed to meet the goals of the CEQA, as exempt from its requirements to prepare an Environmental Impact Report (EIR), Negative Declaration, or Initial Study. The State Water Resources Control Board's (State Water Board's) and San Diego Water Board's Basin Plan amendment process is a certified regulatory program and is therefore exempt from the CEQA's requirements to prepare such documents.

The State Water Board's CEQA implementation regulations describe the environmental documents required for Basin Plan amendment actions. These documents consist of a written report that includes a description of the proposed activity, alternatives to the proposed activity to minimize or eliminate potentially significant environmental impacts, and identification of mitigation measures to minimize any significant adverse impacts.

The CEQA and CEQA Guidelines limit the scope to an environmental analysis of the reasonably foreseeable methods of compliance with the WLAs and LAs. The State Water Board CEQA Implementation Regulations for Certified Regulatory Programs require the environmental analysis to include at least the following:

1. A brief description of the proposed activity. In this case, the proposed activity is the TMDL Basin Plan amendment.
2. Reasonable alternatives to the proposed activity.
3. Mitigation measures to minimize any significant adverse environmental impacts of the proposed activity.

Additionally, the CEQA and CEQA Guidelines require the following components, some of which are repetitive of the list above:

²⁴ Public Resources Code section 21080.

²⁵ Public Resources Code section 21067. "Lead Agency" means the public agency, which has the principal responsibility for carrying out or approving a project. The Lead Agency will decide whether an EIR or Negative Declaration will be required for the project and will cause the document to be prepared.

1. An analysis of the reasonably foreseeable environmental impacts of the methods of compliance.
2. An analysis of reasonably foreseeable mitigation measures relating to those impacts.
3. An analysis of reasonably foreseeable alternative means of compliance with the rule or regulation, which would avoid or eliminate the identified impacts.

Additionally, the CEQA Guidelines require the environmental analysis take into account a reasonable range of:

1. Environmental factors.
2. Economic factors.
3. Technical factors.
4. Population.
5. Geographic areas.
6. Specific sites.

11.2 Analysis of Reasonably Foreseeable Methods of Compliance

The analysis of potential environmental impacts is based on the numerous alternative means of compliance available for controlling bacteria loading to the impaired shoreline segments of BB and SISP. The only controllable sources of bacteria are attributed to the MS4s that drain the watersheds that drain into the receiving waters. Attainment of the WLAs will be achieved through discharger implementation of structural and non-structural BMPs for point sources. The BMP control strategies should be designed to reduce bacteria loading in urban and stormwater runoff.

The controls evaluated in Appendix M include the following non-structural and structural BMPs:

- Education and outreach;
- Road and street maintenance;
- Storm drain system cleaning;
- BMP inspection and maintenance;
- Enforcement of local ordinances;
- Buffer strips and vegetated swales;
- Bioretention
- Infiltration trenches
- Sand filters
- Diversion/treatment systems.

Structural and non-structural control strategies can be based on specific land uses, sources, or periods of a storm event. In order to comply with these TMDLs, emphasis should be placed on BMPs that control the sources of pollutants and on the maintenance of BMPs that remove pollutants from runoff.

11.3 Possible Environmental Impacts

The CEQA and CEQA Guidelines require an analysis of the reasonably foreseeable environmental impacts of the methods of compliance with the TMDL Basin Plan amendment. The environmental checklist identifies the potential environmental impacts associated with these methods with respect to earth, air, water, plant life, animal life, noise, light, land use, natural resources, risk of upset, population, housing, transportation, public services, energy, utilities and services systems, human health, aesthetics, recreation, and archeological/historical concerns. There were no reasonably foreseeable environmental impacts identified in the checklist considered to be “Potentially Significant,” though several were considered “Less than Significant with Mitigation.” See sections 4 and 5 in Appendix M for a complete discussion of the potential environmental impacts.

In addition to the potential impacts mentioned above, mandatory findings of significance regarding short-term, long-term, cumulative, and substantial impacts were evaluated. Based on this review, the San Diego Water Board concluded that the potentially significant cumulative impacts can be mitigated to less than significant levels as discussed in Appendix M.

11.4 Alternative Means of Compliance

The CEQA requires an analysis of reasonably foreseeable alternative means of compliance with the rule or regulation, which would avoid or eliminate the identified impacts. The dischargers can use the structural and non-structural BMPs described in Appendix M or other structural and non-structural BMPs, to control and prevent pollution, and meet the TMDLs’ required load reductions. The alternative means of compliance with the TMDLs consist of the different combinations of structural and non-structural BMPs that the dischargers might use. Since most of the adverse environmental effects are associated with the construction and installation of large scale structural BMPs, to avoid or eliminate impacts, compliance alternatives should minimize structural BMPs, maximize non-structural BMPs, and site, size, and design structural BMPs in ways to minimize environmental effects.

11.5 Reasonably Foreseeable Methods of Compliance at Specific Sites

The San Diego Water Board analyzed various reasonably foreseeable methods of compliance at specific sites within the subject watersheds. The specific sites analysis was focused on reviewing potential compliance methods within various land uses. The land uses analyzed correspond to the land uses that were utilized for watershed model development (discussed section 7).

In the discussion of potential compliance methods in section 6 of Appendix M, the San Diego Water Board assumed that, generally speaking, the BMPs suitable for the control of bacteria generated from a specific land use within a given watershed were also suitable for the control of bacteria generated from the same land use category within a different watershed. For example, a BMP used to control the discharge of bacteria from a residential area in the San Diego County watershed is likely suitable to control the

discharge of bacteria from a residential area in the Orange County watershed. However, in addition to land use, BMP selection includes considering site-specific geographical factors such as average rainfall, soil type, and the amount of impervious surfaces, and non-geographical factors such as available funding. Such factors vary between watersheds. The most suitable BMP(s) for a particular site must be determined by the dischargers in a detailed, project-specific environmental analysis.

In order to meet TMDL requirements, dischargers will determine and implement the actual compliance method(s) after a thorough analysis of the specific sites suitable for BMP implementation within each watershed. In most cases, the San Diego Water Board anticipates a potential strategy to be the use of non-structural BMPs as a first step in controlling bacteria discharges, followed by structural BMP installation if necessary.

11.6 Economic Factors

The environmental analysis required by the CEQA must take into account a reasonable range of economic factors. This section contains estimates of the costs of implementing the reasonably foreseeable methods of compliance with the TMDL Basin Plan amendment. Specifically, this analysis estimates the costs of implementing the structural and non-structural BMPs which the dischargers could use to reduce bacteria loading.

As discussed in section 7 in Appendix M, the cost estimates for non-structural BMPs ranged from \$0 to \$211,000. For SISP, the cost estimates for treating 10 percent of the watershed with structural BMPs ranged from approximately \$900 to over \$1 million, depending on BMP selection, with yearly maintenance costs estimated from less than \$200 to over \$10,000. For BB, the cost estimates for treating 10 percent of the watershed with structural BMPs ranged from approximately \$46,000 to approximately \$11 million, depending on BMP selection, with yearly maintenance costs estimated from approximately \$8,000 to over \$760,000. Implementation of these TMDLs will also entail water quality monitoring which has associated costs. Assuming that a two-person sampling team can collect samples at 5 sites per day, the total cost for one day of sampling would be \$2,291.

The specific BMPs to be implemented will be chosen by the dischargers after adoption of these TMDLs. All costs are preliminary estimates since particular elements of a BMP, such as type, size, and location, would need to be developed to provide a basis for more accurate cost estimations.

11.7 Reasonable Alternatives to the Proposed Activity

The environmental analysis must include an analysis of reasonable alternatives to the proposed activity. The proposed activity is a Basin Plan Amendment to incorporate bacteria TMDLs for the impaired shoreline segments of BB and SISP. The purpose of this analysis is to determine if there is an alternative that would feasibly attain the basic objective of the rule or regulation (the proposed activity), but would lessen,

avoid, or eliminate any identified impacts. The alternatives analyzed include taking no action or modifying water quality standards. These alternative actions are discussed in section 8 of Appendix M. Because these alternatives are not expected to attain the basic objective of the proposed activity at this point in time, the preferred alternative is the proposed activity itself, which is the Basin Plan amendment incorporating the bacteria TMDLs.

12 Necessity of Regulatory Provisions

The Office of Administrative Law (OAL) is responsible for reviewing administrative regulations proposed by state agencies for compliance with standards set forth in California's Administrative Procedure Act, Government Code section 11340 *et seq.*, for transmitting these regulations to the Secretary of State and for publishing regulations in the California Code of Regulations. Following State Water Board approval of this Basin Plan amendment establishing TMDLs, any regulatory portions of the amendment must be approved by the OAL per Government Code section 11352. The State Water Board must include in its submittal to the OAL a summary of the necessity²⁶ for the regulatory provision.

This Basin Plan amendment for Bacteria Impaired Waters meets the “necessity standard” of Government Code section 11353(b). Amendment of the Basin Plan to establish and implement bacteria TMDLs in affected watersheds in the San Diego Region is necessary because the existing water quality does not meet applicable numeric WQOs for indicator bacteria. Applicable state and federal laws require the adoption of this Basin Plan amendment and regulations as provided below.

The State Water Board and Regional Water Boards are delegated the responsibility for implementing California's Porter-Cologne Water Quality Control Act and the federal Clean Water Act. Pursuant to relevant provisions of both of those acts the State Water Board and San Diego Water Board establish water quality standards, which include designated beneficial uses and water quality criteria or objectives to protect those uses.

Clean Water Act section 303(d) [United States Code Title 33 section 1313(d)] requires the states to identify certain waters within their borders that are not attaining water quality standards and to establish TMDLs for certain pollutants impairing those waters. USEPA regulations²⁷ provide that a TMDL is a numerical calculation of the amount of a pollutant that a water body can assimilate and still meet water quality standards. A TMDL includes one or more numeric targets that represent attainment of the applicable standards, considering seasonal variations and a margin of safety (MOS), in addition to the allocation of the target or load among the various sources of the pollutant. These include wasteload allocations (WLAs) for point sources, and load allocations (LAs) for nonpoint sources and background sources. TMDLs established for impaired waters must be submitted to the USEPA for approval.

Clean Water Act section 303(e) requires that TMDLs, upon USEPA approval, be incorporated into the state's Water Quality Management Plans, along with adequate

²⁶ "Necessity" means the record of the rulemaking proceeding demonstrates by substantial evidence the need for a regulation to effectuate the purpose of the statute, court decision, provision of law that the regulation implements, interprets, or makes, taking into account the totality of the record. For purposes of this standard, evidence includes, but is not limited to, facts, studies, and expert opinion. [Government Code section 11349(a)].

²⁷ Code of Federal Regulations Title 40 section 130.2

measures to implement all aspects of the TMDL. In California, these are the basin plans for the nine regions. Water Code sections 13050(j) and 13242 require that basin plans have a program of implementation to achieve WQOs. The implementation program must include a description of actions that are necessary to achieve the objectives, a time schedule for these actions, and a description of surveillance to determine compliance with the objectives. State law requires that a TMDL project include an implementation plan because TMDLs normally are, in essence, interpretations or refinements of existing WQOs. The TMDLs have to be incorporated into the Basin Plan,²⁸ and, because the TMDLs supplement, interpret, or refine existing objectives, State law requires a program of implementation.

²⁸ Clean Water Act section 303(e)

13 Public Participation

Public participation is an important component of TMDL development. The federal regulations require that TMDL projects be subject to public review.²⁹ All public hearings and public meetings have been conducted as stipulated in the regulations,³⁰ for all programs under the Clean Water Act. Public participation was provided through one public workshop, and through the formation and participation of the Stakeholder Advisory Group. In addition, staff contact information was provided on the San Diego Water Board's website, along with periodically updated drafts of the TMDL project documents. Public participation also took place through the San Diego Water Board's Basin Plan amendment process, which included an additional public workshop, a hearing, and a formal public comment period. A chronology of public participation and major milestones is provided in Table 14-1.

Table 14-1. Public Participation Milestones

Date	Event
February 18, 2003	Notice of Public Workshop and CEQA Scoping Meeting
March 27, 2003	Public Workshop and CEQA Scoping Meeting
May 23, 2005	SAG Meeting
June 30, 2005	SAG Meeting
January 15, 2008	Draft Documents released for SAG review
February 14, 2008	SAG Meeting
February 22, 2008	Draft Documents released for public review
April 9, 2008	Public Hearing

²⁹ Code of Federal Regulations Title 40 section 130.7

³⁰ Code of Federal Regulations Title 40 section 25.5 and 25.6

14 References

- Bicknell, B.R., J.C. Imhoff, J.L. Kittle, A.S. Donigian, and R.C. Johanson. 1996. *Hydrological Simulation Program – FORTRAN (HSPF): User's Manual Release 12*. National Exposure Research Laboratory, Office of Research and Development, USEPA, Athens, Georgia.
- Brown and Caldwell. 2006a. *Report Summarizing Comments from the Port of San Diego Requesting Delisting of the San Diego Bay Shoreline, Point Loma Hydrologic Area (908.10) at Shelter Island Shoreline Park for Bacteria Indicators*. Prepared by Brown and Caldwell for Port of San Diego, San Diego, CA.
- Brown and Caldwell. 2006b. *Report in Support of SWRCB Decision to Delist San Diego Bay Shoreline, Coronado Hydrologic Area (910.10) at Tidelands Park for Bacteria Indicators*. Prepared by Brown and Caldwell for Port of San Diego, San Diego, CA.
- Chapra, S.C. 1997. *Surface Water Quality Modeling*. The McGRAW-HILL Company, INC., New York, USA.
- City of San Diego. 2004. *Mission Bay Clean Beaches Initiative Bacterial Source Identification Study*. Final Report to the State Water Resources Control Board.
- County of San Diego Department of Environmental Health. 2000. *County of San Diego—Ocean Illness Survey Results (August 1997–December 1999)*. County of San Diego Department of Environmental Health, San Diego, CA.
- Fleming, R., and H. Fraser. 2001. *The Impact of Waterfowl on Water Quality: Literature Review*. Ridgeway College, University of Guelph.
- Grant, S., B. Sanders, A. Boehm, J. Redman, J. Kim, R. Mrse, A. Chu, M. Gouldin, C. McGee, N. Gardiner, B. Jones, J. Svejksky, G. Leipzig, and A. Brown. 2002. Generation of enterococci bacteria in coastal saltwater marsh and its impact on the surf zone water quality. *Environmental Science & Technology* (November 12, 2001)35: pp. 2407-2416.
- Hamrick, J.M. 1992. *A Three-dimensional Environmental Fluid Dynamics Computer Code: Theoretical and Computational Aspects*. The College of William and Mary, Virginia Institute of Marine Science. Special report 317, 63 pp.
- Hamrick, J. M. 1996. *User's Manual for the Environmental Fluid Dynamics Computer Code*. Special Report No. 331 in Applied Marine Science and Ocean Engineering. Department of Physical Sciences, School of Marine Science, Virginia Institute of Marine Science, The College of William and Mary, Gloucester Point, VA.

Draft Technical Report
TMDLs for Indicator Bacteria
Baby Beach and Shelter Island Shoreline Park

February 22, 2008

- Los Angeles Water Board. 2002. *Total Maximum Daily Load to Reduce Bacterial Indicator Densities at Santa Monica Bay Beaches During Wet Weather*. Los Angeles Regional Water Quality Control Board, Los Angeles, CA.
- Los Angeles Water Board. 2003. *Total Maximum Daily Loads for Bacteria in the Malibu Creek Watershed*. Los Angeles Regional Water Quality Control Board, Los Angeles, CA.
- Manny, B.A., W.C. Johnson and R.G. Wetzel. 1994. Nutrient additions by waterfowl to lakes and reservoirs – predicting their effects on productivity and water quality. *Hydrobiol.* 280:121-132.
- SANGIS, 2004. San Diego Geographic Information Source. A Joint Powers Authority between City of San Diego and County of San Diego. <http://www.sangis.org/>.
- San Diego Water Board. 1994. *Water Quality Control Plan for the San Diego Basin (9)*. San Diego Regional Water Quality Control Board, San Diego, CA.
- San Diego Water Board. 1998. Letter to Interested Parties, Subject: Public Notice for Draft Clean Water Act Section 303(d) List. January 8, 1998.
- San Diego Water Board. 2001. *Waste Discharge Requirements for Discharges of Urban Runoff from the Municipal Separate Storm Sewer Systems (MS4s) Draining to the Watersheds of the County of San Diego, the Incorporated Cities of San Diego County, and the San Diego Unified Port District (NPDES No. CAS0108758)*. Order No. 2001-01. San Diego Regional Water Quality Control Board, San Diego, CA.
- San Diego Water Board. 2002a. *Waste Discharge Requirements for Discharges of Urban Runoff from the Municipal Separate Storm Sewer Systems (MS4s) Draining to the Watersheds of the County of Orange, the Incorporated Cities of Orange County, and the Orange County Flood Control District Within the San Diego Region (NPDES No. CAS0108740)*. Order No. R9-2002-01. San Diego Regional Water Quality Control Board, San Diego, CA.
- San Diego Water Board. 2007. Total Maximum Daily Loads for Indicator Bacteria, Project I- Beaches and Creeks in the San Diego Region. Draft Technical Report. San Diego Regional Water Quality Control Board, San Diego, CA.
- Space and Naval Warfare Systems (SPAWAR), 2005. Temperature and salinity data for 26 regions within San Diego Bay.
- USDA. 1986. *Urban Hydrology for Small Watersheds*. U.S. Department of Agriculture. Soil Conservation Service, Engineering Division, Technical Release 55 (TR-55).

Appendix A
Water Quality Objectives
for
Indicator Bacteria

A Water Quality Objectives for Bacteria Indicators

Under section 304(a) of the Clean Water Act, the USEPA is required to publish water quality criteria accurately reflecting the latest scientific knowledge for the protection of human health and aquatic life. Prior to 1986, the USEPA recommended bacteria criteria based on fecal coliforms to protect human health.¹ In 1986, the USEPA recommended the use of criteria based on *Escherichia coli* (*E. coli*) for fresh waters and *Enterococci* for fresh and marine waters rather than the use of criteria based on fecal coliform.² The USEPA recommended this change in the use of bacteria indicator organisms because the USEPA studies demonstrated that *E. coli* and *Enterococci* are better predictors of the presence of gastrointestinal illness-causing pathogens than fecal and total coliforms and hence provide a better means of protecting human health. Subsequent supporting research led the USEPA to reaffirm these findings in 2002.³ The USEPA strongly recommends the replacement of water quality objectives based on fecal or total coliforms with objectives based on *Enterococci* and *E. coli*.

In January 2005 the State Water Resources Control Board (State Water Board) adopted an amendment to the *Water Quality Control Plan for Ocean Waters of California* (Ocean Plan) that maintained the total and fecal coliform water quality objectives (WQOs). Additionally, the State Water Board added provisions that required additional monitoring if the single sample maximum water quality objectives are exceeded. Water quality objectives for *Enterococci* were also added to the Ocean Plan at this time.

As described below, the *Water Quality Control Plan for the San Diego Basin (9)* (Basin Plan) contains objectives based on fecal and total coliform as well as *Enterococci* and *E. coli* for inland surface waters, enclosed bays and estuaries and coastal lagoons.

A.1 REC-1 Water Quality Objectives in the San Diego Region

The contact recreation (REC-1) beneficial use water quality objectives for bacterial indicators applicable in the San Diego Region are contained in the Ocean Plan and in the San Diego Water Board's Basin Plan. The objectives contained in both are derived from water quality criteria promulgated by the USEPA in 1976 and 1986. The Ocean Plan currently contains REC-1 objectives for total and fecal coliforms and *Enterococci*. The Basin Plan currently contains REC-1 objectives for total coliform, fecal coliform, *Enterococci* and *E. coli* as shown below.

¹ Quality Criteria for Water. USEPA 1976

² Ambient Water Quality Criteria for Bacteria. USEPA 1986

³ Implementation Guidance for Ambient Water Quality Criteria for Bacteria. May 2002 DRAFT.

REC-1
Ocean Waters (from Ocean Plan)

Within a zone bounded by the shoreline and a distance of 1,000 feet from the shoreline or the 30-foot depth contour, whichever is further from the shoreline, and in areas outside this zone used for water contact sports, as determined by the Regional Board (i.e., waters designated as REC-1), but including all kelp beds, the following bacterial objectives shall be maintained throughout the water column:

30-day Geometric Mean – The following standards are based on the geometric mean of the five most recent samples from each site:

- i. **Total coliform** density shall not exceed **1,000** per 100 ml;
- ii. **Fecal coliform** density shall not exceed **200** per 100 ml; and
- iii. **Enterococcus** density shall not exceed **35** per 100 ml.

Single Sample Maximum:

- i. **Total coliform** density shall not exceed **10,000** per 100 ml;
- ii. **Fecal coliform** density shall not exceed **400** per 100 ml;
- iii. **Enterococcus** density shall not exceed **104** per 100 ml; and
- iv. **Total coliform** density shall not exceed **1,000** per 100 ml when the fecal coliform/total coliform ratio exceeds 0.1.

REC-1
Inland Surface Waters, Enclosed Bays and Estuaries and Coastal Lagoons
(from Basin Plan)

Fecal Coliform / Fresh or Marine Waters: Fecal coliform concentration, based on a minimum of not less than five samples for any **30-day period**, shall not exceed a **log mean of 200** per 100 ml, nor shall more than **10 percent** of total samples during any **30-day period** exceed **400** per 100 ml.

Total Coliform / Bays and Estuaries only: Coliform organisms shall be less than **1,000** per 100 ml (10 per ml); provided that not more than **20 percent** of the samples at any station, in any **30-day period**, may exceed **1,000** per 100 ml (10 per ml) and provided further that no **single sample** when verified by a repeat sample taken within 48 hours shall exceed **10,000** per 100 (100 per ml).

Enterococci / Fresh Waters: In fresh water, the **geometric mean** of *Enterococci* shall not exceed **33** colonies per 100 ml. The **single sample maximum** allowable density in designated beach areas is **61** colonies per 100 ml, in moderately or lightly used areas is 108 colonies per 100 ml, in infrequently used areas is 151 colonies per 100 ml.

Enterococci / Marine Waters: In marine waters, the **geometric mean** of *Enterococci* shall not exceed **35** colonies per 100 ml. The **single sample maximum** allowable density in designated beach areas is **104** colonies per 100 ml, in moderately or lightly used areas is 276 colonies per 100 ml, in infrequently used areas is 500 colonies per 100 ml.

***E. coli* / Fresh Waters:** In fresh water, the **geometric mean** of *E. coli* shall not exceed **126** colonies per 100 ml. The **single sample maximum** allowable density in designated beach areas is **235** colonies per 100 ml, in moderately or lightly used areas is 406 colonies per 100 ml, in infrequently used areas is 576 colonies per 100 ml.

A.2 REC- 2 Water Quality Objectives in the San Diego Region

The non-contact (REC-2) beneficial use water quality objectives for bacterial indicators applicable in the San Diego Region are contained in the Basin Plan and are derived from water quality criteria promulgated by the USEPA in 1976.

REC-2 **Inland Surface Waters, Enclosed Bays and Estuaries and Coastal Lagoons** **(from Basin Plan)**

Fecal Coliform / Fresh or Marine Waters: In waters designated for non-contact recreation (REC-2) and not designed for contact recreation (REC-1), the average fecal coliform concentrations for any **30-day period**, shall not exceed **2,000** per 100 ml, nor shall more than **10 percent** of total samples collected during any **30-day period** exceed **4,000** per 100 ml.

A.3 Shellfish Harvesting Water Quality Objectives in the San Diego Region

The shellfish harvesting (SHELL) beneficial use water quality objectives for bacterial indicators applicable in the San Diego Region where shellfish may be harvested for human consumption are contained in the Ocean Plan and in the Basin Plan. Both are derived from water quality criteria promulgated by the USEPA in 1976.

SHELL **Ocean Waters (from Ocean Plan)**

At all areas where shellfish may be harvested for human consumption, as determined by the Regional Board, the following bacteria objectives shall be maintained throughout the water column:

The median **total coliform** density shall not exceed **70** per 100 ml, and not more than **10 percent** of the samples shall exceed **230** per 100 ml.

SHELL **Enclosed Bays and Estuaries and Coastal Lagoons (from Basin Plan)**

Total Coliform / Marine Waters: The median total coliform concentration throughout the water column for an **30-day period** shall not exceed **70** per 100 ml nor shall more than **10 percent** of the samples collected during any **30-day period** exceed **230** per 100 ml for a five-tube decimal dilution test or 330 per 100 ml when a three-tube decimal dilution test is used.

Appendix B
Peer Review Comments
And Responses

B Peer Review Comments and Responses

The technical portions of the proposed Basin Plan amendment to incorporate TMDLs for indicator bacteria were peer reviewed by Professor Patricia Holden of the Donald Bren School of Environmental Science & Management, University of California, Santa Barbara, and by Professor Michael Barber of the Washington State Water Research Center, Department of Civil and Environmental Engineering, Washington State University. External scientific peer review of the technical portion of a proposed rule (in this case, the proposed Basin Plan amendment) is mandated by Health and Safety Code section 57004. This statute states that the reviewer's responsibility is to determine whether the scientific portion of the proposed rule is based upon sound scientific knowledge, methods, and practices. The San Diego Water Board provided the peer reviewers with the draft Technical Report, the draft Basin Plan amendment, and a list of key issues with discussion for the peer reviewers to address. The list of key issues with discussion provided to the peer reviewers is given below in the first section of this appendix. The peer reviewers' comments and the San Diego Water Board's responses follow in subsequent sections.

Issues for Peer Review

1. Use of land use composition to quantify bacteria sources from all watersheds to affected beaches and creeks in the San Diego Region.

Bacteria are ubiquitous in the environment, as there are numerous sources including both controllable and non-controllable. Controllable sources include sewage related sources (spills, leaking sewer lines), trash, farm animal waste, and pet waste. Non-controllable sources include aquatic and terrestrial wildlife, decaying matter, and soil. To manage this abundance of sources and quantify them in a useful way, land-use types were identified in the San Diego Region and quantified in terms of bacteria generation.

Various bacteria sources are present across different land-use categories. For example, wildlife can be present in both urbanized and non-urbanized areas. Despite this source variability, loading can be highly correlated with land use practices. For this reason, it was decided to quantify the bacteria load coming from each land use type rather than quantify the sources directly. This approach was applied to both wet weather and dry weather conditions.

2. Use of wet weather model to simulate fate and transport of bacteria, and to calculate TMDLs.

The wet-weather approach chosen for use in this project is based on the application of USEPA's Loading Simulation Program in C++ (LSPC) to estimate bacteria loading in the watersheds. LSPC is a recoded C++ version of USEPA's Hydrological Simulation Program–FORTRAN (HSPF) that relies on fundamental (and USEPA-endorsed) algorithms. LSPC has been applied and calibrated in multiple

watersheds in the San Diego Region in the *Draft Bacteria TMDLs for Beaches and Inland Surface Waters of the San Diego Region*, hereafter referred to as Draft Bacteria TMDL Project I (SDRWQCB, 2005). The regionally calibrated modeling parameters from Draft Bacteria TMDLs Project I were transferred to the watersheds of the San Diego Bay (SDB) and Dana Point Harbor (DPH) impaired shorelines. For a complete discussion of LSPC configuration, validation, and application, refer to Appendix G.

Receiving water models of SDB and DPH were developed to simulate the assimilative capacity of the waterbodies, quasi-steady-state effects of tidal flushing, and bacterial die-off. These models were based on the Environmental Fluid Dynamics Code (EFDC) (Hamrick, 1992 and 1996). Wet-weather flows and bacteria levels from the watersheds were based on LSPC output for the respective impaired shorelines modeled, and were therefore used as boundary conditions to the EFDC models. The EFDC models additionally provided quasi-steady-state simulation of flushing and intrusion of waters high in salinity resulting from tidal hydrodynamics. The models also included assumptions for influence of salinity and temperature on bacteria die-off formulations. A complete discussion of EFDC model development of SDB and DPH is provided in Appendix G.

Please comment on the use of this modeling system for the purpose of calculating TMDLs to impaired waters during wet weather.

3. Use of single-sample maximum objectives for wet weather numeric targets.

Bacteria water quality objectives have two temporal components: single sample maximum values and 30-day geometric mean values. As a conservative measure for wet weather analyses, the single sample maximum values were chosen as TMDL numeric targets.

Wet weather events, and subsequent high bacterial counts, are sporadic and episodic. Wet weather runoff and flows contain elevated bacteria densities, but have a quick time of travel. Thus, bacteria densities remain elevated for relatively short time periods following storm flows. Storm events do not typically result in an exceedance of the 30-day geometric mean bacteria densities, even though single sample densities are very high. Therefore, the single sample maximum values were used as numeric targets for the wet weather simulations.

4. Reasonableness of assumptions (described in Appendix L) for wet-weather modeling.

Several assumptions are relevant to the modeling system used to simulate the fate and transport of wet weather sources of bacteria. This model was used to estimate both existing bacteria loads and total maximum daily loads. Please comment on the validity of these assumptions. Assumptions for wet weather modeling can be found in Appendix L.

5. Use of wet weather modeling parameters to simulate build-up/wash-off of bacteria from similar studies in San Diego and Los Angeles (SDRWQCB, 2005 and LARWQCB, 2002).

Sources of bacteria are quantified by correlating land use types to bacteria loading. Land use data was classified into 13 distinct categories. Each category had a unique parameter describing the amount of bacteria loading directly to the *critical point* (defined as the culmination point at the bottom of each affected watershed). These unique parameters were obtained by using those that were previously defined in the TMDL for Santa Monica Bay (LARWQCB, 2002), and used in Draft Bacteria TMDLs Project I. The parameters include land-use-specific accumulation rates and build-up limits. Using these values assumes that land use characteristics for all categories in the San Diego Region are sufficiently similar to characteristics of all land use categories in the Los Angeles Region. This assumption was validated in Draft Bacteria TMDLs Project I through evaluation of model results with local water quality data. Please comment on the application of modeling parameters derived in the Los Angeles Region and validated in Draft Bacteria TMDLs Project I to this project.

6. Use of dry weather and receiving water model to simulate fate and transport of bacteria, and to calculate TMDLs.

The density of bacteria during dry weather is extremely variable in nature. Therefore, to better identify and characterize sources an approach was used that relied on detailed analysis of available data based on statistical relationships between flow, bacteria concentrations, and area of each land use. An approach similar to that used for Draft Bacteria TMDLs Project I was also used to model dry weather watershed sources for the impaired shorelines of SDB and DPH. Also, since dry weather flow data was not available for any of the bay and harbor segments, flow parameters were utilized from the regionally calibrated dry weather model for Draft Bacteria TMDLs Project I.

To represent the linkage between source contributions and receiving waters, steady-state mass balance models were developed to simulate transport of bacteria in the streams and storm drains flowing to impaired SDB and DPH shorelines. These predictive models represent the streams/storm drains as a series of plug-flow reactors, with each reactor having a constant, steady-state flow and bacteria load. Bacteria concentrations in each segment were simulated based on regionally calibrated values for a first-order die-off rate and stream infiltration.

Receiving water models of SDB and DPH were consistent with EFDC models developed for wet-weather analyses, and included linkage to the dry-weather watershed transport model described above. These models simulated the assimilative capacity of the waterbodies, quasi-steady-state effects of tidal flushing,

salinity, and temperature, and effects on bacterial die-off. A complete discussion of the modeling approach for dry weather is provided in Appendix G.

7. Use of data from Aliso, San Juan, Rose, and Tecolote Creeks to characterize dry weather source loading in the entire San Diego Region.

Dry weather flow data was not available for any of the bay and harbor segments. Flow parameters were utilized from the regionally calibrated dry weather model for Draft Bacteria TMDLs Project I. In this approach, data from Aliso Creek, San Juan Creek (Orange County), Rose Creek, and Tecolote Creek (San Diego County) were used for characterization of dry weather flows and water quality because the data sets associated with these creeks are considered sufficient in size. Data from these four creeks were used to generate regression equations describing flow and water quality as functions of land use composition and watershed size. Conditions in these four creeks are assumed representative of conditions throughout the Region. A complete discussion of the approach for dry weather is provided in Appendix G.

8. Use of geometric mean objectives for dry weather numeric targets.

Bacteria water quality objectives have two temporal components: single sample maximum values and 30-day geometric mean values. For dry weather analyses, the geometric mean values were chosen as TMDL numeric targets. This is because the dry weather model simulates steady state flow for predictions of average conditions in the creeks. To compare the conditions of these average flows to water quality objectives, the geometric mean is more appropriate since this value likewise represents average conditions over 30 days.

9. Reasonableness of assumptions (described in Appendix L) for dry weather modeling.

Several assumptions are relevant to the modeling system used to simulate the fate and transport of bacteria during dry weather in the Region. Please comment on the validity of these assumptions. Additional assumptions for dry weather modeling can be found in Appendix L.

10. Assumptions used for modeling the impaired shorelines of SDB (B Street and G Street Pier) that had no data for model verification or loading assessment.

Sufficient bacteria data were available for three impaired shorelines in this study, including Tidelands Park and Shelter Island Shoreline Park of SDB and Baby Beach of DPH. These data were used for model testing and analyses of loading conditions to the receiving waters. These analyses provided information for assumptions for modeling the other impaired shorelines of SDB (B Street and G Street Pier) that had no data for model verification or loading assessment.

11. Location of *critical points* for TMDL calculation.

The *critical point* for loading assessment is defined as the culmination point at the bottom of the watershed, before inter-tidal mixing takes place. Both current loading and total maximum daily loading is calculated at the critical point for each watershed having an impaired waterbody. High bacteria loading is predicted at the critical point, and is therefore considered a conservative location for TMDL calculation. TMDL calculations were determined at the critical point in dry weather.

12. Use of conservative assumptions to comprise an implicit Margin of Safety.

Rather than incorporating an explicit margin of safety (MOS) to TMDL calculation, the conservative assumptions built into both the wet weather, dry weather and receiving water models are considered sufficient to account for any uncertainties. The implicit MOS was thus generated by incorporating a series of conservative assumptions regarding current source loading of bacteria from the watersheds, as well as assumptions regarding the assimilation of bacteria into the waterbodies and surrounding environment.

13. Calculations of wasteload allocations, load allocations and TMDLs during dry weather and wet weather.

Data and model limitations required that assumptions be made to calculate the dry weather wasteload allocations. The models were incapable of predicting the variability in measured receiving water bacteria concentrations, most likely because of the extreme daily variability in bacteria loading from birds and other localized sources. Additionally, there were no data or literature values to accurately estimate the loading to the shorelines from sources external to the MS4s including bird sources, marine mammals, and boat discharges. However, modeling showed that, because of the small size of the watersheds draining to the impaired shorelines, the MS4s are incapable of contributing a significant portion of the bacteria loads to the receiving water based on measured water quality. Thus, the loads contributed by the MS4s during dry weather are likely orders of magnitude lower than those contributed from bird loading, the principal external source.

Because loads from external sources could not be calculated directly due to lack of data and lack appropriate literature values, the dry weather wasteload allocations were calculated by assuming that the MS4 discharges to the receiving water met the 30-day geometric mean numeric targets. The load allocations were then calculated by subtracting the wasteload allocations from the assimilative capacity of the shoreline areas. The dry weather load allocations were assumed to be the same for the wet-weather condition, and the wet weather wasteload allocations were calculated by subtracting the load allocations from the assimilative capacity of the receiving water.

The assumptions used to calculate the dry weather wasteload allocations, and dry and wet weather load allocations are broad considering that bird loading and other localized sources can result in high temporal variability that may at times result in exceedance of the assimilative capacity of the waterbody. However, the assumptions are reasonable considering the fact that the calculated dry weather wasteload allocations are orders of magnitude lower than the calculated external loads as expected based on size of the watersheds and measured receiving water quality.

Overarching Questions

Reviewers were not limited to addressing only the specific issues presented above, and were asked to contemplate the following “big picture” questions.

- (a) In reading the staff technical reports and proposed implementation language, are there any additional scientific issues that are part of the scientific basis of the proposed rule (the Basin Plan amendment) not described above? If so, please comment with respect to the statute language given above.
- (b) Taken as a whole, is the scientific portion of the proposed rule based upon sound scientific knowledge, methods, and practices?

Reviewers were asked to note that some proposed actions may rely significantly on professional judgment where available scientific data are not as extensive as desired to support the statute requirement for absolute scientific rigor. In these situations, the proposed course of action is favored over no action.

Comments from Professor Holden

1. Use of land use composition to quantify bacteria sources from all watersheds to affected beaches and creeks in the San Diego region.

Comment: Land use composition was used to “estimate” not to “quantify” fecal indicator bacteria. Nonetheless, it appears that there is no other logical and immediate way to approach this. However, the regression equation in Appendix G is based on Los Angeles data. It would be useful to clarify for the reader how closely the land uses are in the Los Angeles dataset to the ones in the San Diego TMDL region. If the land use percentages are similar between the sites studied and the ones modeled, then this approach (across jurisdictions or regions) is additionally justified or should be qualified.

A continuing concern in this TMDL report is the very small degree to which watersheds are predicted to contribute to the wasteload. Since most of the wasteload cannot be attributed to the watersheds, then either the land use composition data or the LA watersheds as sources for regressions are unrealistic for this setting or in fact the birds (or other unidentified sources) are really the majority source. There is a great deal of uncertainty, in other words.

Response: The regression equations 5 and 6, reported in Appendix G (now revised to Appendix F), were based on data collected from San Juan Creek and Aliso Creek of Orange County, and Tecolote Creek and Rose Creek of San Diego. Given these watersheds proximity to the Dana Point Harbor (Orange County) and San Diego Bay (San Diego County) watersheds, their use in basing land use assumptions was considered justified.

The reason that watershed loading constituted a small portion of the total load to the receiving waters was not associated with land use, but rather due to the relatively small size of the watersheds and the likely contribution of localized sources such as waterbowl and other local sources within the receiving waters. Watershed loads of bacteria associated with dry urban runoff, estimated based on the regression equations, were very small compared to direct, localized loads to receiving waters (e.g., birds). Direct loads from birds and other sources within the receiving waters were not included in watershed load estimates and their regression equations. For this reason, we do not believe there is a great deal of uncertainty with land use composition based on the reviewer's comment.

2. Use of wet weather model to simulate fate and transport of bacteria, and to calculate TMDLs.

Comment: The use of a mathematical model is good and appropriate. The model concept, as described in Appendix G, would appear to have appropriate elements (reactor assumption, first order decay coefficients, mixing equation) and the calibration to existing data sets appears successful. This reviewer may have overlooked it, but it would be useful to have some explanation in Appendix G regarding the origin of the "observed range" data in Figures starting with G-7. Over what time frame are ranges depicted?

In Section G.3.2.d, the die-off rates are much higher than stated for the watershed model (ca. 0.6/day for the former versus ca. 0.15 / day for the latter). Assuming this is because of salinity, it would be good to be more explicit about how the salinity adjustment recommended by Chapra (1997) was used.

I agree with the last statement of Appendix G regarding the utility of the model. It strikes me that if this is done well, its continued use and refinement can be used to hone in on "lumped" sources that drive the need for inverse simulation approaches.

In Appendix H, it is rather difficult to assess the goodness of fit of the model to the data, beginning with Figure H-57. Is there a way to represent the fit better in a graphical sense? Could the data be plotted against the simulated values and an R-squared value shown? The simulated 30 day geometric means for Dana Point Harbor (H-63 and H-64) are rather good fits, on the other hand, and are more easily depicted graphically.

Response: The observed ranges shown in Figures G-7 through G-14 of Appendix G (now revised to Figures F-7 through F-14 of Appendix F), specific to dry weather model calibration and validation results, are based on observed flows and bacterial densities corresponding to the monitoring performed for Aliso Creek, San Juan Creek, Tecolote Creek, and Rose Creek. Appendix G (now revised to Appendix F) was updated to provide an improved discussion of data associated with model calibrations and validations, as shown in these Figures.

The commentor is correct that higher die-off rates in the EFDC receiving water model are due to the influence of salt water, compared to lower die-off rates in the freshwater watershed models. It should be noted that all die-off rates in the EFDC model were changed to 0.8/day consistent with a typical value reported in Chapra (1997). Based on salinity concentrations predicted by the model, adjustments to bacteria die-off are automatically performed assuming a relationship of ratio of $0.02\text{day}^{-1}\text{ppt}^{-1}$ salinity, as reported in Section G.3.2.d (now revised to Section F.3.2.4).

The challenge with presentation of model results and observed data is the extremely high variability of bacteria data. Since bacteria concentrations vary by orders of magnitude, and the objective of the modeling was to follow the general trend and estimate the order of magnitude present in the observed data, the graphical results provided in Figure H-57 (now revised to Figure K-57) are sufficient for the purpose of presenting agreement between orders of magnitude. Comparison of 30-day geometric means is easier to depict graphically due to the reduced impact of highly variable instantaneous concentrations.

3. Use of single-sample maximum objectives for wet weather numeric targets.

Comment: The single sample basis is appropriately conservative. However, what is going to be a problem is the fact that TC targets have been set lower than FC (Table 3.1). FC are a subset of TC; TC are typically around 10 times higher than FC and thus it is unlikely that the two targets can be met (TC will always be out of compliance even if FC is met). In fact, Equation 7 in Appendix G gives the formula of $\text{TC} = 5\text{X FC}$.

Response: Equation 7 in Appendix G is based on a regression analysis of the correlation between total coliform (TC) and fecal coliform (FC) derived from observed data. However, this observed correlation is not relevant to the method by which the targets for TC and FC are selected.

The San Diego Water Board recognizes that the numeric targets used in the Technical Report present what seems to be an error in logic: This apparent problem arises because the total coliform numeric objective for the SHELL use is lower than the fecal coliform objective for the REC-1 use. Fecal coliform is a subset of total coliform, yet numeric targets for total coliform are less than numeric targets for fecal coliform. There are no WQOs for fecal coliform for SHELL. Because the WQOs associated

with SHELL are more stringent than the WQOs for REC-1, this results in final numeric targets showing a discrepancy between values for total coliform and fecal coliform.

The result of this discrepancy is that, although the numeric target of 400 MPN/mL is reported for fecal coliform, in practice a lower numeric fecal coliform density will have to be met in order to meet the total coliform target of 230 MPN/mL. This apparent discrepancy is understood when beneficial uses are taken into account.

However, the TMDLs based on the WQOs for SHELL have been removed from this project and technical report and will be addressed in a separate TMDL or water quality standards action. Thus, this comment is no longer relevant.

4. Reasonableness of assumptions (described in Appendix L) for wet-weather modeling.

Comment: As stated below, not all of the parameters could be reviewed in detail, but the assumptions in general and their sources appear to be sound.

Response: The San Diego Water Board agrees that the assumptions and their sources are generally sound.

5. Use of wet weather modeling parameters to simulate build-up/wash-off of bacteria from similar studies in San Diego and Los Angeles (SDRWQCB, 2005 and LARWQCB, 2002).

Comment: It was not possible to review all the modeling parameters as these are found in numerous other studies (as stated in Appendix L) but the sources of the parameters are logical and appear to be sound. The conceptual framework, as described, appears sound for the model. It becomes clear later in Appendix L which die-off rate constants were applied when / where, and it would be useful to ensure that the same clarity is in Appendix G.

Response: Comment noted. Assumptions stated in Appendix L (now revised to Appendix G) are consistent with discussions in Appendix G (now revised to Appendix F).

6. Use of dry weather and receiving water model to simulate fate and transport of bacteria, and to calculate TMDLs.

Comment: A dry weather model is a reasonable idea, and the comments regarding simulation success in my “wet weather” comments apply here. Especially important to recognize in this report is that it appears that the majority sources have been backed out of the models. This is a major concern. If watershed sources don’t account for

much at the shore and birds are suspected as the major source, then either data should be available to back this up or data should be gathered to confirm. Further, birds should be considered as a public health concern.

Response: The dry weather model indicated that a significant amount of the observed bacteria levels in the receiving waters could not be attributed to loads originating from the watershed. Observed bacteria levels in the receiving waters exhibited significant variation temporally as well as spatially. The receiving water (EFDC) models were not able to simulate the observed data in any statistically meaningful way.

Because of the variability and unpredictability of modeled bacteria levels in the receiving water compared to observed data, and lack of data about natural (primarily waterfowl) sources, the dry weather receiving water (EFDC) model was used to back-calculate the maximum allowable bacteria load that could be attributed to natural sources. The allowable load calculated from the watershed (LSPC) model was assumed to originate from controllable point sources, namely the municipal separate storm sewer systems (MS4s).

The back-calculated maximum potential bacteria load attributed to natural sources is not the actual load from natural (waterfowl or other) sources within the receiving waterbody. Instead, it is the maximum allowable bacteria load that can be received from the natural uncontrollable sources and still allow the receiving waterbody to assimilate the bacteria load from the watershed sources (from the LSPC watershed model) without exceeding the numeric targets. So, while the TMDLs may include a relatively large contribution from natural sources, the TMDL is still protective of water quality standards. The point sources (MS4s) from the watersheds, which have a relatively low contribution to the receiving waters, are the only sources that are considered controllable.

The San Diego Water Board recognizes that additional data for the natural sources as well as watershed sources would help to further refine the LAs for nonpoint sources and wasteload allocations (WLAs) for point sources. The San Diego Water Board further agrees that as additional data are collected to further characterize the bacteria loads that can be attributed to natural sources, methods for bacteria load estimation and calculation of TMDLs should be refined in the future. However, until those data are available, the approach taken is believed to be the most conservative and protective approach for calculating the TMDLs.

7. Use of data from Aliso, San Juan, Rose, and Tecolote Creeks to characterize dry weather source loading in the entire San Diego Region.

Comment: It was good that these data were available, and that the SDRWQCB had the insight to use this available data. But as stated above, it is important in this document to explicitly show the similarities or differences between land uses in the LA

watersheds versus the subject San Diego watersheds. If they are very different, then one would think about the value of this exercise in a more critical way. It would also be appropriate for San Diego to start monitoring in its own region. This should begin now, in order to effectively monitor the effectiveness of the TMDL development effort over the long term.

Response: Because the four creeks mentioned in this item are located in the San Diego Region, it is believed that the commenter misunderstood the intent of the item. Data from Aliso Creek, San Juan Creek (Orange County), Rose Creek, and Tecolote Creek (San Diego County) were used for characterization of dry weather flows and water quality because the data sets associated with these creeks are considered sufficient in size. Data from these four creeks were used to generate regression equations describing flow and water quality as functions of land use composition and watershed size. Conditions in these four creeks are assumed representative of conditions throughout the Region. The item was meant to solicit opinion about the application of regression equations developed by these four creeks onto the remaining watersheds.

Comment cont'd: One small comment for G.2.4.b regards the units for the die-off coefficients. The “per day” units are correct and “liters” should not be in the units.

Response: See the response to the comment for item 1. Section G.2.4.b (now revised to Section F.2.4.2) was corrected regarding units of die-off rates.

8. Use of geometric mean objectives for dry weather numeric targets.

Comment: Because bathers are more frequently at the beach during dry weather, it seems that more stringent targets should be set for the dry weather periods. Sustained loading of fecal indicator bacteria to coastal sediments could occur in the summer following wintertime upland erosional processes and deposition of contaminated sediments to coastal zones. Thus, nearshore sediments deposited from winter processes could have a sustained, and perhaps tidally-influenced, effect on coastal water quality. The geometric mean sets a value for the target which could fluctuate around the mean due to tidal cycling. This is suggested in section 3 (page 11, 2nd paragraph) of the draft Technical Report. Given that tidal cycling is natural and incoming flows will be lower, the geometric mean basis for targets is reasonable, but it should also be considered that swimming is occurring mostly during the summer and this is thus when maximum protection of public health is needed. If the latter is taken seriously, then one time numeric targets should be set. This would also protect the health of swimmers when an accident occurs such as a sewer line break, pump failure, etc. Thus, it is good that both one time and geometric mean targets are set (Table 3.2).

Response: The San Diego Water Board agrees that the use of both single sample maximum and geometric mean targets are appropriate for dry weather targets due to

significant fluctuation in bacteria levels that can occur during the tidal cycling in the receiving waterbodies.

Comment, cont'd: As with the wet weather targets (see 4 above), setting the TC target as less than FC is nearly impossible to meet (Table 3.2) because TC is a larger group (by about 10 fold) than FC. Thus, which would be used as the real target: FC or TC?

Response: For the issue about TC and FC targets, please see the response above to the comment for item 3 for the reasons the TC targets are less than the FC targets. However, the TMDLs based on the WQOs for SHELL have been removed from this project and technical report and will be addressed in a separate TMDL or water quality standards action. Thus, this comment is no longer relevant.

Comment cont'd: Lastly, it would be useful in the report to be explicit about why *E. coli* is not included in either Table 3.1 or 3.2. It is clear from Appendix C that there is no WQO for *E. coli* in marine waters, and that FC WQOs do exist. But a statement in Section 3 to that effect would be helpful.

Response: Section 3 has been revised to provide additional explanation for not including *E. coli* targets in Tables 3-1 and 3-2, as in Appendix C (now revised to Appendix A).

9. Reasonableness of assumptions (described in Appendix L) for dry weather modeling.

Comment: The assumptions and sources for assumptions (where not all information is readily available to review) appear reasonable and sound. However, the lack of data regarding the real contributions of birds to the coastal loading of fecal indicator bacteria is problematic.

Response: As discussed in the response to the comment for item 6, the San Diego Water Board agrees additional data would be helpful to further characterize the bacteria loads that can be attributed to natural sources. However, until those data are available, the approach taken in the Technical Report is the most conservative approach for calculating the TMDLs and protecting the designated beneficial uses of the waterbodies.

10. Assumptions used for modeling the impaired shorelines of SDB (B Street and G Street Pier) that had no data for model verification or loading assessment.

Comment: Using data available from other nearby sites appears reasonable under these circumstances.

Response: The San Diego Water Board agrees that the use of data available from other nearby sites is reasonable under these circumstances. Water quality data collected in the future from these shorelines can be used to revisit and refine the LAs, WLAs, and TMDLs, if necessary.

However, the shoreline segments of B Street and G Street have been removed from this project. Thus, this comment is no longer relevant.

11. Location of *critical points* for TMDL calculation.

Comment: It appears that all shorelines are critical points. If they are all frequented to the same degree, then this makes sense. If they are not, then weighting them by visitation frequency of recreational water users makes more sense. The land uses at the different sites imply a possible difference in this regard across sites.

Response: The critical points were selected as the most conservative locations, where the bacteria densities predicted by the receiving water (EFDC) model would be highest. Numeric targets for TMDL calculation are based on the appropriate WQOs. Although the ENT WQOs for REC-1 beneficial use may be different based on swimmer usage, the San Diego Water Board uses the most stringent objective for calculating TMDLs in order to be conservative in protecting public health.

12. Use of conservative assumptions to comprise an implicit Margin of Safety.

Comment: This is fine. Otherwise, an MOS is arbitrary.

The only large issue, and it is not clear where to make it in this list of 12 review issues, is the bird contribution. The documents state that there are no good census data for birds, yet the vast majority of fecal indicator bacteria projected in this study are from birds. The lack of data for the majority projection contributes to a serious amount of uncertainty in this effort. Because the model is constrained by the land use relationships and bacterial die off rates, the majority waste load is predicted to be from a wholly unquantified source: the birds. This is most problematic and leads to a great deal of uncertainty.

Response: The San Diego Water Board agrees there is uncertainty regarding the quantification of bacteria from natural (waterfowl) sources. However, as discussed in the response to the comment for item 6, the TMDL that is calculated includes the maximum allowable bacteria load that can be received from the uncontrollable natural sources and still allow to receiving waterbody to assimilate the bacteria load from the watershed sources without exceeding the numeric targets. Therefore, the TMDL is protective of beneficial uses, even if the bacteria loads attributed to natural (waterfowl) sources are a significant portion of the TMDL. Until a study is performed to quantify the loads from natural sources, the San Diego Water Board believes that the approach

taken in the Technical Report is the most conservative approach for calculating the TMDLs and protecting the designated beneficial uses of the waterbodies.

13. Calculations of wasteload allocations, load allocations and TMDLs during dry and wet weather.

Comment: Ironically, the majority of the fecal bacteria loaded to these sites are predicted (by default) to be from waterfowl. The miniscule amounts to be removed from the watershed will likely do little to protect public health. Why are there no efforts in this TMDL to address the birds as sources? Shouldn't data be collected to determine if birds are indeed the major sources? If this is a major source of fecal bacteria to the coastal ocean beaches, then we should be concerned: we already know well as a society that at least viruses can be transmitted from birds to humans. Can the birds as a source of fecal bacteria really be ignored from a TMDL as such?

Response: The San Diego Water Board disagrees that removing the loads from the watersheds will do little to protect public health, because watershed sources such as leaking sewer lines or feces from domestic animals can contain harmful pathogens. However, we agree that loading from waterfowl is a major source of uncertainty when calculating TMDLs.

As discussed in the responses to the comments for items 6, 9 and 12, the calculated TMDLs are protective of the designated beneficial uses, thus public health, even if the bacteria loads attributed and allocated to natural (waterfowl) nonpoint sources are a significant portion of the TMDL. The fact that there is no data available to quantify the load from natural (waterfowl) sources only emphasizes the need for collecting additional data. The calculated TMDLs do not ignore birds as a source of fecal bacteria. Instead, the TMDLs indicate that natural sources are a significant part of the bacteria loading. At this time, the calculated TMDLs assume that natural sources are uncontrollable and are a significant source of bacteria. However, the San Diego Water Board believes that future studies and data collection may help to determine if identified natural sources can indeed be controlled.

Overarching Questions:

(a) In reading the staff technical reports and proposed implementation language, are there any additional scientific issues that are part of the scientific basis of the proposed rule not described above? If so, please comment with respect to the statute language given above.

Comment: A main issue is the continuing focus on fecal indicator bacteria and the uncertainty of the relationship to human health in these mostly non-point source scenarios. The development of TMDLs and the implementation of them against a backdrop of great uncertainty regarding their effectiveness to protect human health

represents an unwise expenditure of public funds. At the very least, additional scientific understanding needs to be gained regarding the real presence of pathogens, the real incidences of human illness, the real risk to human health, and the probability of animal-to-human disease transmission (particularly in the regions heavily visited by shore birds).

Response: As discussed above, the TMDLs that were developed in the Technical Report are protective of the designated beneficial uses, thus public health, even if the bacteria loads attributed and allocated to natural (waterfowl) nonpoint sources are a significant portion of the TMDL. The water quality standards, which are based on beneficial uses and WQOs, provide the backdrop against which the TMDLs must be developed. The San Diego Water Board recognizes that there is uncertainty in the development of these TMDLs, and agrees that additional information and data are needed to fully evaluate the real risk to human health. However, given the lack of available data, the development of these TMDLs serve as a conservative starting point for restoring and protecting the impaired waterbodies. As additional studies are performed and data collected, additional refinement of these TMDLs and allocations may be conducted.

(b) Taken as a whole, is the scientific portion of the proposed rule based upon sound scientific knowledge, methods, and practices?

Comment: The technical choices of models and model parameters appear to be sound, and their implementation appears to be sound except for the fact that the majority load is from an unquantified source. Also, as stated above, the current scientific opinion in water quality monitoring is that fecal indicator bacterial concentrations do not adequately capture evidence of pollution relatable to human health in a non-point setting. Without truly knowing the sources and also real presence of pathogens, these TMDL efforts to account for fecal indicator bacteria and to simulate their transport and routing from one place to another does little to really inform water quality managers of the true magnitude of the problem and thus real threat to public health. If the main goal is to serve compliance needs, then TMDL development around fecal indicator bacteria is fine but the actual magnitude of sources needs to be established.

Response: The San Diego Water Board is familiar with the issues raised by the reviewer. However, as the reviewer has commented below, the “number of possible pathogens is too great to make it either practical and perhaps even feasible to monitor them directly.” Therefore, bacteria are measured as surrogates for pathogens. Also, given the variability and unpredictability of bacteria levels observed both spatially and temporally in the receiving waters evaluated, a source study would be prohibitively expensive (likely in the millions of dollars) as it would require a significant amount of sampling of over time and in several location for each shoreline segment to establish the potential sources of bacteria. The San Diego Water Board would encourage such studies to be undertaken by the dischargers and other interested parties.

Comment (cont'd): Also, again, as stated above, if birds are related to natural background sources, then a potential threat to human health is being ignored and at least unquantified. Bird fecal material at beaches, especially where it is suspected that this material contributes to the majority of waste load to a beach, really should be addressed.

Response: As discussed above, even though the bacteria loads attributed to natural (waterfowl) sources are a significant portion of the TMDL, the TMDLs that were developed are protective of beneficial uses, as well as public health, because they are based on the WQOs from the Basin Plan. The San Diego Water Board believes that the approach taken in the Technical Report is the most conservative approach for calculating the TMDLs and protecting the designated beneficial uses of the waterbodies evaluated.

Other Specific Comments

Comment:

The language used in this arena of “pathogen TMDLs” is very important to consider. Pathogen TMDLs are rather new and California is newly creating them; many will be templates for elsewhere in the U.S. The concept of indicators and what they can and cannot tell us is confusing, but if we as a society are to improve the indicator system, we must be mindful of describing it accurately so that the public can embrace and understand the need for improvements.

That said, some specific comments regard the use of language from a scientific accuracy standpoint. They include:

1. Executive Summary: “Bacteria have been historically used as indicators of human pathogens because bacteria are easier and less costly to measure than the pathogens themselves”. The word “fecal” should precede “bacteria” in both occurrences in this sentence. Also, “easier” and “less costly” are equivalent because “time is money”. However, the real reasons for using fecal bacteria as indicators are that: 1) there is historical evidence linking swimmer illness to fecal indicator bacteria, 2) it has been impractical, if not impossible, to monitor all pathogens directly, and 3) indicators, if they are good tracers for pathogens, negate the need for the latter.

Response: The Executive Summary has been revised.

2. Introduction (1st paragraph): Similar comment as above. Additionally, the second paragraph should convey that the number of possible pathogens is too great to make it either practical and perhaps even feasible to monitor them directly. Further, if only a subset of pathogens are monitored, water quality managers risk not detecting others for which they are not assaying. The last two sentences of this paragraph are good.

Response: The Introduction has been revised.

3. Problem Statement (page 4, next to last and last paragraphs): “Fecal indicator” should precede “bacteria” in this statement. There are approximately 10^8 bacteria per gram of surface soil nearly everywhere in the world. Thus, “bacteria” is too general of a work to use in this sentence without the suggested qualifiers. Similarly, in the last paragraph on this page, “fecal” should be added before “bacteria” in every occurrence of the latter.

Response: The suggested revisions were incorporated into the Technical Report.

4. Section 2.1, 1st paragraph: Whether or not the bays’s assimilative capacity is indeed “increased” (above what?) due to tidal flushing depends entirely on the amount of mixing and flushing that occurs. With Proposition 40 support, the County of Orange will be testing the use of Oloids off Baby Beach to improve circulation. Given the investment as such, the assimilative capacity must be short of optimal.

Response: The San Diego Water Board agrees that these waterbodies are relatively enclosed bays and flushing may be limited. However, tidal flushing does occur. The mixing and flushing that occurs is greater than if the bays were completely closed. Hence, the assimilative capacity is increased compared to a totally closed waterbody, such as a lake, without the benefit of any tidal flushing whatsoever.

Comments from Professor Barber

1. Use of land use composition to quantify bacteria sources from all watersheds to affected beaches and creeks in the San Diego Region.

Comment: This appears to be a potential source of uncertainty in the TMDL values. While the lack of data forces this approach, attempts to correlate land use to fecal coliform and enterococci generally result in correlations coefficients (R^2) between 0.6 and 0.8. Some studies have shown little to no correlation between coliform and enterococci. This is an acceptable first step but more data is needed.

Response: The San Diego Water Board concurs that more data is needed to refine analysis. The approach was designed in such a way that modifications or further verification can be easily performed as new data become available. It is our hope that the technique will be further refined as new data are collected.

2. Use of wet weather model to simulate fate and transport of bacteria, and to calculate TMDLs.

Comment: LSPC (and its predecessor HSPF) have been used extensively throughout the country to reasonably predict flows and pollutant concentrations for TMDL analysis. It is unclear if the model is capable of handling likely bacteria sources from recreational boats and marinas if those are a potential source in these areas.

Although somewhat less used, EFDC is being touted by EPA as an important tool in their TMDL Toolbox. There is no reason to believe that it would not work in this setting subject to the limitations of any model developed with limited data. Appendix G contains sufficient information on the input parameters used. According to the results shown in Appendix H, the model seems to over estimate temperature during warm (presumably dry) periods. Any impact this may have on fecal coliform die-off or regrowth should be noted.

Response: We concur that LSPC is incapable of simulating bacteria sources from recreational boats and marinas. However, this model was only applied to the watershed for estimation of bacteria loads from stormwater runoff. Since bacteria loads from recreational boats and marinas are within receiving waters, the EFDC model was used to determine loads associated with these source. Additional detail regarding these modeling assumptions are discussed in Section 7.2.2 and Appendix G (now revised to Appendix F).

For some periods, the EFDC model over-predicted temperature during summer months by 3° C or less. As discussed in Section G.3.2.d of Appendix G (now revised to Section F.3.2.4 of Appendix F), bacteria die-off rates included a slight dependency on temperature, with a factor of $1.01 \text{ day}^{-1} \text{ }^{\circ}\text{C}^{-1}$ multiplied by the die-off rate. This can potentially result in a 0.03 day^{-1} increase in the die-off rate. It should be noted that all die-off rates in the EFDC model were changed (per peer review comments) to 0.8/day consistent with a typical value reported in Chapra (1997). Compared to this base assumption for die-off, the 0.03 day^{-1} discrepancy will have a minor impact on model predictions.

Comment cont'd: For the general public, the phrase 'quasi-steady-state' should be more clearly defined.

Response: Steady-state refers to a system that is in a balanced condition of inputs, outputs, and internal gains and losses. For this case, state-state is used to define dry weather conditions that are assumed to represent a constant, average condition representative of critical dry loads and receiving water volume. The "quasi" aspect refers to conditions under steady state that can vary, including tidal variations that affect receiving water volume and hence the assimilative capacity of pollutants.

Comment cont'd: Meteorological data for wind speed and direction were obtained from 1990 to 2004 but it is unclear how this information was used in the SDB area.

Apparently wind was not included in the Baby Beach model. Given the difference in temperature and salinities between freshwater and ocean water, neglecting wind could impact model results.

Response: Wind speed and direction were used by the San Diego Bay model for simulation of hydrodynamic mixing due to wind effects. As suggested in the comment, wind effects were added to the Dana Point Harbor model and differences were noticed. As a result, wind was added to the model for TMDL calculations. The result is an increase in the load allocation to natural sources. The Technical Report and TMDLs were revised to reflect this change.

Comment cont'd: It is difficult to know if the model domain encompasses the region that would be impacted by the SHELL WQO. The use of SHELL criteria may be overly restrictive if the shellfish beds or areas of potential exposure are some distance from the bay/harbor. It may be that the entire region is restricted by shellfish use but that was not made clear.

Response: Applicable beneficial uses for San Diego Bay and Dana Point Harbor, according to the Basin Plan, are presented in Table 2-3 of the Technical Report. The SHELL beneficial use is applicable to the waters, as well as the shorelines, of San Diego Bay and Dana Point Harbor, so distance from the shellfish beds or areas of potential exposure is not a factor. However, the TMDLs based on the WQOs for SHELL have been removed from this project and technical report and will be addressed in a separate TMDL or water quality standards action. Thus, this comment is no longer relevant.

3. Use of single-sample maximum objectives for wet weather numeric targets.

Comment: Justification for use of single sample maximum exceedance values for wet weather numeric targets is adequate and in line with the USEPA 2000 BEACH Act. These criteria are likely to represent conservative values. States are often left trying to pick whether to regulate based on single-sample maximums or geometric means and there does not appear to be a clear choice.

Response: The San Diego Water Board agrees that the justification for use of single sample maximum exceedance values are adequate for wet weather numeric targets.

4. Reasonableness of assumptions (described in Appendix L) for wet-weather modeling.

Comment: It is not clear that the selection of 1993 as the critical year because it represents the 90th percentile rainfall data is a conservative assumption. The data shown in Appendix E do not appear to be well correlated with rainfall. In fact, often the data seem to decrease during or immediately following rainfall. It seems like the

decision of wet-weather modeling should be based on average 30-day load rather than flow. Furthermore, do the higher flows cause the model to predict higher concentrations at the critical TMDL locations?

Response: Data presented in Appendix E illustrate critical conditions for both dry and wet weather. The fact that most of the data presented in Appendix E appears coincidental with dry conditions is not an indication of lack of correlation with wet conditions, but rather that most data were collected during dry conditions. Also, the criteria for selection of wet and dry days, with wet periods defined by the occurrence of at least 0.2 inches of rainfall (measured at the closest rainfall gage) and the following 72 hours, can potentially lead to identification of wet conditions that were actually more associated with dry, or visa versa. For this reason, results of analyses were qualitative in nature and meant to indicate that both wet and dry conditions result in exceedances of water quality objectives, but not to definitively prove which condition was more critical. Both conditions were considered in separate technical approaches with distinct considerations to pollutant sources and critical conditions. Selection of 1993 as the critical year is specific to wet conditions. Since most wet conditions do not span 30 days and are more episodic in nature, the single sample maximum was considered the most appropriate numeric target, requiring analysis of daily loads and hence daily flows and associated water quality. Dry conditions and associated watershed loads were considered in separate analysis for TMDL calculation. Based on receiving water modeling, higher bacterial densities were observed during wet conditions with higher watershed flows (see Appendix I, now revised to Appendix H).

Comment cont'd: Why wasn't the tidal period chosen to match the period of flow? The criteria for selection of the March-April 2001 observed tidal data was not clear.

Response: The 30-day critical wet weather period, when flow and bacteria were highest, was used for the watershed (LSPC) model. The 30-day critical tidal period, when tidal fluctuation and assimilative capacity of the receiving water was lowest, was used for the receiving water (EFDC) model. The combination of these two 30-day critical periods provide the most conservative possible combination of wet weather flow conditions and low tidal conditions. The Technical Report has been revised to present the criteria for selecting the 30-day critical wet weather period and 30-day critical tidal period more clearly.

Comment cont'd: Appendix L reasonably describes the assumptions that were made in developing the wet-weather model. However, the impacts of these assumptions are not well described. For example, the authors write that the shoreline bacteria die-off rates were 0.6, 0.6 and 0.5/day which were less than Chapra's 0.8/day value. Was any sensitivity done to show how this impacts the results? Why was one of the values less than the other two? It is hard to make the claim later on that the assumptions result in a conservative MOS without understanding the relative impacts of each of the many assumptions.

Response: The original bacteria die-off rate was selected to be slightly lower than Chapra's default 0.8/day value for the consideration of the conservative assumption in the MOS. However, sensitivity analyses were performed and it was noted that the bacteria concentration at the beach area was insensitive to the slight reduction of base die-off rate, indicating that the conservativeness caused from these lower die-off rates is insignificant. As a result, baseline die-off rates for each indicator bacteria were changed to 0.8/day in the model, consistent with the typical value reported by Chapra (1997). The TMDL report was modified to reflect these changes.

5. Use of wet weather modeling parameters to simulate build-up/wash-off of bacteria from similar studies in San Diego and Los Angeles (SDRWQCB, 2005 and LARWQCB, 2002).

Comment: As I am unfamiliar with the similarities and differences between the LA and SD watersheds, it is somewhat difficult for me to assess whether the use of model results for Santa Monica Bay are appropriate. Given the lack of other information and the claim that “..San Diego Region are sufficiently similar to characteristics of ...Los Angeles” it would seem like this is a reasonable assumption as a starting point. The variability between watersheds as well as the assumptions underlying the original study should be understood by the authors.

Response: The model developers have been involved in developing LSPC models for both the San Diego and Los Angeles Region (e.g., LA River and San Gabriel River), and differences and similarities between watersheds, associated data, and applicability of modeling parameters are well understood.

6. Use of dry weather and receiving water model to simulate fate and transport of bacteria, and to calculate TMDLs.

Comment: The regression equations used in the plug-flow reactor model for cross-sectional area and width are likely to be wrong. The correlation coefficients were relatively poor to begin with ($R^2 = 0.51$ for area relationship) and this was for flows up to 15 cfs. The dry weather flows were considerably less than this, with most under 1 cfs. The significance of this in terms of predicted loading to the bays, however, is not clear. At such low flows whether the width is 2 feet or 5 feet may not be significant in terms of load estimates. A sensitivity analysis of the results to this could easily be completed.

Response: The regression equations associated with cross-sectional area and width and the plug flow reactor models were only used in original development of models in Bacteria TMDL Project I to provide verification of model performance at instream monitoring locations (following calibration and validation of stream infiltration and bacterial die-off rates). However, as shown in Appendix F (now revised to Appendix J), all drainage areas modeled in this study consisted of watersheds requiring no routing through downstream subwatersheds. This was due to their small

sizes and lack of need for multiple subwatersheds. Therefore, only equations 6, 7, and 8 of Appendix G (now revised to Appendix F) were used to estimate loadings from watersheds of San Diego Bay and Dana Point Harbor. As a result, impacts of regression equations associated with cross-sectional area and width did not require sensitivity analysis as they were not a factor in load estimates.

Additional discussion was added to Appendix G (now revised to Appendix F) to better explain application of the models from Bacteria TMDL Project I to San Diego Bay and Dana Point Harbor, and the lack of simulation of stream routing. In addition, assumptions associated with the plug flow reactor model were mistakenly listed in Appendix L (now revised to Appendix J) that summarized dry weather modeling assumptions, and were therefore removed.

7. Use of data from Aliso, San Juan, Rose, and Tecolote Creeks to characterize dry weather source loading in the entire San Diego Region.

Comment: The assumptions inherent in this approach have the potential to introduce significant amounts of uncertainty into the TMDL analysis. The assumption that these four creeks are representative of the area does not appear to have been validated. Insufficient information is provided regarding the relative locations, watershed characteristics, land use patterns, bird habitat, and neighborhood preferences regarding water use practices to adequately evaluate this assumption. Moreover, the use of phrase “good fit” to describe R^2 values of 0.74 for flow and 0.67 and 0.77 for correlations between FC and TC and ENT is at least debatable. This is especially true because you end up multiplying flow by concentration to get load so the combined variability could be quite large. Several studies have shown a lack of correlation between fecals (*E. Coli*) and ENT but the ability to extrapolate from regional data is difficult. It is hard to know how this uncertainty affects the conservative assumptions used to justify an implicit MOS.

Most of the dry season flows are less than 1.0 cfs. It would be interesting to know how these small discharges were measured or if they were estimated.

Response: San Juan Creek and Aliso Creek watersheds are both within five miles of Dana Point Harbor (San Juan Creek actually discharges adjacent to Dana Point Harbor). Tecolote Creek and Rose Creek watersheds are both within five miles of most San Diego Bay watersheds. Land uses for each watershed included in this TMDL are summarized in Table G-1 of Appendix G (now revised to Table F-1 of Appendix F), which were based on the same land use datasets used in analyses of San Juan, Aliso, Tecolote, and Rose Creeks. The dominant land uses in these watersheds are shown as low-density residential (LDR), high-density residential (HDR), commercial/institutional (COM), industrial/transportation (IND/TRN), parks/recreation (PRK/OPR), and open space (OPS). Equations 6 and 7 of Appendix G (now revised to Appendix F), which were regression analyses performed on monitoring data and land use in San Juan, Aliso, Tecolote, and Rose Creeks,

showed a correlation based on the following land uses for prediction of dry flows and fecal coliform: COM, OPS, LDR, HDR, PRK, IND, TRN, OPR. These land uses are an exact match to those dominant land uses in the San Diego Bay and Dana Point Harbor watersheds. Data specific to water use practices in the watersheds were not available and though they may have provided some additional evidence of sources of urban runoff, they were not considered in this analysis. Bird habitat information was not considered since such sources are typically very difficult to quantify and correlate with dry urban runoff sources. Although bacteria source identification studies in southern California watersheds typically show a major source of bacteria in runoff to be associated with birds, correlation among watersheds based on bird habitat information is extremely difficult and data intensive, and was not considered productive for this study. Based on the land use and geographical considerations above, as well as previous efforts in Bacteria TMDL Project I, the ability of San Juan, Aliso, Tecolote, and Rose Creeks to characterize conditions of the watersheds of San Diego Bay and Dana Point Harbor were considered justified.

The San Diego Water Board concurs that there is uncertainty for estimation of flows and indicator bacteria based on the regression equations, and although the “good fit” of correlations is debatable, the R^2 values do indicate correlation. In addition to correlations, a general comparison of predicted and observed flows and TC and ENT concentrations are shown in Figures G-3, G-5, and G-6 (now revised to Figures H-3, H-5, and H-6).

The observed and predicted flows in Aliso, Rose, and Tecolote Creeks are shown in Figure G-3 (now revised to Figure H-3) to follow a similar trend, and all are below 1.2 cfs for the watersheds evaluated. Flows from these watersheds were measured and reported by the City of San Diego and the Orange County Public Facilities and Resources Department; specific methods for flow estimation are unknown. Based on the associated equation 6 of Appendix G (now revised to Appendix F), all flows to the San Diego Bay and Dana Point Harbor shorelines were estimated to be less than 0.5 cfs, with flows to Shelter Island Shoreline Park at zero flows. Given these small flows, sensitivities would have varied by insignificant increments of hundredths of a cfs, and were therefore not considered.

We concur that there is much uncertainty in FC, TC, and ENT predictions based on equations 7 and 8 of Appendix G (now revised to Appendix F). However, predicted concentrations for runoff to San Diego Bay and Dana Point Harbor were based strictly on these equations that attempted to provide the best fit to data, and therefore represent typical or average conditions. These predictions did not incorporate additional measures to ensure conservativeness for the implicit MOS.

8. Use of geometric mean objectives for dry weather numeric targets.

Comment: This is the preferred way to compute long-term numeric targets during low flow (dry weather) conditions. It allows for watershed planning activities to address the

big picture issues and reduces the possibility that one aberrant sample will lead to the wrong conclusion.

Response: The San Diego Water Board agrees that the use of geometric means is the preferred way to compute long-term numeric targets during dry weather flow conditions.

9. Reasonableness of assumptions (described in Appendix L) for dry weather modeling.

Comment: The assumptions for dry weather modeling summarized in Appendix L appear justifiable in the current modeling configuration. Given the lack of data, the significant figures associated with several of the calibrated parameters seem interesting and perhaps conveys accuracy that simply isn't present. If the authors believe some or all of these assumptions to be conservative, they could state it in the appendix to strengthen the case for the implicit MOS approach.

Response: The number of significant digits of calibrated parameters, including stream infiltration and bacteria die-off rates, were not meant to convey a degree of accuracy. Rather, these were the actual values used in model predictions and were reported exactly as used. Major assumptions that dominated the conservativeness of the MOS were outlined in Section 7.2.7.

10. Assumptions used for modeling the impaired shorelines of SDB (B Street and G Street Pier) that had no data for model verification or loading assessment.

Comment: There is certainly some uncertainty associated with this assumption as there is no evidence presented to suggest that these two sites should or should not be similar to the other two sites in the SDB. Activities at the G Street Pier may be very different than at Tidelands Park. My lack of familiarity with these locations does not permit me to adequately evaluate this assumption. Given that the model reasonably tracks measured values, it would appear that these assumptions are sufficient for now but likely to cause finger pointing when specific individuals are asked to adopt mitigation practices.

Response: The San Diego Water Board recognizes that uncertainty is associated with the assumptions used for modeling B Street and G Street. However, the shoreline segments of B Street and G Street have been removed from this project. Thus, this comment is no longer relevant.

11. Location of *critical points* for TMDL calculation.

Comment: The use of both SHELL and REC-1 criteria is difficult to follow especially when the concept of interim numeric targets. The locations of SHELL areas were not

discussed. The use of the entire coast line as the monitoring location seems reasonable.

Response: The distinction between interim and final numeric targets has been removed from the Technical Report. Additionally, the TMDLs based on the WQOs for SHELL have been removed from this project and technical report and will be addressed in a separate TMDL or water quality standards action

12. Use of conservative assumptions to comprise an implicit Margin of Safety.

Comment: The section of an implicit versus explicit margin of safety continues to be debated in the scientific community and section criteria are nonexistent. It is easier to understand an explicit MOS but the selection of a value is generally quite arbitrary. The implicit MOS method adopted by this study is extremely difficult to assess in the current document as no sensitivity analysis were performed. Consequently, the relative importance of each assumption is impossible to quantify and the reader is left wondering exactly what the conservative assumptions are.

Response: In the wet and dry weather modeling analyses, conservative assumptions were used whenever possible, meaning that worst-case scenarios are taking place in terms of existing loading to the receiving waters or the ability of the receiving waters to assimilate the pollutants. The San Diego Water Board recognizes that the relative importance of each conservative assumption cannot be quantified exactly. However, the San Diego Water Board believes the conservativeness of the assumptions used (i.e., critical wet weather period, critical tidal period, critical location, etc.), though not quantified, provide an adequate margin of safety in calculating TMDLs.

13. Calculations of wasteload allocations, load allocations and TMDLs during dry weather and wet weather.

Comment: There appears to be considerable scientific rationalization involved at developing estimates of dry weather wasteload allocations. While uncertainty in the approach exist, the rationalization seems reasonable especially considering the relative loading between MS4 and waterfowl sources. Several sections in Chapter 7 appear unnecessarily repetitive. The discussion of critical period in Section 7.1 is essentially a repeat of previous discussions. For clarity, these duplications should be minimized.

Sections 8.3 and 8.4 should be expanded to explain the data shown in the subsequent tables. The results of the entire study are presented without much context.

Response: The Technical Report has been revised to incorporate the recommended changes.

Overarching Questions:

(a) In reading the staff technical reports and proposed implementation language, are there any additional scientific issues that are part of the scientific basis of the proposed rule not described above? If so, please comment with respect to the statute language given above.

(b) Taken as a whole, is the scientific portion of the proposed rule based upon sound scientific knowledge, methods, and practices?

Comment: I must say that in many ways it seems like this TMDL study is putting the cart in front of the horse. There are many data gaps that required assumptions that will eventually need to be proven in order to justify the expected costs associated with the implementation plan. Some of the watershed percent reduction values presented in Tables 8-2, 8-4, 8-5, 8-6, 8-7, 8-8 (note typos in Table numbers on page 40) are astounding and may not be achievable. As mentioned several times in this review, without a better understanding of the sensitivity of the model predictions it is likely that stakeholders will have a hard time comprehending the significance of what will be asked of them. The implementation plan seems extremely vague given the hopes of reaching up to 99.9 % removal. For instance, Table 8-6 proposes a 99.3 % reduction in enterococcus at the B Street Pier even though the existing watershed load of 25 B MPN/day represents only about 1.5% of the 1640 B MPN/day waterfowl load allocation. It seems that this should be specifically explained.

Response: The San Diego Water Board disagrees that the dry weather load reductions required to meet the WLAs assigned to the MS4s are not achievable. Dry weather flows generated in the urban setting and are completely controllable. If the dry weather flows cease, or are significantly reduced, the dry weather bacteria loads from the watersheds will cease or be significantly reduced.

As for the relative contributions of the existing watershed loads compared to the allocation given to natural (waterfowl) sources, this is not an appropriate comparison. The loads attributed to the natural sources are assumed to be constant and uncontrollable, and were calculated as the maximum allowable natural load that may be in the receiving water, which is assigned the natural sources LA, and still meet WQOs. This LA for natural sources was back-calculated by modeling the receiving water to be able to assimilate a load from the watershed that can meet the dry weather numeric targets, which is assigned the MS4 WLA. Therefore, the existing load from the watershed must be compared to the MS4 WLA, not the LA for natural sources. An exceedance of the MS4 WLA will exceed the TMDL if the bacteria loads in the receiving waters are equal to the LA.

Comment (cont'd): Although perhaps outside the scope of this document, a discussion of Best Management Practices that could be used to address the reduction targets could be used. Furthermore, although this may be outside the purview of the

Board, it would seem like requiring NPDES holders to participate in public education and awareness campaigns should be included in the implementation plan.

Response: The Implementation Plan in the Technical Report has been revised to include more details about potential structural and non-structural BMP options for implementation.

Comment (cont'd): When examined in its entirety, the approach appears to be consistent with practices typically adopted for TMDL development. There are a number of assumptions involving professional judgment and empirical relationships necessary due to the lack of site-specific data. In the future, it would be advisable to collect this information to verify these assumptions and make adaptations where necessary.

Response: Monitoring and data collection are required in the Implementation Plan. As additional data are made available, the TMDLs may be revisited and revised, if necessary.

Appendix C
Tentative Resolution No. R9-2008-0027
and
Basin Plan Amendment

This page left intentionally blank

TENTATIVE**CALIFORNIA REGIONAL WATER QUALITY CONTROL BOARD
SAN DIEGO REGION****RESOLUTION NO. R9-2008-0027****A RESOLUTION TO ADOPT AN AMENDMENT TO THE
WATER QUALITY CONTROL PLAN FOR THE SAN DIEGO BASIN (9)
TO INCORPORATE TOTAL MAXIMUM DAILY LOADS FOR INDICATOR BACTERIA,
BABY BEACH IN DANA POINT HARBOR AND
SHELTER ISLAND SHORELINE PARK IN
SAN DIEGO BAY**

WHEREAS, the California Regional Water Quality Control Board, San Diego Region (hereinafter San Diego Water Board), finds that:

- Basin Plan Amendment:** Total Maximum Daily Loads (TMDLs) and allocations for pollutants that exceed water quality objectives in waterbodies that do not meet water quality standards under the conditions set forth in section 303(d) of the Clean Water Act [U.S. Code Title 33 section 1250, *et seq.*, at 1313(d)] (“Water Quality Limited Segments”) should be incorporated into the *Water Quality Control Plan for the San Diego Basin (9)* (Basin Plan) pursuant to Article 3, commencing with section 13240, of Chapter 4 of the Porter-Cologne Water Quality Control Act, as amended, codified in Division 7, commencing with section 13000, of the Water Code.
- Clean Water Act Section 303(d):** As required by section 303(d) of the Clean Water Act, specific segments of San Diego Bay and Dana Point Harbor in the San Diego Region were placed on the List of Water Quality Limited Segments because levels of total coliform, fecal coliform, and/or *Enterococcus* at those locations exceeded water quality objectives for water-contact recreation (REC-1)¹ beneficial use. (Measurements of total coliform, fecal coliform, and *Enterococcus* are relied on to indicate the presence of disease-causing pathogens.) The shoreline segments of San Diego Bay and Dana Point Harbor for which water quality is impaired by bacterial pollution, and for which TMDLs have been calculated, are shown below.

Waterbody	Segment / Area	Hydrologic Descriptor	Pollutant / Stressor	Extent of Impairment	Year Listed
Dana Point Harbor	Baby Beach	Dana Point HSA (901.14)	Indicator bacteria	0.4 miles	2002
San Diego Bay	Shelter Island Shoreline Park	Point Loma HA (908.10)	Indicator bacteria	0.4 miles	2002

¹ The Basin Plan also contains shellfish harvesting (SHELL) beneficial use water quality objectives for total coliform. SHELL impairments for total coliform will be addressed in a separate TMDL and/or standards action.

3. **Water Quality Impairments:** The REC-1 beneficial use is particularly sensitive to, and subject to impairment by, pathogens when elevated densities of indicator bacteria exist in the water.² Persons who ingest water during recreational activities in waters containing indicator bacteria at densities in excess of water quality objectives for REC-1, are significantly more likely to incur infections or illness caused by pathogens in the water than when indicator bacteria occur at densities consistent with the applicable water quality objectives. REC-1 is a beneficial use of the shorelines of San Diego Bay and Dana Point Harbor where water quality is listed as impaired.
4. **Necessity Standard** [Government Code section 11353(b)]: Amendment of the Basin Plan to establish and implement Total Maximum Daily Loads (TMDLs) for the waters along the impaired shoreline segments of San Diego Bay and Dana Point Harbor is necessary because the existing water quality at the shoreline segments listed in Attachment A does not meet applicable water quality objectives for total coliform, fecal coliform, and/or *Enterococcus* bacteria. Clean Water Act section 303(d) requires the establishment and implementation of TMDLs under the water quality conditions that exist at these shoreline segments. TMDLs for total coliform, fecal coliform, and/or *Enterococcus* bacteria are necessary to promote attainment of applicable water quality objectives and restoration of water quality needed to support the beneficial uses designated for the shorelines of San Diego Bay and Dana Point Harbor.
5. **Water Quality Objectives:** Water quality objectives for bacteria the coastal waters of the Baby Beach and Shelter Island Shoreline Park shorelines, expressed as the most probable number of bacteria colonies per 100 mL of water sample (MPN/100 mL), are contained in the Basin Plan.

The water quality objectives for indicator bacteria in inland surface waters and enclosed bays and estuaries designated as having the REC-1 beneficial use include:

- i. **Total Coliform (Bays and Estuaries):** Total coliform bacteria density shall be less than 1,000 per 100 ml (10 per ml); provided that not more than 20 percent of the samples at any station, in any 30-day period, may exceed 1,000 per 100 ml (10 per ml) and provided further that no single sample when verified by a repeat sample taken within 48 hours shall exceed 10,000 per 100 (100 per ml).
- ii. **Fecal Coliform (Marine Waters):** Based on a minimum of not less than five samples for any 30-day period, fecal coliform bacteria density shall not exceed a log mean of 200 per 100 ml, nor shall more than 10 percent of total samples during any 30-day period exceed 400 per 100 ml.
- iii. ***Enterococcus* (Marine Waters):** The geometric mean of *Enterococcus* bacteria shall not exceed 35 colonies per 100 ml. The single sample maximum allowable density in designated beach areas is 104 colonies per 100 ml, in

² Water quality objectives for indicator bacteria in waters with non-water-contact recreation (REC-2) are less stringent than the water quality objectives for REC-1, therefore, attainment of REC-1 objectives through the implementation of TMDLs will, *a fortiori*, provide the requisite water quality for REC-2.

moderately or lightly used areas is 276 colonies per 100 ml, in infrequently used areas is 500 colonies per 100 ml.

6. **Numeric Targets:** Numeric Targets are established for the purposes of calculating TMDLs. The numeric targets for these TMDLs consist of the REC-1 water quality objectives for indicator bacteria contained in the Basin Plan. Since numeric targets are equal to the water quality objectives for total coliform, fecal coliform, and enterococci bacteria cited in finding 5, attainment of TMDLs will ensure attainment of these water quality objectives.
7. **Sources of Bacteria:** Sources of bacteria are the same under both wet weather and dry weather conditions. Bacteria can enter surface waters from both nonpoint and point sources. Nonpoint sources are typically diffuse sources that have multiple routes of entry into surface waters. Point sources typically discharge at a specific location from pipes, outfalls, and conveyance channels. The only nonpoint sources identified were natural or background sources, such as direct inputs from birds, terrestrial and aquatic animals, or other unidentified sources within the receiving waters. The only point source identified was discharges from municipal separate storm sewer systems (MS4s), although other point sources may exist. For both wet weather and dry weather conditions, there are natural and background sources of bacteria within the receiving waters at the impaired shoreline segments. These nonpoint sources of bacteria are generally considered uncontrollable. However, for sources of bacteria that originate from the watersheds draining into the receiving waters, which are located entirely within urbanized areas, the method of transport for the two conditions is very different. Wet weather loading originating from the watersheds is dominated by episodic storm flows that wash off bacteria that build up on the surface of all land use types in a watershed during dry periods. Dry weather loading originating from the watersheds is dominated by nuisance flows from urban land use activities such as car washing, sidewalk washing, and lawn over-irrigation, which pick up bacteria and deposit it into receiving waters. Because the watersheds draining into the receiving waters are located entirely within urbanized areas, and therefore surface runoff is collected and discharged from MS4s, the watershed sources of bacteria are controllable.
8. **Water Quality Objective Violations:** Bacteria densities at the impaired shoreline segments of Baby Beach and Shelter Island Shoreline Park have frequently exceeded water quality objectives.
9. **Relationship Between Bacteria and Pathogens:** Fecal indicator bacteria originate from the intestinal flora of warm-blooded animals, including humans, and their presence in surface water is used as an indicator of the possible presence of human pathogens (*i.e.*, organisms that can cause illness in people exposed through recreational water use and people who harvest and eat filter-feeding shellfish; pathogens include protozoans, bacteria, viruses, and other disease-causing organisms). Bacteria have been historically used as indicators of human pathogens because the probability of disease is directly correlated with the density of indicator bacteria in waters used for recreation and because the indicator bacteria are easier

and less costly to measure than the pathogens themselves. If TMDLs for indicator bacteria are attained, then water quality objectives are met, and health risks associated with pathogens are minimal.

10. **Total Maximum Daily Loads** [Code of Federal Regulations Title 40 section 130.2(i)]: TMDLs for bacteria are equal to the total assimilative or loading capacities of the receiving waters along the shorelines of Baby Beach and Shelter Island Shoreline Park for total coliform, fecal coliform, and *Enterococcus* bacteria. The loading capacities are defined as the maximum amount of fecal coliform, total coliform and *Enterococcus* that the waterbody can receive and still attain water quality objectives necessary for the protection of designated beneficial uses. Each TMDL must accommodate all known sources of a pollutant, whether from natural background, nonpoint sources, or point sources, and must include a margin of safety (MOS) to preclude pollutant loading from exceeding the actual assimilative capacities of the waterbodies. The TMDL calculations also account for seasonal variations and critical conditions and were developed in a manner consistent with guidelines published by USEPA.
11. **Allocations and Reductions**: Discharges of bacteria from all identified sources that are susceptible to control or management must be reduced in order to keep total bacterial loads as close to the TMDLs and actual assimilative capacities of the impaired waters as possible. Discharges from controllable sources were identified as originating from MS4s for urbanized sources. Controllable sources must be reduced by an amount in proportion to the existing loads generated in each watershed, as calculated using a computer model. TMDLs are reported on a watershed basis and must be jointly achieved by all dischargers of bacteria located in the watersheds. Natural sources of bacteria are considered uncontrollable and no load reductions are necessary.
12. **Implementation Plan**: The report entitled *Total Maximum Daily Loads for Indicator Bacteria, Baby Beach and Shelter Island Shoreline Park Shorelines*, (Technical Report) dated **Month Day, 2008** presents a summary of measures that, if adopted by the San Diego Water Board, the State Water Resources Control Board (State Water Board), and local governmental agencies, will promote attainment of the load reductions needed to keep discharges of bacteria at or below the TMDLs calculated for these waterbodies. Section 303 of the CWA and the federal NPDES regulations direct USEPA and authorized states to impose requirements consistent with TMDLs for point source discharges to “impaired” waterbodies. When the San Diego Water Board and State Water Board re-issue or revise National Pollutant Discharge Elimination System (NPDES) requirements for municipal storm water discharges, they will have to include requirements that will implement all TMDLs applicable to waters affected by the regulated discharges.
13. **Compliance Monitoring**: Monitoring including pollutant load reductions, changes in urban runoff and discharge water quality, and changes in receiving water quality will be necessary to assess effectiveness in achieving load and wasteload allocations

and compliance with the water quality objectives for total coliform, fecal coliform, and *Enterococcus* bacteria.

14. **Scientific Peer Review:** The scientific basis for these TMDLs has undergone external peer review pursuant to Health and Safety Code section 57004. The San Diego Water Board has considered and responded to all comments submitted by the peer review panel, and has enhanced the Technical Report appropriately. No change to the fundamental approach to TMDL calculation was necessary as a result of this process.
15. **CEQA Requirements:** Pursuant to Public Resources Code section 21080.5, the Resources Agency has approved the Regional Water Boards' basin planning process as a "certified regulatory program" that adequately satisfies the California Environmental Quality Act (CEQA) [Public Resources Code section 21000 et seq.] requirements for preparing environmental documents [California Code of Regulations Title 14 section 15251(g); California Code of Regulations Title 23 section 3782]. As such, the documents supporting the San Diego Water Board's proposed basin planning action contain the required environmental documentation under CEQA and serve as "substitute documents" [California Code of Regulations Title 23 section 3777]. The substitute documents for this project include the environmental checklist, the detailed Technical Report, responses to comments submitted during the public participation phase in the development of the TMDLs, and this resolution. The project itself is the establishment of TMDLs for indicator bacteria for the shoreline segments of San Diego Bay and Dana Point Harbor where water quality has been listed as "impaired" by the State Water Board pursuant to section 303(d) of the Clean Water Act, as required by that section. While the San Diego Water Board has no discretion to not establish the TMDLs (the TMDLs are required by federal law), the Board does exercise discretion in assigning wasteload allocations and load allocations, determining the program of implementation, and setting various milestones in achieving the applicable water quality objectives at the affected beaches and creeks.
16. **Project Impacts:** The accompanying CEQA substitute documents satisfy the requirements of substitute documents for a Tier 1 environmental review under CEQA, pursuant to Public Resources Code section 21159 and California Code of Regulations Title 14 section 15187. Nearly all of the compliance obligations anticipated to be necessary to implement the TMDLs for indicator bacteria will be undertaken by public agencies that will have their own obligations under CEQA for implementation projects that could have significant environmental impacts (e.g., installation and operation of structural best management practices). Project level impacts will need to be considered in any subsequent environmental analysis performed by other public agencies pursuant to Public Resources Code section 21159.2.

If not properly mitigated at the project level, implementation and compliance measures undertaken could have significant adverse environmental impacts. The substitute documents for this TMDL, and in particular the environmental checklist

and responses to comments, identify broad mitigation approaches that should be considered at the project level. The San Diego Water Board does not engage in speculation or conjecture regarding the projects that may be used to implement the TMDLs and only considers the reasonably foreseeable alternative methods of compliance, the reasonably foreseeable feasible environmental impacts of these methods of compliance, and the reasonably foreseeable mitigation measures which would avoid or eliminate the identified impacts, all from a broad general perspective consistent with the uncertainty regarding how the TMDLs, ultimately, will be implemented. The lengthy implementation period allowed by the TMDLs will allow persons responsible for compliance with wasteload allocations to develop and pursue many compliance approaches and mitigation measures.

17. **Project Mitigation:** The proposed amendment to the Basin Plan to establish TMDLs for indicator bacteria in the receiving waters at the shoreline segments of San Diego Bay and Dana Point Harbor could have a significant adverse effect on the environment. However, there are feasible alternatives, feasible mitigation measures, or both, that would substantially lessen any significant adverse impact. The public agencies responsible for implementation measures needed to comply with the TMDLs can and should incorporate such alternatives and mitigation into any projects or project approvals that they undertake for the impaired beaches and creeks. Possible alternatives and mitigation are described in the CEQA substitute documents, specifically the Technical Report and the environmental checklist. To the extent the alternatives, mitigation measures, or both, are not deemed feasible by those agencies, the necessity of implementing the TMDLs that is mandated by the federal Clean Water Act and removing the bacteria impairments within waterbodies in the San Diego Region (an action required to achieve the express, national policy of the Clean Water Act) outweigh the unavoidable adverse environmental effects identified in the substitute documents.
18. **Department of Fish and Game Filing Fee:** Considering the record as a whole, this Basin Plan amendment will result in no effect, either individually or cumulatively, on wildlife resources.
19. **Economic Analysis:** The San Diego Water Board has considered the costs of the reasonably foreseeable methods of compliance with the load and wasteload allocations specified in these TMDLs. The most reasonably foreseeable methods of compliance involve implementation of structural and non-structural controls. Surface water monitoring to evaluate the effectiveness of these controls will be necessary
20. **Stakeholder and Public Participation:** Interested persons and the public have had reasonable opportunity to participate in review of the proposed TMDLs. Efforts to solicit public review and comment included a public workshop and CEQA scoping meeting in March 2003, a public workshop in March 2004, three meetings with the Stakeholder Advisory Group, a public review and comment period consisting of XX days, and a public hearing on Month Day, 2008. Notices for all meetings were sent to interested parties including cities and counties with jurisdiction in watersheds draining to the bacteria impaired shoreline segments. All of the written comments

submitted to the San Diego Water Board during the review and comment periods have been considered in Appendix XX to the Technical Report.

21. **Public Notice:** The San Diego Water Board has notified all known interested parties and the public of its intent to consider adoption of this Basin Plan amendment in accordance with Water Code section 13244.

NOW, THEREFORE, BE IT RESOLVED THAT:

1. **Environmental Documents Certification:** The substitute environmental documents prepared pursuant to Public Resources Code section 21080.5 are hereby certified, and the Executive Officer is directed to file a Notice of Decision with the Resources Agency after State Water Board and Office of Administrative Law (OAL) approval of the Basin Plan Amendment, in accordance with section 21080.5(d)(2)(E) of the Public Resources Code and the California Code of Regulations Title 23 section 3781.
2. **Amendment Adoption:** The San Diego Water Board hereby adopts the attached Basin Plan amendment as set forth in Attachment A hereto to establish TMDLs for indicator bacteria at Baby Beach and Shelter Island Shoreline Park.
3. **Technical Report Approval:** The San Diego Water Board hereby approves the Technical Report entitled *Total Maximum Daily Loads for Indicator Bacteria, Baby Beach in Dana Point Harbor and Shelter Island Shoreline Park in San Diego Bay*, dated Month Day, 2008.
4. **Certificate Of Fee Exemption:** The Executive Officer is authorized to sign a Certificate of Fee Exemption for a “no” impact finding and shall submit this Certificate *in lieu* of payment of the California Department of Fish and Game filing fee.
5. **Agency Approvals:** The Executive Officer is directed to submit this Basin Plan amendment to the State Water Board in accordance with Water Code section 13245.
6. **Non-Substantive Corrections:** If, during the approval process for this amendment, the San Diego Water Board, the State Water Board, or the OAL determines that minor, non-substantive corrections to the language of the amendment are needed for clarity or consistency, the Executive Officer may make such changes, and shall inform the San Diego Water Board of any such changes.

I, John H. Robertus, Executive Officer, do hereby certify that the foregoing is a full, true and correct copy of a resolution adopted by the California Regional Water Quality Control Board, San Diego Region, on Month Day, 2008.

JOHN H. ROBERTUS
Executive Officer

ATTACHMENT A TO RESOLUTION NO. R9-2008-0027**ATTACHMENT A
TO RESOLUTION NO. R9-2008-0027****AMENDMENT TO THE WATER QUALITY
CONTROL PLAN FOR THE SAN DIEGO BASIN (9) TO INCORPORATE
TOTAL MAXIMUM DAILY LOADS FOR INDICATOR BACTERIA,
BABY BEACH IN DANA POINT HARBOR AND
SHELTER ISLAND SHORELINE PARK IN
SAN DIEGO BAY**

This Basin Plan amendment establishes Total Maximum Daily Loads (TMDLs) and associated load and wasteload allocations for total coliform, fecal coliform, and *Enterococcus* bacteria along the shorelines of Baby Beach, located within Dana Point Harbor, and Shelter Island Shoreline Park, located within San Diego Bay. This amendment includes a program to implement the TMDLs and monitor their effectiveness. Chapters 2, 3, and 4 of the Basin Plan are amended as follows:

CHAPTER 2. BENEFICIAL USES.***Table 2-3. BENEFICIAL USES OF COASTAL WATERS.***

Consecutively number and add the following footnote to Dana Point Harbor in Table 2-3:

The shoreline segment along Baby Beach within Dana Point Harbor is designated as a water quality limited segment for indicator bacteria pursuant to Clean Water Act section 303(d). Total Maximum Daily Loads have been adopted to address these impairments. See Chapter 4, *Implementation, Clean Water Act Section 303(d) Requirements for Impaired Waterbodies, Total Maximum Daily Loads for Indicator Bacteria, Baby Beach in Dana Point Harbor and Shelter Island Shoreline Park in San Diego Bay.*

Consecutively number and add the following footnote to San Diego Bay in Table 2-3:

The shoreline segment along Shelter Island Shoreline Park within San Diego Bay is designated as a water quality limited segment for indicator bacteria pursuant to Clean Water Act section 303(d). Total Maximum Daily Loads have been adopted to address these impairments. See Chapter 4, *Implementation, Clean Water Act Section 303(d) Requirements for Impaired Waterbodies, Total Maximum Daily Loads for Indicator Bacteria, Baby Beach in Dana Point Harbor and Shelter Island Shoreline Park in San Diego Bay.*

Renumber any footnotes in Table 2-3 displaced by these new footnotes.

ATTACHMENT A TO RESOLUTION NO. R9-2008-0027**CHAPTER 3. WATER QUALITY OBJECTIVES.****OCEAN WATERS.****OCEAN PLAN AND THERMAL PLAN.*****Ocean Plan and Thermal Plan Water Quality Objective.***

Add the following paragraph to the end of the introductory text:

The shoreline segment along Baby Beach within Dana Point Harbor is designated as a water quality limited segment for indicator bacteria pursuant to Clean Water Act section 303(d). Total Maximum Daily Loads have been adopted to address these impairments. See Chapter 2, Table 2-3, *Beneficial Uses of Coastal Waters*, Footnote [*insert footnote number*], and Chapter 4, *Implementation, Clean Water Act Section 303(d) Requirements for Impaired Waterbodies, Total Maximum Daily Loads for Indicator Bacteria, Baby Beach in Dana Point Harbor and Shelter Island Shoreline Park in San Diego Bay.*

INLAND SURFACE WATERS, ENCLOSED BAYS AND ESTUARIES, COASTAL LAGOONS, AND GROUND WATERS.**BACTERIA – TOTAL AND FECAL COLIFORM.**

Add the following paragraph to the end of the introductory text:

The shoreline segment along Shelter Island Shoreline Park within San Diego Bay is designated as a water quality limited segment for indicator bacteria pursuant to Clean Water Act section 303(d). Total Maximum Daily Loads have been adopted to address these impairments. See Chapter 2, Table 2-3, *Beneficial Uses of Coastal Waters*, Footnote [*insert footnote number*], and Chapter 4, *Implementation, Clean Water Act Section 303(d) Requirements for Impaired Waterbodies, Total Maximum Daily Loads for Indicator Bacteria, Baby Beach in Dana Point Harbor and Shelter Island Shoreline Park in San Diego Bay.*

INLAND SURFACE WATERS, ENCLOSED BAYS AND ESTUARIES, COASTAL LAGOONS, AND GROUND WATERS.**BACTERIA – E. COLI AND ENTEROCOCCI.**

(2) Waters Designated for Contact Recreation (REC-1) Beneficial Use

Add the following paragraph to the end of the introductory text:

The shoreline segment along Shelter Island Shoreline Park within San Diego Bay is designated as a water quality limited segment for indicator bacteria pursuant to Clean Water Act section 303(d). Total Maximum Daily Loads have been adopted to address these impairments. See Chapter 2, Table 2-3, *Beneficial Uses of Coastal Waters*, Footnote [*insert footnote number*], and Chapter 4, *Implementation, Clean Water Act Section 303(d) Requirements for Impaired Waterbodies, Total Maximum*

ATTACHMENT A TO RESOLUTION NO. R9-2008-0027

Daily Loads for Indicator Bacteria, Baby Beach in Dana Point Harbor and Shelter Island Shoreline Park in San Diego Bay.

CHAPTER 4. IMPLEMENTATION.

Amend the Table of Contents to Chapter 4 to include the subsection added below.

Consecutively number and renumber footnotes appropriately.

Add the following subsection after the most recently adopted and approved TMDL subsection and before the Other Programs subsection:

***TOTAL MAXIMUM DAILY LOADS FOR INDICATOR BACTERIA,
BABY BEACH AND SHELTER ISLAND SHORELINE PARK SHORELINES***

On [Insert date], the San Diego Water Board adopted Resolution No. R9-2008-0027, *A Resolution Amending the Water Quality Control Plan for the San Diego Region (9) to Incorporate Total Maximum Daily Loads for Indicator Bacteria, Baby Beach in Dana Point Harbor and Shelter Island Shoreline Park in San Diego Bay.* The TMDL Basin Plan Amendment was subsequently approved by the State Water Resources Control Board on [Insert date], the Office of Administrative Law on [Insert date], and the USEPA on [Insert date].

PROBLEM STATEMENT

Bacteria densities along the shoreline segments of Baby Beach within Dana Point Harbor and Shelter Island Shoreline Park within San Diego Bay violate water quality objectives (WQOs) for indicator bacteria. Bacteria densities in waters at these shoreline segments unreasonably impair and threaten to impair the water quality needed to support designated beneficial uses of contact recreation (REC-1)³.

The federal Clean Water Act requires the establishment of Total Maximum Daily Loads (TMDLs) for pollutants that exceed water quality objectives needed to support designated beneficial uses, *i.e.*, that cause or contribute to violation of state “water quality standards.”

³ Water quality objectives for indicator bacteria in waters with non-water-contact recreation (REC-2) are less stringent than the water quality objectives for REC-1, therefore, attainment of REC-1 objectives through the implementation of TMDLs will, *a fortiori*, provide the requisite water quality for REC-2.

ATTACHMENT A TO RESOLUTION NO. R9-2008-0027**NUMERIC TARGETS**

When calculating TMDLs, numeric targets are established to meet WQOs and subsequently ensure the protection of beneficial uses. The numeric targets for these TMDLs consist of the REC-1 WQOs for indicator bacteria contained in the Ocean Plan and Basin Plan. TMDLs were calculated for each impaired waterbody, for each indicator bacteria, for wet and dry weather. The numeric targets used in the TMDL calculations were equal to the WQOs for bacteria for REC-1.

Different dry weather and wet weather numeric targets were used for load calculations because the bacteria transport mechanisms to receiving waters are different under wet and dry weather conditions.

Single sample maximum WQOs were used as wet weather numeric targets. Dry weather numeric targets are typically best represented by geometric mean WQOs. However, due to extreme diurnal variations in bacteria densities that can result from tidal effects, in some cases the maximum hourly concentration could regularly exceed the single sample maximum WQOs. Therefore, both the REC-1 30-day geometric mean and single sample maximum WQOs were selected as numeric targets for dry weather. The numeric targets were equal to the total coliform, fecal coliform and *Enterococcus* WQOs for REC-1 in all cases.

The numeric targets for the scenarios described above are listed in the following tables:

Table [Insert Table Number]. Wet Weather Numeric Targets

Basis for Numeric Target	Total Coliform (MPN/100mL)	Fecal Coliform (MPN/100mL)	<i>Enterococcus</i> (MPN/100mL)
Beneficial Use	REC-1	REC-1	REC-1
Single sample maximum	10,000	400	104

Table [Insert Table Number]. Dry Weather Numeric Targets

Basis for Numeric Target	Total Coliform (MPN/100mL)	Fecal Coliform (MPN/100mL)	<i>Enterococcus</i> (MPN/100mL)
Beneficial Use	REC-1	REC-1	REC-1
30-day geometric mean	1,000	200	35
Single sample maximum	10,000	400	104

SOURCE ANALYSIS

Sources of bacteria are the same under both wet weather and dry weather conditions. Bacteria can enter surface waters from both nonpoint and point sources. Nonpoint sources are typically diffuse sources that have multiple routes of entry into surface waters. Point sources typically discharge at a specific location from pipes,

ATTACHMENT A TO RESOLUTION NO. R9-2008-0027

outfalls, and conveyance channels. The only nonpoint sources identified were natural or background sources, such as direct inputs from birds, terrestrial and aquatic animals, or other unidentified sources within the receiving waters. The watersheds that drain into the receiving waters at the impaired shoreline segments are wholly located within urbanized areas. Therefore, the only point source identified was urban runoff discharged from municipal separate storm sewer systems (MS4s), although other point sources may exist.

For both wet weather and dry weather conditions, there are natural and background sources of bacteria within the receiving waters at the impaired shoreline segments. However, for sources of bacteria that originate from the watersheds draining into the receiving waters, the method of transport for the two conditions is very different. Wet weather loading originating from the watersheds is dominated by episodic storm flows that wash off bacteria that build up on the surface of all land use types in the watershed during dry periods. Dry weather loading originating from the watersheds is dominated by nuisance flows from urban land use activities such as car washing, sidewalk washing, and lawn over-irrigation, which pick up bacteria and deposit it into receiving waters.

TOTAL MAXIMUM DAILY LOADS AND ALLOCATIONS

The TMDLs are equal to the assimilative or loading capacity of each shoreline segment for each pollutant. TMDLs for each type of indicator bacteria were developed for each impaired waterbody. TMDLs are defined as the maximum amount of a pollutant the waterbody can receive and still attain water quality objectives and protection of designated beneficial uses. Once calculated, a TMDL is set equal to the sum of all individual Waste Load Allocations (WLAs) for point sources and Load Allocations (LAs) for nonpoint sources. The TMDL includes a margin of safety (MOS) that takes into account any uncertainties in the TMDL calculation, which may be explicit or implicit. For these TMDLs, an implicit margin of safety is included via conservative estimates and assumptions used throughout the TMDL calculations. Separate TMDLs were calculated for wet weather and dry weather conditions to account for seasonal variations, and because the transport mechanism, flow, and bacteria loads from the watersheds draining to the receiving waters are different between dry and wet weather conditions.

Calibrated models were used to simulate flow and bacteria densities from the watersheds draining into the receiving waters and within the receiving waters of the shoreline segments. The models were used to calculate the existing bacteria loads, as well as TMDLs for each impaired shoreline segment. The modeled existing loads were compared to the TMDLs to calculate the necessary load reductions needed to achieve the TMDLs in the waterbodies. The TMDLs were allocated among point sources (WLAs) and nonpoint sources (LAs). The only point source identified was urban runoff discharged from MS4s, which was assigned a WLA for each watershed. The only nonpoint sources identified were natural or background sources, such as

ATTACHMENT A TO RESOLUTION NO. R9-2008-0027

direct inputs from birds, terrestrial and aquatic animals, or other unidentified sources within the receiving waters, which were lumped together and assigned a LA. Because only the point sources are considered controllable, a load reduction was only calculated for the bacteria loads from the MS4s. The TMDLs, LAs for natural and background sources, WLAs for municipal MS4s, and load reductions for municipal MS4s are shown below in Tables [Insert table numbers].

MARGIN OF SAFETY

There are two ways to incorporate the MOS (USEPA, 1991): (1) implicitly incorporate the MOS using conservative model assumptions to develop allocations; and/or, (2) explicitly specify a portion of the total TMDL as the MOS and use the remainder for allocations. Throughout the TMDL development process, conservative assumptions were employed. Based on the incorporation of all these conservative assumptions, no explicit MOS was necessary.

Draft Technical Report (Appendix C – Tentative Resolution)
 TMDLs for Indicator Bacteria
 Baby Beach and Shelter Island Shoreline Park

ATTACHMENT A TO RESOLUTION NO. R9-2008-XXXX

Table [Insert table number]. REC-1 Wet Weather TMDLs for Total Coliform for Baby Beach and Shelter Island Shoreline Park Shoreline Segments

Waterbody	Shoreline Segment/Area	Hydrologic Descriptor	Model Sub-watershed	TMDL (Billion MPN/ 30 days)	Load Allocations (LAs)	Wasteload Allocations (WLAs)	Existing Wasteloads	Percent Reduction of Municipal MS4 Existing Wasteload ²
					Natural/Background (Billion MPN/ 30 days) ¹	Municipal MS4 (Billion MPN/ 30 days)	Municipal MS4 (Billion MPN/ 30 days)	
Dana Point Harbor	Baby Beach	Dana Point HSA (901.14)	2101,2102 2103,2104	166,111	162,857	3,254	3,254	0%
San Diego Bay	Shelter Island Shoreline Park	Point Loma HA (908.10)	2201	482,598	482,400	198	198	0%

Abbreviations/Acronyms:
 TMDL: total maximum daily load
 LA: load allocation for nonpoint source
 WLA: wasteload allocation for point source
 MS4: Municipal Separate Storm Sewer System
 MPN: most probable number

Notes:
¹ Calculated by dry weather EFDC model analysis (Dry weather LA from Table 8-4 multiplied by 30 days). No reduction required for natural sources.
² Percent Reduction of Existing Municipal MS4 Wasteload = (Existing Municipal MS4 Wasteload – Municipal MS4 WLA) ÷ (Existing Municipal MS4 Wasteload) x 100%

Table [Insert table number]. REC-1 Wet Weather TMDLs for Fecal Coliform for Baby Beach and Shelter Island Shoreline Park Shoreline Segments

Waterbody	Shoreline Segment/Area	Hydrologic Descriptor	Model Sub-watershed	TMDL (Billion MPN/ 30 days)	Load Allocations (LAs)	Wasteload Allocations (WLAs)	Existing Wasteloads	Percent Reduction of Municipal MS4 Existing Wasteload ²
					Natural/Background (Billion MPN/ 30 days) ¹	Municipal MS4 (Billion MPN/ 30 days)	Municipal MS4 (Billion MPN/ 30 days)	
Dana Point Harbor	Baby Beach	Dana Point HSA (901.14)	2101,2102 2103,2104	32,585	32,473	112	112	0%
San Diego Bay	Shelter Island Shoreline Park	Point Loma HA (908.10)	2201	41,408	41,400	8	8	0%

Abbreviations/Acronyms:
 TMDL: total maximum daily load
 LA: load allocation for nonpoint source
 WLA: wasteload allocation for point source
 MS4: Municipal Separate Storm Sewer System
 MPN: most probable number

Notes:
¹ Calculated by dry weather EFDC model analysis (Dry weather LA from Table 8-5 multiplied by 30 days). No reduction required for natural sources.
² Percent Reduction of Existing Municipal MS4 Wasteload = (Existing Municipal MS4 Wasteload – Municipal MS4 WLA) ÷ (Existing Municipal MS4 Wasteload) x 100%

Draft Technical Report (Appendix C – Tentative Resolution)
 TMDLs for Indicator Bacteria
 Baby Beach and Shelter Island Shoreline Park

ATTACHMENT A TO RESOLUTION NO. R9-2008-XXXX

Table [Insert table number]. REC-1 Wet Weather TMDLs for *Enterococcus* for Baby Beach and Shelter Island Shoreline Park Shoreline Segments

Waterbody	Shoreline Segment/Area	Hydrologic Descriptor	Model Sub-watershed	TMDL (Billion MPN/ 30 days)	Load Allocations (LAs)	Wasteload Allocations (WLAs)	Existing Wasteloads	Percent Reduction of Municipal MS4 Existing Wasteload ²
					Natural/Background (Billion MPN/ 30 days) ¹	Municipal MS4 (Billion MPN/ 30 days)	Municipal MS4 (Billion MPN/ 30 days)	
Dana Point Harbor	Baby Beach	Dana Point HSA (901.14)	2101,2102 2103,2104	5,730	5,616	114	301	62.2%
San Diego Bay	Shelter Island Shoreline Park	Point Loma HA (908.10)	2201	10,556	10,530	26	26	0%

Abbreviations/Acronyms:
 TMDL: total maximum daily load
 LA: load allocation for nonpoint source
 WLA: wasteload allocation for point source
 MS4: Municipal Separate Storm Sewer System
 MPN: most probable number

Notes:
¹ Calculated by dry weather EFDC model analysis (Dry weather LA from Table 8-6 multiplied by 30 days). No reduction required for natural sources.
² Percent Reduction of Existing Municipal MS4 Wasteload = (Existing Municipal MS4 Wasteload – Municipal MS4 WLA) ÷ (Existing Municipal MS4 Wasteload) x 100%

Table [Insert table number]. REC-1 Dry Weather TMDLs for Total Coliform for Baby Beach and Shelter Island Shoreline Park Shoreline Segments

Waterbody	Shoreline Segment/Area	Hydrologic Descriptor	Model Sub-watershed	TMDL (Billion MPN/ day)	Load Allocations (LAs)	Wasteload Allocations (WLAs)	Existing Wasteloads	Percent Reduction of Municipal MS4 Existing Wasteload ²
					Natural/Background (Billion MPN/ day) ¹	Municipal MS4 (Billion MPN/ day)	Municipal MS4 (Billion MPN/ day)	
Dana Point Harbor	Baby Beach	Dana Point HSA (901.14)	2101,2102 2103,2104	5,430	5,429	0.86	9.0	90.4%
San Diego Bay	Shelter Island Shoreline Park	Point Loma HA (908.10)	2201	16,080	16,080	0	0	0%

Abbreviations/Acronyms:
 TMDL: total maximum daily load
 LA: load allocation for nonpoint source
 WLA: wasteload allocation for point source
 MS4: Municipal Separate Storm Sewer System
 MPN: most probable number

Notes:
¹ Calculated by dry weather EFDC model analysis. No reduction required for natural sources.
² Percent Reduction of Existing Municipal MS4 Wasteload = (Existing Municipal MS4 Wasteload – Municipal MS4 WLA) ÷ (Existing Municipal MS4 Wasteload) x 100%

Draft Technical Report (Appendix C – Tentative Resolution)
 TMDLs for Indicator Bacteria
 Baby Beach and Shelter Island Shoreline Park

ATTACHMENT A TO RESOLUTION NO. R9-2008-XXXX

Table [Insert table number]. REC-1 Dry Weather TMDLs for Fecal Coliform for Baby Beach and Shelter Island Shoreline Park Shoreline Segments

Waterbody	Shoreline Segment/Area	Hydrologic Descriptor	Model Sub-watershed	TMDL (Billion MPN/day)	Load Allocations (LAs)	Wasteload Allocations (WLAs)	Existing Wasteloads	Percent Reduction of Municipal MS4 Existing Wasteload ²
					Natural/Background (Billion MPN/day) ¹	Municipal MS4 (Billion MPN/day)	Municipal MS4 (Billion MPN/day)	
Dana Point Harbor	Baby Beach	Dana Point HSA (901.14)	2101,2102 2103,2104	1,083	1,082	0.17	1.0	82.7%
San Diego Bay	Shelter Island Shoreline Park	Point Loma HA (908.10)	2201	1,380	1,380	0	0	0%

Abbreviations/Acronyms:
 TMDL: total maximum daily load
 LA: load allocation for nonpoint source
 WLA: wasteload allocation for point source
 MS4: Municipal Separate Storm Sewer System
 MPN: most probable number

Notes:
¹ Calculated by dry weather EFDC model analysis. No reduction required for natural sources.
² Percent Reduction of Existing Municipal MS4 Wasteload = (Existing Municipal MS4 Wasteload – Municipal MS4 WLA) ÷ (Existing Municipal MS4 Wasteload) x 100%

Table [Insert table number]. REC-1 Dry Weather TMDLs for *Enterococcus* for Baby Beach and Shelter Island Shoreline Park Shoreline Segments

Waterbody	Shoreline Segment/Area	Hydrologic Descriptor	Model Sub-watershed	TMDL (Billion MPN/day)	Load Allocations (LAs)	Wasteload Allocations (WLAs)	Existing Wasteloads	Percent Reduction of Municipal MS4 Existing Wasteload ²
					Natural/Background (Billion MPN/day) ¹	Municipal MS4 (Billion MPN/day)	Municipal MS4 (Billion MPN/day)	
Dana Point Harbor	Baby Beach	Dana Point HSA (901.14)	2101,2102 2103,2104	187	187	0.03	0.8	96.2%
San Diego Bay	Shelter Island Shoreline Park	Point Loma HA (908.10)	2201	351	351	0	0	0%

Abbreviations/Acronyms:
 TMDL: total maximum daily load
 LA: load allocation for nonpoint source
 WLA: wasteload allocation for point source
 MS4: Municipal Separate Storm Sewer System
 MPN: most probable number

Notes:
¹ Calculated by dry weather EFDC model analysis. No reduction required for natural sources.
² Percent Reduction of Existing Municipal MS4 Wasteload = (Existing Municipal MS4 Wasteload – Municipal MS4 WLA) ÷ (Existing Municipal MS4 Wasteload) x 100%

ATTACHMENT A TO RESOLUTION NO. R9-2008-XXXX***TMDL IMPLEMENTATION PLAN***

The necessary actions to implement the TMDLs are described in section 10 of the Technical Report entitled *Total Maximum Daily Loads for Indicator Bacteria, Baby Beach in Dana Point Harbor and Shelter Island Shoreline Park in San Diego Bay*, dated **Month Day, 2008**, and listed below.

(A) San Diego Water Board Actions

The TMDLs will be implemented primarily by reissuing or revising the existing NPDES requirements for MS4 discharges to include water quality based effluent limitations (WQBELs) that are consistent with the assumptions and requirements of the bacteria WLAs for MS4 discharges, though there may be other or new point sources.

(1) Process and Schedule for Issuing NPDES Requirements

NPDES requirements should be issued, reissued, or revised “as expeditiously as practicable” to incorporate WQBELs derived from the TMDL WLAs. “As expeditiously as practicable” means the following:

1. **New point sources.** “New” point sources previously unregulated by NPDES requirements must obtain their NPDES requirements before they can lawfully discharge pollutants. For point sources receiving NPDES requirements for the first time, “as expeditiously as practicable” means that the San Diego Water Board incorporates WQBELs that are consistent with the assumptions and requirements of the WLAs into the NPDES requirements and requires compliance with the WQBELs upon the commencement of the discharge.
2. **Point Sources Currently Regulated Under NPDES Requirements.** For point sources currently regulated under NPDES requirements, “as expeditiously as practicable” means that:
 - a. WQBELs that are consistent with the assumptions and requirements of the WLAs should be incorporated into NPDES requirements during their 5-year term, prior to expiration, in accordance with the applicable NPDES requirement reopening provisions, taking into account factors such as available NPDES resources, staff and budget constraints, and other competing priorities.
 - b. In the event the NPDES requirement revisions cannot be considered during the 5-year term, the San Diego Water Board will incorporate WQBELs that are consistent with the assumptions and requirements of the WLAs into the NPDES requirements at the end of the 5-year term.

ATTACHMENT A TO RESOLUTION NO. R9-2008-XXXX***(2) Actions with respect to Phase I Municipal Dischargers***

The Phase I Municipal Dischargers in San Diego and Orange County are required under Receiving Water Limitations A.3.a.1 and C.2⁴ of Orders No. R9-2007-0001 and R9-2002-0001, respectively (San Diego County and Orange County MS4 NPDES requirements) to implement additional BMPs to reduce bacteria discharges in impaired watersheds to the maximum extent practicable and to restore compliance with the bacteria WQOs. This obligation is triggered when either the discharger or the San Diego Water Board determines that MS4 discharges are causing or contributing to an exceedance of an applicable WQO, in this case indicator bacteria WQOs. Designation of the shoreline segments in SDB and DPH as water quality limited segments under Clean Water Act section 303(d) provided sufficient evidence that that MS4 discharges are causing or contributing to the violation of water quality standards. Thus, the Municipal Dischargers should be implementing the provisions of Receiving Water Limitation C.2 with respect to bacteria discharges into water quality limited segments.

In addition to enforcing the provisions of Receiving Water Limitation C.2, the San Diego Water Board shall reissue or revise Orders No. R9-2007-0001 and R9-2002-0001, to incorporate WQBELs consistent with the assumptions and requirements of the bacteria WLAs, and requirements for monitoring and reporting. In those orders, the Phase I Municipal Dischargers are referred to as “Copermittees.”⁵ WQBELs and other requirements implementing the TMDLs can be incorporated into these NPDES requirements upon the normal renewal cycle or sooner, if appropriate. The requirements implementing the TMDLs shall include the following:

- a. WQBELs consistent with the requirements and assumptions of the bacteria WLAs described in Tables 8-1 through 8-6 and a schedule of compliance applicable to the MS4 discharges into the impaired shoreline segments

⁴ Receiving Water Limitations A.3.a.1 and C.2.a provide that “[u]pon a determination by either the Copermittee or the San Diego Water Board that MS4 discharges are causing or contributing to an exceedance of an applicable water quality standard, the Copermittee shall promptly notify and thereafter submit a report to the San Diego Water Board that describes BMPs that are currently being implemented and additional BMPs that will be implemented to prevent or reduce any pollutants that are causing or contributing to the exceedance of water quality standards. The report may be incorporated in the annual update to the Jurisdictional URMP unless the San Diego Water Board directs an earlier submittal. The report shall include an implementation schedule. The San Diego Water Board may require modification to the report.” Additional requirements are included in sections C.2.b-d.

⁵ Copermittees own or operate MS4s through which urban runoff discharges into waters of the U.S. within the San Diego Region. These MS4s fall into one or more of the following categories: (1) a medium or large MS4 that services a population of greater than 100,000 or 250,000 respectively; or (2) a small MS4 that is “interrelated” to a medium or large MS4; or (3) an MS4 which contributes to a violation of a water quality standard; or (4) an MS4 which is a significant contributor of pollutants to waters of the United States.

ATTACHMENT A TO RESOLUTION NO. R9-2008-XXXX

described in Table 10-3. At a minimum, WQBELs shall include a BMP program of expanded or better-tailored BMPs to attain the WLAs.

- b. If the WQBELs consist of BMP programs, then the reporting requirements shall consist of annual progress reports on BMP planning, implementation, and effectiveness in attaining the WQOs in impaired shoreline segments, and annual water quality monitoring reports. The first progress report shall consist of a Bacteria Load Reduction Plan (BLRP). BLRPs must be specific to each impaired waterbody.

To provide guidance to the dischargers in preparing BLRPs, the following bullets describe components that should be considered for incorporation in the BLRPs.

Bacteria Load Reduction Plans should include the following components:

Comprehensive Watershed Approach

- Dischargers should identify the Lead Watershed Contact for their BLRPs. The Lead Watershed Contact should serve as liaison between all other common watershed dischargers and the San Diego Water Board, where appropriate.
- Dischargers should describe a program for encouraging collaborative, watershed-based, land-use planning in their jurisdictional planning departments.
- Dischargers should develop and periodically update a map of the BLRP watershed, to facilitate planning, assessment, and collaborative decision-making. As appropriate, the map should include features such as receiving waters; Clean Water Act section 303(d) impaired receiving waters; water quality projects; land uses; MS4s; major highways; jurisdictional boundaries; and inventoried commercial, industrial, and municipal sites.
- Dischargers should annually assess the water quality of the impaired water body in their BLRPs in order to identify all water quality problems within the impaired water body. This assessment should use applicable water quality data, reports, and analysis generated in accordance with the requirements of the applicable NPDES MS4 monitoring and reporting programs, as well as applicable information available from other public and private organizations.

ATTACHMENT A TO RESOLUTION NO. R9-2008-XXXX

- Dischargers should develop and implement a collective watershed BLRP strategy to meet the bacteria TMDL. The strategy should guide dischargers in developing a Bacteria Compliance Schedule (BCS) which includes BMP planning and scheduling as outlined below.
- Dischargers should collaborate to develop and implement the BLRPs. The BLRP should include a proposal for frequent regularly scheduled meetings among the dischargers in the impaired watershed.
- Each BLRP and BCS should be reviewed annually to identify needed modifications and improvements. The dischargers should develop and implement a plan and schedule, included in the BCS, to address the identified modifications and improvements. All updates to the BLRP should be documented in the BLRP, and submitted to the San Diego Water Board. Individual dischargers should also review and modify their jurisdictional ordinances and activities as necessary so that they are consistent with the requirements of the BLRP.

Bacteria Compliance Schedule - BMP Planning and Scheduling

The BCS should identify the BMPs/water quality projects that are planned for implementation and provide an implementation schedule for each BMP/water quality project. The BCS should demonstrate how the BMPs/water quality projects will address all the bacteria TMDLs. The BCS, at a minimum, should include scheduling for the following:

Non-structural BMP phasing:

- Initial Non-Structural BMP Analysis - Watershed data should be analyzed to identify effective non-structural BMPs for implementation. This should be completed and included in the BCS.
- Scheduled Annual Non-structural BMP Implementation - The above analysis should be used to identify BMPs that will be implemented and to develop an aggressive non-structural BMP implementation schedule. The BCS should include a schedule of the current BMP staffing for each impaired area, and provide a discussion on adjustments to staff scheduling to meet new non-structural BMP demands. Schedules should be realistic and justifiable.
- Scheduled Annual BMP Assessment and Optimizing Adjustments - As the non-structural BMPs are being implemented, a scheduled in-depth assessment of the non-structural BMPs' performance should follow. Non-structural BMPs that are found to be ineffective should be modified to

ATTACHMENT A TO RESOLUTION NO. R9-2008-XXXX

incorporate optimizing adjustments to improve performance or be replaced by other effective non-structural BMPs. The results from this assessment should also be used to determine structural BMP selection and the schedule for structural BMP implementation. The BCS should include an annual schedule for in-depth non-structural BMP assessment and optimizing adjustments.

- Scheduled Continuous Budget and Funding Efforts- Securing budget and funding for non-structural BMP staffing and equipment should be scheduled early and continue until the bacteria TMDLs are met. The BCS should include a schedule for staff time, including position and job description, authorized for securing budget and funding for non-structural BMP implementation.

Structural BMP phasing:

- Scheduled Initial Structural BMP Analysis– Structural BMP analysis should utilize all available information, including the non-structural BMP assessment, to identify, locate, design and build structural BMPs, or a train of BMPs, to meet the these bacteria TMDLs. The BCS should include a schedule for structural BMP analysis.
- Scheduled Annual BMP Construction - The BCS should include a projected general construction schedule with a realistic and justifiable timeline for BMP construction.
- Scheduled Annual BMP Assessment, Optimization Adjustments, and Maintenance - Assessment for structural BMPs should begin immediately upon initial BMP completion, followed by continuously scheduled BMP assessment, optimization adjustments, and maintenance, to both the individual structural BMPs and the structural BMP program as a whole. The BCS should include an annual schedule for in-depth structural BMP assessment.
- Scheduled Continuous Budget and Funding Effort - Securing budget and funding for structural BMPs and additional maintenance staff should be scheduled early and continue until the bacteria TMDLs are met. The BCS should include a schedule for staff time, including position and job description, authorized for securing budget and funding for structural BMP implementation.

Subsequent reports should assess and describe the effectiveness of implementing the Bacteria Load Reduction Plan. Effectiveness assessments should be based on a program effectiveness assessment framework, such as

ATTACHMENT A TO RESOLUTION NO. R9-2008-XXXX

the one developed by the California Stormwater Quality Association (CASQA, no date). Using the CASQA framework as an example, the assessments should address the framework's outcome levels 1-5 on an annual basis, and outcome level 6 once every five years.⁶ Methods used for assessing effectiveness should include the following or their equivalent: surveys, pollutant loading estimations, and receiving water quality monitoring. The long-term strategy should also discuss the role of monitoring data in substantiating or refining the assessment. Once WQOs have been attained, a reduced level of monitoring may be appropriate.

In addition to these requirements, if load-based numerical WQBELs are included in the NPDES requirements, the monitoring requirements should include flow and bacteria density measurements to determine if bacteria loads in effluent are in compliance with WQBELs.

The BLRPs are the municipal dischargers' opportunity to propose methods for assessing compliance with WQBELs that implement TMDLs. The monitoring components included in the BLRPs should be formulated according to particular compliance assessment strategies. The monitoring components are expected to be consistent with, and support whichever compliance assessment methods are proposed. The San Diego Water Board will coordinate with the municipal dischargers during the development of their proposed monitoring components and associated compliance assessment methods.

If NPDES requirements are not likely to be issued, reissued or revised within 6 months of OAL approval of these TMDLs, the San Diego Water Board may issue an investigative/monitoring order to dischargers pursuant to sections 13267 or 13383 of the Water Code. This order would require BMP planning and receiving water quality monitoring in adherence to performance measures described above.

The BLRPs may be re-evaluated at set intervals (such as 5-year renewal cycles for NPDES requirements, or upon request from named dischargers, as appropriate and in accordance with the San Diego Water Board priorities). Plans may be iterative and adaptive according to assessments and any special studies.

⁶ Outcome level 1 assesses compliance with activity-based permit requirements. Outcome level 2 assesses changes in attitudes, knowledge, and awareness. Outcome level 3 assesses behavioral change and BMP implementation. Outcome level 4 assesses pollutant load reductions. Outcome level 5 assesses changes in urban runoff and discharge water quality. Outcome level 6 assesses changes in receiving water quality. See CASQA "An Introduction to Stormwater Program Effectiveness Assessment."

ATTACHMENT A TO RESOLUTION NO. R9-2008-XXXX

(3) Additional Actions

Take Enforcement Actions

The San Diego Water Board shall consider enforcement actions,⁷ as necessary, against any discharger failing to comply with applicable WDRs or discharge prohibitions. Enforcement actions may be taken, as necessary, to control the discharge of bacteria to impaired shorelines to attain compliance with the bacteria WLAs specified in this Technical Report, or to attain compliance with the bacteria WQOs.

Recommend High Priority for Grant Funds

The San Diego Water Board shall recommend that the State Water Board assign a high priority to awarding grant funding⁸ for projects to implement the bacteria TMDLs. Special emphasis will be given to projects that can achieve quantifiable bacteria load reductions consistent with the specific bacteria TMDL WLAs and LAs.

(B) Specific Implementation Objectives

As shown in Tables [Inset table numbers here], no load reductions are required for total coliform, fecal coliform, and *Enterococcus* for Shelter Island Shoreline Park during wet weather or dry weather conditions. Additionally, the modeling results indicate that no load reductions are required for total and fecal coliform for any of the impaired shoreline segments during wet weather conditions. According to the modeling results, only *Enterococcus* wet weather load reductions are required for Baby Beach.

For dry weather, Baby Beach requires between approximately 83 percent and 96 percent wasteload reductions for total coliform, fecal coliform, and *Enterococcus*. However, based only on the water quality data collected during 2006, the number of samples that exceed the REC-1 WQOs are less than the allowable number of exceedances for recommending removal from the 303(d) List. This trend implies that the water quality in the impaired shoreline segments may already meet REC-1 WQOs during dry weather. However, additional monitoring is required to confirm this trend.

⁷ An enforcement action is any formal or informal action taken to address an incidence of actual or threatened noncompliance with existing regulations or provisions designed to protect water quality. Potential enforcement actions including notices of violation (NOVs), notices to comply (NTCs), imposition of time schedules (TSO), issuance of cease and desist orders (CDOs) and cleanup and abatement orders (CAOs), administrative civil liability (ACL), and referral to the attorney general (AG) or district attorney (DA). The San Diego Water Board generally implements enforcement through an escalating series of actions to: (1) assist cooperative dischargers in achieving compliance; (2) compel compliance for repeat violations and recalcitrant violators; and (3) provide a disincentive for noncompliance.

⁸ In most cases, the State Water Board administers the awarding of grants funded from Proposition 13, Proposition 50, Clean Water Act section 319(h) and other federal appropriations to projects that can result in measurable improvements in water quality, watershed condition, and/or capacity for effective watershed management. Many of these grant fund programs have specific set-asides for expenditures in the areas of watershed management and TMDL project implementation for non-point source pollution.

ATTACHMENT A TO RESOLUTION NO. R9-2008-XXXX

While the BLRPs required from the dischargers will still be a requirement, if current trends continue, monitoring and permanent implementation of the current programs and BMPs may be adequate in meeting the wet weather and dry weather TMDLs.

Therefore, assuming the water quality data continue the trend that will support delisting before the NPDES requirement revisions are considered, specific objectives of this Implementation Plan after delisting is found to be appropriate are as follows:

1. Persons responsible for monitoring the impaired shoreline segments of Baby Beach and Shelter Island Shoreline Park for bacteria will continue with the monitoring program to ensure REC-1 WQOs are maintained.
2. If REC-1 WQOs are exceeded, actions outlined in Attachment B of Order Nos. R9-2007-0001 and R9-2002-0001 in section II.C, Coastal Storm Drain Outfall Monitoring, will be implemented.
3. If sources of bacteria persist at levels that exceed water quality standards, then the persons responsible will take appropriate actions to identify and eliminate the source or sources of the chronic contamination.

If the impaired shoreline segments of Baby Beach and Shelter Island Shoreline Park remain on or are put back on the 303(d) List during subsequent iterations of the 303(d) listing process, the San Diego Water Board will revise the NPDES requirements to be consistent with these TMDLs.

(C) Coordination and Execution of Special Studies

The San Diego Water Board recognizes that coordination and execution of special studies by dischargers and other interested persons could result in improved TMDL analyses that more accurately protect beneficial uses. Areas of study that could benefit TMDL analysis include collection of data that can be used to improve model output, improved understanding of bacteria levels and the relationship to health effects, and identification of an appropriate and affordable method(s) to measure pathogens directly. Additionally, studies designed to measure BMP effectiveness and bacteria source identification will be useful for dischargers in identifying appropriate strategies to meet the requirements of this TMDL project.

(1) Collect Data Useful for Model Improvement

Calibration and validation of the computer models used for TMDL analysis was based on limited data (water quality and/or flow) and assumed values for input parameters such as rates for bacteria die-off and re-growth. Especially limited are data related to fecal bacteria that can be attributed to natural sources (e.g., waterfowl and other sources within the waters). Studies designed to collect additional data that can be used for model improvement will result in more accurate TMDL results. Also, data from each watershed can be used to

ATTACHMENT A TO RESOLUTION NO. R9-2008-XXXX

construct models that are applicable to the watershed from which the data originated.

(2) Improve Understanding Between Bacteria Levels and Health Effects

The San Diego Water Board recognizes that there are potential problems associated with using indicator bacteria WQOs to indicate the presence of human pathogens in receiving waters free of sewage discharges. The indicator bacteria WQOs were developed, in part, based on epidemiological studies in waters with sewage inputs. The risk of contracting a water-borne illness from contact with urban runoff devoid of sewage, or human-source bacteria is not known. Some pathogens, such as *giardia* and *cryptosporidium* can be contracted from animal hosts. Likewise, domestic animals can pass on human pathogens through their feces. These and other uncertainties need to be addressed through special studies and, as a result, revisions to the TMDLs established in this project may be appropriate.

As information is gathered, initiating special studies to understand the uncertainties between bacteria levels and bacteria sources within the watersheds may be useful. Specifically, continuing research may be helpful to answer the following questions:

- What is the risk of illness from swimming in water contaminated with urban/stormwater runoff devoid of sewage?
- Do exceedances of the bacteria water quality objectives from animal sources (wildlife and domestic) increase the risk of illness?
- Are there other, more appropriate surrogates for measuring the risk of illness than the indicator bacteria WQOs currently used?

Addressing these uncertainties is needed to maximize effectiveness of strategies to reduce the risk of illness, which is currently measured by indicator bacteria densities. Dischargers may work with the San Diego Water Board to determine if such special studies are appropriate.

(3) Identification of Method for Direct Pathogen Measurement

Ultimately, the San Diego Water Board supports the idea of measuring pathogens (the agents causing impairment of beneficial uses) rather than indicator bacteria (surrogates for pathogens). However, as stated previously, indicator bacteria have been used to measure water quality historically because measurement of pathogens is both difficult and costly. The San Diego Water Board is supportive of any efforts by the scientific community to perform epidemiological studies and/or investigate the feasibility of measuring pathogens directly. The San Diego Water Board further supports subsequent modification

ATTACHMENT A TO RESOLUTION NO. R9-2008-XXXX

of WQOs as a result of such studies. Ultimately, TMDLs will be recalculated if WQOs are modified due to results from future studies.

(D) Compliance ScheduleBaby Beach Compliance Schedule

According to Tables [Insert table numbers], no wet weather wasteload reductions are required for TC and FC. This means that according to the wet weather models for Baby Beach, REC-1 WQOs for total and fecal coliform are not expected to be exceeded due to discharges from the MS4s. The only wet weather wasteload reductions required for MS4s discharging into the receiving waters along the shoreline at Baby Beach is for *Enterococcus*. The compliance schedule for Baby Beach to achieve wet weather TMDLs is as shown in [Insert table number].

Table [Insert table number]. Compliance Schedule for Baby Beach to Achieve Wet Weather TMDLs

Year (after OAL Approval)	Required Wasteload Reduction	TMDL Compliance Action
1	No reduction required	<ul style="list-style-type: none"> ▪ Water Quality Monitoring ▪ Implement BMPs
2	Same as above	<ul style="list-style-type: none"> ▪ Water Quality Monitoring ▪ Implement BMPs
3	Same as above	<ul style="list-style-type: none"> ▪ Water Quality Monitoring ▪ Implement BMPs
4	Same as above	<ul style="list-style-type: none"> ▪ Water Quality Monitoring ▪ Implement BMPs
5	Same as above	<ul style="list-style-type: none"> ▪ Water Quality Monitoring ▪ Implement BMPs
6	Same as above	<ul style="list-style-type: none"> ▪ Water Quality Monitoring ▪ Implement BMPs
7	50 percent ENT reduction	<ul style="list-style-type: none"> ▪ Water Quality Monitoring ▪ Implement BMPs
8	Same as above	<ul style="list-style-type: none"> ▪ Water Quality Monitoring ▪ Implement BMPs
9	Same as above	<ul style="list-style-type: none"> ▪ Water Quality Monitoring ▪ Implement BMPs
10	100 percent ENT reduction	<ul style="list-style-type: none"> ▪ Water Quality Monitoring ▪ Implement BMPs ▪ Submit request for removal from 303(d) List (if not requested and removed earlier)

The phased compliance schedule to achieve wet weather TMDLs will provide the MS4 dischargers time to identify sources, develop plans and implement enhanced and

ATTACHMENT A TO RESOLUTION NO. R9-2008-XXXX

expanded BMPs capable of achieving the mandated decreases in bacteria densities at the BB shoreline.

According to Tables [Insert table numbers], dry weather wasteload reductions are required for total coliform, fecal coliform, and *Enterococcus*. The trend in the water quality data from Baby Beach indicate that the number of REC-1 WQO exceedances have declined significantly beginning in 2006. According to the City of Dana Point and County of Orange, several BMPs have been implemented, including a dry weather flow diversion structure on the east end of the beach, that are responsible for the significant improvements in water quality. If the current trend continues, the San Diego Water Board expects that the dry weather TMDLs for Baby Beach can be achieved within the next 5 years. The compliance schedule for Baby Beach to achieve dry weather TMDLs is as shown in Table [Insert table number].

Table [Insert table number]. Compliance Schedule for Baby Beach to Achieve Dry Weather TMDLs

Year (after OAL Approval)	Required Wasteload Reduction	TMDL Compliance Action
1	No reduction required	<ul style="list-style-type: none"> ▪ Water Quality Monitoring ▪ Implement BMPs
2	Same as above	<ul style="list-style-type: none"> ▪ Water Quality Monitoring ▪ Implement BMPs
3	50 percent reduction	<ul style="list-style-type: none"> ▪ Water Quality Monitoring ▪ Implement BMPs
4	Same as above	<ul style="list-style-type: none"> ▪ Water Quality Monitoring ▪ Implement BMPs
5	100 percent reduction	<ul style="list-style-type: none"> ▪ Water Quality Monitoring ▪ Implement BMPs ▪ Submit request for removal from 303(d) List (if not requested and removed earlier)

Shelter Island Shoreline Park Compliance Schedule

According to Tables [Insert table numbers], there are no wasteload reductions required for MS4s discharging into the receiving waters along the shoreline at Shelter Island Shoreline Park under both wet weather and dry weather conditions. This means that according to the wet weather and dry weather models for Shelter Island Shoreline Park, REC-1 WQOs are not expected to be exceeded due to discharges from the MS4s.

Given that the modeled wasteload reductions for both wet weather and dry weather conditions for all indicator bacteria are zero percent, no compliance schedules were developed to meet wasteload reductions for SISP. However Shelter Island Shoreline Park will remain on the 303(d) List until enough data are collected to support removing

Draft Technical Report (Appendix C – Tentative Resolution)
TMDLs for Indicator Bacteria
Baby Beach and Shelter Island Shoreline Park

February 22, 2008

ATTACHMENT A TO RESOLUTION NO. R9-2008-XXXX

Shelter Island Shoreline Park from the 303(d) List. Therefore, in order to comply with these TMDLs, the responsible municipalities must continue implementing BMPs and collecting data until there are enough data to support and maintain the removal of SISP from the 303(d) List.

The trend in the water quality data from Shelter Island Shoreline Park indicate that the number of REC-1 WQO exceedances have declined significantly since 2003. If the current trend continues, the San Diego Water Board expects that Shelter Island Shoreline Park will have enough data to support removal of Shelter Island Shoreline Park from the 303(d) List by 2010, and no later than 2012.

Appendix D

Data Sources

Draft Technical Report (Appendix D – Data Sources)
TMDLs for Indicator Bacteria
Baby Beach and Shelter Island Shoreline Park

Table D-1. Monitoring Data Sources

Index	Data Source	Location	Station ID	Years Compiled	Purpose	
Hydrology/Hydraulics						
1	United States Geological Survey (USGS) ¹	San Juan Creek	11046530	01/1991-12/2002	Average daily flows on wet days used for calibration and validation of wet-weather modeled streamflows in Bacteria TMDL Project I.	
			11047300	10/1995-04/2002		
2	National Oceanic and Atmospheric Administration-Center for Operational Oceanographic Products and Services (NOAA-COOPS)	San Diego Bay	9410230	01/2001-12/2002	Water elevation data used in determination of open ocean boundary conditions for the hydrodynamic model.	
		San Diego Bay, Dana Point Harbor	9410170	01/2001-12/2002	Water surface elevation data used in calibration of San Diego bay hydrodynamic model and in determination of open ocean boundary conditions for the Dana point harbor hydrodynamic model.	
Water Quality						
3	Orange County Public Health Laboratory (SDRWQCB, 2002)	San Juan Creek	SJ13	4/2001-7/2001	Development of multi-variable regression equations for prediction of dry-weather bacteria levels in Bacteria TMDL Project I.	
			SJ14, SJ15, SJ16, SJ19, SJ20, SJ21, SJ29, SJ32	5/2001-7/2001		
			SJ01, SJ04, SJ05, SJ24	4/2001-7/2001		Validation of dry-weather model for bacteria levels in Bacteria TMDL Project I.
			SJ15, SJ17, SJ18, SJ29	5/2001-7/2001		Validation of wet weather water quality predictions in Bacteria TMDL Project I.
			SJ02, SJ09, SJ10, SJ12, SJ13, SJ25, SJ30	5/2001-12/2001		Validation of wet weather water quality predictions in Bacteria TMDL Project I.
Dana Point Harbor – Baby Beach	BDP12, BDP13, BDP14, BDP15	11/1996-10/2002	Calibration and validation of water quality predictions by the hydrodynamic model.			
4	County of San Diego (2004)	San Diego Bay - Shelter Island Shoreline Park	EH-200	3/1999-2/2004	Calibration and validation of water quality predictions by the hydrodynamic model.	
		San Diego Bay - Tidelands Park	EH-070			
5	SCRIPPS Institution of Oceanography (SCRIPPS)	San Diego Bay	#091, #095	1/2001-12/2002	Continuous surface temperature data used in determination of open ocean boundary conditions for the hydrodynamic model.	
		Dana Point Harbor	#096	1/2001-12/2002		
6	Port of San Diego	San Diego Bay Dana Point Harbor	3	3/2001-12/2001 1/2002-2/2002	Salinity measurements used for determination of open ocean boundary conditions for the hydrodynamic model.	

Draft Technical Report (Appendix D – Data Sources)
 TMDLs for Indicator Bacteria
 Baby Beach and Shelter Island Shoreline Park

Table D-1. Monitoring Data Sources

Index	Data Source	Location	Station ID	Years Compiled	Purpose
Water Quality (Cont'd)					
7	Space and Naval Warfare Systems (SPAWAR)	San Diego Bay	1 through 27	1/2000-8/2002	Salinity and temperature measurements used for calibration and validation of the hydrodynamic model.
8	National Oceanographic and Atmospheric Administration-Center for Operational Oceanographic Products and Services (NOAA-COOPS)	San Diego Bay Dana Point Harbor	9410170	1/2001-12/2002	Water column temperature data used in calibration of San Diego bay hydrodynamic model and in determination of lateral ocean boundary conditions for the Dana point harbor hydrodynamic model.
Meteorological data					
9	National Oceanographic and Atmospheric Administration-National Climatic Data Center (NOAA-NCDC)	San Diego Bay	CA7740	1/1990-5/2004	Hourly rainfall data used for hydrologic and water quality modeling for wet-weather conditions.
		Dana Point Harbor	CA4650		
	San Diego Bay Dana Point Harbor	COOP ID #047740	1/1990-5/2004	Temperature, humidity, wind speed and direction, atmospheric pressure, and cloud cover data used for setting the initial surface conditions of hydrodynamic model.	
10	Automatic Local Evaluation in Real-Time (ALERT) Flood Warning System	San Diego Bay	31	1/1990-5/2004	Hourly rainfall data used for hydrologic and water quality modeling for wet-weather conditions.
11	California Irrigation Management Information System (CIMIS)	San Diego Bay Dana Point Harbor	CIMIS74	1990-2004	Hourly rainfall, evaporation data used for hydrologic and water quality modeling for wet-weather conditions
Bathymetric Data					
12	California Spatial Information Library (CASIL)	San Diego Bay Dana Point Harbor	-	-	Bathymetric data used for hydrodynamic and water quality simulation.

www.usgs.gov

Draft Technical Report (Appendix D – Data Sources)
 TMDLs for Indicator Bacteria
 Baby Beach and Shelter Island Shoreline Park

Table D-2. GIS Data Sources

Index	Data Type	Data Source	Years Compiled	Purpose
13	Storm Drain network	City of San Diego, City of Chula Vista, City of Coronado	-	To derive streams and watershed boundaries
14	Land Use	San Diego's Regional Planning Agency (SANDAG)	2001	Designation of Land uses in the region.
		Southern California Association of Governments (SCAG)	2000	
15	Soils	USDA-NRCS (STATSGO)	1994	STATSGO soil data used for watershed modeling.
16	Topographic and digital elevation models (DEMs)	USEPA BASINS, USGS ¹	-	To derive streams and watershed boundaries.

¹www.usgs.gov

Appendix E

Review of Shoreline Bacteria Data

Table E-1. Percent Exceedances of Single Sample and 30-day Water Quality Objectives at Sampling Locations in San Diego Bay

Location	Indicator Bacteria	Percent Exceedance of Single Sample WQOs	Percent Exceedance of 30-day WQOs
Shelter Island Shoreline Park	<i>Enterococcus</i>	26	57
	Fecal Coliform	13	0
	Total Coliform	21	51

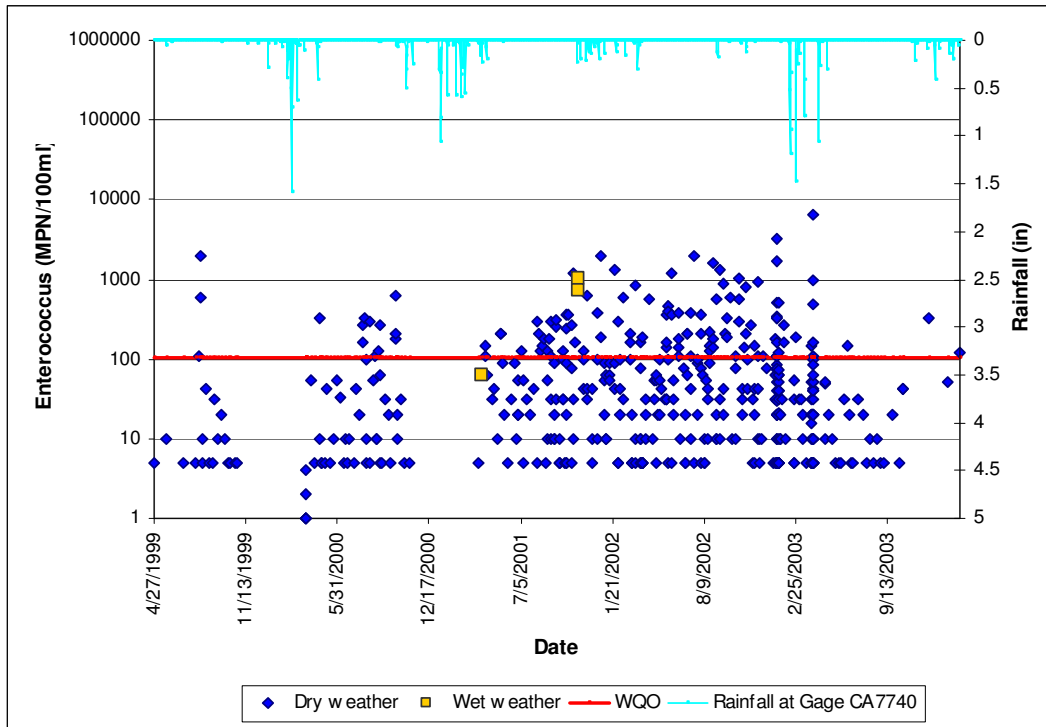

Figure E-1. *Enterococcus* Densities at Shelter Island Shoreline Park

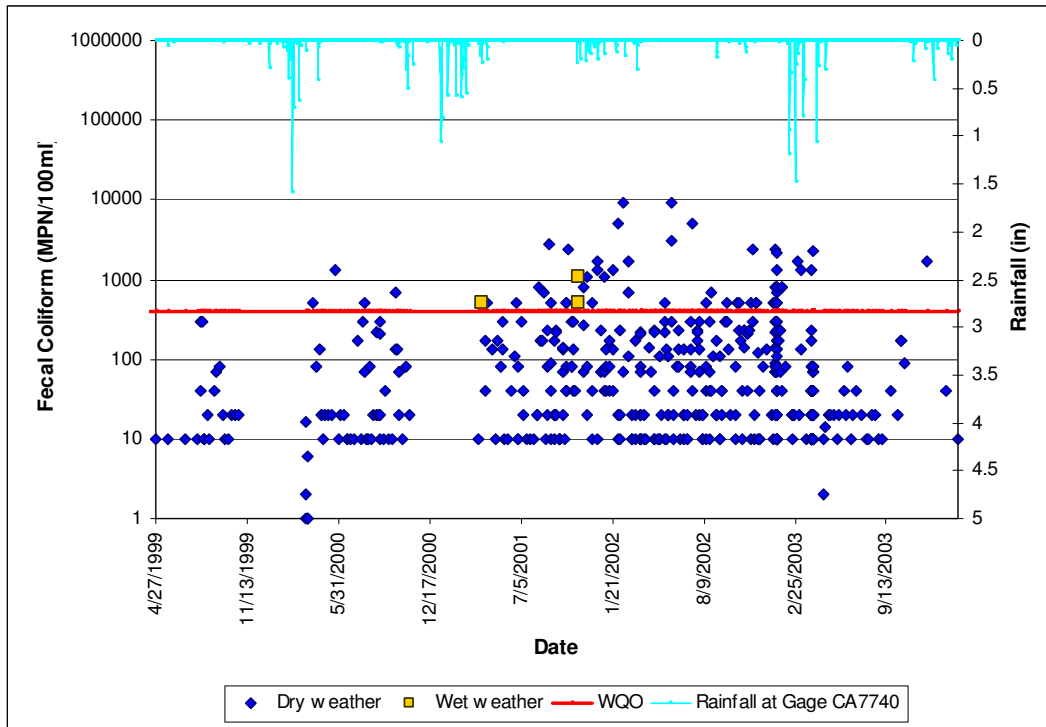

Figure E-2. Fecal Coliform Densities at Shelter Island Shoreline Park

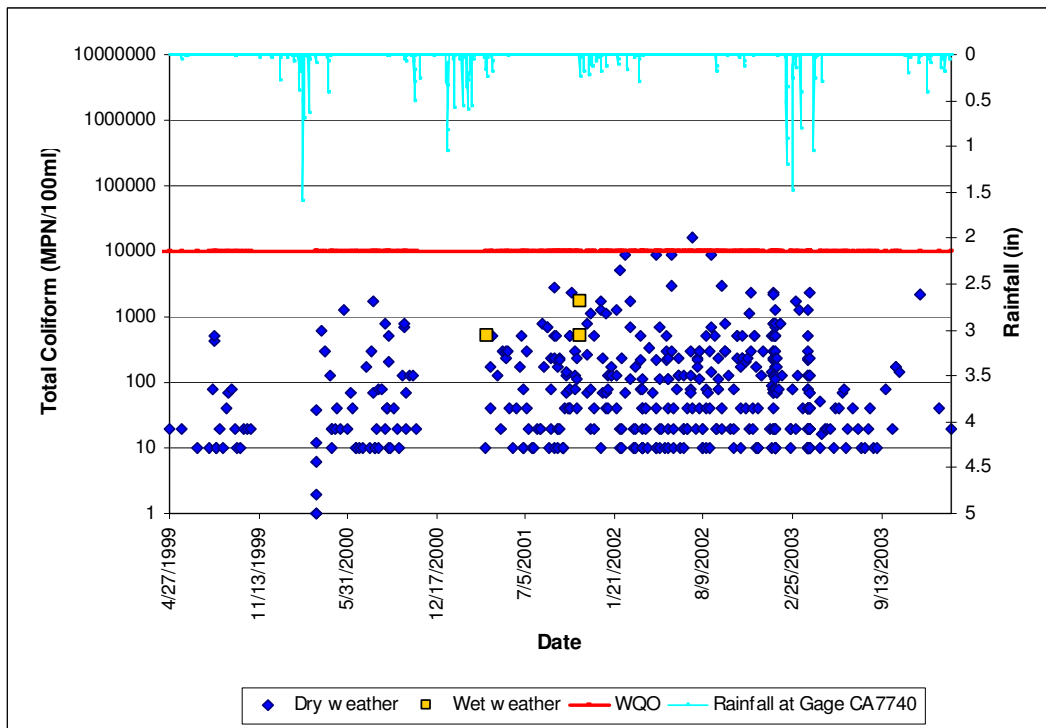

Figure E-3. Total Coliform Densities at Shelter Island Shoreline Park

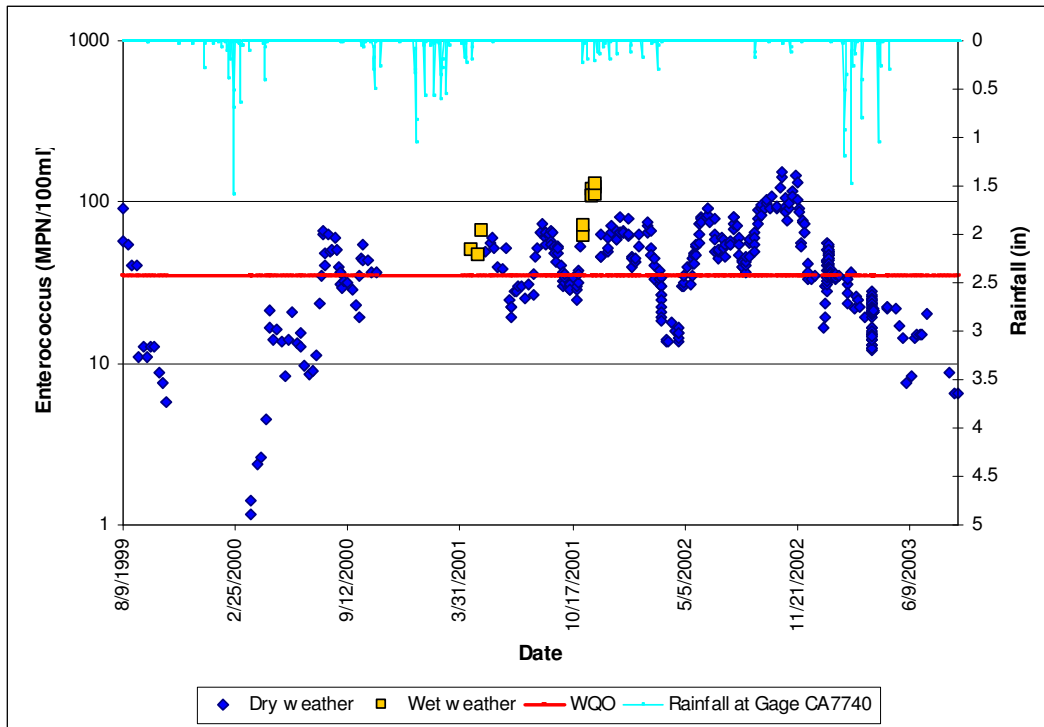

Figure E-4. 30-day Geometric Mean Densities of *Enterococcus* at Shelter Island Shoreline Park

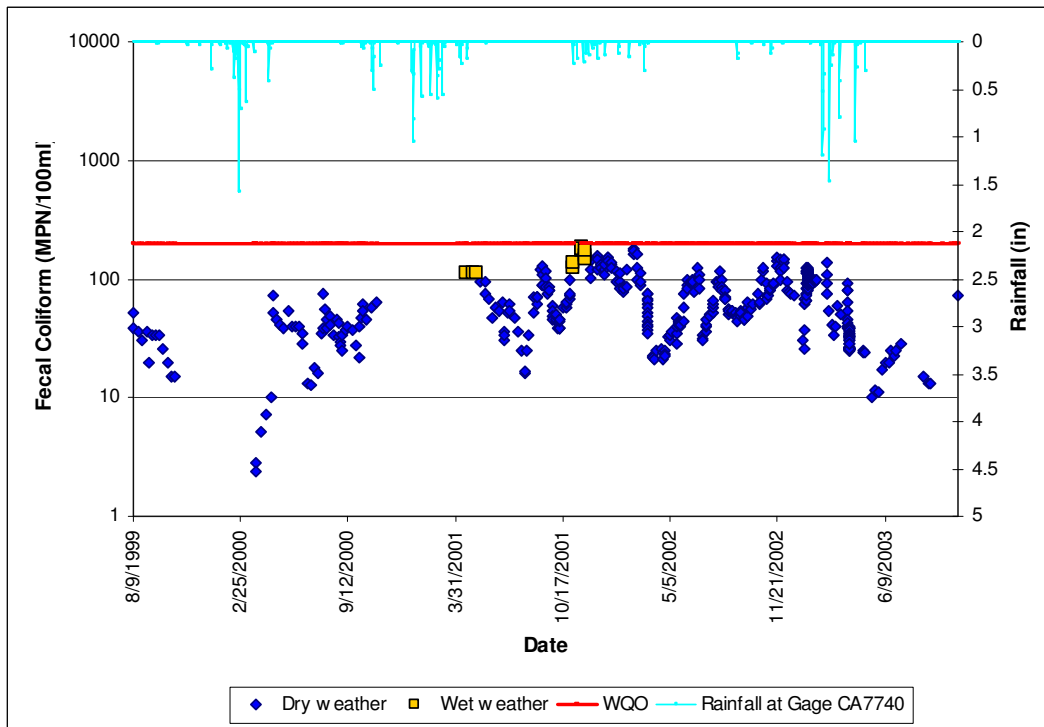

Figure E-5. 30-day Geometric Mean Densities of Fecal Coliform at Shelter Island Shoreline Park

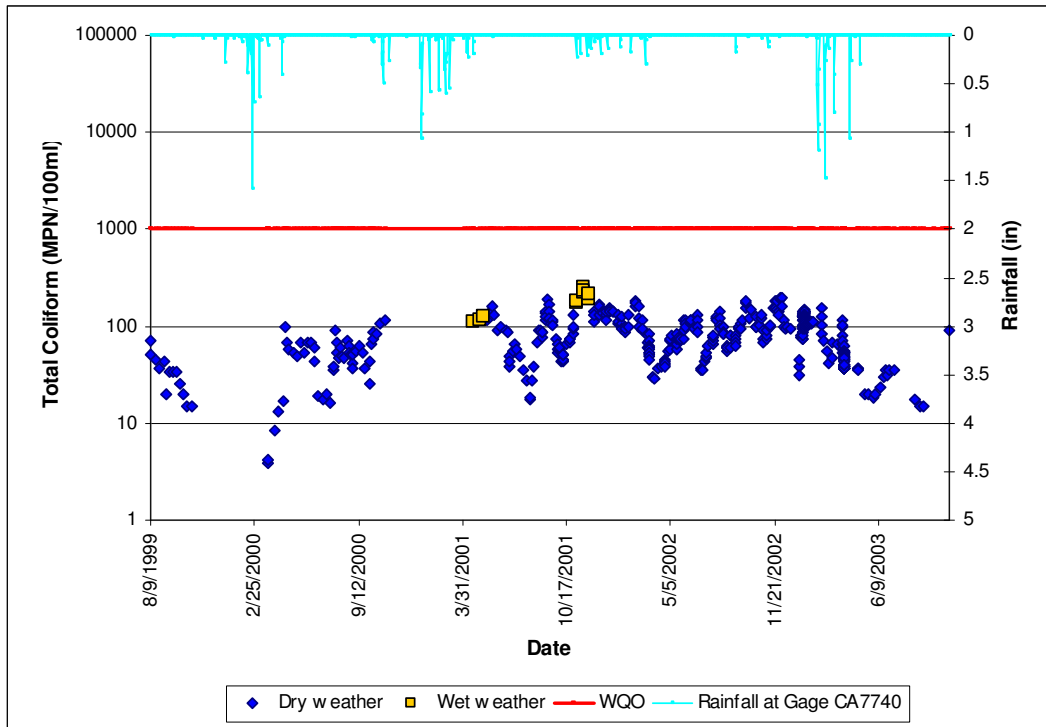

Figure E-6. 30-day Median Densities of Total Coliform at Shelter Island Shoreline Park

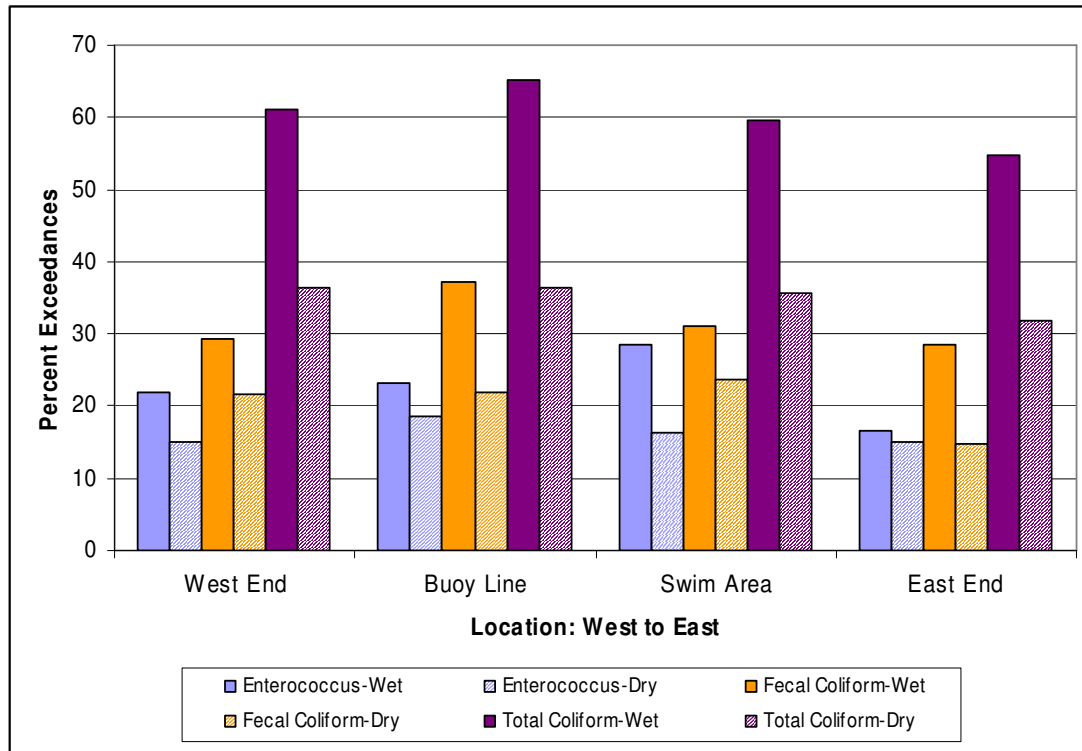

Figure E-7. Percent Exceedances of Single Sample Objectives During Wet and Dry Weather at Baby Beach Locations

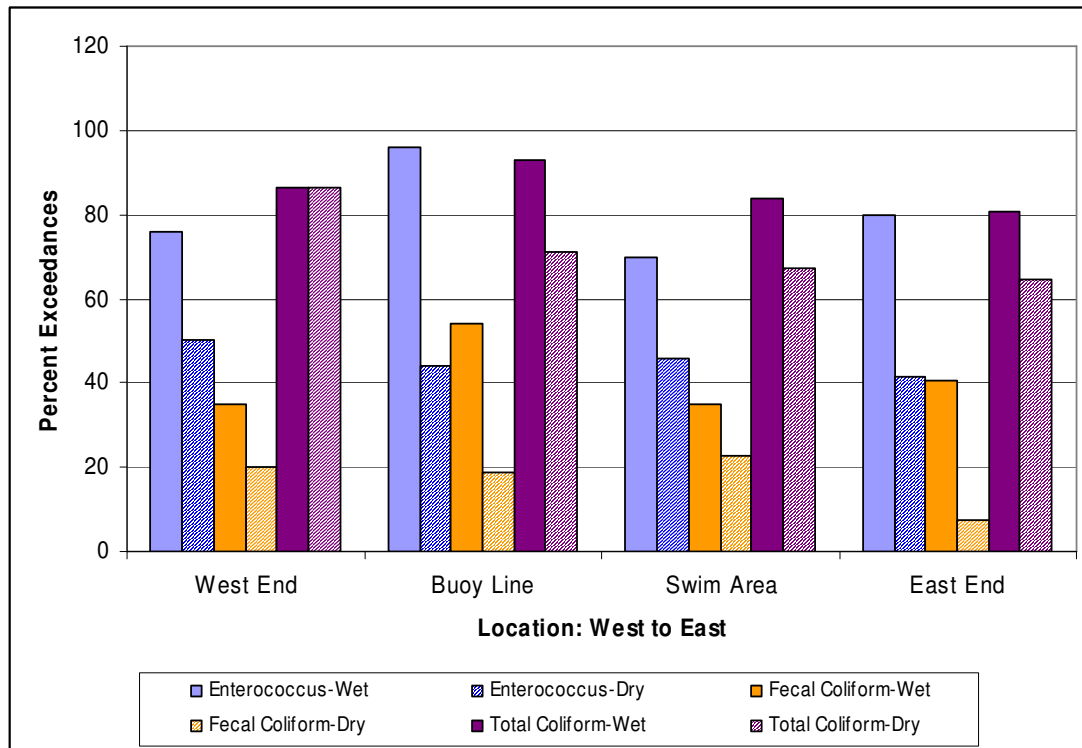

Figure E-8. Percent Exceedances of the 30-day Objectives During Wet and Dry Weather at Baby Beach Locations

Table E-2. Percent Exceedances of the Single Sample Objectives Relative to Weather at Baby Beach Locations at Dana Point Harbor

Location	Indicator Bacteria	Percent Total Exceedances	Percent Wet Period Samples in Exceedance	Percent Dry Period Samples in Exceedance
Baby Beach West End	<i>Enterococcus</i>	26	22	15
	Fecal Coliform	23	29	22
	Total Coliform	40	61	36
Baby Beach Buoy Line	<i>Enterococcus</i>	32	23	19
	Fecal Coliform	24	37	22
	Total Coliform	40	65	36
Baby Beach Swim Area	<i>Enterococcus</i>	30	29	16
	Fecal Coliform	25	31	24
	Total Coliform	39	60	36
Baby Beach East End	<i>Enterococcus</i>	25	17	15
	Fecal Coliform	17	29	15
	Total Coliform	10	55	32

Table E-3. Percent Exceedances of the 30-day Water Quality Objectives Relative to Weather at Baby Beach Locations at Dana Point Harbor

Location	Indicator Bacteria	Percent Total Exceedances	Percent Wet Period Samples in Exceedance	Percent Dry Period Samples in Exceedance
Baby Beach West End	<i>Enterococcus</i>	28	76	50
	Fecal Coliform	25	35	20
	Total Coliform	87	87	87
Baby Beach Buoy Line	<i>Enterococcus</i>	55	96	44
	Fecal Coliform	29	54	19
	Total Coliform	79	93	71
Baby Beach Swim Area	<i>Enterococcus</i>	53	70	46
	Fecal Coliform	27	35	23
	Total Coliform	73	84	67
Baby Beach East End	<i>Enterococcus</i>	60	80	42
	Fecal Coliform	18	40	7
	Total Coliform	70	81	65

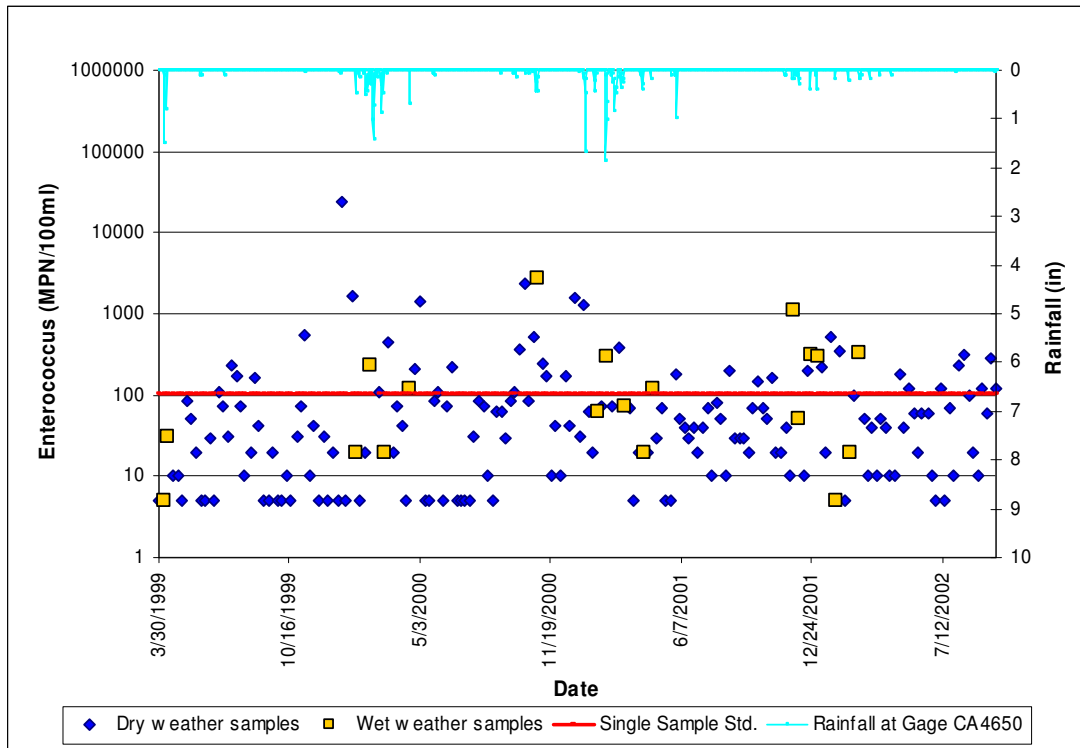

Figure E-9. *Enterococcus* Densities at Baby Beach-West End

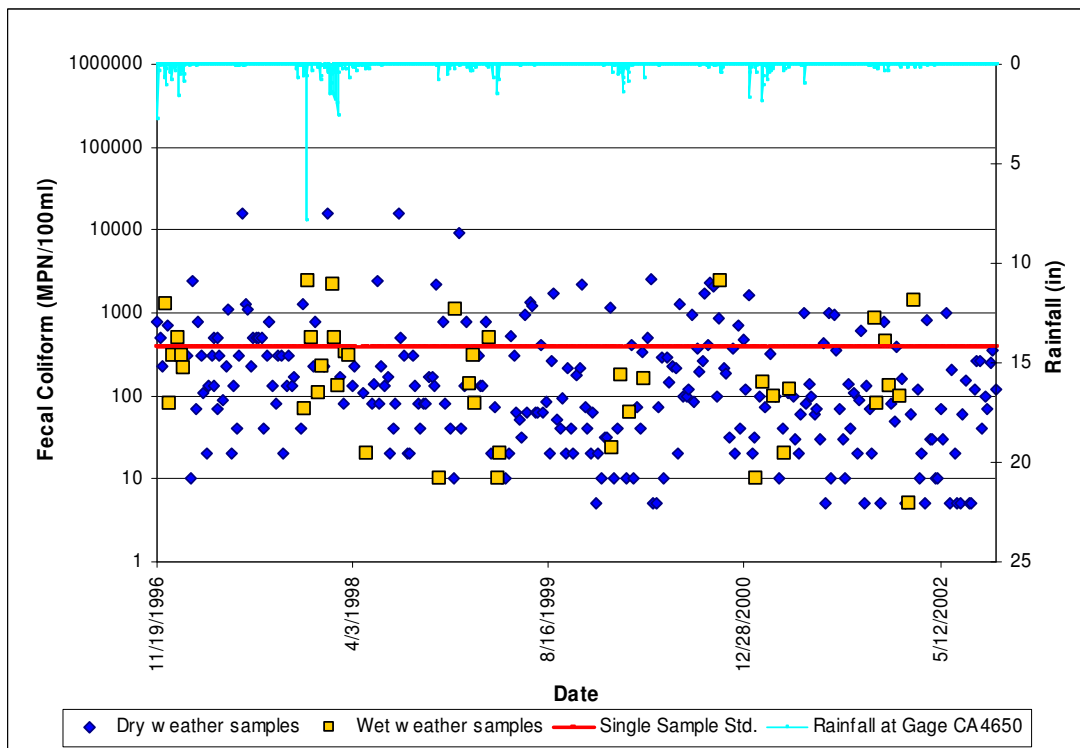

Figure E-10. Fecal Coliform Densities at Baby Beach-West End

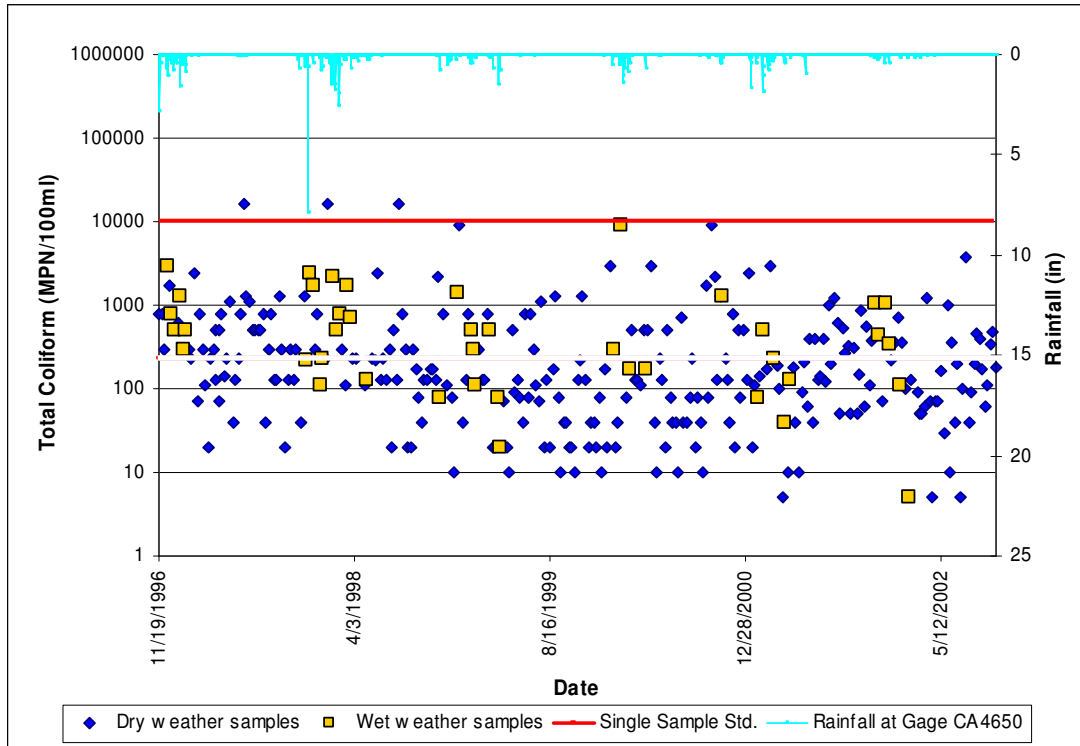

Figure E-11. Total Coliform Densities at Baby Beach-West End

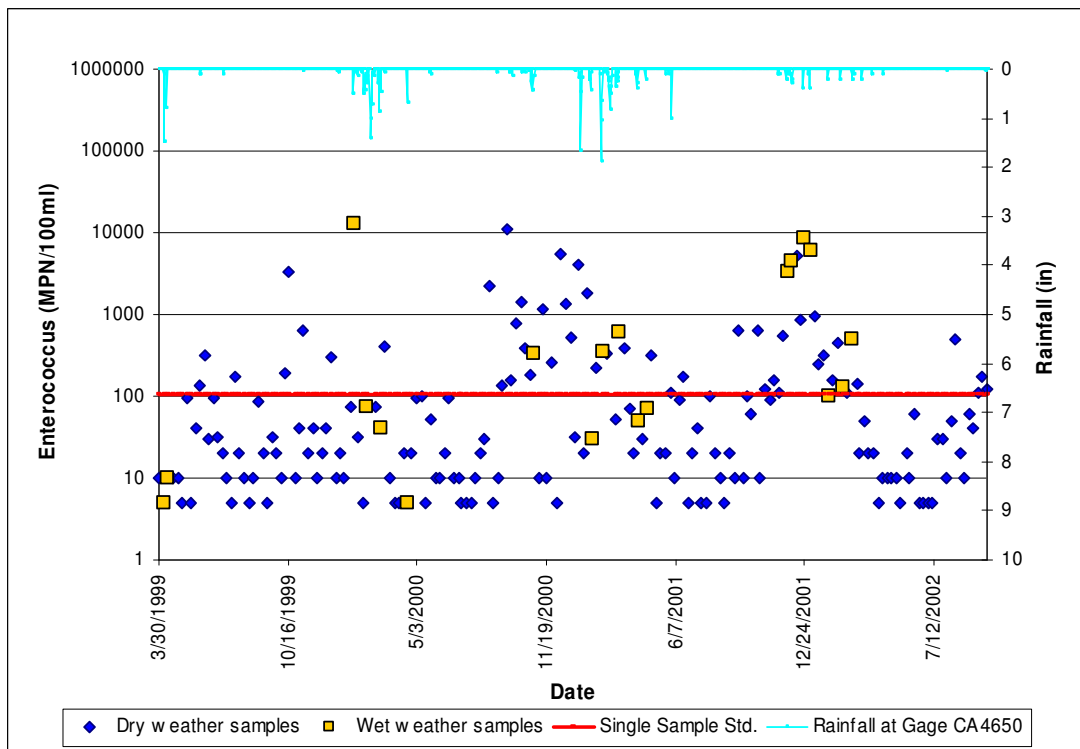

Figure E-12. Enterococcus Densities at Baby Beach-Buoy Line

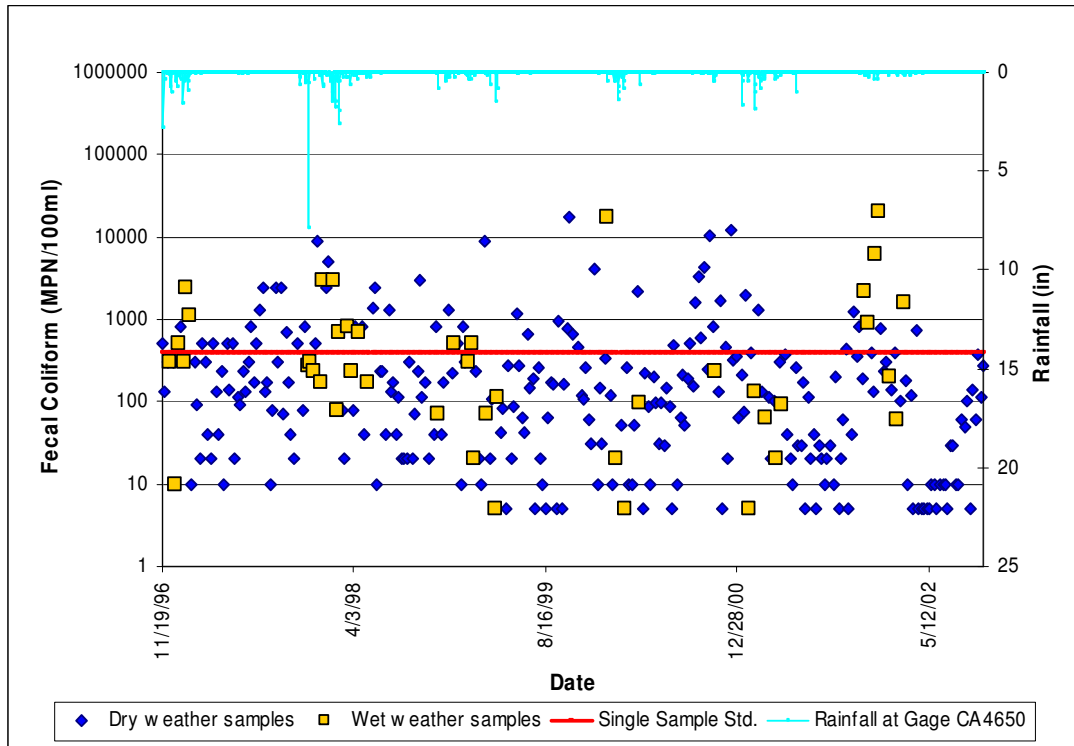

Figure E-13. Fecal Coliform Densities at Baby Beach-Buoy Line

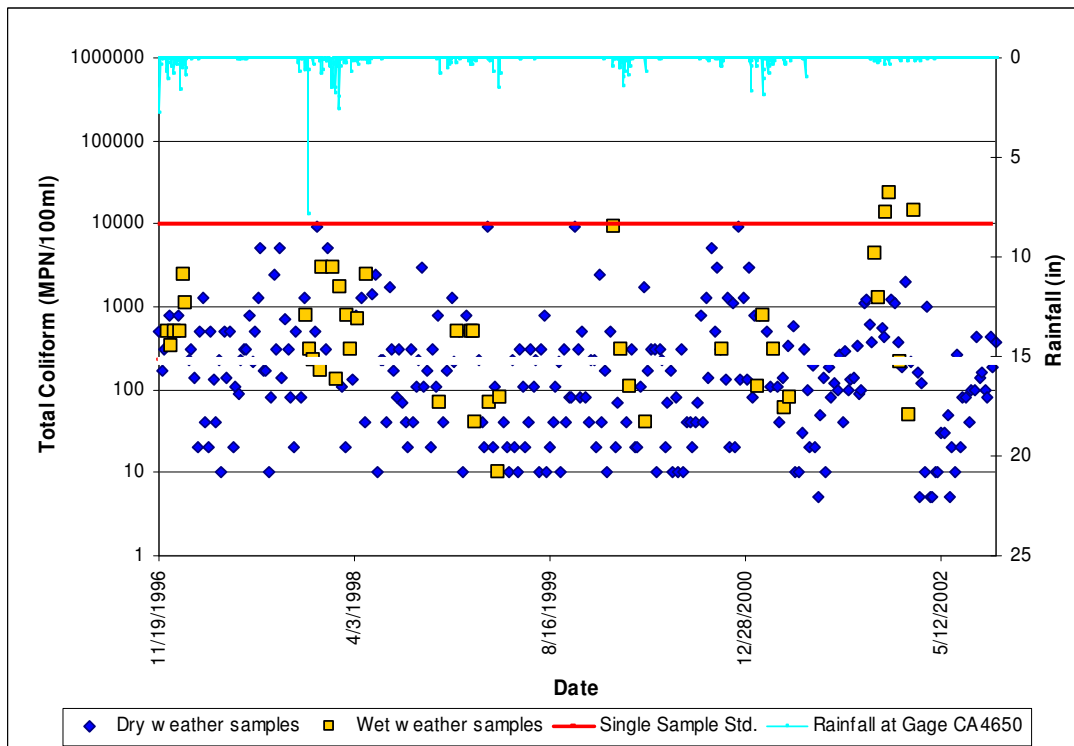

Figure E-14. Total Coliform Densities at Baby Beach-Buoy Line

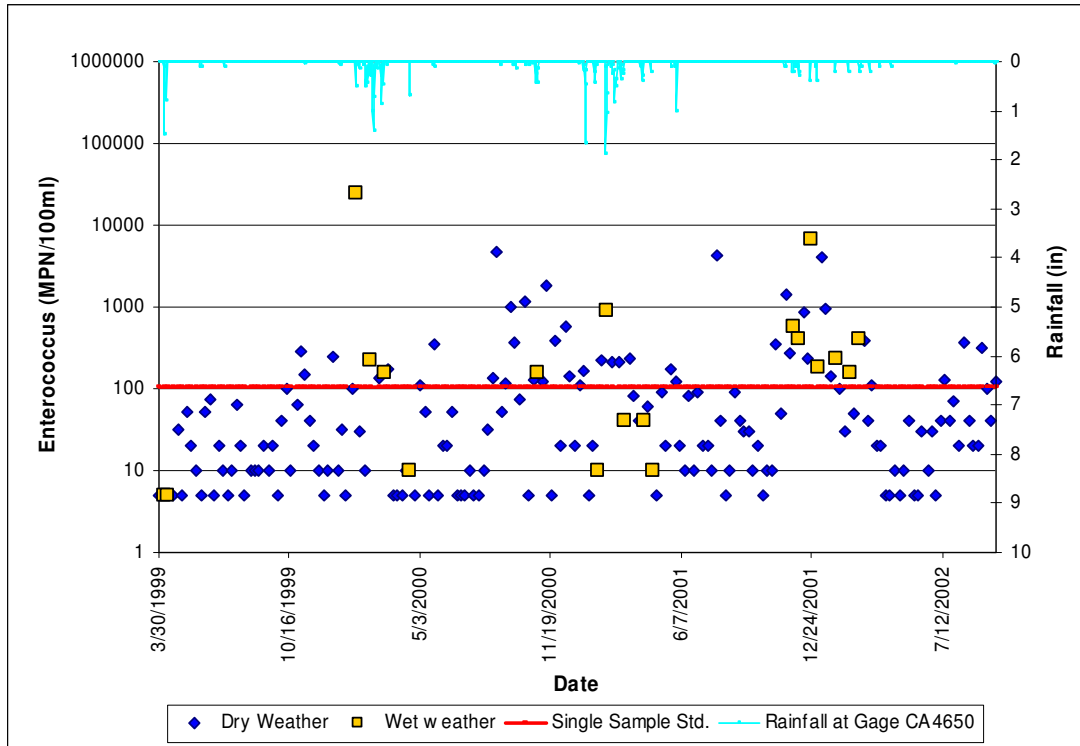

Figure E-15. *Enterococcus* Densities at Baby Beach-Swim Area

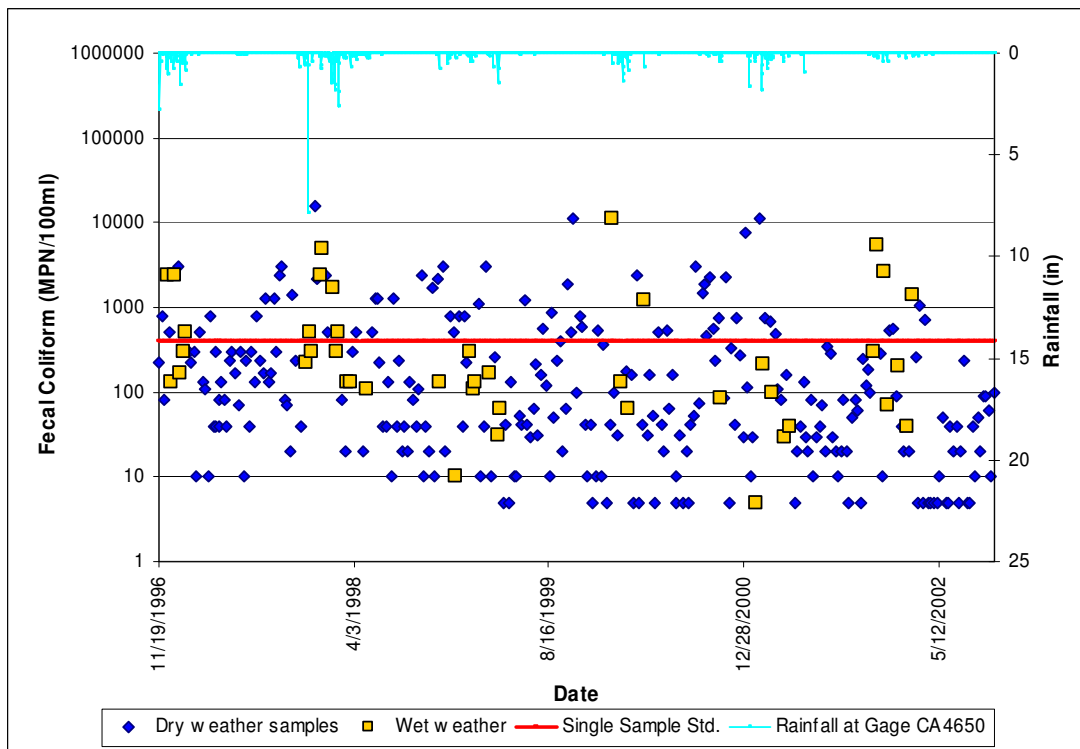

Figure E-16. Fecal Coliform Densities at Baby Beach-Swim Area

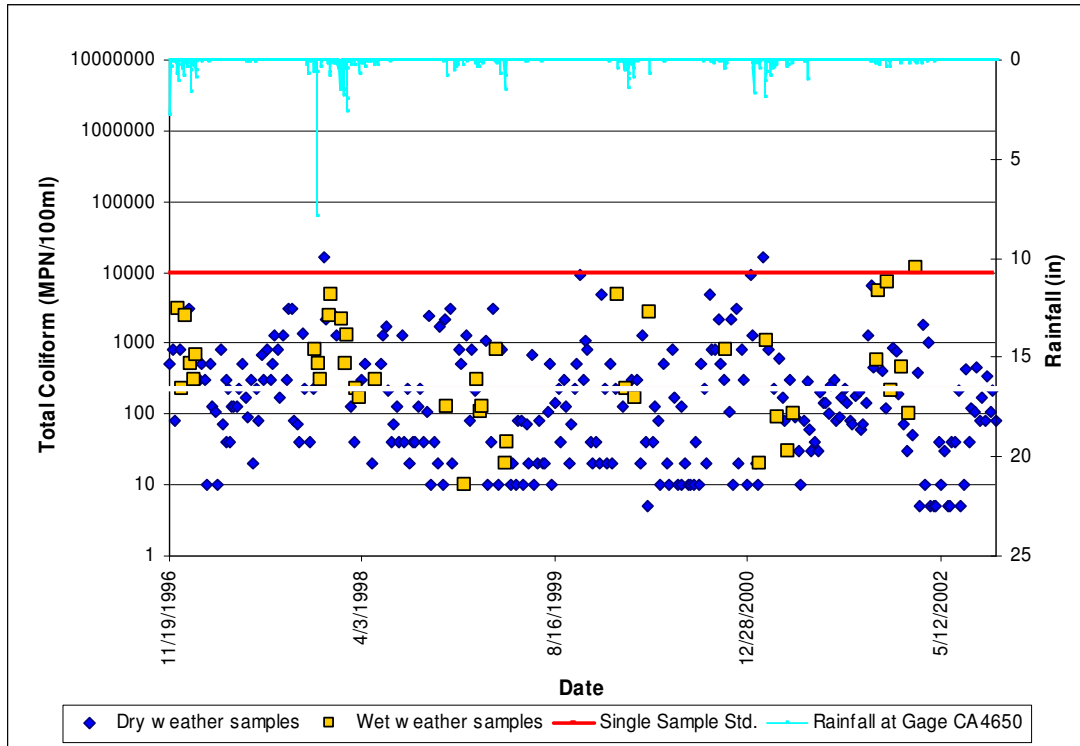

Figure E-17. Total Coliforms Densities at Baby Beach-Swim Area

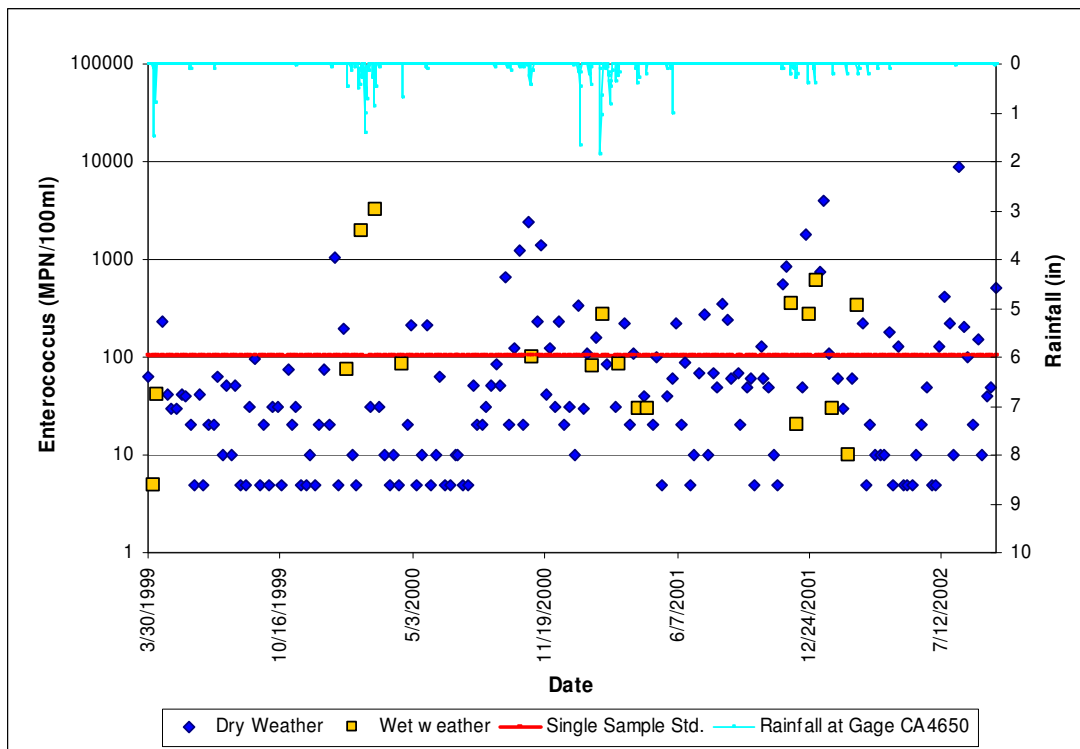

Figure E-18. Enterococcus Densities at Baby Beach-East End

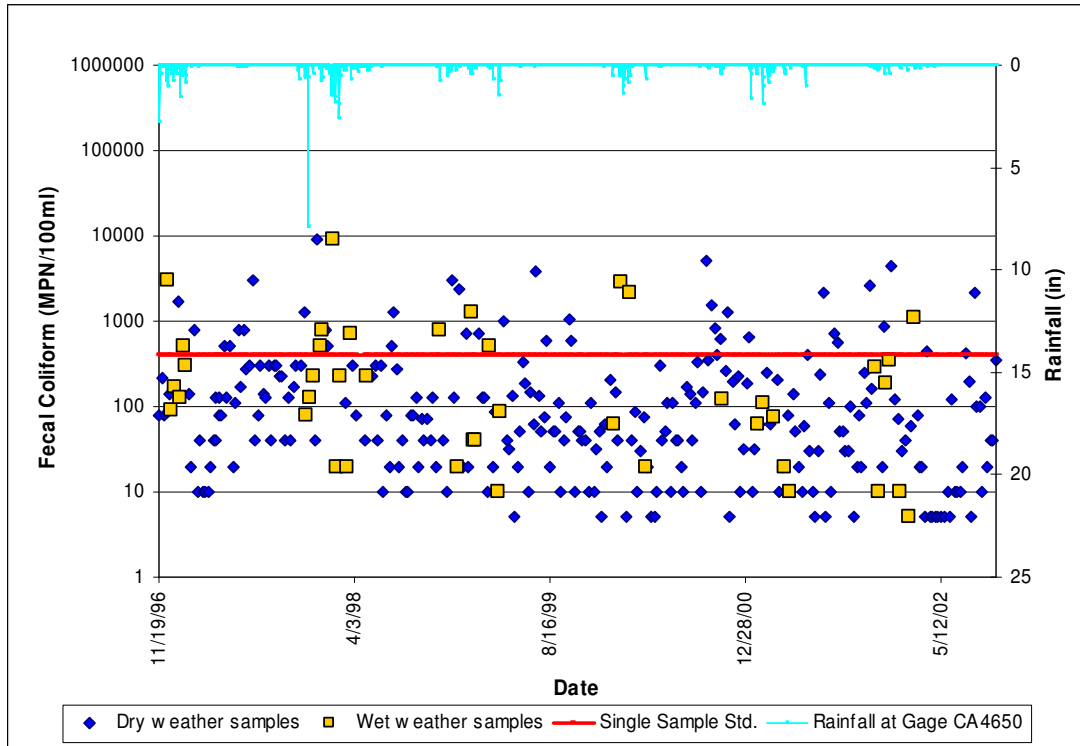

Figure E-19. Fecal Coliform Densities at Baby Beach-East End

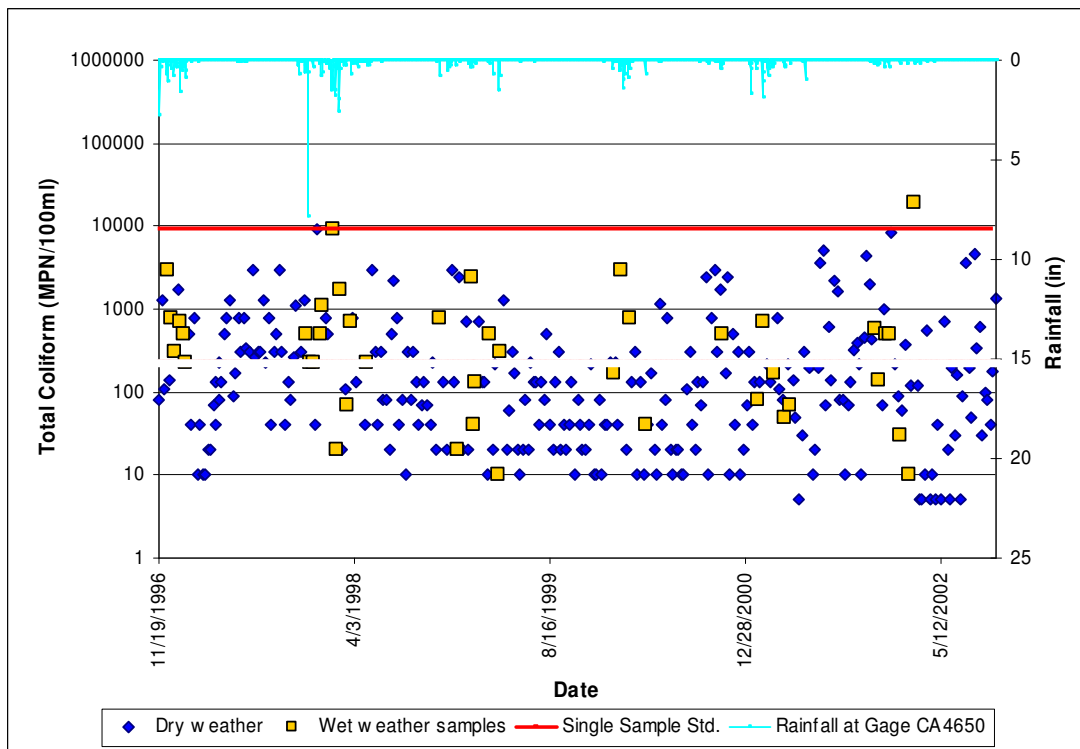

Figure E-20. Total Coliform Densities at Baby Beach-East End

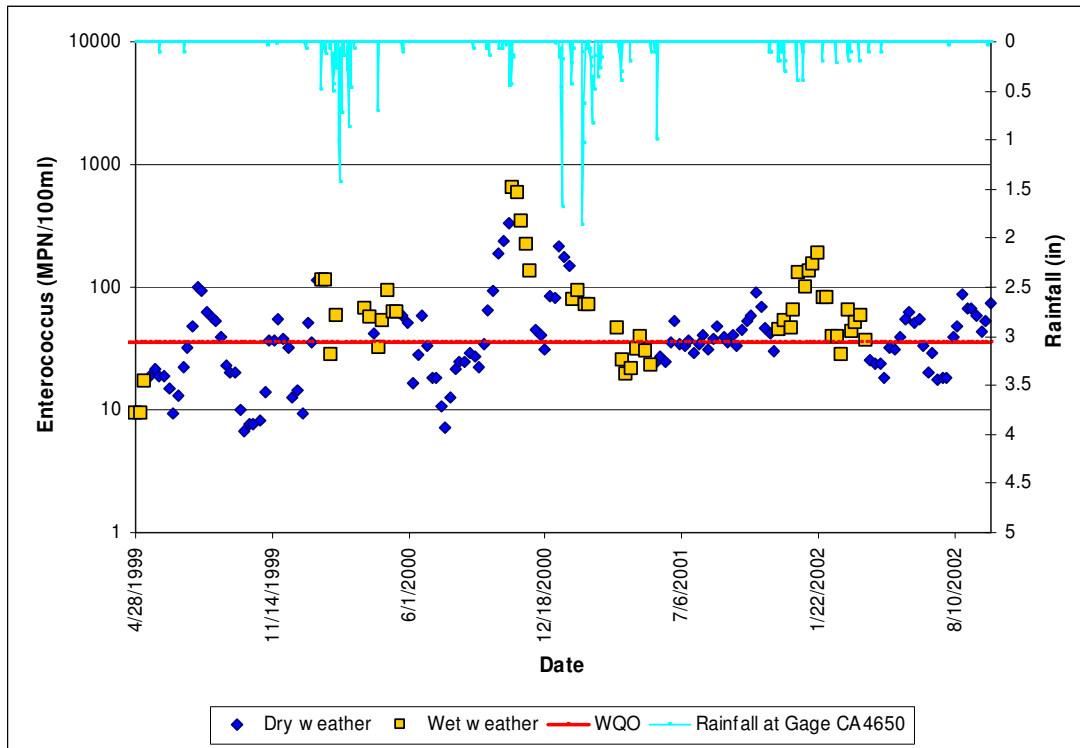

Figure E-21. 30-day Geometric Mean Densities of *Enterococcus* at Baby Beach-West End

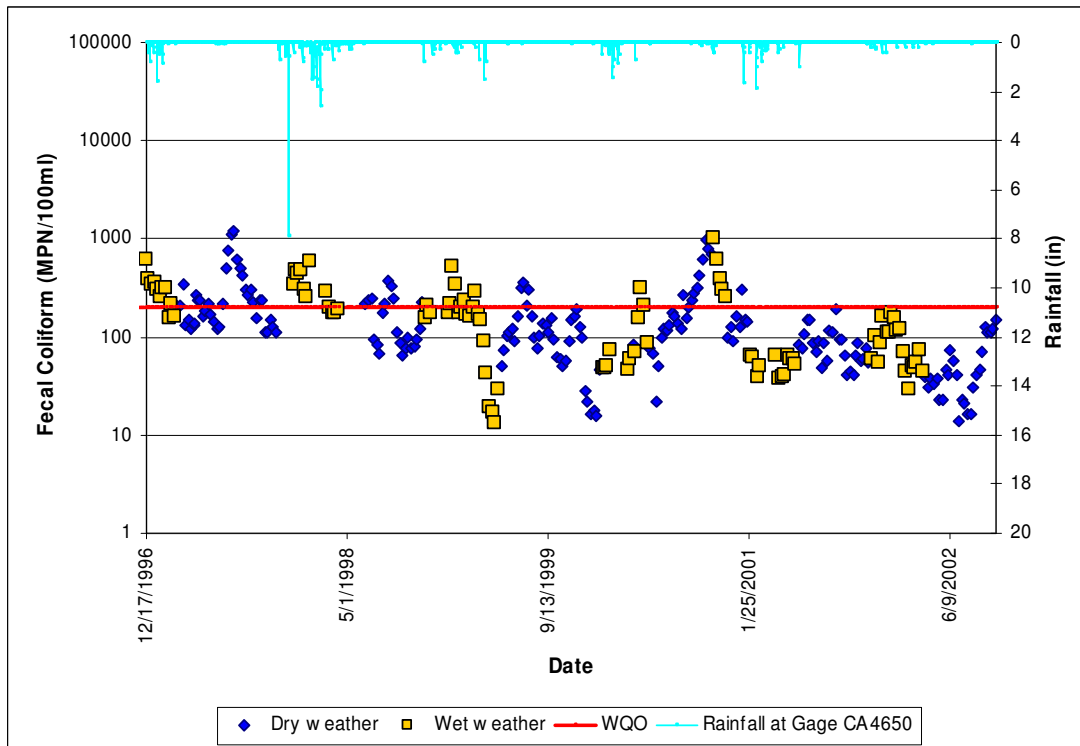

Figure E-22. 30-day Geometric Mean Densities of Fecal Coliform at Baby Beach-West End

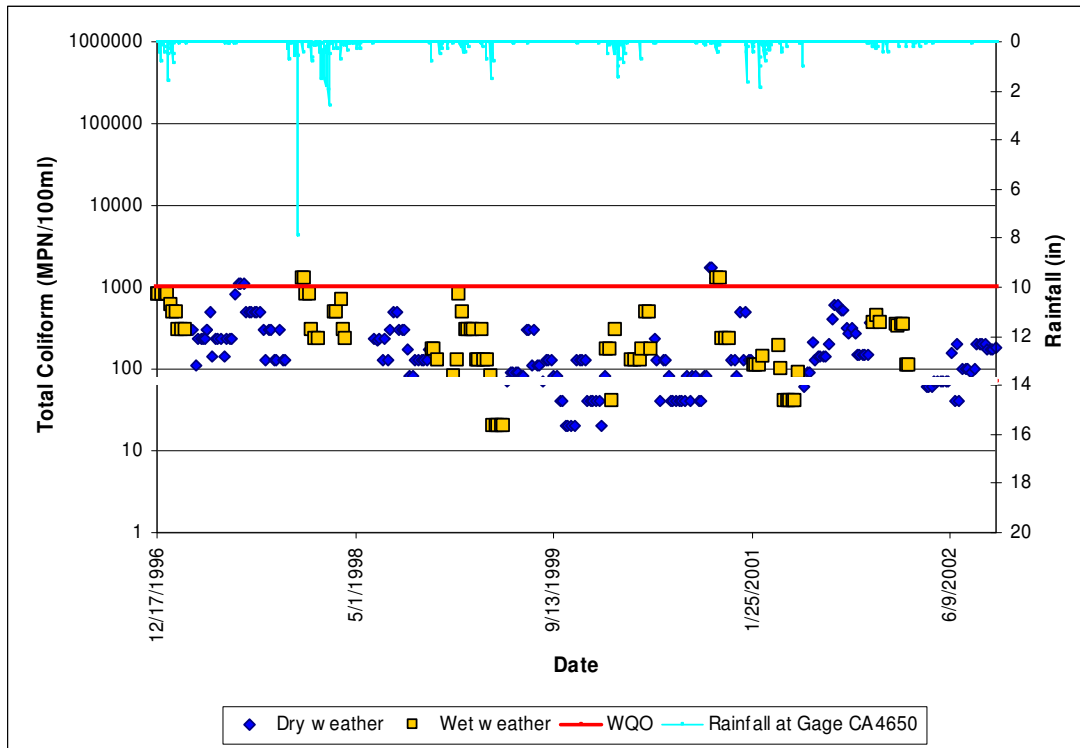

Figure E-23. 30-day Median Densities of Total Coliform at Baby Beach-West End

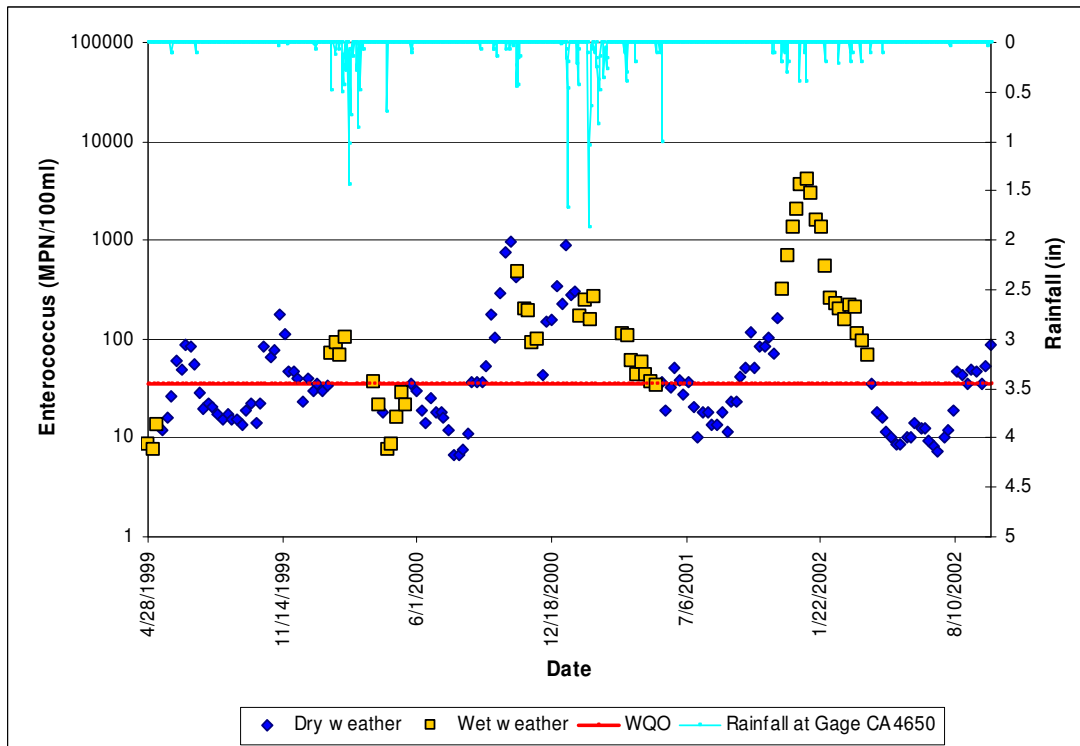

Figure E-24. 30-day Geometric Mean Densities of *Enterococcus* at Baby Beach-Buoy Line

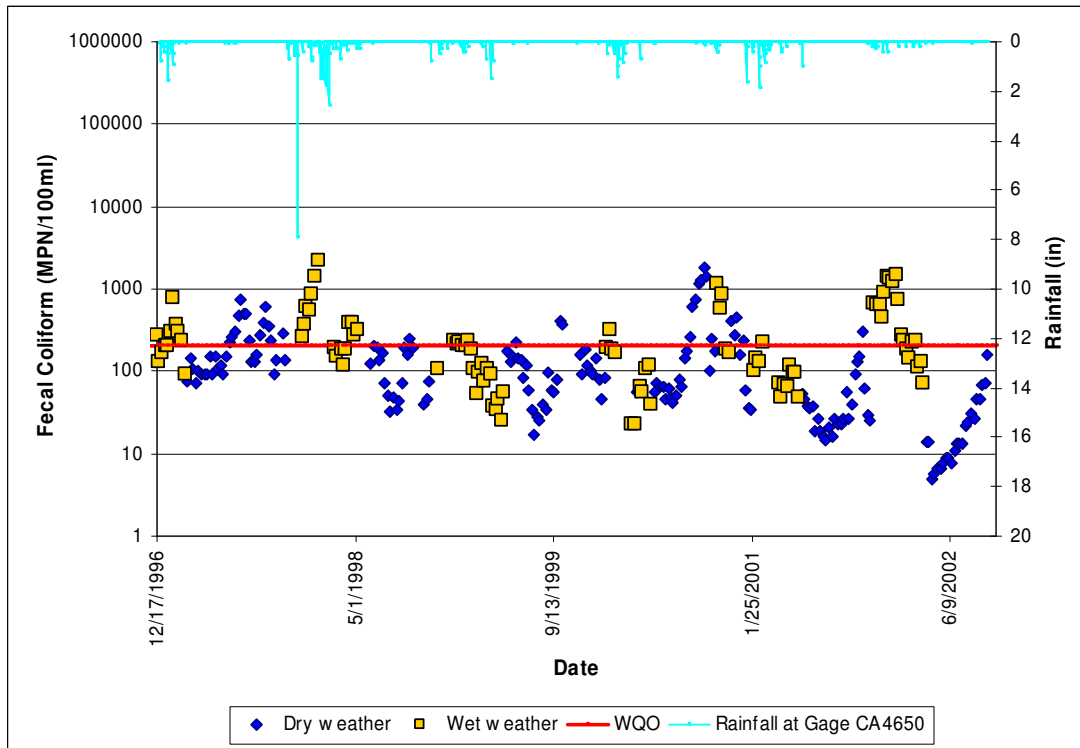

Figure E-25. 30-day Geometric Mean Densities of Fecal Coliforms at Baby Beach- Buoy Line

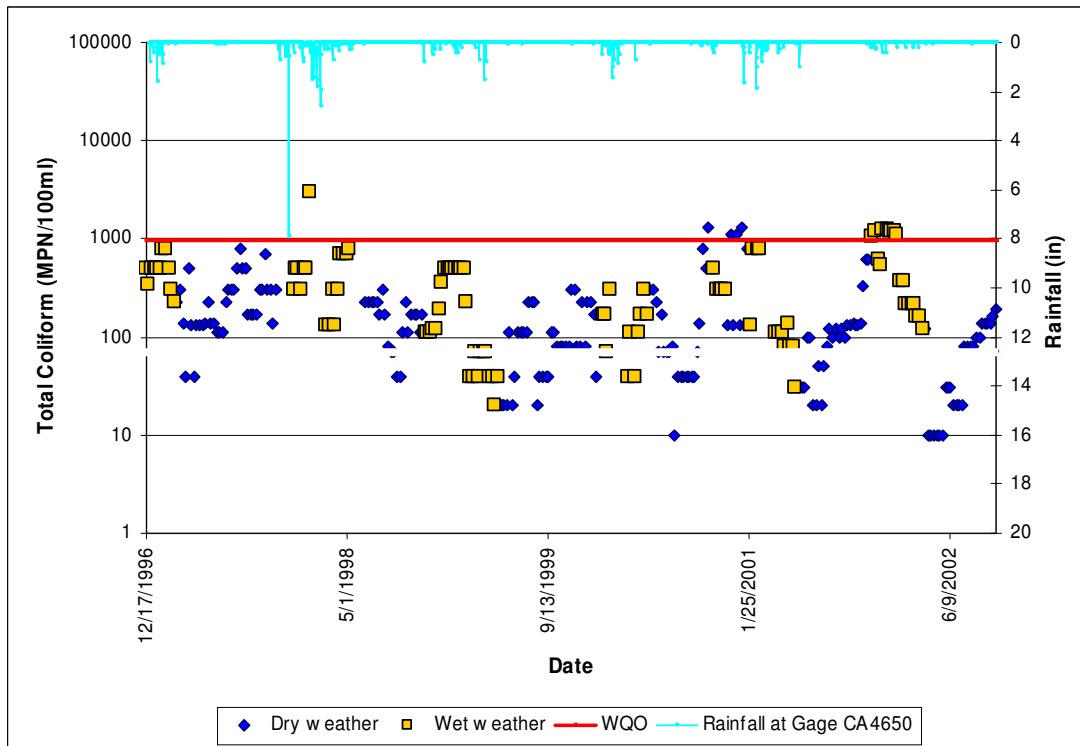

Figure E-26. 30-day Median Densities of Total Coliforms at Baby Beach-Buoy Line

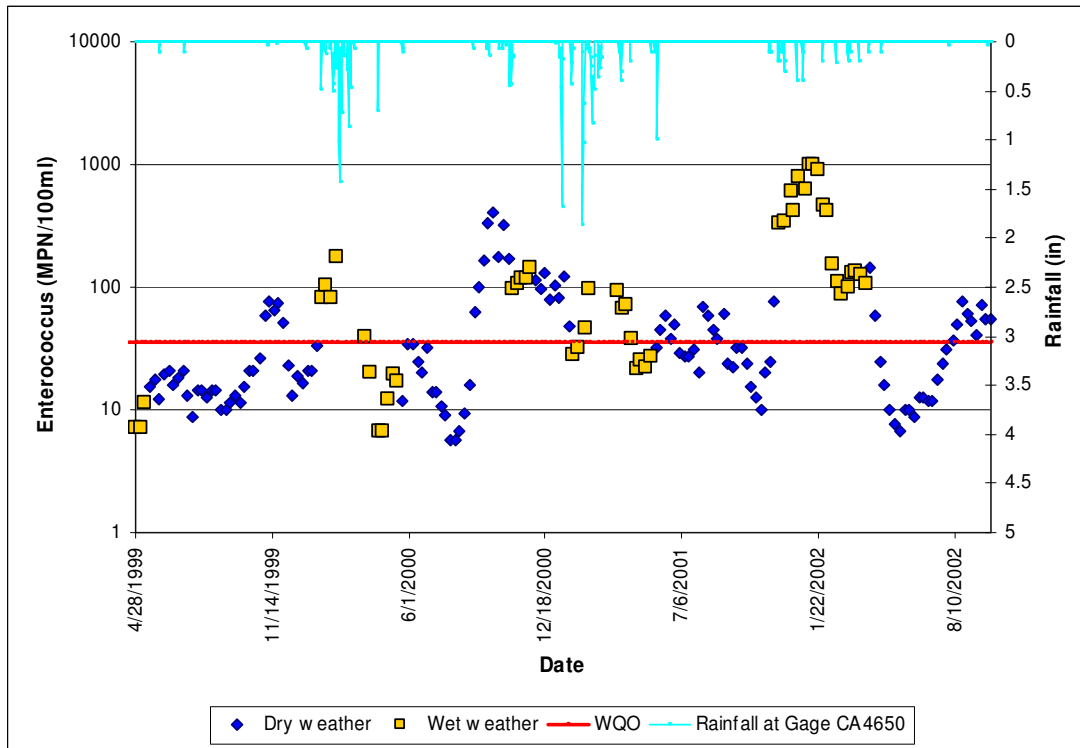

Figure E-27. 30-day Geometric Mean Densities of *Enterococcus* at Baby Beach-Swim Area

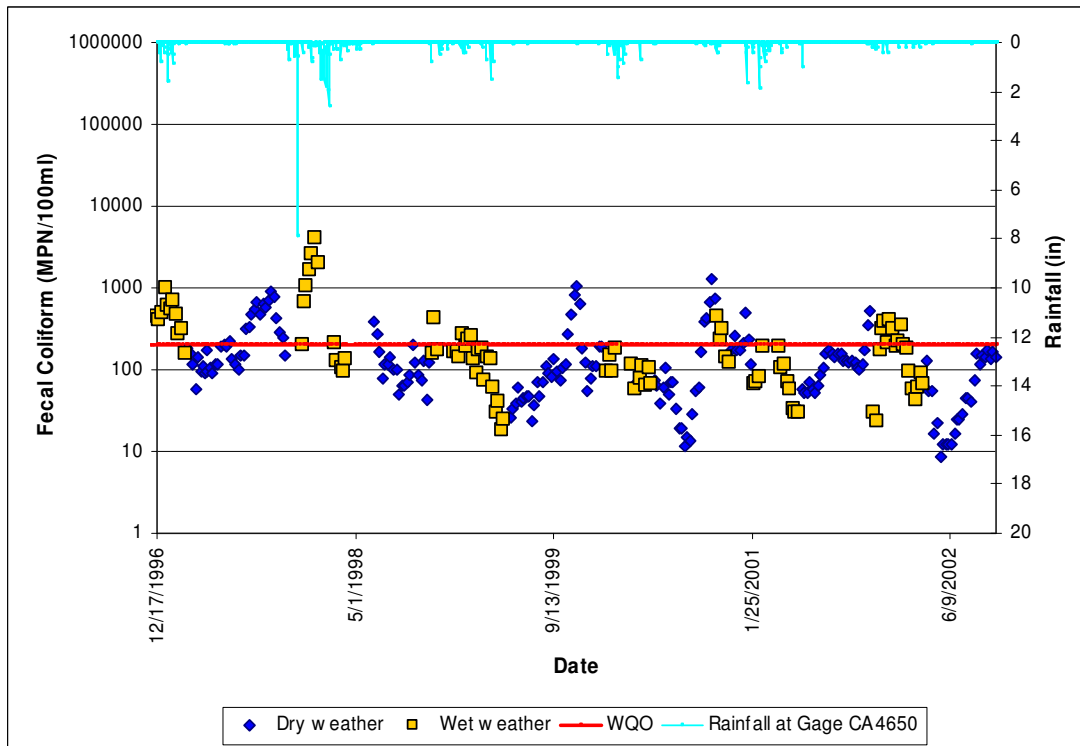

Figure E-28. 30-day Geometric Mean Densities of Fecal Coliforms at Baby Beach-Swim Area

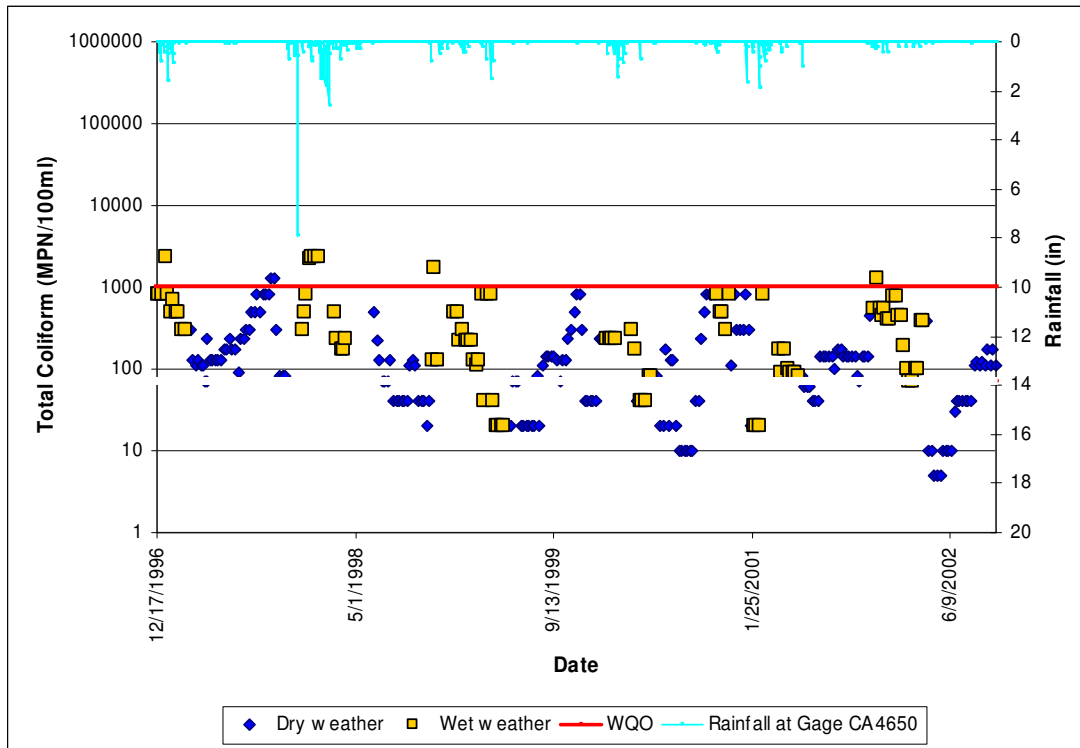

Figure E-29. 30-day Median Densities of Total Coliform at Baby Beach-Swim Area

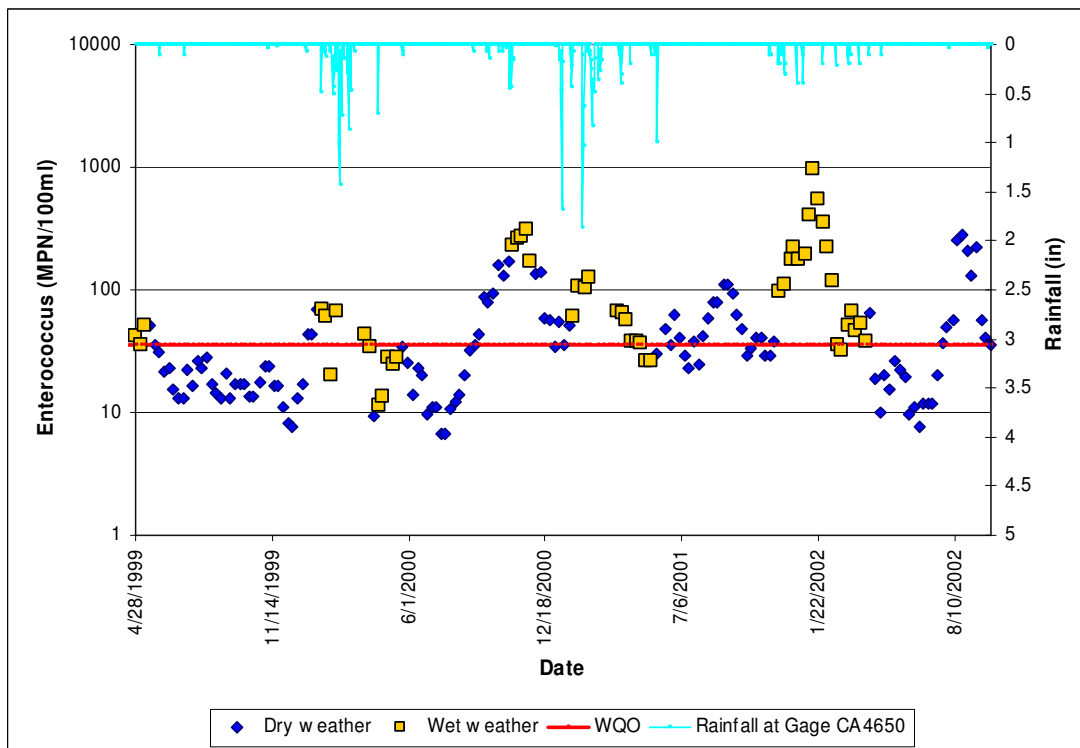

Figure E-30. 30-day Geometric Mean Densities of *Enterococcus* at Baby Beach-East End

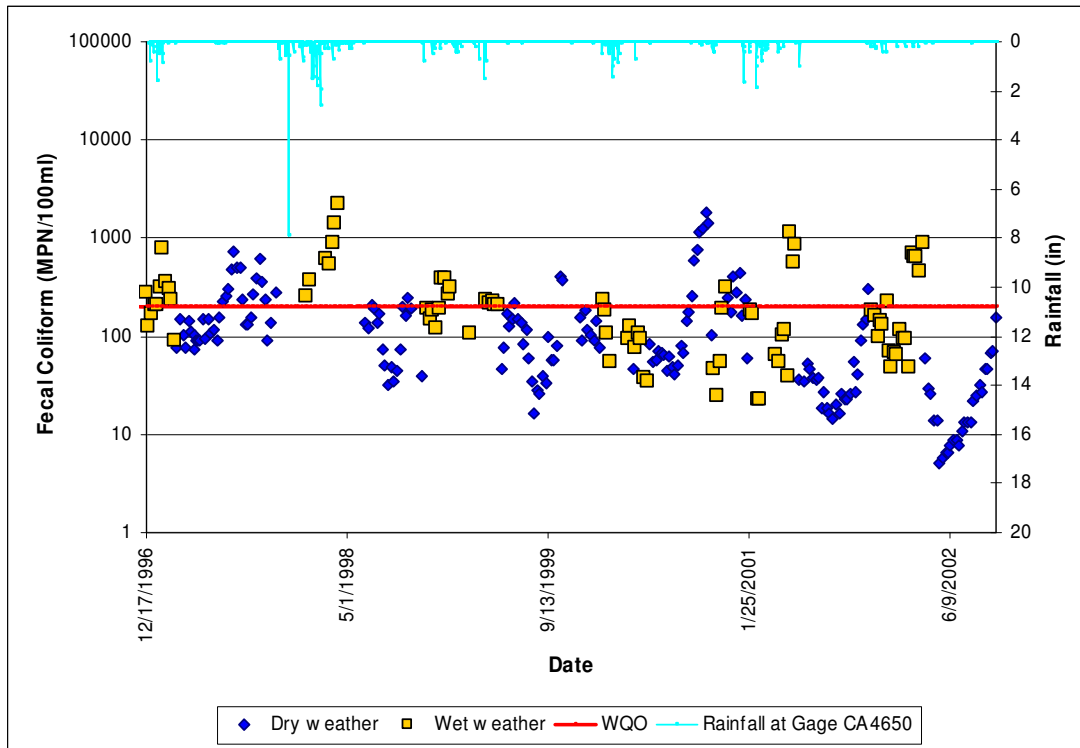

Figure E-31. 30-day Geometric Mean Densities of Fecal Coliform at Baby Beach-East End

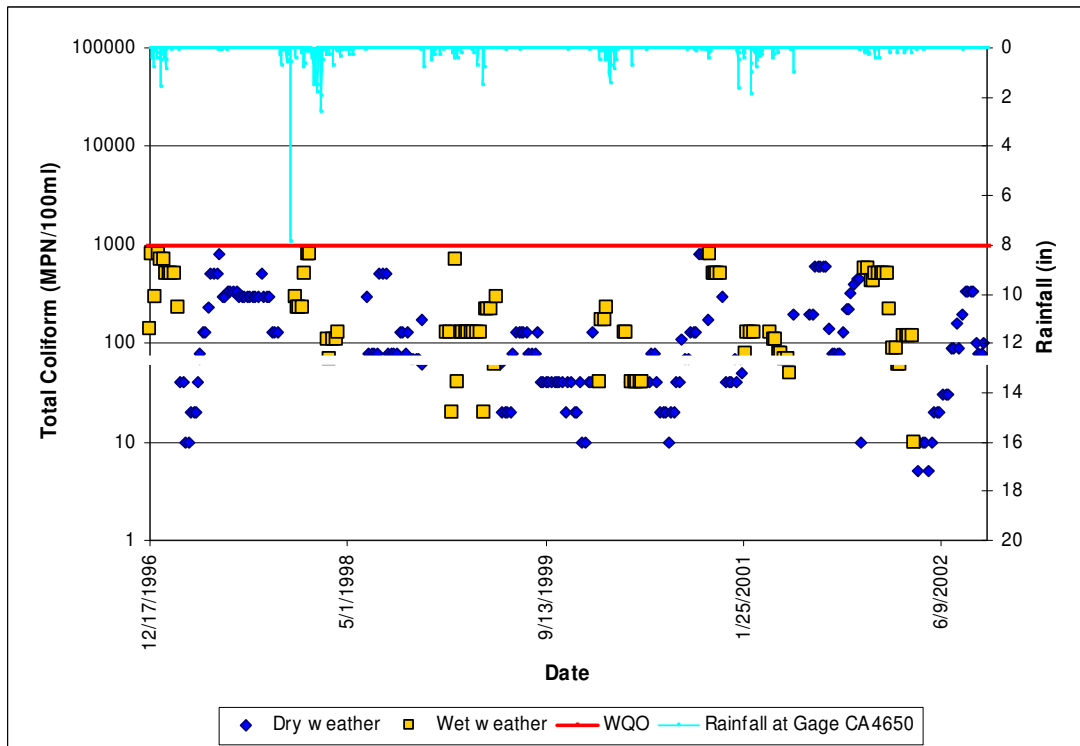

Figure E-32. 30-day Median Densities of Total Coliform at Baby Beach-East End

Appendix F

Wet Weather and Dry Weather Model Configuration, Calibration, and Validation

Appendix F Table of Contents

F	Introduction	2
F.1	Wet Weather Watershed Model – LSPC.....	3
F.1.1	Watershed Segmentation	3
F.1.2	Configuration of Key Wet Weather Watershed Model Components	4
F.1.3	Wet Weather Watershed Model Calibration and Validation	8
F.2	Dry Weather Watershed Model.....	10
F.2.1	Dry Weather Watershed Model Configuration	11
F.2.2	Estimation of Dry Weather Runoff	13
F.2.3	Estimation of Bacteria Densities	16
F.2.4	Dry Weather Watershed Model Calibration and Validation.....	21
F.3	Wet and Dry Weather Receiving Water Model– EFDC	27
F.3.1	Coarse Grid Receiving Water Model for the San Diego Bay.....	29
F.3.2	Fine Grid Receiving Water Model for Shelter Island Shoreline Park.....	33
F.3.3	Dana Point Harbor Receiving Water Model	38
F.4	Application of the Watershed and Receiving Water Models	42

F Introduction

Bacteria loading to bay and harbor beaches are generally associated with three main sources, which are described below:

- (1) **Upstream watershed area.** Bacteria accumulate on the land surface at different rates. These rates vary considerably and are dependent on the activities associated with a land use.
- (2) **Near-shore area.** Bacteria may also accumulate on the land surface immediately surrounding a receiving waterbody. These near-shore areas can support bird populations, whose feces contain large quantities of bacteria that build up on the land surface.
- (3) **Direct sources.** Sources within the shoreline waters may contribute bacteria. These sources may include bird populations that deposit feces directly into the water, terrestrial and aquatic wildlife, and other sources within the waters.

During precipitation events and through dry weather transport mechanisms, bacteria loads from the watershed and near-shore areas are delivered to receiving waterbodies through stream networks and stormwater collection systems. Often, watershed-based bacteria sources are associated with land use-specific accumulation rates. There is often a correlation between sources of bacteria and specific land use types. Specific land use types may have higher relative accumulation rates of bacteria, or may be more likely to deliver bacteria to water bodies through stormwater collection systems. Near-shore contributions and direct deposition typically can be linked to the bird population and their dropping rates.

In order to assess the linkage between bacteria sources and impaired waters, a modeling system may be utilized to simulate the build-up and wash-off of bacteria and the hydrologic, hydraulic and hydrodynamic processes that affect delivery to and response of the receiving waters. Understanding and modeling of these processes provides the necessary decision support for TMDL development and allocation of loads to sources.

TMDL calculations were based on comprehensive wet and dry weather modeling systems, which linked watershed hydrology, receiving water hydrodynamics, and their pollutant loading characteristics. The Loading Simulation Program C++ (LSPC) (Shen et al., 2004; USEPA, 2003a) was applied to simulate watershed hydrology and pollutant loading during wet weather conditions. LSPC is a recoded C++ version of the USEPA's Hydrological Simulation Program-FORTRAN (HSPF) that relies on fundamental (and USEPA-approved) algorithms. A steady-state spreadsheet model was developed to simulate these processes during dry weather conditions. The Environmental Fluid Dynamic Code (EFDC) (Hamrick, 1992 and 1996) was used to simulate the complex flow and pollutant transport patterns in the bays during both wet and dry weather.

The watershed component of this TMDL (wet weather and dry weather) is a direct application of the regionally calibrated models from the *Total Maximum Daily Loads for Indicator Bacteria Project I – Beaches and Creeks in the San Diego Region* (hereafter referred to as Bacteria TMDL Project I) (SDRWQCB, 2005). The EFDC hydrodynamic model incorporates flow and loading from the watershed and subsequently determines their impact on the impaired shorelines as the pollutants are transported through the bays. This document describes the modeling methodologies employed during the development of bacteria TMDLs for the impaired shorelines of San Diego Bay (SDB) and Dana Point Harbor (DPH) (see Appendix J for maps of the areas modeled). Specifically, Section F.1 describes the LSPC wet weather watershed model, Section F.2 describes the dry weather steady-state model of the watershed, and Section F.3 provides details on the wet and dry weather EFDC model. Section F.4 discusses the application and utility of the three individual models as well as their collective role in calculation of the current TMDL and potential future functionality.

F.1 Wet Weather Watershed Model – LSPC

In the present study, an LSPC model was configured for the watersheds contributing to impaired shorelines of SDB and DPH (see Appendix J for watershed maps) and was then used to simulate the flow and loading from a watershed, or a series of hydraulically connected subwatersheds, if applicable. Configuration of the model involved subdividing the watersheds into modeling units, followed by continuous simulation of flow and water quality for these units using meteorological, land use, soils, stream, and bacteria representation data. Development and application of the watershed model to address the project objectives involved a number of important steps:

1. Watershed Segmentation
2. Configuration of Key Wet Weather Watershed Model Components
3. Wet Weather Watershed Model Calibration and Validation

F.1.1 Watershed Segmentation

Watershed segmentation refers to the subdivision of the bay watersheds into smaller, discrete subwatersheds for modeling and analysis. This process determines the land surface area that contributes flows and pollutants to each of the downstream receiving waterbodies. This subdivision was primarily based on topographic variability and storm water conveyance system networks.

A 30-meter Digital Elevation Model (DEM) was the primary source of topography data; however, this resolution was not fine enough to segment the watersheds that have relatively flat contributing areas. The 30-meter DEM was used to delineate the Baby Beach watershed. Storm water conveyance system data were used for the remaining watersheds. The Port of San Diego provided the coastal storm water conveyance system data that were used for delineating the Shelter Island Shoreline Park (SANGIS, 2004). The subwatersheds draining to the impaired shorelines of SDB and DPH identified by the watershed segmentation are presented in Appendix J.

F.1.2 Configuration of Key Wet Weather Watershed Model Components

Configuration of the watershed model involved consideration of five major components:

- Meteorological data;
- Land use representation;
- Hydrologic representation;
- Pollutant representation; and,
- Waterbody representation.

These components provided the basis for the LSPC model's ability to estimate flow and pollutant loadings. Detailed discussions about the development of each component for the LSPC model are provided in the following subsections.

F.1.2.1 Meteorology

Meteorological data are a critical component of the watershed model. Meteorological data essentially drive the watershed model. Rainfall and other parameters are key inputs to LSPC's hydrologic algorithms. The LSPC model requires an appropriate representation of precipitation and potential evapotranspiration.

In general, hourly precipitation (or finer resolution) data are recommended for nonpoint source modeling. Therefore, only weather stations with hourly-recorded (or finer resolution) data were considered in the precipitation data selection process. Rainfall-runoff processes for each subwatershed were driven by precipitation data from the most representative station. These data provide necessary input to LSPC algorithms for hydrologic and water quality representation.

Meteorological data have been accessed from a number of sources in an effort to develop the most representative dataset for the bay and harbor watersheds. Hourly rainfall data were obtained from the National Climatic Data Center (NCDC) of the National Oceanic and Atmospheric Administration (NOAA) and the Automatic Local Evaluation in Real Time (ALERT) Flood Warning System managed by the County of San Diego. The above data were reviewed based on geographic location, period of record, and missing data to determine the most appropriate meteorological stations. In addition, hourly evapotranspiration data were obtained from the California Irrigation Management Information System (CIMIS). Based on the review of the available data, the meteorological data were utilized from three area weather stations for the period of January 1990 to May 2004 (Figure F-1) were selected.

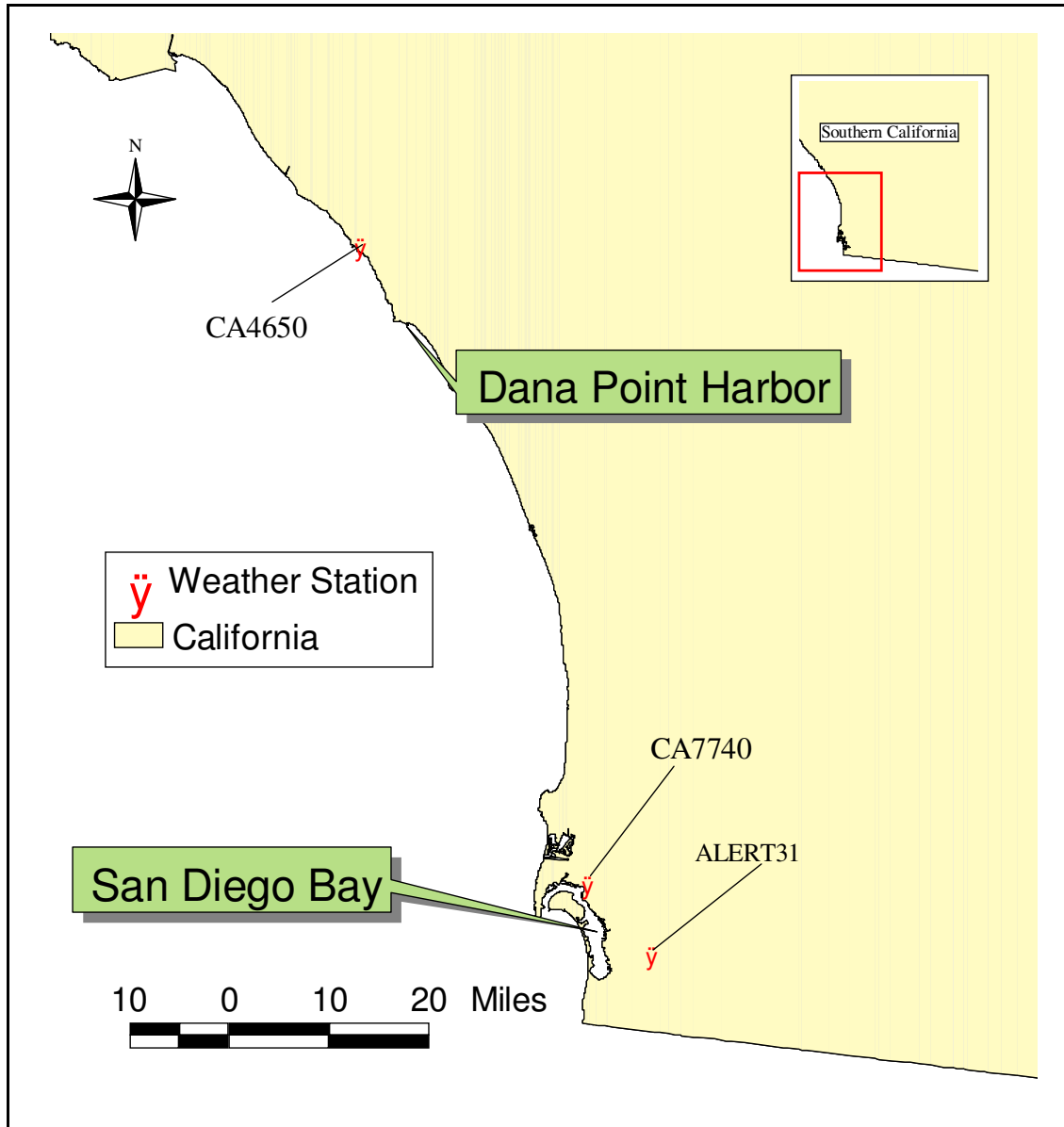

Figure F-1. Weather Stations Utilized for Wet Weather Modeling

F.1.2.2 Land Use Representation

The LSPC watershed model requires a basis for distributing hydrologic and pollutant loading parameters. Hydrologic variability within a watershed is influenced by land surface and subsurface characteristics. Variability in pollutant loading is highly correlated to land use practices. Land use representation provides the basis for distributing soils and pollutant loading characteristics throughout the watershed.

Two sources of land use data were used in this modeling effort. The primary source of data was the San Diego Association of Governments (SANDAG) 2000 land use dataset that covers San Diego County. This dataset was supplemented with land use data from

the Southern California Association of Governments (SCAG) to address the Dana Point Harbor watersheds in Orange County.

Although the multiple categories in the land use coverage provide much detail regarding spatial representation of land practices in the watershed, such resolution is unnecessary for watershed modeling if many of the categories share hydrologic or pollutant loading characteristics. Therefore, many land use categories were grouped into similar classifications, resulting in a subset of thirteen categories for modeling. Selection of these land use categories was based on the availability of monitoring data and literature values that could be used to characterize individual land use contributions and critical bacteria-contributing practices associated with different land uses. For example, multiple urban categories were represented independently (e.g., high density residential, low density residential, and commercial/institutional), whereas forest and other natural categories were grouped. Table F-1 presents the land use distribution in each of the watersheds.

Table F-1. Land Use Areas (Acres) of Each Impaired Shoreline Watershed

Watershed Land Use	Dana Point Harbor	San Diego Bay
	Baby Beach	Shelter Island Shoreline Park
Low Density Residential (1100)	193.8	0.0
High Density Residential (1200)	165.6	0.9
Commercial/ Institutional (1400)	82.5	0.0
Industrial/ Transportation (1500)	3.6	0.0
Military (1600)	0.0	0.0
Parks/ Recreation (1700)	17.1	9.3
Open Recreation (1800)	29.7	0.0
Agriculture (2000)	0.0	0.0
Dairy/ Intensive Livestock (2400)	0.0	0.0
Horse Ranches (2700)	0.0	0.0
Open Space (4000)	30.3	0.0
Water (5000)	0.0	0.0
Transitional (7000)	0.0	0.0
Total	522.6	10.2

LSPC algorithms require that land use categories be divided into separate pervious and impervious land units for modeling. This division was made for the appropriate land uses (primarily urban) to represent impervious and pervious areas separately. The division was based on typical impervious percentages associated with different land use types from the Soil Conservation Service's TR-55 Manual (United States Department of Agriculture, 1986) as summarized in Table F-2. The other eight land use categories are assumed to be 100% pervious.

Table F-2. Percent Impervious for Urban Land Uses (based on TR-55)

Land Use	Pervious Percentage	Impervious Percentage
Industrial/Transportation	18%	72%
Low Density Residential	85%	15%
High Density Residential	35%	65%
Commercial/Institutional	15%	85%
Parks/Recreation	88%	12%

F.1.2.3 Hydrology Representation

Hydrologic representation refers to the modules, or algorithms, in the LSPC model used to simulate hydrologic processes (e.g., surface runoff, evapotranspiration, and infiltration). The hydrology in the model was represented with the LSPC PWATER (water budget simulation for pervious land segments) and IWATER (water budget simulation for impervious land segments) hydrology modules, which are identical to those in HSPF model. These hydrology modules were used to simulate the hydrology for all pervious and impervious land units (Bicknell et al., 1996) in the LSPC model.

Designation of key hydrologic parameters in the PWATER and IWATER hydrology modules of LSPC were required. These parameters are associated with infiltration rates, groundwater flow, and overland flow. Robust hydrology calibration and validation were performed previously for gaged watersheds in the San Diego Region Bacteria TMDL Project I (San Diego Water Board, 2007). The parameter values derived from this previous modeling effort were input to the PWATER and IWATER hydrology modules to parameterize the watersheds in this project. None of the SDB or DPH shoreline watersheds have historic recorded streamflow. Therefore, no further hydrology calibration or validation was performed.

F.1.2.4 Pollutant Representation

Pollutant representation refers to the modules, or algorithms, in the LSPC model used to simulate pollutant loading processes (primarily accumulation and wash-off). Pollutant loading processes for total coliform (TC), fecal coliform (FC), and *Enterococcus* (ENT) were represented for each land unit using the LSPC PQUAL (simulation of quality constituents for pervious land segments) and IQUAL (simulation of quality constituents for impervious land segments) water quality modules, which are identical to those in the HSPF model. These modules simulate the accumulation of pollutants during dry

weather conditions and the wash-off of pollutants during wet weather conditions (rainy periods or storm events) for pervious and impervious land units in the LSPC model.

Land-use-specific accumulation rates and buildup limits were initially obtained from a study performed by the Southern California Coastal Water Research Project (SCCWRP) to support bacteria TMDL development for Santa Monica Bay (Los Angeles Water Board, 2002). These initial values from the SCCWRP study served as baseline conditions for water quality calibration; the appropriateness of these values to the San Diego Region was validated through comparison with local water quality data (San Diego Water Board, 2007). Because these buildup limits and accumulation rates have already been validated for the San Diego Region Bacteria TMDL Project I (San Diego Water Board, 2007), they were considered suitable for use in this smaller-scale modeling effort and thus were incorporated into the PQUAL and IQUAL water quality modules.

F.1.2.5 Waterbody Representation

Waterbody representation refers to modules, or algorithms, in the LSPC model used to simulate flow and pollutant transport through streams and rivers. Each delineated subwatershed was represented with a single stream assumed to be completely mixed, one-dimensional segments with a trapezoidal cross-section. The National Hydrography Dataset (NHD) stream reach network is generally used to determine the representative stream reach for each subwatershed. The resolution of the NHD network was not fine enough to capture the streams in the bay and harbor subwatersheds. Instead, a representative reach for each subwatershed was approximated in a geographic information system (GIS) using the DEM and storm water conveyance system network data. Once the representative reach was identified, slopes were calculated based on DEM data and stream lengths measured from the new stream coverage. In addition to stream slope and length, mean depths and channel widths are required to route flow and pollutants through the hydrologically connected subwatersheds. Mean stream depth and channel width were estimated using regression curves that relate upstream drainage area to stream dimensions. An estimated Manning's roughness coefficient of 0.2 was also applied to each representative stream reach.

F.1.3 Wet Weather Watershed Model Calibration and Validation

After the LSPC watershed model was configured, model calibration and validation was performed. Model validation for hydrology and water quality occurs after model calibration. The entire model calibration and validation process is generally a two-phase process, with hydrology calibration and validation completed before repeating the calibration and validation process for water quality. Model calibration refers to the adjustment or fine-tuning of modeling parameters until the model is able to reproduce previous observations from a particular location and time period. Subsequently, model validation is performed to test the calibrated parameters to see if the model can reproduce previous observations at different locations or for different time periods, without further adjustment.

No flow and water quality data were available to further validate the previously calibrated and validated parameters (San Diego Water Board, 2007). The general calibration and validation process is described below and details are provided regarding this current modeling effort, where applicable. To ensure that the model results are as current as possible and to provide for a range of hydrologic conditions, the meteorological data used during the previous study were extended so that the current simulations span from January 1991 through May 2004.

F.1.3.1 Hydrology Calibration and Validation

Hydrology is the first model component of the watershed model to be calibrated because estimation of bacteria loading relies heavily on streamflow prediction. The hydrology calibration involves a comparison of model results to in-stream flow observations at selected locations and time periods. After running the model and comparing results, key hydrologic parameters are adjusted and additional model simulations are performed. This iterative process can be repeated until the simulated model results closely represent the stream system and reproduce previously observed streamflow patterns and magnitudes.

Model validation is then performed to test the calibrated parameters to see if the model can reproduce previous observations at different locations or for different time periods, without further adjustment. These validation results essentially confirm the appropriateness and applicability of the hydrologic parameters derived during the calibration process.

Regionally-calibrated, land use-specific hydrology parameter values were developed while modeling the entire San Diego Region for Bacteria TMDL Project I (San Diego Water Board, 2007). These values were used to parameterize the SDB and DPH shoreline watersheds. This single set of parameters was calibrated and validated over a diverse geographic (includes mountainous and coastal regions as well as highly urbanized and open areas) and temporal scale (includes extreme wet and dry conditions), and can be applied to the ungaged streams within the San Diego Region. Without this regional set of parameter values, a watershed model would be unfeasible for TMDL linkage analysis and the calculation of loading capacities along ungaged streams. A detailed description of this robust calibration, which included thirteen USGS gages throughout the San Diego Region, is described in the Bacteria TMDL Project I (San Diego Water Board, 2007). This report also documents the methods employed to develop, evaluate, and interpret model results.

Key considerations in the hydrology calibration and validation include the overall water balance, the high-flow/low-flow distribution, stormflows, and seasonal variation. Two methods for evaluation of calibration and validation performance are often used: graphical comparison and the relative error method. Graphical comparisons are extremely useful for judging the results of model calibration; time-variable plots of observed versus modeled flow provided insight into the model's representation of storm hydrographs, baseflow recession, time distributions, and other pertinent factors often overlooked by statistical comparisons. The model's accuracy is primarily assessed

through interpretation of the time-variable plots. The relative error method is used to support the goodness of fit evaluation through a quantitative comparison.

F.1.3.2 Water Quality Calibration and Validation

After a model is calibrated and validated for hydrology, water quality model simulations are performed. As described above, previously calibrated, land use specific accumulation and maximum build up rates for TC, FC, and ENT (Los Angeles Water Board, 2002) were used for the water quality model simulations. Since these values have been successfully applied to recent bacteria models in southern California, they were considered to be sufficiently calibrated. These values were validated for the San Diego Region in Bacteria TMDL Project I by comparing the model results with available monitoring data (San Diego Water Board, 2007).

F.2 Dry Weather Watershed Model

The variable nature of bacteria sources from the SDB and DPH shoreline watersheds during dry weather required an approach that relied on detailed analyses of flow and water quality monitoring data to identify and characterize sources. This TMDL utilized empirical equations previously calibrated and validated in the San Diego Region for Bacteria TMDL Project I (San Diego Water Board, 2007) to represent water quantity and water quality associated with dry weather runoff from various land uses.

Characterization of dry-weather flow and indicator bacteria concentrations was based on analyses of data collected during studies of four watersheds in the San Diego Region. Two of these watersheds, Aliso Creek and San Juan Creek, are located in Orange County and are representative of conditions in the northern part of the Region. The remaining two watersheds, Rose Creek and Tecolote Creek, are located in San Diego County and discharge to Mission Bay. Three of these watersheds, Aliso Creek, San Juan Creek, and Tecolote Creek, are associated with water quality impairments due to bacteria and are therefore representative of conditions that may contribute to similar impairments in neighboring watersheds. Land uses for all four watersheds are consistent with other impaired watersheds in this study, with varying amounts of urban/residential land uses and open space in different subwatersheds.

The modeling approach was originally designed to simulate dry weather bacteria concentrations in the San Diego Region, as described in Bacteria TMDL Project I (San Diego Water Board, 2007). Robust model calibration and validation of flow and bacteria were performed for this initial model application. The SDB and DPH shoreline watersheds model utilizes calibrated parameters from the Bacteria TMDL Project I. The remainder of this section describes model set-up, calibration, and validation of the Bacteria TMDL Project I dry weather model, while noting modifications that were made to specify the model for the SDB and DPH shoreline watersheds.

F.2.1 Dry Weather Watershed Model Configuration

This predictive model for Bacteria TMDL Project I represented the streams as a series of plug-flow reactors, with each reactor having a constant source of flow. A plug-flow reactor can be thought of as an elongated rectangular basin with a constant level in which advection (unidirectional transport) dominates (Figure F-2).

Although not used in the SDB and DPH watersheds due to their small size, the plug-flow reactor models were essential in testing of modeling assumptions in Bacteria TMDL Project I, and comparison to instream monitoring data. As a result, a general description of development of the plug flow reactor models is discussed to provide a basis for assessing the successful application of the approach for flow and bacteria density estimation in Bacteria TMDL Project I, and hence the acceptability of the simplified application of the approach for SDB and DPH.

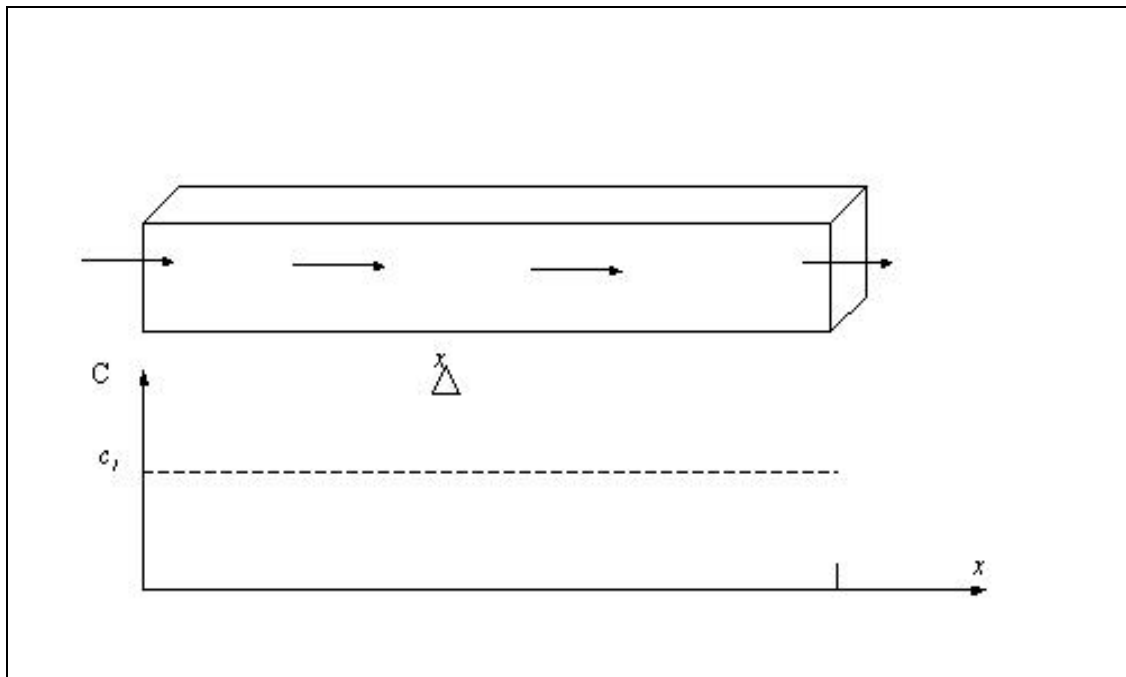

Figure F-2. Theoretical Plug-Flow Reactor

This modeling approach relies on basic segment characteristics, which include flow, width, and cross-sectional area. Model segments are assumed to be well-mixed laterally and vertically at a steady-state condition (constant flow input). Variations in the longitudinal dimension determine changes in flow and pollutant concentrations. A “plug” of a conservative substance introduced at one end of the reactor will remain intact as it passes through the reactor. The initial concentration of a pollutant can be entered and multiple source contributions can be lumped and represented as a single input based on empirically derived inflows for the injection point. Each reactor defines the mass balance for the pollutant and flow. At points further downstream, the concentration can be estimated based on first-order loss and mass balance.

F.2.1.1 Physical Representation

Before the model could be configured, an appropriate scale for analysis was determined. Model subwatersheds were delineated based primarily on topographic variability and storm water conveyance system networks. The subwatersheds, soil types, and stream lengths used in the dry weather model were identical to those described in the wet weather model (see Sections F.1.1 and F.1.2.2 for subwatershed descriptions and Appendix J for watershed maps).

F.2.1.2 Conceptual Representation

Using an upstream boundary condition of initial concentration (C_0) for inflow, the final water column concentration (C) in a segment can be calculated with the loss equation given below:

$$\frac{dc}{dt} = -kc \quad \text{or} \quad C_{out} = C_{in}e^{-kt} = C_{in}e^{-\left(\frac{kx}{u}\right)} \quad (1)$$

where:

- C_{in} = initial concentration (MPN/100ml)
- C_{out} = final concentration (MPN/100ml)
- k = loss rate (1/d)
- x = segment length (mi)
- u = stream velocity (mi/d)

At each confluence, a mass balance of the watershed load and, if applicable, the load from the upstream tributary are performed to determine the change in concentration. This is represented by the following equation:

$$C_0 = \frac{Q_r C_r + Q_t C_t}{Q_r + Q_t} \quad (2)$$

where:

- Q = flow (ft³/s)
- C = concentration

In the previous equation, Q_r and C_r refer to the flow and concentration from the receiving watershed and Q_t and C_t refer to the flow and concentration from the upstream tributary. The concentration calculated from this equation is then used as the initial concentration (C_0) in the loss equation for the receiving segment.

For calculation of outflows from the reach, the following equation is used. Infiltration rates for the model were determined through model calibration and comparison to literature ranges (see Section F.2.2), and are dependent on stream length and width.

$$Q = Q_t + Q_r - I \quad (3)$$

where:

I = infiltration (ft³/s)

Precise channel geometry data were not available for the modeled stream segments; therefore, stream dimensions were estimated from analysis of observed data. For Bacteria TMDL Project I, analyses were performed on flow data and associated stream dimension data from 53 USGS gages throughout southern California. For this analysis, it was assumed that all flow less than 15 cubic feet per second (ft³/s) represented dry weather flow conditions. Using these dry weather data, the relationship between flow and cross-sectional area was estimated ($R^2 = 0.51$). The following regression equation describes the relationship between flow and cross-sectional area:

$$A = e^{0.2253 \times Q} \quad (4)$$

where:

A = cross-sectional area (ft²)

Q = flow (ft³/s)

In addition, data from the USGS gages were used to determine the width of each segment based on a regression between cross-sectional area and width. The relationship with the greatest correlation ($R^2 = 0.75$) was based on the natural logarithms of each parameter. The following regression equation describes the relationship between cross-sectional area and width:

$$\ln(W) = (0.6296 \times \ln(A)) + 1.3003 \quad \text{or} \quad W = e^{((0.6296 \times \ln(A)) + 1.3003)} \quad (5)$$

where:

W = width of model segment (ft)

A = cross-sectional area (ft²)

F.2.2 Estimation of Dry Weather Runoff

Dry weather runoff flow data were not available for any of the SDB or DPH shoreline watersheds. To overcome this data limitation, flow parameters from the regionally calibrated dry weather watershed model for Bacteria TMDL Project I TMDLs was utilized. The remainder of this section describes the methodology used to predict flow for the Bacteria TMDL Project I model (SDRWQCB, 2005).

An analysis was performed using dry weather data from the Aliso Creek (27 stations), Rose Creek (3 stations) and Tecolote Creek (2 stations) watersheds to determine whether there is a correlation between the respective land use types and the average of dry weather flow measurements collected at the mouth of each subwatershed. Table F-3 lists the stations and number of flow measurements used in this analysis.

Table F-3. Number of Flow Measurements at Each Station Used in Analyses

Watershed	Station	No. of Flow of Measurements
Aliso Creek	J01P08	35
	J01P06	21
	J07P02	40
	J07P01	38
	J01P01	40
	J01P05	39
	J01P03	40
	J01P04	40
	J06	15
	J05	39
	J01P30	39
	J01P28	39
	J01P27	40
	J01P33	40
	J01P25	40
	J01P26	40
	J01P24	35
	J01P23	40
	J01P22	39
	J03P02	39
	J01P21	32
	J02P05	39
	J02P08	40
J03P13	38	
J03P05	40	
J03P01	39	
J04	6	
Rose Creek	MBW11	7
	MBW13	80
	MBW16	76
Tecolote Creek	MBW7	23
	MBW9	77

Selection of stations used in the analyses considered the number of flow measurements, the size of the watershed, as well as strategic locations of multiple watersheds representative of varied land uses. A linear relationship was established based on land use areas, with coefficients established through a *step-wise* multivariable regression analyses. For this regression, variables (land use areas) were added to the regression in a step-wise approach, and *p*-values were evaluated for each parameter. A *p*-value of less than 0.05 for each variable was used to determine their statistical significance. Some variables added at an early state of the regression analysis became statistically insignificant as additional variables were subsequently added to the model, which verified the necessity for a robust *step-wise* regression analyses over other more simplified methods. The resulting equation showed a good correlation between the flow and the commercial/institutional, open space and industrial/transportation land uses

($R^2 = 0.78$). The following is the resulting equation from the analysis (p -values for each variable are listed below):

$$Q = (A_{COM} \times 0.00168) + (A_{OPS} \times 0.000256) - (A_{IND} \times 0.00141) \quad (6)$$

where:

Q = flow (ft^3/s)

A_{COM} = area of commercial/institutional (acres) (p -value = $6\text{E}-13$)

A_{OPS} = area of open space, including military operations (acres) (p -value = 0.029)

A_{IND} = area of industrial/transportation (acres) (p -value = 0.002)

The empirical equation presented above that represents water quantity associated with dry weather runoff from various land uses can be used to predict flows. Figure F-3 shows the flow predicted by the above equation compared to observed data for Aliso Creek, Rose Creek, and Tecolote Creek.

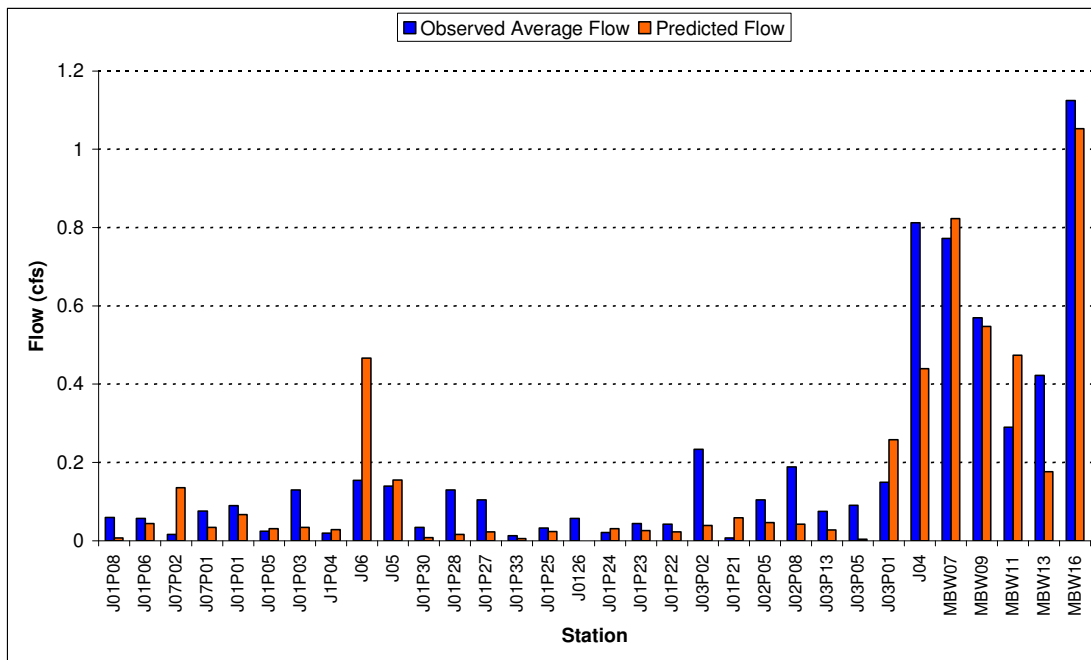

Figure F-3. Predicted and Observed Flows in Aliso Creek, Rose Creek, and Tecolote Creek

Overall, the statistical relationship established between each land use area and flow showed good correlation with the observed flow data. To improve model fit in Bacteria TMDL Project I, model calibration and validation were conducted based on the plug-flow reactor assumptions (see Section F.2.4). The equation presented above was used to estimate inflows from the SDB and DPH shoreline watersheds as part of this current TMDL project.

F.2.3 Estimation of Bacteria Densities

Like dry weather runoff flow data, no bacteria water quality data were available for the SDB and DPH shoreline watersheds. To overcome this data limitation, water quality parameters from the regionally-calibrated dry weather model for Bacteria TMDL Project I were utilized. The remainder of this section describes the methodology used to predict bacteria densities for the Bacteria TMDL Project I dry weather watershed model (San Diego Water Board, 2007).

An analysis was performed using data from subwatersheds tributary to Aliso Creek (27 stations), Tecolote Creek (5 stations), Rose Creek (4 stations) and San Juan Creek (9 stations) to determine the correlation between dry weather FC concentrations, land use distribution and the overall size of the subwatersheds. For comparison, geometric means were calculated for each station using all dry weather data collected. Large data sets were preferred to reduce random error and normalize observations at each site. For example, if a station has 40 dry weather samples, the geometric mean of bacteria concentrations can be used for that station with confidence that they are representative of the range of conditions that normally occur. Likewise, if a station has only two samples, there is less confidence. It was critical that the data were normalized as well as possible before regression analysis so that variability did not propagate error. However, no criteria were developed for selection of stations based on the number of samples for representative geometric mean calculations. Rather, station selection included qualitative evaluation for consideration in the analyses. Specific stations of Rose Creek, Tecolote Creek, and San Juan Creek were selected for analyses even though few samples were available at these locations for geometric mean calculations. These stations were selected based on multiple reasons, including the relatively low indicator bacteria concentrations observed, strategic locations of watersheds to provide an expanded spatial coverage for analyses, size of the watershed, or representation of key land uses.

Table F-4. Number of Water Quality Samples at Each Station Used in Analyses

Watershed	Station	Number of Samples		
		FC	TC	ENT
Aliso Creek	J01P08	40	40	40
	J01P06	39	39	39
	J07P02	40	40	40
	J07P01	40	40	40
	J01P01	40	40	40
	J01P05	40	40	40
	J01P03	40	40	40
	J01P04	40	40	40
	J06	40	40	40
	J05	40	40	40
	J01P30	40	40	40
	J01P28	40	40	40
	J01P27	40	40	40
	J01P33	40	40	40
	J01P25	40	40	40
	J01P26	40	40	40
	J01P24	40	40	40
	J01P23	40	40	40
	J01P22	40	40	40
	J03P02	40	40	40
	J01P21	33	33	33
	J02P05	40	40	40
	J02P08	40	40	40
	J03P13	40	40	40
J03P05	40	40	40	
J03P01	40	40	40	
J04	40	40	40	
Rose Creek	MBW13	55	80	60
	MBW15	22	78	26
	MBW16	18	76	21
	MBW24	3	7	3
Tecolote Creek	MBW6	5	70	8
	MBW7	6	23	11
	MBW8	5	27	15
	MBW9	20	77	25
	MBW10	40	88	54
San Juan Creek	SJ13	11	11	11
	SJ14	10	10	10
	SJ15	11	11	11
	SJ16	11	11	11
	SJ19	3	3	3
	SJ20	11	11	11
	SJ21	11	11	11
	SJ29	2	2	2
SJ32	11	11	11	

As part of the TMDL development for Bacteria TMDL Project I, a regression analysis was performed to determine whether there is correlation between the representative geometric mean of FC data at each station, the percent of each land use category in the subwatershed, and the total watershed area. Coefficients in the equation were established through a *step-wise* multivariable regression analyses. For this regression,

variables (percent of land uses) were added to the regression in a step-wise approach, and p -values were evaluated for each parameter. Percentages of land uses were used instead of land use areas since concentrations are not expected to increase with the size of the watershed, but rather due to the density of specific land uses. To include a function for reduction of bacteria concentration due to watershed size and increased potential for bacteria die-off (prior to entering the stream), an additional variable was added for watershed area. A p -value of less than 0.05 for each variable was used to determine their statistical significance (although this criterion was relaxed for open recreation which slightly exceeded at 0.067). As with the flow analysis, some variables added at an early state of the regression analysis became statistically insignificant as additional variables were subsequently added to the model, verifying the need for a robust *step-wise* regression analyses over other more simplified methods.

Results showed a good correlation between the natural log of FC concentrations and low-density residential, high-density residential, industrial/transportation, open space, transitional, commercial/institutional, and recreation land uses, as well as subwatershed size ($R^2=0.74$). The following regression equation describes the correlation between land use, fecal coliform concentration, and watershed area. Figure F-4 illustrates the observed geometric means and predicted concentrations at each sampling station.

$$\ln(FC) = 8.48 \times (\%LU_{LDR}) + 9.81 \times (\%LU_{HDR}) + 8.30 \times (\%LU_{IND}) + 8.46 \times (\%LU_{OPS}) + 10.76 \times (\%LU_{TRN}) + 6.60 \times (\%LU_{COM}) + 17.92 \times (\%LU_{PRK}) + 12.85 \times (\%LU_{OPR}) - 0.000245 \times A$$

(7)

where: FC = fecal coliform concentration (MPN/100 ml)

$\%LU_{LDR}$ = percent of low density residential (p-value = 8E-16)

$\%LU_{HDR}$ = percent of high density residential (p-value = 7E-15)

$\%LU_{IND}$ = percent of industrial/transportation (p-value = 0.005)

$\%LU_{OPS}$ = percent of open space, including military operations (p-value = 7E-24)

$\%LU_{TRN}$ = percent of transitional space (p-value = 1E-19)

$\%LU_{COM}$ = percent of commercial/institutional (p-value = 4E-9)

$\%LU_{PRK}$ = percent of park/recreation (p-value = 0.009)

$\%LU_{OPR}$ = percent of open recreation (p-value = 0.067)

A = total area of watershed (acres) (p-value = 1E-7)

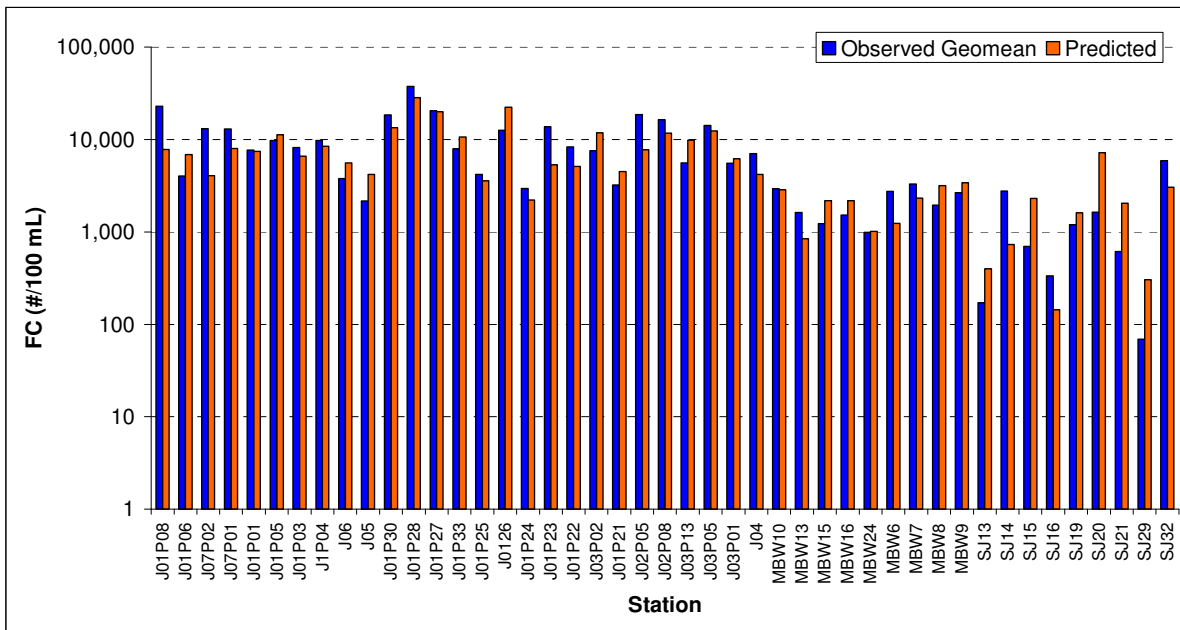

Figure F-4. Predicted Versus Observed Fecal Coliform Concentrations

The methodology for estimating FC concentrations was not as successful for prediction of TC and ENT. For Bacteria TMDL Project I, similar regression analyses were performed to determine whether there were relationships between TC and ENT and land use and subwatershed size, but no acceptable correlations were found. As a result, a separate approach was used for estimating TC and ENT concentrations in dry weather runoff for each watershed.

Analyses of geometric means of FC data collected at each station were performed on similar geometric means of TC and ENT data collected at the same stations. The analyses resulted in a single, normalized value of FC, TC, and ENT at each station. Regression analyses were performed to determine whether there is a correlation between FC and levels of TC and ENT. Results showed a good correlation in predicting TC and ENT as a function of FC ($R^2=0.67$ and $R^2=0.77$, respectively). The following equations describe the relationship observed between FC and TC/ENT (units of FC and TC/ENT are consistent):

$$TC = 5.0324 \times FC \quad \text{and} \quad ENT = 0.8466 \times FC \quad (8)$$

Figures F-5 and F-6 illustrate the observed geometric means and predicted concentrations for TC and ENT, respectively. The TMDL equations for TC, FC, and ENT from Bacteria TMDL Project I were applied to the SDB and DPH shoreline watersheds to estimate bacteria densities impacting the impaired shoreline segments.

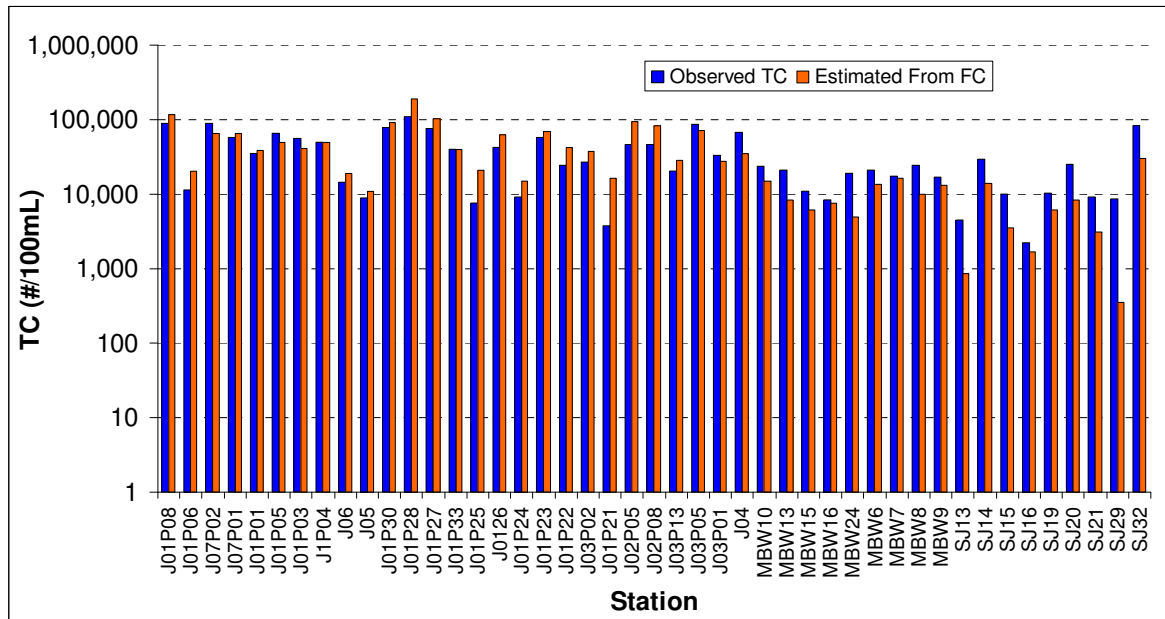

Figure F-5. Predicted Versus Observed Total Coliform Concentrations

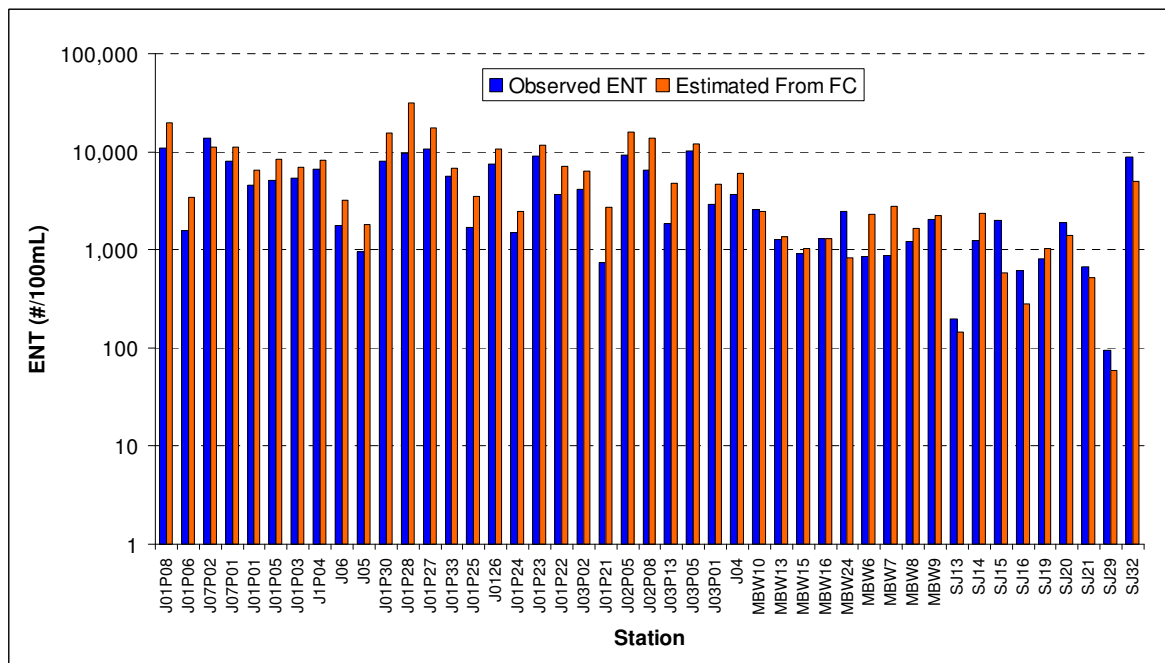

Figure F-6. Predicted Versus Observed Enterococci Concentrations

F.2.4 Dry Weather Watershed Model Calibration and Validation

During the development of TMDLs for Bacteria TMDL Project I, calibration of the plug-flow reactor model was performed using data from Aliso Creek and Rose Creek. Calibration involved the adjustment of infiltration rates to reflect observed in-stream flow conditions. Following model calibration, a separate validation process was undertaken to verify the predictive capability of the model in other watersheds.

Model assumptions for stream reach infiltration and bacterial die-off rates were derived through calibration based on data collected within reaches of Aliso Creek (11 stations) and Rose Creek (6 stations). Some of these stations were also used for development of regression equations for prediction of flow and FC concentrations from watersheds, however, effects of infiltration or bacteria die-off that may be implicitly incorporated in the regression equations (e.g., negative correlation of bacteria concentration to watershed size suggests effects of bacteria die-off in equation 7) were not considered duplicated in the reach assumptions. Model configuration of multiple subwatersheds and reaches differed from single representative watersheds used in regression analyses, and required incorporation of assumptions for reach infiltration and bacterial die-off to account for losses occurring during transport. Each model subwatershed used the regression equations to estimate flow and bacterial concentration that were routed through a network of stream reaches that ultimately met locations corresponding to monitoring stations used for calibration. However, watersheds used for regression analyses represented a single watershed for the same area, with no stream routing. Hence, the infiltration and die-off rates developed for the reaches were not consistent with errors associated with regression equations applied to the entire watershed without reach routing and losses considered. To further prove the independence of the calibration procedure from the regression analyses, data from five additional instream monitoring stations that were not used for regression analyses were also used for calibration. Model validation included nine additional stations not included in the regression analyses.

The calibration was completed by adjusting infiltration rates to reflect observed in-stream flow conditions and adjusting bacteria die-off rates to reflect observed in-stream bacteria concentrations. Following model calibration to in-stream flow and bacteria concentrations, a separate validation process was undertaken to verify the predictive capability of the model in other watersheds. Table F-5 lists the sampling locations used in calibration and validation, along with their corresponding watersheds.

Table F-5. Calibration and Validation Sampling Locations

Calibration – Flow and Bacteria		Validation – Flow		Validation – Bacteria	
Watershed	Sampling Location	Watershed	Sampling Location	Watershed	Sampling Location
208	J01P22	403	USGS11047300	402	SJ04
209	J01P23	1701	MBW06	403	SJ05
210	J01P28	1702	MBW07	405	SJ18
211	J01P27	1703	MBW10	406	SJ24
212	J06	1704	MBW08	408	SJ1
213	J01P05	1705	MBW09	409	SJ29 & SJ17
214	J01P01			411	SJ06
215	J01TBN8			413	SJ08 & SJ07
219	J04			414	SJ30 & SJ09
220	J03P13			416	SJ15
221	J03P01			1701	MBW06
1601	MBW20			1702	MBW07
1602	MBW17			1703	MBW10
1603	MBW15			1704	MBW08
1605	MBW11			1705	MBW09
1606	MBW13				
1607	MBW24				

F.2.4.1 Dry Weather Watershed Hydrology Model Calibration and Validation

Infiltration rates vary by soil type and, as described in Section F.2.1, the dry weather watershed model configuration included identifying a soil type for each subwatershed. Stream infiltration was calibrated by adjusting the infiltration rate. This rate was adjusted for each soil type within ranges identified from literature values. The goal of calibration was to minimize the difference between average observed flow and modeled flow at each calibration station location. The model closely predicted observed flows and the calibration results are graphically presented in Figure F-7.

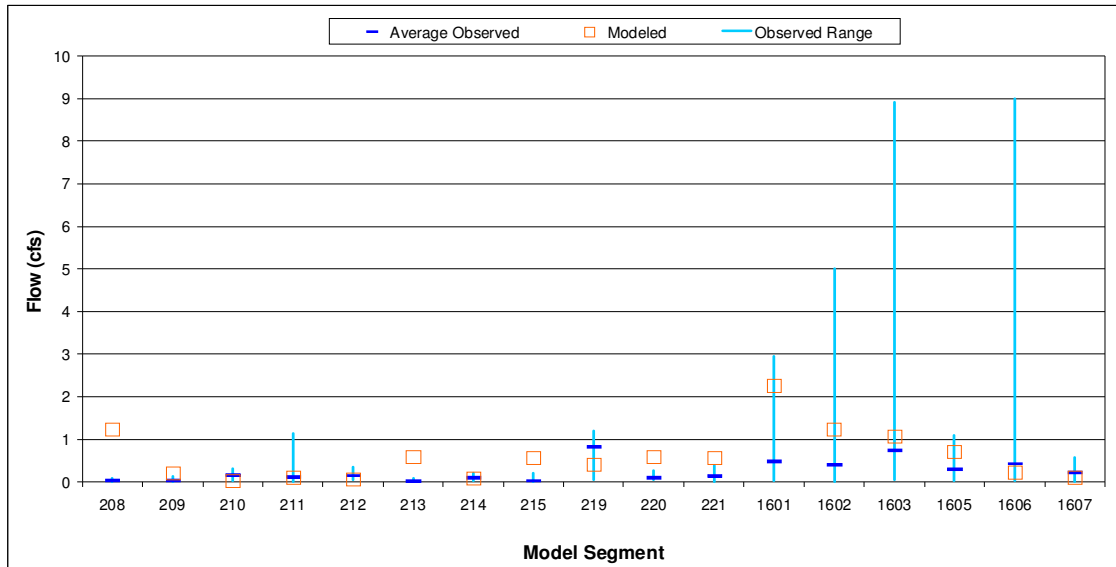

Figure F-7. Calibration Results of Modeled Versus Observed Flow

The calibrated infiltration rates were 1.368 inches per hour (in/hr) for Soil Group A, 0.698 in/hr for Soil Group B, 0.209 in/hr for Soil Group C, and 0.084 in/hr for Soil Group D. The infiltration rates for Soil Groups B, C, and D fall within the range of values described in the literature (Wanielisata et al., 1997). The calibrated rate for Soil Group A is below the range identified in Wanielisata et al. (1997); however, Soil Group A is not present in the modeled watersheds, which is dominated by Soil Group C.

Subsequent to the model calibration, the model was validated using six stations in the San Juan Creek and Tecolote Creek watersheds. The model-predicted flows were within the observed ranges of dry weather flows (Figure F-8), demonstrating very good overall model fit.

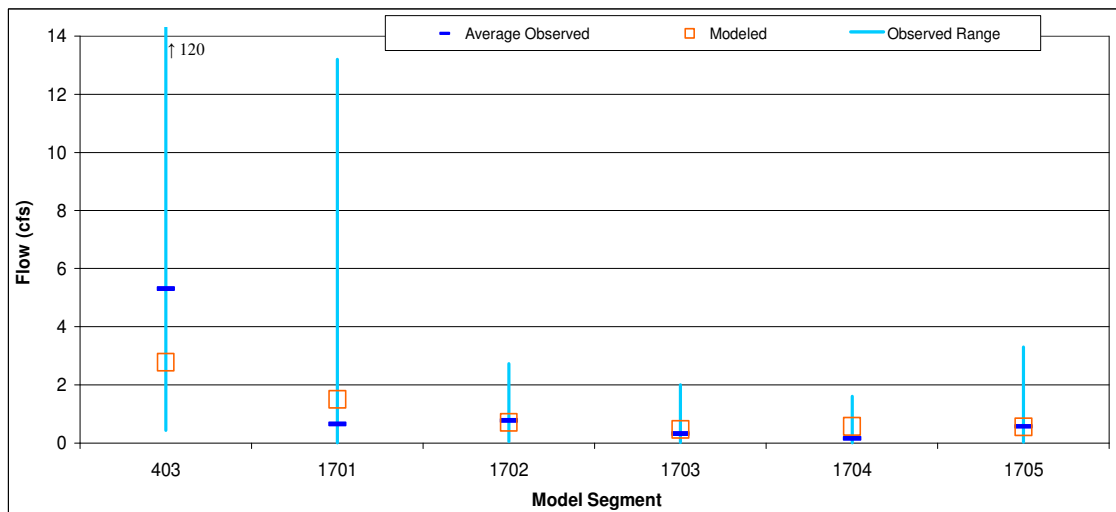

Figure F-8. Validation Results of Modeled Versus Observed Flow

F.2.4.2 Dry Weather Watershed Bacteria Model Calibration and Validation

The modeled first-order die-off rate reflects the net effect on bacteria of various environmental conditions, such as solar radiation, temperature, dissolved oxygen, nutrients, regrowth, deposition, resuspension, and toxins in the water. The die-off rates for TC, FC, and ENT were used as calibration parameters to minimize the difference between observed in-stream bacteria levels and dry weather watershed model predictions. Calibration results for TC, FC, and ENT are presented in Figures F-9 through F-11. Die-off rates were determined TC (0.209 1/d), FC (0.137 1/d), and ENT (0.145 1/d). These values are within the range of die-off rates used in various modeling studies as reported by USEPA (1985). Sixteen stations were used in calibrating die-off rates for Bacteria TMDL Project I.

Model validation to in-stream water quality was conducted using 15 stations on Tecolote Creek and San Juan Creek. The results of the water quality dry weather watershed model validation for Bacteria TMDL Project I are presented in Figures F-12 through F-14.

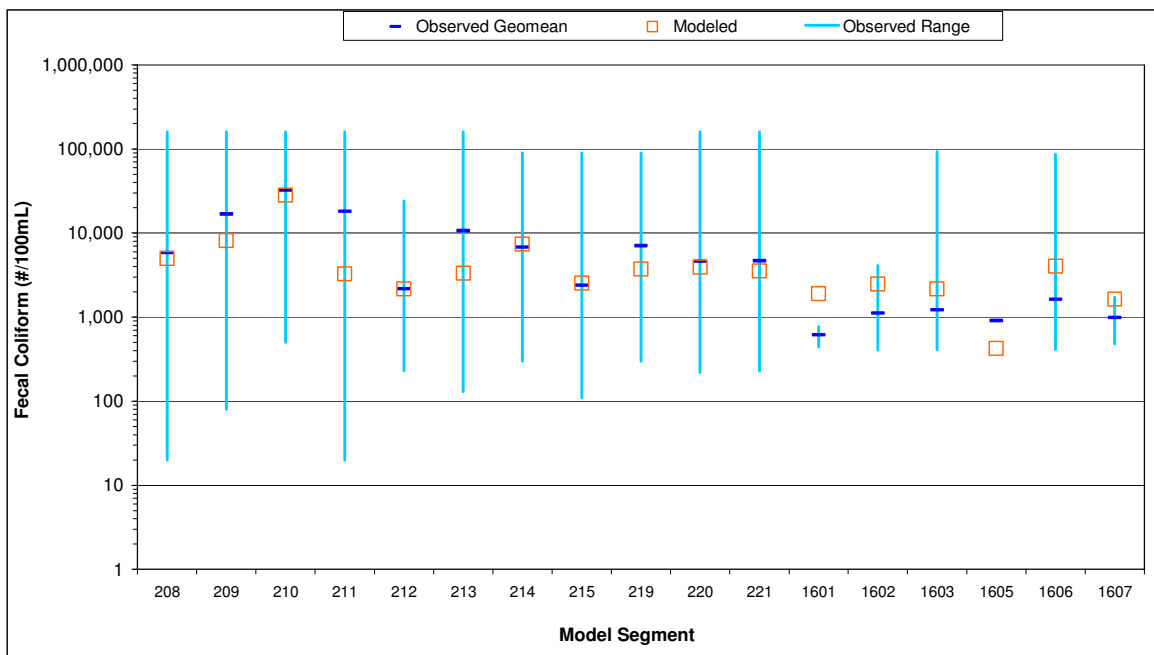

Figure F-9. Calibration Modeled Versus Observed In-Stream Fecal Coliform Concentrations

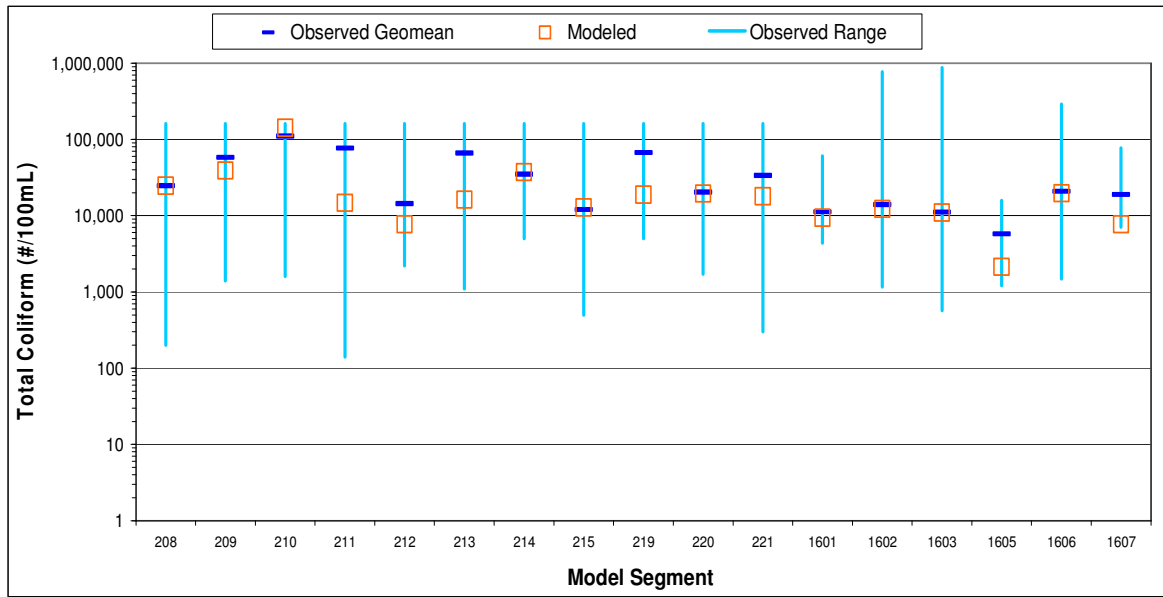

Figure F-10. Calibration Modeled Versus Observed In-Stream Total Coliform Concentrations

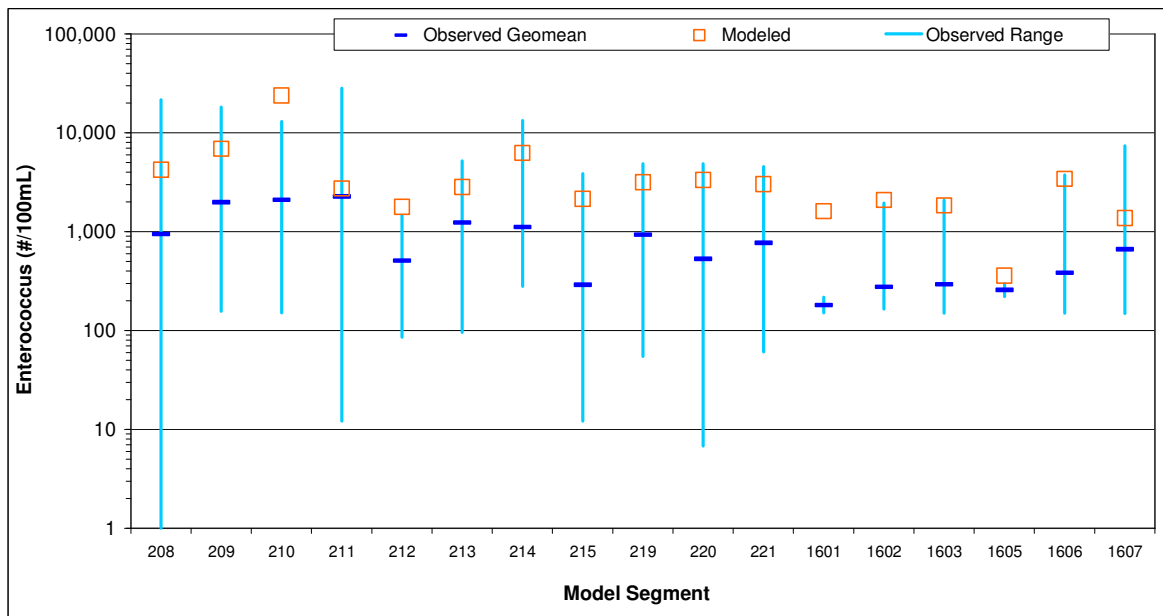

Figure F-11. Calibration Modeled Versus Observed In-Stream Enterococci Concentrations

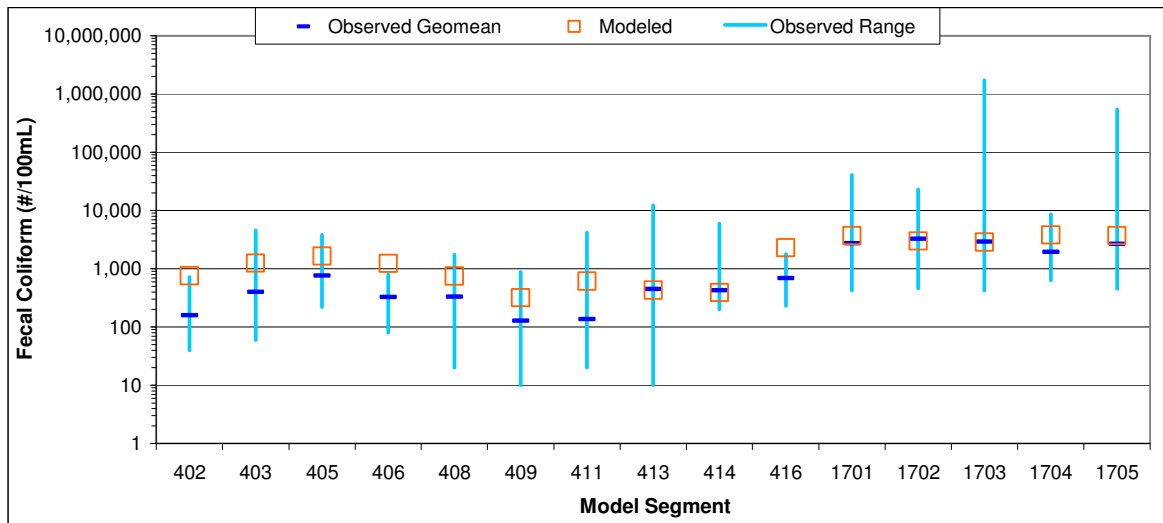

Figure F-12. Validation Modeled Versus Observed In-Stream Fecal Coliform Concentrations

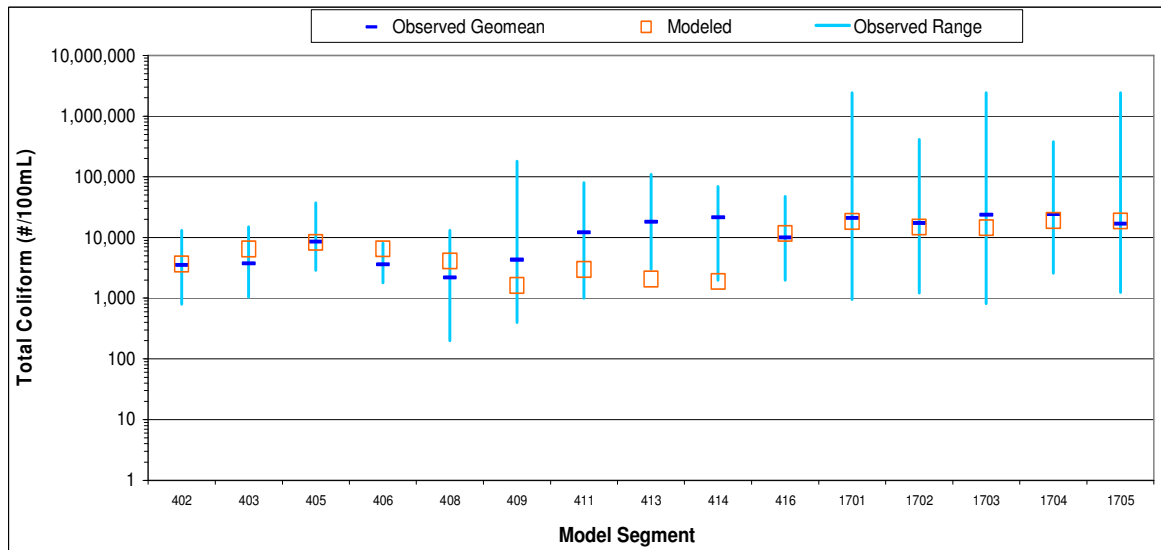

Figure F-13. Validation Modeled Versus Observed In-Stream Total Coliform Concentrations

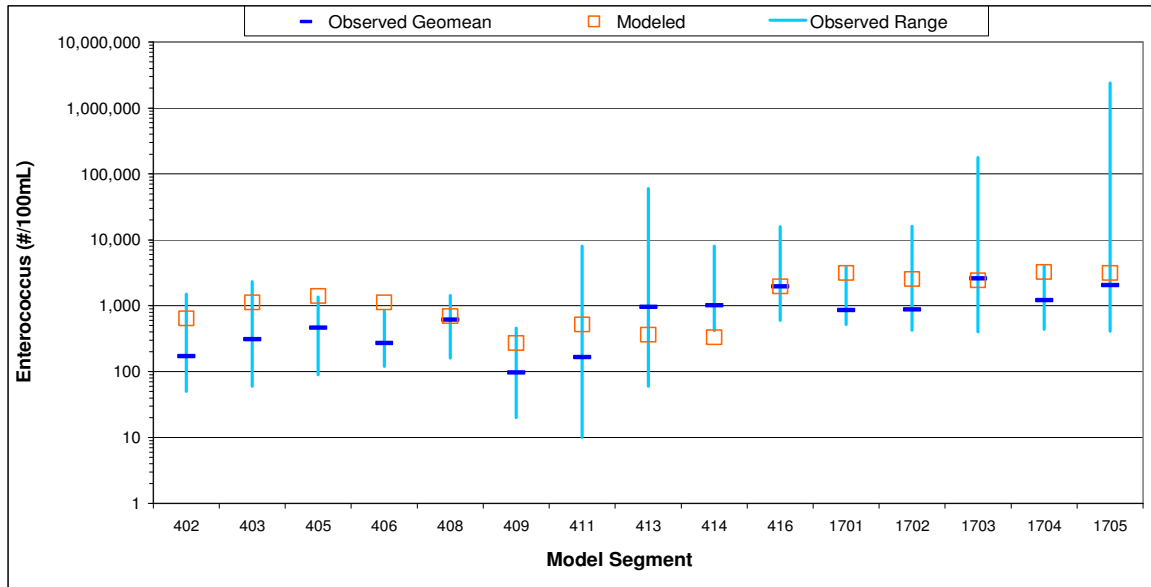

Figure F-14. Validation Modeled Versus Observed In-Stream Enterococci Concentrations

F.2.4.3 Dry Weather Watershed Model Application to San Diego Bay and Dana Point Harbor Watersheds

As described previously, regionally-calibrated parameters and equations were applied to the SDB and DPH shoreline watersheds. However, each of the watersheds draining to the shoreline areas consisted of a single watershed without multiple subwatersheds included for routing purposes (see Appendix J). Only single watersheds were considered necessary for modeling due to the small size of the drainage areas. As a result, only equations 6, 7, and 8 were used in estimating dry weather flows and bacterial densities from these watersheds. The plug-flow reactor models were not required for routing of associated bacterial loads from these areas, as they discharge directly to the shorelines.

Further validation could not be conducted for flow or bacteria due to lack of dry weather monitoring data in the watersheds of interest. The application of the dry weather watershed model and its role in calculation of the SDB and DPH shoreline TMDLs is discussed in Section F.4.

F.3 Wet and Dry Weather Receiving Water Model– EFDC

A hydrodynamic and bacteria transport model was developed to simulate the water budget and the fate and transport of bacteria to the receiving waters of the impaired shoreline segments in SDB and DPH. The computational framework of the receiving water models are based on the EFDC model, a comprehensive three-dimensional model capable of simulating hydrodynamics, salinity, temperature, suspended sediment, water quality, and the fate of toxic metals. The EFDC model is a widely

accepted model (particularly by USEPA) and is capable of simulating 21 water quality parameters, including dissolved oxygen, suspended algae, various components of carbon, nitrogen, phosphorous, and bacteria.

San Diego Bay

The shoreline segment located at Shelter Island Shoreline Park within SDB was included in this receiving water analysis for indicator bacteria. Bacteria usually show strong local source-concentration response patterns (i.e., the concentration of bacteria in a specific location is usually directly caused by sources discharged nearby). Therefore, very high spatial resolution is necessary to accurately represent the source-concentration link.

Although the entire San Diego Bay can be simulated with a sufficiently fine grid to achieve the necessary resolution for each of the shoreline segment areas, a model configured with that level of detail could incur prohibitive computational time. To overcome this limitation, a two-stage approach was adopted, which achieves sufficient resolution for the the shoreline segment areas with reasonable computational times. The first stage involved developing a coarse grid, vertically-integrated, two-dimensional hydrodynamic model to simulate water circulation and water elevation fluctuation throughout the bay. The objective of this coarse grid model was to provide open boundary conditions for the fine grid model of the impaired shoreline segment area. The second stage involved developing a separate fine grid model for the impaired shoreline segment of Shelter Island Shoreline Park (see Appendix J for maps). The high-resolution grid was better able to capture the intricate shoreline features of the impaired shoreline segment and near-field variability, which is critical for representing the bacteria source-concentration relationship.

The EFDC model application of Shelter Island Shoreline Park simulated both hydrodynamics and TC, FC, and ENT bacteria densities. The Shelter Island Shoreline Park fine grid model was used to identify potential sources causing the bacteria fluctuations in the observed data.

Dana Point Harbor

The shoreline segment located at Baby Beach within DPH shoreline was included in this receiving water analysis for indicator bacteria. The entire harbor was simulated with a sufficiently fine grid to achieve the necessary resolution at Baby Beach (see Appendix J for a map). The model of the entire harbor was configured to simulate hydrodynamics associated with tidal flushing and TC, FC, and ENT bacteria densities.

Model Configuration

Configuration of the EFDC models for SDB and DPH (sections F.3.1 and F.3.2 and section F.3.3, respectively) involved identifying and processing bathymetric data, developing model grids, defining boundary and initial conditions, and creating a linkage with the wet weather (LSPC) and dry weather (steady-state) watershed models using lateral inputs. Boundary conditions are fixed conditions applied to the modeling system

to drive the hydrodynamic simulation. Three types of boundary conditions were applied to the models: open ocean, lateral flux, and meteorological.

Open ocean boundary conditions consist of time-variable tidal water levels, temperature, and salinity. The lateral flux boundary conditions include the wet weather and dry weather inflow of water from the watershed. The wet weather watershed flows were configured based on the results of the calibrated LSPC watershed model (section F.1). Constant dry weather watershed flows were estimated from the steady-state dry weather watershed model (section F.2), developed and calibrated for Bacteria TMDL Project I. The spatial representation of these inflow boundary conditions was determined by mapping the geographical coordinates of the watershed outlets on the individual model grids. The meteorological boundary condition is represented by time-variable weather conditions including solar radiation, wind speed and direction, air temperature, atmospheric pressure, relative humidity, and cloud cover.

For water quality simulations, bacteria loads associated with the watershed flows were also input as a lateral boundary condition. Time-variable wet weather and constant dry weather concentrations were used to develop the bacteria loading time-series for each watershed inflow location. In addition to the watershed loading, a lumped source of bacteria loading was incorporated into the models. This lumped source characterized all other unquantifiable sources, including the aerial contribution from waterfowl, accumulated waterfowl feces on beaches, and/or other unidentified sources within the receiving waters.

In hydrodynamic modeling, initial conditions provide a starting point for the model to progress through time. Initial temperature, salinity, flow velocity, and water depth values were specified for the entire domain of each model. These data, especially for temperature and salinity, were limited within the bays. Therefore, in the absence of data, reasonable assumptions or extrapolations of data were made.

January 1, 2001 through December 31, 2002 was selected as the model simulation time period. This period corresponds to the two years in which the most comprehensive data were available for model configuration and comparison. It should be noted that for simulation over a long time period, such as over a year or multiple years (as was the case for this simulation), the overall model performance is not sensitive to the initial conditions for velocity and temperature. The remainder of this section provides additional details regarding the configuration and application of the EFDC models of SDB (sections F.3.1 and F.3.2) and DPH (section F.3.3).

F.3.1 Coarse Grid Receiving Water Model for the San Diego Bay

F.3.1.1 Grid Generation

The model domain for SDB includes the entire bay up to the mouth, which encompasses an area of approximately 50 square kilometers. The model is comprised of 138 computation cells (Figure F-15). The maximum and minimum cell widths (l direction) are 354 meters and 1311 meters, respectively, and the maximum and

minimum cell lengths (J direction) are 288 meters and 762 meters, respectively. The grid has dimensions of $I=35$, $J=15$ in the horizontal plane and consists of a single layer in the vertical plane.

Bathymetry for the model domain was based on Digital Raster Graphics (DRGs) obtained through the California Spatial Information Library (<http://casil.ucdavis.edu/>). The average depth for the course grid was 7 meters (minimum was 6 meters and maximum was 8 meters).

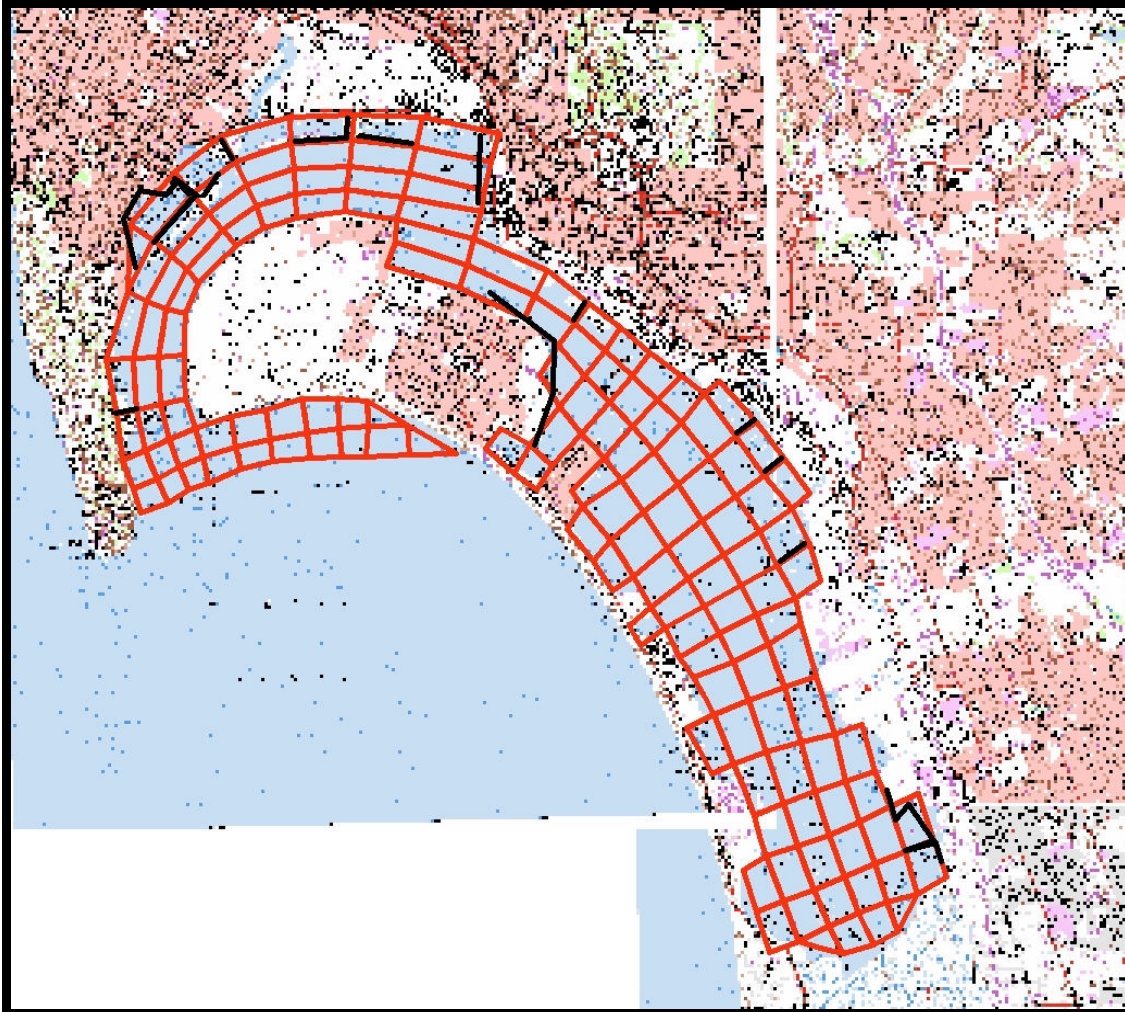

Figure F-15. Coarse Resolution Grid for San Diego Bay

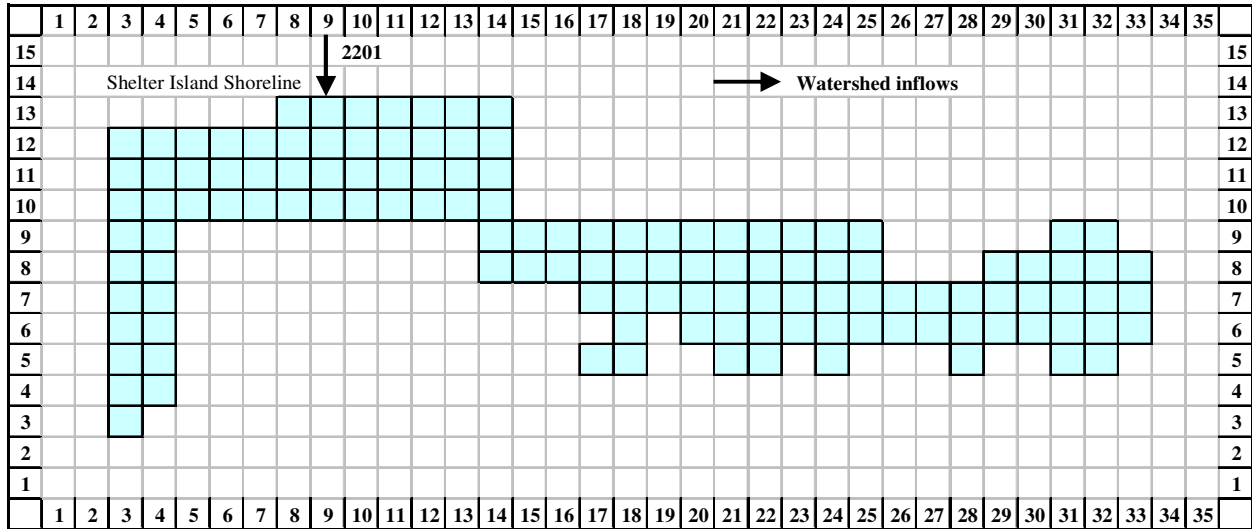

Figure F-16. Open Ocean and Lateral Boundary Locations for San Diego Bay Model

F.3.1.2 Boundary Conditions

F.3.1.2.1 Open ocean boundary conditions

The mouth of SDB opens to the Pacific Ocean. Ten grids in the model (Figure F-16) were configured as the open ocean boundary and were assigned time-variable water levels, temperature, and salinity. Real-time hourly water level data was available from the National Oceanic and Atmospheric Administration Centers for Operational Oceanographic Products and Services (NOAA-COOPS) for station #9410230, located in La Jolla, CA. Data were processed and an EFDC-compatible tidal time series dataset was created.

Two Scripps Institution of Oceanography stations with continuous surface temperature observations were utilized to obtain temperature for the open ocean boundary. The closest station to SDB is station #091, located 8.5 miles west of Point Loma. However, this station is a seasonal buoy and is operated from approximately February to August of each year. Station #095, located 3.8 miles west of La Jolla, operates year-round. Temperature data from these two stations were compared for 180 overlapping days in 2001. The comparison resulted in good correlation between the two stations with an $R^2 = 0.92$. Therefore, temperature data from La Jolla (station #095) were selected to build the time series at the open ocean boundary. Initially, the hourly data at La Jolla was directly used as the boundary condition. However, this caused model instability at certain times during the simulation period. The suspected cause of this instability is a short-term signal in the time series. Because the temperature at La Jolla is not exactly the same as the mouth of the bay, hourly data were averaged to daily values. This filtered out the impact of any short period temperature signals that may not be representative of conditions at the mouth.

A station operated by the Port of San Diego and located within SDB provided salinity data for the open ocean boundary. Continuous salinity observations were available from March 7, 2001 to December 13, 2001 and January 13, 2002 to February 7, 2002. The January to February 2002 data were used to fill the data gap in 2001 and the March to December 2001 data were used to fill the data gap in 2002. Although not comprehensive, the Port of San Diego data were the only available salinity data at the time the model was configured.

F.3.1.2.2 Lateral boundary conditions

Contributions from one subwatershed (2201) was included as a lateral boundary condition for SDB. Dynamic wet weather and steady-state dry weather flow rates from this subwatershed was applied to the corresponding inflow grid cells in the EFDC model. In total, the model has two lateral inflow boundary conditions (one for wet weather and one for dry weather watershed runoff).

Continuous surface temperature observations from NOAA station #9410170, located within the SDB shoreline, were used to specify the temperature for the watershed inflows. Although temperature of the bay waters can be different from the incoming tributary flows, temperature measurements for incoming streams were not available. Since watershed flows only account for a negligible portion of the total flow balance in the bay, the uncertainty associated with the inflow temperature values has minimal impact on the model results. In addition, salinity data for the inflows were not available and were thus set to zero. This is also expected to have a negligible impact on the model results because the inflows account for such a small portion of the volume of the bay.

F.3.1.2.3 Meteorological boundary conditions

Five airway stations in close proximity to SDB were evaluated for potential inclusion in the model. The stations were evaluated based on their proximity to the model domain, period of record, parameters measured, and completeness of data. Data for 1990 through 2004 were obtained from the National Climatic Data Center (NCDC). The results of the evaluation indicated that the Lindbergh Field Airway Station in San Diego was the most appropriate weather station and was thus used to create the meteorological file. This station had data for most of the required parameters, provided the most complete temporal data record, and is located in close proximity to SDB. Data for dry and wet bulb temperature, dew point temperature, relative humidity, wind speed, wind direction, sea level pressure, and sky conditions for 1990 to 2004 were obtained for the Lindbergh Field station. Sky condition was converted to “percent cloud cover” and solar radiation was estimated by calculating the clear sky solar radiation using latitude and longitude and adjusting the values based on the estimated cloud cover.

F.3.1.3 Initial Conditions

A uniform temperature of 15°C and a salinity of 33 parts per thousand (ppt) were included as initial conditions throughout in the water column. This temperature was verified using data from Scripps Institution of Oceanography stations #091 and #095

and was determined reasonable considering that the models began on January 1st. The initial water velocity was set to 0.0 meters per second (m/s) and the initial water surface elevation was 0.0 meters above mean sea level.

F.3.1.4 Model Calibration and Validation

The hydrodynamic model of SDB was calibrated using observed surface elevation, temperature, and salinity data from within the bay. Specifically, the model-computed hourly water surface elevations were compared with hourly real-time data from NOAA-COOPS station #9410170, located within the SDB shoreline. Figure I-1 in Appendix I illustrates the model-data comparison for 2001. The model has captured the phase and amplitude of the data well. The mean error¹ for the model-computed hourly water surface elevation for 2001 is -0.008 meters. The root mean square error² is 0.1 meters.

The model-predicted hourly water column temperature was compared with hourly observations from NOAA-COOPS station #9410170. Figures I-2 and I-3 of Appendix I show the model-data comparison for 2001 and 2002, respectively. The model simulates the seasonal variation in temperature well. The mean error for the model-predicted hourly temperature for 2001 is 0.39°C and the root mean square error is 1.03°C.

Through a sampling effort conducted in the bay by Space and Naval Warfare Systems (SPAWAR, 2005), salinity and temperature measurements were available for January 30, May 11, and September 19, 2001, and January 27 and May 14, 2002 (see Figure I-4 of Appendix I for a map of sampling locations). Figures I-5 through I-30 of Appendix I illustrate the results of the temperature calibration to the SPAWAR data, while Figures I-31 through I-56 of the same appendix illustrate the salinity calibration. Overall, the model predicts both salinity and temperature very well.

F.3.2 Fine Grid Receiving Water Model for Shelter Island Shoreline Park

F.3.2.1 Grid Generation

The fine resolution grid developed for the Shelter Island Shoreline Park shoreline segment extends 900 meters from Shelter Island across (in J direction) to the opposite side of the bay and spans a length (in I direction) of 1750 meters along SDB (Figure F-17). The grid has dimensions of I=11, J=9 in the horizontal plane and contains a single layers in the vertical plane. The model domain is represented by 35 computation cells. Bathymetry for the model was based on DRGs obtained through the California Spatial Information Library website (<http://casil.ucdavis.edu/>). Cell depths throughout most of the fine grid were identical to those in the course grid: 7 meters (minimum was 6 meters and maximum was 8 meters). Very shallow depths were assigned to the grid cells directly along the impaired shoreline to more accurately represent the natural conditions.

¹ Mean error = Sum (model-data)/n; n=number of model-data points

² Root Mean Square Error = square root [(Sum (model-data)²)/n]

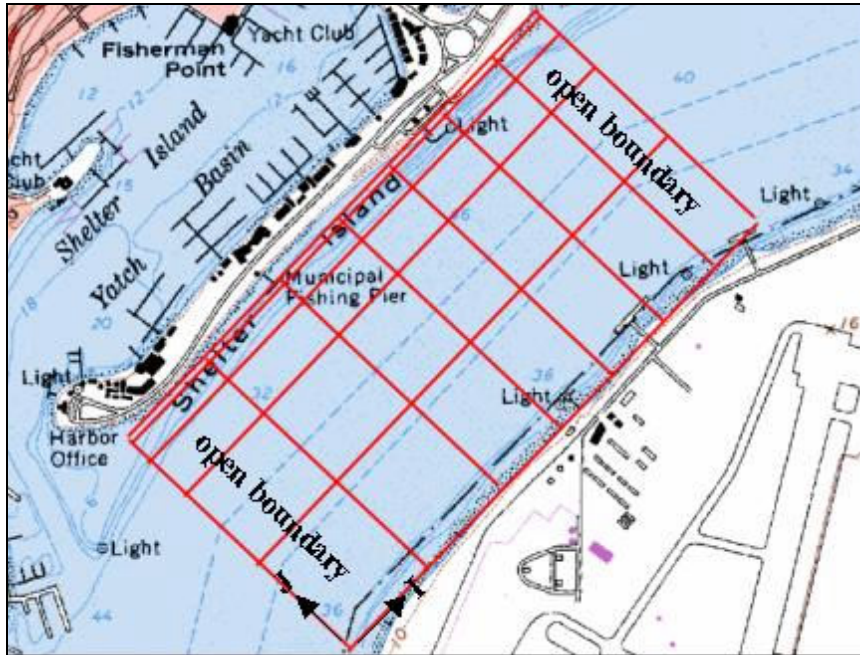

Figure F-17. Fine Resolution Grid for Shelter Island

F.3.2.2 Boundary Conditions

F.3.2.2.1 Open ocean boundary conditions

Two sides of the grid (see Figure F-17) were configured as the open boundary. These were assigned time-variable water levels, temperature, and salinity values. Predicted hourly water levels, daily temperature, and daily salinity from the calibrated coarse grid model were used to develop the open ocean boundary conditions. Predictions were extracted from the appropriate grids in the coarse grid model and then applied to the fine resolution open boundary grids. Available bacteria water quality data collected in the area had minimal TC, FC, and ENT bacteria densities (10 MPN/100ml, 10 MPN/100 ml, and 5 MPN/100 ml, respectively). Assuming that these values represent background bacteria densities from the other large-scale sources, they were incorporated in the model as the open ocean boundary conditions for TC, FC, and ENT.

F.3.2.2.2 Lateral boundary conditions

The contribution from subwatershed 2201 was included in the Shelter Island Shoreline Park receiving water model as a lateral boundary condition. Time variable wet weather and constant dry weather flow rates and bacteria loads were applied to the corresponding inflow grid cells. The model had two lateral inflow boundary conditions (one for wet weather and one for dry weather watershed runoff). Bacteria loads were computed based on TC, FC, and ENT bacteria densities output from the wet and dry weather watershed models.

Continuous surface temperature observations from NOAA station #9410170 located within the SDB shoreline were used to specify temperature for the watershed inflows. Salinity of the inflow water was set to zero.

Initially the receiving water model was run only with the wet and dry weather watershed modeled bacteria loading sources. Available water quality data collected from the Shelter Island Shoreline Park shoreline segment indicated that bacteria levels varied significantly, both temporally and spatially. Comparing the initial receiving water model-predicted bacteria densities with observed data (see Figure F-18 for a map of locations with available water quality monitoring data), the results indicated that the wet weather and dry weather watershed sources do not account for the magnitude and variability of bacteria densities observed in this area. The difference in the magnitude of bacteria densities between the initial receiving water model output and observed bacteria levels suggests that additional unquantified sources, other than watershed inflows, may contribute significantly to bacteria loading along the shoreline. Therefore, in addition to the lateral bacteria loading from the wet and dry weather watershed models, an additional loading source was included for each of the fine resolution cells along the shoreline to represent other unquantified bacteria sources such as waterfowl, beach sediment sources, and other unidentified sources within the water. These unquantified sources were lumped together as “lumped sources” and included in the receiving water model to account for additional wet and dry weather sources that were not sufficiently captured by the traditional watershed sources.

Additionally, it was assumed that there was a corresponding temporal variability present to generate the observed bacteria density fluctuations. The lowest observed bacteria density was considered as the background bacteria density. The days on which the observed bacteria density was equal to the background bacteria density were considered as “*background days*”. As an initial estimate, the TC and ENT bacteria loadings for *background days* were set to a base value. The base value was determined using the daily loading rate applied in a Malibu Creek Watershed Study (USEPA, 2003). The loading for days other than *background days*, was estimated by scaling the base values using the ratio between the observed bacteria density and the background density. Since the observed FC densities are similar to TC densities, the FC bacteria loading from the lumped sources was set to be equal to the TC bacteria loading from the lumped sources. These initial estimates were then systematically rescaled for the overall magnitude and fine-tuned for certain specific dates through an iterative modeling process to obtain predictions for bacteria densities closer to the observed patterns.

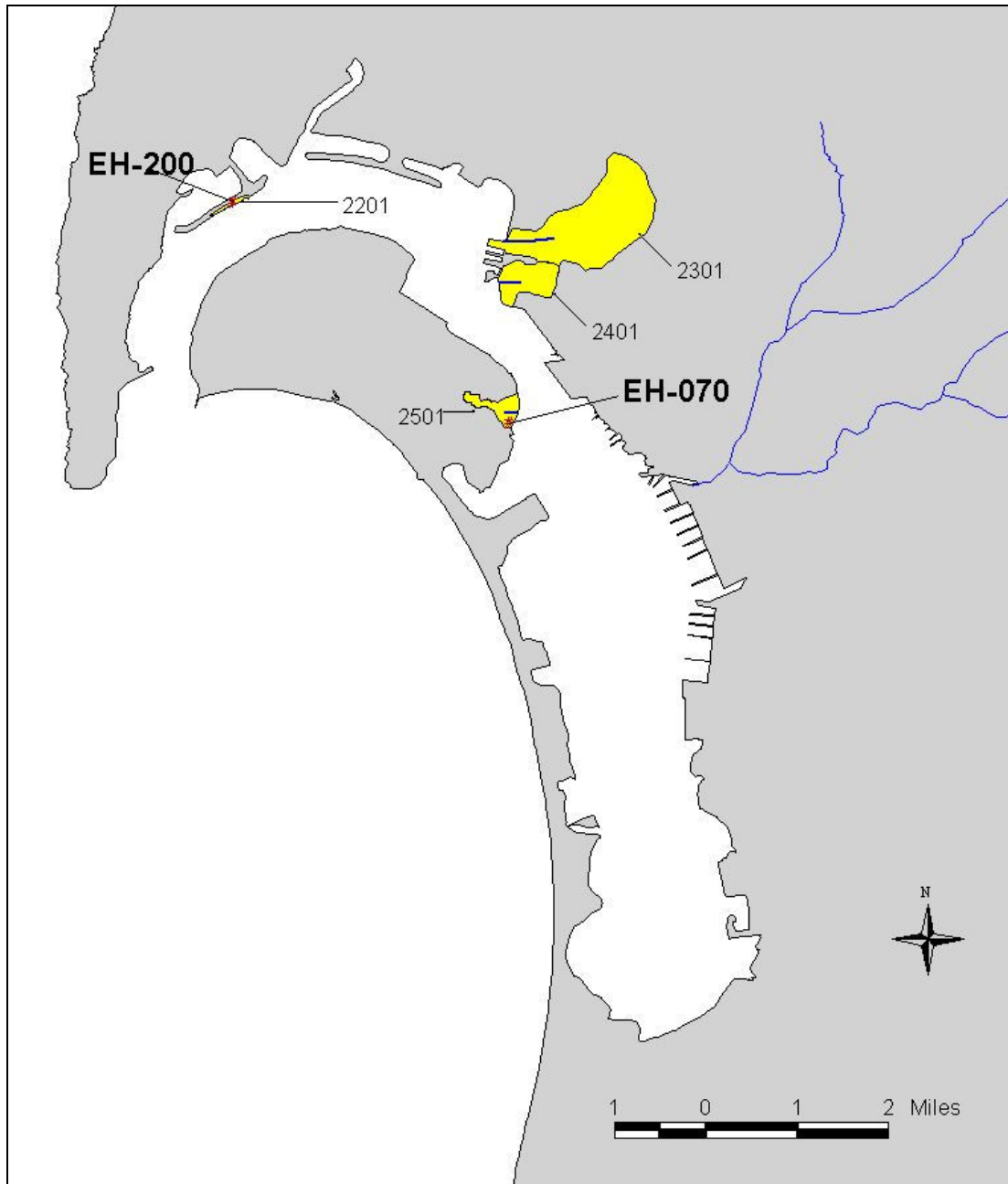

Figure F-18. Bacteria Monitoring Stations Along the San Diego Bay Shoreline
[Need to revised this figure]

F.3.2.2.3 Meteorological Boundary Conditions

Meteorological data from the Lindbergh Field Airway Station in San Diego were used to specify the water surface boundary conditions. Section F.3.1.2.3 provides a detailed description on the weather data required to perform the EFDC model simulations and the data processing that was necessary to obtain the appropriate format.

F.3.2.3 Initial Conditions

A uniform temperature of 15°C and a salinity of 33 ppt were included as the initial conditions throughout the water column. The initial velocity was set to 0.0 m/s and the water surface elevation was set to 0.0 meters above mean low sea level.

F.3.2.4 Inverse Loading Identification

In conventional water quality modeling practices, an important component of model development is the calibration of model parameter values based on observed receiving water quality and well-defined source/sink functions. However, this conceptual framework does not apply to this model since the quantification of major bacteria sources is not available. On the other hand, the kinetics impacting bacteria concentrations in water is relatively simple, where die-off is the dominant process controlling bacteria dynamics. Therefore, among all the major factors impacting bacteria densities in water, the kinetic parameter values contribute significantly less uncertainty than the unquantifiable sources. In other words, it is reasonable to set values commensurate to literature values for the bacteria die-off rate and subsequently use the model to inversely estimate the external sources that produce the observed temporal variability in bacteria concentration. This type of method represents a research field known as “inverse method”, which is widely applied in the areas of air quality modeling, ocean modeling, geo-hydrology, and other environmental research areas. In air quality modeling, the model is configured with reasonable parameter values and then applied to inversely estimate pollutant rates from different sources at different locations. This approach is justified when the key component of model uncertainty is from sources rather than from parameter values.

The receiving water model was used to simulate the fate and transport of TC, FC, and ENT within the near-shore zone. The base die-off rate of the three bacteria indicators were set to 0.8/day consistent with a typical value reported by Chapra (1997). In addition to the base die-off rate, temperature and salinity dependence ratios were applied. Salinity can contribute to the die-off rate at a ratio of $0.02\text{day}^{-1}\text{ppt}^{-1}$ (Chapra, 1997). There is no conclusive research to show that the die-off rates of the bacteria indicators are highly temperature dependent. Therefore, a low value of $1.01\text{ day}^{-1}\text{ }^{\circ}\text{C}^{-1}$ was included and was assumed to represent weak temperature dependence.

Using these parameter settings, the Shelter Island Shoreline Park receiving water model was run for the period from March 25, 2001 through October 30, 2002, and the simulated results were compared with observed data. For the dates that the receiving water model results did not correspond with the order of magnitude or trend of the observed data, the loading rate of the lumped sources (unquantified sources, which are assumed to be composed largely of bird sources) was fine-tuned until a reasonable agreement between the receiving water model results and the observed data were achieved. Figure I-57 of Appendix I graphs the simulated bacteria density against the observed data. As shown, with the inversely derived lumped source loading, the receiving water model was able to reproduce the observed bacterial level near the shoreline relatively well. The adjusted lumped source loading for the simulation period is shown in Figure I-58 of Appendix I. No other fine-tuning was performed to further

improve the goodness-of-fit. Since the uncertainty associated with bacteria water quality data can be significant, the objective of the modeling was to follow the general trend and estimate the order of magnitude present in the observed data.

It should be noted that the inversely estimated loading is not fictitious, but rather consistent with reality. Observed data show that there is a peak of TC bacteria density on July 29, 2002 (maximum value of 250,250 MPN/100 ml); however, the wet weather and dry weather watershed bacteria loads did not show significant loading during that time period. The only explanation for such high bacteria levels is the presence of significant additional bacteria loading source(s) during that time period. Two days later on July 31, 2002, it was also observed that the TC bacteria density at the same location was 10 MPN/100 ml. This type of rapid change in bacteria concentrations demonstrates the unique local relationship between bacteria loadings and densities. As shown through the receiving water model results (Figure I-57 of Appendix I), the model was able to predict sharp changes in bacteria concentrations caused by loading rates and tidal conditions within a short period of time.

F.3.3 Dana Point Harbor Receiving Water Model

F.3.3.1 Grid Generation

The DPH receiving water model includes the harbor up to the outer barrier and then extends approximately 5 kilometers in the south-east direction into the open ocean. The grid consists of 62 computation cells in the horizontal plane (Figure F-19) and each cell is represented by a single vertical layer. Six additional barrier features were setup to represent the grid cells that have one or more flow faces blocked from marina breakwaters (Figure F-20). All six barriers were assigned to the western face of each cell. Bathymetry for the model domain was based on DRGs obtained through the California Spatial Information Library website (<http://casil.ucdavis.edu/>). The average grid depth was 5 meters (minimum was 1 meter and maximum was 9 meters).

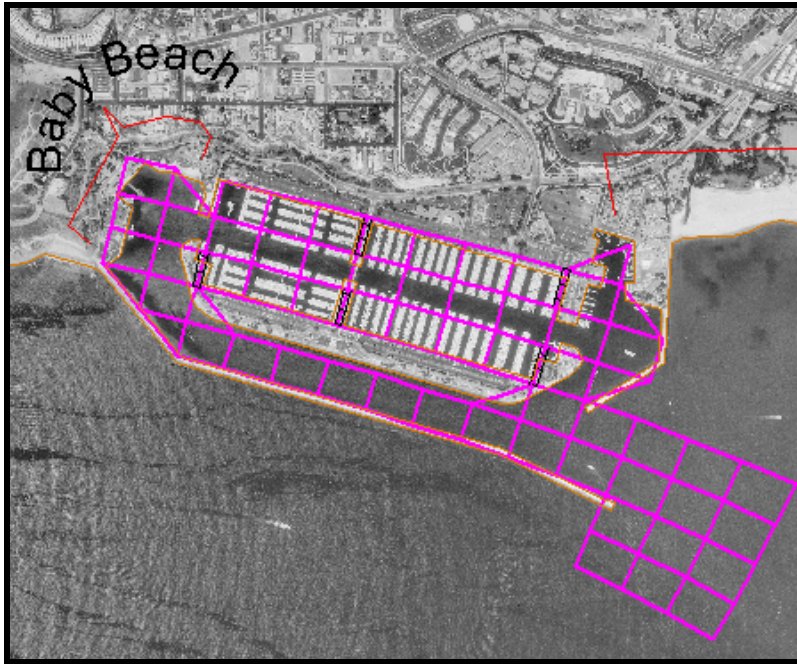

Figure F-19. Grid for the Dana Point Harbor

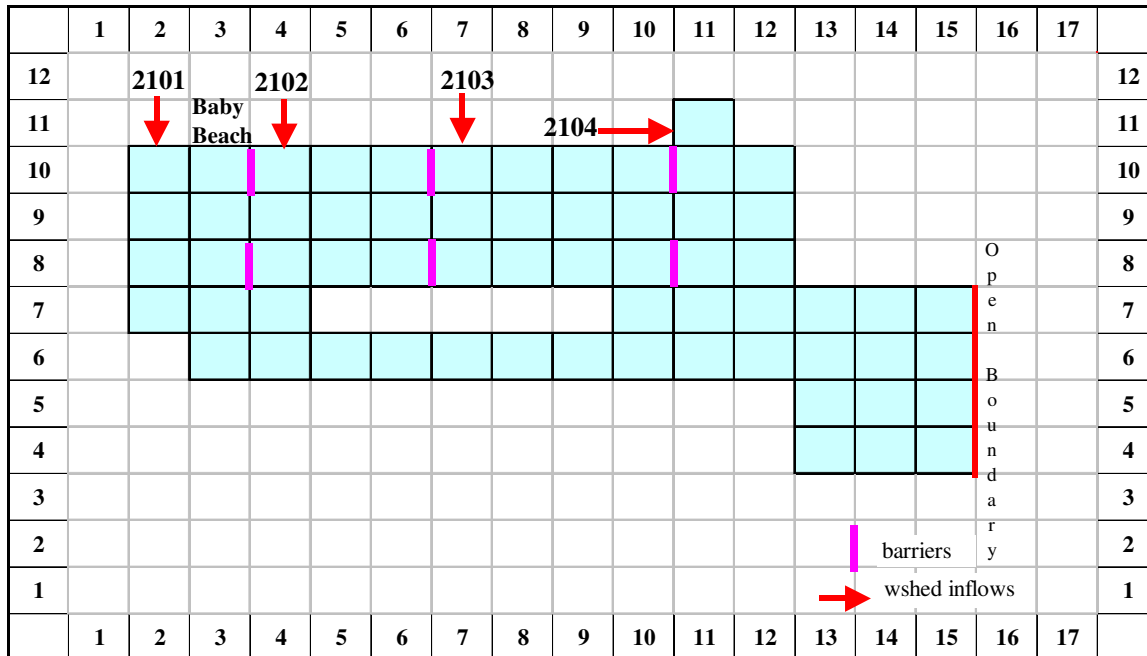

Figure F-20. Open Ocean and Lateral Boundary Locations for Dana Point Harbor Model

F.3.3.2 Boundary Conditions

F.3.3.2.1 Open ocean boundary conditions

Four grids in the eastern boundary of the model were configured as open ocean boundary conditions and were assigned time-variable water levels (Figure F-20). Real-time water level data were available through the NOAA-COOPS website for select locations in southern California. The closest station to DPH was Los Angeles, which is about 80 kilometers away. Therefore, to more accurately portray tidal fluctuations, the tidal predictions for San Clemente were used to develop the open ocean boundary conditions since this location is closer in proximity to DPH.

To predict the time-variable water levels at San Clemente, data were obtained for its assigned reference station, San Diego (Broadway). Specifically, hourly tidal predictions for San Diego (Broadway) for 2000 through 2004 were obtained from NOAA-COOPS. The phase and amplitude of the tide at San Clemente was then calculated based on these reference data. To account for the time difference between tides at San Clemente and San Diego (Broadway), an average lag time of 13 minutes was included in the calculation of the San Clemente phase (actual lag times are 15 minutes for high tide and 11 minutes for low tide). In addition, an amplitude ratio of 0.92 (as specified on the NOAA-COOPS website) was used to convert the tidal height from the San Diego (Broadway) values to corresponding heights at San Clemente. After completing these calculations, the data were processed and an EFDC-compatible tidal time series was created.

Scripps Institution of Oceanography station #096, located 3.7 miles west of Dana Point, provided temperature data for the open ocean boundary. Data with a 30-minute frequency were converted to build the EFDC-compatible temperature time series. Specifically, since temperature data from station #096 is not exactly the same as the temperature at the open ocean boundary, the 30-minute data was averaged to daily values to filter out the impact of any short period temperature signals, which may not be representative of the true condition at the boundary and may result in model instability. There were no salinity data identified for DPH. Therefore, the same salinity time series used for the SDB model (see Section F.3.1.2.1) was used for the DPH open ocean boundary.

F.3.3.2.2 Lateral boundary conditions

Contributions from subwatersheds 2101 and 2102 were included as lateral boundary conditions for DPH. The wet weather flows and bacteria loads were configured based on simulation results from the LSPC watershed model. Nuisance runoff rates and associated bacteria loads were obtained from the steady-state dry weather watershed spreadsheet model, originally developed and calibrated for Bacteria TMDL Project I. The spatial representation of these inflow boundary conditions was determined by mapping the geographical coordinates of the watershed outlets to the model grid. Flow and bacteria loading output from the wet and dry weather watershed models were processed to build a time series for each tributary in EFDC-compatible format, which was then applied to the corresponding grid cells. In total, the model has four lateral inflow boundary conditions (two for wet weather and two dry weather watershed runoff).

Available data collected from four locations along the Baby Beach shoreline segment indicated that bacteria levels varied significantly both temporally and spatially. As with the Shelter Island Shoreline Park fine grid receiving water model, in addition to the lateral bacteria loading from the wet weather and dry weather watershed models, an additional loading source was included for each of the cells along the shoreline to represent the contribution from lumped sources (unquantified sources such as waterfowl, unidentified human sources, beach sediment sources, and other unidentified sources within the water).

Uniform bacteria densities (MPN/100ml) for TC, FC, and ENT and associated seasonally-variable surface flow rate (cms/m^2) were used to apply a lumped source loading in units of MPN/day at the computation cells adjacent to the Baby Beach shoreline segment. Seasonal variability in the unit area flow rate takes into account factors such as the seasonal bird population. To estimate the load allocation from lumped sources, the receiving water model was run with and without this lumped source load, as described in Section F.3.6.4.

There were no data identified for the temperatures of tributaries flowing into DPH. Therefore, the same temperature time series used at the open ocean boundary was used to provide temperature for all wet and dry weather watershed inflows. Salinity of the inflow waters was set to zero since no data were available.

F.3.3.2.3 Meteorological boundary conditions

El Toro Marine Corps Air Station is the closest Airway station to DPH; however, records from the El Toro station did not extend through the calibration time period. Therefore, a meteorological file was created using data from Lindbergh Field Airway Station in San Diego. Hourly data for the El Toro and Lindbergh Field stations were compared for January to June of 1997 and were found to be very similar for several meteorological parameters. As a result, the Lindbergh Field station was used to represent dry and wet bulb temperature, relative humidity, wind speed, wind direction, sea level pressure, and sky conditions for 1990 to 2004. Sky conditions were converted to “percent cloud cover” and solar radiation was estimated by calculating the clear sky solar radiation using latitude and longitude and adjusting the values based on the estimated cloud cover.

F.3.3.3 Initial Conditions

A uniform temperature of 15°C and a salinity of 35 psu were specified as the initial conditions throughout the water column. The initial water velocity was set to 0.0 m/s and water surface elevation was set to 0.0 meters above mean sea level.

F.3.3.4 Inverse Loading Identification

The receiving water model was used to simulate the fate and transport of TC, FC, and ENT within the near-shore zone. Bacteria kinetics (including bacteria die-off rates and the temperature and salinity impact on the die-off rate) were the same as those described for the SDB Shelter Island Shoreline Park fine grid model (see Section

F.3.2.4). Bacteria water quality observations were available at four stations along the Baby Beach shoreline segment – BDP 12, 13, 14 and 15 (see Figures I-60 and I-61 of Appendix I); however, BDP 12, 13 and 14 fall within one computation cell of the DPH grid. Therefore, data at those three stations were averaged to obtain a mean value.

Initially the receiving water model was run only with the wet and dry weather watershed modeled bacteria loading sources. Bacteria die-off rates were not considered for this simulation. Comparing the initial receiving water model-predicted bacteria densities with observed data the results indicated that the wet weather and dry weather watershed sources do not account for the magnitude and variability of bacteria densities observed in this area. The difference in the magnitude of bacteria densities between the initial receiving water model output and observed bacteria levels suggests that additional unquantified sources, other than watershed inflows, may contribute significantly to bacteria loading along the shoreline.

Next, as in the SDB fine grid receiving water model for Shelter Island Shoreline Park (see Section F.3.2.2.2), the DPH receiving water model was used to inversely estimate external bacteria loading sources that would produce the observed temporal variability in bacteria densities. However, in the DPH receiving water model, loading from lumped sources was not adjusted to match individual bacteria observations. Instead, the seasonal loading rate was adjusted to match the 30-day geometric mean of the observed data. A higher load was applied between 30 to 90 days and 330 to 390 days (days are relative to the modeling starting time of January 1, 2001) since the observed bacteria densities in the region were high during those time periods. A lower load was applied during other times to correspond with the lower observed bacteria densities.

Figures I-62 through I-64 of Appendix I show the simulated bacteria densities plotted against the 30-day geometric mean for the observed data. As shown with the seasonally-variable lumped source loading, the model was able to reproduce the observed bacterial level near the shoreline relatively well. The adjusted seasonally-variable lumped source loading for the simulation period at the two cells bordering Baby Beach is shown in Figure I-65 of Appendix I.

F.4 Application of the Watershed and Receiving Water Models

The EFDC receiving water models incorporated bacteria loads and flow rates from the wet and dry weather watershed models as lateral boundary conditions. Therefore, all TMDL calculations were based on output from the comprehensive EFDC models for the corresponding impaired shoreline segment. Additional, localized sources of bacteria associated with lumped sources (unquantified sources such as waterfowl, unidentified human sources, beach sediment sources, and other unidentified sources within the water) were simulated for each shoreline segment based on model simulations to reproduce observed conditions within the waters. These loads from lumped sources, in addition to watershed sources, were used to determine existing conditions and load allocations to sources.

After completing all model simulations, the EFDC model was applied to obtain hourly and average daily output for the critical wet and dry periods described in Section 7 of the Technical Report. The maximum hourly TC, FC, and ENT densities were obtained for a 30-day critical period for each impaired shoreline model zone. These concentrations were used to determine compliance to numeric targets for TMDL calculation. If bacteria densities exceeded the selected numeric targets, bacteria loads to the receiving water from controllable sources were reduced until compliance was reached. The resulting bacteria loads were equivalent to the TMDL and associated load and wasteload allocations.

While this modeling effort was useful in calculating TMDLs for impaired shorelines in SDB and DPH, future expansion of the model can greatly increase its accuracy and utility. If data become available that quantify the bacteria loading from birds and other unknown sources (both directly to the waterbodies and to the near-shore areas), this modeling system can be modified and expanded to capture detail on all available sources. The model can also be expanded to incorporate bacteria simulations if data become available near the segments where bacteria data were unavailable. Adding any additional detail to the model would allow for more specific load and wasteload allocations. In addition, the incorporation of more data would enhance the range of scenarios that can be simulated to assist the San Diego Water Board and stakeholders with implementation of the TMDL.

Appendix G

Assumptions for Model Development and TMDL Calculation

G.1 Wet Weather Modeling Assumptions

The watershed and receiving water modeling system developed to represent wet weather conditions is reported in Appendix F of the Technical Report. The following assumptions are relevant to the LSPC and EFDC models developed to simulate wet weather sources of bacteria and assimilative capacities of receiving waters.

- *General LSPC/HSPF Model Assumptions* - Many model assumptions are inherent in the algorithms used by the LSPC watershed model and are reported extensively in Bicknell et al. (1996).
- *Land Use* - A combination of SCAG, SANDAG, and MRLC land use GIS datasets is assumed representative of the current land use areas. For areas where significant changes in land use have occurred since the creation of these datasets, model predictions may not be representative of observed conditions.
- *Stream Representation* - Each delineated subwatershed was represented with a single stream/storm drain assumed to be a completely mixed, one-dimensional segment with a trapezoidal cross-section.
- *Hydrologic Modeling Parameters* - Hydrologic modeling parameters were developed during previous modeling studies in Southern California (e.g., LA River, San Jacinto River) and refined through calibration to streamflow data collected in the San Diego region. Through the calibration and validation processes (reported in Appendix F of the Technical Report), a set of modeling parameters were obtained specific to land use and hydrologic soil groups. These parameters are assumed to be representative of the hydrology of other watersheds in the San Diego region that are presently ungauged and therefore unverified.
- *Water Quality Modeling Parameters* - Dynamic models require a substantial amount of information regarding input parameters and data for calibration purposes. All sources of indicator bacteria from watersheds are represented in the LSPC model as build-up/wash-off from specific land use types. Limited data are currently available in the San Diego region to allow development of unique modeling parameters for simulation of build-up/wash-off, so parameters were obtained from a similar study performed in the Los Angeles region. These build-up/wash-off modeling parameters were originally developed by SCCWRP for a watershed model of the Santa Monica Bay Beaches (Los Angeles Water Board, 2002), and are assumed representative of land use sources in the San Diego region. This assumption was validated through evaluation of model results with local data in the San Diego Region. Results of model validation were reported in Bacteria TMDL Project I (San Diego Water Board, 2007).

- *Lumped Parameter Model Characteristic* - LSPC is a lumped-parameter model and is assumed to be sufficient for modeling transport of flows and bacteria loads from watersheds in the region. For lumped parameter models, transport of flows and bacteria loads to the streams within a given model subwatershed cannot consider relative distances of land use activities and topography that may enhance or impede time of travel over the land surface. Although this limitation could result in mistiming of peak flows or under-prediction of bacteria die-off because overland losses are not simulated, impacts are assumed minimal.
- *First-order Bacteria Die-off* - Each stream is modeled assuming first-order die-off of bacteria. Bacteria die-off rates for wet weather are assumed as 0.8/day, based on sensitivity analyses performed by SCCWRP (Los Angeles Water Board, 2002).
- *In-stream Bacteria Re-growth* - The LSPC model assumes no in-stream regrowth of bacteria. No data or literature were located to provide indication that such sources are significant during wet weather or could be estimated for model input.
- *SDB and DPH Shoreline Bacteria Die-off* – The base die-off rates of the three species of bacteria were set to 0.8/day, consistent with default literature values reported by Chapra (1997). In addition to the base die-off rate, temperature and salinity dependence ratios were applied. Salinity can contribute to the death rate at a ratio of $0.02\text{day}^{-1}\text{ppt}^{-1}$ (Chapra, 1997). There is no conclusive research to show that the die-off rates of the three indicator bacteria species are highly temperature dependent. Therefore, a low value of $1.01\text{ day}^{-1}\text{ }^{\circ}\text{C}^{-1}$ was included and was assumed to represent weak temperature dependence.
- *Direct Nonpoint Source Loading to SDB and DPH* – Loads from waterfowl and other unquantified nonpoint sources (e.g., other sources within the water) directly to the receiving were calculated based on dry weather modeling analyses described in the next section.

G.2 Dry Weather Modeling Assumptions

The watershed and receiving water modeling system developed for simulation of quasi-steady-state dry weather flows and sources of bacteria are reported in Appendix F of the Technical Report. The following assumptions are relevant to that discussion.

- *Steady-state Watershed Model Configuration* - Although it is understood that dry weather flows and bacteria densities vary over time for any given stream, for prediction of average conditions in the stream, flows and concentrations are assumed as steady state.
- *Sources for Characterization of Dry Weather Watershed Loads* - Data used for characterization of dry weather flows and water quality are assumed representative of conditions throughout the region.

- *Methods for Characterization of Dry Weather Watershed Loads* - The equations derived through multivariable regression analyses are assumed sufficient to represent the dry weather flows and water quality as functions of land use and watershed size.
- *Stream Bacteria Re-growth* - The dry weather model assumes no in-stream sources or regrowth of bacteria. No data or literature were located to provide indication that such sources are significant during wet weather or could be estimated for model input
- *SDB and DPH Shoreline Bacteria Die-off* – The base die-off rates of the three species of bacteria were set to 0.8/day, consistent with default literature values reported by Chapra (1997). In addition to the base die-off rate, temperature and salinity dependence ratios were applied. Salinity can contribute to the death rate at a ratio of $0.02\text{day}^{-1}\text{ppt}^{-1}$ (Chapra, 1997). There is no conclusive research to show that the die-off rates of the three indicator bacteria species are highly temperature dependent. Therefore, a low value of $1.01\text{ day}^{-1}\text{ }^{\circ}\text{C}^{-1}$ was included and was assumed to represent weak temperature dependence.
- *Direct Nonpoint Source Loading to SDB and DPH* – Loads from waterfowl and other unidentified nonpoint sources (e.g., other sources within the water) directly to the receiving were calculated using EFDC models to take up the remaining assimilative capacity of the waterbodies after wasteload allocations to dry weather runoff.

G.3 Assumptions for TMDL Calculation

Calculation of TMDLs, load allocations, and recommended load reductions were reported in Section 8 of the Technical Report. The following assumptions are applicable to this discussion.

- *Critical Location for Loading Assessments* - For SDB and DPH shorelines, the critical locations for meeting numeric targets include the entire length of impaired shoreline. For model development, receiving waters at impaired shorelines were represented in the model with multiple grid cells (see Appendix F). Therefore, for each of the impaired shorelines, a weighted average of bacteria concentration was calculated based on respective length of shoreline ($\text{Avg. Conc.} = \frac{\sum [\text{Length} \times \text{Conc.}]}{\sum \text{Length}}$) of each model grid cell located adjacent to that shoreline. This resulted in a single representative bacteria concentration for each impaired shoreline addressed in this TMDL.
- *TMDL Numeric Targets* – Separate numeric targets are used for wet and dry weather TMDL calculations. For wet weather, the single sample maximum WQOs were used to assess exceedance of the TMDL. For dry weather, both the 30-day geometric mean and the single sample maximum WQOs were used to assess exceedances. For each condition, selection of the applicable numeric

target provides assurance of the protection of beneficial uses in the impaired waterbodies and is consistent with state and federal guidance.

- *Wet Weather Critical Condition* – To assess the response of the receiving waters due to variable critical watershed loads, a specific 30-day period of 1993 was selected for detailed assessment. This shortened period facilitated detailed analyses of the hourly or diurnal conditions that impact the water quality, rather than a longer-term, daily evaluation of loads. A critical wet weather period of 1993 was identified from January 7th through February 5th, which corresponded to five to ten of the top 1st percentile of flow magnitudes (daily averages) simulated by LSPC from January 1, 1990 to May 31, 2004, depending on location. In addition to this 30-day critical wet weather watershed loading period, a 30-day critical tidal period was assumed based on observed data from March 7, 2001 to April 7, 2001. These two critical 30-day periods were combined in the model to provide the most conservative bacteria loading scenario.
- *Dry Weather Critical Condition* – For the EFDC model of receiving waters, the critical period for TMDL calculation assumed tidal variations based on observed data from March 7, 2001 to April 7, 2001. During this period, tidal variations were determined through modeling analyses to have critical impacts on the assimilative capacities of the receiving waters.
- *Reduction of Dry Weather Watershed Loads* - Watershed loads were reduced to bacteria densities consistent with geometric mean WQOs, thus ensuring that controllable sources of bacteria are addressed. Such conservativeness provides a MOS by ensuring that targets are met at increasing distances from the discharge, where dilution and die-off in the receiving waters occur.

Appendix H

Existing and Reduced Concentrations Wet Weather

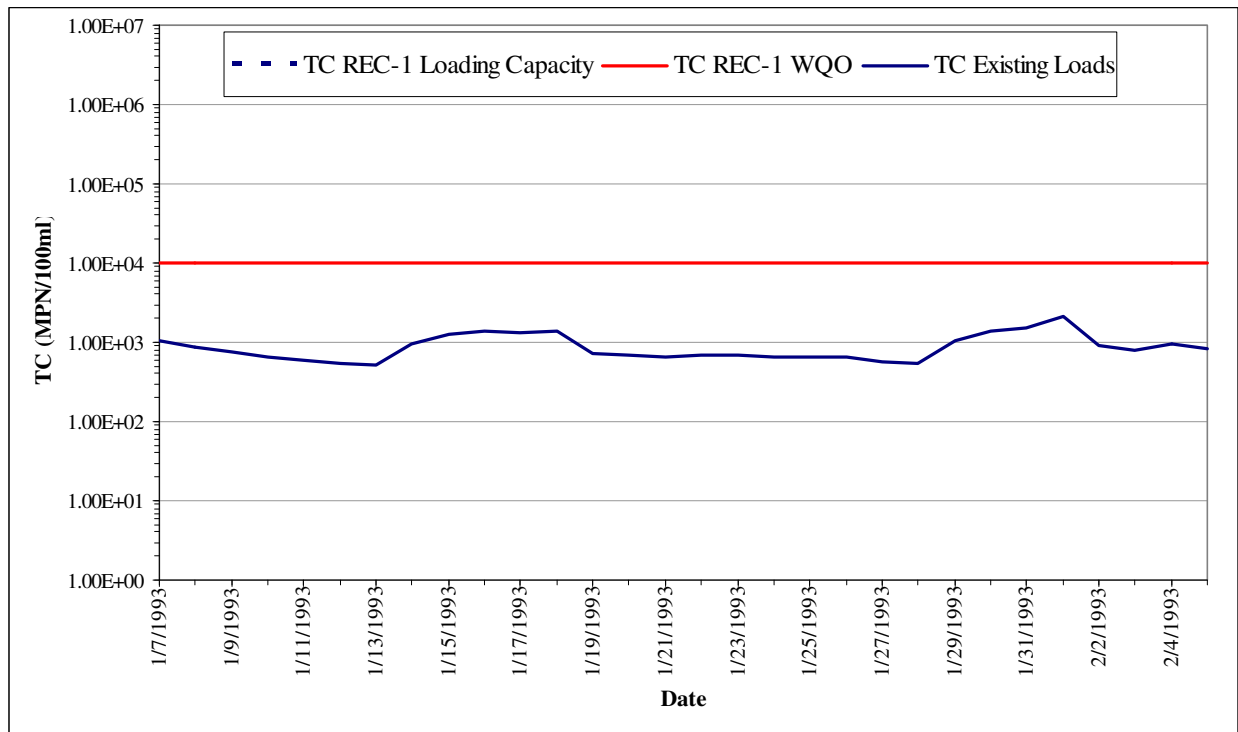

Figure H-1. Existing and Reduced Total Coliform Concentrations at Shelter Island Shoreline Park, San Diego Bay-Wet Weather (Comparison to Single Sample Maximum WQO)

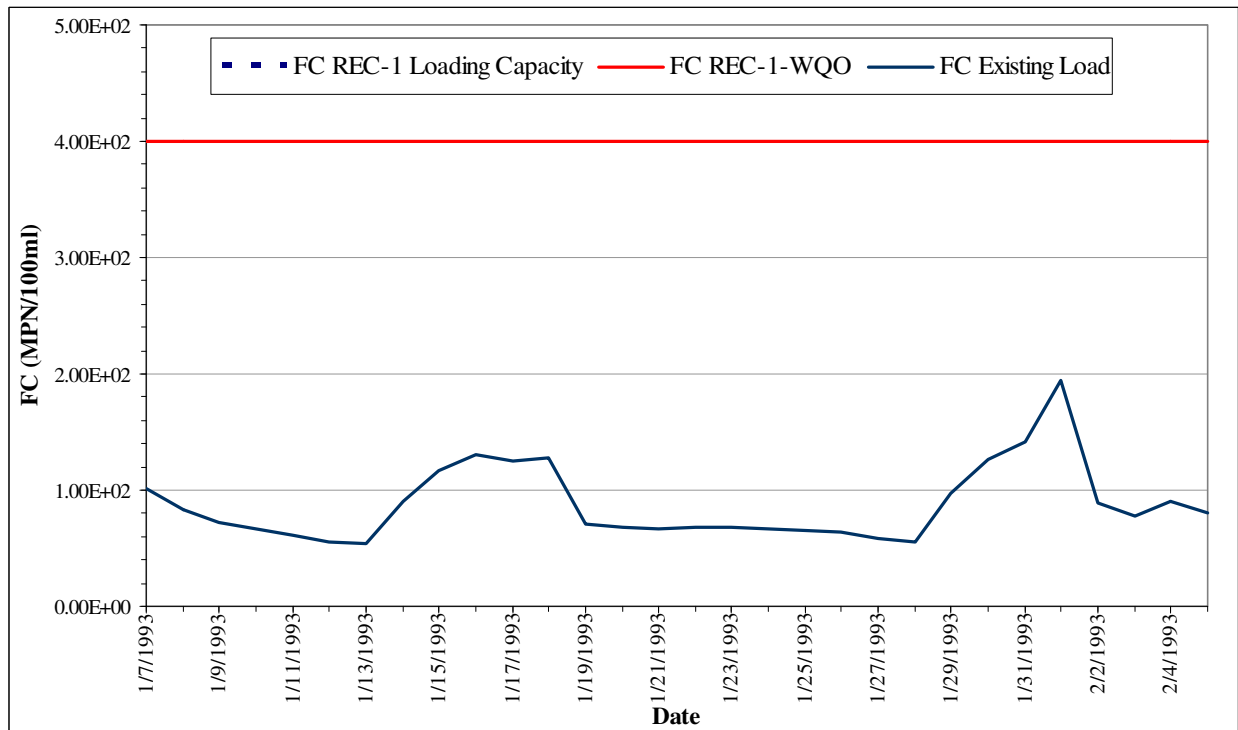

Figure H-2. Existing and Reduced Fecal Coliform Concentrations at Shelter Island Shoreline Park, San Diego Bay-Wet Weather (Comparison to Single Sample Maximum WQO)

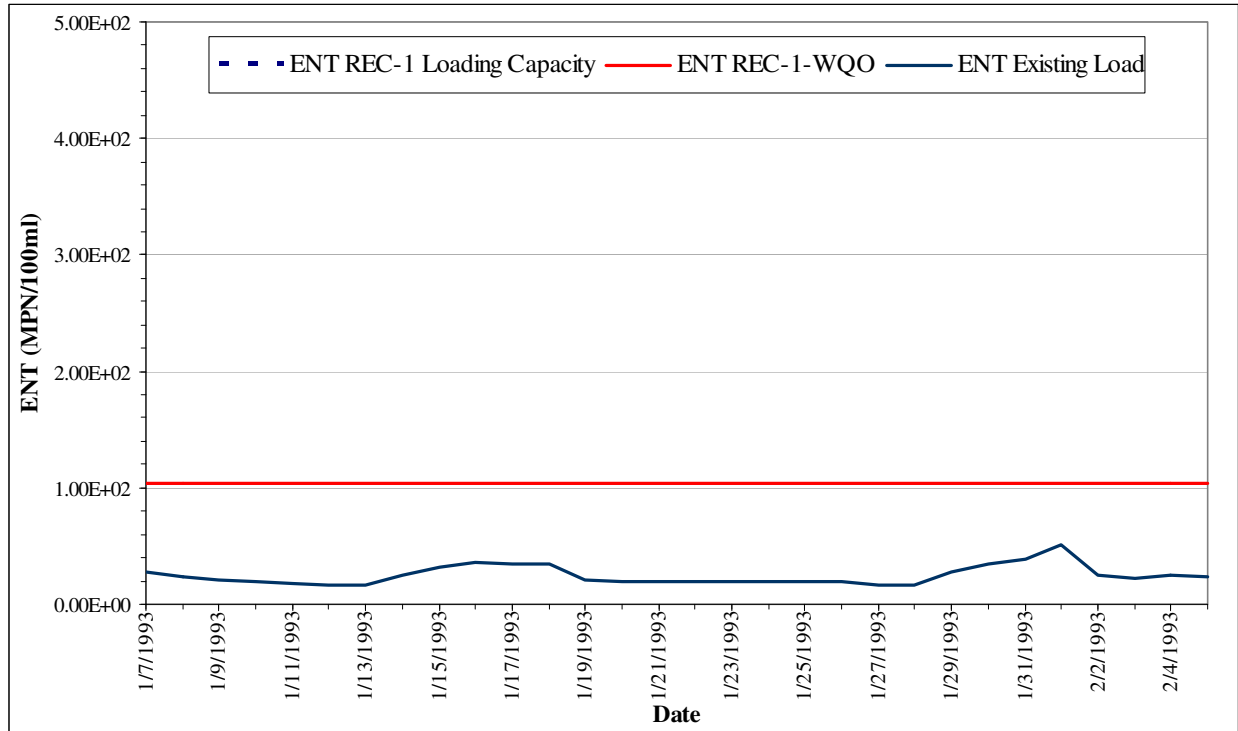

Figure H-3. Existing and Reduced Enterococcus Concentrations at Shelter Island Shoreline Park, San Diego Bay-Wet Weather (Comparison to Single Sample Maximum WQO)

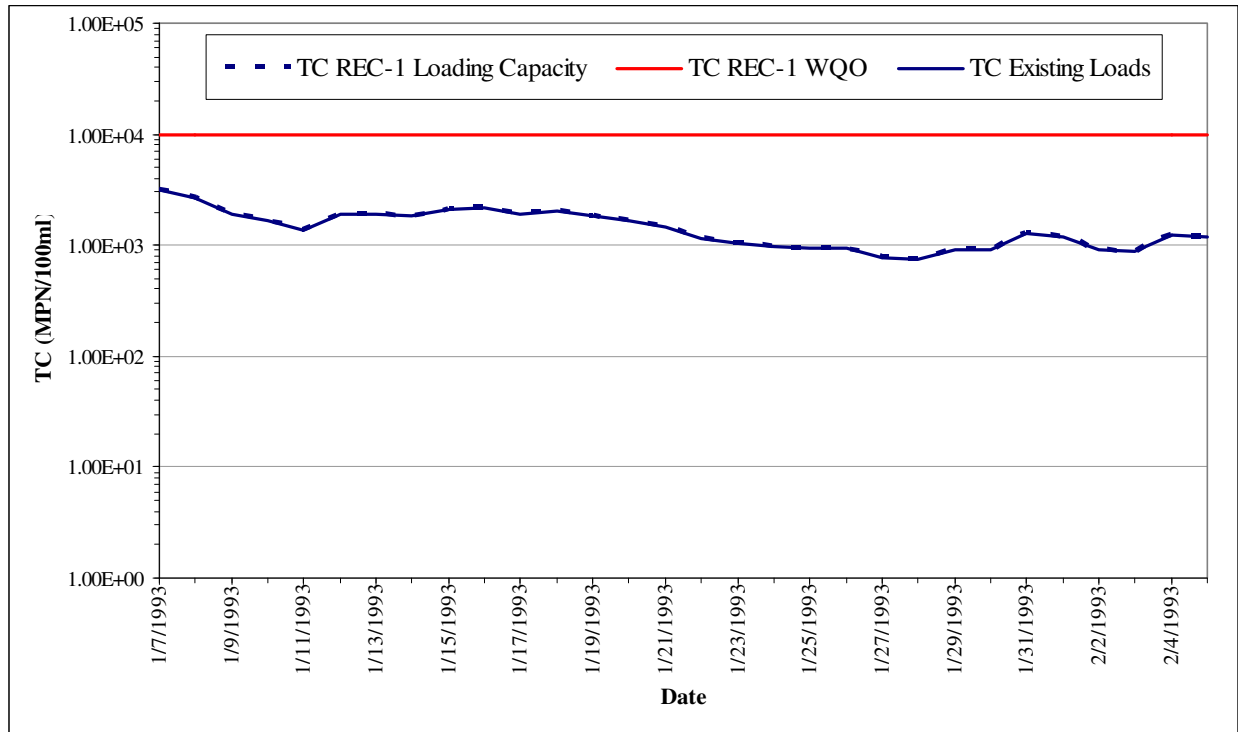

Figure H-4. Existing and Reduced Total Coliform Concentrations at Baby Beach Shoreline, Dana Point Harbor-Wet Weather (Comparison to Single Sample Maximum WQO)

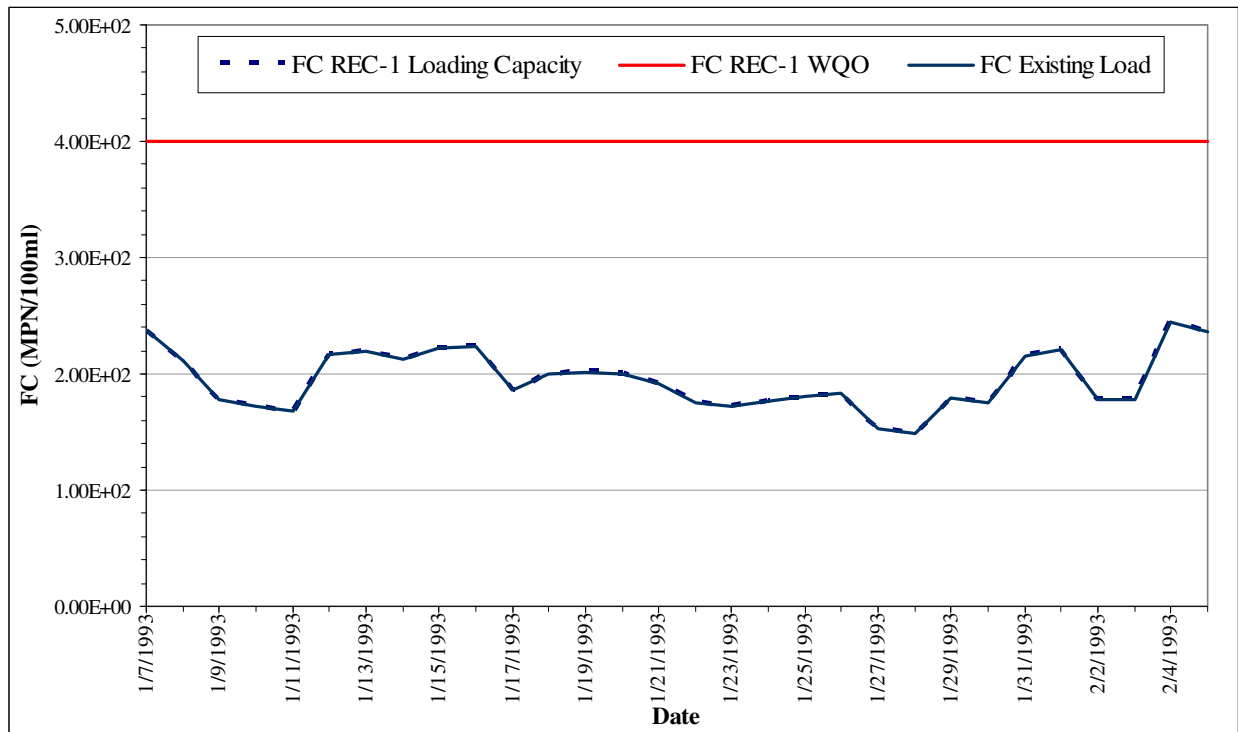

Figure H-5. Existing and Reduced Fecal Coliform Concentrations at Baby Beach Shoreline, Dana Point Harbor-Wet Weather (Comparison to Single Sample Maximum WQO)

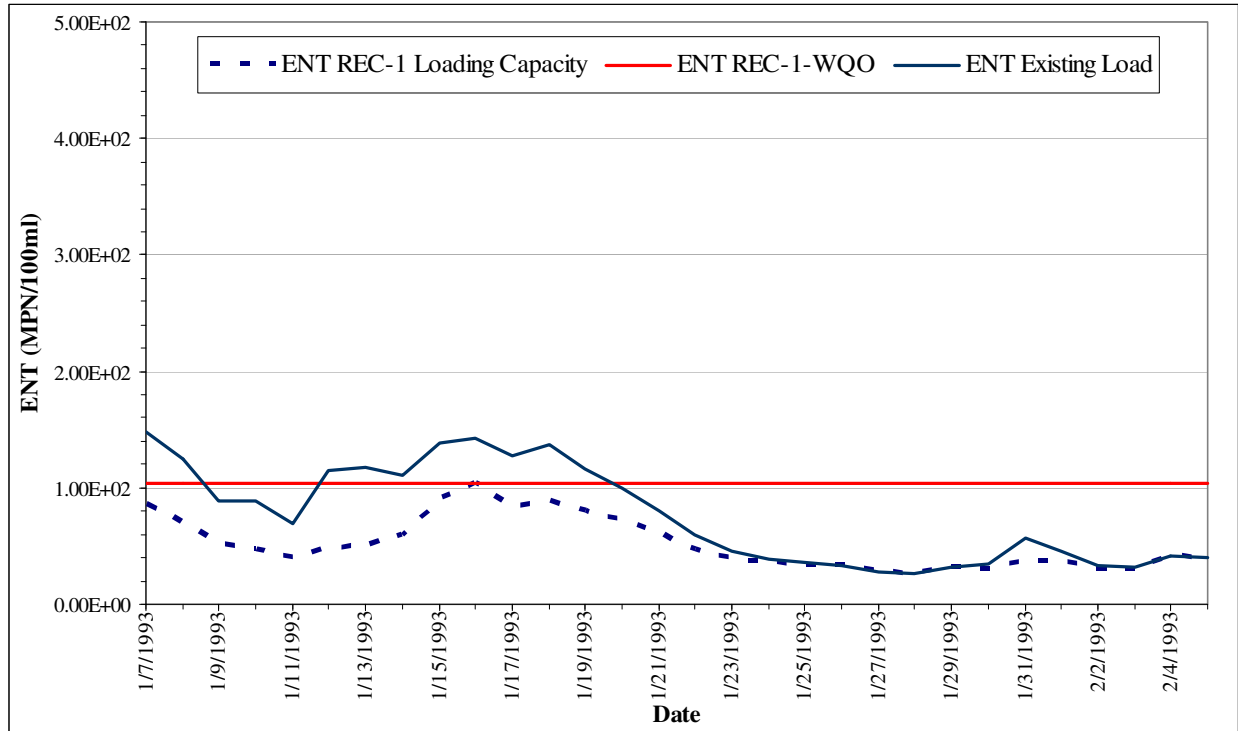

Figure H-6. Existing and Reduced Enterococcus Concentrations at Baby Beach Shoreline, Dana Point Harbor-Wet Weather (Comparison to Single Sample Maximum WQO)

Appendix I

EFDC Calibration and Modeling Results

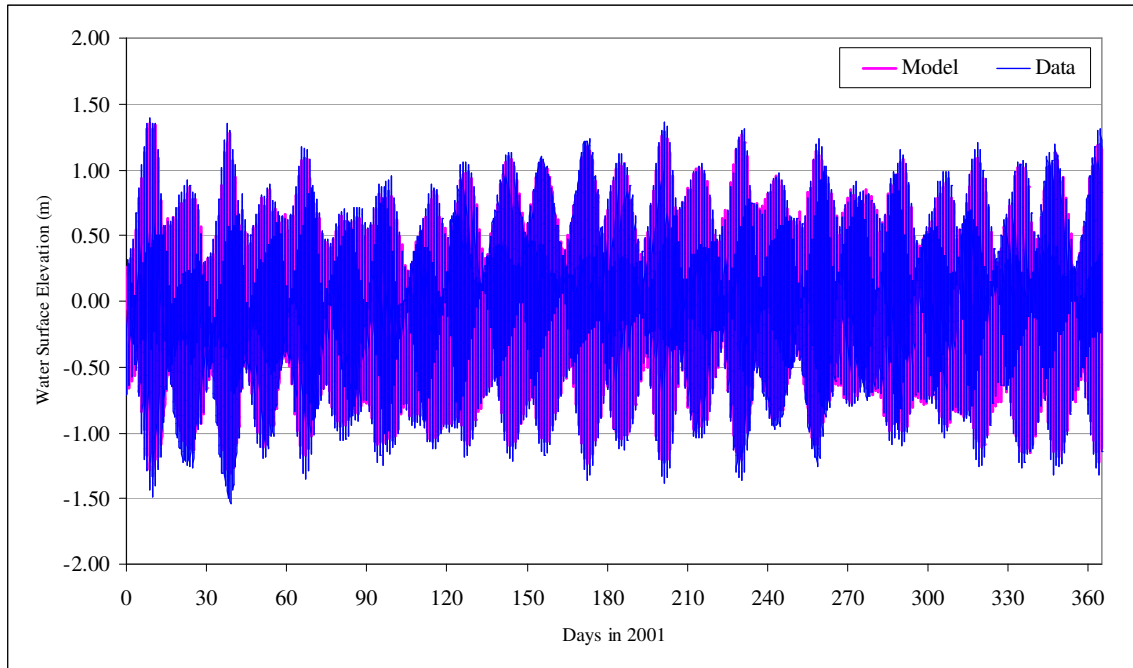

Figure I-1. Comparison of 2001 Model Computed Water Surface Elevations with Data for NOAA-COOPS Station #9410170

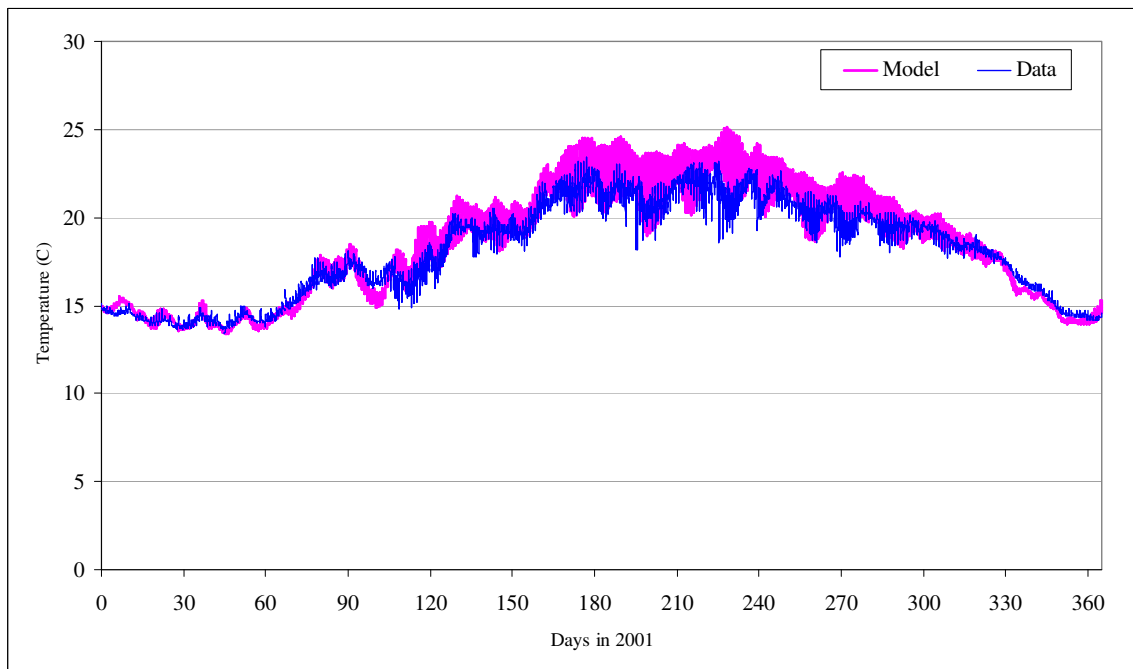

Figure I-2. Comparison of 2001 Model Computed Temperature Results with Data for NOAA-COOPS Station #9410170

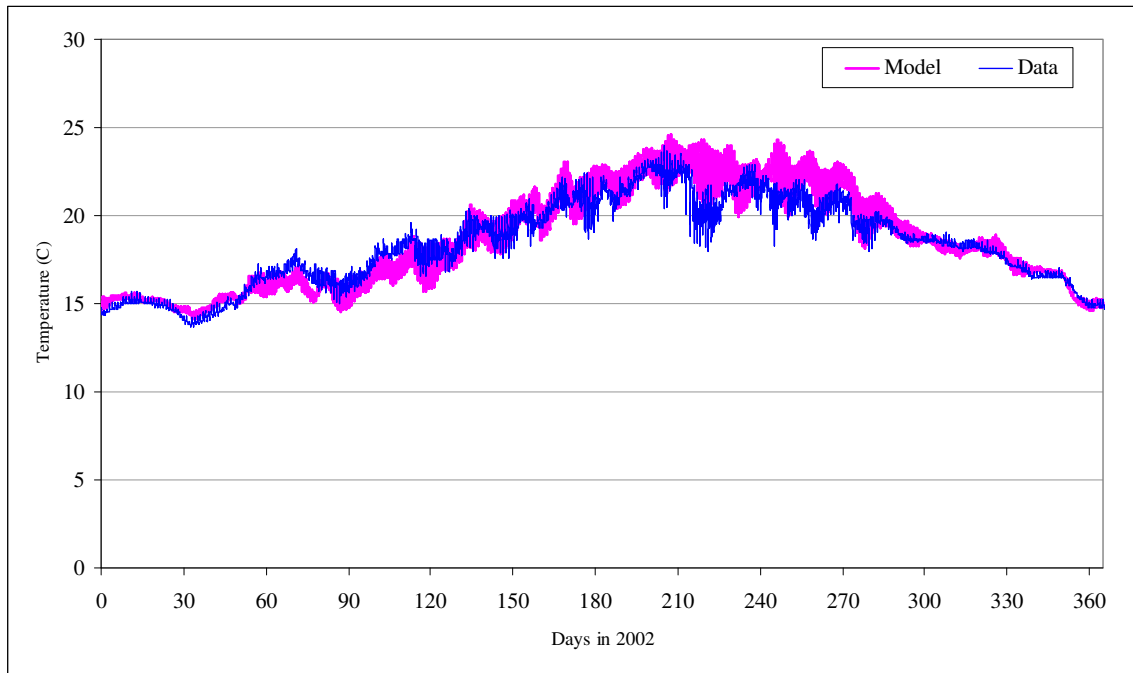

Figure I-3. Comparison of 2002 Model Computed Temperature Results with Data for NOAA-COOPS Station #9410170

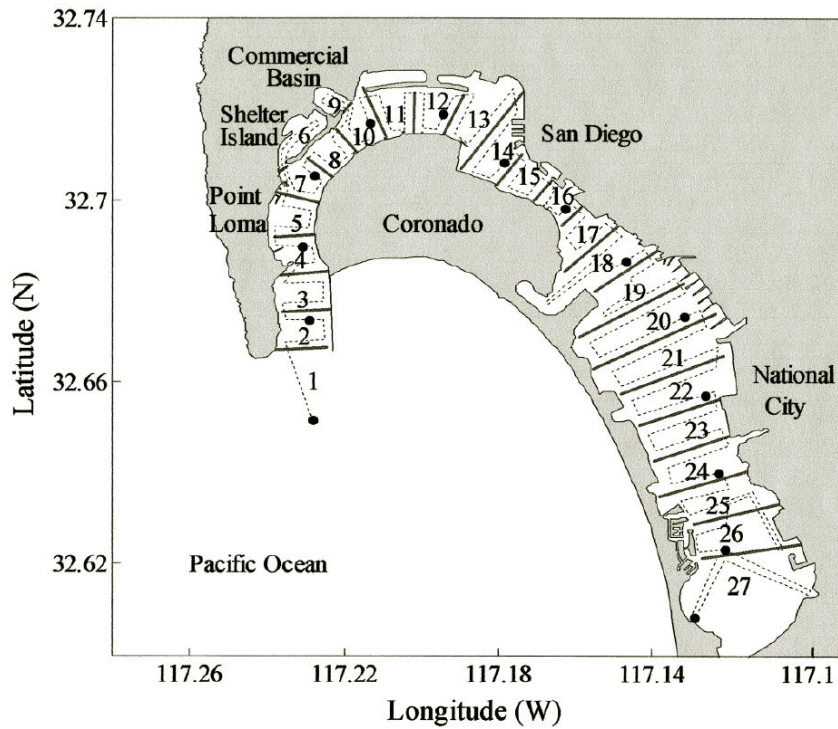

Figure I-4. Map of Temperature and Salinity Sampling Stations in San Diego Bay (SPAWAR, 2005)

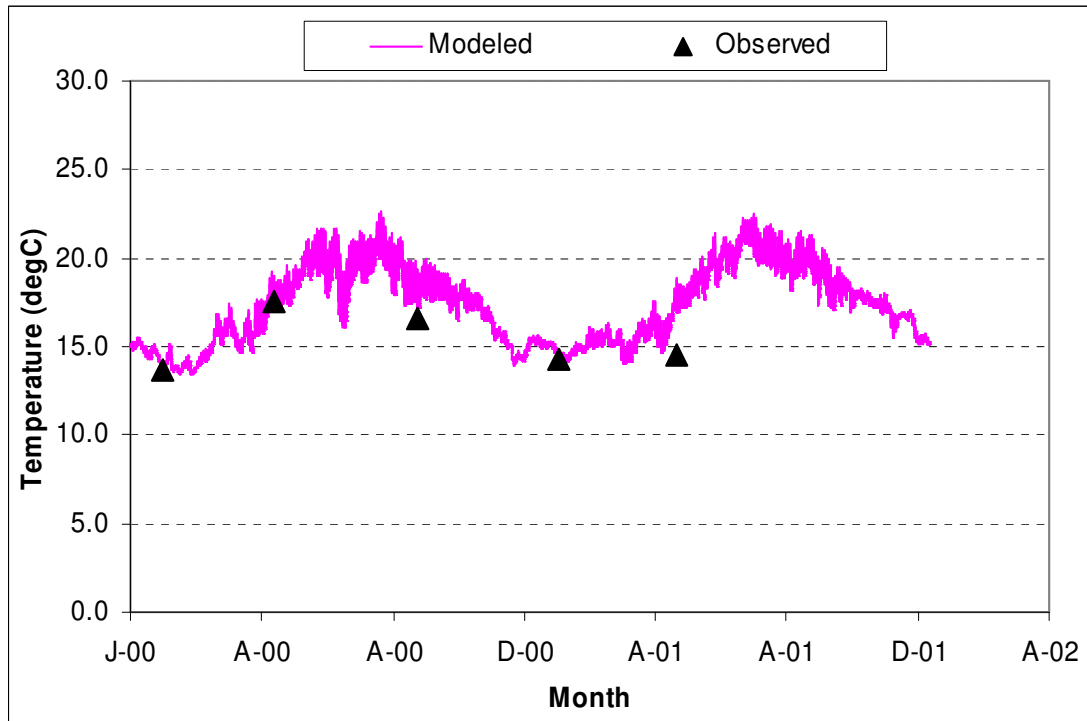

Figure I-5. Comparison of Model Predicted Temperature Results with Observed SPAWAR Results at Station #1

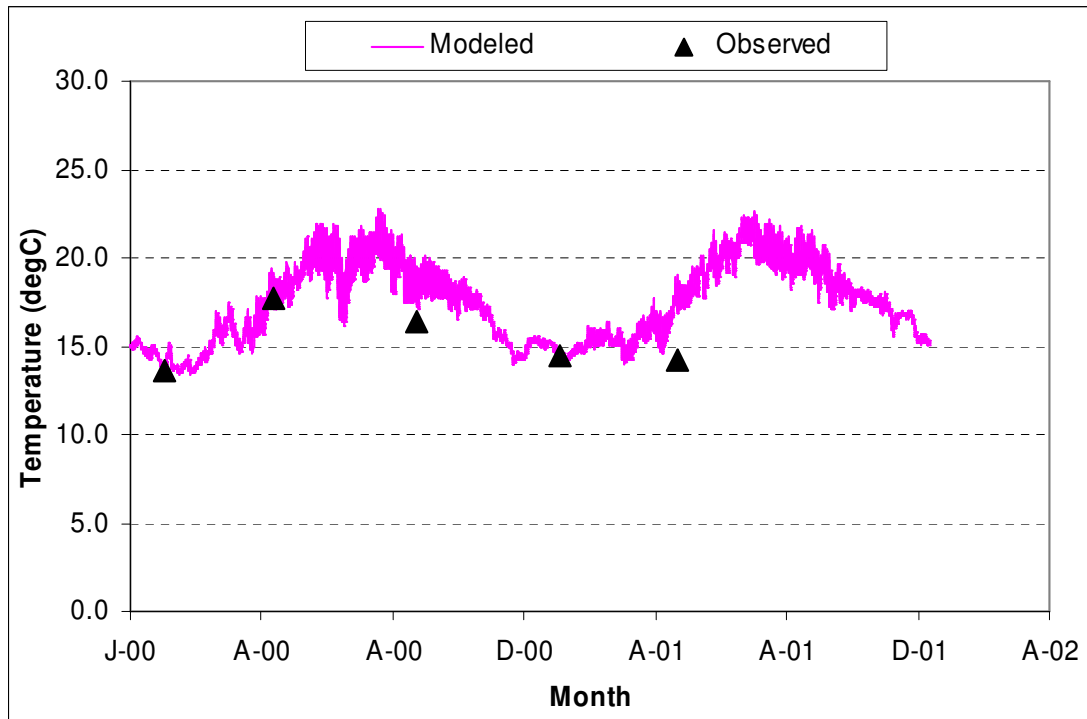

Figure I-6. Comparison of Model Predicted Temperature Results with Observed SPAWAR Results at Station #2

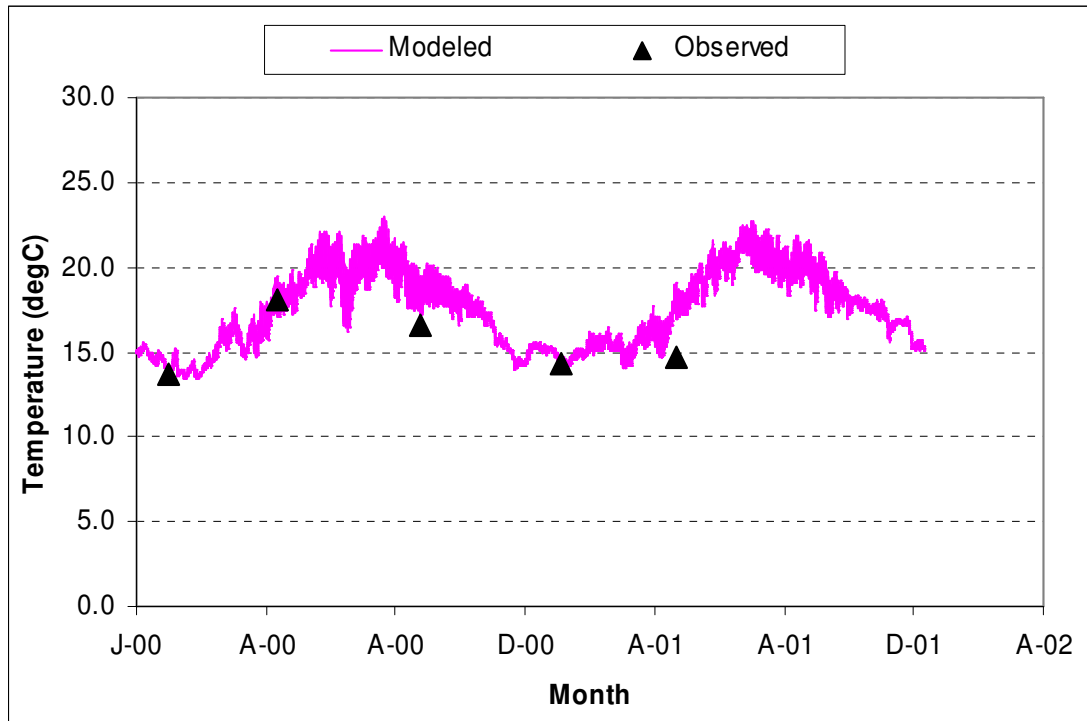

Figure I-7. Comparison of Model Predicted Temperature Results with Observed SPAWAR Results at Station #3

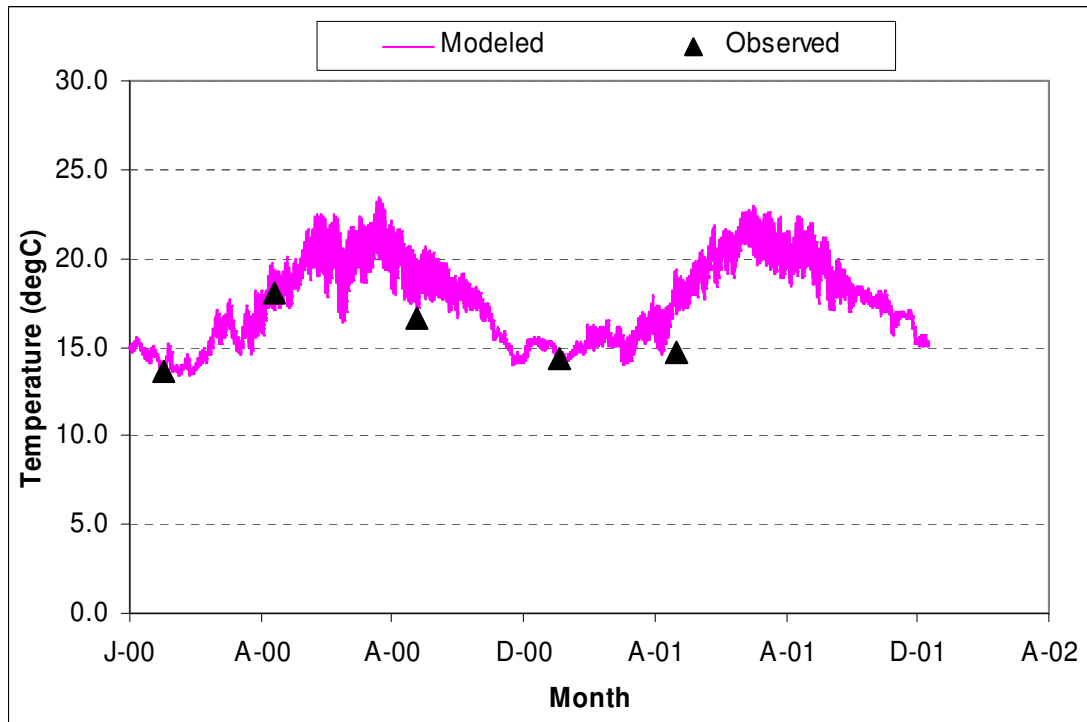

Figure I-8. Comparison of Model Predicted Temperature Results with Observed SPAWAR Results at Station #4

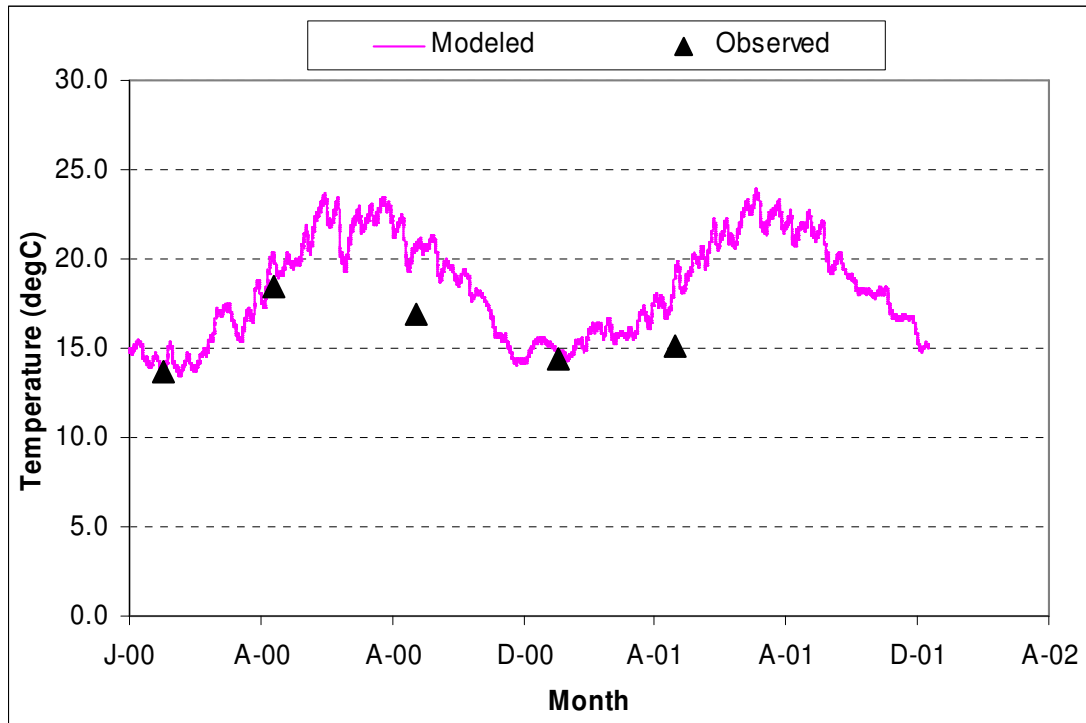

Figure I-9. Comparison of Model Predicted Temperature Results with Observed SPAWAR Results at Station #5

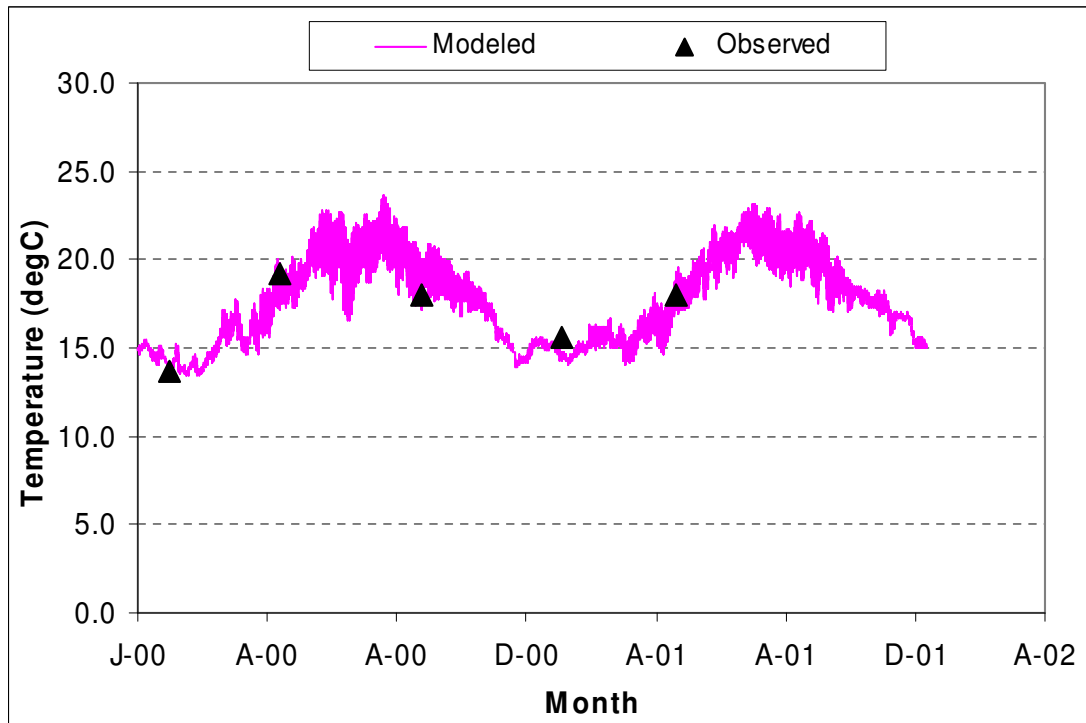

Figure I-10. Comparison of Model Predicted Temperature Results with Observed SPAWAR Results at Station #6

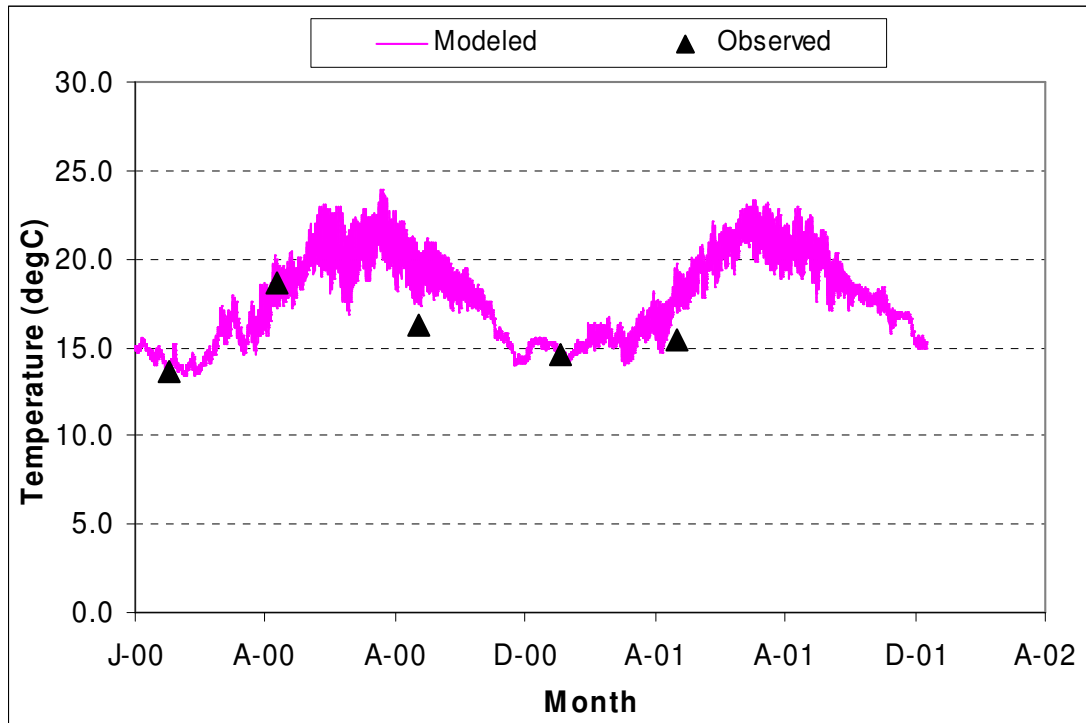

Figure I-11. Comparison of Model Predicted Temperature Results with Observed SPAWAR Results at Station #7

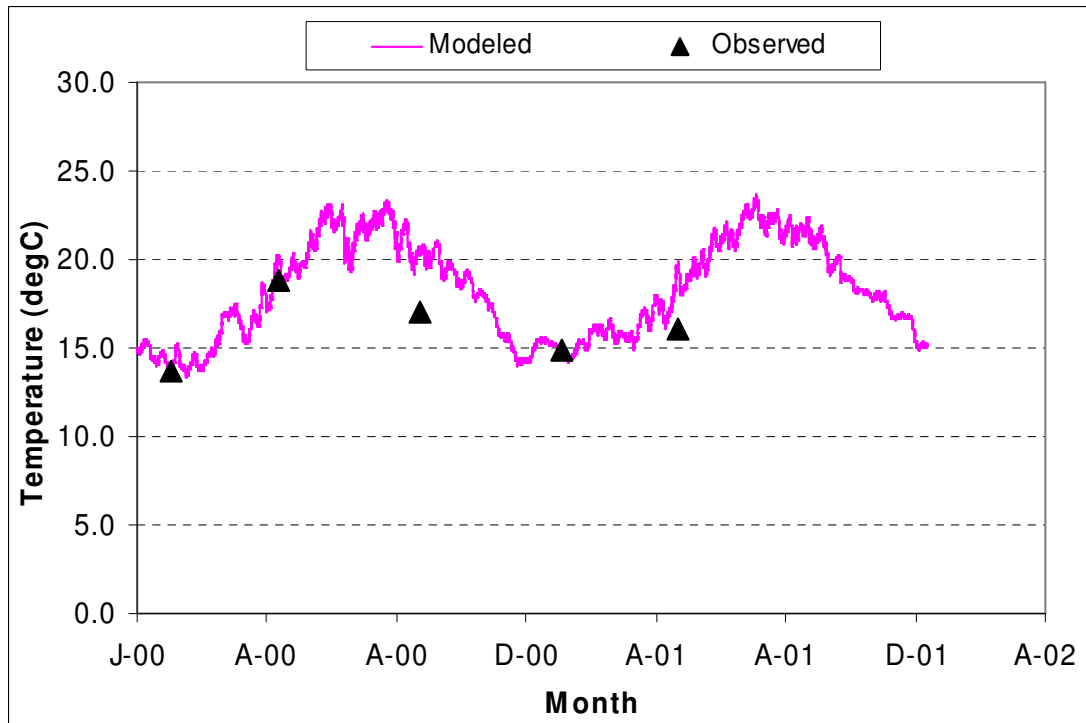

Figure I-12. Comparison of Model Predicted Temperature Results with Observed SPAWAR Results at Station #8

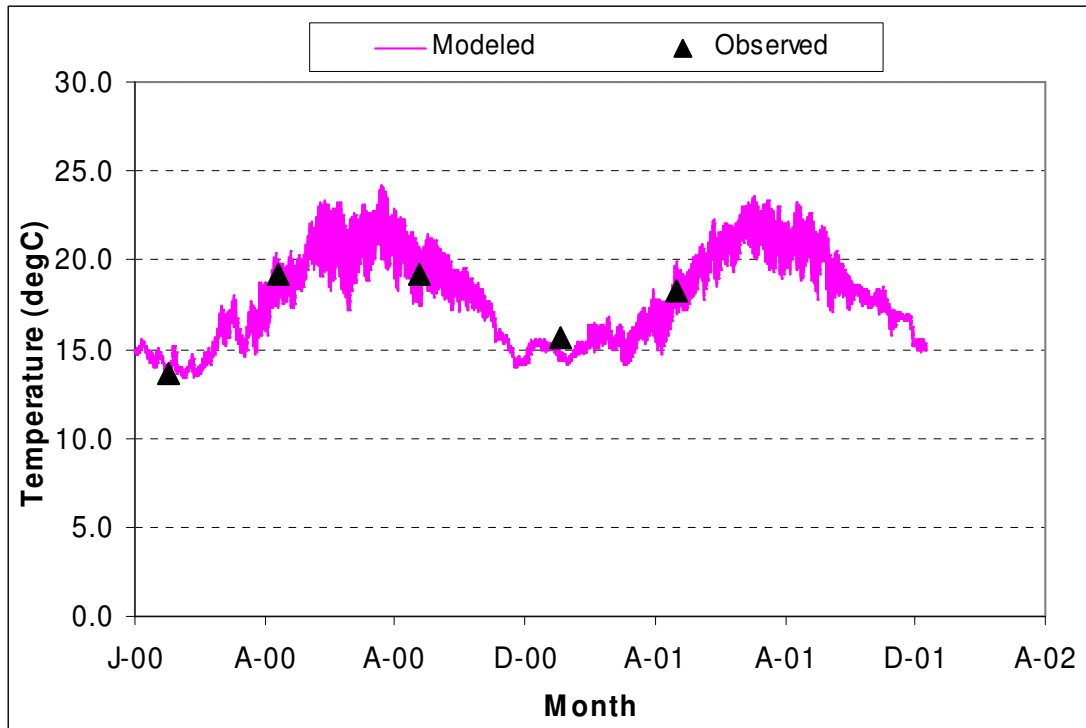

Figure I-13. Comparison of Model Predicted Temperature Results with Observed SPAWAR Results at Station #9

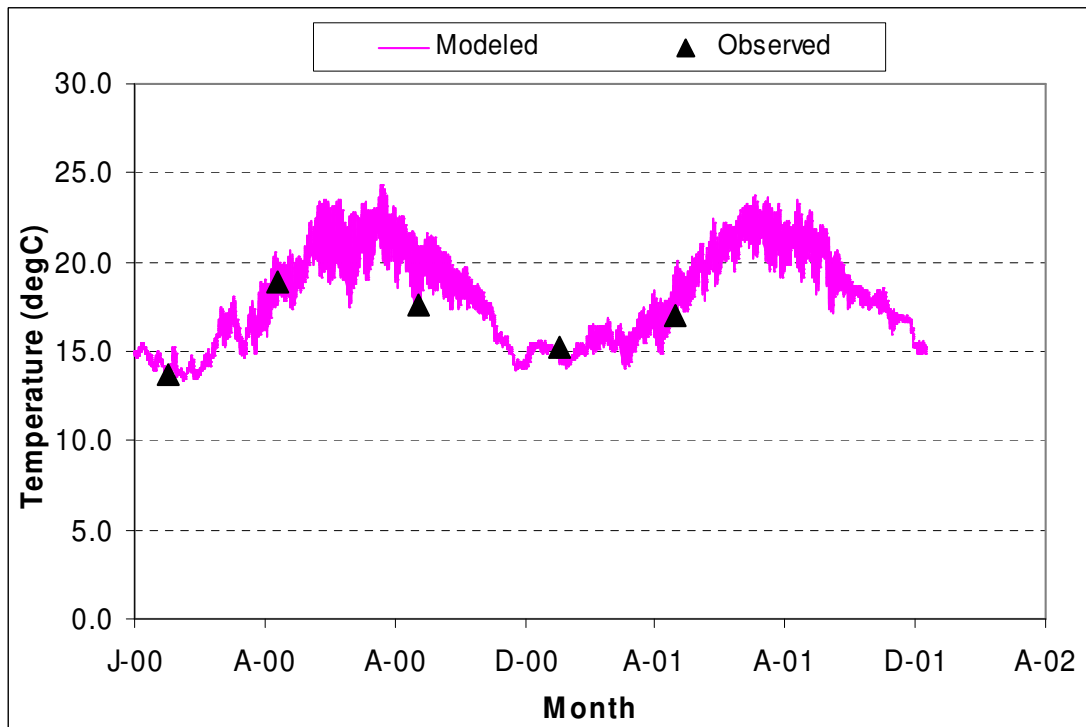

Figure I-14. Comparison of Model Predicted Temperature Results with Observed SPAWAR Results at Station #10

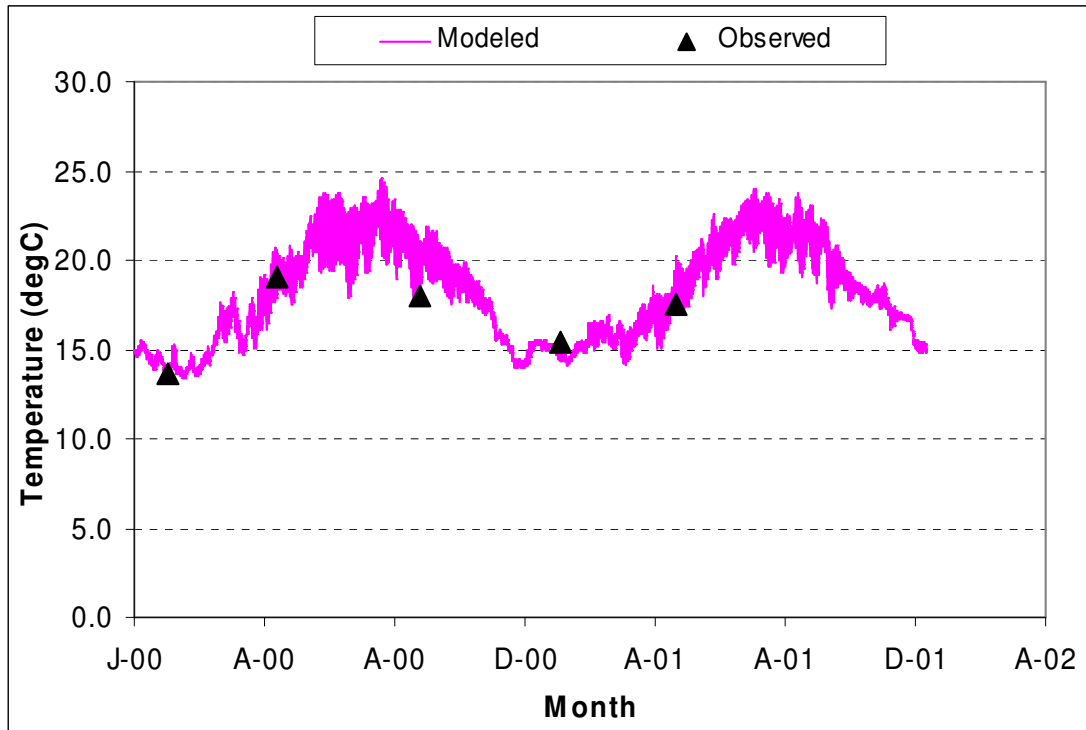

Figure I-15. Comparison of Model Predicted Temperature Results with Observed SPAWAR Results at Station #11

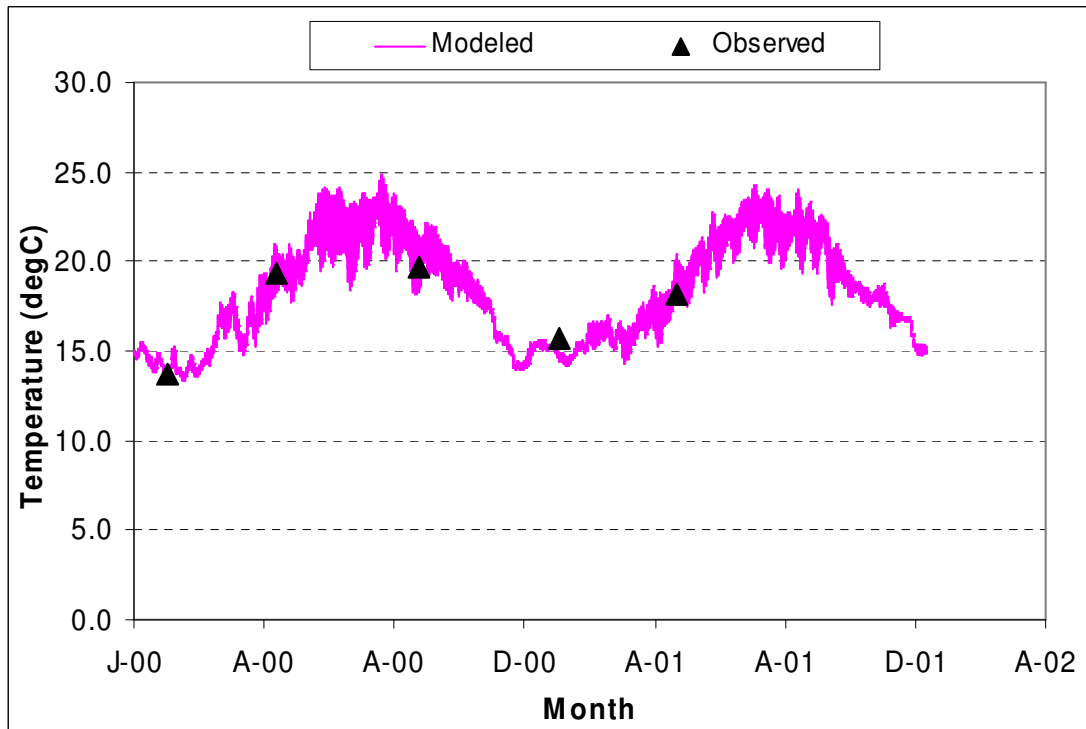

Figure I-16. Comparison of Model Predicted Temperature Results with Observed SPAWAR Results at Station #12

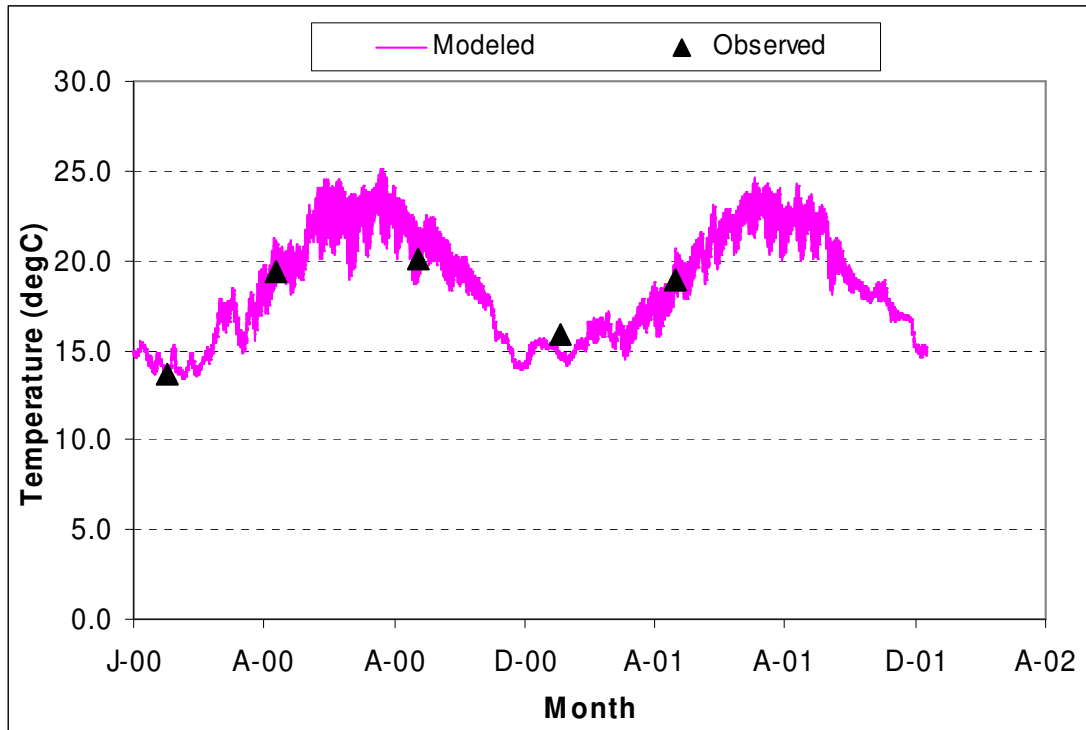

Figure I-17. Comparison of Model Predicted Temperature Results with Observed SPAWAR Results at Station #13

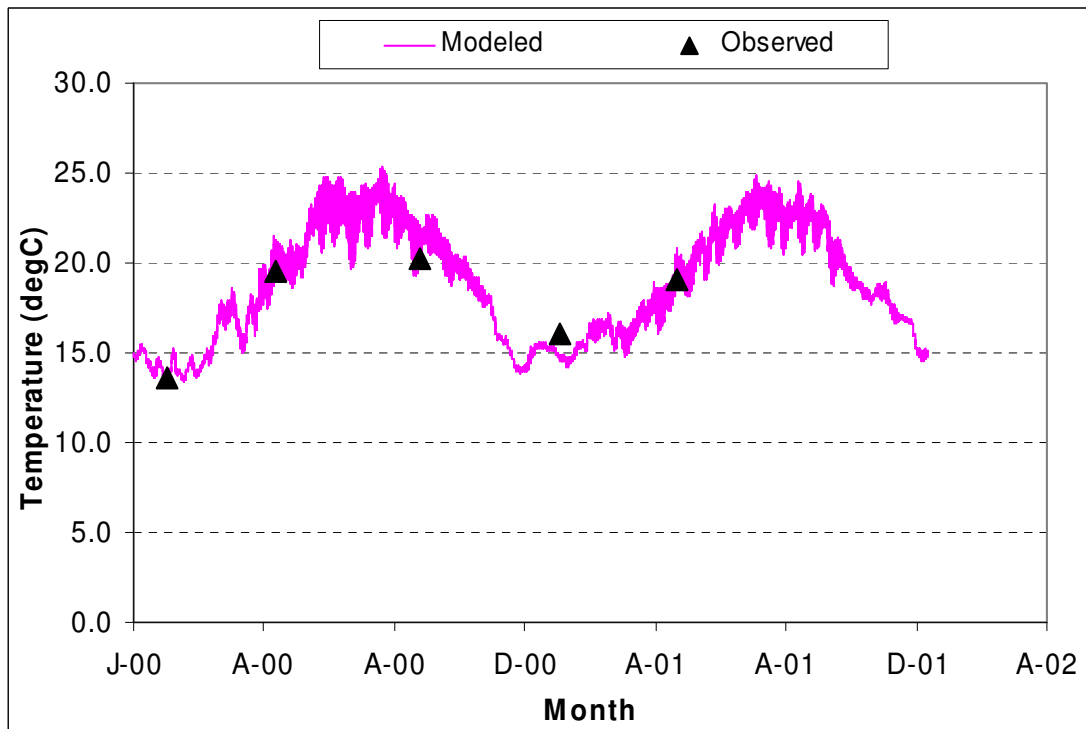

Figure I-18. Comparison of Model Predicted Temperature Results with Observed SPAWAR Results at Station #14

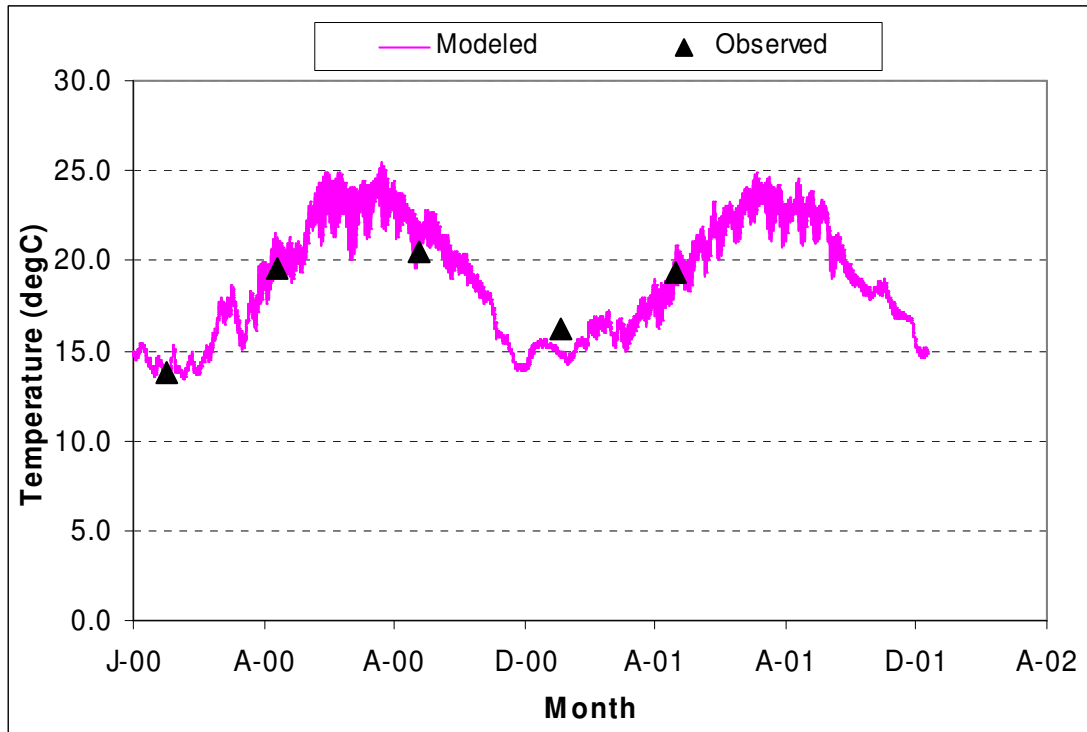

Figure I-19. Comparison of Model Predicted Temperature Results with Observed SPAWAR Results at Station #15

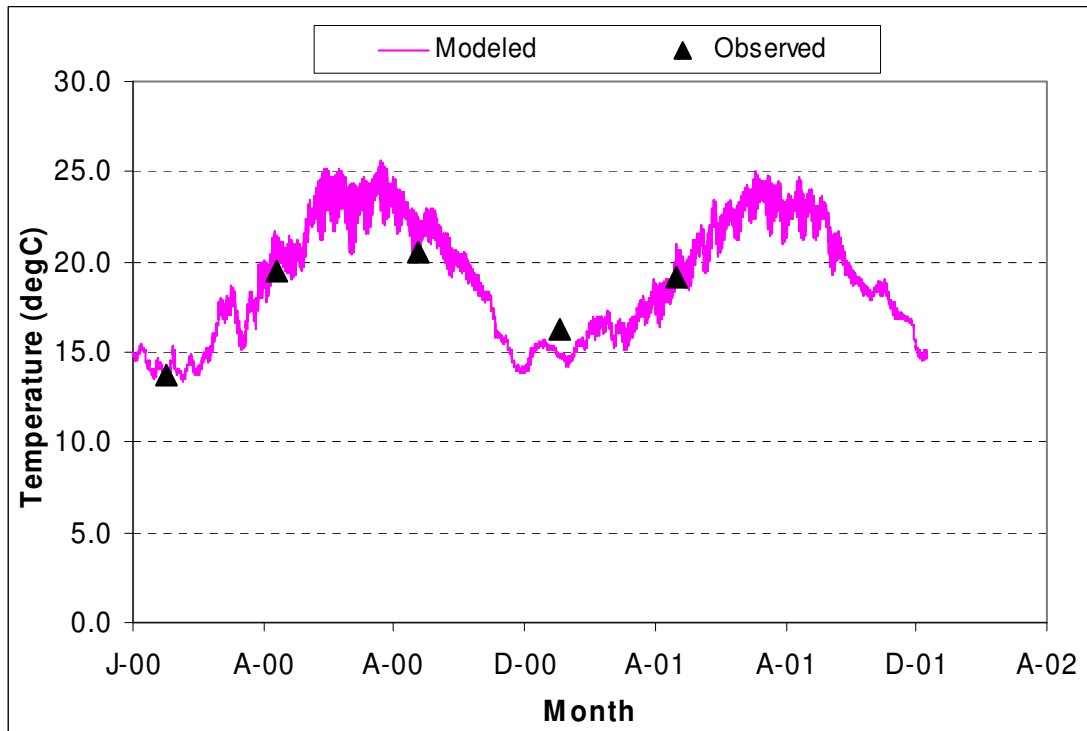

Figure I-20. Comparison of Model Predicted Temperature Results with Observed SPAWAR Results at Station #16

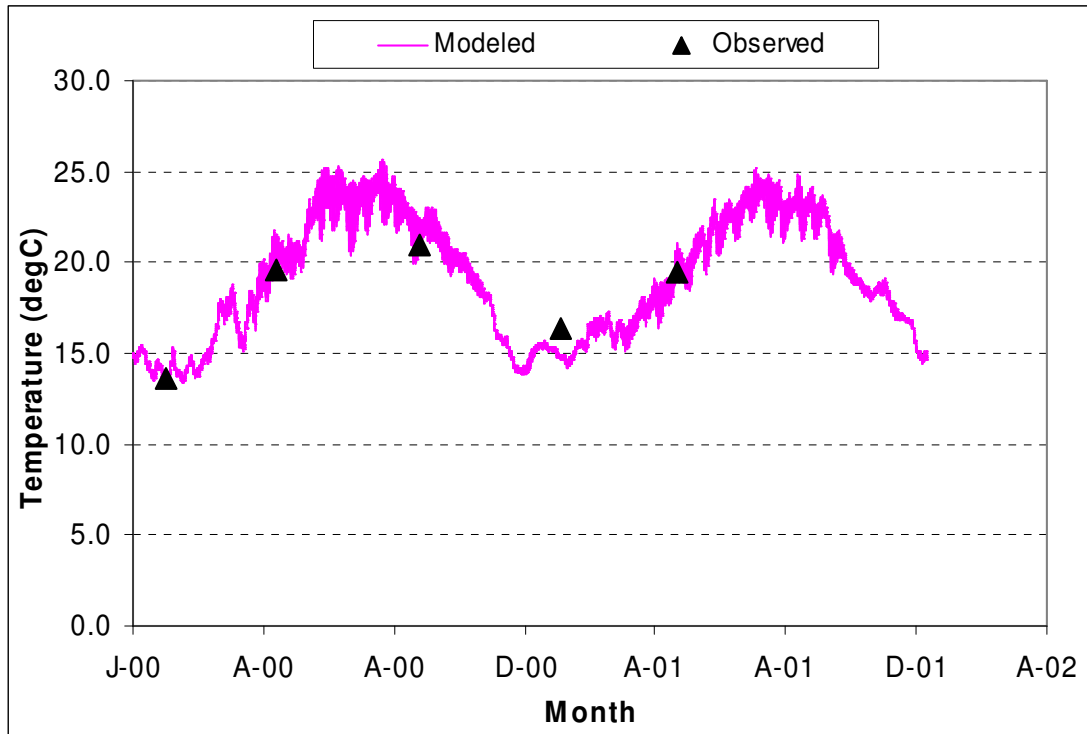

Figure I-21. Comparison of Model Predicted Temperature Results with Observed SPAWAR Results at Station #17

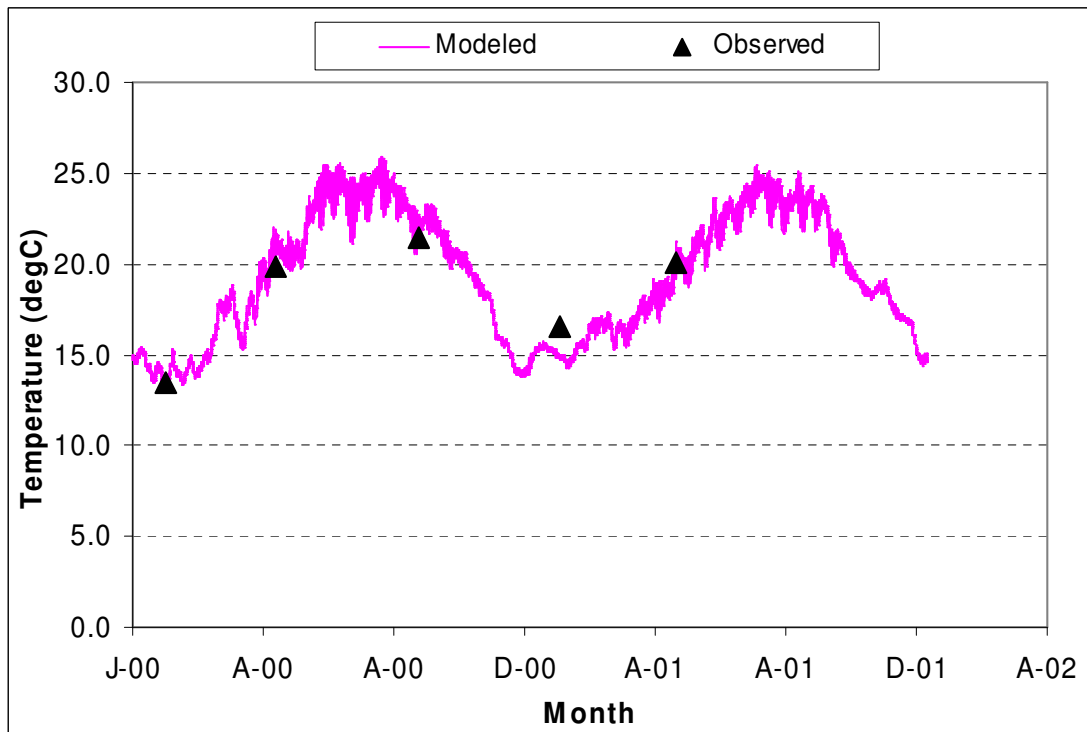

Figure I-22. Comparison of Model Predicted Temperature Results with Observed SPAWAR Results at Station #18

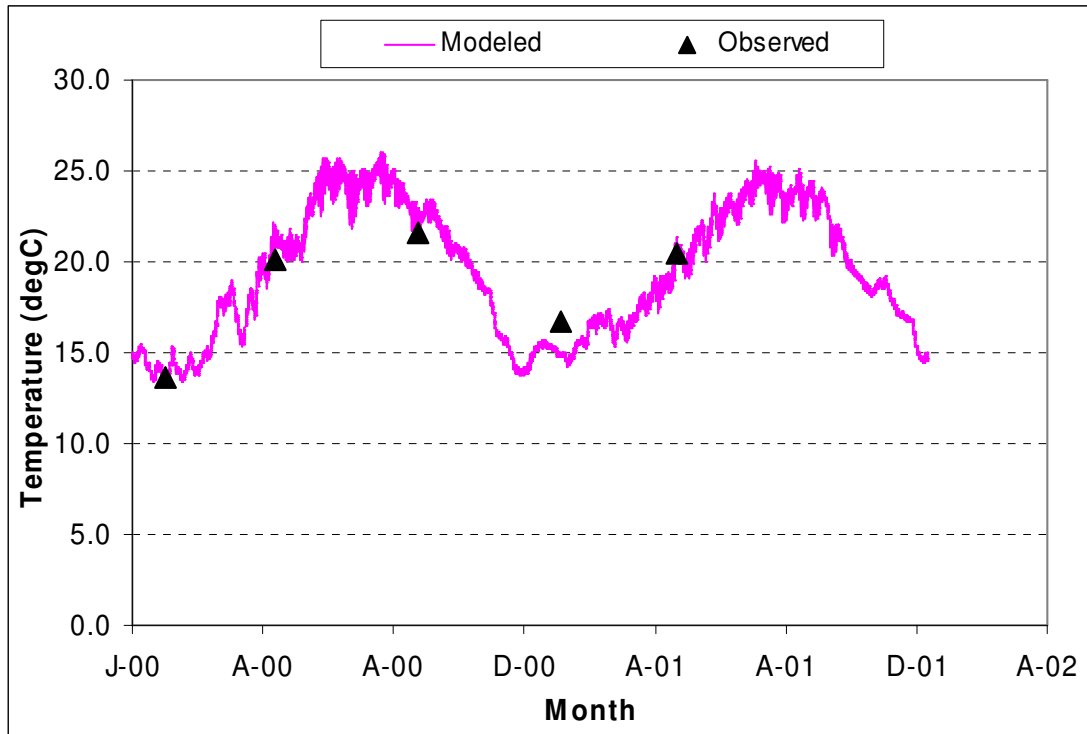

Figure I-23. Comparison of Model Predicted Temperature Results with Observed SPAWAR Results at Station #19

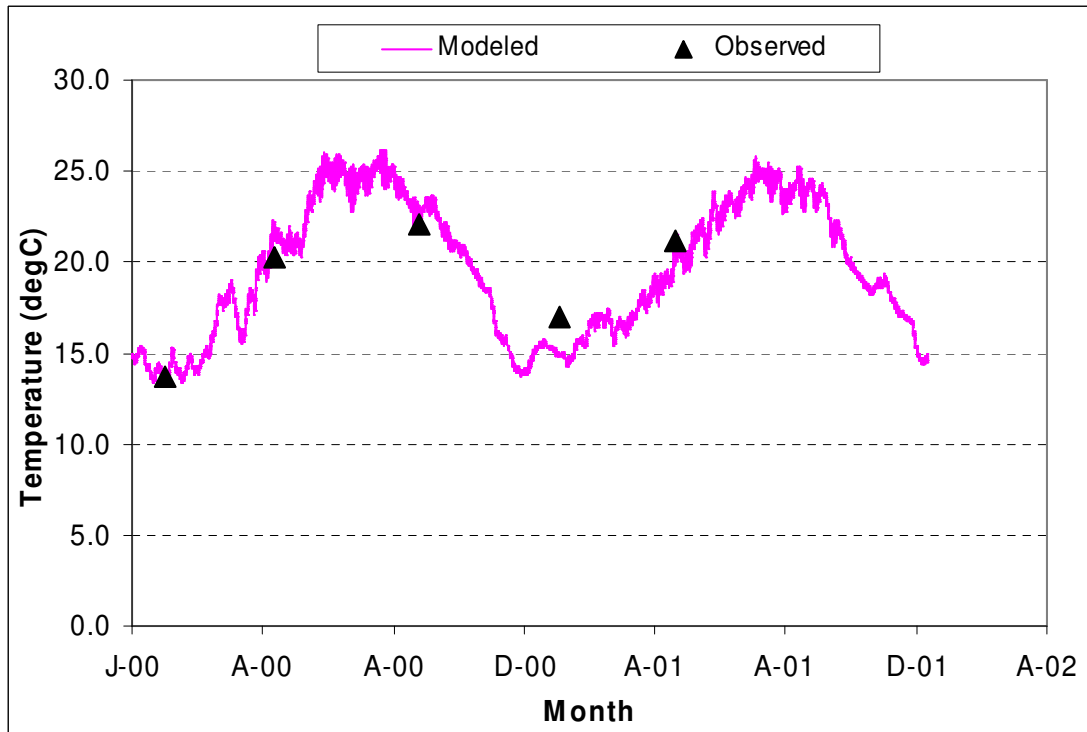

Figure I-24. Comparison of Model Predicted Temperature Results with Observed SPAWAR Results at Station #20

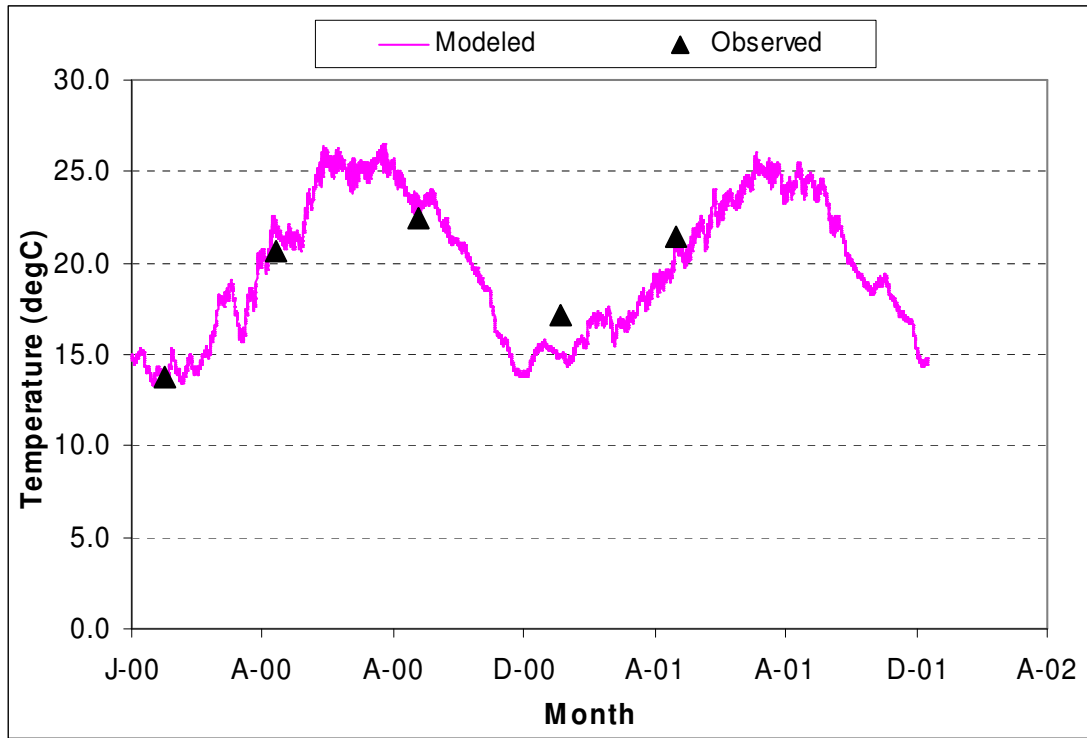

Figure I-25. Comparison of Model Predicted Temperature Results with Observed SPAWAR Results at Station #21

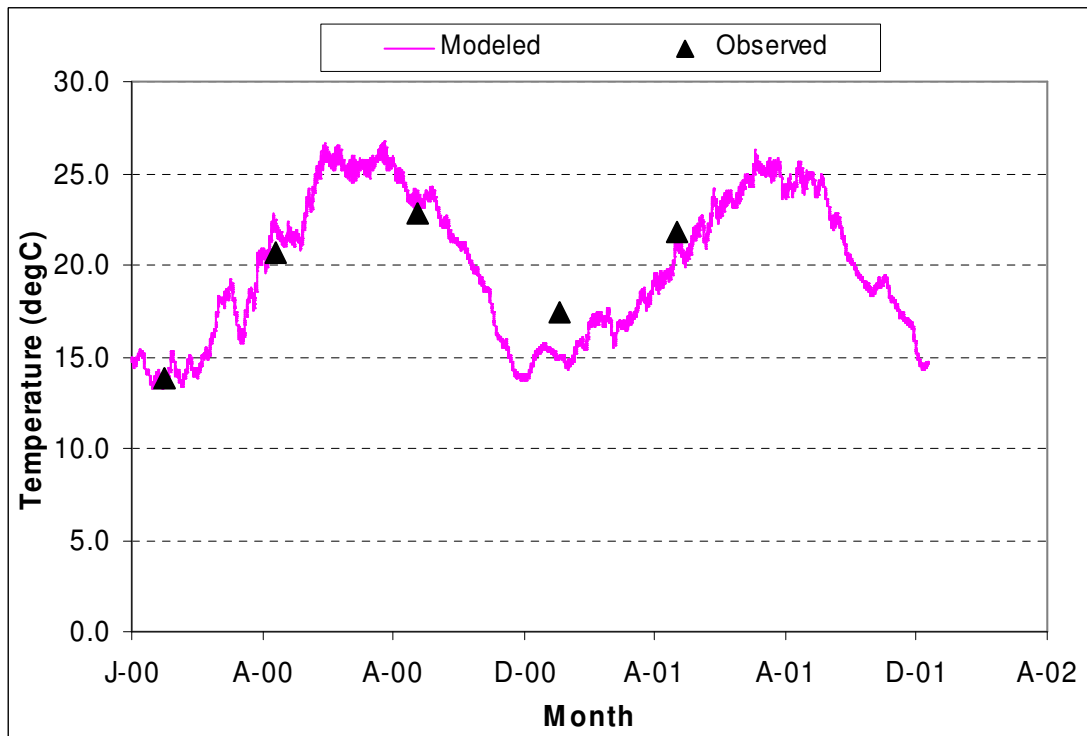

Figure I-26. Comparison of Model Predicted Temperature Results with Observed SPAWAR Results at Station #22

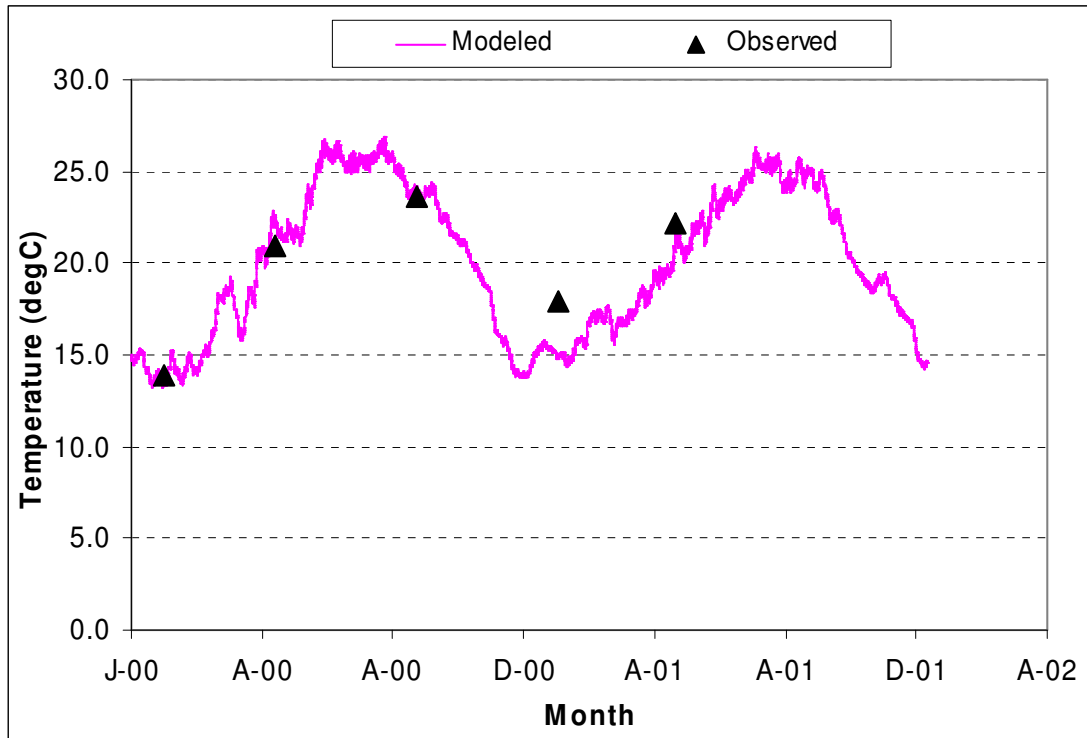

Figure I-27. Comparison of Model Predicted Temperature Results with Observed SPAWAR Results at Station #23

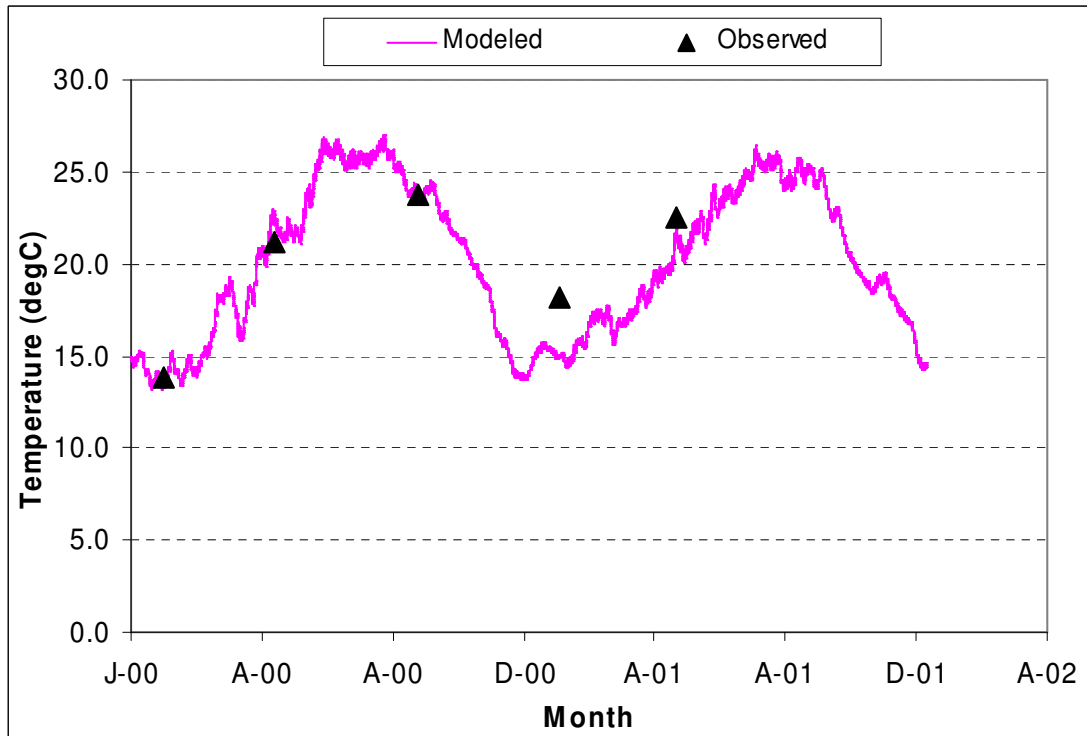

Figure I-28. Comparison of Model Predicted Temperature Results with Observed SPAWAR Results at Station #24

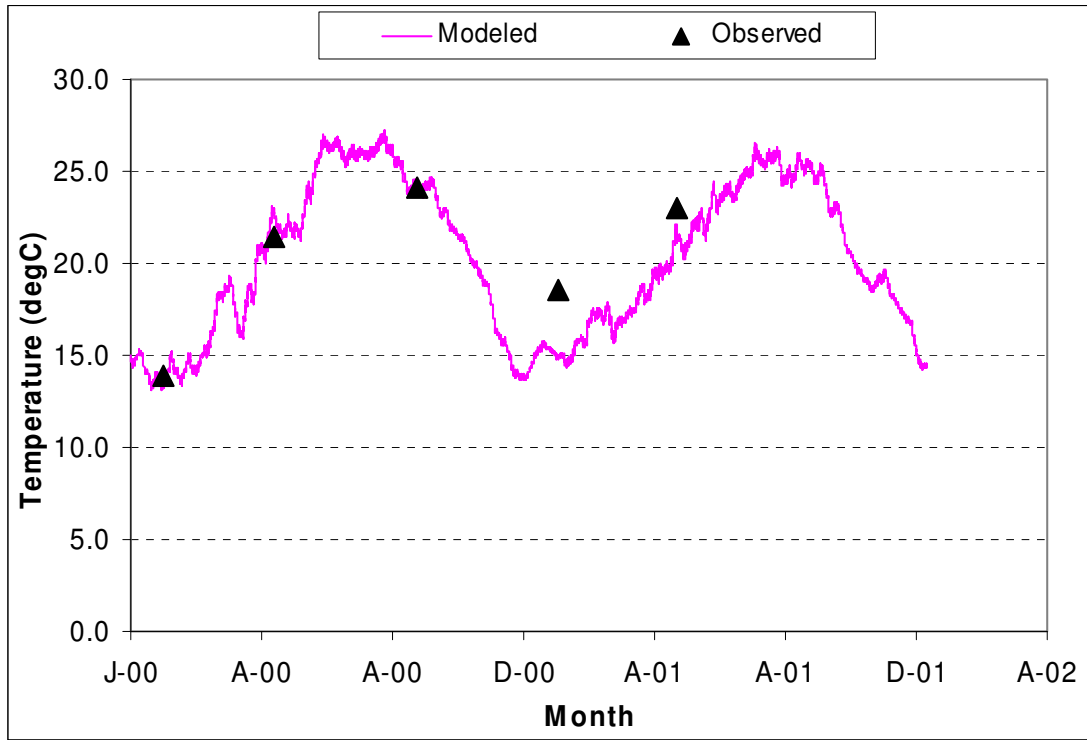

Figure I-29. Comparison of Model Predicted Temperature Results with Observed SPAWAR Results at Station #25

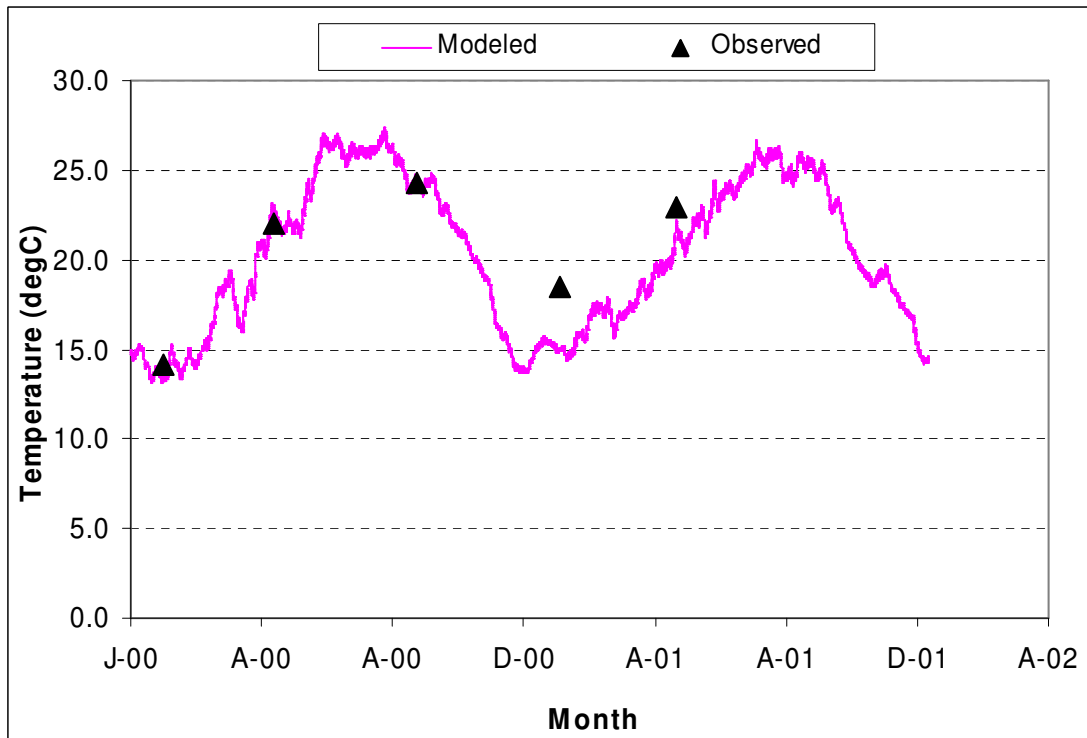

Figure I-30. Comparison of Model Predicted Temperature Results with Observed SPAWAR Results at Station #26

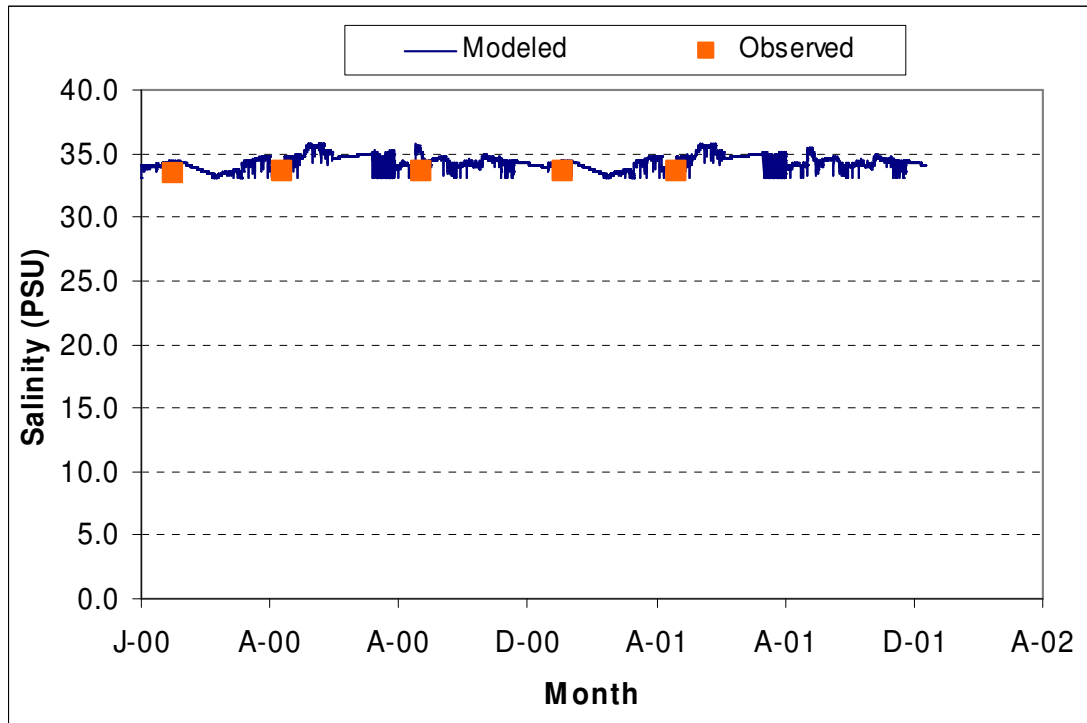

Figure I-31. Comparison of Model Predicted Salinity Results with Observed SPAWAR Results at Station #1

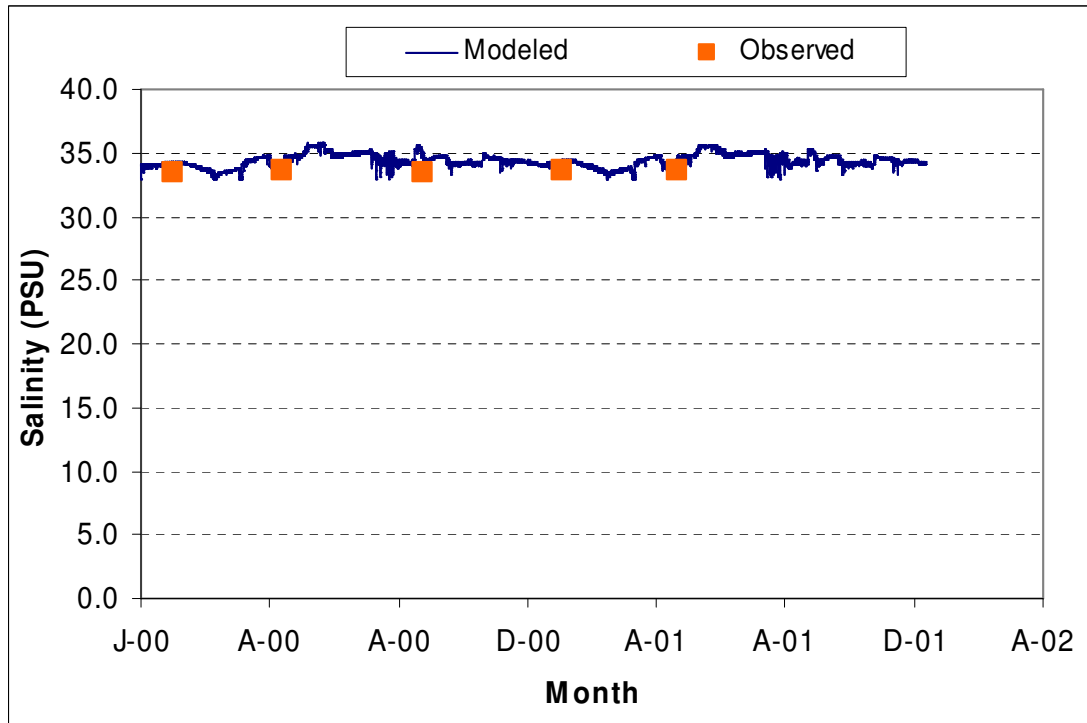

Figure I-32. Comparison of Model Predicted Salinity Results with Observed SPAWAR Results at Station #2

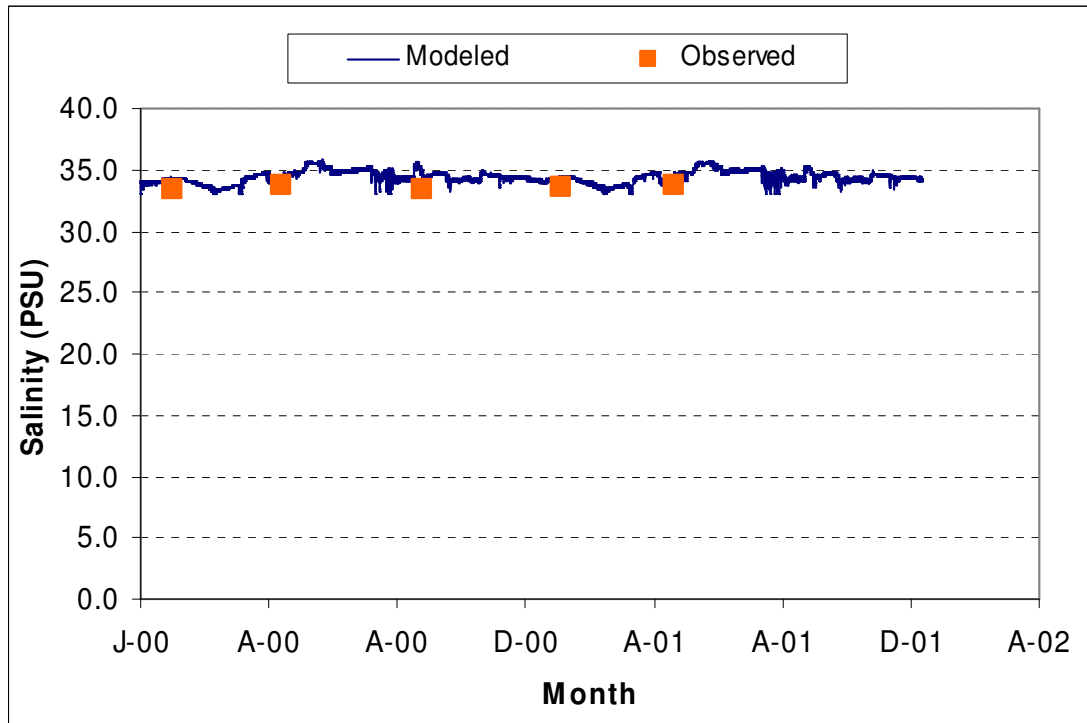

Figure I-33. Comparison of Model Predicted Salinity Results with Observed SPAWAR Results at Station #3

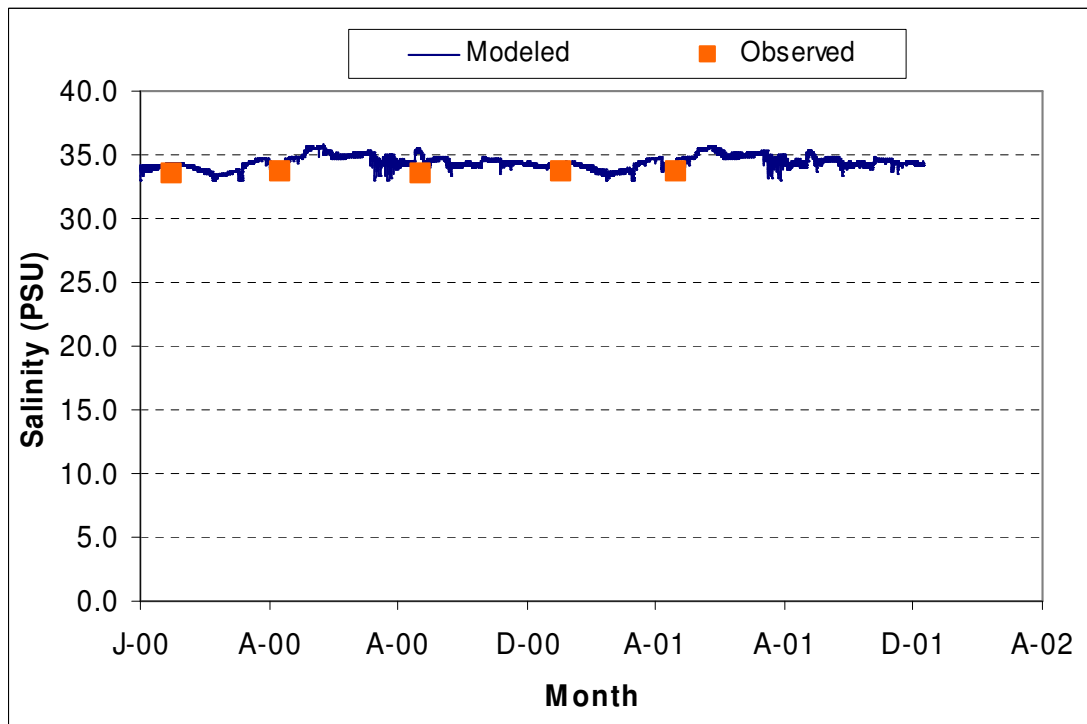

Figure I-34. Comparison of Model Predicted Salinity Results with Observed SPAWAR Results at Station #4

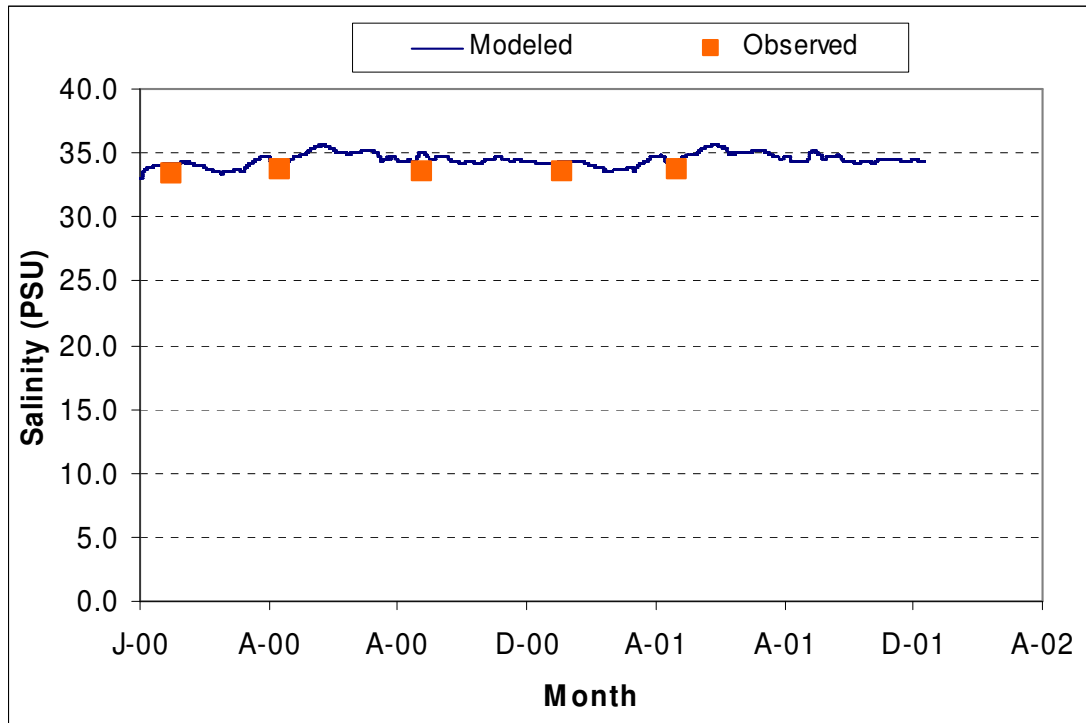

Figure I-35. Comparison of Model Predicted Salinity Results with Observed SPAWAR Results at Station #5

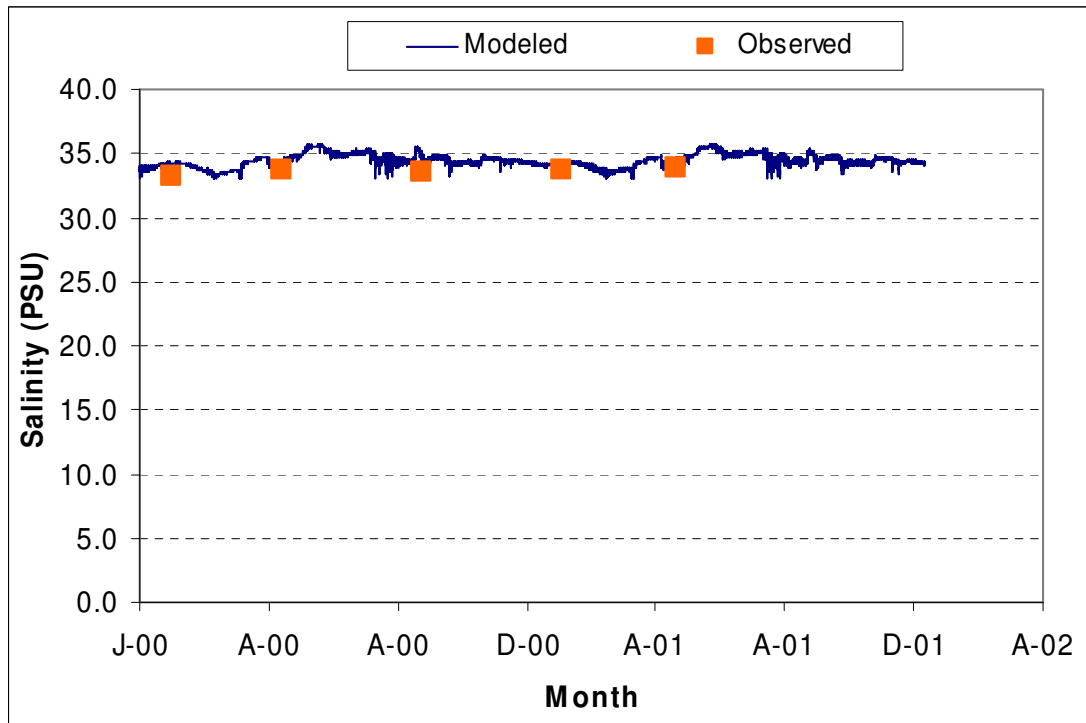

Figure I-36. Comparison of Model Predicted Salinity Results with Observed SPAWAR Results at Station #6

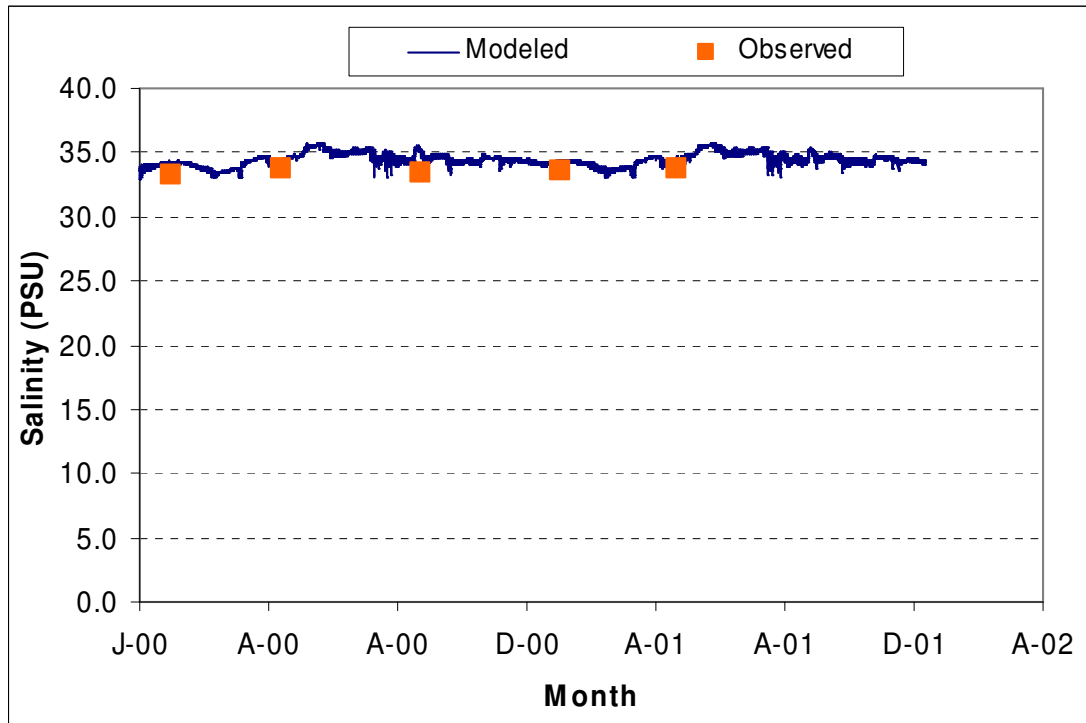

Figure I-37. Comparison of Model Predicted Salinity Results with Observed SPAWAR Results at Station #7

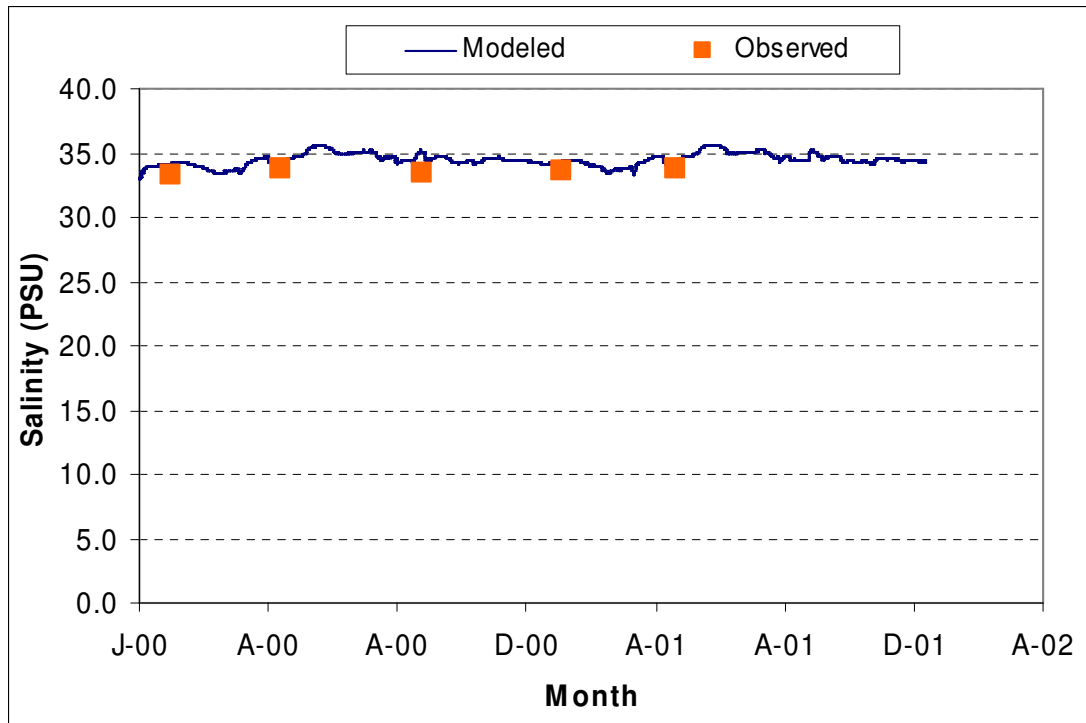

Figure I-38. Comparison of Model Predicted Salinity Results with Observed SPAWAR Results at Station #8

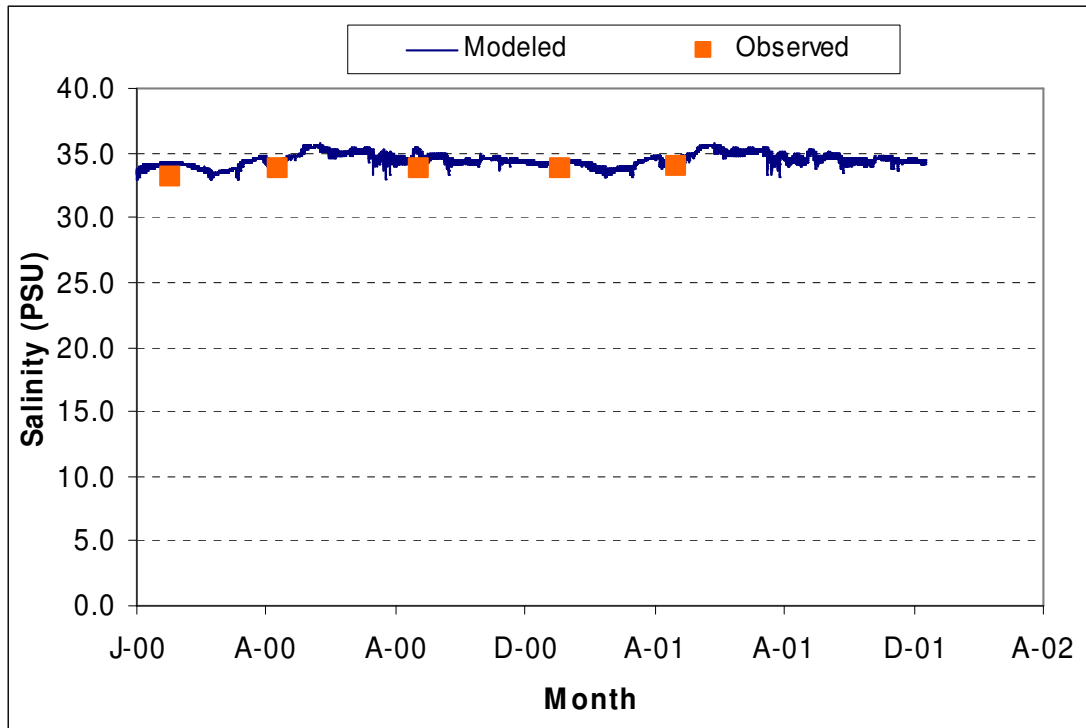

Figure I-39. Comparison of Model Predicted Salinity Results with Observed SPAWAR Results at Station #9

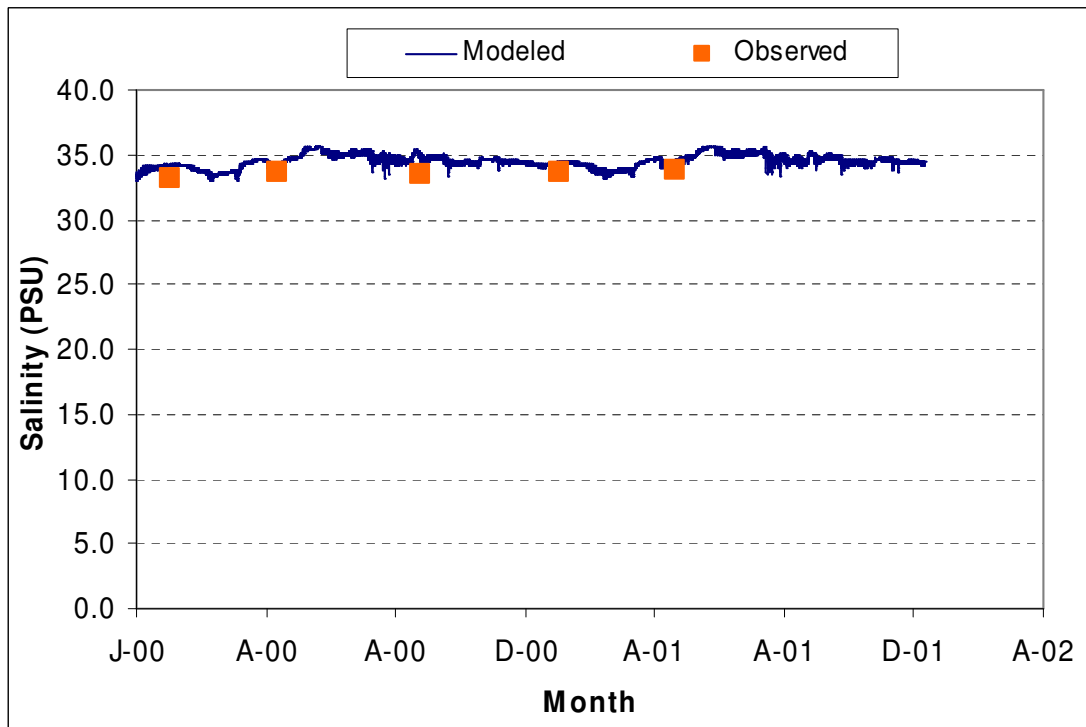

Figure I-40. Comparison of Model Predicted Salinity Results with Observed SPAWAR Results at Station #10

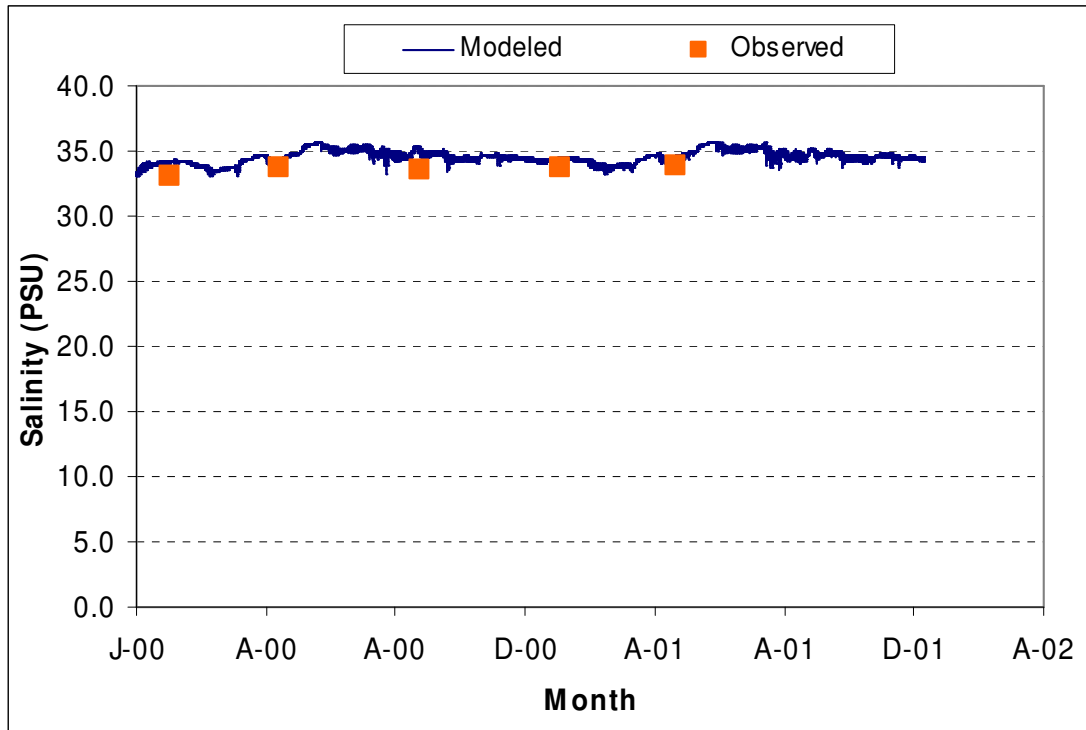

Figure I-41. Comparison of Model Predicted Salinity Results with Observed SPAWAR Results at Station #11

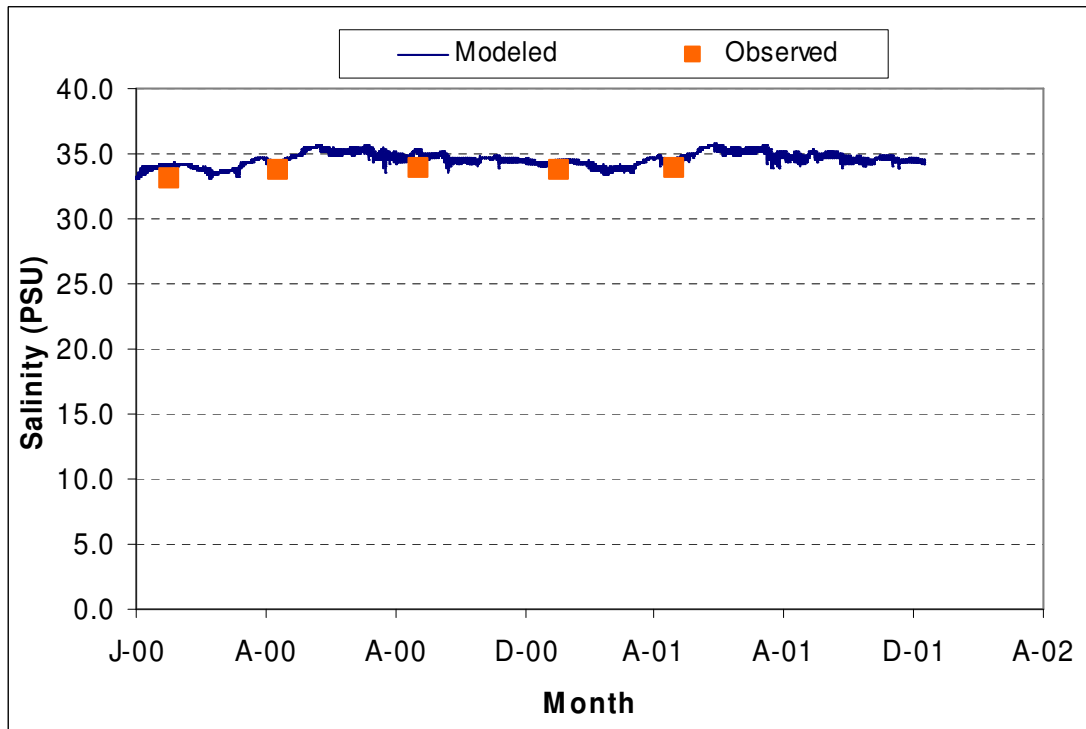

Figure I-42. Comparison of Model Predicted Salinity Results with Observed SPAWAR Results at Station #12

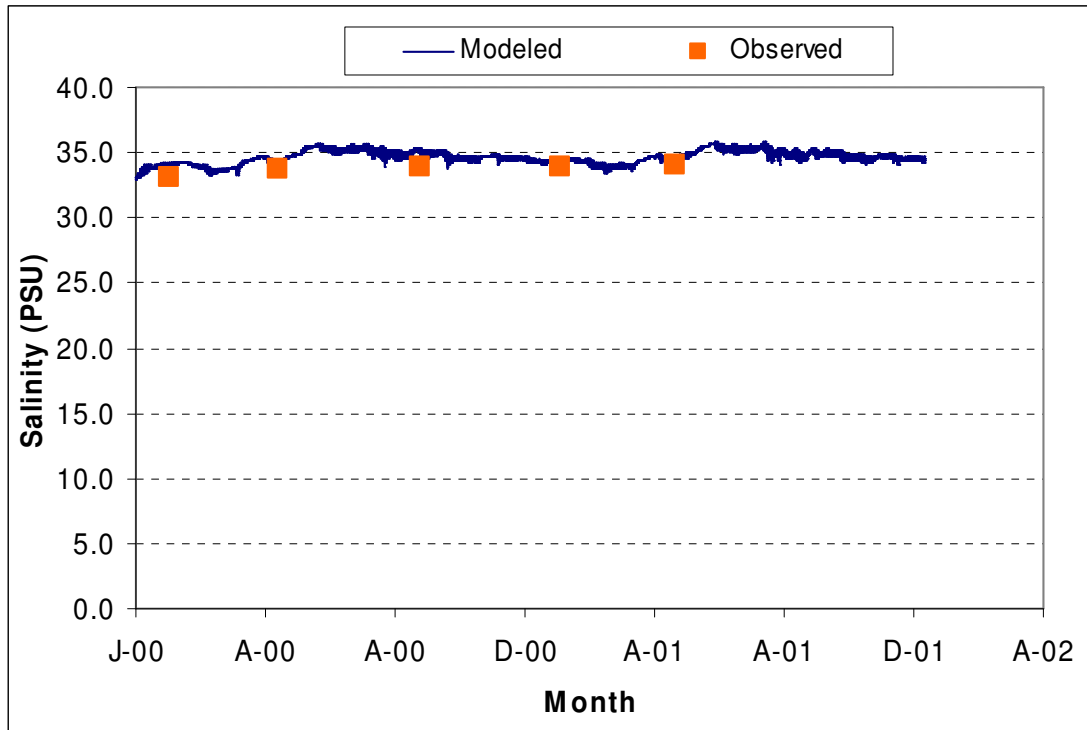

Figure I-43. Comparison of Model Predicted Salinity Results with Observed SPAWAR Results at Station #13

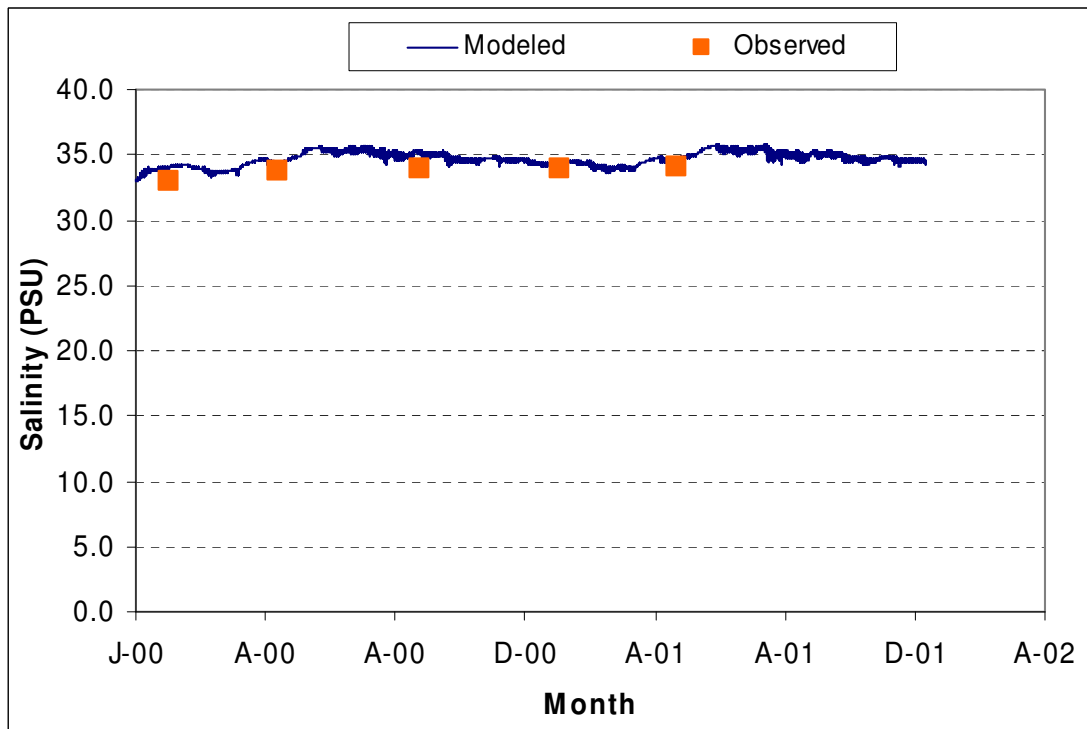

Figure I-44. Comparison of Model Predicted Salinity Results with Observed SPAWAR Results at Station #14

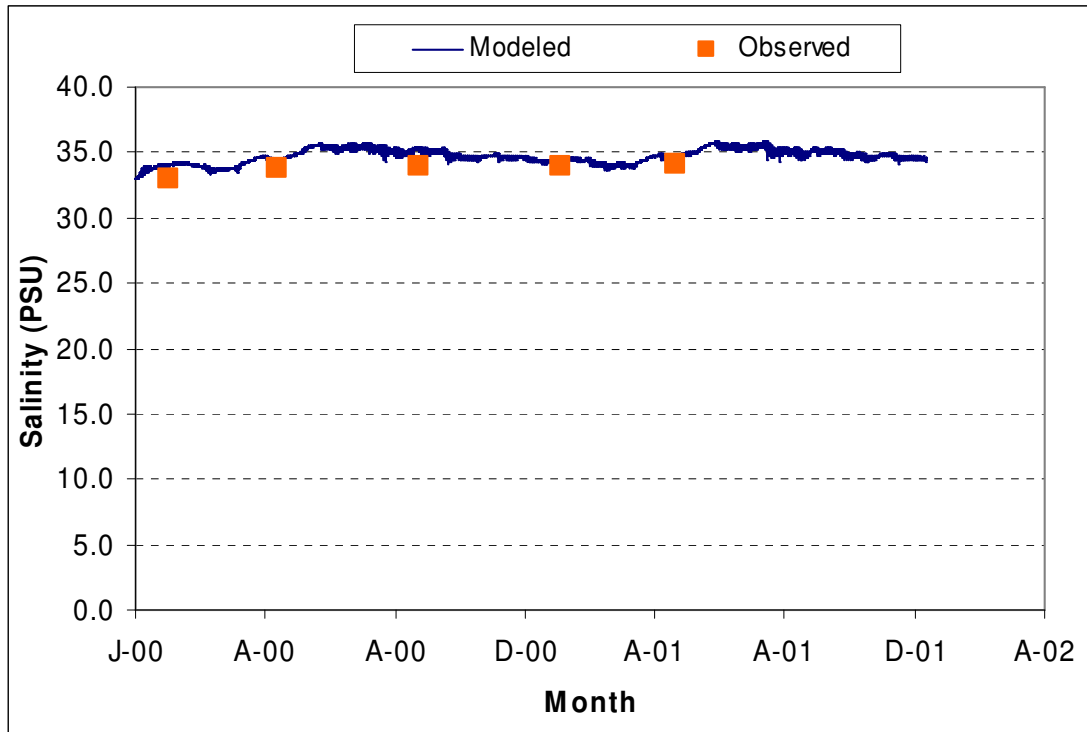

Figure I-45. Comparison of Model Predicted Salinity Results with Observed SPAWAR Results at Station #15

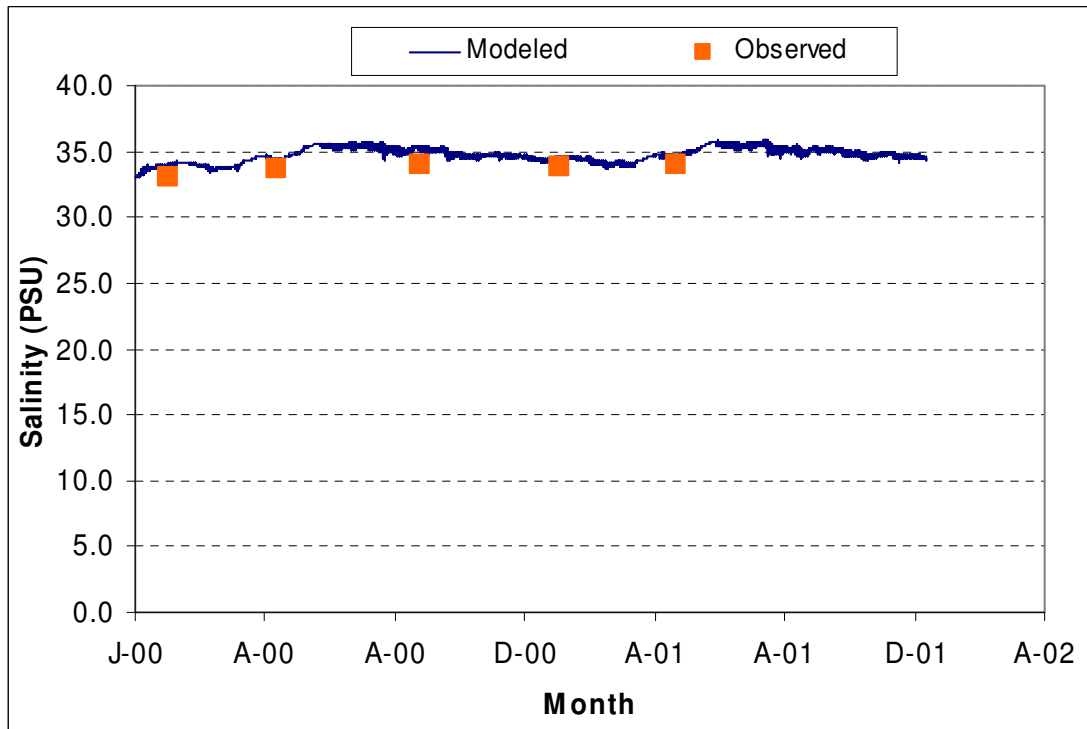

Figure I-46. Comparison of Model Predicted Salinity Results with Observed SPAWAR Results at Station #16

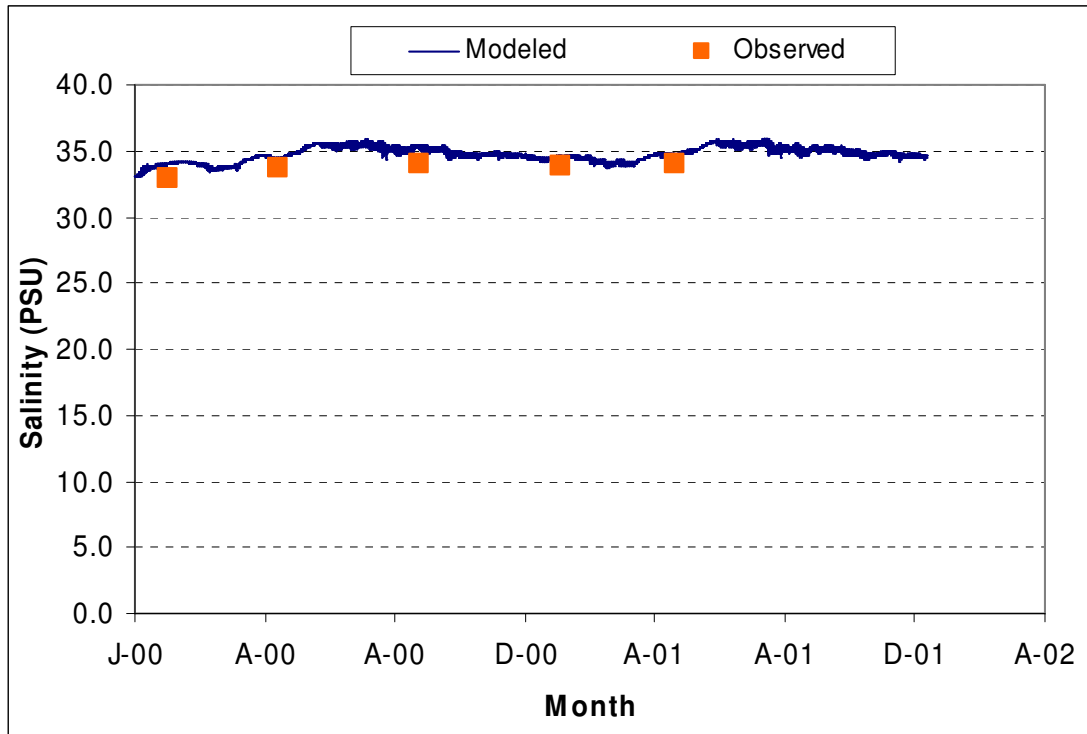

Figure I-47. Comparison of Model Predicted Salinity Results with Observed SPAWAR Results at Station #17

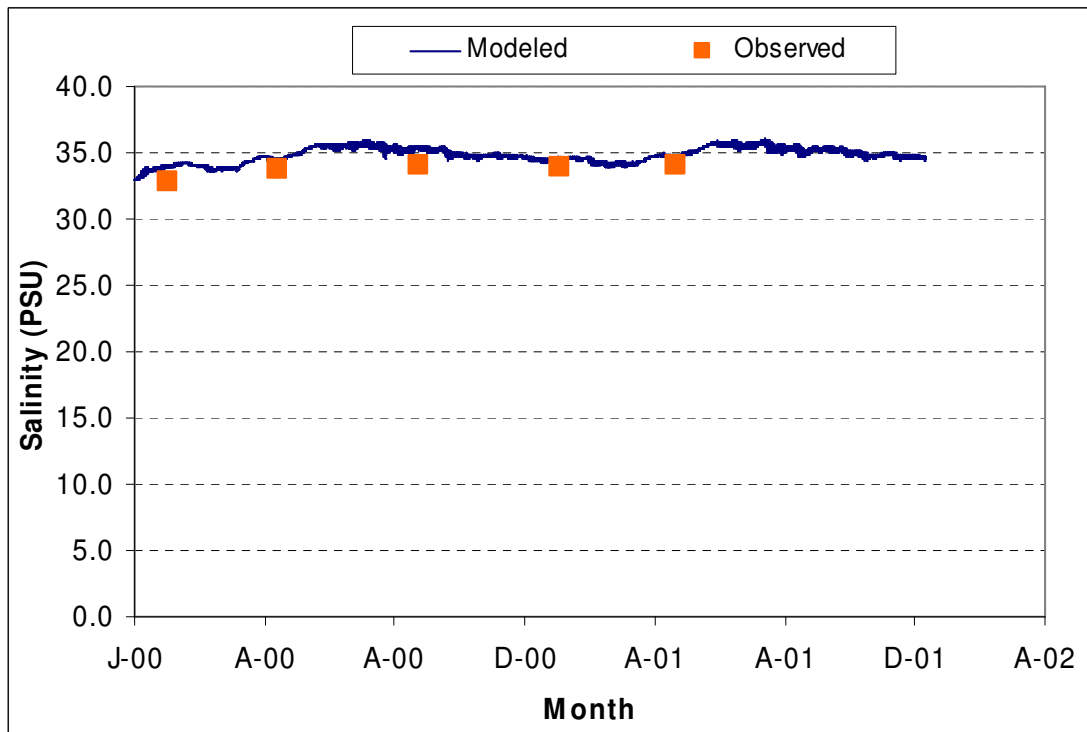

Figure I-48. Comparison of Model Predicted Salinity Results with Observed SPAWAR Results at Station #18

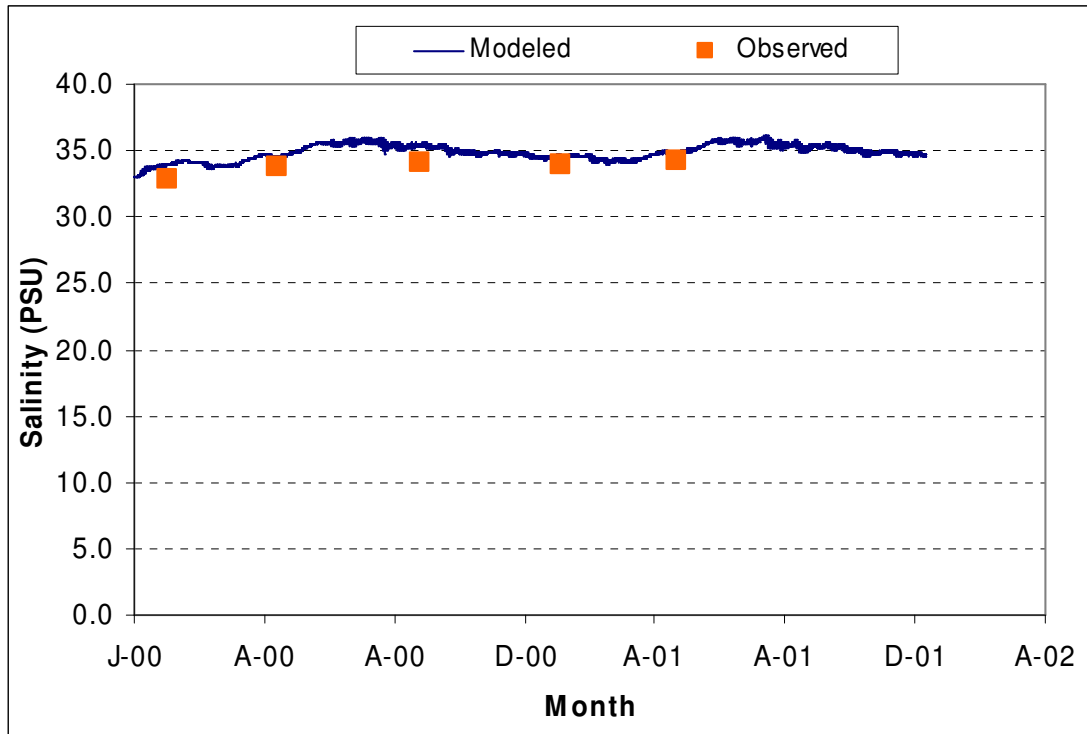

Figure I-49. Comparison of Model Predicted Salinity Results with Observed SPAWAR Results at Station #19

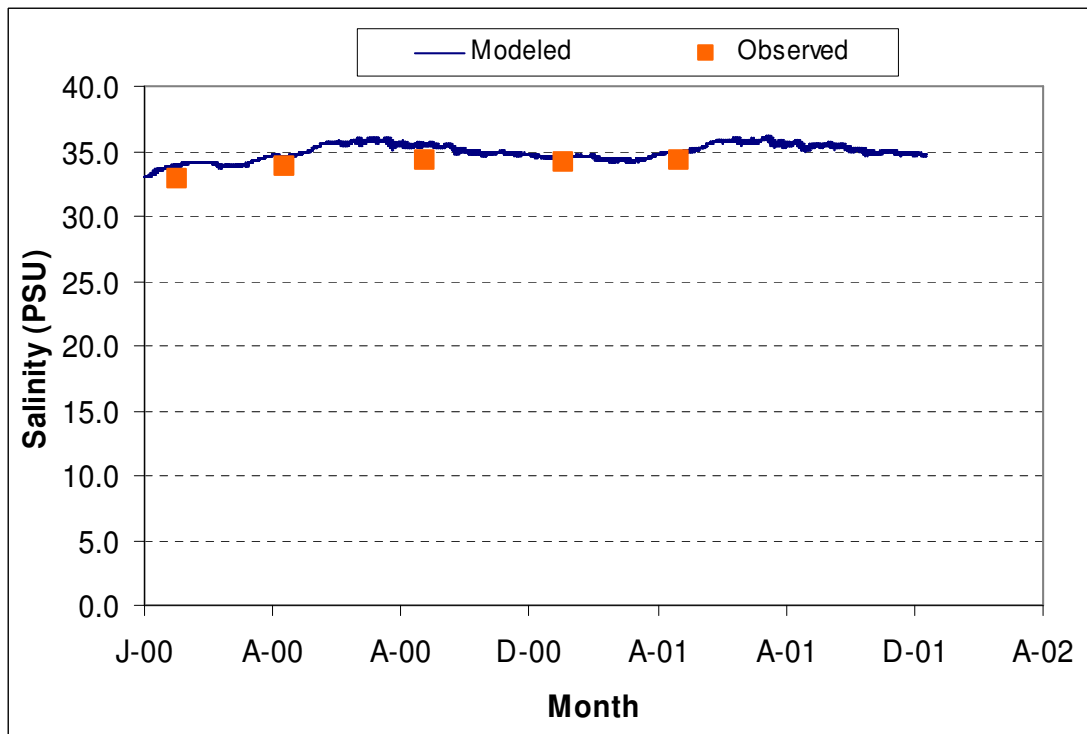

Figure I-50. Comparison of Model Predicted Salinity Results with Observed SPAWAR Results at Station #20

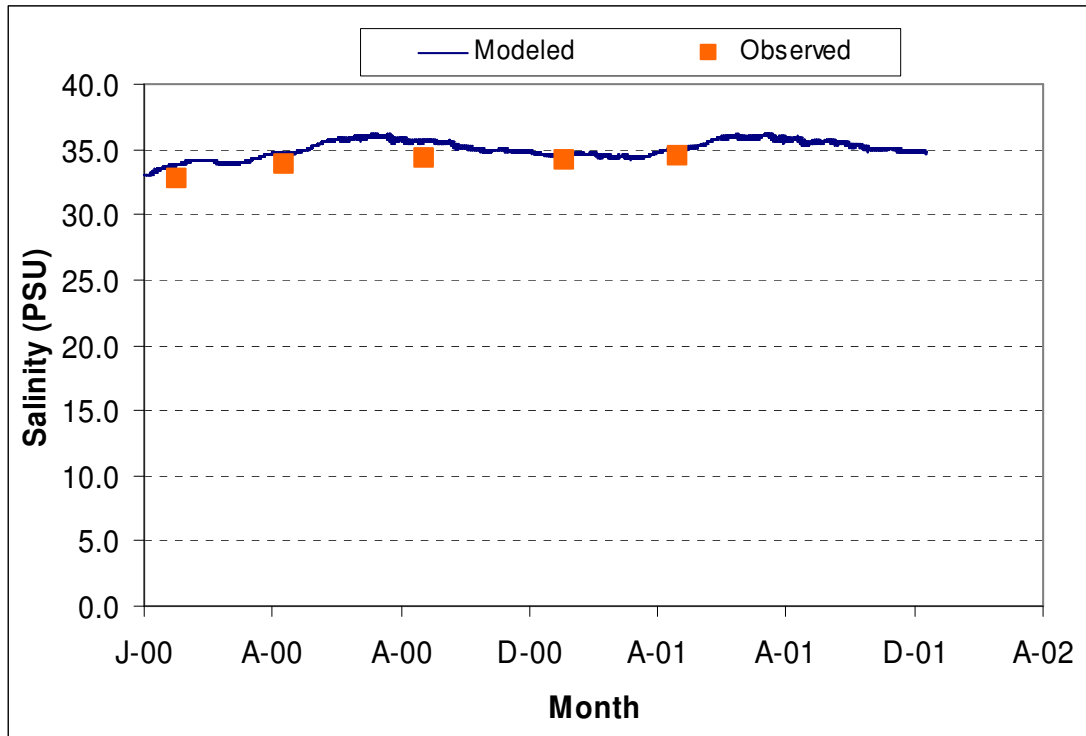

Figure I-51. Comparison of Model Predicted Salinity Results with Observed SPAWAR Results at Station #21

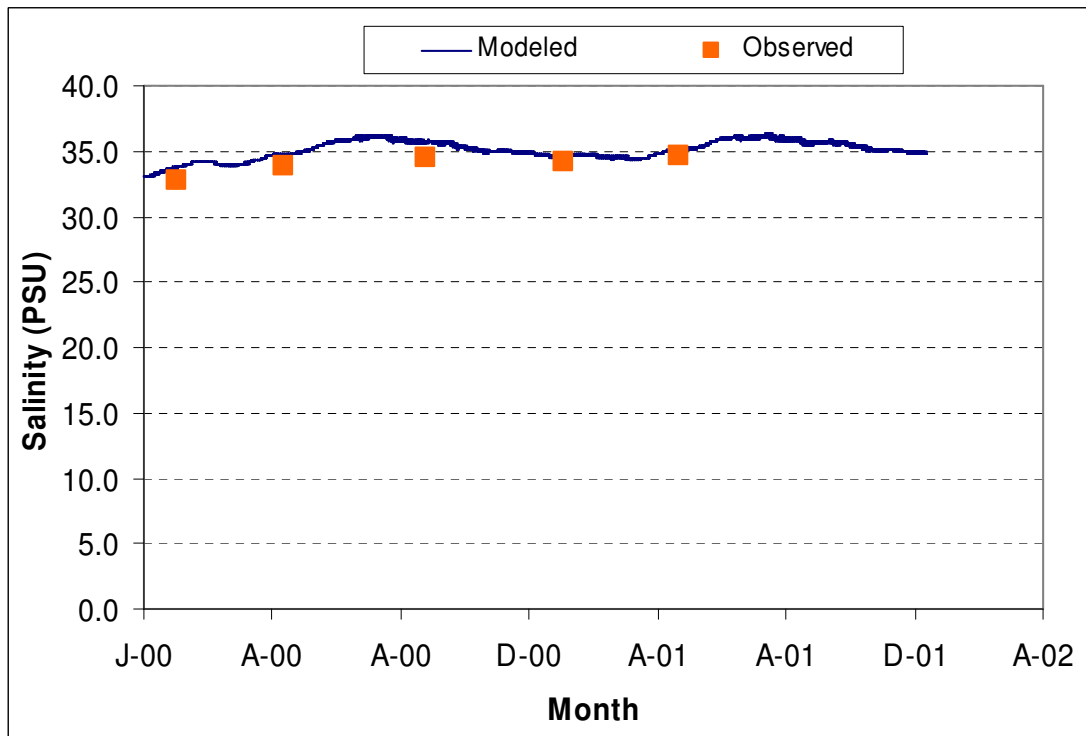

Figure I-52. Comparison of Model Predicted Salinity Results with Observed SPAWAR Results at Station #22

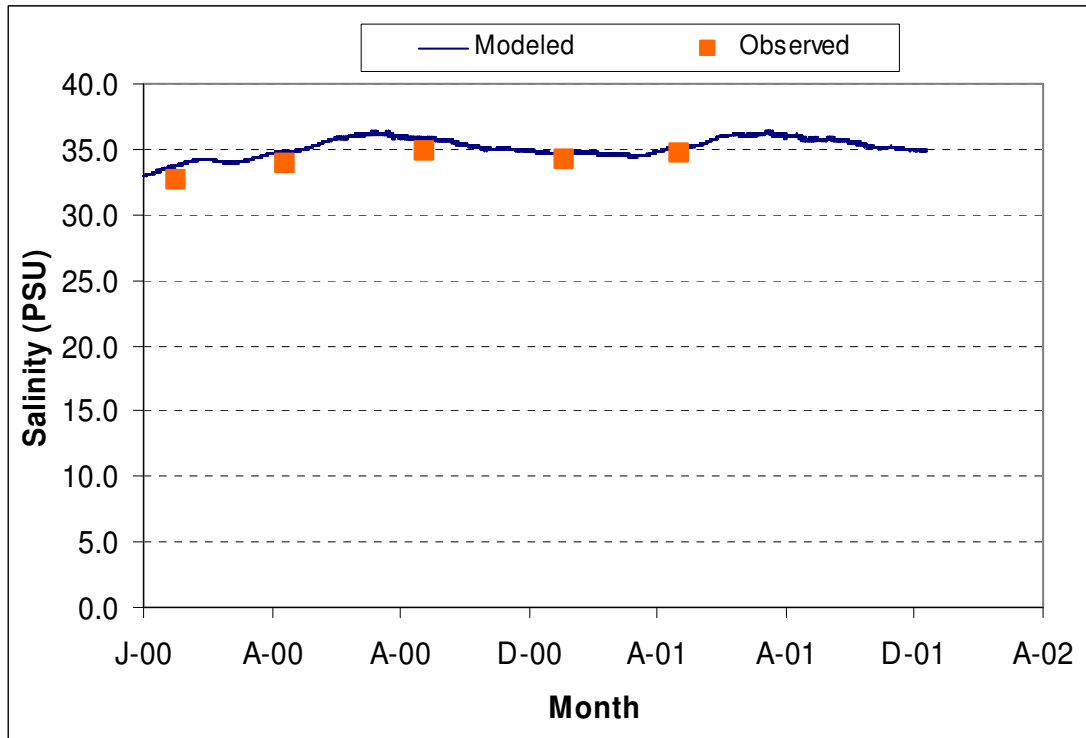

Figure I-53. Comparison of Model Predicted Salinity Results with Observed SPAWAR Results at Station #23

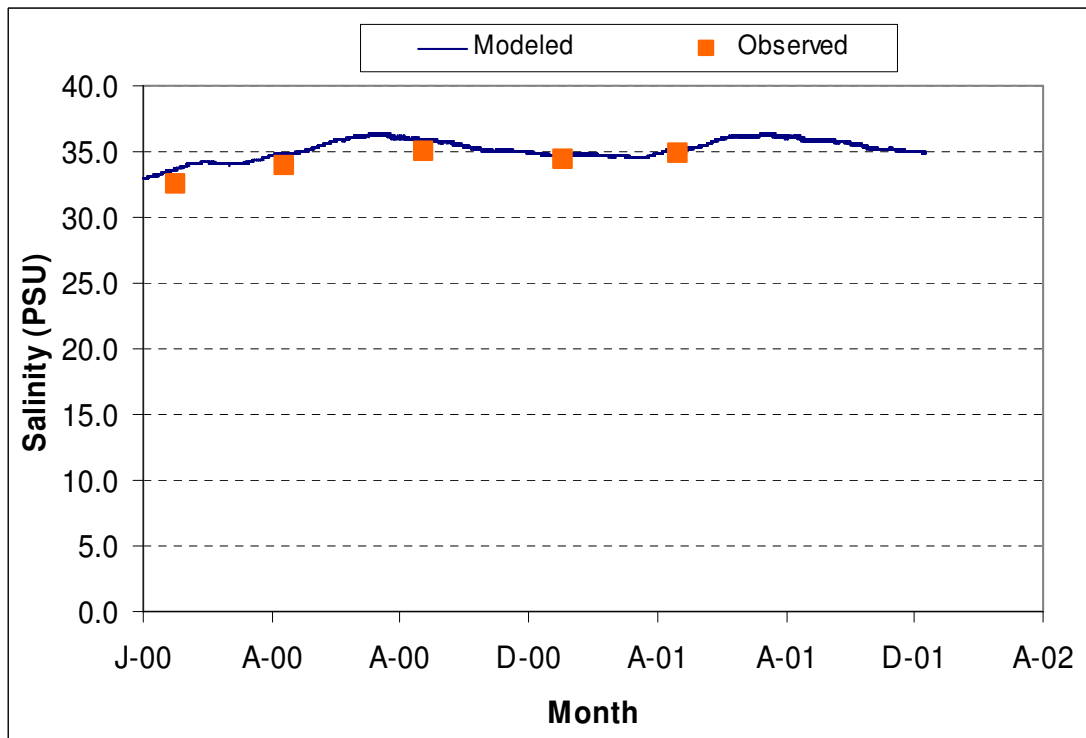

Figure I-54. Comparison of Model Predicted Salinity Results with Observed SPAWAR Results at Station #24

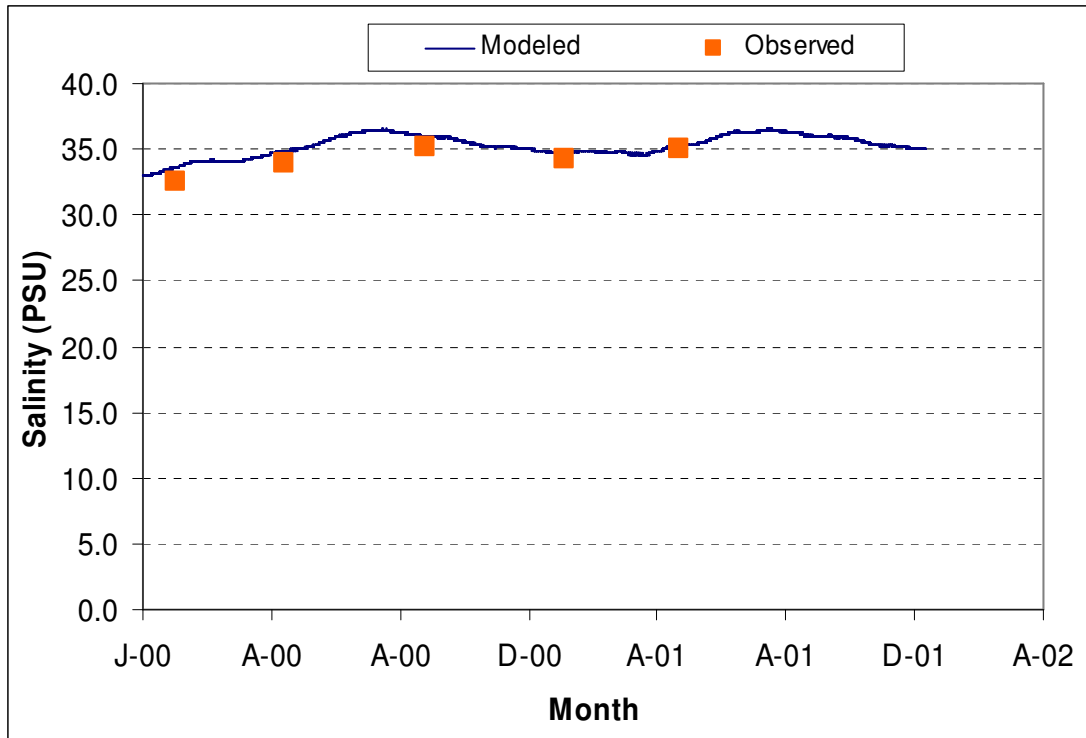

Figure I-55. Comparison of Model Predicted Salinity Results with Observed SPAWAR Results at Station #25

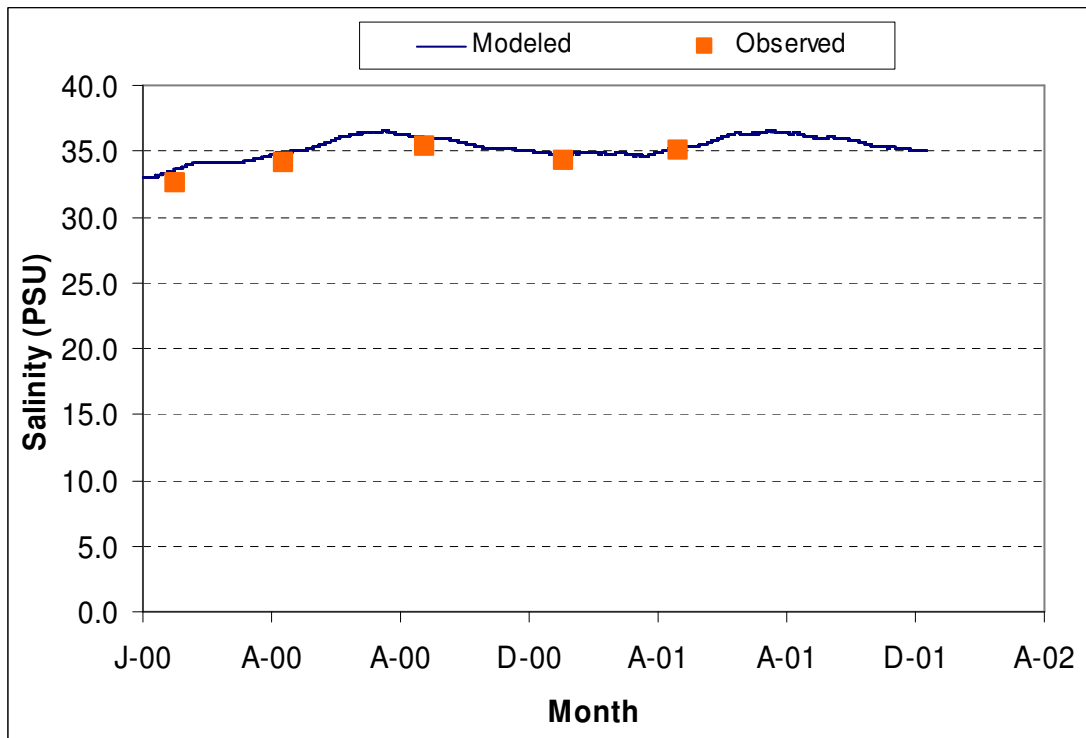

Figure I-56. Comparison of Model Predicted Salinity Results with Observed SPAWAR Results at Station #26

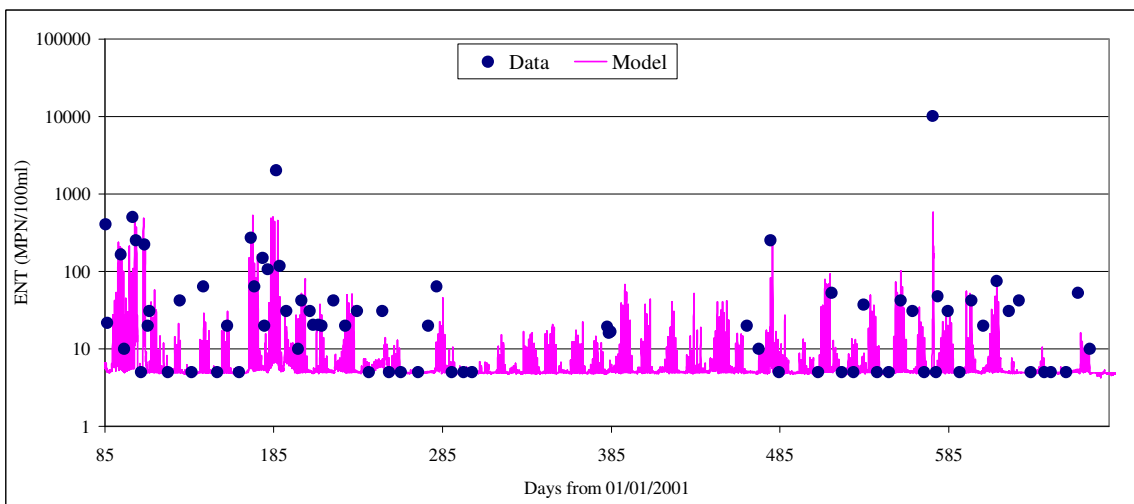
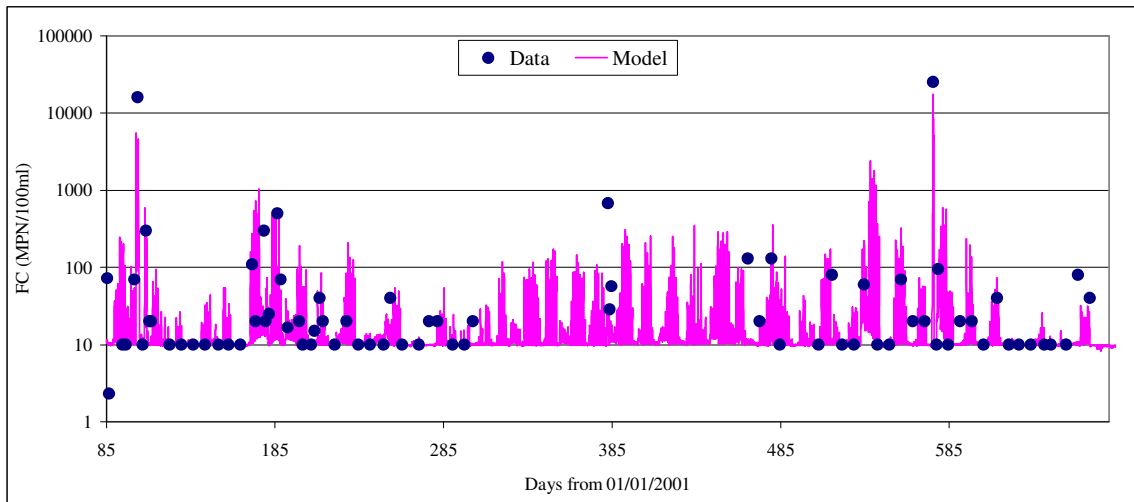
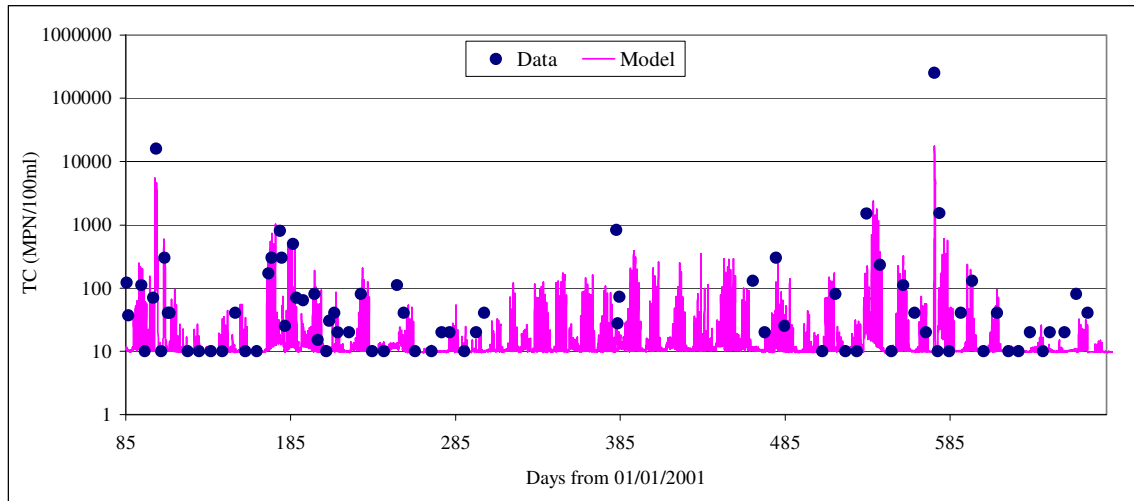

Figure I-57. Comparison of Model Predicted Fecal Coliform, Total Coliform, and Enterococcus Concentrations with

Observed Data for Shelter Island Shoreline Park

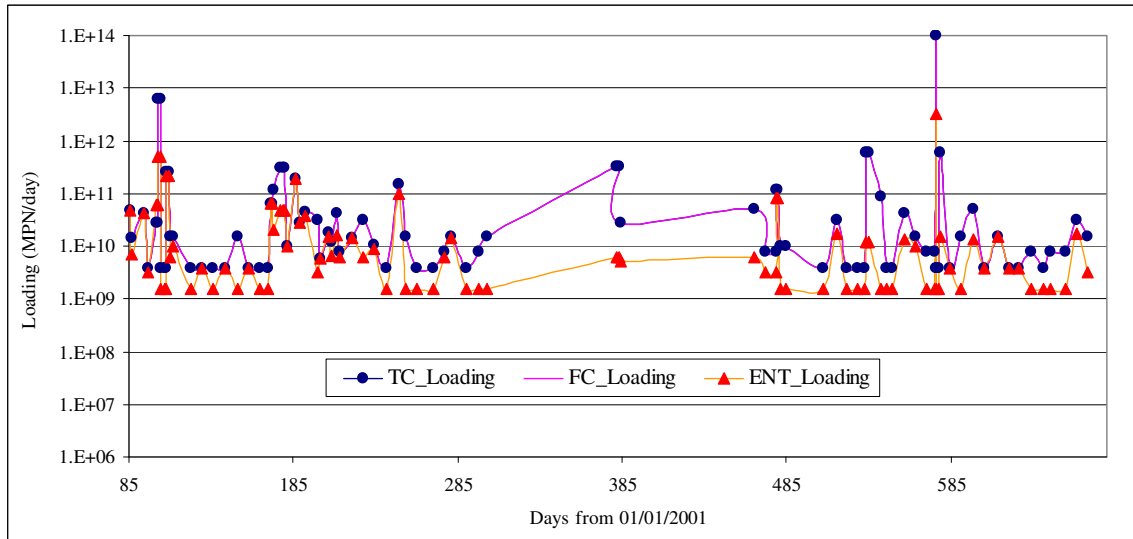

Figure I-58. Inversely Derived Lumped Source Loading for the Simulation Period for Shelter Island Shoreline Park

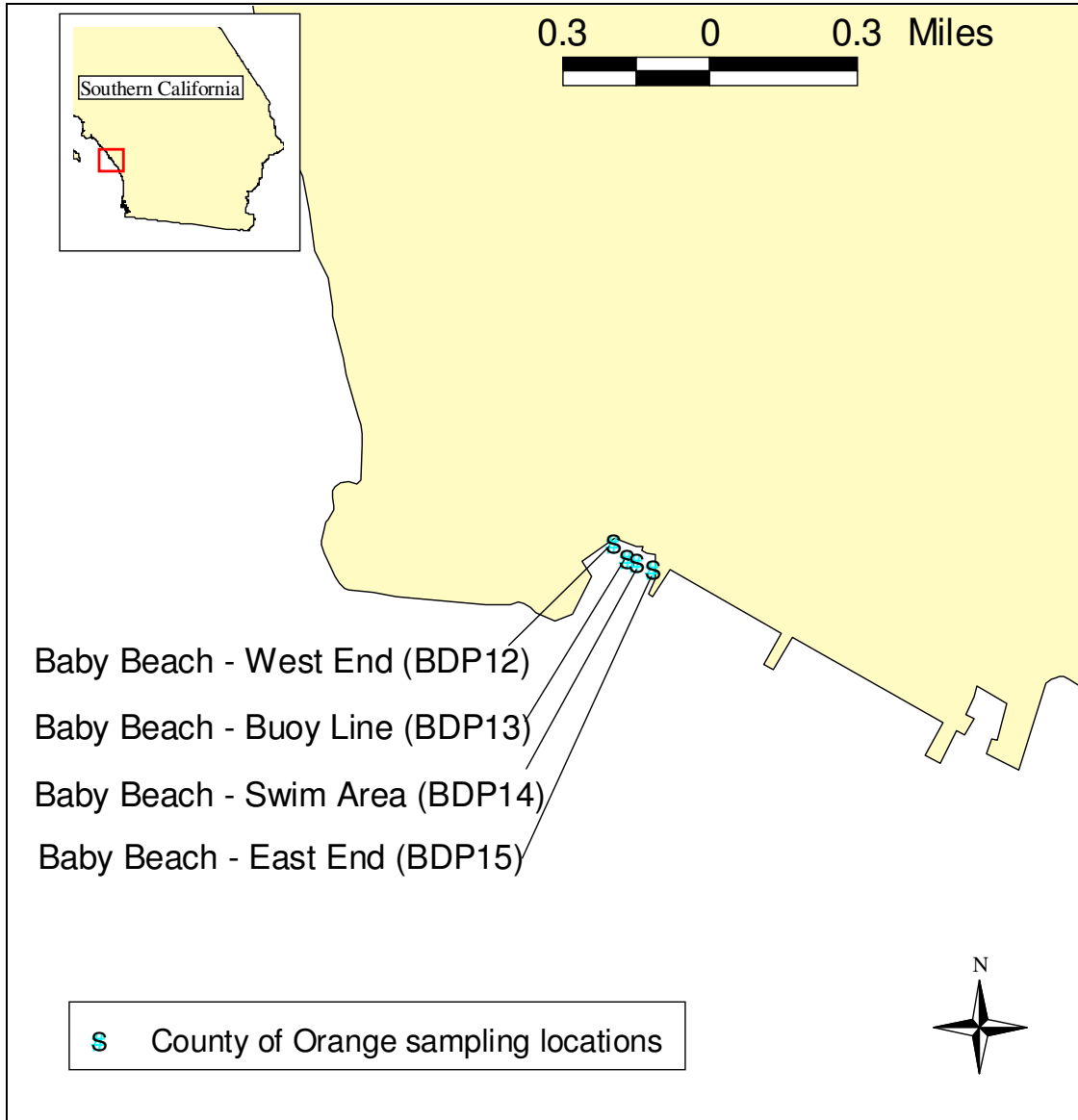

Figure I-59. Sampling Stations Near Baby Beach at Dana Point Harbor

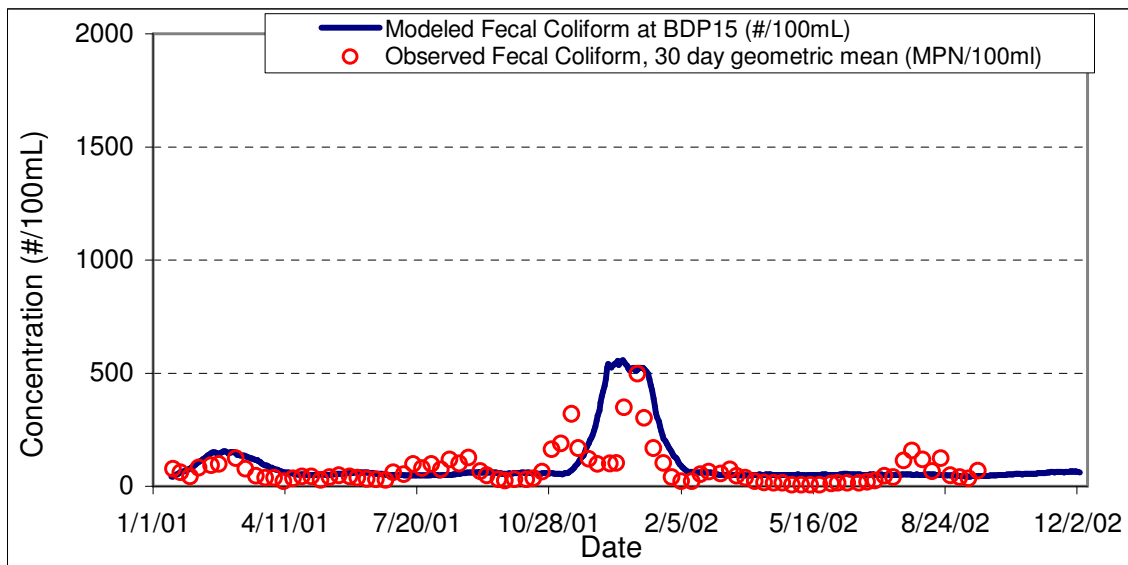
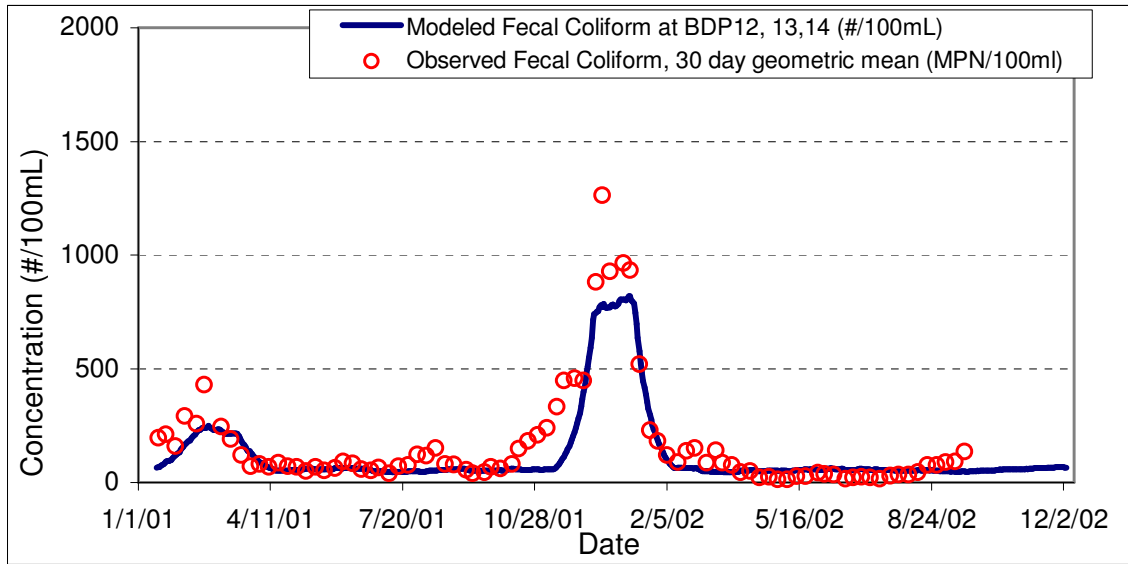

Figure I-60. Simulated Fecal Coliform Concentrations and the Observed 30-day Geometric Mean in Dana Point Harbor

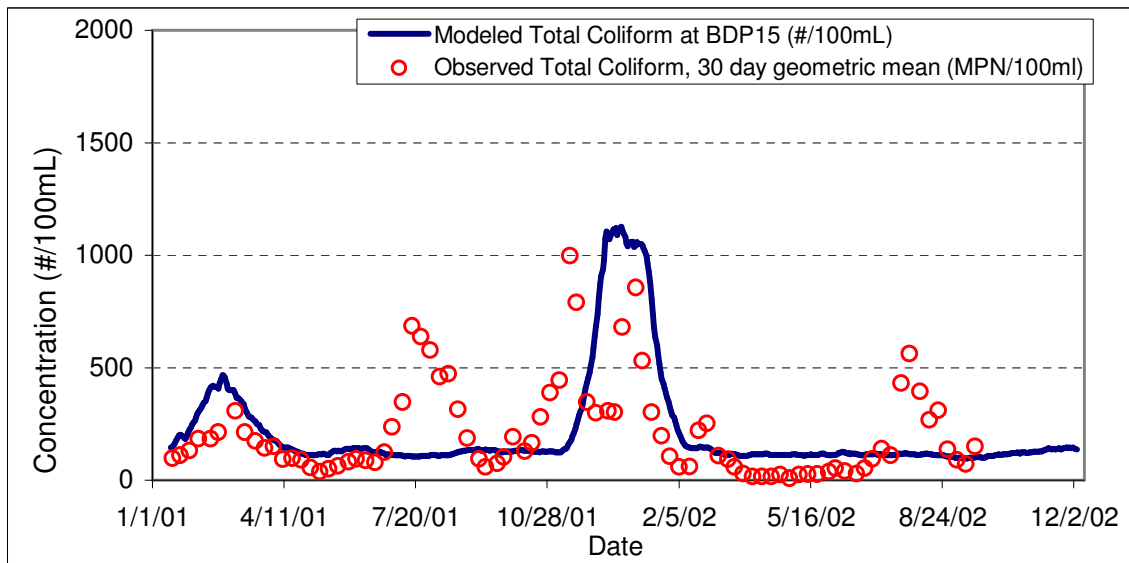
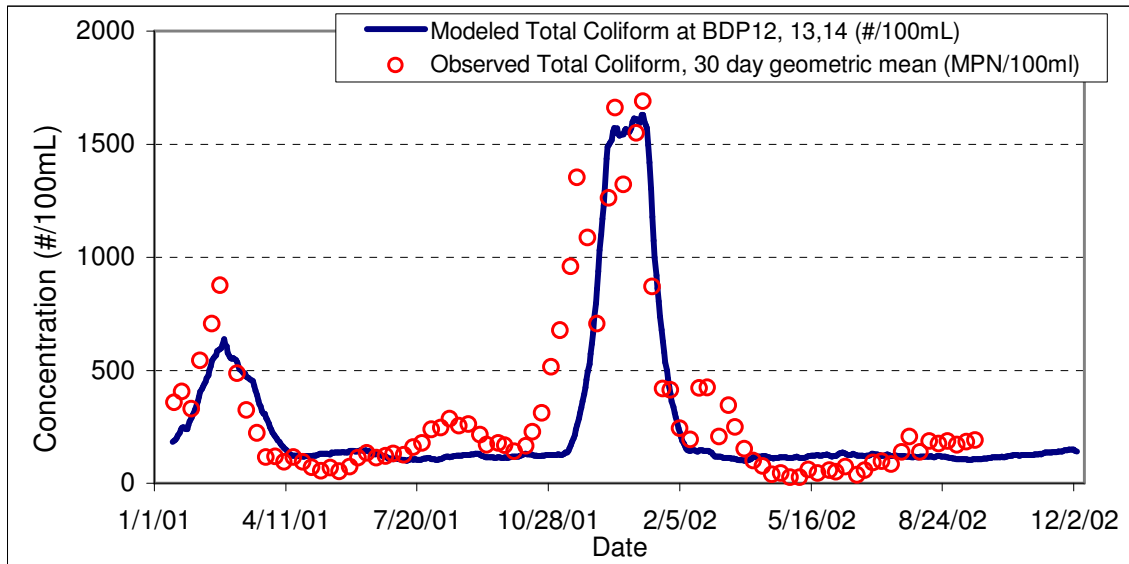

Figure I-61. Simulated Total Coliform Concentrations and the Observed 30-day Geometric Mean in Dana Point Harbor

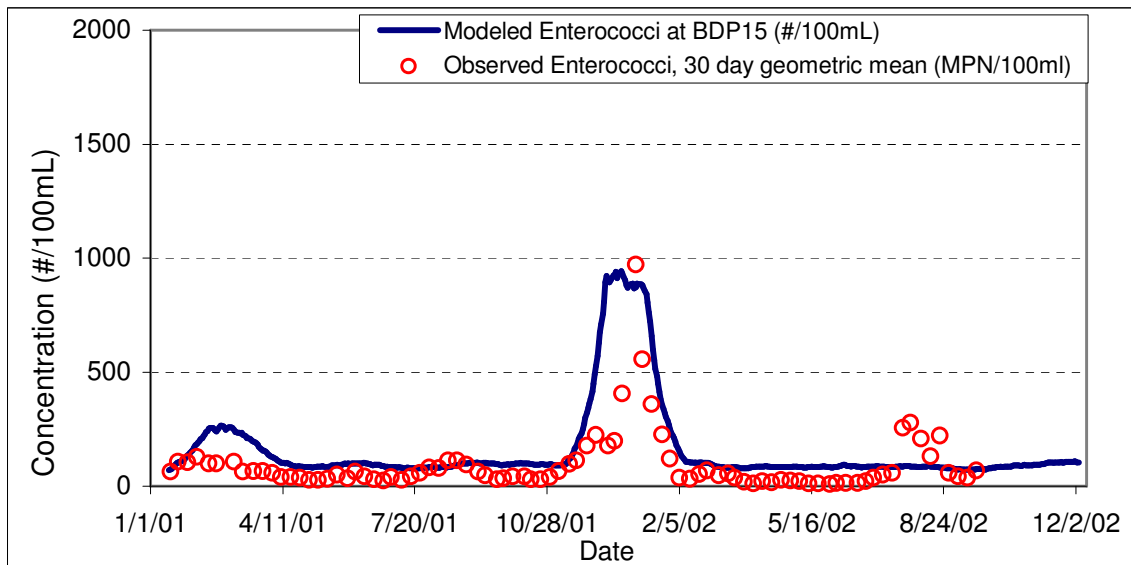
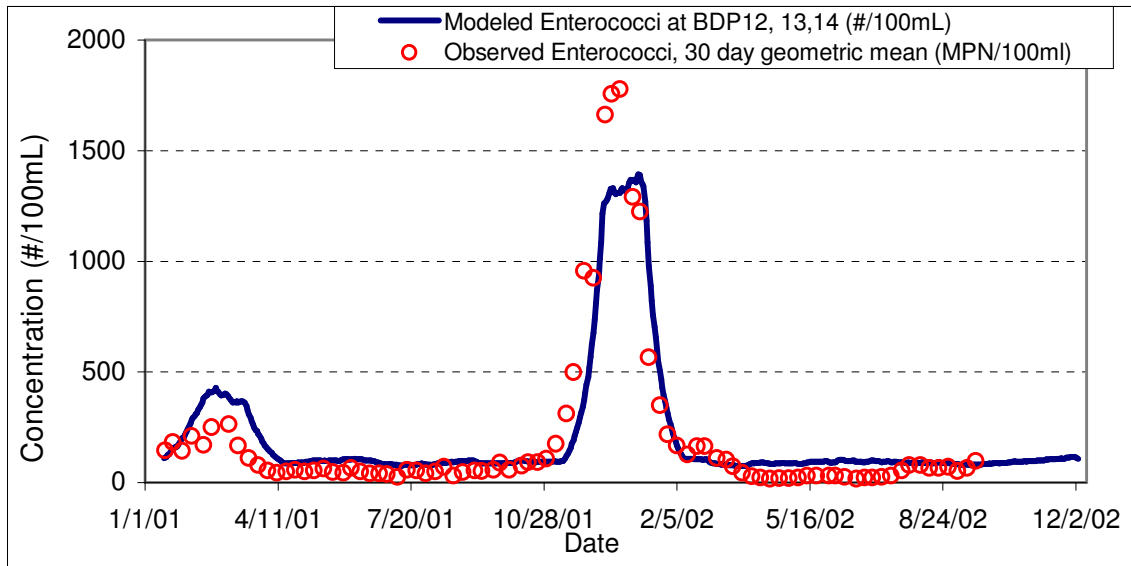

Figure I-62. Simulated Enterococcus Concentrations and the Observed 30-day Geometric Mean in Dana Point Harbor

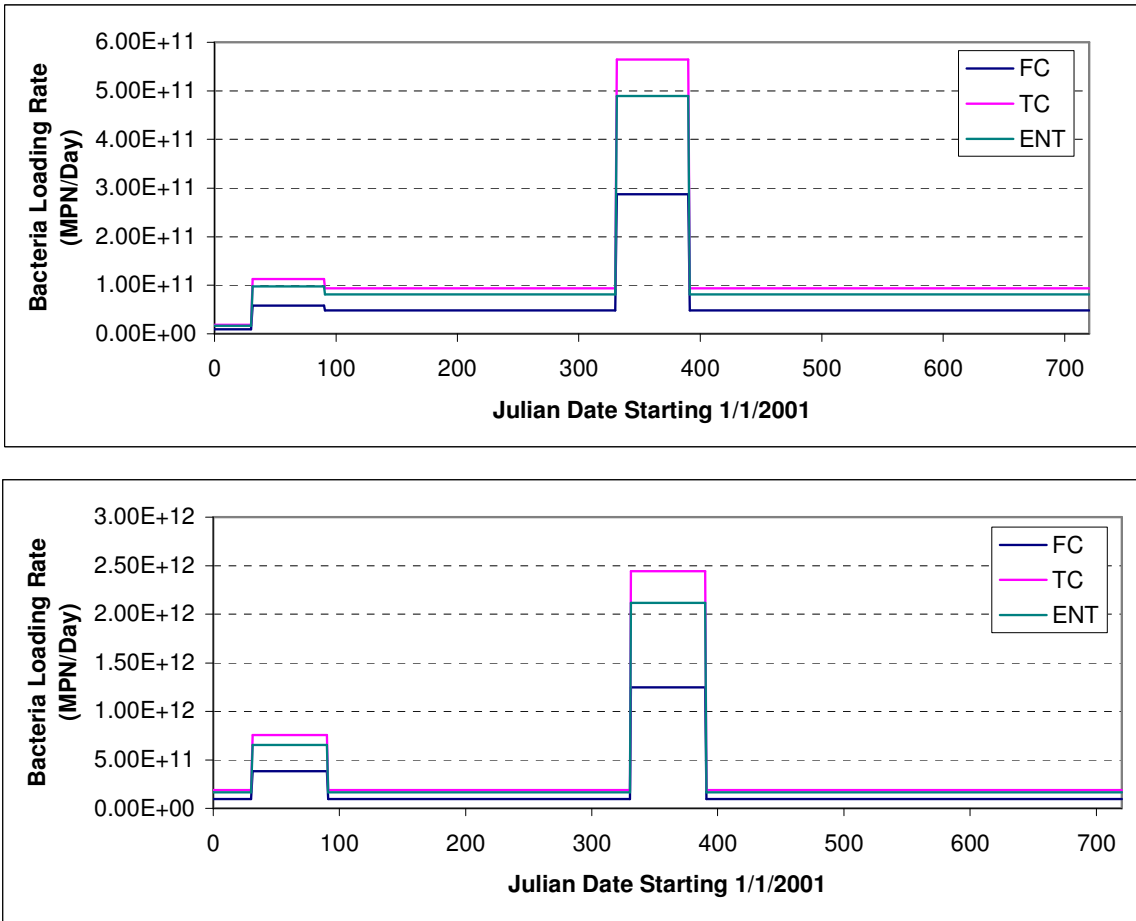

Figure I-63. Inversely-Derived Lumped Sources Loading Applied for the Simulation Period to Two Cells in Baby Beach

Appendix J

Maps of Watersheds for Shoreline Segments

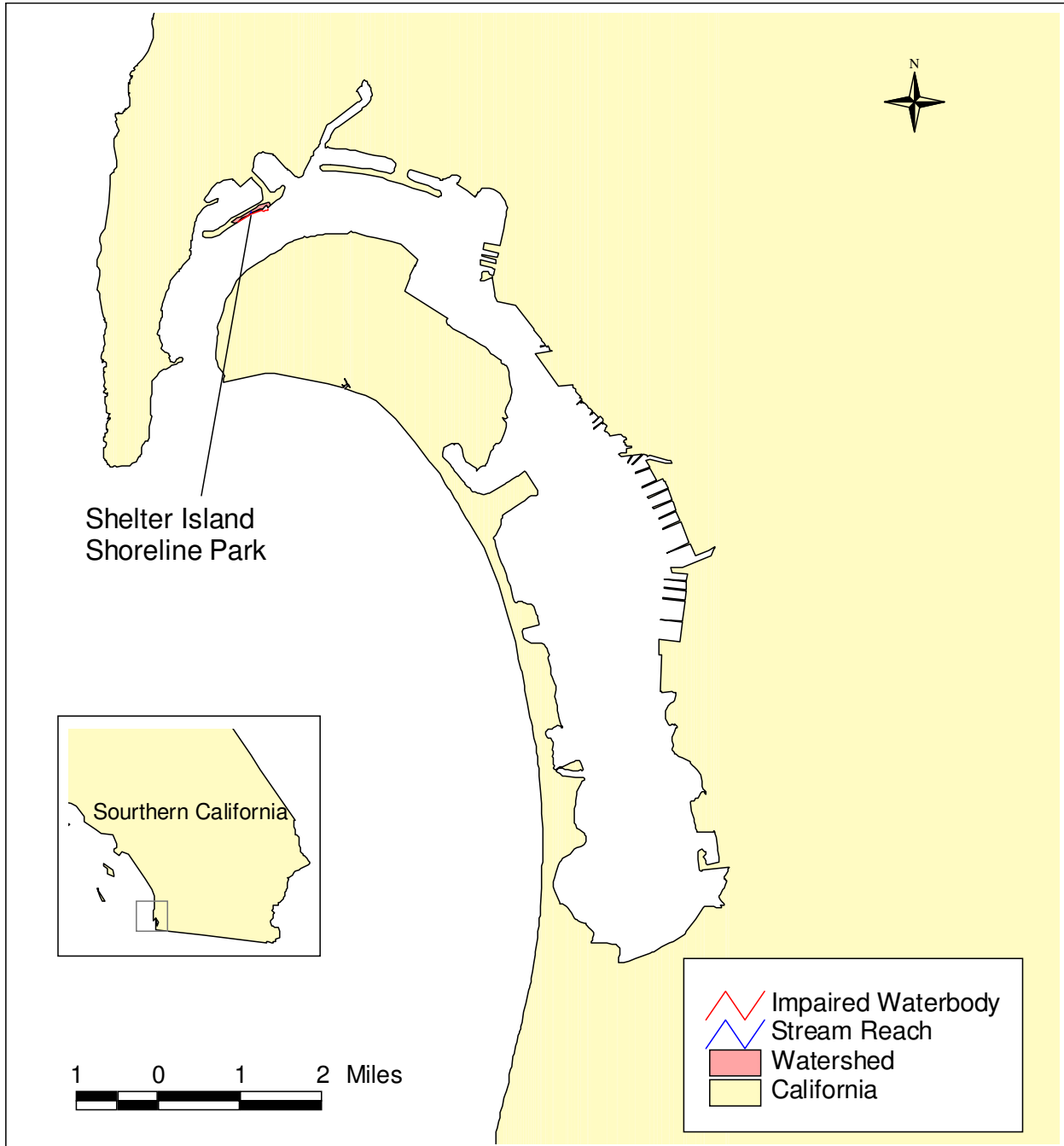

Figure J-1. Shoreline Segments Addressed in San Diego Bay

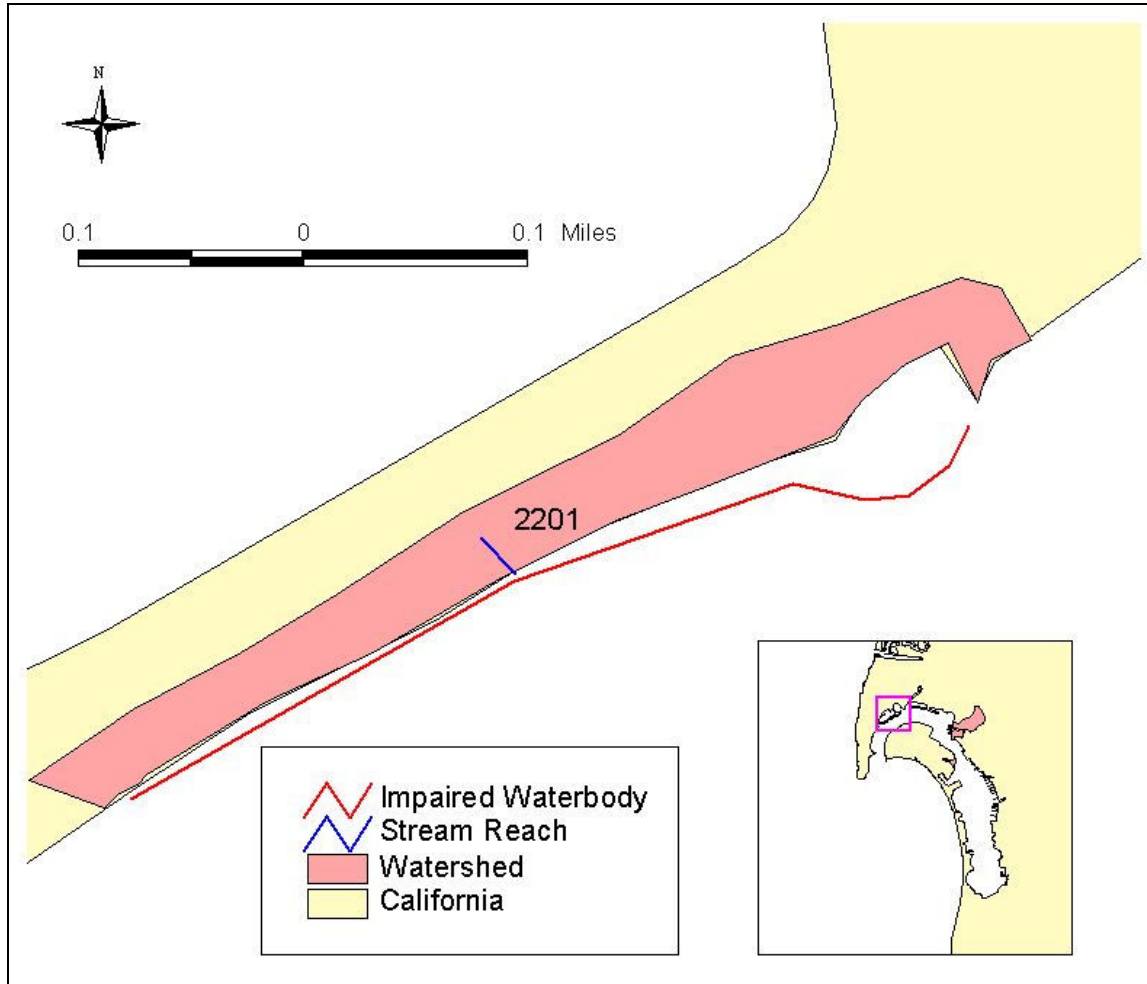

Figure J-2. Shelter Island Shoreline Park Watershed

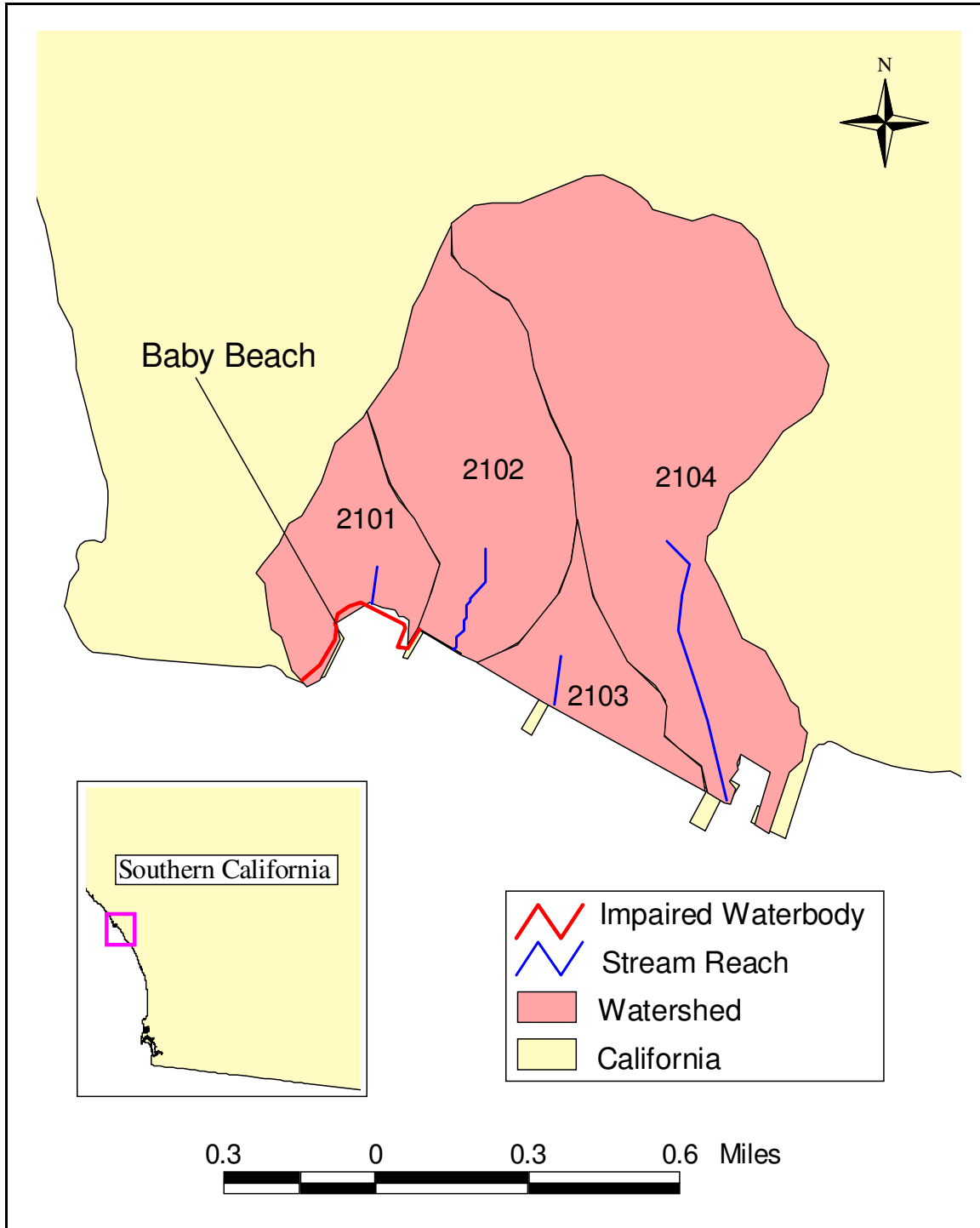

Figure J-3. Dana Point Harbor – Baby Beach Watersheds

Appendix K

Load Reduction Analyses

For determination of the required load reductions to meet wasteload allocations for fecal coliform (FC), total coliform (TC), and *Enterococcus* (ENT), loading analyses were performed for the subwatershed draining to each impaired San Diego Bay (SDB) and Dana Point Harbor (DPH) shoreline segment (see Appendix J for subwatershed maps). These analyses provided a comprehensive assessment of varying storm loads over a 30-day period from January 7, 1993 through February 5, 1993, which represented various critical wet-weather events that impact the loading of bacteria from stormwater runoff.

An LSPC model was used to simulate storm volumes and associated bacteria loads over the 30-day period. Loading capacities for each day were calculated based on separate EFDC models of shoreline receiving waters. Determination of required load reductions assumed that all loads below the load-capacity curve (blue) are allowable and are therefore assigned wasteload allocations. All loads above the load-capacity curve (red) are not allowed and are therefore designated as required load reductions. The percent reduction is calculated by dividing the required load reduction (red) by the total load below the load-capacity curve.

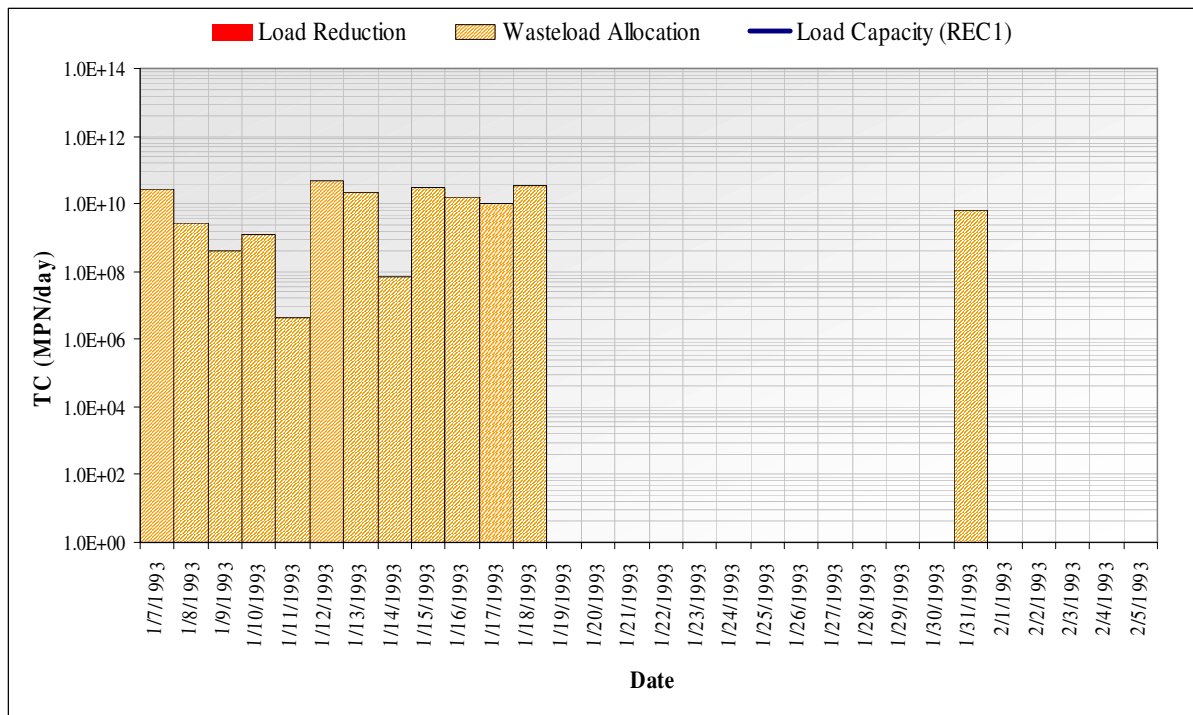

Figure K-1. Load Reduction Analysis at Shelter Island Shoreline Park-TC (REC1) (Subwatershed 2201).

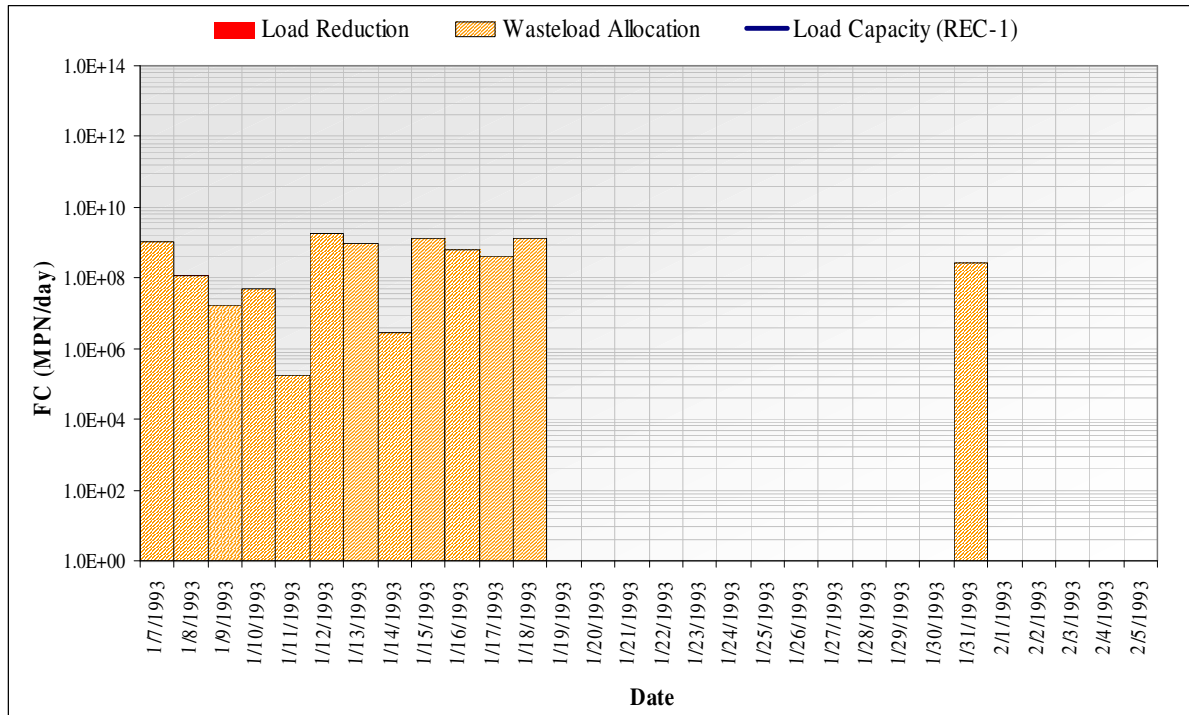

Figure K-2. Load Reduction Analysis at Shelter Island Shoreline Park-FC (REC1) (Subwatershed 2201).

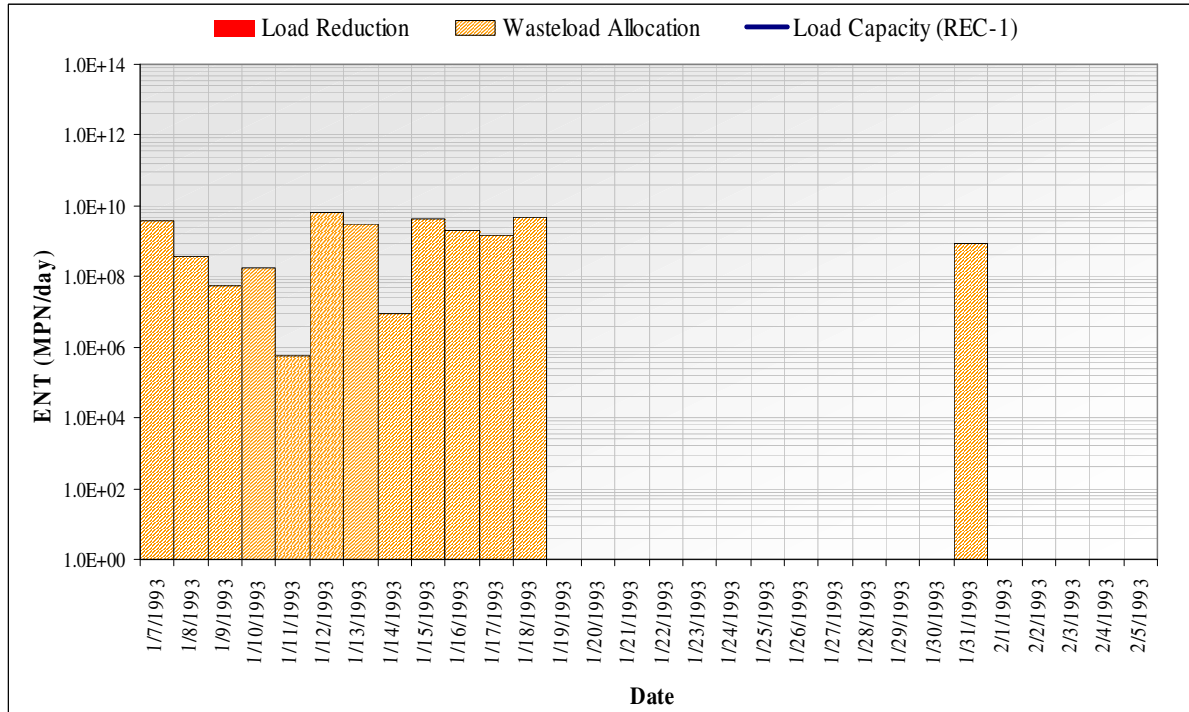

Figure K-3. Load Reduction Analysis at Shelter Island Shoreline Park-ENT (REC1) (Subwatershed 2201).

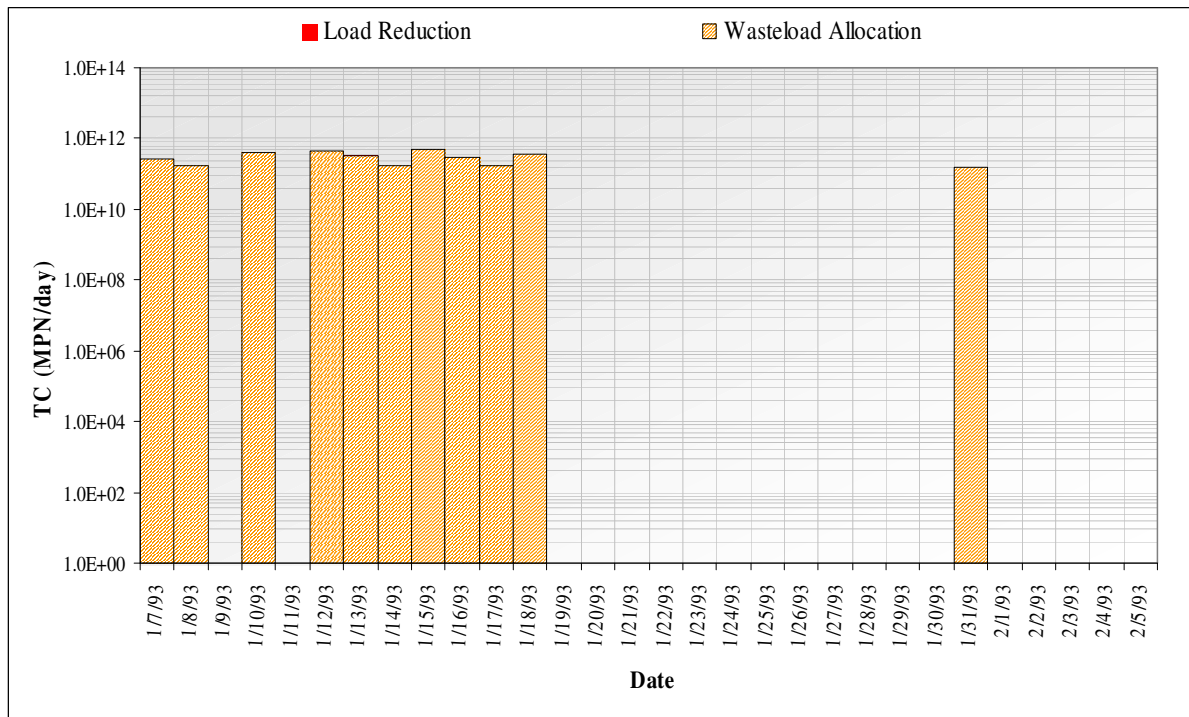

Figure K-4. Load Reduction Analysis at Baby Beach Shoreline-TC (REC1) (Subwatersheds 2101-2104).

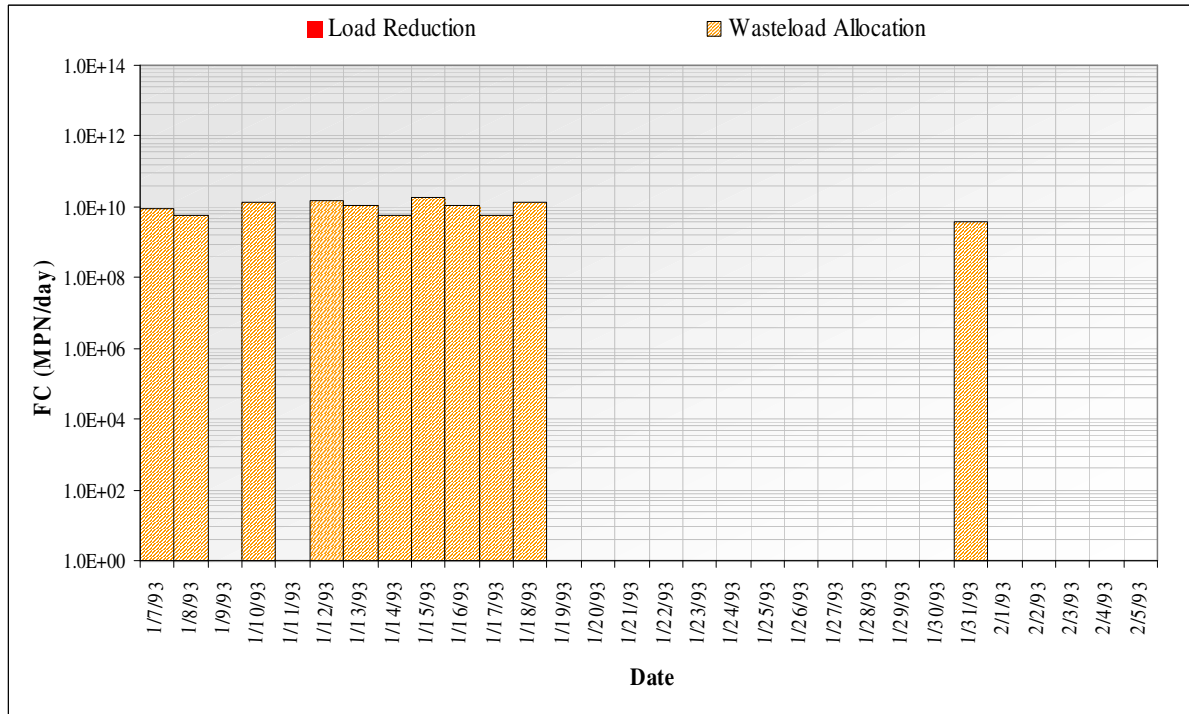

Figure K-5. Load Reduction Analysis at Baby Beach Shoreline-FC (REC1) (Subwatersheds 2101-2104)

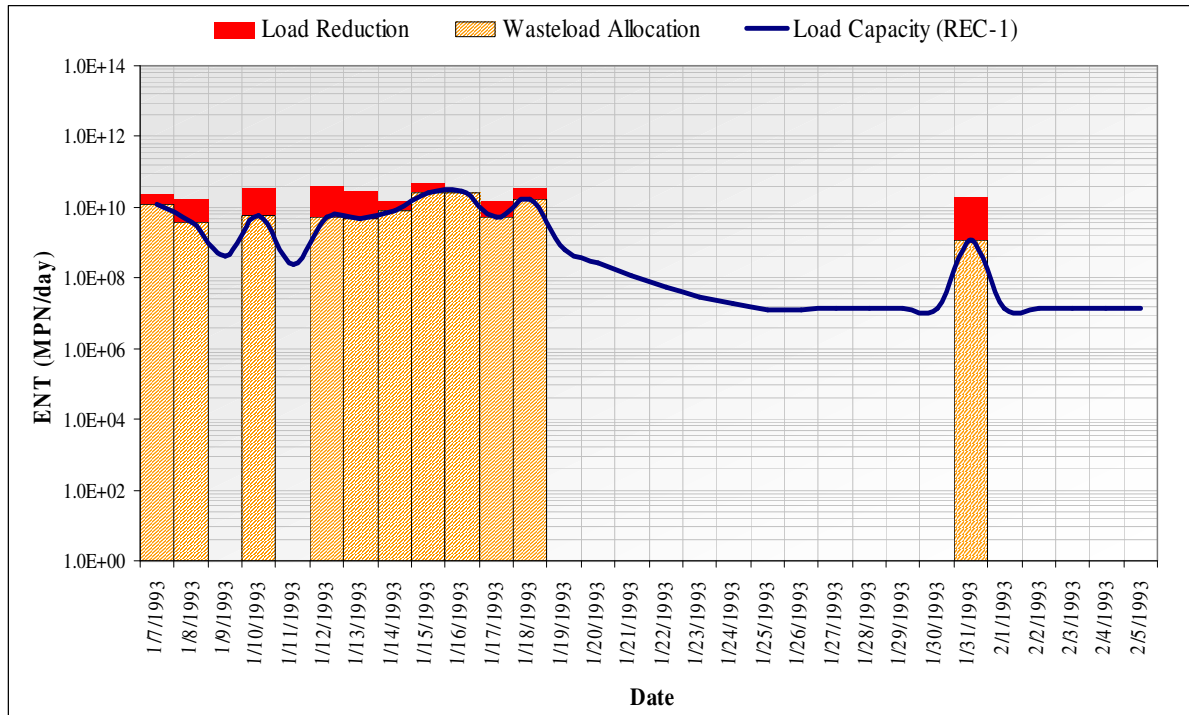

Figure K-6. Load Reduction Analysis at Baby Beach Shoreline-ENT (REC1) (Subwatersheds 2101-2104).

Appendix L
Dry Weather Modeling
Load Estimates

The dry weather steady-state watershed model was used to calculate the allowable loading from dry weather urban runoff by calculating the dry weather flow and multiplying it by the dry weather 30-day geometric mean numeric targets. This allowable bacteria load from the watershed was used as a boundary condition in the receiving water (EFDC) model. Nonpoint, non-urban runoff sources of bacteria that may be attributed to waterfowl or other unidentified sources within the receiving waters were added to the allowable load calculated from the dry weather steady-state watershed model. These loads were modeled on an hourly basis during the 30-day critical tidal period by the EFDC model. The hourly model-predicted bacteria densities allowed the consideration of diurnal variations in water quality resulting from tidal fluctuations, which may vary by orders of magnitude.

The hourly EFDC model-predicted bacteria densities were used to calculate a geometric mean bacteria density for the 30-day critical tidal period. Additionally, the hourly EFDC model-predicted bacteria densities were used to calculate daily arithmetic averages for each day of the 30-day critical tidal period. The 30-day critical tidal period geometric mean was compared to the 30-day geometric mean numeric target. The daily arithmetic averages were compared to the single sample maximum numeric target.

Bacteria loads attributed to non-urban runoff sources (e.g., waterfowl or other unidentified sources) were increased until either the 30-day critical tidal period geometric mean was equal to the 30-day geometric mean numeric target, or one or more daily arithmetic means was equal single sample maximum numeric target. This was considered the allowable load attributed to non-urban runoff sources that could still meet the assimilative capacity of the receiving water, while accounting for the allowable loads from urban runoff sources.

Results of these analyses are shown in the following figures for the dry weather 30-day critical tidal period evaluated. The graphical results show the hourly EFDC model-predicted bacteria densities (blue lines), which are used to calculate the daily arithmetic means (green lines) and 30-day critical tidal period geometric means (not shown). The 30-day critical tidal period geometric means are not shown in the figures, because the 30-day critical tidal period geometric mean is a single point

The daily arithmetic means (green lines) are compared to the single sample maximum numeric targets (dashed red lines). The 30-day critical tidal period geometric means are compared to the 30-day geometric mean numeric targets (solid red lines). As discussed above, the 30-day critical tidal period geometric means are not shown in the figures; however, they are less than or equal to the 30-day geometric mean numeric targets.

For each shoreline segment evaluated, the EFDC model-predicted TC, FC and ENT bacteria densities were compared to REC-1 WQOs for development of TMDLs.

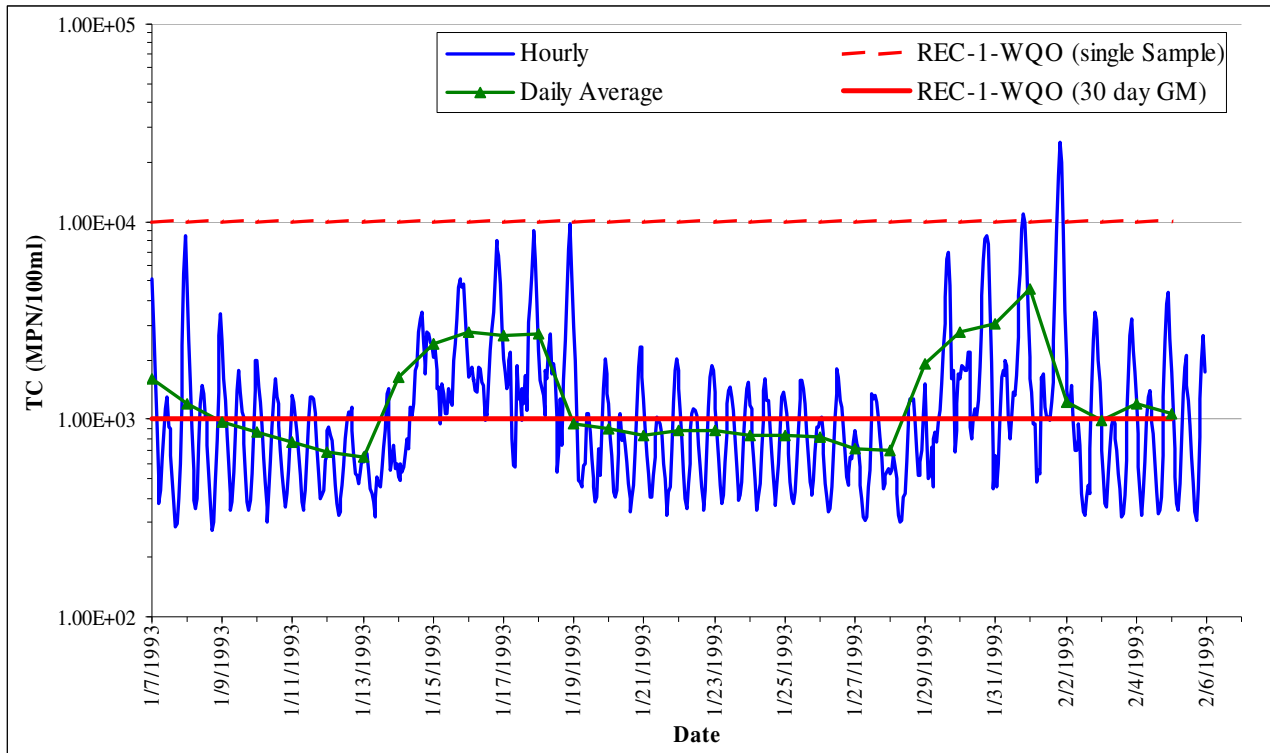

Figure L-1. Model-Predicted Total Coliform Concentration at Shelter Island Shoreline Park, San Diego Bay-Dry Weather

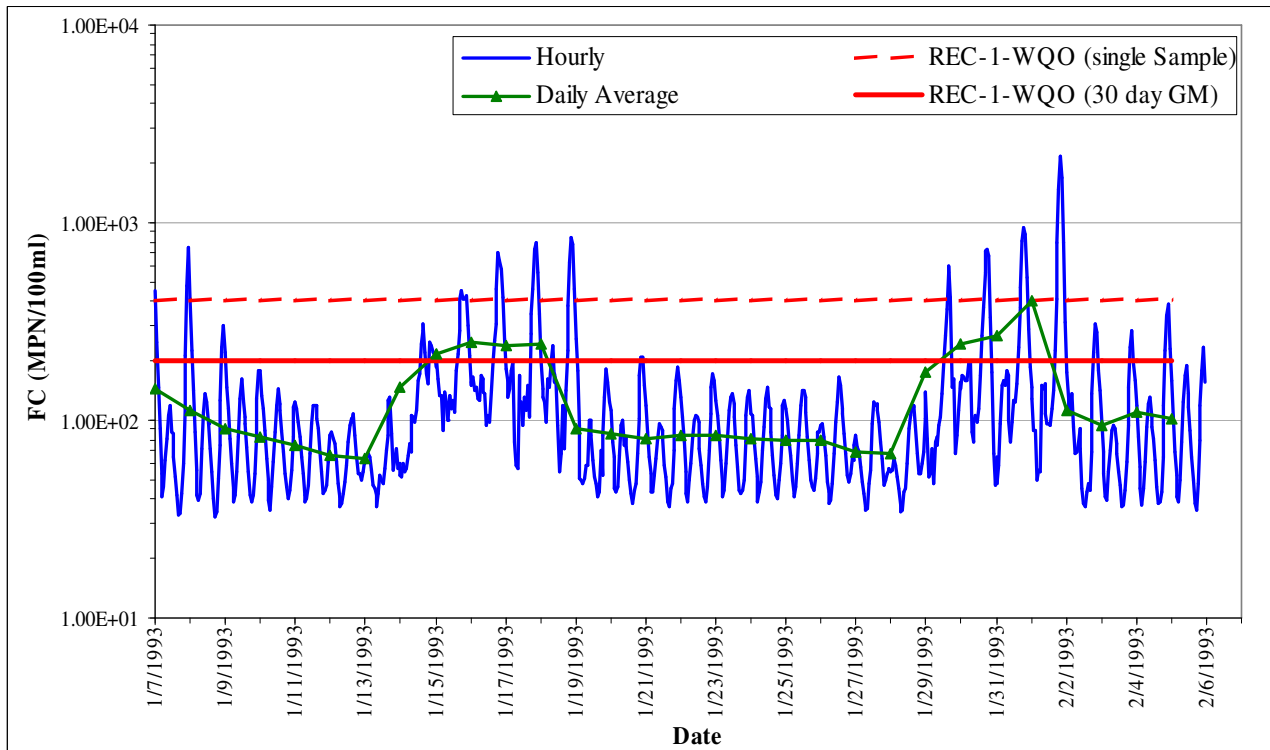

Figure L-2. Model-Predicted Fecal Coliform Concentration at Shelter Island Shoreline Park, San Diego Bay-Dry Weather

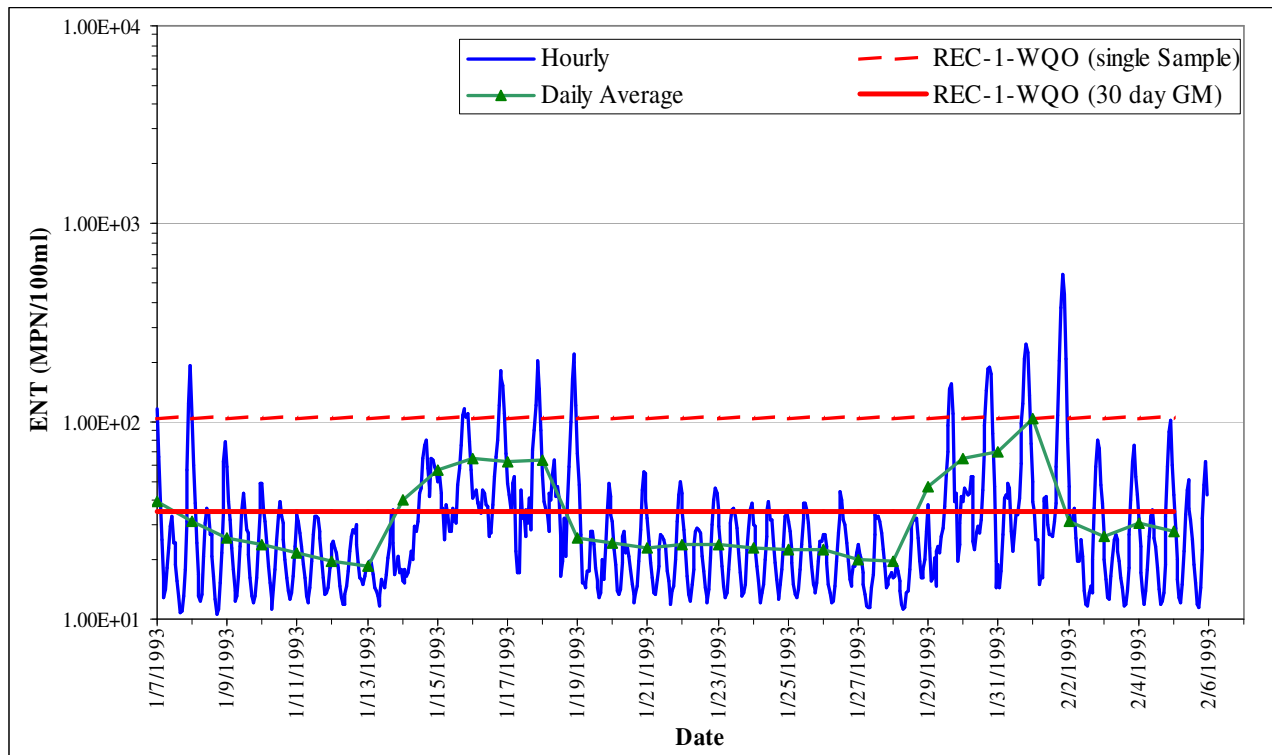

Figure L-3. Model-Predicted *Enterococcus* Concentration at Shelter Island Shoreline Park, San Diego Bay-Dry Weather

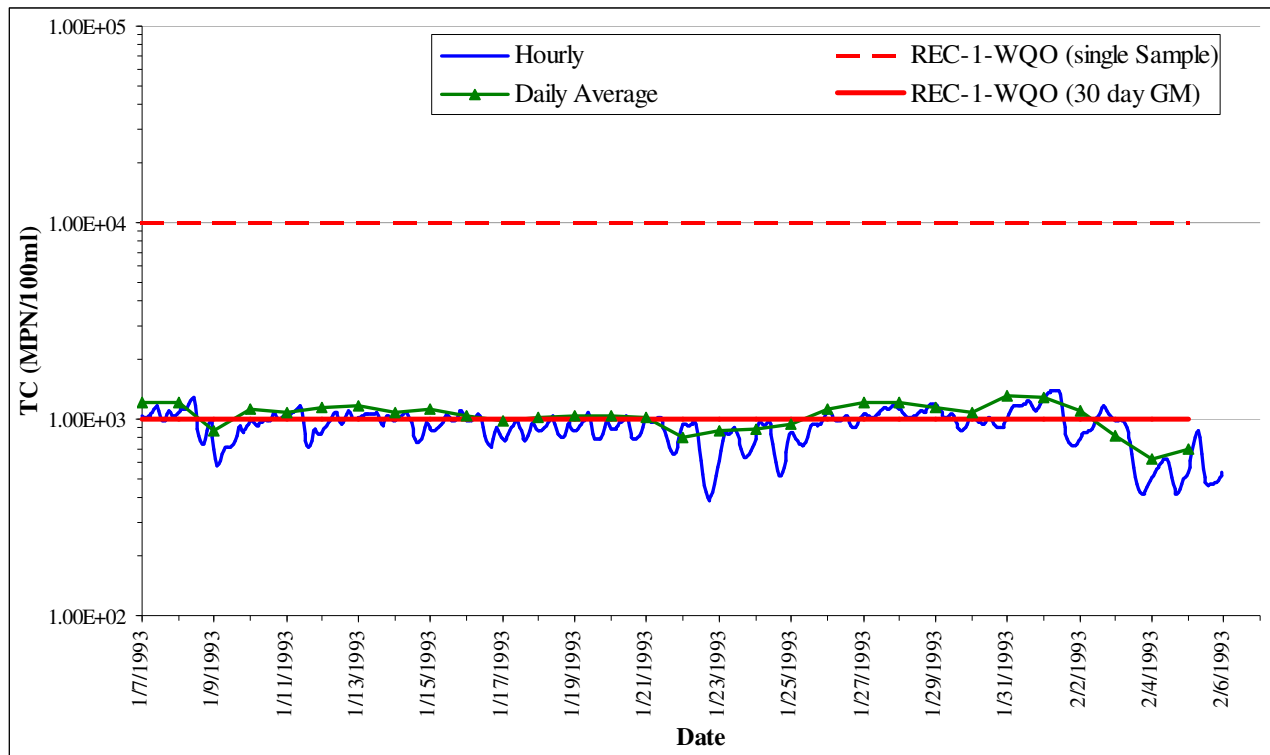

Figure L-4. Model-Predicted Total Coliform Concentration at Baby Beach Shoreline, Dana Point Harbor- Dry Weather

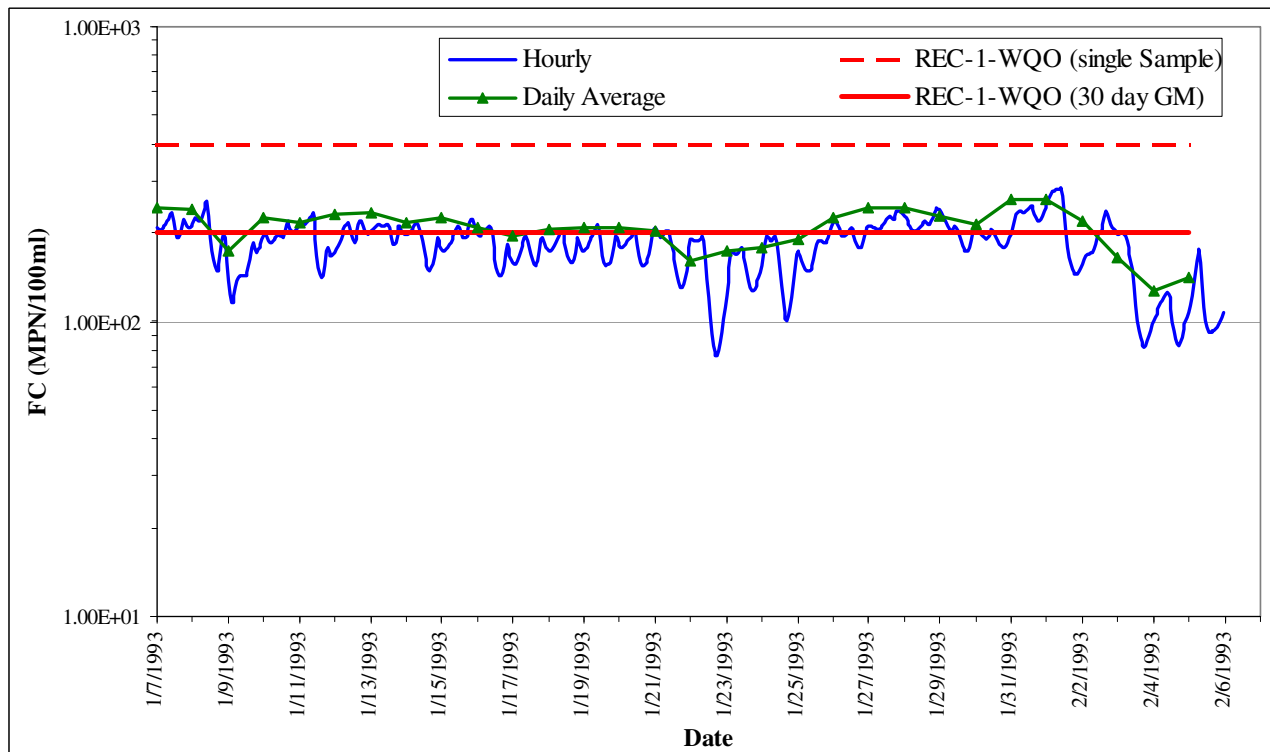

Figure L-5. Model-Predicted Fecal Coliform Concentration at Baby Beach Shoreline, Dana Point Harbor- Dry Weather

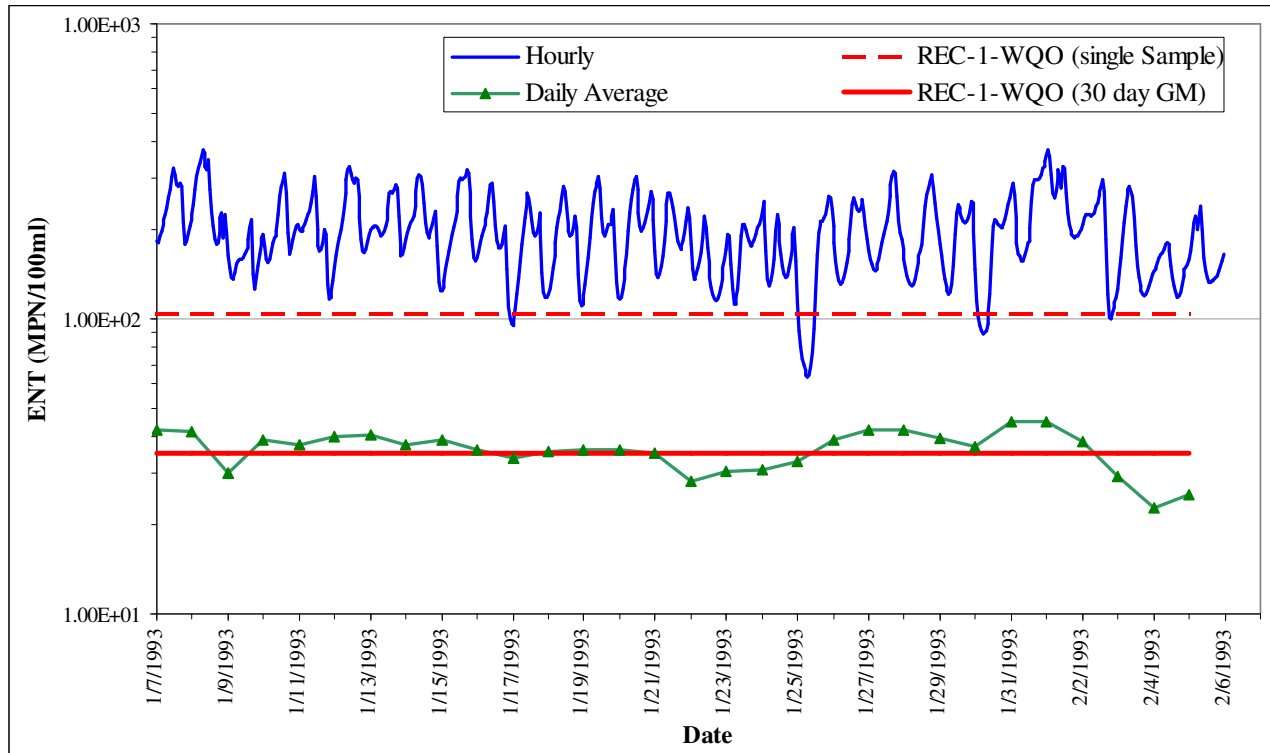

Figure L-6. Model-Predicted *Enterococcus* Concentration at Baby Beach Shoreline, Dana Point Harbor-Dry Weather

Appendix M

Environmental Analysis and Checklist

This page left intentionally blank

Appendix M

Table of Contents

M	Environmental Analysis and Checklist	1
M.1	California Environmental Quality Act Requirements.....	1
	M.1.1 Exemption from Requirement to Prepare Standard CEQA Documents	1
	M.1.2 Scope of Environmental Analysis	2
M.2	Description of the Proposed Activity.....	3
	M.2.1 Surrounding Land Uses and Setting.....	4
M.3	Analysis of Reasonably Foreseeable Methods of Compliance.....	5
M.4	Environmental Checklist.....	7
M.5	Discussion of Possible Environmental Impacts of Reasonably Foreseeable Compliance Methods and Mitigation Measures.....	12
	M.5.1 Alternative Means of Compliance	51
M.6	Reasonably Foreseeable Methods of Compliance at Specific Sites	52
	M.6.1 Potential Controls for Animal Operations.....	Error! Bookmark not defined.
	M.6.2 Potential Controls for Construction Sites	Error! Bookmark not defined.
	M.6.3 Potential Controls for Agricultural Areas	Error! Bookmark not defined.
	M.6.4 Potential Controls for Residential Areas	53
	M.6.5 Potential Controls for Park and Recreational Areas	54
	M.6.6 Potential Controls for Commercial/Institutional Areas.....	56
	M.6.7 Potential Controls for Industrial and Transportation Areas	57
M.7	Economic Factors	58
	M.7.1 Legal Requirement for Economic Analysis	58
	M.7.2 Project Implementation Costs.....	59
	M.7.3 Cost Estimates of Reasonably Foreseeable Controls	59
	M.7.4 Costs for Agricultural Sources of Nonpoint Pollution	60
	M.7.5 Potential Sources of Funding	62
M.8	Reasonable Alternatives to the Proposed Activity	63
	M.8.1 No Action.....	64
	M.8.2 Re-adopt the Existing Conditional Waivers without Revisions.....	Error! Bookmark not defined.
	M.8.3 Adopt General Waste Discharge Requirements for Specific Types of Discharge	Error! Bookmark not defined.
	M.8.4 Preferred Alternative.....	65
M.9	CEQA Determination.....	66

This page left intentionally blank

M Environmental Analysis and Checklist

M.1 California Environmental Quality Act Requirements

The California Regional Water Quality Control Board, San Diego Region (San Diego Water Board) must comply with the California Environmental Quality Act (CEQA) when amending the *Water Quality Control Plan for the San Diego Basin (9)* (Basin Plan) as proposed in this project to adopt total maximum daily loads (TMDLs) for indicator bacteria at the impaired shoreline segments of Baby Beach and Shelter Island Shoreline Park. Under the CEQA, the San Diego Water Board is the Lead Agency for evaluating the environmental impacts of the reasonably foreseeable methods of compliance with the proposed conditional waivers.

The adoption of a Basin Plan amendment is an activity subject to CEQA requirements because Basin Plan amendments constitute rules or regulations requiring the installation of pollution control equipment, establishing a performance standard, or establishing a treatment requirement.¹ TMDL Basin Plan amendments normally contain a quantifiable numeric target that interprets the applicable water quality objective. TMDLs also include wasteload allocations (WLAs) for point sources and load allocations (LAs) for nonpoint sources and natural background. The quantifiable target together with the allocations may be considered a performance standard.² Sections M.1.1 and M.1.2 below describe in detail the statutory requirements and scope of this environmental analysis required by the CEQA for Basin Plan amendments.

M.1.1 Exemption from Requirement to Prepare Standard CEQA Documents

The CEQA authorizes the Secretary of the Resources Agency to certify state regulatory programs, designed to meet the goals of the CEQA, as exempt from its requirements to prepare an Environmental Impact Report (EIR), Negative Declaration, or Initial Study. The State Water Resources Control Board's (State Water Board) and the San Diego Water Board's Basin Plan amendment process is a certified regulatory program and is therefore exempt from the CEQA's requirements to prepare such documents.³

The State Water Board's CEQA implementation regulations⁴ describe the environmental documents required for Basin Plan amendment actions. These documents consist of a written report that includes a description of the proposed activity, alternatives to the proposed activity to reduce or eliminate potentially significant environmental impacts, and identification of mitigation measures to minimize any significant adverse impacts. For this project, these documents are the Technical Report entitled *Total Maximum*

¹ California Code of Regulations Title 14 section 15187(a)

² The term "performance standard" is defined in the rulemaking provisions of the Administrative Procedure Act [Government Code sections 11340-11359]. A "performance standard" is a regulation that describes an objective with the criteria stated for achieving the objective [Government Code section 11342(d)].

³ California Code of Regulations Title 14 section 15251(g) and Public Resources Code section 21080.5

⁴ California Code of Regulations Title 23 section 3720 et seq. "Implementation of the Environmental Quality Act of 1970"

Daily Loads for Indicator Bacteria, Baby Beach in Dana Point Harbor and Shelter Island Shoreline Park in San Diego Bay (Technical Report), an initial draft of the Basin Plan amendment (Appendix C) and an environmental checklist (section M.4 below). These components fulfill the requirements of the CEQA for preparation of environmental documents for this Basin Plan amendment.⁵

M.1.2 Scope of Environmental Analysis

The CEQA has specific provisions that establish the scope of the environmental analysis required for the adoption of this TMDL Basin Plan amendment. The CEQA limits the scope to an environmental analysis of the reasonably foreseeable methods of compliance with the WLAs and LAs. The State Water Board CEQA Implementation Regulations for Certified Regulatory Programs⁶ require the environmental analysis to include at least the following:

1. A brief description of the proposed activity. In this case, the proposed activity is the TMDL Basin Plan amendment. The Basin Plan amendment is described in section M.2 of this appendix.
2. Reasonable alternatives to the proposed activity (discussed in section M.8).
3. Mitigation measures to minimize any significant adverse environmental impacts of the proposed activity (discussed in section M.5).

Additionally, the CEQA⁷ and CEQA Guidelines⁸ require the following components, some of which are repetitive from the list above:

1. An analysis of the reasonably foreseeable environmental impacts of the methods of compliance. These methods may be employed to comply with the TMDL Basin Plan amendment. Reasonably foreseeable methods of compliance are described in section M.3. Sections M.4 and M.5 identify the environmental impacts associated with the methods of compliance.
2. An analysis of the reasonably foreseeable feasible mitigation measures relating to those impacts. This discussion is also in section M.5.
3. An analysis of reasonably foreseeable alternative means of compliance with the rule or regulation, which would avoid or eliminate the identified impacts. This discussion is in section M.5.1.

Additionally, the CEQA Guidelines require the environmental analysis take into account a reasonable range of:⁹

⁵ California Code of Regulations Title 23 section 3777

⁶ California Code of Regulations Title 23 section 3777

⁷ Public Resources Code section 21159 (a)

⁸ California Code of Regulations Title 14 section 15187(c)

1. Environmental factors (section M.5)
2. Economic factors (section M.7)
3. Technical factors (section M.6)
4. Population (section M.6)
5. Geographic areas (section M.6)
6. Specific sites (section M.6)

A “reasonable range” does not require an examination of every site, but a reasonably representative sample of them. The statute specifically states that the agency shall not conduct a “project level analysis.”¹⁰ Rather, a project level analysis must be performed by the dischargers to be eligible for a conditional waiver.¹¹ Notably, the San Diego Water Board is prohibited from specifying the manner of compliance with its regulations,¹² and accordingly, the actual environmental impacts will necessarily depend upon the compliance strategy selected by the dischargers. In preparing this environmental analysis, the San Diego Water Board has considered the pertinent requirements of state law,¹³ and intends this analysis to serve as a tier 1 environmental review.

Any potential environmental impacts associated with the TMDL depend upon the specific compliance projects selected by the dischargers, most of whom are public agencies subject to their own CEQA obligations. If not properly implemented or mitigated at the project level, there could be adverse environmental impacts from implementing these TMDLs.

The substitute CEQA documents identify broad mitigation approaches that could be considered at the project level. Consistent with the CEQA, the substitute documents do not engage in speculation or conjecture, but rather consider the reasonably foreseeable environmental impacts of the reasonably foreseeable methods of compliance, the reasonably foreseeable mitigation measures, and the reasonably foreseeable alternative means of compliance, which would avoid, eliminate, or reduce the identified impacts.

M.2 Description of the Proposed Activity

The Basin Plan designates beneficial uses of water bodies, establishes water quality objectives for the protection of these beneficial uses, and outlines a plan of implementation for maintaining and enhancing water quality. The proposed amendment would incorporate into the Basin Plan TMDLs for indicator bacteria at Baby Beach and Shelter Island Shoreline Park.

⁹ California Code of Regulations Title 14 section 15187(d), Public Resources Code section 21159 (c)

¹⁰ Public Resources Code section 21159(d)

¹¹ Public Resources Code section 21159.2

¹² Water Code section 13360

¹³ Public Resources Code section 21159 and 14 CCR section 15187

The San Diego Water Board's goal in adopting the TMDL is to eliminate the water quality problems caused by bacteria at the impaired shoreline segments of Baby Beach and Shelter Island Shoreline Park. Although the indicator bacteria water quality objectives (WQOs) for are written in terms of density of indicator bacteria colonies (most probable number of colonies per milliliter of water), the actual risk to human health is caused by the presence of disease-causing pathogens. When the risk to human health from pathogens in the water is so great that beaches are posted with health advisories or closure signs the quality and beneficial use of the water are impaired. The adoption of a TMDL is not discretionary; rather, it is compelled by section 303(d) of the federal Clean Water Act.

The TMDLs for indicator bacteria, and their derivation are discussed in the Technical Report, section 8. For point sources, the TMDLs will be implemented primarily through waste discharge requirements (WDRs) for urban runoff that implement federal National Pollutant Discharge Elimination System (NPDES) regulations. The primary dischargers are municipalities located in the watersheds. Dischargers will receive wasteload allocations (WLAs) that must be met over a phased compliance schedule that should result in attainment of water quality standards.

M.2.1 Surrounding Land Uses and Setting

The San Diego Region forms the southwest corner of California and occupies approximately 3,900 square miles. The western boundary of the Region consists of the Pacific Ocean coastline. The northern boundary of the Region is formed by the hydrologic divide starting near Laguna Beach and extending inland through El Toro and easterly along the ridge of the Elsinore Mountains into the Cleveland National Forest. The eastern boundary of the Region is formed by the Laguna Mountains and other lesser known mountains located in the Cleveland National Forest. The southern boundary of the Region is formed by the United States-Mexico international border.

The San Diego Region encompasses most of San Diego County, parts of southwestern Riverside County, and southwestern Orange County. The Region is divided into a coastal plain area, a central mountain-valley area, and an eastern mountain-valley area. It consists of eleven hydrologic units that ultimately drain to the Pacific Ocean. The climate in the Region is generally mild with annual temperatures averaging around 65°F near the coastal areas. Average annual rainfall ranges from 9 to 11 inches along the coast to more than 30 inches in the eastern mountains. There are two distinct seasons in the Region. Summer dry weather occurs from late April to mid-October. During this period almost no rain falls. The winter season (mid-October through early April) consists of generally dry weather interspersed by occasional rain storms. Eighty-five to ninety percent of the annual rainfall occurs during the winter season.

The land use of the San Diego Region is highly variable. However, the coastline areas are highly concentrated with urban and residential land uses. Most of the watershed areas addressed in this project are occupied by recreational and open space land uses and low-density and high-density residential land uses. Other major land uses are

commercial/institutional and industrial/transportation. More information is provided in section 2 of the Technical Report.

M.3 Analysis of Reasonably Foreseeable Methods of Compliance

This section identifies a range of reasonably foreseeable method(s) of compliance with the Basin Plan amendment. Bacteria generation is linked to different types of land uses, and for these watersheds, bacteria are transported to receiving waters primarily via urban runoff. Therefore, the most significant controllable source of bacteria to receiving waters is urban runoff discharges from MS4s during wet and dry weather. In wet weather, the amount of runoff and associated bacteria densities are highly dependent on land use and associated management practices (e.g., pet waste in residential areas). In dry weather, the amount of runoff and associated bacteria densities result from various land use practices that cause water to enter storm drains, such as lawn irrigation runoff and car washing. Bacteria loads from natural sources are uncontrollable and were not included in the watershed runoff, but included as part of the load existing in the receiving waters of the impaired shoreline segments.

The most reasonably foreseeable methods of compliance with the WLAs of these TMDLs are for dischargers (i.e., owner of MS4) to implement structural and non-structural best management practices (BMPs). Typical BMPs that may be selected by dischargers to comply with WLAs are divided into non-structural and structural controls, and are described below.

Non-structural Controls

Non-structural controls typically are aimed at controlling sources of a pollutant and generally do not involve new construction. Non-structural controls are expected to be the first methods to be utilized by the dischargers. No potentially significant impacts on the environment were identified for these controls.

Education and Outreach: Conduct education and outreach to residents to minimize the potential for contamination of stormwater runoff by cleaning up after their pets, picking up litter, minimizing runoff from agriculture, livestock, and horse ranch facilities, and controlling excessive irrigation. Bacterial source-tracking studies in a watershed in the Seattle, Washington area found that nearly 20 percent of the bacteria isolates that could be matched with host animals were matched with dogs.¹⁴

Road and Street Maintenance: Increase frequency of street sweeping to maintain clean sidewalks, streets, and gutters. Street sweeping can reduce non-point source pollution by 5 to 30 percent when a conventional mechanical broom and vacuum-assisted wet sweeper is used.¹⁵ The U.S. Environmental Protection Agency (USEPA) reports that the new vacuum assisted dry sweepers can achieve 50 to 88 percent overall reductions in the annual sediment loading for a residential street, depending on

¹⁴ USEPA, 1999, National Menu of Best Management Practices for Stormwater-Phase II, <http://cfpub.epa.gov/npdes/stormwater/menuofbmps>

¹⁵ *ibid*

sweeping frequency. A reduction in sediment load may lead to a reduction in bacteria being carried to the MS4, and ultimately to the impaired shorelines.

Storm Drain System Cleaning: Storm drain systems should be cleaned regularly since flows in the drains are rarely high enough to flush the drains. Cleaning of the storm drain systems will reduce the levels of bacteria as well as reduction of other pollutants, trash, and debris both in the storm drain system and in receiving waters.

BMP Inspection and Maintenance: Conduct regular inspections of treatment control BMPs to ensure their adequacy of design and proper function. Routine inspection and maintenance is an efficient way to prevent potential nuisance situations, such as odors, mosquitoes, weeds, etc., and can reduce the need for repair maintenance and the chance of polluting storm water runoff by finding and correcting problems before the next storm event.¹⁶

Enforcement of Local Ordinances: Develop and/or enforce municipal ordinances prohibiting the discard of litter, pet cleanup negligence, or lawn over-watering. Enforcement of such ordinances will decrease the likelihood of bacteria from controllable sources reaching storm drains.

Structural Controls

Structural controls may be utilized to divert, store, and/or treat stormwater, or infiltrate stormwater into the ground. Structural controls can involve construction and operation activities that create potentially significant environmental impacts.

Buffer Strips and Vegetated Swales: Construct and/or maintain vegetative buffer strips along roadsides and in medians to slow surface runoff velocity, filter pollutants, and increase stormwater infiltration. Replace curbs with vegetated swales to allow highway and road runoff to percolate into the ground.

Bioretention: Construct and maintain bioretention BMPs to provide on-site removal of pollutants from stormwater runoff through landscaping features.

Infiltration Trenches: Construct and maintain infiltration trenches designed to capture and naturally filter stormwater runoff.

Sand Filters: Install and maintain sand filters, which are effective for pollutant removal from stormwater. Sand filters may be a good option in densely developed urban areas with little pervious surface since the filters occupy minimal space.

Diversion/Treatment Systems: Install diversion and containment systems to capture non-stormwater runoff. During low flow conditions, runoff may be diverted to an on-site treatment system and released back to the MS4/receiving water, or it may be diverted to wastewater collection plants for treatment.

¹⁶ ibid

M.4 Environmental Checklist

POTENTIAL IMPACT	POTENTIALLY SIGNIFICANT	LESS THAN SIGNIFICANT WITH MITIGATION	LESS THAN SIGNIFICANT	NO IMPACT
1. Earth. Will the proposal result in:				
a. Unstable earth conditions or in changes in geologic substructures?	<input type="checkbox"/>	<input checked="" type="checkbox"/>	<input type="checkbox"/>	<input type="checkbox"/>
b. Disruptions, displacements, compaction or overcoming of the soil?	<input type="checkbox"/>	<input type="checkbox"/>	<input checked="" type="checkbox"/>	<input type="checkbox"/>
c. Change in topography or ground surface relief features?	<input type="checkbox"/>	<input checked="" type="checkbox"/>	<input type="checkbox"/>	<input type="checkbox"/>
d. The destruction, covering or modification of any unique geologic or physical features?	<input type="checkbox"/>	<input checked="" type="checkbox"/>	<input type="checkbox"/>	<input type="checkbox"/>
e. Any increase in wind or water erosion of soils either on or off the site?	<input type="checkbox"/>	<input type="checkbox"/>	<input checked="" type="checkbox"/>	<input type="checkbox"/>
f. Changes in deposition or erosion of beach sands, or changes in siltation, deposition or erosion which may modify the channel of a river or stream or the bed of the ocean or any bay, inlet or lake?	<input type="checkbox"/>	<input type="checkbox"/>	<input checked="" type="checkbox"/>	<input type="checkbox"/>
g. Exposure of people or property to geologic hazards, such as earthquakes, landslides, mudslides, ground failure, or similar hazards?	<input type="checkbox"/>	<input checked="" type="checkbox"/>	<input type="checkbox"/>	<input type="checkbox"/>
2. Air. Will the proposal result in:				
a. Substantial air emissions or deterioration of ambient air quality?	<input type="checkbox"/>	<input checked="" type="checkbox"/>	<input type="checkbox"/>	<input type="checkbox"/>
b. The creation of objectionable odors?	<input type="checkbox"/>	<input checked="" type="checkbox"/>	<input type="checkbox"/>	<input type="checkbox"/>
c. Alteration of air movement, moisture or temperature, or any change in climate, either locally or regionally?	<input type="checkbox"/>	<input type="checkbox"/>	<input type="checkbox"/>	<input checked="" type="checkbox"/>
3. Water. Will the proposal result in:				
a. Changes in currents, or the course of direction or water movements, in either marine or fresh waters?	<input type="checkbox"/>	<input type="checkbox"/>	<input checked="" type="checkbox"/>	<input type="checkbox"/>
b. Changes in absorption rates, drainage patterns, or the rate and amount of surface water runoff?	<input type="checkbox"/>	<input type="checkbox"/>	<input checked="" type="checkbox"/>	<input type="checkbox"/>
c. Alterations to the course of flow of flood waters?	<input type="checkbox"/>	<input checked="" type="checkbox"/>	<input type="checkbox"/>	<input type="checkbox"/>

POTENTIAL IMPACT	POTENTIAL SIGNIFICANT IMPACT	LESS THAN SIGNIFICANT IMPACT WITH MITIGATION	LESS THAN SIGNIFICANT IMPACT	NO IMPACT
3. Water. Will the proposal result in (Cont'd):				
d. Change in the amount of surface water in any water body?	<input type="checkbox"/>	<input type="checkbox"/>	<input checked="" type="checkbox"/>	<input type="checkbox"/>
e. Discharge into surface waters, or in any alteration of surface water quality, including but not limited to temperature, dissolved oxygen, or turbidity?	<input type="checkbox"/>	<input checked="" type="checkbox"/>	<input type="checkbox"/>	<input type="checkbox"/>
f. Alteration of the direction or rate of flow of groundwaters?	<input type="checkbox"/>	<input checked="" type="checkbox"/>	<input type="checkbox"/>	<input type="checkbox"/>
g. Change in the quantity or quality of groundwaters, either through direct additions or withdrawals, or through interception of an aquifer by cuts or excavations?	<input type="checkbox"/>	<input checked="" type="checkbox"/>	<input type="checkbox"/>	<input type="checkbox"/>
h. Substantial reduction in the amount of water otherwise available for public water supplies?	<input type="checkbox"/>	<input type="checkbox"/>	<input type="checkbox"/>	<input checked="" type="checkbox"/>
i. Exposure of people or property to water related hazards such as flooding or tidal waves?	<input type="checkbox"/>	<input checked="" type="checkbox"/>	<input type="checkbox"/>	<input type="checkbox"/>
4. Plant Life. Will the proposal result in:				
a. Change in the diversity of species, or number of any species of plants (including trees, shrubs, grass, crops, microflora and aquatic plants)?	<input type="checkbox"/>	<input type="checkbox"/>	<input checked="" type="checkbox"/>	<input type="checkbox"/>
b. Reduction of the numbers of any unique, rare or endangered species of plants?	<input type="checkbox"/>	<input checked="" type="checkbox"/>	<input type="checkbox"/>	<input type="checkbox"/>
c. Introduction of new species of plants into an area, or in a barrier to the normal replenishment of existing species?	<input type="checkbox"/>	<input checked="" type="checkbox"/>	<input type="checkbox"/>	<input type="checkbox"/>
d. Reduction in acreage of any agricultural crop?	<input type="checkbox"/>	<input type="checkbox"/>	<input type="checkbox"/>	<input checked="" type="checkbox"/>
5. Animal Life. Will the proposal result in:				
a. Change in the diversity of species, or numbers of any species of animals (birds, land animals including reptiles, fish and shellfish, benthic organisms, insects or microfauna)?	<input type="checkbox"/>	<input type="checkbox"/>	<input checked="" type="checkbox"/>	<input type="checkbox"/>

POTENTIAL IMPACT	POTENTIAL SIGNIFICANT IMPACT	LESS THAN SIGNIFICANT IMPACT WITH MITIGATION	LESS THAN SIGNIFICANT IMPACT	NO IMPACT
5. Animal Life. Will the proposal result in (Cont'd):				
b.Reduction of the numbers of any unique, rare or endangered species of animals?	<input type="checkbox"/>	<input checked="" type="checkbox"/>	<input type="checkbox"/>	<input type="checkbox"/>
c.Introduction of new species of animals into an area, or result in a barrier to the migration or movement of animals?	<input type="checkbox"/>	<input checked="" type="checkbox"/>	<input type="checkbox"/>	<input type="checkbox"/>
d.Deterioration to existing fish or wildlife habitat?	<input type="checkbox"/>	<input checked="" type="checkbox"/>	<input type="checkbox"/>	<input type="checkbox"/>
6. Noise. Will the proposal result in:				
a.Increases in existing noise levels?	<input type="checkbox"/>	<input checked="" type="checkbox"/>	<input type="checkbox"/>	<input type="checkbox"/>
b.Exposure of people to severe noise levels?	<input type="checkbox"/>	<input type="checkbox"/>	<input checked="" type="checkbox"/>	<input type="checkbox"/>
7. Light and Glare. Will the proposal:				
a.Produce new light or glare?	<input type="checkbox"/>	<input checked="" type="checkbox"/>	<input type="checkbox"/>	<input type="checkbox"/>
8. Land Use. Will the proposal result in:				
a.Substantial alteration of the present or planned land use of an area?	<input type="checkbox"/>	<input type="checkbox"/>	<input checked="" type="checkbox"/>	<input type="checkbox"/>
9. Natural Resources. Will the proposal result in:				
a.Increase in the rate of use of any natural resources?	<input type="checkbox"/>	<input type="checkbox"/>	<input type="checkbox"/>	<input checked="" type="checkbox"/>
b.Substantial depletion of any nonrenewable natural resource?	<input type="checkbox"/>	<input type="checkbox"/>	<input type="checkbox"/>	<input checked="" type="checkbox"/>
10. Risk of Upset. Will the proposal involve:				
a.A risk of an explosion or the release of hazardous substances (including, but not limited to: oil, pesticides, chemicals or radiation) in the event of an accident or upset conditions?	<input type="checkbox"/>	<input type="checkbox"/>	<input checked="" type="checkbox"/>	<input type="checkbox"/>
11. Population. Will the proposal:				
a.Alter the location, distribution, density, or growth rate of the human population of an area?	<input type="checkbox"/>	<input type="checkbox"/>	<input checked="" type="checkbox"/>	<input type="checkbox"/>
12. Housing. Will the proposal:				
a.Affect existing housing, or create a demand for additional housing?	<input type="checkbox"/>	<input type="checkbox"/>	<input checked="" type="checkbox"/>	<input type="checkbox"/>

POTENTIAL IMPACT	POTENTIAL SIGNIFICANT IMPACT	LESS THAN SIGNIFICANT IMPACT WITH MITIGATION	LESS THAN SIGNIFICANT IMPACT	NO IMPACT
13. Transportation/Circulation. Will the proposal result in:				
a.Generation of substantial additional vehicular movement?	<input type="checkbox"/>	<input type="checkbox"/>	<input checked="" type="checkbox"/>	<input type="checkbox"/>
b.Effects on existing parking facilities, or demand for new parking?	<input type="checkbox"/>	<input checked="" type="checkbox"/>	<input type="checkbox"/>	<input type="checkbox"/>
c.Substantial impact upon existing transportation systems?	<input type="checkbox"/>	<input type="checkbox"/>	<input checked="" type="checkbox"/>	<input type="checkbox"/>
d.Alterations to present patterns of circulation or movement of people and/or goods?	<input type="checkbox"/>	<input type="checkbox"/>	<input checked="" type="checkbox"/>	<input type="checkbox"/>
e.Alterations to waterborne, rail or air traffic?	<input type="checkbox"/>	<input type="checkbox"/>	<input type="checkbox"/>	<input checked="" type="checkbox"/>
f. Increase in traffic hazards to motor vehicles, bicyclists or pedestrians?	<input type="checkbox"/>	<input type="checkbox"/>	<input checked="" type="checkbox"/>	<input type="checkbox"/>
14. Public Service. Will the proposal have an effect upon, or result in a need for new or altered governmental services in an of the following areas:				
a.Fire protection?	<input type="checkbox"/>	<input type="checkbox"/>	<input checked="" type="checkbox"/>	<input type="checkbox"/>
b.Police protection?	<input type="checkbox"/>	<input type="checkbox"/>	<input checked="" type="checkbox"/>	<input type="checkbox"/>
c.Schools?	<input type="checkbox"/>	<input type="checkbox"/>	<input type="checkbox"/>	<input checked="" type="checkbox"/>
d.Parks or other recreational facilities?	<input type="checkbox"/>	<input type="checkbox"/>	<input checked="" type="checkbox"/>	<input type="checkbox"/>
e.Maintenance of public facilities, including roads?	<input type="checkbox"/>	<input checked="" type="checkbox"/>	<input type="checkbox"/>	<input type="checkbox"/>
f. Other governmental services?	<input type="checkbox"/>	<input checked="" type="checkbox"/>	<input type="checkbox"/>	<input type="checkbox"/>
15. Energy. Will the proposal result in:				
a.Use of substantial amounts of fuel or energy?	<input type="checkbox"/>	<input type="checkbox"/>	<input type="checkbox"/>	<input checked="" type="checkbox"/>
b.Substantial increase in demand upon existing sources of energy, or require the development of new sources of energy?	<input type="checkbox"/>	<input type="checkbox"/>	<input type="checkbox"/>	<input checked="" type="checkbox"/>
16. Utilities and Service Systems. Will the proposal result in a need for new systems, or substantial alterations to the following utilities:				
a.Power or natural gas?	<input type="checkbox"/>	<input type="checkbox"/>	<input checked="" type="checkbox"/>	<input type="checkbox"/>
b.Communications systems?	<input type="checkbox"/>	<input type="checkbox"/>	<input type="checkbox"/>	<input checked="" type="checkbox"/>
c.Water?	<input type="checkbox"/>	<input type="checkbox"/>	<input type="checkbox"/>	<input checked="" type="checkbox"/>
d.Sewer or septic tanks?	<input type="checkbox"/>	<input type="checkbox"/>	<input checked="" type="checkbox"/>	<input type="checkbox"/>
e.Storm water drainage?	<input type="checkbox"/>	<input type="checkbox"/>	<input checked="" type="checkbox"/>	<input type="checkbox"/>

POTENTIAL IMPACT	POTENTIAL SIGNIFICANT IMPACT	LESS THAN SIGNIFICANT IMPACT WITH MITIGATION	LESS THAN SIGNIFICANT IMPACT	NO IMPACT
16. Utilities and Service Systems. Will the proposal result in a need for new systems, or substantial alterations to the following utilities (Cont'd):				
f. Solid waste and disposal?	<input type="checkbox"/>	<input type="checkbox"/>	<input checked="" type="checkbox"/>	<input type="checkbox"/>
17. Human Health. Will the proposal result in:				
a. Creation of any health hazard or potential health hazard (excluding mental health)?	<input type="checkbox"/>	<input checked="" type="checkbox"/>	<input type="checkbox"/>	<input type="checkbox"/>
18. Aesthetics. Will the proposal result in:				
a. The obstruction of any scenic vista or view open to the public?	<input type="checkbox"/>	<input checked="" type="checkbox"/>	<input type="checkbox"/>	<input type="checkbox"/>
b. The creation of an aesthetically offensive site open to public view?	<input type="checkbox"/>	<input checked="" type="checkbox"/>	<input type="checkbox"/>	<input type="checkbox"/>
19. Recreation. Will the proposal result in:				
a. Impact upon the quality or quantity of existing recreational opportunities?	<input type="checkbox"/>	<input checked="" type="checkbox"/>	<input type="checkbox"/>	<input type="checkbox"/>
20. Archeological/Historical. Will the proposal:				
a. Result in the alteration of a significant archeological or historical site structure, object or building?	<input type="checkbox"/>	<input checked="" type="checkbox"/>	<input type="checkbox"/>	<input type="checkbox"/>
21. Mandatory Findings of Significance				
Potential to degrade: Does the project have the potential to degrade the quality of the environment, substantially reduce the habitat of a fish or wildlife species, cause a fish or wildlife population to drop below self-sustaining levels, threaten to eliminate a plant or animal community, reduce the number or restrict the range of a rare or endangered plant or animal or eliminate important examples of the major periods of California history or prehistory?	<input type="checkbox"/>	<input checked="" type="checkbox"/>	<input type="checkbox"/>	<input type="checkbox"/>

POTENTIAL IMPACT	POTENTIAL SIGNIFICANT IMPACT	LESS THAN SIGNIFICANT IMPACT WITH MITIGATION	LESS THAN SIGNIFICANT IMPACT	NO IMPACT
21. Mandatory Findings of Significance				
Short-term: Does the project have the potential to achieve short-term, to the disadvantage of long-term, environmental goals? (A short-term impact on the environment is one which occurs in a relatively brief, definitive period of time, while long-term impacts will endure well into the future.)	<input type="checkbox"/>	<input type="checkbox"/>	<input type="checkbox"/>	<input checked="" type="checkbox"/>
Cumulative: Does the project have impacts which are individually limited, but cumulatively considerable? (A project may impact on two or more separate resources where the impact on each resource is relatively small, but where the effect of the total of those impacts on the environment is significant.)	<input type="checkbox"/>	<input checked="" type="checkbox"/>	<input type="checkbox"/>	<input type="checkbox"/>
Substantial adverse: Does the project have environmental effects which will cause substantial adverse effects on human beings, either directly or indirectly?	<input type="checkbox"/>	<input checked="" type="checkbox"/>	<input type="checkbox"/>	<input type="checkbox"/>

M.5 Discussion of Possible Environmental Impacts of Reasonably Foreseeable Compliance Methods and Mitigation Measures

As stated previously, the environmental analysis must include an analysis of the reasonably foreseeable environmental impacts of the methods of compliance and the reasonably foreseeable feasible mitigation measures relating to those impacts. This section, consisting of answers to the questions in the checklist, discusses compliance methods and mitigation measures as they pertain to the checklist.

In formulating these answers, the impacts of implementing the non-structural and structural controls listed in section M.3 were evaluated. At this time, the exact type, size, and location of non-structural and/or structural controls that might be implemented to comply with the TMDLs is unknown. This analysis considers a range of non-structural and/or structural controls that might be used, but is by no means an exhaustive list of available controls. When non-structural and/or structural controls are selected for implementation, a project-level and site-specific CEQA analysis must be performed by the responsible agency.

Potential reasonably foreseeable impacts were evaluated with respect to earth, air, water, plant life, animal life, noise, light, land use, natural resources, risk of upset, population, housing, transportation, public services, energy, utilities and services systems, human health, aesthetics, recreation, and archeological/historical concerns. Additionally, mandatory findings of significance regarding short-term, long-term, cumulative and substantial impacts were evaluated. The evaluation considered whether the implementation and/or construction or implementation of the non-structural and/or structural controls would cause a substantial, adverse change in any of the physical conditions within the areas affected by the control. In addition, the evaluation considered environmental effects in proportion to their severity and probability of occurrence. Based on this review, we concluded that the potentially significant impacts can be mitigated to less than significant levels.

A significant effect on the environment is defined as “a substantial, or potentially substantial, adverse change in any of the physical conditions within the area affected by the project, including land, air, water, minerals, flora, fauna, ambient noise, and objects of historic or aesthetic significance. A social or economic change by itself shall not be considered a significant effect on the environment. A social or economic change related to a physical change may be considered in determining whether the physical change is significant.”¹⁷

A significant effect on the environment is defined in statute as “a substantial, or potentially substantial, adverse change in the environment”¹⁸ where “Environment” is defined as “the physical conditions which exist within the area which will be affected by a proposed project, including air, water, minerals, flora, fauna, noise, objects of historic or aesthetic significance.”¹⁹

In this analysis, the level of significance was based on baseline conditions (i.e., current conditions). Short-term impacts associated with construction of structural controls were considered less than significant because the impacts due to construction activities are temporary and similar to typical capital improvement projects and maintenance activities currently performed by municipalities or dischargers. The long-term impacts associated with structural controls were considered potentially significant, but only if they could have an adverse, or potentially adverse, impact on the environment even with mitigation.

Social or economic changes related to a physical change of the environment were also considered in determining whether there would be a significant effect on the environment. However, adverse social and economic impacts alone are not significant effects on the environment.

¹⁷ California Code of Regulations Title 14 section 15382

¹⁸ Public Resources Code section 21068

¹⁹ Public Resources Code section 21060.5

1. Earth. a. Will the proposal result in unstable earth conditions or in changes in geologic substructure?

Answer: Less than significant with mitigation

Discussion: Reasonably foreseeable non-structural controls would not create unstable earth conditions or changes in geologic substructure because none of these controls include earth moving activities.

For structural controls, infiltration of surface runoff could potentially result in unstable earth conditions if loose or compressible soils are present, or if such structural controls were to be located where infiltrated runoff flowing as groundwater could destabilize existing slopes. These impacts can be avoided by siting infiltration type structural controls away from areas with loose or compressible soils, and away from slopes that could become destabilized by an increase in groundwater flow. Infiltration type structural controls can also be built on a small enough scale to avoid these types of impacts.

1. Earth. b. Will the proposal result in disruptions, displacements, compaction or overcoming of the soil?

Answer: Less than significant

Discussion: Reasonably foreseeable non-structural controls would not result in disruptions, displacements, compaction or overcoming of the soil because none of these controls include earth moving activities.

Depending on the structural controls selected, the proposal may result in minor surface soil excavation or grading during construction of structural controls resulting in increased disturbance of the soil. However, the subwatersheds draining to the shoreline segments addressed in this project are located primarily within urban areas which have already undergone soil compaction and hardscaping. Standard construction techniques, including but not limited to, shoring, piling and soil stabilization can mitigate any potential short-term impacts. In addition, structural controls can be designed and sited in areas where the risk of new soil disruption is minimal. Soil disruptions, displacements, compaction, or overcoming during construction activities would be similar to typical temporary capital improvement construction and maintenance activities currently performed by municipalities, and no long-term impacts to the soil are expected.

1. Earth c. Will the proposal result in change in topography or ground surface relief features?

Answer: Less than significant with mitigation

Discussion: Reasonably foreseeable non-structural controls would not result in change in topography or ground relief features because none of these controls include earth moving activities.

Implementation and construction of structural controls could result in some change in topography or ground surface relief features; however, most of the potential structural controls are so small that changes to topography will not be noticeable. If the dischargers construct structural controls on a scale large enough to change topography or ground relief features, then potential adverse impacts could be avoided or mitigated through siting such topographic alterations in geologically stable areas, or by installing or designing structural controls with the least amount of impact to the topography.

1. Earth d. Will the proposal result in the destruction, covering or modification of any unique geologic or physical features?

Answer: Less than significant with mitigation

Discussion: Reasonably foreseeable non-structural controls would not result in the destruction, covering or modification of any unique geologic or physical features because none of these controls include earth moving activities.

Constructing structural controls in areas where doing so would result in the destruction, covering or modification of a unique geologic or physical features is not a reasonably foreseeable alternative that dischargers would choose. Furthermore, no impact is expected because foreseeable methods of compliance, including implementation of structural controls to control bacteria, would not be of the size or scale to result in the destruction, covering or modification of any unique geologic or physical features. In the unlikely event that dischargers might install facilities on a scale that could result in the destruction, covering or modification of any unique geologic or physical features, potential impacts could be mitigated by mapping these features to avoid siting facilities in these areas.

1. Earth. e. Will the proposal result in any increase in wind or water erosion of soils, either on or off the site?

Answer: Less than significant

Discussion: Reasonably foreseeable non-structural controls would not result in increase in wind or water erosion of soils because none of the non-structural controls would result in increased stormwater discharge, or in exposing soils to erosion by wind and water.

Depending on the structural controls selected, the proposal may result in minor soil excavation during construction of structural controls. However, construction related erosion impacts will cease with the cessation of construction. Wind or water erosion of soils may occur as a potential short-term impact. On-site soil erosion during construction activities will be similar to typical temporary capital improvement projects and maintenance activities currently performed by the municipalities in urban areas. Typical established construction BMPs should be used during installation of structural controls to minimize offsite sediment runoff or deposition. Construction sites are required to retain sediment on site, both under general construction storm water WDRs and through the construction program of the applicable MS4 WDRs; both of which are already designed to minimize or eliminate erosion impacts on receiving water.

1. Earth. f. Will the proposal result in changes in deposition or erosion of beach sands, or changes in siltation, deposition or erosion which may modify the channel of a river or stream or the bed of the ocean or any bay, inlet or lake?

Answer: Less than significant

Discussion: Reasonably foreseeable non-structural controls would not result in changes in deposition or erosion of beach sands, or changes in siltation, deposition or erosion which may modify the channel of a river or stream or the bed of the ocean or any bay, inlet or lake. However, non-structural controls, such as increased street sweeping, may reduce the amount of silt and sediment that is transported and deposited to the impaired shorelines.

Deposition of significant volumes of sediment to beaches occurs mostly during wet weather flows. Therefore, structural wet weather diversion and treatment controls that remove the stream's sediment load could impact deposition of sand on beaches. End of stream detention basins that capture sediment, resulting in possible changes in deposition or erosion, can be mitigated through sand replacement and importation.

1. Earth. g. Will the proposal result in exposure of people or property to geologic hazards, such as earthquakes, landslides, mudslides, ground failure, or similar hazards?

Answer: Less than significant with mitigation

Discussion: Reasonably foreseeable non-structural controls would not result in exposure of people or property to geologic hazards because none of these controls would result in earth moving activities.

For structural controls, infiltration of collected stormwater could possibly result in ground failure if loose or compressible soils are present, or if such controls were to be located where introduced groundwater movements could destabilize existing slopes. This may result in landslides, mudslides, ground failure, or similar hazards. However, complying with these TMDLs using structural controls in areas where doing so, or of a size or scale that would result in exposure of people or property to such geologic hazards is unlikely when other alternatives exist. In the unlikely event that dischargers might install facilities on a scale that could result in exposure of people or property to geologic hazards, a geotechnical investigation should be prepared at the project level to ensure that structural controls are not employed in areas subject to potential geologic hazards.

2. Air. a. Will the proposal result in substantial air emissions or deterioration of ambient air quality?

Answer: Less than significant with mitigation

Discussion: Short term increases in traffic during the construction and installation of structural controls and long-term increases in traffic caused by non-structural controls and maintenance of structural controls are potential sources of air emissions that may adversely affect ambient air quality. Several mitigation measures are available to reduce potential impacts to ambient air quality due to increased traffic during short-term construction and long-term maintenance activities. Mitigation measures could include, but are not limited to, the following: 1) use of construction, maintenance, and street sweeper vehicles with lower-emission engines, 2) use of soot reduction traps or diesel particulate filters, 3) use of emulsified diesel fuel, 4) use of vacuum-assisted street sweepers to eliminate potential re-suspension of sediments during sweeping activity, 5) the design of structural devices to minimize the frequency of maintenance trips, and/or 6) proper maintenance of vehicles so they operate cleanly and efficiently.

The generation of fugitive dust and particulate matter during construction or maintenance activities could also impact ambient air quality. An operations plan for the specific construction and/or maintenance activities could be completed to address the variety of available measures to limit the ambient air quality impacts. These could include vapor barriers and moisture control to reduce transfer of particulates and dust to air.

The emission of air pollutants during short-term construction activities associated with reasonably foreseeable methods of compliance would not likely change ambient air conditions, because long-term ambient air quality would not change after short-term construction activities are completed.

Ambient air quality may change as a result of increased traffic due to an increase in street sweeping and/or maintenance activities. However, the impact to ambient air quality can be reduced by using the mitigation measures described above for street sweepers and maintenance vehicles. The potential impact to ambient air quality can be further reduced if street sweeping and/or maintenance activities are scheduled to be performed at the same time as other maintenance activities performed by the municipalities, or at times when these activities have lower impact, such as periods of low traffic activity. In any case, the number of additional vehicles expected in the watersheds due to non-structural and structural controls is not expected to increase the level of pollutants in the air compared to current conditions, because various common managerial practices are available to mitigate the adverse effects. In fact, additional street sweeping could potentially reduce the amount of dust and particulates that may be available on the streets.

2. Air. b. Will the proposal result in creation of objectionable odors?

Answer: Less than significant with mitigation

Discussion: Non-structural controls could result in the creation of objectionable odors in urbanized areas caused by exhaust from street sweepers or maintenance vehicles. Objectionable odors due to engine exhaust would be temporary and dissipate once the vehicle has passed through the area. Objectionable odors from exhaust could be reduced if gasoline or propane engines were used instead of diesel engines. Additionally, street sweepers and maintenance vehicles could be scheduled to be performed at the same time as other maintenance activities performed by the municipalities, or at times when these activities have lower impact, such as periods when there are fewer people in the area.

Construction and installation of structural controls may result in objectionable odors in the short-term due to exhaust from construction equipment and vehicles, but no more so than during typical construction activities currently performed. Structural controls may be a source of objectionable odors if structural control designs allow for

water stagnation or collection of water with sulfur-containing compounds. Stormwater runoff is not likely to contain sulfur-containing compounds, but stagnant water could create objectionable odors.

Mitigation measures to eliminate odors caused by stagnation could include proper design to eliminate standing water, covers, aeration, filters, barriers, and/or odor suppressing chemical additives. Structural controls should be inspected regularly to ensure that treatment devices are not clogged, pooling water, or odorous. During maintenance, odorous sources should be uncovered for as short of a time period as possible. Structural controls should be designed to minimize stagnation of water and installed in such a way so as to increase the distance to sensitive receptors in the event of any stagnation.

2. Air. c. Will the proposal result in alteration of air movement, moisture or temperature, or any change in climate, either locally or regionally?

Answer: No impact

Discussion: Reasonably foreseeable non-structural and/or structural controls would not be of the size or scale to result in alteration of air movement, moisture or temperature, or any change in climate, either locally or regionally.

3. Water. a. Will the proposal result in changes in currents, or the course of direction or water movements, in either marine or fresh waters?

Answer: Less than significant

Discussion: Most non-structural controls will not cause changes in currents, or the course of direction or water movements, in either marine or fresh waters because most of these controls would not introduce any physical effects that could impact these characteristics. Reduction or elimination of dry weather flows caused by implementation of non-structural controls could have a physical impact due to a reduction in sediment and refuse discharge.

Structural controls may change the currents in the watersheds by diverting flow. Overland flow in these urbanized watersheds is directed primarily to storm drains. Overland flow may change depending on the structural controls installed such as infiltration trenches. If stormwater runoff flow is reduced, these changes would reduce the potential for erosion.

3. Water. b. Will the proposal result in changes in absorption rates, drainage patterns, or the rate and amount of surface water runoff?

Answer: Less than significant

Discussion: Non-structural controls would not result in changes in absorption rates, drainage patterns, or the rate and amount of surface water runoff because none of these controls would introduce any physical effects that could impact these characteristics.

Depending on the structural controls selected, absorption rates, drainage patterns, and surface water runoff may change. Grading and excavation during construction and installation of structural controls could result in alterations in absorption rates, drainage patterns, and surface water runoff. Several types of structural controls collect and/or inhibit surface runoff flow, which would likely alter drainage patterns, and also decrease the rate and amount of surface runoff. For example, structural controls such as buffer strips would change drainage patterns by increasing absorption rates, which would reduce the amount of surface runoff. If surface runoff is diverted to wastewater treatment facilities, thereby reducing the overall flow, the erosion and scour that would normally be caused by surface runoff would be reduced. The amount of flow within the stream channel may change; however, the channelized drainage pattern would remain essentially unchanged.

3. Water. c. Will the proposal result in alterations to the course of flow of flood waters?

Answer: Less than significant with mitigation

Discussion: Reasonably foreseeable non-structural controls are unlikely to result in alterations to the course of flow of flood waters because none of the controls would introduce any physical effects that could impact these characteristics.

The course of flow of flood waters may change depending on the structural controls selected. Structural controls, such as sand filters, could reduce a storm drain's ability to convey flood waters. This can be mitigated through proper design (including flood water bypass systems), sizing, and maintenance of these types of structural controls. Other structural controls, such as sewer diversions, detention basins or infiltration basins, could alter the volume of flood waters by diverting a portion of the flood waters, but these controls are unlikely to alter the course of flood waters.

3. Water. d. Will the proposal result in change in the amount of surface water in any water body?

Answer: Less than significant

Discussion: Implementation of non-structural controls could result in a reduction in the amount of dry weather surface water in the watersheds. Because the reduction of nuisance flows would return the watersheds to a more natural, predevelopment condition, this impact is considered less than significant.

Depending on the structural controls selected, surface runoff may be retained and/or diverted for groundwater infiltration and/or reused. Water that is retained or diverted would not flow into creek and stream channels or storm drains. Because the surface water runoff to the creeks would be reduced, the adverse effects of channel scour and erosion of the creeks would also be reduced.

3. Water. e. Will the proposal result in discharge to surface waters, or in any alteration of surface water quality, including but not limited to temperature, dissolved oxygen, or turbidity?

Answer: Less than significant with mitigation

Discussion: Non-structural and/or structural controls would not result in any additional discharge to surface waters. Depending on the structural controls selected, the current amount of surface runoff discharged to surface waters may actually be reduced if diverted for groundwater infiltration, reuse, or to wastewater treatment facilities.

During wet weather discharges, certain structural controls (including detention basins, infiltration basins, and sand filters) would reduce turbidity and increase dissolved oxygen, because these controls would remove sediment and bioavailable oxygen demanding substances from the surface water. However, reduced turbidity, and increased dissolved oxygen does not typically result in an adverse effect on the environment.

Onsite facilities may be employed for treatment of dry weather or storm flows that use oxidizing agents such as ozone for disinfection, which can result in decreased bacteria loads. If not used properly, use of these technologies can result in adverse alteration of surface water quality because of the production of disinfection by-products. For example, if a surface water has significant concentrations of bromide, reaction with ozone can cause the formation of brominated by-products that can cause both immediate and delayed toxicity to marine organisms even after relatively

short periods of ozonation.²⁰ Mitigation measures could include removal of bromide before contact with ozone occurs, or not using this treatment method where high concentrations of bromide are present.

A reduction of dry weather discharges (i.e., a cessation or reduction in nuisance flows) would result in a reduction of overall surface runoff flow during the dry season. This could result in a water temperature increase, and a decrease of dissolved oxygen in dry weather pools.

3. Water. f. Will the proposal result in alteration of the direction or rate of flow of groundwaters?

Answer: Less than significant with mitigation

Discussion: Non-structural controls would not result in alteration of the direction or rate of flow of groundwaters because none of the controls would introduce any physical effects that could impact these characteristics.

Over the long term, infiltration of stormwater runoff via infiltration type structural controls such as vegetative strips could significantly alter the direction or rate of flow of groundwater. This could result in unstable earth conditions if such controls were to be located where infiltrated stormwater flowing as groundwater could destabilize existing slopes. As discussed in the answer to question 1.a, these impacts can be avoided by siting infiltration type structural controls away from areas with loose or compressible soils, and away from slopes that could become destabilized by an increase in groundwater flow. Infiltration type structural controls can also be built on a small enough scale to avoid these types of impacts. In the unlikely event that dischargers might install facilities on a scale that could result in unstable earth conditions, potential impacts could be avoided through proper groundwater investigations, siting, design, and groundwater level monitoring to ensure that structural controls are not employed in areas where slopes could become destabilized.

²⁰ William Cooper et al. 2002. Final Report. *Ozone, seawater, and aquatic nonindigenous species: Testing a full-scale ozone ballast water treatment system on an American oil tanker.*

3. Water. g. Change in the quantity or quality of groundwaters, either through direct additions or withdrawals, or through interception of an aquifer by cuts or excavations?

Answer: Less than significant with mitigation

Discussion: Non-structural controls will not change the quantity or quality of groundwaters because none of these controls would introduce any physical effects that could impact these characteristics.

Infiltration type structural controls such as infiltration trenches may increase the quantity and degrade the quality of groundwaters. The increase in quantity is unlikely to have any adverse effects since, under pre-development conditions, infiltration rates of stormwater runoff to groundwater were most likely much higher than they are today due to the absence of hardscapes. However, as discussed in question 3.f above, increased infiltration of stormwater near steep slopes, such as canyon walls, could potentially destabilize these slopes by saturating the soils, making them more prone to sliding. Mitigation could include not siting large infiltration structural controls near canyon walls or other steep slopes.

In addition to bacteria, stormwater also contains dissolved pollutants such as nutrients, metals, pesticides, hydrocarbons, oil and grease. However, infiltration based structural controls are not expected to degrade groundwater with respect to these pollutants for the following reasons.

Ambient nitrogen and phosphorus concentrations in groundwater are likely higher than nutrient concentrations in stormwater due to decades of over application of fertilizers on domestic and commercial landscapes, and deep percolation of applied irrigation water. Nonetheless, if stormwater nutrient concentrations are higher than ambient concentrations in the groundwater, mitigation could include education and outreach to homes and business to better manage fertilizer use. Phytoremediation can also be used to remove nutrients from stormwater runoff.

Bacteria and metals in stormwater runoff are not expected to degrade groundwater quality since they tend to adsorb to clay and organic particles in the soil. Likewise, oil and grease would become bound up in the soil and remain nearer to the surface due to lower densities. Pesticides and hydrocarbons are not expected to degrade groundwater quality because natural bacteria in the soil and groundwater tend to break down pesticides.

3. Water. h. Will the proposal result in substantial reduction in the amount of water otherwise available for public water supplies?

Answer: No impact

Discussion: Reasonably foreseeable non-structural and/or structural controls will not reduce public water supplies because most of the public water supplies for the watersheds included in these TMDLs are imported from outside the region.

3. Water. i. Will the proposal result in exposure of people or property to water related hazards such as flooding or tidal waves?

Answer: Less than significant with mitigation

Discussion: Reasonably foreseeable non-structural controls would not result in exposure of people or property to water related hazards such as flooding or tidal waves because none of these controls would introduce any physical effects that could impact these characteristics.

Installation of structural controls that are not properly designed and constructed to allow for bypass of stormwater during storms that exceed design capacity can cause flooding. However, this potential impact can be mitigated through proper design and maintenance of structural controls. Any modifications to the watershed hydrology should be modeled and accounted for in the design of structural controls.

4. Plant Life. a. Will the proposal result in change in the diversity of species, or number of any species of plants (including trees, shrubs, grass, crops, microflora and aquatic plants)?

Answer: Less than significant

Discussion: Implementing non-structural controls will not directly result in change in the diversity of species, or number of any species of plants (including trees, shrubs, grass, crops, microflora and aquatic plants) because most of these controls would not introduce any physical effects that could impact these characteristics. However, the reduction or elimination of nuisance flows could result in a change in the diversity of species, or number of any species of plants, especially in the dry weather season. No adverse impacts are expected because the elimination of nuisance flows would return the dry weather flows to a more natural, pre-development condition. This in turn would facilitate the return of the plant

community to a more natural, pre-development condition and could impede the propagation of water-loving non-native and invasive plant species. Impeding the propagation of invasive species is not an adverse impact. Additionally, because these watersheds are located within urbanized areas, the diversity of species, or number of any species of plants is more dependent on anthropogenic activities rather than natural propagation.

The installation of structural controls such as vegetated swales or buffer strips could increase the diversity or number of plant species. During storm events, structural controls could also divert, reduce, and/or eliminate surface water runoff discharge, which may reduce the number and/or diversity of plant species dependent on such flows. However, surface runoff rates were most likely much lower than they are today due to the absence of hardscapes, and structural controls such as vegetated swales and buffer strips would likely restore surface runoff flows closer to more natural, pre-development conditions.

4. Plant life. b. Will the proposal result in reduction of the numbers of any unique, rare or endangered species of plants?

Answer: Less than significant with mitigation

Discussion: Implementing non-structural controls will not directly result in a reduction of the numbers of any unique, rare, or endangered species of plants because these controls will not affect the habitat of any unique, rare, or endangered species of plants.

Depending on the type of discharge and/or structural controls selected, direct or indirect impacts to special-status plant species may occur during and after the waste discharge and/or construction of structural controls. However, when the specific projects are developed and sites identified, a focused protocol plant survey and/or a search of the California Natural Diversity Database should be performed to confirm that any potentially sensitive or special status plant species in the site area are properly identified and protected as necessary. If sensitive plant species occur on the project site, mitigation is required in accordance with the Endangered Species Act. Mitigation measures should be developed in consultation with the California Department of Fish and Game (CDFG) and the United States Fish and Wildlife Service (USFWS). Therefore, responsible agencies should avoid installing structural controls that could result in reduction of the numbers of unique, rare or endangered species of plants, and instead opt for non-structural controls and/or identify and install structural controls in areas that will not reduce the numbers of such plants.

4. Plant life. c. Will the proposal result in introduction of new species of plants into an area, or in a barrier to the normal replenishment of existing species?

Answer: Less than significant with mitigation

Discussion: Implementing non-structural controls will not result in introduction of new species of plants into an area, or in a barrier to the normal replenishment of existing species because most of the controls would not introduce any physical effects that could impact these characteristics. However, the reduction or elimination of nuisance flows could result in the introduction of new species of plants into an area, or in a barrier to the normal replenishment of existing species especially in the dry weather season. However, no adverse impacts are expected as discussed in the answer to question 4.a.

For structural controls that may include the use of plants, such as vegetated swales or buffer strips, new species of plants may possibly be introduced into the area. However, in cases where plants or landscaping is incorporated into the specific project design, the possibility of disruption of resident native species could be avoided or minimized by using only plants native to the area. The use of exotic invasive species or other plants listed in the Exotic Pest Plant of Greatest Ecological Concern in California (1999, California Invasive Plant Council, as amended) should be prohibited

4. Plant life. d. Will the proposal result in reduction in acreage of any agricultural crop?

Answer: No impact

Discussion: Reasonably foreseeable non-structural and/or structural controls are not expected to result in a reduction in acreage of agricultural crops because the subwatersheds addressed in these TMDLs do not include agricultural land uses.

5. Animal Life. a. Will the proposal result in change in the diversity of species, or numbers of any species of animals (birds, land animals including reptiles, fish and shellfish, benthic organisms, insects or microfauna)?

Answer: Less than significant

Discussion: Implementing non-structural controls will not directly result in change in the diversity of species, or numbers of any species of animals (birds, land animals including reptiles, fish and shellfish, benthic organisms, insects or microfauna)

because the controls would not introduce any physical effects that could impact these characteristics. However, the reduction or elimination of nuisance flows could result in change in the diversity of species, or numbers of any species of animals, due to a reduction of dry weather flows that could eliminate habitats dependant on those flows. However, this would return dry weather flows in the watersheds to a more natural, pre-development condition as discussed in the answer to question 4.a. Animal species that thrive in the absence of nuisance flows should not be adversely impacted by habitat changes if the flows are eliminated. Impeding the propagation of invasive species is not an adverse impact.

The installation of structural controls such as vegetated swales or buffer strips could increase the diversity or number of animal species by providing habitat. Structural controls could also divert, or reduce storm water runoff discharge, which could decrease the number and/or diversity of animal species by eliminating habitat dependant on those flows. However, native communities of animals can thrive under lower streamflow conditions than what currently exist.

5. Animal Life. b. Will the proposal result in reduction of the numbers of any unique, rare or endangered species of animals?

Answer: Less than significant with mitigation

Discussion: Implementing non-structural controls will not result in a reduction of the numbers of unique, rare or endangered species of animals because these controls will not cause a reduction in habitat for unique, rare, or endangered animals.

Depending on the type of discharge and/or structural controls selected, direct or indirect impacts to special-status animal species may occur during and after construction. Special-status species may be present in these watersheds. If special status species are present during activities such as ground disturbance, construction, operation and maintenance activities associated with the potential projects, direct impacts to special status species could result including the following:

- Direct loss of a special status species
- Increased human disturbance in previously undisturbed habitats
- Mortality by construction or other human-related activity
- Impairing essential behavioral activities, such as breeding, feeding or shelter/refuge
- Destruction or abandonment of active nest(s)/den sites
- Direct loss of occupied habitat

In addition, potential indirect impacts may include but are not limited to, the following:

- Displacement of wildlife by construction activities
- Disturbance in essential behavioral activities due to an increase in ambient noise levels and/or artificial light from outdoor lighting around facilities

Mitigation measures, however, could be implemented to ensure that special status animals are not negatively impacted, nor their habitats diminished. For example, when the specific projects are developed and sites identified, a focus protocol animal survey and/or a search of the California Natural Diversity Database should be performed to confirm that any potentially special-status animal species in the site area are properly identified and protected as necessary.

If special-status animal species are potentially near the project site area, as required by the Endangered Species Act (ESA), two weeks prior to grading or the construction of facilities and per applicable USFWS and/or CDFG protocols, pre-construction surveys to determine the presence or absence of special-status species should be conducted. The surveys should extend an appropriate distance (buffer area) off site in accordance with USFWS and/or CDFG protocols to determine the presence or absence of any special-status species adjacent to the project site. If special-status species are present on the project site or within the buffer area, mitigation would be required under the ESA. To this extent, mitigation measures shall be developed with the USFWS and CDFG to reduce potential impacts.

5. Animal Life. c. Will the proposal result in introduction of new species of animals into an area, or in a barrier to the migration or movement of animals?

Answer: Less than significant mitigation

Discussion: Implementing non-structural controls will not result in introduction of new species of animals into an area, or in a barrier to the migration or movement of animals because the controls would not introduce any physical effects that could impact these characteristics. However, the reduction or elimination of nuisance flows could result in a barrier to the migration or movement of animals especially in the dry weather season by eliminating habitat dependant on those flows. However, this would cause dry weather flows to return to a more natural, pre-development condition, as discussed in the answer to question 4a. Animal species that thrived in the absence of nuisance flows should not be adversely impacted by habitat changes if the flows are eliminated. Impeding the propagation of invasive species is not an adverse impact.

Implementing structural controls would not foreseeably introduce new species. Construction of reasonably foreseeable structural controls likely would not restrict wildlife movement because the sizes of structural controls are generally too small to obstruct a corridor. For terrestrial animals, corridors would be maintained regardless of stream flow since reduced flows would not provide physical barriers for these

animals. In the event that any structural controls built, such as animal exclusions, that may impede some wildlife migration, fence gaps large enough to allow migrating wildlife to pass through could be included in the design.

5. Animal Life. d. Will the proposal result in deterioration to existing fish or wildlife habitat?

Answer: Less than significant with mitigation

Discussion: Implementing non-structural controls will not directly result in deterioration to existing fish or wildlife habitat as discussed in the answers to questions 4 and 5.

Depending on the structural controls selected, direct or indirect impacts to existing fish or wildlife habitat may occur. In urbanized areas, the installation of structural controls would not likely result in the deterioration of existing fish and or wildlife habitat in the immediate area of a project. Nonetheless, potential effects on fish or wildlife habitat can be minimized or eliminated by reducing the size of structural controls and limiting the encroachment and/or removal of animal habitat.

Structural controls could also divert, reduce, and/or eliminate stormwater runoff discharge, which would no longer reach the receiving waters at the impaired shoreline segment. These discharges are not expected to change the fish and wildlife habitat at the shorelines due to the relatively insignificant amount of discharge compared to the volume of the receiving waters.

6. Noise. a. Will the proposal result in increases in existing noise levels?

Answer: Less than significant with mitigation

Discussion: Non-structural controls could result in increases in existing noise levels due to increased traffic from street sweepers and/or maintenance vehicles which may increase the noise level temporarily as the vehicles pass through an area. However, the increase in noise levels would be no greater than typical infrastructure maintenance activities currently performed by municipalities and is therefore, less than significant.

The construction and installation of structural controls would result in temporary increases in existing noise levels, but this would be short term and only exist until construction is completed. Therefore, this noise impact is less than significant for humans. For some special status wildlife species, however, even temporary increases in noise levels could result in significant impacts. For example, special

status birds might abandon nesting sites in response to the stress of noise impacts. Mitigation measures for increased noise levels that adversely affect rare and endangered species are discussed under question 5 b.

The noise associated with the construction and installation of structural controls would be the same as typical construction activities in urbanized areas, such as ordinary road and infrastructure maintenance and building activities. Contractors and equipment manufacturers have been addressing noise problems for many years and through design improvements, technological advances, and a better understanding of how to minimize exposures to noise, noise effects can be minimized. An operations plan for the specific construction and/or maintenance activities could be prepared to identify the variety of available measures to limit the impacts from noise to adjacent homes and businesses.

Severe noise levels could be mitigated by implementing commonly-used noise abatement procedures, such as sound barriers, mufflers, and limiting construction and maintenance activities to times when these activities have lower impact, such as periods when there are fewer people near the construction area. Applicable and appropriate mitigation measures could be evaluated when specific projects are determined, depending upon proximity of construction activities to receptors.

6. Noise. b. Will the proposal result in exposure of people to severe noise levels?

Answer: Less than significant

Discussion: Non-structural controls would not result in increases in exposure of people to severe noise levels because none of these controls would introduce any physical effects that could impact this characteristic. Increased traffic from street sweepers and/or maintenance vehicles may increase the noise level temporarily as the vehicles pass through an area, but these levels will not be severe.

There is the possibility that severe noise levels could be emitted during construction activities. The increase in noise levels could be mitigated by implementing commonly-used noise abatement procedures, such as sound barriers, mufflers, and limiting construction and maintenance activities to times when these activities have lower impact, such as periods when there are fewer people in the area. Applicable and appropriate mitigation measures should be evaluated when specific projects are determined, depending upon proximity of construction activities to receptors.

7. Light and Glare. Will the proposal produce new light or glare?

Answer: Less than significant with mitigation

Discussion: Non-structural controls will not produce new light or glare because none of the BMPs would introduce any physical effects that could impact light and glare.

The construction and installation of structural controls could potentially be performed during evening or night time hours. If this scenario were to occur, night time lighting would be required to perform the work. Also, lighting could possibly be used to increase safety around structural controls. If temporary artificial lighting is required for construction purposes, this could be stressful for some rare and endangered species. For example, special status birds might abandon nesting sites in response to the stress of light and glare impacts. Mitigation measures for artificial light or glare that adversely affect rare and endangered species are discussed under question 5 b.

In the unlikely event that construction is performed during night time hours, a lighting plan should be prepared to include mitigation measures. Mitigation measures can include shielding on all light fixtures, and limiting light trespass and glare through the use of directional lighting methods. Other potential mitigation measures may include using screening and low-impact lighting, performing construction during daylight hours, or designing security measures for installed structural controls that do not require night lighting.

8. Land Use. Will the proposal result in substantial alteration of the present or planned land use of an area?

Answer: Less than significant

Discussion: Non-structural controls will not result in alteration of the present or planned land use of an area because none of the controls would introduce any physical effects that could impact land uses.

Implementation of structural controls may potentially cause minor alterations in present or planned land use of an area. However, municipalities are not required or expected to change present or planned land uses to comply with the TMDLs, and are encouraged to seek alternatives that would have the lowest impact on the land use and the environment. Potential conflicts between complying with the TMDLs and other land uses can be resolved by standard planning efforts under which specific projects are reviewed by local planning agencies. Applicable and

appropriate mitigation measures could be evaluated when specific projects are determined, and a cost-benefit analysis of proposed compliance alternatives should be performed.

More reasonable alternatives should be evaluated and implemented, such as non-structural controls and low impact and/or small scale structural controls, before considering an alternative that would create considerable hardship for the community in the area.

9. Natural Resources. a. Will the proposal result in increase in the rate of use of any natural resources?

Answer: No impact

Discussion: Non-structural and/or structural controls will not increase the rate of use of any natural resources. Implementation of non-structural and/or structural controls should not require quarrying, mining, dredging, or extraction of locally important mineral resources. Operation of street sweepers, construction, and maintenance vehicles could increase the use of fossil fuels, and some types of equipment used in structural controls may consume electricity to operate pumps, etc. However, the relative amounts of additional fossil fuel and electricity that might be used would fall well within the capacity and expectations of the region's normal rate of use of natural resources. The additional use of fossil fuels and electricity could be offset and reduced if dischargers used alternative fuels and/or renewable energies to power their vehicles and equipment.

9. Natural Resources. b. Will the proposal result in substantial depletion of any non-renewable natural resource?

Answer: No impact

Discussion Non-structural and/or structural controls will not substantially deplete any non-renewable natural resource. Operation of street sweepers, construction, and maintenance vehicles could increase the use of fossil fuels, and some types equipment used in structural controls may consume electricity to operate pumps, etc. However, the relative amounts of additional fossil fuel and electricity that might be used would fall well within the capacity and expectations of the region's energy supply and natural resources. The additional use of fossil fuels and electricity could be offset and reduced if dischargers used alternative fuels and/or renewable energies to power their vehicles and equipment.

10.Risk of Upset. Will the proposal involve a risk of an explosion or the release of hazardous substances (including, but not limited to: oil, pesticides, chemicals or radiation) in the event of an accident or upset conditions?

Answer: Less than significant

Discussion: Non-structural and structural controls will not involve a risk of an explosion or the release of hazardous substances (including, but not limited to: oil, pesticides, chemicals or radiation) in the event of an accident or upset conditions. The reasonably foreseeable non-structural and structural controls included in this evaluation would not be subject to explosion or the release of hazardous substances in the event of an accident because these types of substances would not be present. There is the possibility that hazardous materials (e.g., paint, oil, gasoline) may be present during construction and installation activities, but potential risks of exposure can be mitigated with proper handling and storage procedures. All risks of exposure would be short term and would be eliminated with the completion of construction and installation activities.

11.Population. Will the proposal alter the location, distribution, density, or growth rate of the human population of an area?

Answer: Less than significant

Discussion: Non-structural controls will not alter the location, distribution, density, or growth rate of the human population of an area because none of the controls would introduce any physical effects that could impact these characteristics.

Implementation of structural controls may potentially alter the location, distribution, density, or growth rate of the human population of an area. However, dischargers are not required or expected to change present or planned land uses to comply with the TMDLs, and dischargers are encouraged to seek alternatives that would have the lowest impact on the existing and planned population of an area. Potential conflicts between complying with the TMDLs and planned growth can be resolved by standard planning efforts under which specific projects are reviewed by local planning agencies. Applicable and appropriate mitigation measures could be evaluated when specific projects are determined.

More reasonable alternatives should be evaluated and implemented, such as non-structural controls and low impact and/or small scale structural controls, before considering an alternative that would create the need to relocate the population of parts of the watersheds.

12.Housing. Will the proposal affect existing housing, or create a demand for additional housing?

Answer: Less than significant

Discussion: Non-structural controls will not affect existing housing, or create a demand for additional housing because none of these controls would introduce any physical effects that could impact housing.

Implementation of structural controls may potentially affect existing housing. However, dischargers are not required or expected to change present or planned land uses to comply with the TMDLs, and dischargers are encouraged to seek alternatives that would have the lowest impact on land use and the environment. Potential conflicts between complying with the TMDLs and other land uses can be resolved by standard planning efforts under which specific projects are reviewed by local planning agencies. Applicable and appropriate mitigation measures could be evaluated when specific projects are determined.

More reasonable alternatives should be evaluated and implemented, such as non-structural controls and low impact and/or small scale structural controls, before considering an alternative that would create considerable hardship for the community in the area.

13.Transportation/Circulation. a. Will the proposal result in generation of substantial additional vehicular movement?

Answer: Less than significant

Discussion: Non-structural and/or structural controls will not result in generation of substantial additional long-term vehicular movement. There may be additional vehicular movement during construction of structural controls and during street sweeping and/or maintenance activities. However, vehicular movement during construction would be temporary, and vehicular movement during street sweeping and/or maintenance activities would be periodic and only as the vehicle passes through the area. This may generate minor additional vehicular movement. However, no long-term impacts are expected because any increase in maintenance vehicular activities would fall well within the present day activities in any municipality..

In order to reduce the impact of short-term construction traffic, a construction traffic management plan could be prepared for traffic control during any street closure, detour, or other disruption to traffic circulation. The plan could identify the routes that construction vehicles would use to access the site, hours of construction traffic,

and traffic controls and detours. The plan could also include plans for temporary traffic control, temporary signage and stripping, location points for ingress and egress of construction vehicles, staging areas, and timing of construction activity which appropriately limits hours during which large construction equipment may be brought on or off site.

The potential impact to vehicular movement can be reduced if street sweeping and/or maintenance activities are scheduled to be performed at the same time as other maintenance activities performed by municipalities, or at times when these activities have lower impact, such as periods of low traffic activity.

13. Transportation/Circulation. b. Effects on existing parking facilities, or demand for new parking?

Answer: Less than significant with mitigation

Discussion: Non-structural controls may affect existing parking facilities, or create demand for new parking structures, if increased street sweeping and/or maintenance is implemented in areas with parking along roadsides. Available parking in an area could be reduced during certain times of the day, week, and/or month, depending on frequency of street sweeping and/or maintenance events. Street sweeping and maintenance events should be scheduled to be performed at the same time as other maintenance activities performed by the municipalities, and/or at times when these activities have lower impact, such as periods of low traffic activity and parking demand.

Depending on the structural controls selected, alterations to existing parking facilities may occur to incorporate structural controls. This could reduce available parking in an area. However, structural controls can be designed to accommodate space constraints or be placed under parking spaces and do not have to occupy space in existing parking facilities. Available parking spaces can be reconfigured to provide equivalent number of spaces or provide functionally similar parcels for use as offsite parking to reduce potential impacts.

13. Transportation/Circulation. c. Will the proposal result in substantial impacts upon existing transportation systems?

Answer: Less than significant

Discussion: Non-structural controls will not result in significant impacts upon existing transportation systems. The only foreseeable impact would come from increased street sweeping, however long-term impacts are unlikely because any

increase in maintenance vehicular activities would fall well within the present day activities in any municipality, and would therefore not qualify as substantial.

Depending on the structural controls selected, temporary alterations to existing transportation systems may be required during construction and installation activities. The potential impacts would be limited and short-term. Potential impacts could be reduced by limiting or restricting hours of construction so as to avoid peak traffic times and by providing temporary traffic signals and flagging to facilitate traffic movement.

13.Transportation/Circulation. d. Will the proposal result in alterations to present patterns of circulation or movement of people and/or goods?

Answer: Less than significant

Discussion: Non-structural controls will not result in alterations to present patterns of circulation or movement of people and/or goods, because none of the controls, including increased street sweeping, would introduce any physical effects that could impact these characteristics. No long-term impacts are expected because any increase in maintenance vehicular activities would fall well within the present day activities in any municipality.

Depending on the structural controls selected, temporary alterations to present patterns of circulation or movement of people and/or goods may be required during construction and installation activities. The potential impacts would be limited and short-term. Potential impacts could be reduced by limiting or restricting hours of construction so as to avoid peak traffic times and by providing temporary traffic signals and flagging to facilitate traffic movement.

13.Transportation/Circulation. e. Will the proposal result in alterations to waterborne, rail or air traffic?

Answer: No impact

Discussion: Reasonably foreseeable non-structural and/or structural controls would not be of the size or scale that would result in alterations to waterborne, rail or air traffic.

13. Transportation/Circulation. f. Will the proposal result in increase in traffic hazards to motor vehicles, bicyclists or pedestrians?

Answer: Less than significant

Discussion: Non-structural controls could result in an increase in traffic hazards to motor vehicles, bicyclists or pedestrians due, for example, to increased street sweeping. However, any foreseeable impact from increased street sweeping would fall well within the present day conditions in any municipality, and would therefore not present new safety concerns.

Depending on the structural controls selected, a temporary increase in traffic hazards may occur during construction and installation activities. The specific project impacts can be reduced and mitigated by marking, barricading, and controlling traffic flow with signals or traffic control personnel in compliance with authorized local police or California Highway Patrol requirements. These methods would be selected and implemented by responsible local agencies considering project level concerns. Standard safety measures should be employed including fencing, other physical safety structures, signage, and other physical impediments designed to promote safety and minimize pedestrian/bicyclists accidents.

14. Public Service. a. Will the proposal have an effect upon, or result in a need for new or altered governmental services in any of the following areas: Fire protection?

Answer: Less than significant

Discussion: Non-structural controls will not have an effect upon, or result in a need for new or altered fire protection services because none of the controls would introduce any physical effects that could impact this service.

During construction and installation of structural controls, temporary delays in response time of fire vehicles due to road closure/traffic congestion during construction activities may occur. However, any construction activities would be subject to applicable building and safety and fire prevention regulations and codes. The responsible agencies could notify local emergency service providers of construction activities and road closures and could coordinate with local providers to establish alternative routes and appropriate signage. In addition, an Emergency Preparedness Plan could be developed for the construction of proposed new facilities in consultation with local emergency providers to ensure that the proposed project's contribution to cumulative demand on emergency response services would not result in a need for new or altered fire protection services. Most jurisdictions have in place established procedures to ensure safe passage of emergency vehicles

during periods of road maintenance, construction, or other attention to physical infrastructure. In any case, the installation of structural devices would not create any more significant impediments than such other ordinary activities

14.Public Service. b. Will the proposal have an effect upon, or result in a need for new or altered governmental services in any of the following areas: Police protection?

Answer: Less than significant

Discussion: Non-structural controls will not have an effect upon, or result in a need for new or altered police protection services because none of the controls would introduce any physical effects that could impact this service.

During construction and installation of structural controls, temporary delays in response time of police vehicles due to road closure/traffic congestion during construction activities may occur. The responsible agencies could notify local police service providers of construction activities and road closures and could coordinate with local police to establish alternative routes and traffic control during construction projects. In addition, an Emergency Preparedness Plan could be developed for the proposed new facilities in consultation with local emergency providers to ensure that the proposed project's contribution to cumulative demand on emergency response services would not result in a need for new or altered police protection services. Most jurisdictions have in place established procedures to ensure safe passage of emergency vehicles during periods of road maintenance, construction, or other attention to physical infrastructure. In any case, the installation of structural devices would not create any more significant impediments than such other ordinary activities.

14.Public Service. c. Will the proposal have an effect upon, or result in a need for new or altered governmental services in any of the following areas: Schools?

Answer: No impact

Discussion: Reasonably foreseeable non-structural and/or structural controls will not have an effect upon, or result in a need for new or altered school services because none of the controls would introduce any physical effects that could impact this service.

14.Public Service. d. Will the proposal have an effect upon, or result in a need for new or altered governmental services in any of the following areas: Parks or other recreational facilities?

Answer: No impact

Discussion: Non-structural controls will not have an effect upon, or result in a need for new or altered parks or other recreational facilities because none of the controls would introduce any physical effects that could impact parks or recreational facilities.

During construction and installation of structural controls, parks or other recreational facilities could be temporarily affected. Construction activities could potentially be performed near or within a park or recreational facilities. Potential impacts would be limited and short-term and could be avoided through siting, designing, and scheduling of construction activities.

In the unlikely event that the municipalities might install facilities on a scale that could alter a park or recreational facility, the structural controls could be designed in such a way as to be incorporated into the park or recreational facility. Additionally, should an impermeable detention basin be required, this could be constructed underground to avoid the need for new or altered parks or other recreational facilities.

14.Public Service. e. Will the proposal have an effect upon, or result in a need for new or altered governmental services in any of the following areas: maintenance of public facilities, including roads?

Answer: Less than significant with mitigation

Discussion: Non-structural controls may include additional road maintenance such as additional and/or increased street sweeping. Structural controls may require additional maintenance by dischargers to ensure proper operation. As discussed above for Questions 2, 6, and 13, additional or increased street sweeping and maintenance activities could affect air, noise, and transportation/circulation. The increase in air pollutants and noise levels would be no greater than typical street sweeping and maintenance activities currently performed by the municipalities. Street sweeping and maintenance events could be scheduled to be performed at the same time as other maintenance activities performed by the municipalities, or at times when these activities have lower impact, such as periods of low traffic activity and parking demand.

14.Public Service. f. Will the proposal have an effect upon, or result in a need for new or altered governmental services in any of the following areas: other government services?

Answer: Less than significant with mitigation

Discussion: As discussed above, non-structural and/or structural controls may include increased street sweeping and/or additional maintenance by dischargers to ensure proper operation of newly installed structural controls. However, the potential impacts to air, noise, and transportation/circulation would be no greater than typical street sweeping and maintenance activities currently performed by municipalities. Street sweeping and maintenance events could be scheduled to be performed at the same time as other maintenance activities performed by the municipalities, or at times when these activities have lower impact, such as periods of low traffic activity and parking demand.

Implementation of the TMDLs will result in the need for increased monitoring in the watersheds and to track compliance with the TMDLs. However, no effects to the environment would be expected from these monitoring activities.

15.Energy. a. Will the proposal result in use of substantial amounts of fuel or energy?

Answer: No impact

Discussion: Reasonably foreseeable non-structural and/or structural controls will not result the use of substantial amounts of fuel or energy. As discussed above for Question 9, operation of street sweepers, construction, and maintenance vehicles could increase the use of fossil fuels, and some types equipment used in structural BMPs may consume electricity to operate pumps, etc. The additional use of fossil fuels and electricity could be reduced if the dischargers used alternative fuels and/or renewable energies to power their vehicles and equipment.

15.Energy. b. Will the proposal result in a substantial increase in demand upon existing sources of energy, or require the development of new sources of energy?

Answer: No impact

Discussion: Reasonably foreseeable non-structural and/or structural controls will not result a substantial increase in demand upon existing sources of energy, or require the development of new sources of energy. As discussed for Questions 9 and 15a above, operation of street sweepers, construction, and maintenance

vehicles could increase the use of fossil fuels, and some types of equipment used in structural controls may consume electricity to operate pumps, etc. The additional use of fossil fuels and electricity could be reduced if the dischargers used alternative fuels and/or renewable energies to power their vehicles and equipment.

If alternative sources of energy are used, sources of alternative energy and fuel may be needed. Equipment and components for renewable sources of energy such as solar or wind are readily available. Alternative fuels such as ethanol or biodiesel are commercially available and can be used. Sources of new energy are not required to be developed.

16. Utilities and Service Systems. a. Will the proposal result in a need for new systems, or substantial alterations to the following utilities: power or natural gas?

Answer: Less than significant

Discussion: Non-structural controls will not result in a need for new systems or alterations to power or natural gas utilities because none of the controls would introduce any physical effects that could impact these utilities.

Installation of structural controls may require alterations or installation of new power or natural gas lines. Power and natural gas lines might need to be rerouted to accommodate the addition of structural controls. The degree of alteration depends upon local system layouts which careful placement and design can minimize. However, that the installation of structural controls will result in a substantial increased need for new systems, or substantial alterations to power or natural gas utilities, is not reasonably foreseeable, because none of these controls are large enough to substantially tax current power or natural gas sources. No long term effects on the environment are expected if alterations to power or natural gas utilities are required.

16. Utilities and Service Systems. b. Will the proposal result in a need for new systems, or substantial alterations to the following utilities: communications systems?

Answer: No impact

Discussion: Reasonably foreseeable non-structural controls will not result in a need for new or substantial alterations to communications systems because none of the controls would introduce any physical effects that could impact these utilities.

New systems or alterations to communications systems are not necessarily required for structural controls. Structural controls can be manually inspected and maintained

without any communications system required. However, that municipalities could install a remote monitoring system, which could include a new communications system, is possible. A telephone line or wireless communications system could be installed, which would not be a substantial alteration.

16.Utilities and Service Systems. c. Will the proposal result in a need for new systems, or substantial alterations to the following utilities: water?

Answer: No impact

Discussion: Reasonably foreseeable non-structural and/or structural controls will not result in a need for new or substantial alterations to water lines. The need for new municipal or recycled water to implement these TMDLs is not foreseeable.

16.Utilities and Service Systems. d. Will the proposal result in a need for new systems, or substantial alterations to the following utilities: Sewer or septic tanks?

Answer: Less than significant

Discussion: Non-structural and/or structural controls will not result in a need for new systems or alterations to sewer or septic tanks because none of the controls would introduce any physical effects that could impact these utilities.

Depending on the structural controls selected, a portion or all of the surface water runoff may be diverted to wastewater treatment facilities. If stormwater is diverted for treatment at a wastewater treatment facility, new connections to existing sanitary sewer lines may be required, but no new major sewer trunks or substantial alterations to sewer system would be expected because controls utilizing the sewer would likely contribute small amounts of first flush storm water. Any environmental affects from associated construction activities would be small scale and short-term and similar to typical municipal capital improvement projects.

16.Utilities and Service Systems. e. Will the proposal result in a need for new systems, or substantial alterations to the following utilities: storm water drainage?

Answer: Less than significant

Discussion: Non-structural controls will not result in a need for new systems, or substantial alterations to stormwater drainage systems because none of the controls would introduce any physical effects that could impact these utilities.

In order to achieve compliance with the TMDLs, the stormwater drainage systems may need to be reconfigured and/or retrofitted with structural controls to capture and/or treat a portion or all of the stormwater runoff. The alterations and/or additions to stormwater drainage systems will depend on the compliance strategy selected by each discharger at each location where structural controls might be installed. Impacts from construction activities to retrofit or reconfigure the storm drain system as part of installation, and mitigation measures have been considered and discussed in the previous responses to the questions.

16. Utilities and Service Systems. f. Will the proposal result in a need for new systems, or substantial alterations to the following utilities: solid waste and disposal?

Answer: Less than significant

Discussion: Most non-structural controls will not result in a need for new systems, or substantial alterations to the solid waste and disposal systems because none of the controls would introduce any physical effects that could impact these utilities. In urbanized areas, increased street sweeping would generate additional solid waste, but this additional waste is not expected to exceed the maintenance capacity of normal city operations. No new solid waste or disposal systems would be expected.

The installation of structural controls may generate construction debris. Additionally, installed structural controls may collect sediment and solid wastes that will require disposal. However, no new solid waste or disposal systems would be needed to handle the relatively small volume generated by these projects. Construction debris may be recycled at aggregate recycling centers or disposed of at landfills. Sediment and solid wastes that may be collected can be disposed of at appropriate landfill and/or disposal facilities.

17. Human Health. a. Will the proposal result in creation of, and exposure of people to, any health hazard or potential health hazard (excluding mental health)?

Answer: Less than significant with mitigation

Discussion: As discussed above for Questions 2 and 13, non-structural controls such as street sweeping and maintenance vehicles could have an effect on air and transportation/circulation. Non-structural controls could increase the amount of pollutants emitted into the atmosphere above ambient conditions. Non-structural controls could also increase traffic, which could potentially decrease the safety of pedestrians. In both cases, potential impacts can be reduced or eliminated if street sweeping and/or maintenance activities are scheduled to be performed at the same

time as other maintenance activities performed by the dischargers, or at times when these activities have lower impact, such as periods of low traffic activity.

As discussed above for questions 1, 2, 3, 5, and 13, the installation of structural controls could have an effect on earth, air, water, animal life, and transportation/circulation. Structural controls could increase the risk of unstable earth conditions, which could pose a physical risk to persons in the area should a slope fail. Construction, installation, and maintenance of structural controls could increase the amount of pollutants the air, which could have an effect on health. Structural controls could potentially result in additional habitat and/or standing water which can attract pests, such as flies, mosquitoes and/or rodents, which can be carriers of disease. Maintenance of structural controls could also increase traffic, which could potentially decrease the safety of pedestrians. Additionally, heavy machinery and materials that may be used during construction and installation of structural controls could pose physical and/or chemical risks to human health.

Potential impacts to earth could be avoided or mitigated through proper geotechnical investigations, siting, design, and ground and groundwater level monitoring to ensure that structural controls are not employed in areas subject to unstable soil conditions. Potential health hazards attributed to installation and maintenance of structural controls can be mitigated by use of OSHA construction and maintenance health and safety guidelines. Potential health hazards attributed to maintenance activities can be mitigated through OSHA industrial hygiene guidelines. Installation of non-vector producing structural controls can help mitigate vector production from standing water. Netting can be installed over structural controls to further mitigate vector production. Structural controls can be designed and sites can be properly protected to prevent accidental health hazards as well as prevent vector production. Vector control agencies may also be employed as another source of mitigation. Structural controls prone to standing water can be selectively installed away from high-density areas and away from residential housing and/or by requiring oversight and treatment of those systems by vector control agencies. Potential impacts to transportation/circulation can be reduced or eliminated if maintenance activities are scheduled to be performed at the same time as other maintenance activities performed by the municipalities, or at times when these activities have lower impact, such as periods of low traffic activity. Appropriate planning, design, siting, and implementation can reduce or eliminate potential health hazards due to the installation of structural controls.

18.Aesthetics. a. Will the proposal result in the obstruction of any scenic vista or view open to the public?

Answer: Less than significant with mitigation

Discussion: Non-structural controls will not result in the obstruction of any scenic vista or view open to the public because none of the controls would introduce any physical effects that could impact this characteristic.

That dischargers would comply with this TMDL by installing structural controls that would adversely affect a scenic vista or view open to the public is not reasonably foreseeable. Most structural controls that will likely be used can be constructed as subsurface devices, such as sand filters. Once completed, structural controls would not foreseeably obstruct scenic vistas or open views to the public. In the unlikely event that the dischargers might install facilities on a scale that could obstruct scenic views, such impacts could be reduced or eliminated with appropriate planning, design, and siting of the structural controls. Additionally, many structural controls can, if necessary, be constructed underground to eliminate aesthetic issues

18.Aesthetics. b. Will the proposal result in the creation of an aesthetically offensive site open to public view?

Answer: Less than significant with mitigation

Discussion: Non-structural controls will not result in the creation of an aesthetically offensive site open to public view because none of the controls would introduce any physical effects that could impact this characteristic.

The installation of structural controls could potentially create an aesthetically offensive site open to public view. Structural controls may create an aesthetically offensive site to the public during construction and installation, but this would be temporary until construction is completed. Once installation of the structural controls is complete, the site may continue to be aesthetically offensive to the public. However, many structural controls can be designed to provide wildlife habitat, recreational areas, and green spaces in addition to improving stormwater quality. Appropriate architectural and landscape design practices can be implemented to reduce adverse aesthetic effects. Screening and landscaping may also be used to mitigate adverse aesthetic effects. The adverse aesthetic effects could be reduced or eliminated and possibly improved with appropriate planning and design of the structural controls. Additionally, many structural controls can, if necessary, be constructed underground to eliminate aesthetic issues.

19.Recreation a. Will the proposal result in impact on the quality or quantity of existing recreational opportunities?

Answer: Less than significant with mitigation

Discussion: Non-structural controls will not result in impact on the quality or quantity of existing recreational opportunities because none of the controls would introduce any physical effects that could impact these characteristics.

During construction and installation of structural controls, parks or other recreational areas could be temporarily affected. Construction activities could potentially be performed near or within a park or recreational area. Potential impacts would be limited and short-term, and could be avoided through proper siting, design, and scheduling of construction activities.

In the event that the municipalities might install facilities on a scale that could alter a park or recreational area, the structural controls could be designed in such a way as to be incorporated into the park or recreational area. Additionally, any structural controls can, if necessary, be constructed underground to minimize impacts on the quality or quantity of existing recreational opportunities. Mitigation to replace lost areas may include the creation of new open space recreation areas and/or improved access to existing open space recreation areas.

Additionally, improvement of water quality could create new recreation opportunities in urbanized areas of the watersheds by providing the opportunity to recreate in and near a clean water body with a robust and diverse population of plants and animals.

20.Archeological/Historical a. Will the proposal result in the alteration of a significant archeological or historical site, structure, object or building?

Answer: Less than significant with mitigation

Discussion: Non-structural controls will not result in the alteration of a significant archeological or historical site, structure, object or building because none of the controls would introduce any physical effects that could impact these characteristics.

In the unlikely event that dischargers might install facilities on a scale that could result in significant adverse effects on a significant archeological or historical site, structure, object or building, a project level, site-specific environmental assessment should be performed to identify the mitigation measures that could be employed to minimize the potential effects on archeological or historical sites and identify alternatives that could potentially be used that would have less impact. The

agencies responsible for implementing this TMDL could consult the relevant local archeological or historical commissions or authorities to identify these types of sites and determine ways to avoid significant adverse impacts. The potentially adverse effects on archeological or historical sites that might be present could be reduced or eliminated with appropriate planning, design, and siting of the structural controls.

21. Mandatory Findings of Significance - Potential to degrade: Does the project have the potential to degrade the quality of the environment, substantially reduce the habitat of a fish or wildlife species, cause a fish or wildlife population to drop below self-sustaining levels, threaten to eliminate a plant or animal community, reduce the number or restrict the range of a rare or endangered plant or animal or eliminate important examples of the major periods of California history or prehistory?

Answer: Less than significant with mitigation

Discussion: Non-structural controls will not result in the substantial degradation of the environment for plant and animal species because none of the controls would introduce any physical effects that could impact these characteristics.

As discussed above in Questions 4 and 5, plant and animal species could potentially be adversely affected by the installation and operation of structural controls. Mitigation measures could be implemented to ensure that unique, rare or endangered plant and/or animal species and their habitats are not taken or destroyed. When specific projects are developed and sites identified, a focused protocol plant and/or animal survey and/or a search of the California Natural Diversity Database should be performed to confirm that any potentially sensitive or special status plant and/or animal species in the site area are properly identified and protected as necessary. If sensitive plant and/or animal species occur on the project site, mitigation is required in accordance with the Endangered Species Act. Mitigation measures should be developed in consultation with the CDFG and the USFWS. Dischargers should avoid installing structural BMPs that could adversely affect any unique, rare or endangered species of plants and/or animals, and instead opt for non-structural controls and/or identify and install structural controls that will have little or no impact such as underground structural controls.

Taken all together, the potential impacts of the project will not cause a significant cumulative impact in the environment. In any case, the implementation of this TMDL will result in improved water quality in the waters of the Region and will have significant beneficial impacts to the environment over the long term.

21.Mandatory Findings of Significance - Short-term: Does the project have the potential to achieve short-term, to the disadvantage of long-term, environmental goals? (A short-term impact on the environment is one which occurs in a relatively brief, definitive period of time, while long-term impacts will endure well into the future.)

Answer: No impact

Discussion: There are no short-term beneficial effects on the environment from the implementation of non-structural and/or structural controls that would be at the expense of long-term beneficial effects on the environment. The implementation of non-structural and/or structural controls to comply with the proposed waiver conditions will result in improved water quality in the waters of the Region and will have significant beneficial impacts to the environment over the long term.

21.Mandatory Findings of Significance - Cumulative: Does the project have impacts which are individually limited, but cumulatively considerable? (“Cumulatively considerable” means that the incremental effects of a project are considerable when viewed in connection with the effects of past projects, the effects of other current projects, and the effects of probable future projects.)

Answer: Less than significant with mitigation

Discussion: Cumulative impacts, defined in section 15355 of the CEQA Guidelines, refer to two or more individual effects, that when considered together, are considerable or that increase other environmental impacts. Cumulative impact assessment must consider not only the impacts of the proposed bacteria TMDLs, but also the impacts from other TMDL, municipal, and private projects, which have occurred in the past, are presently occurring, and may occur in the future, in the watershed during the period of implementation.

Past and present projects may be regarded as the general construction (development and maintenance) which has brought several regional creeks from a natural, pristine condition, to the urban, developed setting which is present today. This provides a baseline level of construction with which to compare all water quality project requirements. The past and present baseline of construction in the urbanized watersheds will probably remain constant in the future. The increment of increased construction proposed by the cumulative requirements of all water quality requirements can be mitigated through scheduling, and is insignificant compared to the past and on-going baseline of typical municipal construction.

Present and future impacts will come from all of the water quality control programs and pollutant load reduction projects being implemented in the watershed or planned for the near future. This includes waterbodies for which other TMDLs are to be

developed, and projects to comply with the WDRs in Order Nos. R9-2007-0001 and R9-2002-0001 (the San Diego County and Orange County municipal stormwater requirements).

Cumulative impacts of these bacteria TMDLs and other water quality control programs are not expected to be significant because effective non-structural controls, that have no identified significantly adverse impacts, will most likely be an initial strategy for implementation of the bacteria TMDLs. For example, the bacteria TMDLs can be implemented through education and outreach, and enforcement of ordinances requiring pet owners to properly dispose of pet waste, ordinances prohibiting disposal of grease, food products, and other bacteria-laden waste products into the storm drain, and ordinances curbing nuisance flows into the stormdrain system. Another important bacteria load reduction program is to find and fix illegal cross-connections between the sanitary sewer system and the stormdrain system. Fixing cross connections between the storm drain and sanitary sewer systems may increase the overall number of construction projects needed in the watershed to implement TMDLs. However, estimating the number of cross-connections that might exist is purely speculative. Further, these types of construction projects are on a small scale and fall well within typical municipal capital improvement and maintenance activities. Additionally, some of these practices, such as curbing nuisance flows, will be effective at addressing other pollutants in addition to bacteria. Therefore the cumulative effects will not be considerable, and can be mitigated, if necessary, through scheduling.

The dischargers may opt to use structural controls to reduce bacteria and other pollutants to the watersheds, which would increase the likelihood of environmental effects that are cumulatively considerable. The City of San Diego funded an assessment of best management practice (BMP) strategies that would lessen the anticipated impacts and allow an integrated TMDL strategy that address both current and anticipated TMDLs in Chollas Creek. In this study,²¹ the authors recommended a strategy that used a tiered approach that reduces the impact to the environment, and allows for more cost effective implementation of lower-impact BMPs. The tiered approach consists of three major components:

- Tier 1 – Control of Pollutants at the Source and Prevent Pollutants from Entering Runoff
- Tier 2 – Conduct Design Studies and Implement Aggressive Street Sweeping and Runoff and Treatment Volume Reduction BMPs
- Tier 3 – Infrastructure Intensive Treatment BMPs

Implementation of this BMP strategy, because it emphasizes BMPs with the least adverse impacts to the environment, should reduce cumulative impacts to less than significant levels. Although this study was specific to Chollas Creek, the recommended strategy is applicable to reducing pollutants in all watersheds.

²¹ Weston Solutions, 2006. *Chollas Creek TMDL Source Loading, Best Management Practices, and Monitoring Strategy Assessment*, September, 2006.

Present and future specific TMDL projects may include construction of structural controls which must be environmentally evaluated for potential cumulative impacts by the implementing municipality. Present and future specific TMDL projects and other construction activities may result in short-term cumulative impacts as described below. However, appropriate and available mitigation measures, including scheduling, are available to reduce adverse environmental impacts associated with construction to less than significant levels.

Noise and Vibration - Local residents in the near vicinity of installation and maintenance activities may be exposed to noise and possible vibration. The cumulative effects, both in terms of added noise and vibration at multiple installation sites, and in the context of other related projects, are not likely to be cumulatively considerable due to the temporary nature of noise increases and the small scale of the projects. Noise mitigation methods including scheduling of construction are discussed above, and should be used to keep cumulative noise and vibration affects to acceptable levels.

Air Quality - Implementation of the bacteria TMDL program may cause additional emissions of air pollutants and slightly elevated levels of carbon monoxide during construction activities. Emission of air pollutants resulting from installation of TMDL compliance devices may exceed certain regulatory thresholds, and therefore the TMDL, in conjunction with all other construction activity, may contribute to the region's overall exceedance of certain regulatory thresholds during the installation period. However, because these installation-related emissions are temporary, compliance with the TMDL would not result in long-term cumulatively considerable air quality impacts. Short-term impacts can be avoided through scheduling.

Transportation and Circulation - Compliance with the bacteria TMDLs could involve installation activities occurring simultaneously at a number of sites within the watersheds included in this project. Installation of bacteria reduction structural controls may occur in the same general time and space as other related or unrelated projects. In these instances, construction activities from all projects could produce cumulative traffic effects depending upon a range of factors including the specific location involved and the precise nature of the conditions created by the numerous construction activities. Special coordination efforts may be necessary to reduce the combined effects to an acceptable level. Overall, cumulatively considerable impacts are not anticipated because coordination can occur and because transportation mitigation methods are available.

Public Services - The cumulative effects on public services due to the bacteria TMDLs would be limited to traffic inconveniences. These effects are not likely to be cumulatively considerable as long as alternative traffic route are available around construction sites.

Aesthetics - Construction activities associated with other related projects may be ongoing in the vicinity of one or more bacteria TMDL construction sites. To the

extent that combined construction activities do occur, there would be temporary elevated adverse visual effects. However, these effects are not cumulatively considerable in the long-term because the effects will cease with the completion of construction. Short-term impacts can be avoided through scheduling.

As analyzed above, the construction of structural controls, along with other construction and maintenance projects, could have short-term cumulative effects; however, these effects can be mitigated through proper construction scheduling. In addition, these effects are not cumulatively considerable in the long-term because the effects will cease with the completion of construction. In summary, appropriate and available mitigation measures, including scheduling, are available to reduce adverse environmental impacts associated with construction to less than significant levels.

21. Mandatory Findings of Significance - Substantial adverse: Does the project have environmental effects which will cause substantial adverse effects on human beings, either directly or indirectly?

Answer: Less than significant with mitigation

Discussion: All of the potentially significant impacts to human beings, such as air quality, noise, aesthetics, alterations to utilities, fire protection, police protections etc., are either short-term in nature, or can be mitigated to acceptable levels as previously discussed.

M.5.1 Alternative Means of Compliance

The CEQA requires an analysis of reasonably foreseeable alternative means of compliance with the rule or regulation, which would avoid or eliminate the identified impacts.²² The dischargers can use the non-structural and/or structural controls described in section D.3, or other non-structural and structural controls, to control and prevent pollution, and meet the TMDLs' required load reductions. However, the non-structural and structural controls provided in section D.3 are by no means a complete and exhaustive list. The controls described in section D.3 simply provide a reasonable range of reasonably foreseeable method of compliance that may be used by the dischargers to meet the TMDLs' required load reductions.

The potential means of compliance with this TMDL Basin Plan amendment may consist of any combination of non-structural and structural controls that the dischargers might select to use. Because there are many additional controls that may be implemented, and innumerable ways to combine non-structural and/or structural controls, there are also innumerable alternative means on compliance. Therefore, all of the possible alternative means of compliance cannot be discussed here. However, because most of

²² California Code of Regulations Title 14 section 15187(c)(3)

the adverse environmental effects are associated with the construction and installation of structural controls, in order for dischargers to avoid or eliminate potential impacts to the environment, compliance alternatives should minimize the use of structural controls, maximize the use of non-structural controls, and site, size, and design any structural controls that may be used in ways to minimize or eliminate any potential environmental effects.

M.6 Reasonably Foreseeable Methods of Compliance at Specific Sites

The San Diego Water Board analyzed various reasonably foreseeable methods of compliance at specific sites within the subject watersheds. Because this project includes multiple watersheds, the specific sites analysis was focused on reviewing potential compliance methods within various land uses. The land uses cited below correspond to the land uses that were utilized for watershed model development (the watershed models are discussed extensively in section 6 of the Technical Report and Appendix F). Land uses in this analysis include: residential, parks/recreation, commercial/institutional, and industrial/transportation. These land uses represent a range of population densities and geographical settings found in the subject watersheds.

In this discussion of potential compliance methods, the San Diego Water Board assumed that, generally speaking, the methods suitable for the control of bacteria generated from a specific land use within a given watershed are also suitable for the control of bacteria generated from the same land use category within a different watershed. For example, a method used to control the discharge of bacteria from a residential area in the Baby Beach watershed is likely suitable to control the discharge of bacteria from a residential area in the Shelter Island Shoreline Park watershed. However, in addition to land use, selection of control methods includes considering site-specific geographical factors such as average rainfall, soil type, and the amount of impervious surfaces, and non-geographical factors such as available funding. Such factors vary between watersheds. The most suitable controls for a particular site must be determined by the dischargers in a detailed, project-specific environmental analysis.

The following discussion involves a programmatic level review of specific site compliance methods, or combination of compliance methods that have been or may be implemented in the subject watersheds, as well as other BMP examples that could potentially be implemented at additional sites. The dischargers are in no way limited to using the controls included here to comply with achieve TMDL compliance, and may choose not to implement these particular BMPs.

In order to meet TMDL requirements, dischargers will determine and implement the actual compliance method(s) after a thorough analysis of the specific sites suitable for BMP implementation within each watershed. In most cases, the San Diego Water Board anticipates a potential strategy to be the use of management measures, or other non-structural controls as a first step in controlling bacteria discharges, followed by installation of structural controls if necessary.

M.6.1 Potential Controls for Residential Areas

Residential areas in the San Diego Region tend to have the highest population densities as compared to other land use categories. Thus, residential areas have the highest potential for producing human pathogens that can contaminate surface waters. Most of the residential areas are in urbanized areas.

In order to achieve TMDL compliance, residential land use areas, like the area shown in Figure M-1, may only require non-structural controls; however, structural controls could be retrofitted, if appropriate. Potential non-structural controls at this specific site include increased street sweeping, and development and enforcement of municipal ordinances prohibiting the discharge of bacteria and nuisance flows to stormwater and stormwater drainage pathways. Other potential controls include adoption and enforcement of ordinances to pick up pet waste, and regular inspections of storm drains for cross connections with the sanitary sewers.

Potential structural controls include the installation of storm drain filter sacks, which require routine maintenance. Residential areas should be designed with vegetative strips to control the velocity of runoff, increase infiltration, and prevent pollutants from entering stormwater drainage pathways, as shown in Figure M-1.

For a complete discussion of possible adverse effects of the types of controls discussed above, see section M.5.



Figure M-1. Buffer Strips in Residential Area, Santa Clara Avenue in Dana Point within Baby Beach Watershed

M.6.2 Potential Controls for Park and Recreational Areas

Park and recreational areas typically do not have housing or industrial units, thus population densities in these areas are low. However, parks and recreational areas may have significant use as dog walking areas, and be at risk for accumulating pet wastes.

In order to achieve TMDL compliance, park and recreational areas, may only require non-structural controls to encourage responsible actions by pet owners, and efficient irrigation practices that do not result in runoff leaving the site. Potential non-structural controls at this specific site include the availability of pet waste plastic bags and garbage cans, like the examples shown in Figures M-2 and M-3. Other non-structural controls include the enforcement of pet waste ordinances (see Figure M-3). No adverse environmental effects are expected from such measures.

Many park and recreation areas are used by animals, which can be a significant source of pollution if not properly managed. Another example of non-structural controls includes education of animal owners. Animal owners should be educated about proper management of their animal's wastes. For example, as shown in Figure M-3 a sign has been posted to encourage responsible actions by dog owners. Signs could also be posted so owners of larger pets, such as horses, are educated about how to properly manage their animals and animal wastes.



Figure M-2. Plastic Bag Dispenser at Shelter Island Shoreline Park in San Diego within Shelter Island Shoreline Park Watershed.



Figure M-3. Plastic Bag Dispenser and Sign at Dana Cove Park in Dana Point within Baby Beach Watershed.



Figure M-4. Buffer Strip at Shelter Island Shoreline Park, San Diego, Shelter Island Shoreline Park Watershed.

In some cases, structural controls may be required. Park and recreation areas can also be used to treat pollutants like a vegetated swale or buffer strip, as shown above in Figure M-4. These types of areas can provide wildlife habitat, are visually pleasing, and

are successful at reducing or removing a number of pollutants from surface runoff before reaching creek and stream channels.

For a complete discussion of possible adverse effects of the types of controls discussed above, see section M.5.

M.6.3 Potential Controls for Commercial/Institutional Areas

Population densities in commercial and institutional areas vary on an hourly basis but are relatively high in these areas, compared to other land uses. Commercial and institutional areas are located primarily in urbanized areas.

A potential strategy to achieve TMDL compliance includes non-structural controls, which may be sufficient to limit bacteria discharges. Commercial businesses and keepers of school grounds should use cleaning practices that contain pollutants instead of allowing them to enter conveyance systems. For example, debris and other waste should be swept up and disposed of properly, and trash receptacles should be available and properly maintained so access to trash by people and animals is limited, as shown in Figure M-5.



Figure M-5. Trash Receptacle Storage Area behind Business on Del Prado in Dana Point within Baby Beach Watershed.



Figure M-6. Vegetative Strip around Strip Mall on Del Prado in Dana Point within Baby Beach Watershed.

Potential structural controls include the installation of vegetative strips and grassy areas as part of landscaping to control the velocity of runoff, increase infiltration, and prevent pollutants from entering stormwater drainage pathways, as shown above in Figure M-6. Another potential structural BMP that could be utilized in areas where storm drains discharge directly into receiving waters with high recreational use is a dry weather diversion, which are widely used near popular swimming beaches. Dry weather diversions are effective at reducing or removing urban runoff, or nuisance flows, from reaching receiving waters by directing them into sewer systems. These structural controls are suitable in land use categories where the specific site has similar hydrologic settings (dry weather nuisance flows discharging directly into receiving waters).

For a complete discussion of possible adverse effects of the types of controls discussed above, see section M.5.

M.6.4 Potential Controls for Industrial and Transportation Areas

Population densities in industrial and transportation areas vary depending on time of day and also day of week, but are relatively high in these areas, compared to other land uses. Industrial and transportation areas are located primarily in urbanized areas.

Several industrial parks and roadways have adjacent landscaped areas where both management areas and structural controls could be designed to help reduce bacteria discharges to surface waters. Non-structural controls can include using manure fertilizers sparingly, and efficient irrigation practices that minimize the amount of runoff leaving the site. Landscaping can be designed to capture and control the velocity of runoff, increase infiltration, and prevent pollutants from entering stormwater drainage pathways. Additionally, pervious surfaces near transportation areas often have steep

slopes. To prevent erosion and the transport of sediment and bacteria to stormwater drainage pathways, various structural controls can be used. Some examples are fiber rolls, netting, and compost blankets.

For a complete discussion of possible adverse effects of the types of controls discussed above, see section M.5.

M.7 Economic Factors

This section presents the San Diego Water Board's economic analysis of the most reasonably foreseeable methods of compliance with the Basin Plan amendment to incorporate TMDLs for bacteria indicators at the impaired shoreline segments of Baby Beach and Shelter Island Shoreline Park.

M.7.1 Legal Requirement for Economic Analysis

The San Diego Water Board must comply with CEQA when amending the Basin Plan.²³ The CEQA process requires the San Diego Water Board to analyze and disclose the potential adverse environmental impacts of a Basin Plan amendment that is being considered for approval. TMDL Basin Plan amendments typically include "performance standards."²⁴ TMDLs normally contain a quantifiable numeric target that interprets the applicable WQO. TMDLs also include WLAs for point sources and LAs for both nonpoint sources and natural background. The quantifiable target together with the allocations may be considered a performance standard.

CEQA has specific provisions governing the San Diego Water Board's adoption of regulations such as the regulatory provisions of Basin Plans that establish "performance standards" or treatment requirements.²⁵ These provisions require that the San Diego Water Board perform an environmental analysis of the reasonably foreseeable methods of compliance with the WLAs and LAs prior to the adoption of the TMDL Basin Plan amendment. The San Diego Water Board must consider the economic costs of the methods of compliance in this analysis.²⁶ The proposed Basin Plan amendment does not include new WQOs but implements existing objectives to protect beneficial uses. The San Diego Water Board is therefore not required to consider the factors in Water Code section 13241 (a) through (f).

The most reasonably foreseeable methods of compliance with this Basin Plan amendment is for dischargers to implement structural and non-structural controls to reduce bacteria loads in their discharges to surface waters. Additionally, dischargers

²³ Public Resources Code section 21080

²⁴ The term "performance standard" is defined in the rulemaking provisions of the Administrative Procedure Act (Government Code sections 11340-11359). A "performance standard" is a regulation that describes an objective with the criteria stated for achieving the objective. [Government Code section 11342(d)].

²⁵ Public Resources Code sections 21159 and 21159.4

²⁶ See Public Resources Code section 21159(c)

will need to conduct surface water monitoring to evaluate the effectiveness of the controls they implement.

M.7.2 Project Implementation Costs

The specific controls to be implemented will be chosen by the dischargers after adoption of this TMDL Basin Plan amendment. All costs are preliminary estimates because particular elements of a control, such as type, size, and location, would need to be developed to provide a basis for more accurate cost estimations. Identifying the specific controls that dischargers will choose to implement is speculative at this time and the controls presented in this section serve only to demonstrate potential costs. Therefore, this section discloses typical costs of conventional controls for urban runoff, as well as monitoring program costs.

M.7.3 Cost Estimates of Typical Controls for Urban Runoff Discharges

Approximate costs associated with reasonably foreseeable non-structural and structural controls that might be implemented in order to comply with the requirements of this TMDL project are provided below. The controls are divided into non-structural and structural BMP classes. Cost estimates for structural BMPs cited from “*Stormwater Best Management Practice Handbook – New Development and Redevelopment, January 2003*” are for new construction costs only (CASQA, 2003). These estimates generally do not take into account retrofit of existing structures or the potential purchase on land needed for the BMP. Cost estimates provided by Caltrans’s *BMP Pilot Retrofit Pilot Program* were from BMPs retrofitted on existing State owned land (Caltrans, 2004). Annual maintenance costs estimates are based on a percentage of the construction cost estimate (USEPA, 1999).

Non-Structural Controls

Education and Outreach: Education and outreach to residents, businesses and industries can be a very effective tool. These efforts can include methods to reduce sources of pathogens like pet waste in residential areas and methods aimed at reducing excessive irrigation that will flow into the storm drain system. The cost of educational programs will vary with the scope of efforts and are estimated to range up to \$210,900. Educational materials can cost from 10¢ per flyer to \$1,750 for household surveys (USEPA, 1999). Because education and outreach efforts are typically a component of water quality programs, the cost to develop educational programs and materials to comply with the TMDL project requirements are expected to be less than estimated because the programs and materials addressing storm water and urban runoff related issues may already exist.

Road and Street Maintenance: Another effective BMP to prevent pollutants, trash, and organic material from entering the storm drain is proper maintenance and cleaning of the sidewalks, streets, and gutters. The largest expenditures for street sweeping programs are in staffing and equipment. The capital cost for a street sweeper is between \$60,000 and \$180,000 and the average useful life of a sweeper is about four to eight years (USEPA, 1999). Operation and maintenance costs are estimated to range

from \$15 to \$30 per curb mile. This particular BMP may prove to be more cost-effective than certain structural controls, especially in more urbanized areas with greater areas of pavement.

Illicit Connection Identification: Illicit connections of sanitary sewer line and infiltration from leaking sewer lines to the storm water drain system can be a source of pathogens in urban runoff. Identification of illegal connections can be done through visual inspection or through the use of dye and smoke tests. Visual inspection of the storm drain system can cost from \$1,250 to \$1,750 per square mile (USEPA, 1999).

Land Use Modifications: Land Use Modifications can be used to minimize the degradation of water resources caused by storm water run-off by directing urban growth and development away from environmentally sensitive areas and waterways. Sensitive areas can be protected through open space preservation and rezoning of development rights. Costs for new development will be lower if the site is adjacent to existing urban areas because the infrastructure and public services should already exist. Savings can also be realized if the development site is modified to reduce the impacts from urban run-off caused by impervious surfaces by reducing street widths, clustering housing developments, smaller parking lots, and incorporating vegetative BMPs into the site design. Savings come through the reduction of costs associated with clearing and grading, road paving, and storm water drainage systems. See Table M-1 for an example of capital cost savings (CASQA, 2003).

Table R-1. Summary of Potential Savings by Land Use Modifications

Development Pattern	Capital Costs (2005 Dollars) ⁴
Compact Growth ¹	\$31,000
Low-Density Growth (3 units/acre) ²	\$60,100
Low-Density Growth, 10 miles from Existing Development ³	\$82,500

¹Costs include streets (full curb and gutter), central sewage and water supply, storm drainage and school construction.

²Assumes housing mix of 30 percent single-family units and townhouses; 70 percent apartments.

³Assumes housing is located 10 miles from major concentration of employment, drinking water plant and sewage treatment plant.

⁴ Adjusted for inflation from 1987 dollars (Sahr, 2006).

Structural Controls

Vegetated Buffer or Filter Strips: Vegetated buffer strips are vegetated surfaces that are designed to treat sheet flow from adjacent surfaces, such as parking lots, highways, and rooftops (CASQA, 2003). The costs associated with vegetated buffer strips vary and are dependent of the costs associated with establishing the vegetation. Cost estimates range from \$13,000 to \$30,000 per acre. Additional costs could include the purchase of land for the buffer strip (CASQA, 2003). Maintenance of the buffer strip consists mainly of irrigation, mowing, weeding, and litter removal. Costs are estimated to be \$350/acre/year (CASQA, 2003). Caltrans reported actual construction costs of a

buffer strip for Carlsbad Maintenance Station to be \$81,000 with average annual maintenance cost of \$1,900 (Caltrans, 2004).

Bioretention: Bioretention systems are designed to mimic the functions of a natural ecosystem for treating storm water runoff (USEPA, 1999). Pollutants are removed by a number of processes including adsorption, filtration, volatilization, ion exchange, and decomposition (USEPA, 1999). Bioretention construction costs in residential areas are estimated to be \$3 to \$4 per square foot depending on the soil conditions and plant selection. Commercial and industrial costs range from \$10 to \$40 per square foot depending on the design and need for storm drains (CASQA, 2003). Maintenance activities conducted on bioretention facilities were not found to be very different from maintenance of a landscaped area (CASQA, 2003).

Sand Filters: Media filters are commonly used to treat runoff from small sites such as parking lots and small developments, in areas with high pollution potential such as industrial areas, or in highly urbanized areas where land availability or costs preclude the use of other BMP types (USEPA, 1999). An Austin Sedimentation-Filtration System (a type of surface sand filter) is estimated to cost \$18,500 (CASQA, 2003). A sand filter constructed at the La Costa Park and Ride for a 2.7-acre watershed area cost \$226,000 with an average annual maintenance cost of \$870 (Caltrans, 2004).

Infiltration Trench: Infiltration systems are designed to capture a volume of storm water runoff, retain it, and infiltrate that volume into the ground (USEPA, 1999). Infiltration trench is estimated to cost \$45,000 for a 5-acre commercial site (USEPA, 1999). An infiltration trench constructed at the Carlsbad Maintenance Station for a 0.7-hectare watershed area cost \$180,000 with an average annual maintenance cost of \$723 (Caltrans, 2004).

Diversion/Treatment Systems: If no other on-site treatment options are available, diverting the polluted runoff to the sanitary sewer system or other treatment plant may be considered. An individual diversion structure is likely to cost over one million dollars, which does not include maintenance costs.

For example, the City of Dana Point recently put into operation a diversion and ozone treatment system targeting Salt Creek and Monarch Beach. The system has a capacity of 1,000 gallons per minute. According to the Orange County Register (October 18, 2005), the system cost \$6.7 million. These costs include \$1 million in architectural features, and \$1 million for design and administration of the project. Operation and maintenance is contracted out at a cost of \$90,000 per year. In another example, the City of Encinitas has constructed a diversion and ultraviolet radiation treatment system to kill bacteria in runoff to Moonlight Beach. The system has a capacity of 150 gallons per minute, and cost \$1 million for testing, design and construction. Operation and maintenance costs are \$10,000 per year (Jeremy J. Clemmons, PBS&J, personal communication, October 26, 2005).

M.7.4 Cost Estimate Summary for Urban Runoff Controls

Table M-2 summarizes the estimated costs of non-structural urban runoff controls. Tables M-3 summarizes for each watershed the estimated costs of the specific structural urban runoff BMPs that were evaluated for each watershed. The cost estimates for the structural controls are based on sizing the control to treat 10 percent of the urbanized area of each watershed. For example, using the 10 percent cost estimates provided in Table M-3, a cost estimate for 100 percent land treatment could easily be calculated by multiplying the 10 percent cost estimate by 10, or by 5 for 50 percent, or 8 for 80 percent, etc. Additionally, the estimated cost of one diversion structure is provided and can be scaled upward depending on the individual needs in any given watershed.

Table M-2. Summary of Cost Estimates for Non-Structural Controls

BMP	Estimated Cost ¹
Education and Outreach	\$0 to \$210,900 per program
Road and Street Maintenance	\$60,000 to \$180,000
Illicit Connection Identification	\$1,250 to \$1,750 per square mile
Land Use Modifications	Potential cost reduction to developers and local government

¹ USEPA, 1999.

Table M-3. Cost Estimates for Structural Controls for 10 Percent of Urbanized Areas

BMP	Estimated Total Cost to Treat 10 Percent of an Urbanized Area (in acres) ^{1, 2, 3}	Estimated Yearly Maintenance Cost ²
Baby Beach Modeled Watershed		
Vegetated Buffer Strip	\$339,690 - \$783,900	\$8,362
Bioretention	\$817,978 - \$10,906,432	\$57,258 - \$762,450
Sand Filters	\$1,149,720 - \$4,546,620	\$149,464 - \$591,061
Infiltration Trench	\$45,989 - \$108,701	\$9,198 - \$21,740
Diversion	> \$1 million per diversion structure	> \$10,000 per structure
Shelter Island Shoreline Park Modeled Watershed		
Vegetated Buffer Strip	\$6,630 - \$15,300	\$163
Bioretention	\$15,965 - \$212,870	\$1,118 - \$14,901
Sand Filters	\$22,440 - \$88,740	\$2,917 - \$11,536
Infiltration Trench	\$898 - \$2,122	\$180 - \$424
Diversion	> \$1 million per diversion structure	> \$10,000 per structure

¹ CASQA, 2003.

² USEPA, 1999.

³ Assumes 100 percent of modeled watershed is urbanized area.

M.7.5 Cost Estimates for Surface Water Monitoring

The Health and Safety Code already requires a monitoring and reporting program for indicator bacteria at ocean beaches throughout California during dry weather.²⁷ Thus, the dischargers will incur no additional costs for monitoring water quality at beaches from April 1 through October 31 (the required monitoring period). Water quality and flow monitoring for inland surface water and storm drains will be required to measure the effectiveness of controls implemented by the dischargers to reduce bacteria loads. This additional monitoring will add to the costs of implementing these TMDLs.

The TMDLs do not specify the locations and frequencies of sampling of inland surface waters, storm drains, and beaches outside the Health and Safety Code requirements, to measure the effectiveness of bacteria load reduction controls. Each watershed is different in terms of size, flow, land uses, existing bacteria load, and reductions needed. Thus, a different monitoring plan individually tailored for each watershed must be formulated and implemented by the dischargers.

This analysis discloses the costs of collecting, transporting, and analyzing a water sample for the four indicator bacteria for which there are inland surface water WQOs. The costs disclosed are that of a two-person team, day-long sampling effort. The laboratory analytical costs were taken from the San Diego Water Board's Laboratory Services Contract cost tables. Where different analytical methods were available, the more expensive method was used in the estimate. Staff costs were estimated based on a two person sampling team in the field for an 8-hour day. The staff costs were estimated based on a billing rate of \$90 per hour, the rate used for billing San Diego Water Board staff costs in the Cost Recovery Programs. This rate includes overhead costs. The vehicle costs were estimated assuming a distance traveled of 100 miles per day, and a vehicle cost of \$0.505 per mile, the per diem reimbursement rate for San Diego Water Board staff when they use their own cars for State business. This analysis assumes that the dischargers possess basic field monitoring equipment, including meters to measure temperature, conductivity, and pH, and equipment to measure flow in the field. No additional costs were computed for these items. Surface water monitoring costs are summarized in the Table M-4 below. Assuming that a two-person sampling team can collect samples at 5 sites per day, the total cost for one day of sampling would be \$2,291.

²⁷ Health and Safety Code section 15880 (Assembly Bill 411, Statutes of 1997, Chapter 765).

Table M-4. Cost Estimates for Surface Water Monitoring

Expenditure	Cost per Unit
Laboratory Analyses	
Total Coliform	\$40 per sample
Fecal Coliform	\$40 per sample
Enterococci	\$40 per sample
<i>E. Coli</i>	\$40 per sample
Staff Costs	\$180 per hr
Vehicle Costs	\$50.50 per 100 mi

M.8 Reasonable Alternatives to the Proposed Activity

The environmental analysis must include an analysis of reasonable alternatives to the proposed activity.²⁸ The proposed activity is a Basin Plan Amendment to incorporate bacteria TMDLs for the impaired shoreline segments of Baby Beach and Shelter Island Shoreline Park. The purpose of this analysis is to determine if there is an alternative that would feasibly attain the basic objective of the rule or regulation (the proposed activity), but would lessen, avoid, or eliminate any identified impacts. The alternatives analyzed include taking no action and modifying water quality standards. The alternatives are discussed in the subsections below.

M.8.1 No Action

Under the “no action” alternative, the San Diego Water Board would not adopt the proposed TMDL Basin Plan amendment, and bacteria loading would likely continue at current levels. The “no action” alternative 1) does not comply with the Clean Water Act; 2) is inconsistent with the mission of the San Diego Water Board; and 3) does not meet the purpose of the proposed TMDL Basin Plan Amendment. Under Clean Water Act section 303(d), the San Diego Water Board is obligated to adopt a TMDL project for waters that do not meet water quality standards.²⁹ Therefore the “no action” alternative is not viable and cannot be considered an acceptable alternative.

M.8.2 Water Quality Standards Action

Another alternative to adopting the TMDL Basin Plan amendment is the modification of water quality standards. If the applicable standards are not appropriate, a plausible regulatory response may be to correct the standards through mechanisms such as a use attainability analysis (UAA) or a site-specific objective (SSO). If the REC-1 beneficial use has been improperly designated for any of the shoreline segments included in this project, or if SSOs for total coliform, fecal coliform, and *Enterococcus* would be less stringent than what is reported in the Ocean Plans and Basin Plan, the TMDLs might not be necessary, or the required pollutant load reductions might be

²⁸ California Code of Regulations Title 23 section 3777

²⁹ Water quality standards are comprised of designated beneficial uses, the applicable numeric and/or narrative WQOs to protect those uses, and the SWRCB’s anti-degradation policy provisions (Resolution No. 68-16, *Statement of Policy with Respect to Maintaining High Quality of Waters in California*).

lower. This alternative might lessen or eliminate the adverse impacts associated with constructing structural controls by eliminating the need for structural controls or reducing the number of structural controls necessary. This alternative should not be construed as implying that standards may be changed as a convenient means of “restoring” waterbodies. To the contrary, federal and state law contain numerous detailed requirements that in many cases would prevent modifications of the standards, especially if modifications would result in less stringent waste discharge requirements. However, modification of standards may be appropriate to make uses more specific, to manage conflicting uses, to address site-specific conditions, and for other such reasons.³⁰

As a first step in developing TMDLs, the San Diego Water Board confirmed the impairment status of the shoreline segments and determined, from the available evidence, that bacteria densities exceeded water quality objectives that support the REC-1 beneficial use. At this time, the San Diego Water Board has no evidence that the REC-1 beneficial use was inappropriately designated for the shoreline segments. Therefore based on the available information, an action to de-designate these beneficial uses may be harmful to the environment, and this option is not preferred.

Developing SSOs for total coliform, fecal coliform, and *Enterococcus* may be appropriate at specific sites if epidemiology or other scientific studies demonstrate that less stringent water quality objectives would still be protective of human health, or if better indicator(s) are identified. SSOs should be (1) based on sound scientific rationale; (2) protective of the designated beneficial uses of the beaches and creeks; and (3) adopted by the San Diego Water Board in a Basin Plan amendment.

There are no efforts currently underway or planned by interested persons to fund the scientific studies needed to develop SSOs for bacteria at the shoreline segments. Furthermore, the development of SSOs for bacteria at the shoreline segments, including the scientific and epidemiological studies necessary to support them, would be costly, time consuming, and resource intensive.

Even in the event that scientific studies were initiated and SSOs developed and adopted, the need for a TMDL likely would not be eliminated. If SSOs for bacteria were developed in the future and adopted, this TMDL Basin Plan Amendment would be modified accordingly. If interested parties were willing to fund and oversee development of scientific studies to investigate SSOs, the most effective and expeditious means to improve water quality would be to conduct these studies concurrent with actions necessary to achieve compliance with the current TMDL.

M.8.3 Preferred Alternative

Because the alternatives discussed above are not expected to attain the basic objective of the proposed activity at this point in time, the preferred alternative is the proposed activity itself, which is the Basin Plan amendment incorporating the bacteria TMDLs.

³⁰ SWRCB. 2005. *A Process for Addressing Impaired Waters in California*, June 2005

M.9 Preliminary Staff CEQA Determination

The implementation of these TMDLs will result in improved water quality in the San Diego region, but it may result in temporary or permanent localized significant adverse impacts to the environment. Specific projects employed to implement the TMDLs may have significant impacts, but these impacts are expected to be limited, short-term, or may be mitigated through careful design and scheduling. The Technical Report, the draft Basin Plan amendment, and the Environmental Checklist and associated analysis provide the necessary information pursuant to state law³¹ to conclude that properly designed and implemented structural or non-structural methods of compliance will not have a significant adverse effect on the environment, and all agencies responsible for implementing the TMDLs should ensure that their projects are properly designed and implemented. Any of the potential impacts need to be mitigated at a subsequent project level because they involve specific sites and designs not specified or specifically required by the Basin Plan amendment to implement the TMDLs. At this stage, any more particularized conclusions would be speculative.

Specific projects that may have a significant impact would be subject to a separate environmental review. The lead agency for subsequent projects would be obligated to mitigate any impacts they identify, for example, by mitigating potential flooding impacts by designing the structural controls with adequate margins of safety.

Furthermore, implementation of the TMDLs is both necessary and beneficial. If at some time, it is determined that the alternatives, mitigation measures, or both, are not deemed feasible by those local agencies, the necessity of implementing the federally required TMDLs and removing the indicator impairment from the San Diego Region (an action required to achieve the express, national policy of the Clean Water Act) remains.

The benefits of meeting water quality standards to achieve the expressed, national policy of the Clean Water Act far outweigh the potential adverse environmental impacts that may be associated with the projects undertaken by persons responsible for reducing discharges of bacteria to beaches and creeks of the San Diego Region. Meeting water quality standards and the national policy of the Clean Water Act is a benefit to the people of the state because of their paramount interest in the conservation, control, and utilization of the water resources of the state for beneficial use and enjoyment (Water Code section 13000). Furthermore, the health, safety and welfare of the people of the state requires that the state be prepared to exercise its full power and jurisdiction to protect the quality of waters in the state from degradation, particularly including degradation that unreasonably impairs the water quality necessary for beneficial uses.

Water quality that supports the beneficial uses of water are necessary for the survival and well being of people, plants, and animals. Water contact recreational use (REC-1) is a beneficial uses of water that serve to promote the social and environmental goals of

³¹ Public Resources Code, section 21159

the people of the San Diego Region and require water quality suitable for the protection of human health, aquatic life and aquatic dependent wildlife.

In addition, implementation of the TMDLs will have substantial benefits to water quality and will enhance beneficial uses. Enhancement of the REC-1 beneficial use will have positive, indirect social and economic effects by increasing the natural habitat and aesthetic value of the shoreline segments. These substantial benefits outweigh any unavoidable temporary adverse environmental effects.

In accordance with state law,³² the San Diego Water Board finds that, although the proposed project could have significant effect on the environment, revisions in the project to avoid or substantially lessen the impacts, can and should be made or agreed to by the project proponents. This finding is supported by the evidence provided in the impact evaluation section of this document, which indicates that all foreseeable impacts are either short-term or can be readily mitigated.

On the basis of the initial environmental review checklist and analysis, and Technical Report for this Basin Plan amendment, which collectively provide the required information:

- The proposed project COULD NOT have a significant effect on the environment, and, therefore, no alternatives or mitigation measures are proposed.
- The proposed project MAY have a significant or potentially significant effect on the environment, and therefore alternatives and mitigation measures have been evaluated.

Signature

Date

Printed Name

For

³² Public Resources Code section 15091