



**Document in Support of August 12, 2009 RWQCB Meeting Agenda Item 11:
Information Item: Mission Valley Terminal Cleanup Status Report**

Submitted by LFR, Inc. on behalf of Kinder Morgan Energy Partners
August 5, 2009

EXECUTIVE SUMMARY

Groundwater Remediation

The clean-up goal for off-Terminal groundwater remediation is for concentrations of the chemicals of concern (COCs) to be at or below maximum contaminant levels (MCLs) no later than December 31, 2013. These clean-up goals are documented in the off-Terminal corrective action plan (CAP) (LFR 2005a). Groundwater remediation is being achieved through groundwater extraction and treatment. The treated groundwater is discharged under permit to Murphy Canyon Creek, which is a tributary to the San Diego River.

Groundwater remediation activities have reduced the off-Terminal MTBE mass in groundwater by over 99 percent since 2002. The mass of TBA, a biodegradation product of MTBE, has been reduced by approximately 72 percent since its peak in 2005.

The groundwater extraction system continues to operate efficiently and to meet remedial objectives. Overall, MTBE and TBA concentrations continue to decrease with time. Multiple lines of evidence indicate that groundwater cleanup goals will be achieved by the CAO deadline of December 31, 2013.

Soil Remediation

The clean-up goal for off-Terminal soil affected by residual petroleum hydrocarbon liquids (LNAPL) is for the LNAPL to be removed to the extent technically practicable by December 31, 2010. This goal is documented in the off-Terminal CAP.

Off-Terminal soil remediation is being achieved by soil vapor extraction (SVE) and bioventing with groundwater table suppression. In addition, hydraulic containment is being maintained at multiple locations to provide a barrier to migration of dissolved-phase petroleum hydrocarbons from the on-Terminal residual LNAPL zone into the off-Terminal area, and from the off-Terminal residual LNAPL zone to downgradient locations.

Significant soil cleanup has already occurred in the off-Terminal area. Periodic soil sampling indicates that remediation is successfully reducing the concentration of COCs to levels that will be protective of groundwater quality within the Mission Valley aquifer. Multiple lines of evidence indicate that the soil cleanup criteria will be achieved by the CAO deadline for the LNAPL-affected area characterized at the time the CAO was written. The remediation system for a previously

undiscovered area of LNAPL-affected soil is currently in the design phase, and is expected to be completed concurrent with the CAO groundwater cleanup deadline of December 31, 2013.

Reinjection of Treated Groundwater

Reinjection of treated groundwater was evaluated and then rejected as part of the off-Terminal Groundwater remediation system design. The City of San Diego has recently suggested that reinjection of oxygen-enriched treated groundwater be further considered as a means of enhancing the rate of in-situ biodegradation and reducing the “wasting” of groundwater.

No “wasting” of water. Rather than “wasting” groundwater as alleged, the current groundwater extraction system is temporarily intercepting a portion of the groundwater that would otherwise naturally discharge to the San Diego River. This groundwater is extracted, treated, and discharged to Murphy Canyon Creek, where it returns to its natural point of discharge, which is the San Diego River. There is no long-term reduction in the annual available groundwater supply due to remedial extraction. Groundwater conditions will recover to the pre-pumping natural conditions within approximately six months to one year after remedial pumping ceases.

No improvement of beneficial use. Treated groundwater remains high in total dissolved solids as there is no appreciable reduction of these naturally occurring minerals during remedial treatment. Injection of this water into the aquifer would not improve the naturally high mineral content of the groundwater basin, which is unsuitable for potable purposes without demineralization.

The risks outweigh the potential benefits. The potential risks of reinjecting treated groundwater outweigh the potential benefits. There is a high potential risk of chemical encrustation of the aquifer as a result of the naturally high mineral content of the groundwater, the treatment-induced geochemical changes, and the potential effects of geochemical interactions leading to mineral and biological fouling after injection. Precipitate formation, scale buildup, and biofouling are all experienced within the Site’s extraction, treatment, and discharge system.

No loss of beneficial use to Mission Valley Aquifer. The groundwater that is extracted and treated for the purposes of remediation is available for use by the City of San Diego. Rather than discharging treated groundwater to the San Diego River, this water has been offered to the City for its beneficial use. Use of this groundwater for potable purposes would require demineralization to reduce the naturally high mineral content.

A reliable means of discharging treated groundwater is essential to the ongoing reliability of both the on-Terminal and off-Terminal hydraulic containment barriers. Significant disruptions in the ability to discharge treated water, as would likely occur with reinjection, could compromise our ability to maintain the effectiveness of these barriers.

Enhanced Aerobic Biodegradation Has No Clear benefit

The City has suggested that reinjection of oxygen-enriched treated groundwater is needed to ensure timely cleanup of the aquifer. The existing groundwater remedy shows steady, acceptable cleanup progress and the groundwater is on track to meet the cleanup deadline. The existing network of extraction wells is inducing additional subsurface biodegradation, as outlying groundwater containing naturally-occurring oxygen, nitrate, and sulfate is mixed into the existing plume. Moreover, the City's assumption that injection of oxygen-enriched water would have significant benefits on the rate of biodegradation is not supported by the results of site-specific studies of biodegradation, which indicate no significant difference between the aerobic and anaerobic biodegradation rates for TBA (LFR, 2007a), the primary remaining chemical of concern in the distal plume area.

1.0 NATURE OF PROBLEM, CONTAMINANTS AND EXTENT. STRATEGY: PROPERTY BOUNDARY CONTAINMENT, OFF-TERMINAL CLEANUP.

1.1 Site Description

The Site is divided into two areas for discussion purposes: the on-Terminal area, and the off-Terminal area. The on-Terminal area is a 10.5-acre aboveground storage tank facility located in Murphy Canyon, which is oriented north/south and opens into the larger Mission Valley at its southern end. Murphy Canyon and Mission Valley are at the bottom of steep slopes from the surrounding mesa as shown on Figures 1 and 2.

Groundwater flows from the on-Terminal area downgradient toward the off-Terminal area, which is south of San Diego Mission Road and includes Qualcomm Stadium, the stadium parking lot, and areas near the San Diego River south and west of the stadium.

The Terminal has been in operation since 1962 and is owned by SFPP, L.P., an operating partnership of Kinder Morgan Energy Partners, L.P. Portions of the Site have historically been leased to Texaco, Shell, ExxonMobil, and CENCO-Powerine. Petroleum products are delivered to the Terminal through a pipeline that receives product from the Los Angeles Basin. Petroleum products currently or historically stored at the Terminal include leaded and unleaded gasoline, gasoline additives, jet fuel, diesel, ethanol, and transmix (i.e., a mixture of the various refined petroleum products). At various locations over time, petroleum hydrocarbons have historically been released within the Terminal area and have migrated as light non-aqueous phase liquid (LNAPL, commonly termed “free product”) in the subsurface to downgradient off-Terminal areas directly south of San Diego Mission Road to the northeast stadium parking lot. Dissolved petroleum chemicals have migrated further south and west to downgradient areas in the vicinity of the stadium and the San Diego River.

Residual LNAPL is present from the manifold area within the Terminal and extends in a relatively narrow band south into the northern parking area of the stadium, and from the current Shell area into the northern parking area of the stadium.

The area of residual LNAPL in soil located south and southwest of the Terminal’s southern boundary is referred to as the off-Terminal LNAPL zone. This area is depicted on attached figures as the area bounded by the red line indicating “Current Estimated Extent of Residual LNAPL”. The term “residual” is used to indicate that the LNAPL is held within the soil pores and is no longer mobile.

The characterization and remediation of groundwater contamination at the Terminal has been ongoing since the late 1980s. The most recent site conceptual model (SCM) was published in the on- and off-Terminal site conceptual model and corrective action plan reports in 2005. A site conceptual model is a summary of the current state of knowledge regarding the sources of contamination, the pathways of migration of the contamination, and the receptors (i.e., humans or other biota) that may

be potentially exposed to the contamination. Data collected through mid-2008 augmented but did not substantially revise the SCM.

In the third quarter of 2008, data that were inconsistent with the then-current SCM were identified in an area west along San Diego Mission Road toward its intersection with Mission Village Drive. Investigation conducted in this area through the second quarter of 2009 has characterized an unexpected and previously-unidentified area of LNAPL-affected soil. Based on an evaluation of available data from groundwater monitoring wells in the area, Kinder Morgan and LFR do not believe that the newly discovered LNAPL-affected soil is contributing to groundwater contamination. In the event that the LNAPL-affected soil in this area were a contributing source to groundwater, the area is hydraulically contained and captured by the existing groundwater extraction system, which prevents any potential migration of groundwater away from the source area. Additionally, LFR is in the process of installing two new groundwater monitoring wells to further verify the groundwater quality underlying the recently discovered LNAPL-affected soil.

1.2 Groundwater Remediation

Clean-up goals for off-Terminal groundwater remediation, as presented in the off-Terminal CAP, are that the chemicals of concern¹ (COCs) are to be at or below their primary and/or secondary maximum contaminant level (MCL) no later than December 31, 2013.

Remediation of on-Terminal and off-Terminal petroleum constituents in groundwater is being achieved through the following measures, as detailed in the site conceptual models and corrective action plans for the on-Terminal and off-Terminal areas (LFR 2005a, 2005b) and the Evaluation of Remedial Progress in the Off-Terminal LNAPL Zone (LFR 2007b):

- hydraulic containment of on-Terminal dissolved-phase petroleum constituents
- hydraulic containment of off-Terminal dissolved-phase petroleum constituents
- hydraulic extraction of the distal dissolved-phase groundwater plume combined with monitored natural attenuation

Hydraulic containment of on-Terminal and off-Terminal dissolved-phase petroleum constituents is being achieved through operation of the on-Terminal hydraulic barrier groundwater extraction (GWE) wells (i.e., RW-35 through RW-37) and the off-Terminal hydraulic barrier wells (i.e., RW-3A, RW-5A, RW-7A, RW-48, and RW-56), respectively. The groundwater extraction well network has undergone multiple expansions over time.

GWE wells RW-35 through RW-37 serve as the property line hydraulic containment barrier to prevent dissolved contaminants or LNAPL from migrating beyond the limits of the Terminal

¹ benzene, toluene, ethylbenzene, and total xylenes (BTEX), methyl tertiary-butyl ether (MTBE), tertiary butyl alcohol (TBA), and ethylene dibromide (EDB)

property. Multiple lines of evidence indicate that the property boundary wells are effectively preventing off-Terminal migration of dissolved contaminants and LNAPL². Wells RW-35 and RW-36 are also part of the dewatering system for the lower portion of the LNAPL-affected zone in the off-Terminal area, which contributes to the groundwater table suppression goals to enhance Soil Vapor Extraction (SVE).

GWE wells RW-3A, RW-5A, RW-7A, RW-48, and RW-56 also serve as dewatering wells to expose the full vertical extent of off-Terminal residual LNAPL-affected soils to remediation by SVE. Details of remedial efforts targeted at the LNAPL zone are included in the Quarterly Remedial Progress Monitoring Report, Second Quarter of 2009. A new groundwater well (RW-107) has been constructed in the off-Terminal area for more efficient dewatering in the western portion of the residual LNAPL zone. The infrastructure design to facilitate integration with the existing groundwater extraction and treatment system (GWETS) is ongoing.

GWE wells RW-8, RW-9, RW-49, RW-50, RW-51, RW-99, RW-100, and RW-101 exert hydraulic control and extract contaminant mass from the distal portion of the groundwater plume. The latter six of these wells commenced pumping during the second quarter of 2009 to accelerate the reduction of the methyl tertiary-butyl ether (MTBE) and tertiary butyl alcohol (TBA) dissolved in groundwater.

1.3 Soil Remediation

The clean-up goal for the off-Terminal LNAPL zone, as presented in the off-Terminal CAP, is that LNAPL be removed to the extent technically practicable by December 31, 2010.

Off-Terminal soil remediation is being achieved through the following measures:

- soil vapor extraction (SVE) and bioventing with groundwater table suppression in the off-Terminal LNAPL zone
- hydraulic containment as a barrier to migration of dissolved-phase petroleum hydrocarbons from either the on-Terminal residual LNAPL zone into the off-Terminal area or from the off-Terminal residual LNAPL zone to downgradient locations.

The off-Terminal SVE system consists of 172 discrete vapor extraction wells at 92 locations (77 dual-nested SVE wells, 24 single-nested wells, and 4 combination SVE/groundwater extraction [GWE] wells) (Figure 2). The on-Terminal SVE system consists of four SVE wells (one single-nested SVE well and three combination SVE/GWE wells). The vapors that are extracted by the SVE wells are connected to a treatment system with a maximum capacity of 3,000 standard cubic feet per minute (scfm), and treated by a regenerative thermal oxidizer. The soil vapor extraction and

² These multiple lines of evidence include groundwater contours and flow patterns inferred from groundwater elevation observations and observations of reduced concentrations of COCs in groundwater in the off-Terminal area near the hydraulic barrier.

treatment system (SVETS) is operated in accordance with the County of San Diego Air Pollution Control District (APCD) Startup Authorization No. 986337.

Groundwater table suppression is achieved through groundwater extraction in the vicinity of the off-Terminal LNAPL zone. There are 16 GWE wells located in the on-Terminal and off-Terminal areas. Eight of these wells directly contribute to dewatering the off-Terminal LNAPL zone. Extracted groundwater is treated and discharged to nearby surface waters at a maximum permitted discharge flow rate of 350 gallons per minute (gpm) in accordance with National Pollutant Discharge Elimination System (NPDES) discharge permit R9-2008-0002.

A network of soil vapor monitoring (SVM) probes are installed throughout the off-Terminal LNAPL zone to collect data for evaluation of remedial performance and progress. The SVM probe network currently consists of 144 discrete SVM probes in 51 probe clusters in the off-Terminal area. Each probe cluster consists of three to five depth-discrete probes spaced vertically across the vertical extent of the LNAPL zone and the overlying vadose zone.

2.0 REMEDIATION STATUS

2.1 Groundwater Cleanup Progress

Significant groundwater cleanup has already occurred in the off-Terminal area. As a result of remediation, the mass of MTBE present in the off-Terminal portion of the groundwater plume in May 2009 has decreased by over 99 percent since May 2002 (Figures 3 and 4). The mass of TBA in the off-Terminal plume in May 2009 has decreased by approximately 72 percent since November 2005³ (Figures 5 and 6). MTBE and TBA mass reduction is partially a result of extraction of affected groundwater with the remaining, and significant, portion of the mass reduction attributable to in-situ biodegradation (natural attenuation).

The groundwater extraction system has continued to operate efficiently and meet remedial objectives. Six new groundwater extraction wells (RW-49 through RW-51 and RW-99 through RW-101), positioned along the core of the distal part of the dissolved-phase plume, were brought online at the start of this quarter, and were sampled for laboratory analysis during the quarter. MTBE and TBA are the only chemicals of concern detected at these new groundwater extraction wells.

MTBE and TBA concentration trends, MTBE and TBA biodegradation, and geochemical parameters of natural attenuation continue to indicate that overall MTBE and TBA concentrations are decreasing with time. Geochemically, the MTBE and TBA plume coincides with groundwater that has become less aerobic/more anaerobic by historical contact with LNAPL-affected soils. These lines of

³ MTBE and TBA mass reductions are each calculated from the year of peak apparent dissolved mass. The estimated reduction in TBA mass is more uncertain than the MTBE mass reduction due to a less extensive monitoring period, higher detection limit, and recent TBA concentrations observed in newly installed distal extraction wells.

evidence, along with previous microcosm and isotope studies, continue to indicate that natural attenuation, including biodegradation, is reducing concentrations in the MTBE and TBA plumes. Groundwater extraction is also effectively reducing concentrations of MTBE and TBA over time. Current and historical concentration trends in combination with groundwater modeling indicate that the groundwater cleanup goals will be achieved by the CAO deadline of December 31, 2013.

2.2 Soil Cleanup Progress

Multiple lines of evidence indicate that sufficient progress is occurring in the off-Terminal LNAPL zone towards achieving the cleanup criteria. Performance metrics include the tracking of changes occurring in the: (1) concentrations of total volatile organic chemicals (VOCs); (2) concentrations of the most volatile hydrocarbon fraction (lighter than C₈ hydrocarbons [$<C_8$ HC]); (3) SVE mass extraction rates; (4) biodegradation rates; (5) overall hydrocarbon composition trends; and (6) declining concentration trends in the leachability of COCs from soil. Contour maps comparing current and past status of total VOCs and $<C_8$ HC are shown in Figures 7 through 10. Additional details on these performance metrics are presented in the quarterly remedial progress report (LFR 2009).

Evaluation of compositional trends indicates that on the whole there is sufficient progress toward remedial clean-up goals across the off-Terminal LNAPL-affected area that was characterized when the CAO was written. A map illustrating the current status of compositional trends is shown on Figure 11. A significantly smaller area of previously undiscovered LNAPL-affected soil was recently discovered in late 2008 and subsequently characterized during the first and second quarters of 2009 (Figure 2).

Results of periodic soil sampling conducted in February and April 2009 indicate that there have been significant reductions in the concentration of total petroleum hydrocarbons – gasoline range organics (TPH-GRO) and individual chemicals of concern (COCs) in LNAPL-affected soils and leachate. The leachate results demonstrate that remediation is successfully reducing the concentration of COCs to levels that will be protective of future groundwater quality within the Mission Valley aquifer.

All of the multiple lines of evidence indicate that soil cleanup for the off-Terminal LNAPL-affected area that was characterized when the CAO was written will be achieved, to the extent technically practicable, by December 31, 2010. Remediation system expansion for addressing the more recently characterized LNAPL-affected soil is currently in the design phase and this area is expected to meet the cleanup goals concurrent with the CAO groundwater cleanup deadline of December 31, 2013.

3.0 REINJECTION OF TREATED GROUNDWATER

Reinjection of treated groundwater has been considered as part of the off-Terminal groundwater remediation design. The City of San Diego has recently suggested that reinjection of oxygen-enriched treated groundwater be further considered as a means of enhancing the rate of in-situ

biodegradation and reducing the “wasting” of groundwater. The following summarizes our analysis of the potential effectiveness and feasibility of treated water injection at the site.

3.1 The current Remediation System Is Not Wasting Water.

Rather than “wasting” groundwater as alleged, the current groundwater extraction system is temporarily intercepting a portion of the groundwater that would otherwise naturally discharge to the San Diego River. This groundwater is extracted, treated, and discharged to Murphy Canyon Creek, where it returns to its natural point of discharge, which is the San Diego River.

3.1.1 Groundwater Flow Balance

In any groundwater system, groundwater flows from points of recharge to points of discharge. In this portion of the Mission Valley Aquifer, the ultimate point of discharge is the San Diego River. Figure 12 illustrates the size and position of this site in relation to the valley aquifer as a whole. Groundwater currently extracted by the remediation system would otherwise discharge, under natural conditions, to the reach of the San Diego River downgradient the Site. The extracted and treated groundwater is currently discharged to the San Diego River via Murphy Canyon Creek; therefore, there is no long-term reduction in the annual available groundwater supply due to remedial extraction. Groundwater conditions will recover to the pre-pumping natural groundwater conditions within approximately six months to one year after remedial pumping ceases.

3.1.2 No Loss of Beneficial Use to Mission Valley Aquifer

Groundwater that is extracted and treated for the purposes of remediation is potentially available for use by the City of San Diego. Rather than discharging treated groundwater to the San Diego River, it has been offered to the City for its beneficial use. Use of this groundwater would require demineralization to reduce the naturally high mineral content, as previously noted by the City and by the San Diego County Water Authority.

3.1.3 No Improvement of Beneficial Uses

Treated groundwater remains high in total dissolved solids as there is no appreciable reduction of these naturally occurring minerals during remedial treatment. Injection of this water into the aquifer would not improve the naturally high mineral content of the groundwater basin, which is unsuitable for potable purposes without demineralization.

3.2 The Potential Risks of Reinjecting Treated Groundwater Outweigh the Potential Benefits

3.2.1 Risk of Chemical Encrustation within the Aquifer

Chemical encrustation within the aquifer could potentially plug significant portions of the water bearing zone and reduce the permeability and transport characteristics in affected areas. This could further result in disruption of overall dissolved-phase plume remediation by slowing chemical migration in localized areas. Discussions below on natural mineral content, treatment-induced geochemical changes, and potential effects of geochemical mixing indicate that mineral and biological fouling is a significant potential risk.

3.2.2 Risk of Chemical Encrustation and Biofouling within Injection Well Structure

Expected chemical encrustation and biofouling within the injection well structure would result in continually decreasing well efficiency. While appropriate rehabilitation measures could be performed to counter these effects, the degree of potential fouling is significant and would require near full scale implementation to fully evaluate. As above, discussions below support that this is a significant potential risk.

3.2.3 Potential to Compromise Effectiveness of Existing Hydraulic Containment Barrier

A reliable means of discharging treated groundwater is essential to the ongoing reliability of both the on-Terminal and off-Terminal hydraulic containment barriers. Significant disruptions in the ability to discharge treated water could compromise our ability to maintain the effectiveness of these barriers.

3.2.4 Bases

3.2.4.1 High Mineral Content

The treated water is high in total dissolved solids (TDS) concentrations (typically over 2000 milligrams per liter [mg/L]), similarly high in hardness (typically greater than 900 mg/L, expressed as calcium carbonate equivalents) and high alkalinity (typically over 400 mg/L, expressed as calcium carbonate equivalents). For comparison the secondary MCL for TDS is 500 mg/L, and water with a hardness above 180 mg/L is considered very hard (Water Quality Association 2006). The City of San Diego delivers drinking water with TDS ranging from 460 mg/L to 601 mg/L and hardness ranging from 209 mg/L to 273 mg/L (San Diego 2008).

3.2.4.2 Treatment–System Induced Changes in Water Chemistry

The various treatment processes (oil/water separation, particulate filtration, manganese and iron removal, carbon absorption, denitrification, and oxygenation) do not result in significant changes in the overall TDS, hardness, or alkalinity of the treated groundwater. Iron, manganese and nitrate are removed by the treatment system along with petroleum constituents. Dissolved oxygen is increased; oxidation-reduction potential and pH are shifted during treatment, which also induces changes in mineral equilibrium.

3.2.4.3 High Potential for Continued Mineral Precipitation after Injection

Preliminary geochemical evaluation indicates that the treated groundwater is supersaturated with dissolved minerals such as calcite, aragonite, dolomite, iron oxy-hydroxides, goethite, hematite, manganite, hausmannite, and pyrolusite. Saturation indices greater than zero suggests that water is supersaturated, and minerals will tend to precipitate when shifts in geochemical parameters such as pH and redox conditions take place. Saturation indices for calcium-containing minerals in treated groundwater (i.e., calcite, aragonite and dolomite) were estimated to vary between approximately 0.2 and 0.5. Saturation indices for the iron-containing minerals in treated groundwater (i.e., iron oxy-hydroxides, goethite, and hematite) were estimated to vary between approximately 1.3 and 16.3. Saturation indices for the manganese-containing minerals in treated groundwater (i.e., manganite, hausmannite, and pyrolusite) were estimated to vary between approximately 3.2 and 7.7. The treated water therefore has a general propensity to form solid precipitates upon mixing and equilibration with ambient groundwater.

Additionally, “redox fringe” effects could also result in the precipitation of dissolved metals (e.g., iron) and occurrence of associated biofouling organisms. The redox fringe occurs at the boundary interface between saturated zones depleted of dissolved oxygen and those containing dissolved oxygen; as would be experienced in the injection scenario suggested by the City. This issue would have the highest likelihood of occurring at some distance from the injection well when injected water, high in dissolved oxygen, comes into contact with the dissolved-phase plume boundary and core, which is depleted of dissolved oxygen and is highest in dissolved iron. This effect could result in “systemic plugging through an entire aquifer” (Smith, 1995) in the very zones that depend on groundwater flow for remediation.

3.2.4.4 Operational Experience with the Treatment System

Precipitate formation, scale buildup, and biofouling observed in the Site’s groundwater extraction, treatment, and discharge systems indicates that there is a demonstrated tendency for these to be encountered in treated water reinjection wells.

- The main groundwater conveyance line from the off-Terminal area to the treatment system has required periodic cleaning (hydroflushing) to remove build-up, as shown in Figure 13, that precipitates upon the mixing of untreated groundwater extracted from the various extraction wells.

- Accumulation of mineral precipitates and biofilms is the primary factor in the useful lifetime of the cartridge filters (the initial particulate filter at the treatment system). With the recent (March 2009) addition of southern extraction wells (RW-49, RW-50, RW-51, RW-99, RW-100, RW-101) to the groundwater extraction and treatment system (GWETS), the cartridge filter lifetime has fallen substantially from about one or two weeks to two to three days. This is due to an increase in mineral precipitation, primarily iron, due to the mixing of the geochemically dissimilar waters from the northern and southern portions of the off-Terminal groundwater plume prior to treatment.
- In the absence of high hydrocarbon concentrations in the extracted groundwater, the useful lifetime of the granular activated carbon (GAC) is now limited by mineral precipitation (iron and manganese) which causes a coating and hardening of the GAC. Similar precipitation is shown in Figure 14 on the effluent pipeline from the treatment system.

3.2.4.5 Operational Challenges and Delays Due to Reduction in Injection Well Efficiency

Experience with injection of treated water into aquifers at other sites indicates that scale formation in well screens, well filter materials, and aquifer materials outside of injection wells occurs frequently and is a common challenge in the operation of injection systems. Carbonate scale due to hardness and alkalinity, and iron fouling are common problems encountered at injection wells. Long-term use of injection wells under such geochemical conditions eventually results in permanent formation of scale and solid precipitates in aquifer materials, ultimately causing injection wells to fail to the point that they can no longer be rehabilitated. Furthermore, formation of gas bubbles in well screens, well filter materials, and aquifer materials due to geochemical reactions (e.g., off-gassing) also results in reduction of aquifer permeability and creates significant challenges for long-term use of injection wells. These operational challenges would result in delays to remediation progress and could potentially result in permanent reductions in the permeability and yield of the aquifer.

The chemical characteristics of the treated water make it probable that during re-injection, solid precipitates, colloidal precipitates, and biofilms will form in the pore spaces between soil grains in the formation and plug significant portions the aquifer, thereby reducing the overall transmissivity and storativity of the aquifer. This pore-plugging process could result in zones of reduced permeability that grow over time and alter both the quantity and direction of groundwater flow. These changes could be permanent if the precipitation were to occur at some distance from the injection well, which would render a well rehabilitation maintenance program impracticable. Given that total hardness of the treated water is approximately 900 milligrams per liter (mg/L) and the anticipated hypothetical water injection rate would be 350 gallons per minute (gpm), this hypothetical injection scenario would result in approximately 3,785 pounds per day of precipitate-forming chemicals being injected into the aquifer. This amounts to approximately 100 cubic feet per day (ft³/day), or 36,500 cubic feet per year, of aquifer that could become permanently damaged and unusable due to pore plugging by solid precipitates associated with injection of treated water, assuming the precipitates have a density of 2.7 g/cc and the plugged porosity of the aquifer would be 0.2.

These effects have the potential to reduce the ability to remediate affected portions of the aquifer within the prescribed timeframe of remediation due to reductions in permeability. Lower formation permeability would result in greater remediation timeframes and potentially undesirable changes in local groundwater flow patterns.

Furthermore, these changes would reduce the overall value of the aquifer as a usable resource due to permeability reductions associated with pore plugging. Long-term consequences of reinjection could hinder the ability for some portions of the aquifer to be exploited as a water source.

3.3 The Chosen Groundwater Remedy Relies Primarily on Physical Removal by Pump-and-Treat, Rather Than on Biodegradation

The City has stated that reinjection is needed to ensure timely cleanup of the aquifer. The existing groundwater remedy shows steady, acceptable cleanup progress and groundwater is on track to meet the cleanup deadline. In order to ensure timely completion, the extraction system was recently expanded to include six new distal extraction wells for physical removal of contaminants. By changing the groundwater flow directions within the more distal portion of the plume, and disrupting the historically stable geochemistry of the plume core (which is depleted in oxygen, nitrate, and sulfate, and enriched in methane), some degree of incidental enhanced biodegradation is expected to occur, as groundwater with naturally-occurring oxygen, nitrate, and sulfate is drawn in and mixed into the plume core. Sulfate and nitrate, which are present in significant background concentrations in the groundwater, are both known to participate in TBA biodegradation reactions.

The City's request presumes that the injection of oxygen-enriched water would have significant benefits on the rate of TBA biodegradation. This presumption is not supported by the results of site-specific studies of biodegradation. Site-specific microcosm studies conducted in 2006 and 2007 do not reveal a significant difference between the aerobic and anaerobic biodegradation rates for TBA (LFR 2007a), which is the primary remaining chemical of concern in the distal plume area.

4.0 CERTIFICATION

All engineering information, conclusions, and recommendations in this document have been prepared under the supervision of and reviewed by an LFR Inc. California Professional Engineer.



August 5, 2009

C. Fredrik Ahlers, P.E.
Project Technical Director
Senior Associate Civil Engineer
California Registered Civil Engineer #C 66471

Date



* A professional engineer's and/or professional geologist's certification of conditions comprises a declaration of his or her professional judgment. It does not constitute a warranty or guarantee, expressed or implied, nor does it relieve any other party of its responsibility to abide by contract documents, applicable codes, standards, regulations, and ordinances.

5.0 REFERENCES

- LFR Levine-Fricke (LFR). 2005a. Site Conceptual Model and Off-Terminal Corrective Action Plan, Mission Valley Terminal, San Diego, California. September 8.
- _____. 2005b. Site Conceptual Model and On-Terminal Corrective Action Plan, Mission Valley Terminal, San Diego, California. September 8.
- LFR Inc. (LFR). 2007a. Evaluation of Natural Attenuation of MTBE and TBA in Off-Terminal Groundwater, Mission Valley Terminal, San Diego, California. July 20.
- _____. 2007b. Evaluation of Remedial Progress in the Off-Terminal LNAPL Zone, Mission Valley Terminal, San Diego, California. October 31.
- _____. 2009. Quarterly Vadose Zone Remedial Progress Report, Second Quarter of 2009, Mission Valley Terminal, San Diego, California. July 29.
- San Diego, The City of. 2008. Annual Drinking Water Report.
<http://www.sandiego.gov/water/quality/pdf/waterqual08.pdf>.
- Smith, Stuart A. 1995. Monitoring and Remediation Wells, Problem Prevention, Maintenance, and Rehabilitation.
- Water Quality Association, The. 2006. Water Hardness Classifications.
<http://www.wqa.org/sitelogic.cfm?ID=362>. April 20.

ATTACHMENTS

Figures

1. Site Vicinity
2. Site Plan with Estimated Extent of Residual LNAPL
3. MTBE Isoconcentration Map – May 2002
4. MTBE Isoconcentration Map – May 2009
5. TBA Isoconcentration Map – November 2005
6. TBA Isoconcentration Map – May 2009
7. Average SVM Probe and SVE Well Laboratory Analytical VOC Concentrations – Fourth Quarter 2006
8. Average SVM Probe and SVE Well Laboratory Analytical VOC Concentrations – Second Quarter 2009
9. Average SVM Probe and SVE Well Laboratory Analytical <C8 Concentrations – Fourth Quarter 2006
10. Average SVM Probe and SVE Well Laboratory Analytical <C8 Concentrations – Second Quarter 2009
11. SVE Well and SVM/TSV Probe Grading – June 2009
12. Extent of Site within Mission Valley Aquifer
13. Site Photographs - Fouling on Extracted Water Conveyance
14. Site Photographs - Mineral Fouling on Treated Discharge Pipe

K:\Data\Graphics\10000\10143\2Q\TR2009\2Q09Fig1 Vicinity Map.dwg [Vicinity] 5/8/09 11:46am BARobita XREFS:

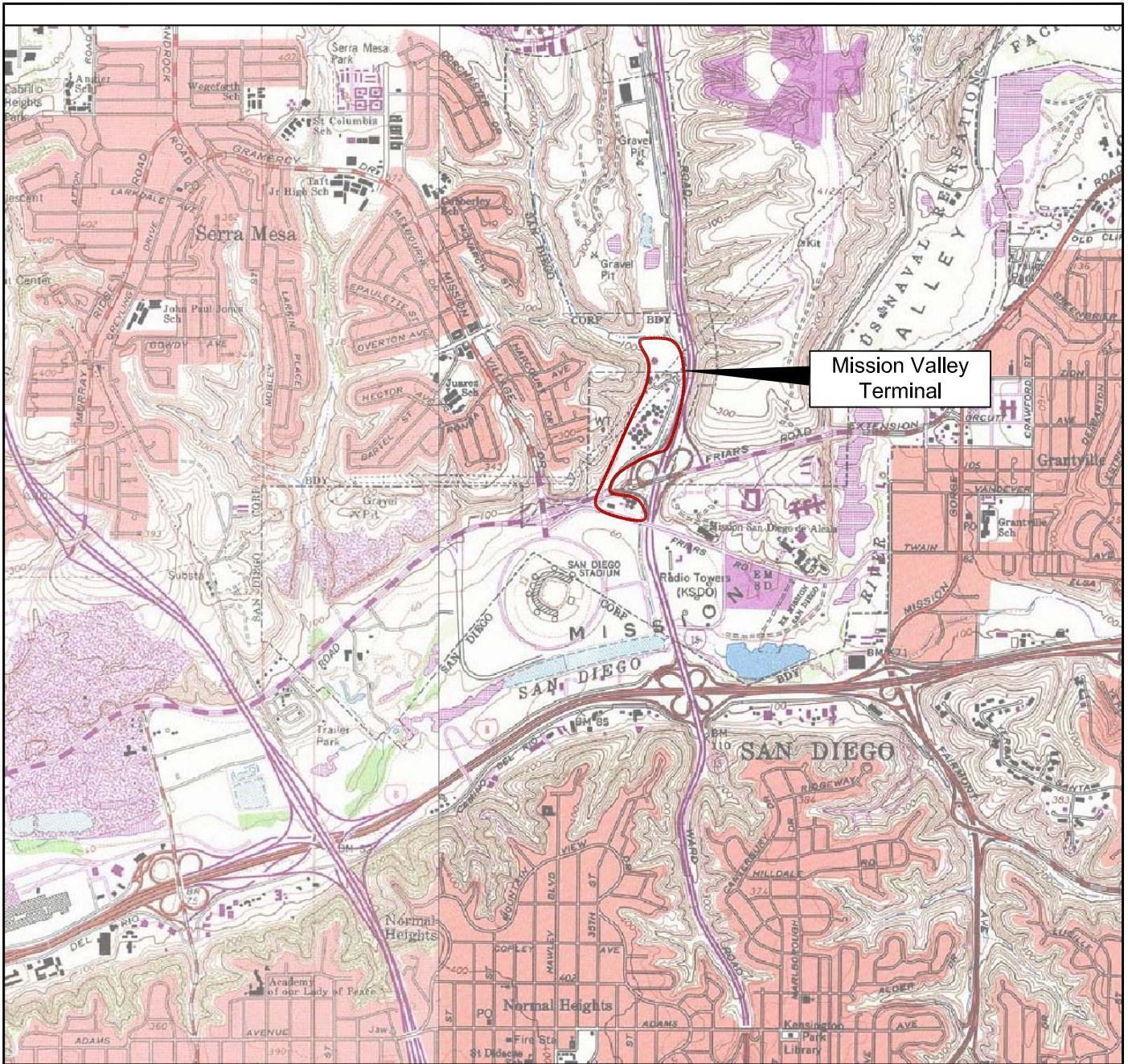

MAP SOURCE: National Geographic Holdings, TOPO! 2001.



0 1,000 2,000 4,000 feet

Vicinity Map

Mission Valley Terminal - 002-10143-32



Figure 1

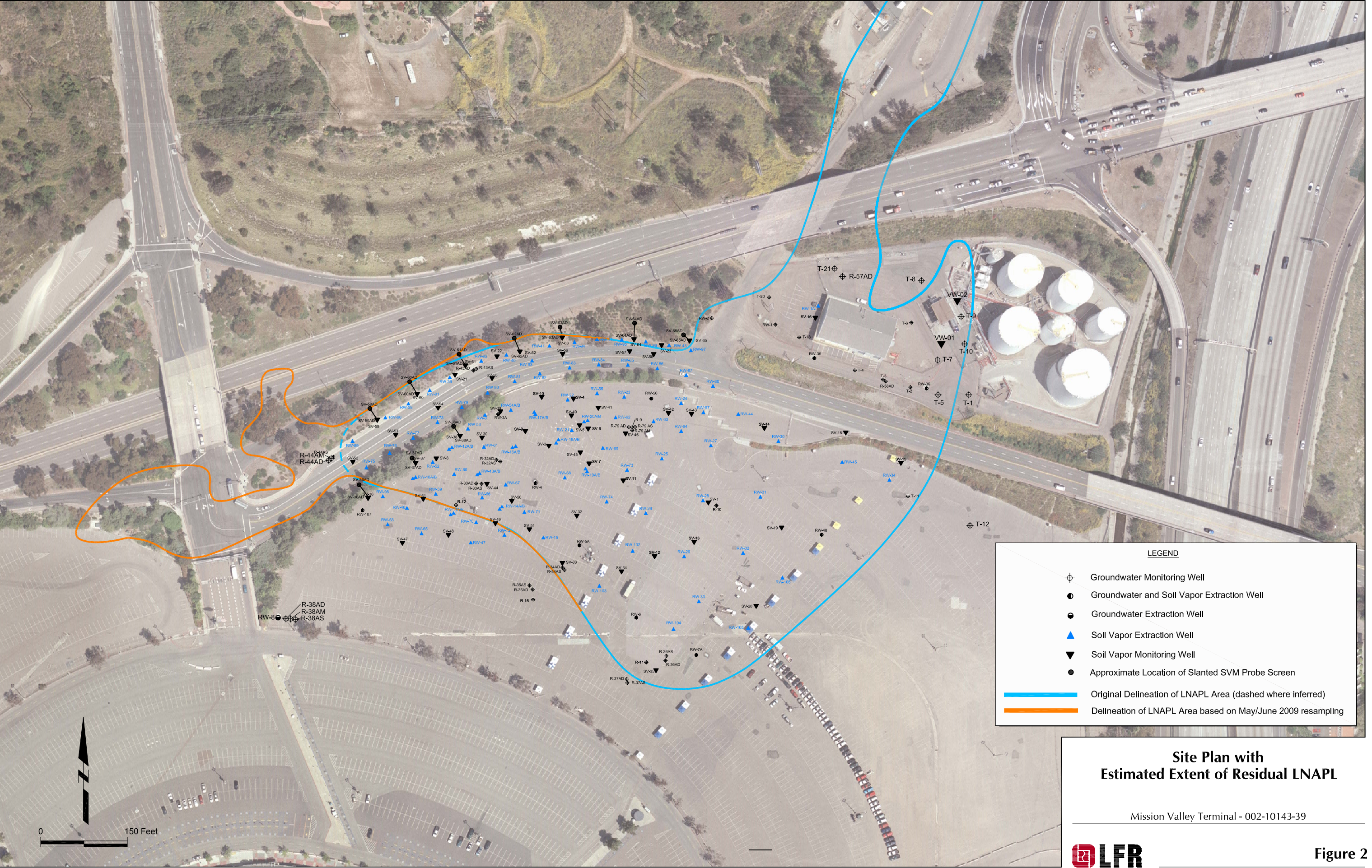

C:\Data\Graphics\1000010143\3910709\10143-39 MTBE May02.dwg [Layout1] 8/4/09 1:47pm BARobbita XREFS: [MVT_BASE_DWG] [MVT_BASE-Aerial.DWG]

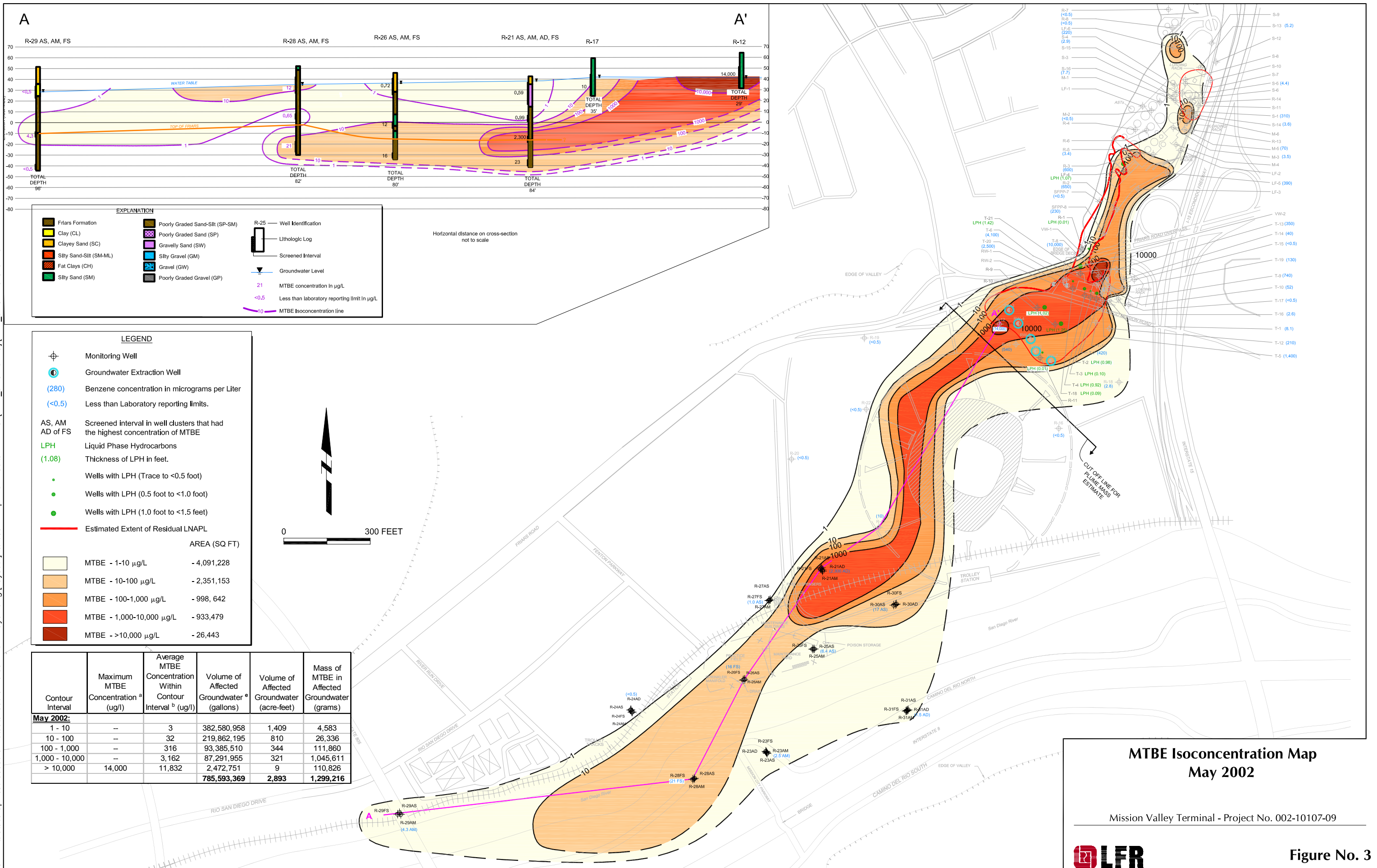

**MTBE Isoconcentration Map
May 2002**

Mission Valley Terminal - Project No. 002-10107-09

LFR

Figure No. 3

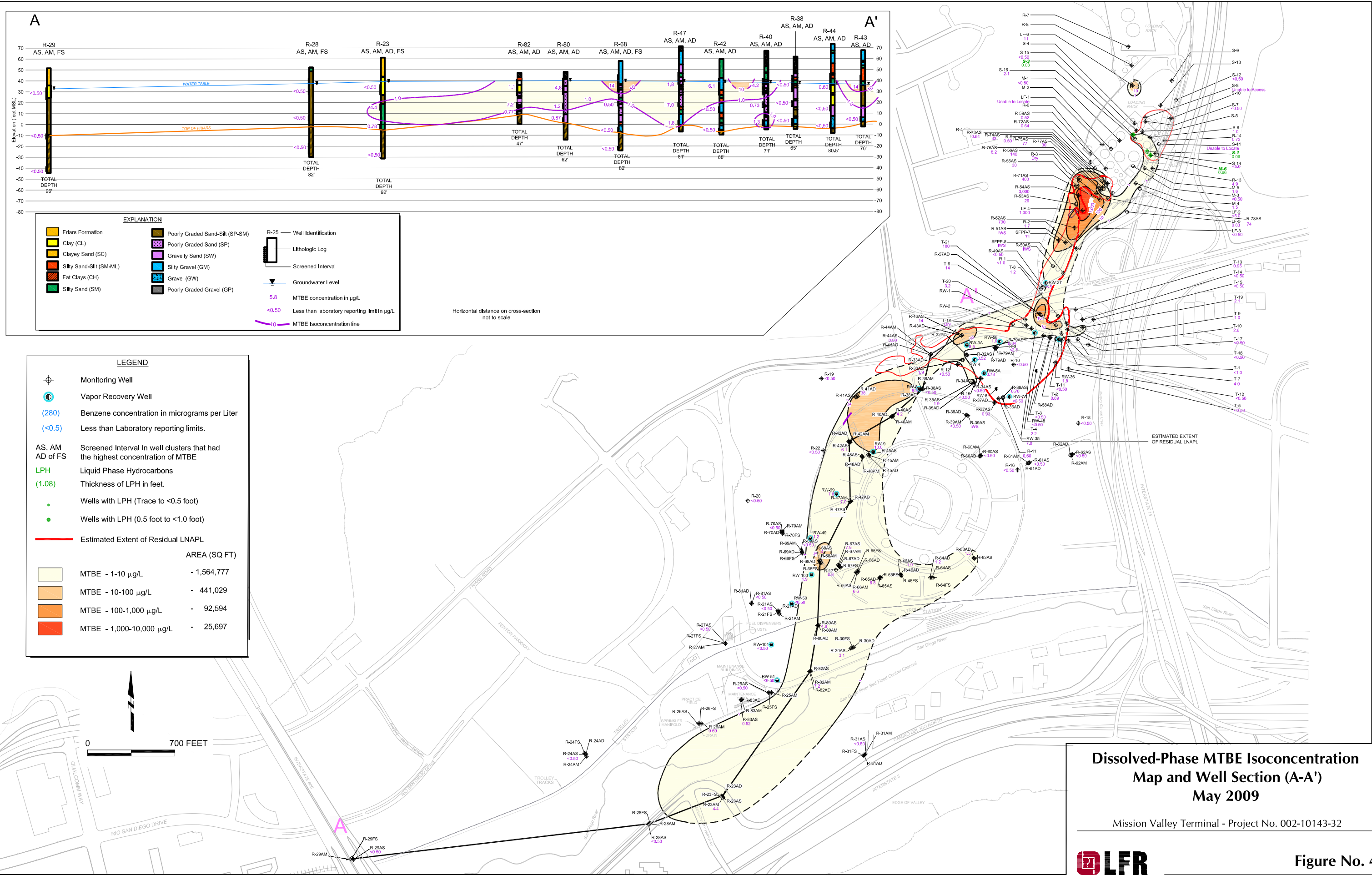

CW: K:\Data\Graphics\1000010143\3910709\10143-39 TBA Nov05.dwg [TAB] 8/4/09 1:49pm BARobita_XREFS: [MVT_BASE4005.DWG] [10180_TerminalBase.dwg]

LEGEND

- Monitoring Well
- Well with Liquid Phase Hydrocarbons
- Groundwater and Soil Vapor Extraction Well
- Groundwater Extraction Well
- 870 TBA concentration in $\mu\text{g/L}$ *
- <0.5 Less than laboratory reporting limit in $\mu\text{g/L}$
- 0.25 Thickness of LPH in feet
- 10 TBA Isoconcentration line (Dashed Where Inferred)
- Estimated Extent of Residual LNAPL

NOTES:

TBA = tertiary butyl alcohol
 $\mu\text{g/l}$ = micrograms per liter

* Posted Data Represent Highest Concentration Observed at Each Monitoring Well Cluster

MTBE - $\mu\text{g/L}$	AREA (SQ FT)
MTBE - 1-10 $\mu\text{g/L}$	-
MTBE - 10-100 $\mu\text{g/L}$	- 1,775,004
MTBE - 100-1,000 $\mu\text{g/L}$	- 1,104,312
MTBE - 1,000-10,000 $\mu\text{g/L}$	- 461,679

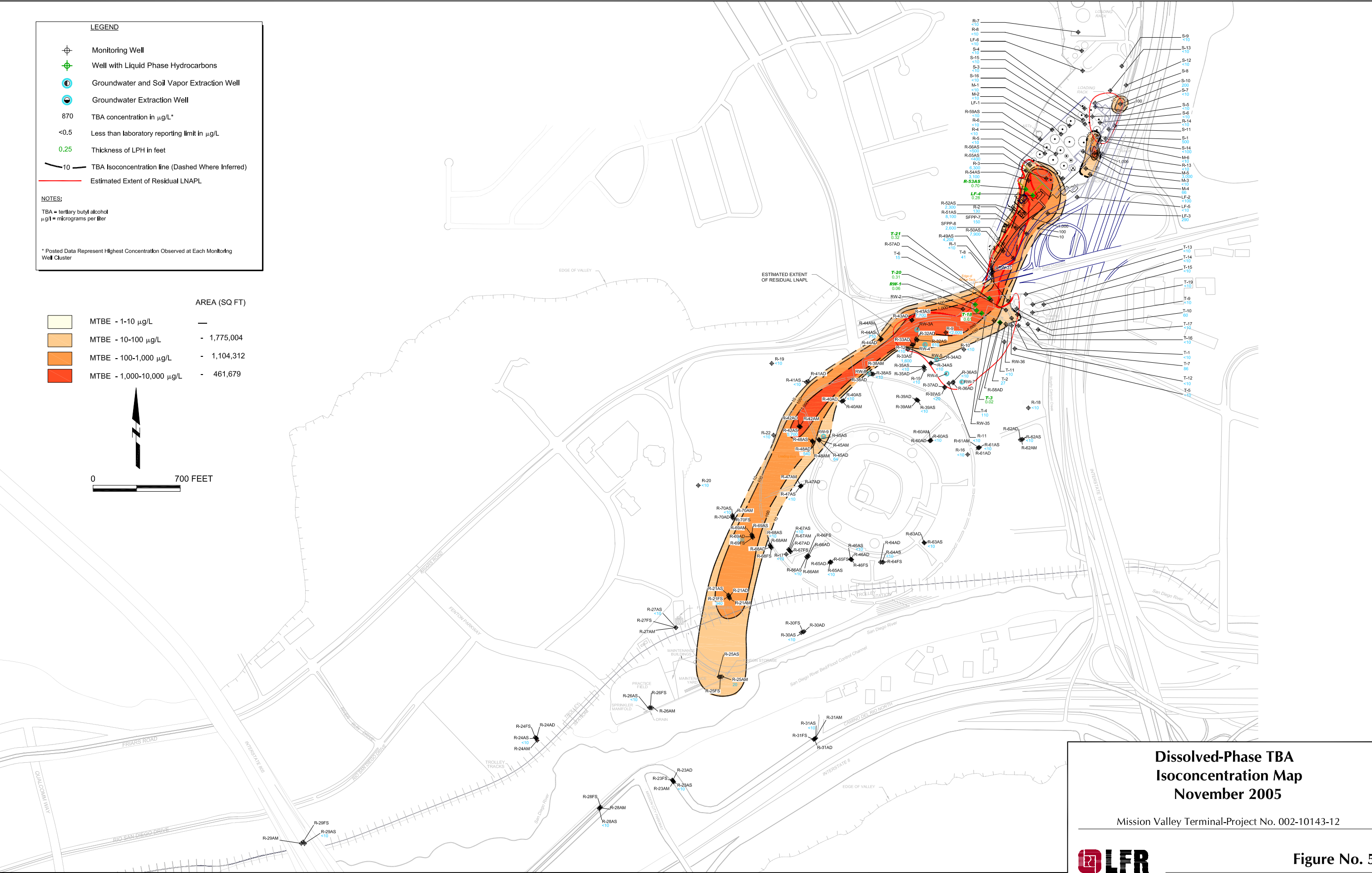
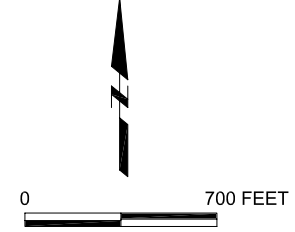

**Dissolved-Phase TBA
 Isoconcentration Map
 November 2005**

Mission Valley Terminal-Project No. 002-10143-12



Figure No. 5

LEGEND

- Monitoring Well
- Well with Liquid Phase Hydrocarbons
- Groundwater and Soil Vapor Extraction Well
- Groundwater Extraction Well
- 160 TBA concentration in $\mu\text{g/L}^*$
- <10 Less than laboratory reporting limit in $\mu\text{g/L}$
- IWS Insufficient Water to Sample
- 0.03 Thickness of LPH in feet
- 10 TBA Isoconcentration line (Dashed Where Inferred)
- Estimated Extent of Residual LNAPL

MTBE - $\mu\text{g/L}$	AREA (SQ FT)
10-100 $\mu\text{g/L}$	- 1,596,573
100-1,000 $\mu\text{g/L}$	- 242,251
1,000-10,000 $\mu\text{g/L}$	- 40,221

NOTES:
 TBA = tertiary butyl alcohol
 $\mu\text{g/l}$ = micrograms per liter

* Posted Data Represent Highest Concentration Observed at Each Monitoring Well Cluster

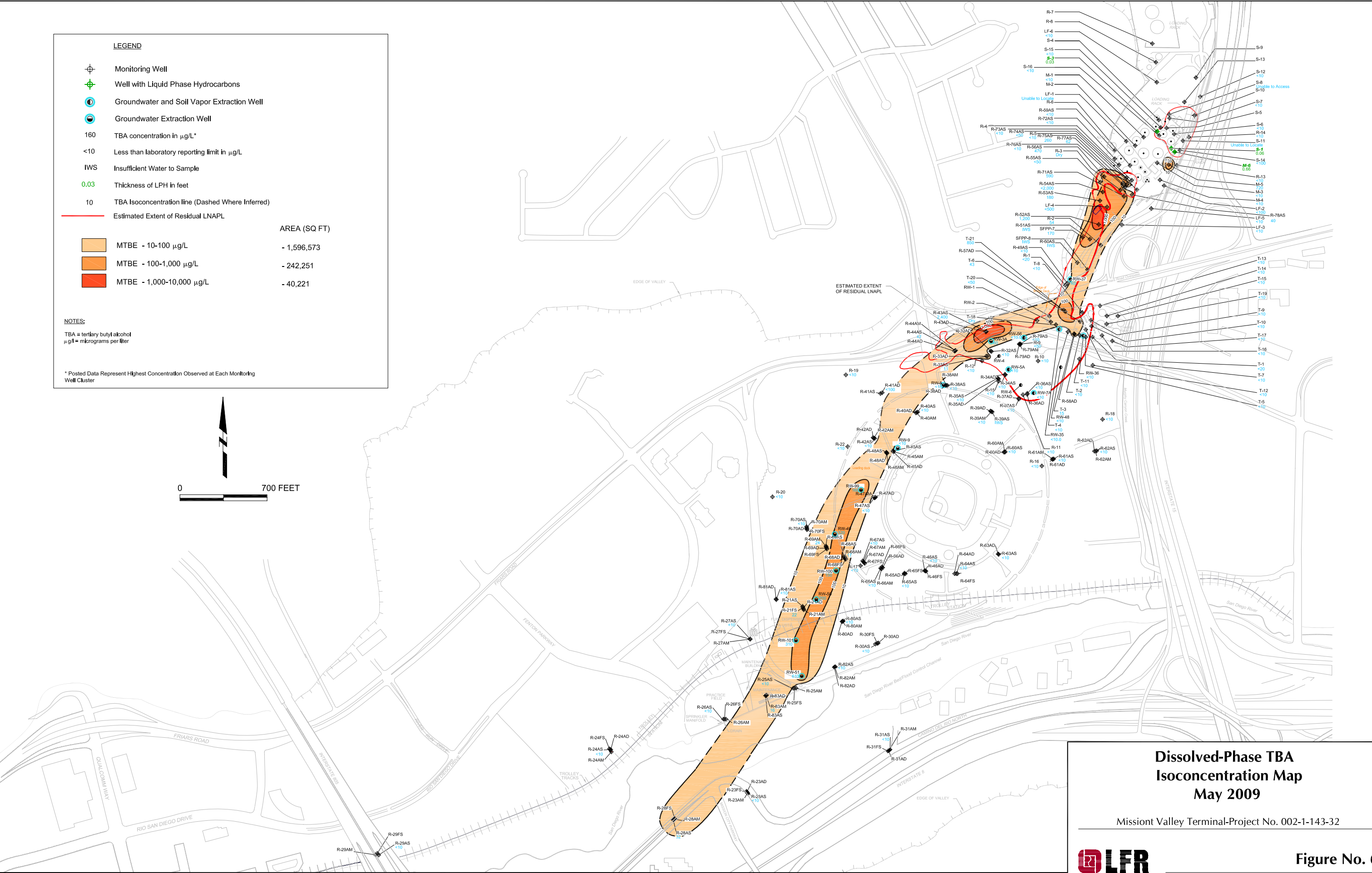
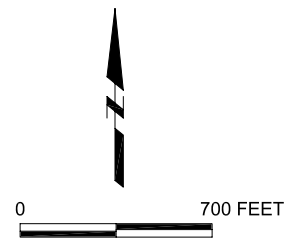

**Dissolved-Phase TBA
 Isoconcentration Map
 May 2009**

Missiott Valley Terminal-Project No. 002-1-143-32

K:\Data\Graphics\100001\10143\39\0709\10143-39_TPH.qd06.dwg [TPH] 8/4/09 2:00pm BARobita XREES: [MVT_BASE\008.DWG] [10180_TerminalBase.dwg] [Residual_LNAPL.dwg] [Residual_LNAPL.dwg] [all_samps_0509.dwg] [MVT_BASE_Aerial.DWG]

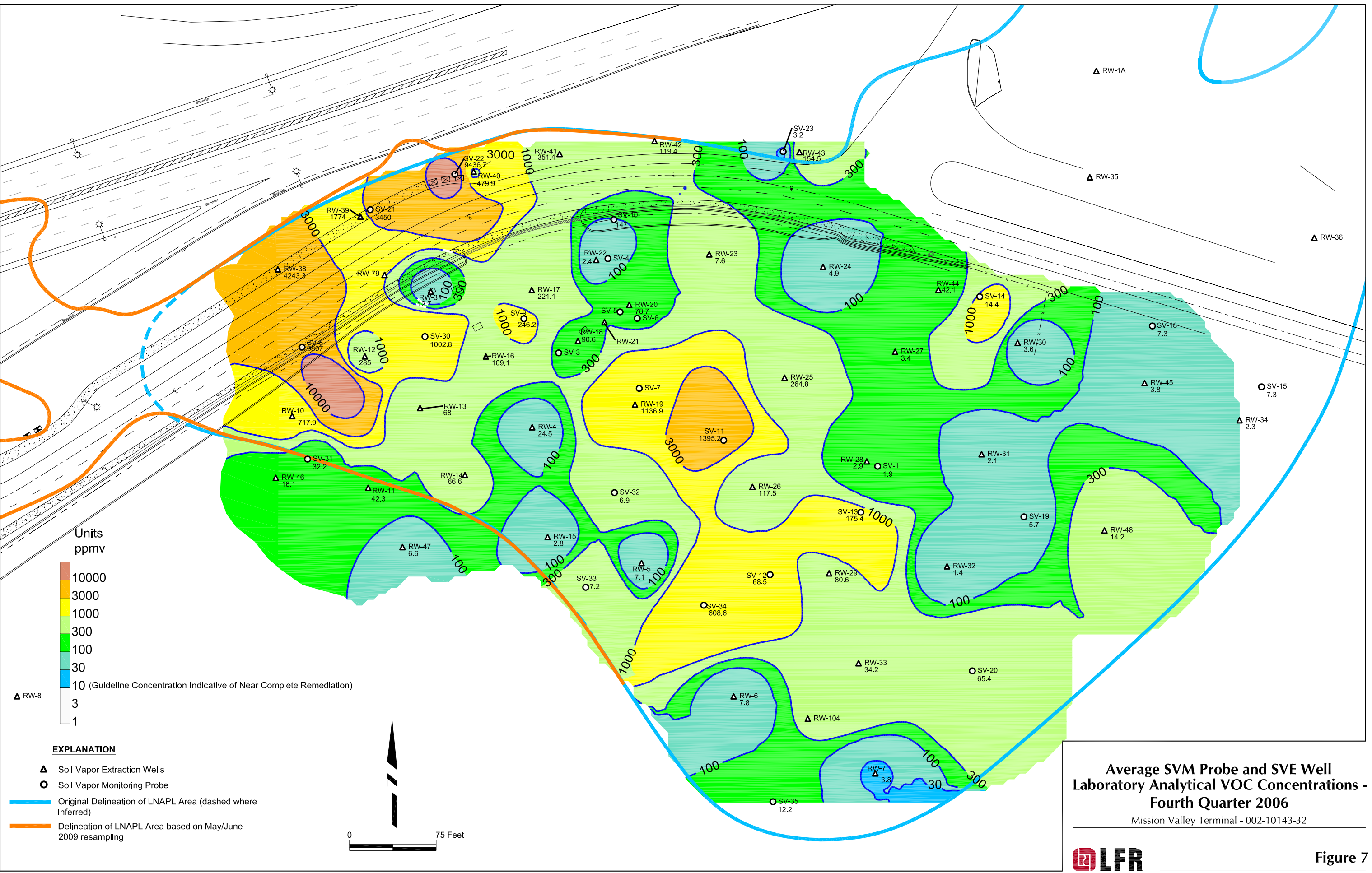
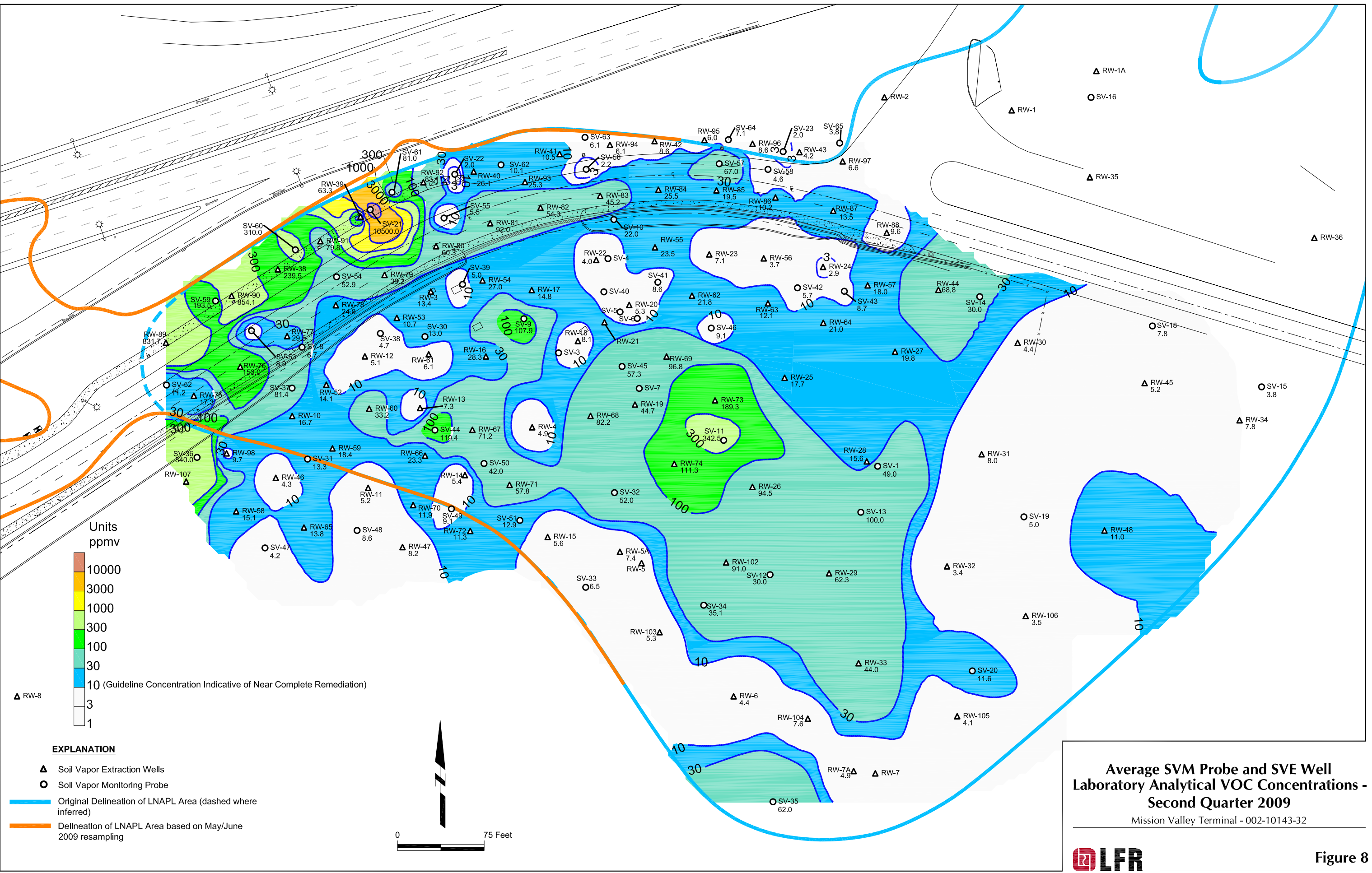

Figure 7

K:\Data\Graphics\1000010143\39\0709\10143-39_TPH.dwg [TPH] 8/4/09 2:05pm BARobin BARobin [10180_TerminalBase.dwg] [Residual_LNAPL.dwg] [Residual_LNAPL.dwg] [all_samps_0609.dwg] [MVT_BASE-Aerial.DWG]



Average SVM Probe and SVE Well Laboratory Analytical VOC Concentrations - Second Quarter 2009
Mission Valley Terminal - 002-10143-32

K:\Data\Graphics\1000010143\39\0709\10143-39_TPH It.c8.qd06.dwg [TPH] 8/4/09 2:07pm BARobita XREES; [MVT_BASE4008.DWG] [10180_TerminalBase.dwg] [Residual_LNAPL.dwg] [DRAIN_PIPE.dwg] [Residual_LNAPL.dwg] [fall_samps 0509.dwg] [MVT_BASE-Aerial.DWG]

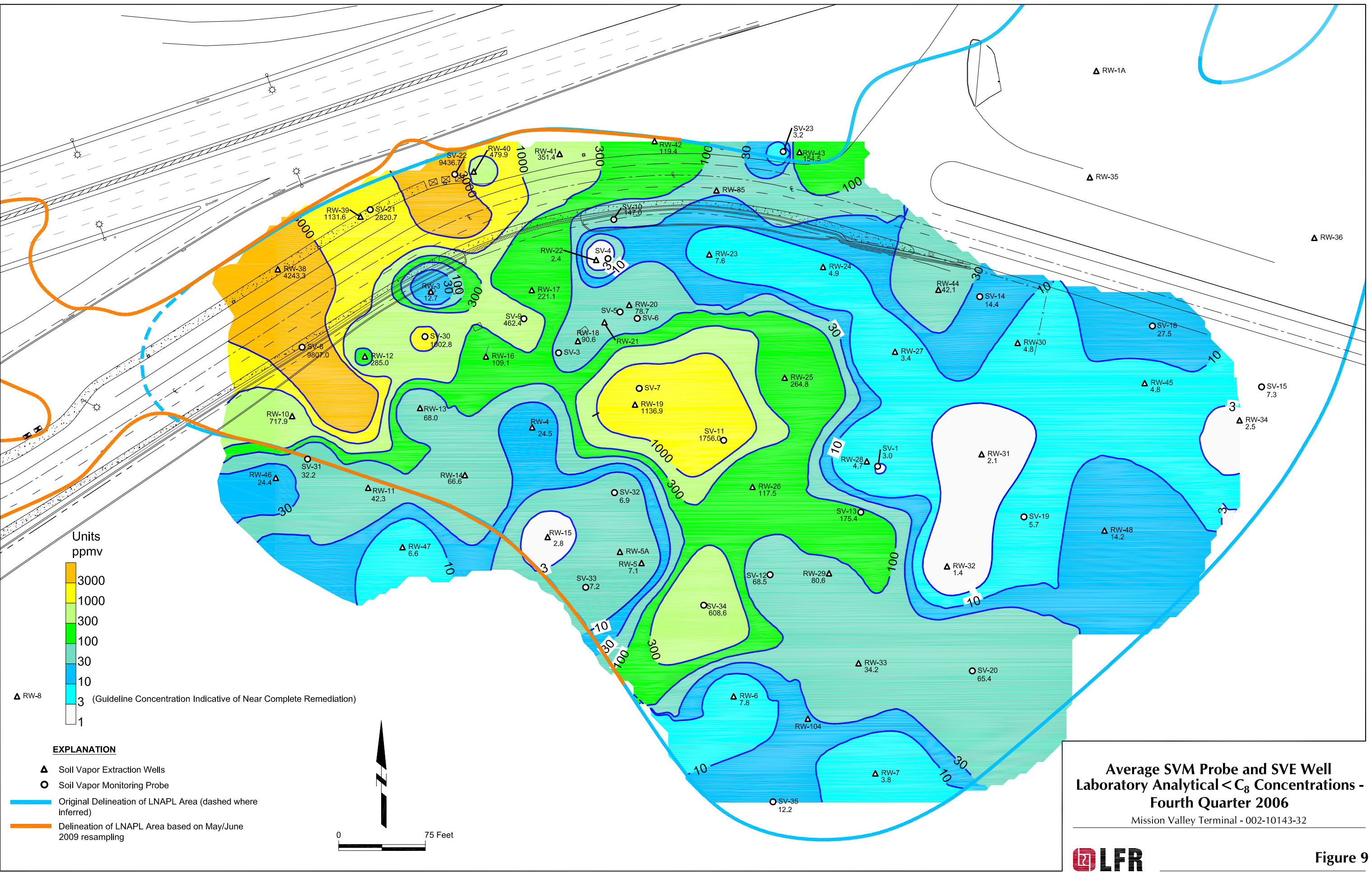
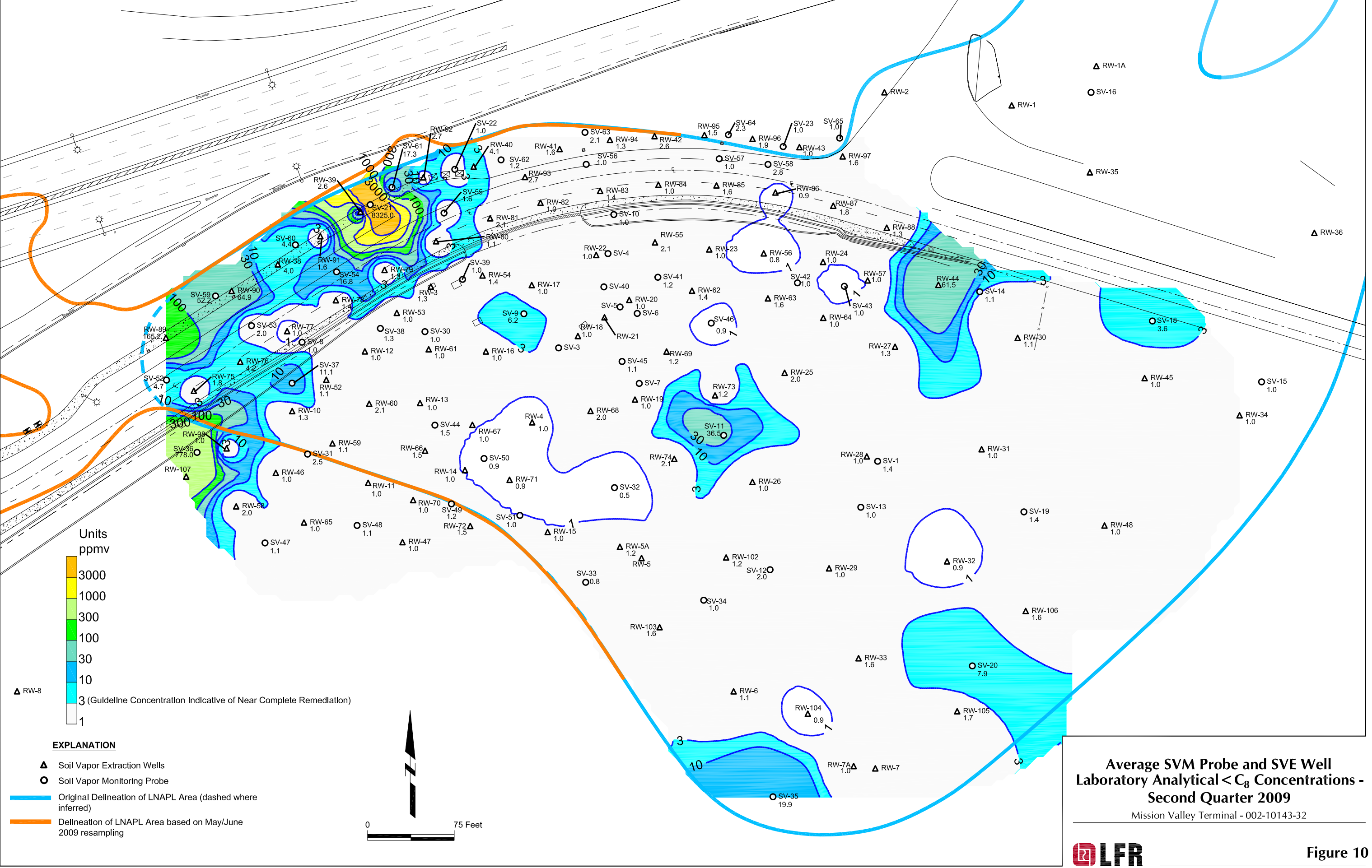

Figure 9

K:\Data\Graphics\1000010143\39\0709\10143-39_TPH It.c8.dwg [TPH] 8/4/09 2:08pm BARobtia XREFS: [MVT_BASE+Q08.DWG] [10180_TerminalBase.dwg] [Residual_LNAPL.dwg] [Residual_LNAPL.dwg] [all_samps_0509.dwg] [MVT_BASE-Aerial.DWG]



**Average SVM Probe and SVE Well
Laboratory Analytical C_8 Concentrations -
Second Quarter 2009**
Mission Valley Terminal - 002-10143-32



Figure 10

K:\Data\Capitol\10143328\101433-32\TSV.dwg [TSV] 7/21/09 11:17am JDI.cofmg_XBEESS: [MVT_BASE]008.DWG [101433-32] [TSV.dwg] [MAP] [PIPE.dwg] [RAIN_PIPE.dwg] [RESIDUAL] [MAP] [PIPE.dwg] [BASE.dwg] [MVT_BASE.dwg] [DWG]

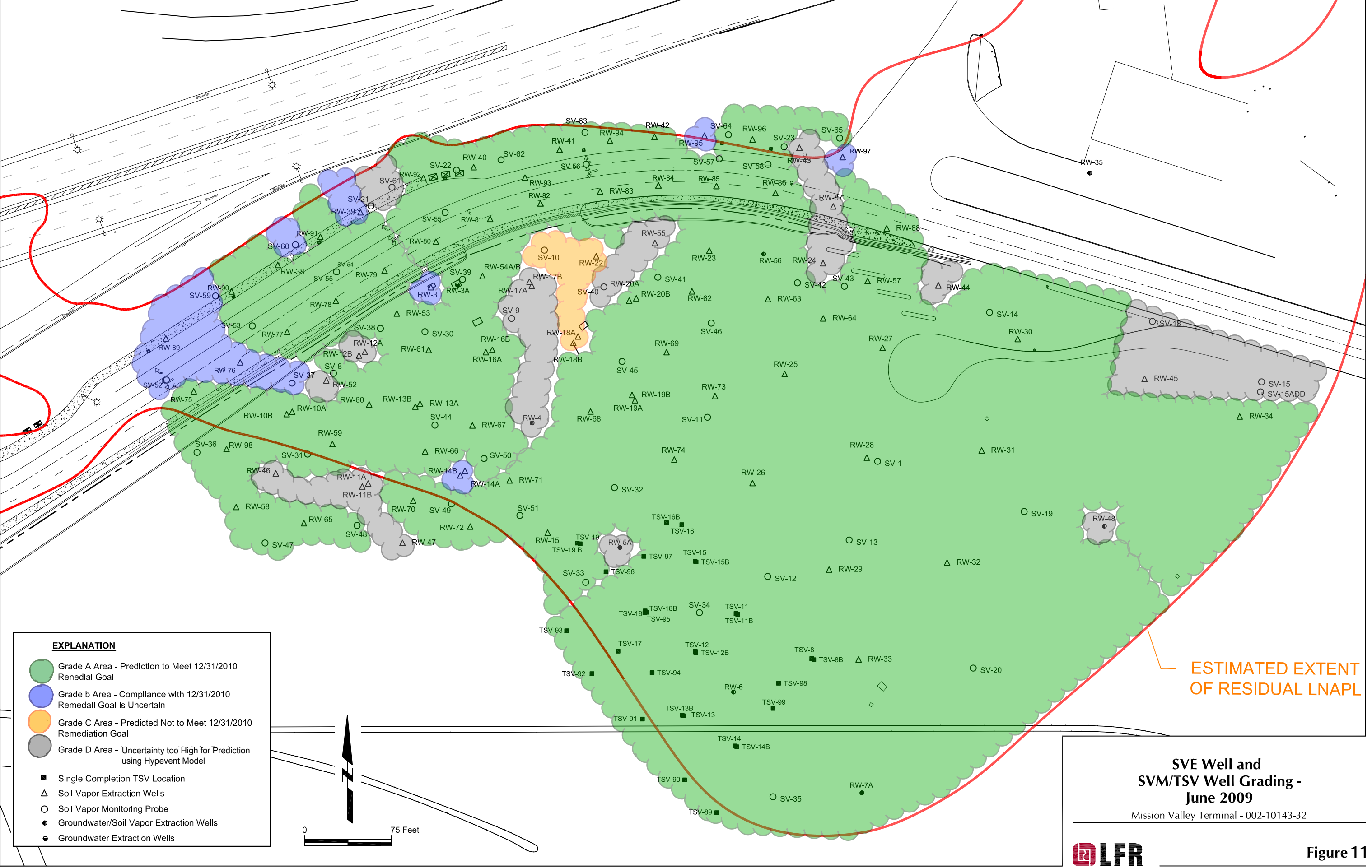

EXPLANATION

- Grade A Area - Prediction to Meet 12/31/2010 Remedial Goal
- Grade b Area - Compliance with 12/31/2010 Remedial Goal is Uncertain
- Grade C Area - Predicted Not to Meet 12/31/2010 Remediation Goal
- Grade D Area - Uncertainty too High for Prediction using Hypevent Model
- Single Completion TSV Location
- △ Soil Vapor Extraction Wells
- Soil Vapor Monitoring Probe
- Groundwater/Soil Vapor Extraction Wells
- Groundwater Extraction Wells

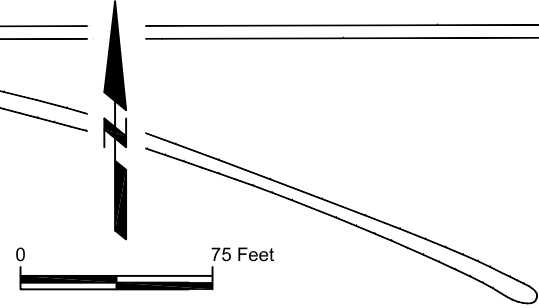

ESTIMATED EXTENT OF RESIDUAL LNAPL



SVE Well and SVM/TSV Well Grading - June 2009
 Mission Valley Terminal - 002-10143-32

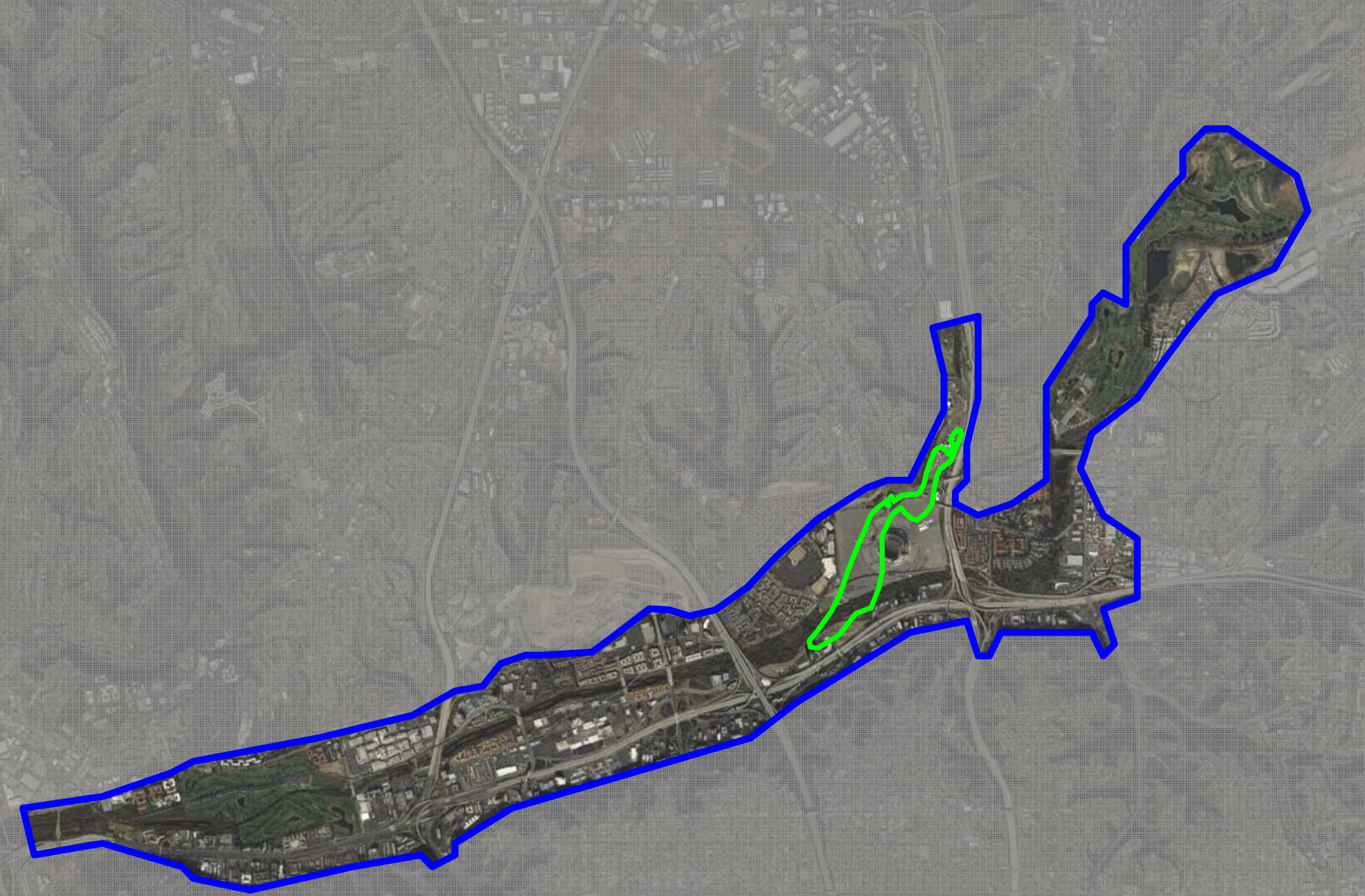

Figure 11



Explanation

-  Extent of Site Impact
-  Extent of Mission Valley Aquifer

Extent of Site Within Mission Valley Aquifer

Mission Valley Terminal – 002-10143-39

Figure 12

Data SIO, NOAA, U.S. Navy, N



1. Fouling on Extracted Water Conveyance 1.



2. Fouling on Extracted Water Conveyance 2.



3. Mineral Fouling on Treated Discharge Pipe 1.



4. Mineral Fouling on Treated Discharge Pipe 2.

Site Photographs

002-10143-39 GWETS

Figure 14

