

**CALIFORNIA REGIONAL WATER QUALITY CONTROL BOARD  
SAN DIEGO REGION**

2375 Northside Drive, Suite.100, San Diego, CA 92108  
Phone (619) 516-1990 • Fax (619) 516-1994  
<http://www.waterboards.ca.gov/sandiego/>

**Amendment No. 1 to Clean Water Act Section 401  
Water Quality Certification No. R9-2015-0158**

**PROJECT: ETS 21953 Access Road Repair to Z223141, CPEN  
Certification Number R9-2015-0158**

**APPLICANT: San Diego Gas and Electric  
8315 Century Park Court, CP21E  
San Diego, CA 92123**

Reg. Meas. ID: 403083  
Place ID: 818545  
Party ID: 39618  
Person ID: 520549  
WDID: 9000002905

On May 6, 2016, Clean Water Act Section 401 Water Quality Certification No. R9-2015-0158 (Certification) was issued to San Diego Gas and Electric (Applicant) for the ETS 21953 Access Road Repair to Z223141, CPEN Project (Project).

By letter dated May 5, 2017, San Diego Gas and Electric requested the Certification be amended to accommodate design changes required by Marine Corps Base Camp Pendleton that will result in increased impacts to waters of the United States and/or State. Design changes include a wing headwall at the outlet, extension of the rip-rap energy dissipater at the culvert outfall and use of concrete culverts to meet design requirements for fire prone areas. Permanent impacts increased from 0.002 acres (14 linear feet) to a total of 0.007 acres (40 linear feet) of waters of the United States and/or State; and temporary impacts are changed from 0.001 acres (52 linear feet) to a total of 0.004 acres (23 linear feet) of waters of the United States and/or State.

Based on the Applicant's request, the California Regional Water Quality Control Board, San Diego Region (San Diego Water Board) is amending the Certification to include a wing headwall at the outlet, extension of the rip-rap energy dissipater at the culvert outfall and use of concrete culverts. Except as modified or superseded by the Certification modifications set forth below, all of the findings, provisions and other requirements of Certification No. R9-2015-0158 remain in full force and effect. The following changes are made to Certification No. R9-2015-0158 and are shown in underline/strikeout format to indicate added and removed language:

**Page 2, PROJECT DESCRIPTON is modified as follows:**

Project construction will permanently impact ~~0.002~~0.007 acre (~~1440~~ linear feet) of streambed waters of the United States and/or State. The Applicant reports that the Project purpose cannot be practically accomplished in a manner which would avoid or result in less adverse impacts to aquatic resources considering all potential practicable alternatives, such as the potential for alternate available locations, designs, reductions in size, configuration or density. The Applicant reports that compensatory mitigation for the permanent loss of ~~0.002~~0.007 acre (~~1440~~ linear feet) of jurisdictional waters will be

achieved through the purchase of ~~0.004~~0.014 acre of reestablished river credits from the San Luis Rey Mitigation Bank.

**Page 11, PROJECT IMPACTS AND COMPENSATORY MITIGATION condition V.B is modified as follows:**

**Project Impacts and Compensatory Mitigation.** Unavoidable Project impacts to Cristianitos Creek and its unnamed tributaries within the San Juan Watershed must not exceed the type and magnitude of impacts described in the table below. At a minimum, compensatory mitigation required to offset unavoidable temporary and permanent Project impacts to waters of the United States and/or State must be achieved as described in the table below:

	Impacts (acres)	Impacts (linear ft.)	Mitigation for Impacts (acres)	Mitigation Ratio (area mitigated :area impacted)	Mitigation for Impacts (linear ft.)	Mitigation Ratio (linear feet mitigated :linear feet impacted)
<b>Permanent Impacts</b>						
Stream Channel	0.002 <u>0.007</u>	44 <u>40</u>	0.004 <u>0.014</u> Re-establishment <sup>1</sup>	2:1	NA <sup>2</sup>	NA <sup>2</sup>
<b>Temporary Impacts<sup>3</sup></b>						
Streambed and Riparian	0.004 <u>0.004</u>	52 <u>23</u>	NA	NA	NA	NA

1. Permanent impacts will be mitigated through the purchase of ~~0.004~~ 0.014-acre of re-established river credits from the San Luis Rey Mitigation Bank. Mitigation purchased from the San Luis Rey Mitigation Bank is required to be protected and maintained in perpetuity by Wildlands according to the conditions of Water Quality Certification No. R9-2013-0050. The mitigation provided for Project impacts contributes to the net gain of wetlands per the State of California Net Gain Policy (Executive Order W-59-93.)

2. The amount of mitigation credits purchased is not reported in terms of linear feet of mitigation.
3. All areas of temporary impacts must be restored to pre-project contours and re-vegetated with native species.

**Notification:** Any person aggrieved by this action of the San Diego Water Board may petition the State Water Resources Control Board (State Water Board) to review the action in accordance with the California Code of Regulations, title 23, sections 3867 and following. The State Water Board must receive the petition by 5:00 p.m., 30 days after the date of this Certification Amendment. Copies of the law and regulations applicable to filing petitions may be found on the Internet at: [http://www.waterboards.ca.gov/public\\_notices/petitions/water\\_quality](http://www.waterboards.ca.gov/public_notices/petitions/water_quality) or will be provided upon request.

I, David W. Gibson, Executive Officer, do hereby certify the forgoing is a full, true, and correct copy of Amendment No. 1 to Certification No. R9-2015-0158 issued on July 14, 2017.

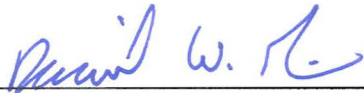
  
\_\_\_\_\_  
DAVID W. GIBSON  
Executive Officer  
San Diego Water Board

14 July 2017  
Date

# CALIFORNIA REGIONAL WATER QUALITY CONTROL BOARD SAN DIEGO REGION

2375 Northside Drive, Suite.100, San Diego, CA 92108  
Phone (619) 516-1990 • Fax (619) 516-1994  
<http://www.waterboards.ca.gov/sandiego/>

## Clean Water Act Section 401 Water Quality Certification and Waste Discharge Requirements for Discharge of Dredged and/or Fill Materials

**PROJECT: ETS 21953 Access Road Repair to Z223141, CPEN  
Certification Number R9-2015-0158  
WDID: 9000002905**

Reg. Meas. ID: 403083
Place ID: 818545
Party ID: 39618
Person ID: 520549

**APPLICANT: San Diego Gas and Electric  
8315 Century Park Court, CP21E  
San Diego, CA 92123**

**ACTION:**

<input type="checkbox"/> Order for Low Impact Certification	<input type="checkbox"/> Order for Denial of Certification
<input checked="" type="checkbox"/> Order for Technically-conditioned Certification	<input type="checkbox"/> Enrollment in Isolated Waters Order No. 2004-004-DWQ
<input checked="" type="checkbox"/> Enrollment in SWRCB GWDR Order No. 2003-017-DWQ	

**PROJECT DESCRIPTION**

An application dated October 2, 2015 was submitted by San Diego Gas and Electric (hereinafter Applicant), for Water Quality Certification pursuant to section 401 of the Clean Water Act (United States Code (USC) Title 33, section 1341) for the proposed ETS 21953 Access Road Repair to Z223141, CPEN Project (Project). The California Regional Water Quality Control Board, San Diego Region (San Diego Water Board) deemed the application to be complete on April 12, 2016. The Applicant proposes to discharge dredged or fill material to waters of the United States and/or State associated with construction activity at the Project site. The project qualifies for a non-notifying Nationwide Permit No. 12 (Utility Line Activities).

The Project is located in the state park-lease area west of Cristianitos Road, along the border of Marine Corps base Camp Pendleton and the City of San Clemente, San Diego County, California. The Project center reading is located at latitude 33.261230 and longitude - 117.345819. The Applicant has paid all required application fees for this Certification in the amount of \$1,097.00. On an annual basis, the Applicant shall also pay all active discharge fees and post discharge monitoring fees, as appropriate<sup>1</sup>. On April 13, 2016, the San Diego

<sup>1</sup> The Applicant shall pay an annual active discharge fee each fiscal year or portion of a fiscal year during which discharges occur until the regional water board or the State Water Resources Control Board (State Water Board) issues a Notice of Completion of Discharges Letter to the discharger. Dischargers shall pay an annual post-discharge monitoring fee each fiscal year or portion of a fiscal year commencing with the first fiscal year following the fiscal year in which the regional water board or State Water Board issued a Notice of Completion of Discharges Letter to the discharger, but continued water quality monitoring or compensatory mitigation monitoring is required. Dischargers shall pay the annual post-discharge monitoring fee each fiscal year until the regional water board or the State Water Board issues a Notice of Project Complete Letter to the

*(footnote continued on next page)*

Water Board provided public notice of the Project application pursuant to California Code of Regulations, title 23, section 3858 by posting information describing the Project on the San Diego Water Board's web site and providing a period of twenty-one days for public review and comment. No comments were received.

The Applicant proposes to replace two corroded corrugated metal pipes (CMPs) under an existing access road. The access road crosses an unnamed intermittent tributary to Cristianitos Creek on Marine Corps Base Camp Pendleton (MCBCP). The corroded CMPs have allowed water to infiltrate underlying soils, which has led to erosion on the south side of the road, compromising safety. Project activities will include the removal and replacement of the existing corroded CMPs and headwall. All debris from the pipe and wall demolition will be loaded into a dump truck and hauled off-site for legal disposal. Existing trash and debris in the drainage will also be removed. After placing 6-inches of 3/4-inch rock, two 30-foot long by 36-inch diameter high-density polyethylene (HDPE) replacement pipes will be installed. Once the pipes are in place, additional 3/4-inch rock will be placed around the pipe, half way up on all sides. A 8-foot wide by 5-foot tall by 2-foot deep replacement headwall will be installed after the pipes are in place. Eroded areas on the east side of the road and under the new pipes will be stabilized with compacted soils. A 2:1 slope will be created at the outflow, leaving the pipe to extend approximately 1 foot beyond the slope. Filter fabric and 9 to 12-inch rip rap will be placed over the slope for energy dissipation. The rock energy dissipater is proposed to prevent erosion and undercutting within the drainage.

The Project application includes a description of the design objective, operation, and degree of treatment expected to be attained from equipment, facilities, or activities (including construction and post-construction BMPs) to treat waste and reduce runoff or other effluents which may be discharged. Compliance with the Certification conditions will help ensure that construction and post-construction discharges from the Project will not cause on-site or off-site downstream erosion, damage to downstream properties, or otherwise damage stream habitats in violation of water quality standards in the *Water Quality Control Plan for the San Diego Basin (9)* (Basin Plan).

Project construction will permanently impact 0.002 acre (14 linear feet) of streambed waters of the United States and/or State. The Applicant reports that the Project purpose cannot be practically accomplished in a manner which would avoid or result in less adverse impacts to aquatic resources considering all potential practicable alternatives, such as the potential for alternate available locations, designs, reductions in size, configuration or density.

The Applicant reports that compensatory mitigation for the permanent loss of 0.002 acre (14 linear feet) of jurisdictional waters will be achieved through the purchase of 0.004 acre of re-established river credits from the San Luis Rey Mitigation Bank. Mitigation purchased from the San Luis Rey Mitigation Bank is required to be protected and maintained in perpetuity by Wildlands according to the conditions of Water Quality Certification No. R9-2013-0050. By purchasing credits: the Performance Standards; Mitigation Site Design; Long Term Management, Maintenance, and Monitoring; and Mitigation Site Preservation Mechanism for

---

*(footnote continued from previous page)*

discharger. Additional information regarding fees can be found electronically at the following location:  
[http://www.waterboards.ca.gov/water\\_issues/programs/cwa401/docs/dredgefillcalculator.xlsx](http://www.waterboards.ca.gov/water_issues/programs/cwa401/docs/dredgefillcalculator.xlsx)

the Project will be implemented by Wildlands through San Luis Rey Mitigation Bank according to the conditions of Water Quality Certification No. R9-2013-0050. Compensatory mitigation options within the watershed were deemed inadequate. The out of watershed mitigation is reflected in the 2:1 re-establishment mitigation ratio for impacts. Mitigation for discharges of fill material to waters of the United States and/or State will be completed by the Applicant at the San Luis Rey Mitigation Bank located in the Mission hydrologic sub-area (HSA 903.11) at a minimum compensation ratio of 2:1 (area mitigated:area impacted). The mitigation provided at the mitigation banks to offset Project impacts will contribute to a net gain in the quantity, quality and sustainability of wetlands pursuant to the State of California Wetlands Conservation Policy (Executive Order W-59-93.)

Additional Project details are provided in Attachments 1 through 3 of this Certification.

## TABLE OF CONTENTS

I.	STANDARD CONDITIONS.....	5
II.	GENERAL CONDITIONS .....	5
III.	CONSTRUCTION BEST MANAGEMENT PRACTICES .....	8
IV.	POST-CONSTRUCTION BEST MANAGEMENT PRACTICES .....	10
V.	PROJECT IMPACTS AND COMPENSATORY MITIGATION.....	11
VI.	MONITORING AND REPORTING REQUIREMENTS .....	12
VII.	NOTIFICATION REQUIREMENTS .....	15
VIII.	CALIFORNIA ENVIRONMENTAL QUALITY ACT COMPLIANCE .....	16
IX.	SAN DIEGO WATER BOARD CONTACT PERSON .....	16
X.	WATER QUALITY CERTIFICATION.....	17

### Attachments:

1. Definitions
2. Project Location Maps
3. Project Site Plans

## I. STANDARD CONDITIONS

Pursuant to section 3860 of title 23 of the California Code of Regulations, the following three standard conditions apply to all water quality certification actions:

- A. This Certification action is subject to modification or revocation upon administrative or judicial review, including review and amendment pursuant to section 13330 of the Water Code and chapter 28, article 6 (commencing with title 23, section 3867), of the California Code of Regulations.
- B. This Certification action is not intended and shall not be construed to apply to any discharge from any activity involving a hydroelectric facility and requiring a Federal Energy Regulatory Commission (FERC) license or an amendment to a FERC license unless the pertinent Certification application was filed pursuant to California Code of Regulations title 23, section 3855 subdivision (b), and that application specifically identified that a FERC license or amendment to a FERC license for a hydroelectric facility was being sought.
- C. This Certification action is conditioned upon total payment of any fee required under title 23, chapter 28 (commencing with section 3830) of California Code of Regulations and owed by the applicant.

## II. GENERAL CONDITIONS

- A. **Term of Certification.** Water Quality Certification No. R9-2015-0158 (Certification) shall expire upon a) the expiration or retraction of the Clean Water Act section 404 (33 USC Title 33, section 1344) permit issued by the U.S. Army Corps of Engineers for this Project, or b) five (5) years from the date of issuance of this Certification, whichever occurs first.
- B. **Duty to Comply.** The Applicant must comply with all conditions and requirements of this Certification. Any Certification noncompliance constitutes a violation of the Water Code and is grounds for enforcement action or Certification termination, revocation and reissuance, or modification.
- C. **General Waste Discharge Requirements.** The requirements of this Certification are enforceable through Water Quality Order No. 2003-0017-DWQ, *Statewide General Waste Discharge Requirements for Discharges of Dredged or Fill Material that have Received State Water Quality Certification* (Water Quality Order No. 2003-0017-DWQ). This provision shall apply irrespective of whether a) the federal permit for which the Certification was obtained is subsequently retracted or is expired, or b) the Certification is expired. Water Quality Order No. 2003-0017-DWQ is accessible at:  
  
[http://www.waterboards.ca.gov/water\\_issues/programs/cwa401/docs/generalorders/gowdr401regulated\\_projects.pdf](http://www.waterboards.ca.gov/water_issues/programs/cwa401/docs/generalorders/gowdr401regulated_projects.pdf).
- D. **Project Conformance with Application.** All water quality protection measures and BMPs described in the application and supplemental information for water quality



certification are incorporated by reference into this Certification as if fully stated herein. Notwithstanding any more specific conditions in this Certification, the Applicant shall construct, implement and comply with all water quality protection measures and BMPs described in the application and supplemental information. The conditions within this Certification shall supersede conflicting provisions within the application and supplemental information submitted as part of this Certification action.

- E. **Project Conformance with Water Quality Control Plans or Policies.** Notwithstanding any more specific conditions in this Certification, the Project shall be constructed in a manner consistent with the Basin Plan and any other applicable water quality control plans or policies adopted or approved pursuant to the Porter Cologne Water Quality Act (Division 7, commencing with Water Code Section 13000) or section 303 of the Clean Water Act (33 USC section 1313). The Basin Plan is accessible at:

[http://www.waterboards.ca.gov/sandiego/water\\_issues/programs/basin\\_plan/index.shtml](http://www.waterboards.ca.gov/sandiego/water_issues/programs/basin_plan/index.shtml)

- F. **Project Modification.** The Applicant must submit any changes to the Project, including Project operation, which would have a significant or material effect on the findings, conclusions, or conditions of this Certification, to the San Diego Water Board for prior review and written approval. If the San Diego Water Board is not notified of a significant change to the Project, it will be considered a violation of this Certification.
- G. **Certification Distribution Posting.** During Project construction, the Applicant must maintain a copy of this Certification at the Project site. This Certification must be available at all times to site personnel and agencies. A copy of this Certification shall also be provided to any contractor or subcontractor performing construction work, and the copy shall remain in their possession at the Project site.
- H. **Inspection and Entry.** The Applicant must allow the San Diego Water Board or the State Water Resources Control Board, and/or their authorized representative(s) (including an authorized contractor acting as their representative), upon the presentation of credentials and other documents as may be required under law, to:
1. Enter upon the Project or Compensatory Mitigation site(s) premises where a regulated facility or activity is located or conducted, or where records must be kept under the conditions of this Certification;
  2. Have access to and copy, at reasonable times, any records that must be kept under the conditions of this Certification;
  3. Inspect, at reasonable times, any facilities, equipment (including monitoring and control equipment), practices, or operations regulated or required under this Certification; and
  4. Sample or monitor, at reasonable times, for the purposes of assuring Certification compliance, or as otherwise authorized by the Clean Water Act or Water Code, any substances or parameters at any location.

- I. **Enforcement Notification.** In the event of any violation or threatened violation of the conditions of this Certification, the violation or threatened violation shall be subject to any remedies, penalties, process or sanctions as provided for under State law. For purposes of section 401(d) of the Clean Water Act, the applicability of any State law authorizing remedies, penalties, process or sanctions for the violation or threatened violation constitutes a limitation necessary to assure compliance with the water quality standards and other pertinent requirements incorporated into this Certification.
- J. **Certification Actions.** This Certification may be modified, revoked and reissued, or terminated for cause including but not limited to the following:
1. Violation of any term or condition of this Certification;
  2. Monitoring results indicate that continued Project activities could violate water quality objectives or impair the beneficial uses of Cristianitos Creek or its tributaries;
  3. Obtaining this Certification by misrepresentation or failure to disclose fully all relevant facts;
  4. A change in any condition that requires either a temporary or permanent reduction or elimination of the authorized discharge; and
  5. Incorporation of any new or revised water quality standards and implementation plans adopted or approved pursuant to the Porter-Cologne Water Quality Control Act or section 303 of the Clean Water Act.

The filing of a request by the Applicant for modification, revocation and reissuance, or termination, or a notification of planned changes or anticipated noncompliance does not stay any Certification condition.

- K. **Duty to Provide Information.** The Applicant shall furnish to the San Diego Water Board, within a reasonable time, any information which the San Diego Water Board may request to determine whether cause exists for modifying, revoking and reissuing, or terminating this Certification or to determine compliance with this Certification.
- L. **Property Rights.** This Certification does not convey any property rights of any sort, or any exclusive privilege.
- M. **Petitions.** Any person aggrieved by this action of the San Diego Water Board may petition the State Water Resources Control Board (State Water Board) to review the action in accordance with the California Code of Regulations, title 23, sections 3867 and following. The State Water Board must receive the petition by 5:00 p.m., 30 days after the date of this Certification. Copies of the law and regulations applicable to filing petitions may be found on the Internet at: [http://www.waterboards.ca.gov/public\\_notices/petitions/water\\_quality](http://www.waterboards.ca.gov/public_notices/petitions/water_quality) or will be provided upon request.

### III. CONSTRUCTION BEST MANAGEMENT PRACTICES

- A. **Approvals to Commence Construction.** The Applicant shall not commence Project construction until all necessary federal, State, and local approvals are obtained.
- B. **Personnel Education.** Prior to the start of the Project, and annually thereafter, the Applicant must educate all personnel on the requirements in this Certification, pollution prevention measures, spill response measures, and BMP implementation and maintenance measures.
- C. **Spill Containment Materials.** The Applicant must, at all times, maintain appropriate types and sufficient quantities of materials on-site to contain any spill or inadvertent release of materials that may cause a condition of pollution or nuisance if the materials reach waters of the United States and/or State.
- D. **General Construction Storm Water Permit.** Prior to start of Project construction, the Applicant must, as applicable, obtain coverage under, and comply with, the requirements of State Water Resources Control Board Water Quality Order No. 2009-0009-DWQ, the *General Permit for Storm Water Discharges Associated with Construction and Land Disturbance Activity*, (General Construction Storm Water Permit) and any reissuance. If Project construction activities do not require coverage under the General Construction Storm Water Permit, the Applicant must develop and implement a runoff management plan (or equivalent construction BMP plan) to prevent the discharge of sediment and other pollutants during construction activities.
- E. **Waste Management.** The Applicant must properly manage, store, treat, and dispose of wastes in accordance with applicable federal, state, and local laws and regulations. Waste management shall be implemented to avoid or minimize exposure of wastes to precipitation or storm water runoff. The storage, handling, treatment, or disposal of waste shall not create conditions of pollution, contamination or nuisance as defined in Water Code section 13050. Upon Project completion, all Project generated debris, building materials, excess material, waste, and trash shall be removed from the Project site(s) for disposal at an authorized landfill or other disposal site in compliance with federal, state and local laws and regulations.
- F. **Waste Management.** Except for a discharge permitted under this Certification, the dumping, deposition, or discharge of trash, rubbish, unset cement or asphalt, concrete, grout, damaged concrete or asphalt, concrete or asphalt spoils, wash water, organic or earthen material, steel, sawdust or other construction debris waste from Project activities directly into waters of the United States and or State, or adjacent to such waters in any manner which may permit its being transported into the waters, is prohibited.
- G. **Downstream Erosion.** Discharges of concentrated flow during construction or after Project completion must not cause downstream erosion or damage to properties or stream habitat.

- H. **Construction Equipment.** All equipment must be washed prior to transport to the Project site and must be free of sediment, debris, and foreign matter. All equipment used in direct contact with surface water shall be steam cleaned prior to use. All equipment using gas, oil, hydraulic fluid, or other petroleum products shall be inspected for leaks prior to use and shall be monitored for leakage. Stationary equipment (e.g., motors, pumps, generator, etc.) shall be positioned over drip pans or other types of containment.
- I. **Process Water.** Water containing mud, silt, or other pollutants from equipment washing or other activities, must not be discharged to waters of the United States and/or State or placed in locations that may be subjected to storm water runoff flows. Pollutants discharged to areas within a stream diversion must be removed at the end of each work day or sooner if rain is predicted.
- J. **Surface Water Diversion.** All surface waters, including ponded waters, must be diverted away from areas of active grading, construction, excavation, vegetation removal, and/or any other activity which may result in a discharge to the receiving water. Diversion activities must not result in the degradation of beneficial uses or exceedance of the receiving water quality objectives. Any temporary dam or other artificial obstruction constructed must only be built from materials such as clean gravel which will cause little or no siltation. Normal flows must be restored to the affected stream immediately upon completion of work at that location.
- K. **Re-vegetation and Stabilization.** All areas that have 14 or more days of inactivity must be stabilized within 14 days of the last activity. The Applicant shall implement and maintain BMPs to prevent erosion of the rough graded areas. After completion of grading, all areas must be re-vegetated with native species appropriate for the area. The re-vegetation palette must not contain any plants listed on the California Invasive Plant Council Invasive Plant Inventory, which can be accessed at <http://www.cal-ipc.org/ip/inventory/>.
- L. **Hazardous Materials.** Except as authorized by this Certification, substances hazardous to aquatic life including, but not limited to, petroleum products, unused cement/concrete, asphalt, and coating materials, must be prevented from contaminating the soil and/or entering waters of the United States and/or State. BMPs must be implemented to prevent such discharges during each Project activity involving hazardous materials.
- M. **Vegetation Removal.** Removal of vegetation must occur by hand, mechanically, or through application of United States Environmental Protection Agency (USEPA) approved herbicides deployed using applicable BMPs to minimize adverse effects to beneficial uses of waters of the United States and/or State. Discharges related to the application of aquatic pesticides within waters of the United States must be done in compliance with State Water Resources Control Board Water Quality Order No. 2004-0009-DWQ, the *Statewide General National Pollution Discharge Elimination System Permit for the Discharge of Aquatic Weed Control in Waters of the United States*, and any subsequent reissuance as applicable.

- N. **Limits of Disturbance.** The Applicant shall clearly define the limits of Project disturbance to waters of the United States and/or State using highly visible markers such as flag markers, construction fencing, or silt barriers prior to commencement of Project construction activities within those areas.
- O. **On-site Qualified Biologist.** The Applicant shall designate an on-site qualified biologist to monitor Project construction activities within or adjacent to waters of the United States and/or State to ensure compliance with the Certification requirements. The biologist shall be given the authority to stop all work on-site if a violation of this Certification occurs or has the potential to occur. Records and field notes of the biologist's activities shall be kept on-site and made available for review upon request by the San Diego Water Board.
- P. **Beneficial Use Protection.** The Applicant must take all necessary measures to protect the beneficial uses of waters of Cristianitos Creek and its tributaries. This Certification requires compliance with all applicable requirements of the Basin Plan. If at any time, an unauthorized discharge to surface waters (including rivers or streams) occurs or monitoring indicates that the Project is violating, or threatens to violate, water quality objectives, the associated Project activities shall cease immediately and the San Diego Water Board shall be notified in accordance with Notification Requirement VII.A of this Certification. Associated Project activities may not resume without approval from the San Diego Water Board.
- Q. **Groundwater Dewatering.** If groundwater dewatering is required for the Project, the Applicant shall enroll in and comply with the requirements of San Diego Water Board Order No. R9-2008-0002 NPDES No. CAG919002, *General Waste Discharge Requirements For Groundwater Extraction Waste Discharges From Construction, Remediation, and Permanent Groundwater Extraction Projects to Surface Waters within the San Diego Region Except for San Diego Bay* or its successor permit.

#### IV. POST-CONSTRUCTION BEST MANAGEMENT PRACTICES

- A. **Post-Construction Discharges.** The Applicant shall not allow post-construction discharges from the Project site to cause or contribute to on-site or off-site erosion or damage to properties or stream habitats.
- B. **Bridge, Crossing, and Culvert Design.** Bridges, culverts, dip crossings, or other stream crossing structures shall be designed and installed so they will not cause scouring of the stream bed and/or erosion of the banks in the vicinity of the Project. Storm drain lines/culverts and other stream crossing structures shall be designed and maintained to accommodate at least a 100-year, 24-hour storm event, including associated bedload and debris, with a similar average velocity as upstream and downstream sections. Bottoms of temporary culverts shall be placed at stream channel grade and bottoms of permanent culverts shall be open bottom or embedded and backfilled below the grade of the stream greater than or equal to a depth of 1 foot.

**V. PROJECT IMPACTS AND COMPENSATORY MITIGATION**

- A. **Project Impact Avoidance and Minimization.** The Project must avoid and minimize adverse impacts to waters of the United States and/or State to the maximum extent practicable.
- B. **Project Impacts and Compensatory Mitigation.** Unavoidable Project impacts to Cristianitos Creek and its unnamed tributaries within the San Juan Watershed must not exceed the type and magnitude of impacts described in the table below. At a minimum, compensatory mitigation required to offset unavoidable temporary and permanent Project impacts to waters of the United States and/or State must be achieved as described in the table below:

	Impacts (acres)	Impacts (linear ft.)	Mitigation for Impacts (acres)	Mitigation Ratio (area mitigated :area impacted)	Mitigation for Impacts (linear ft.)	Mitigation Ratio (linear feet mitigated :linear feet impacted)
<b>Permanent Impacts</b>						
Stream Channel	0.002	14	0.004 Re-establishment <sup>1</sup>	2:1	NA <sup>2</sup>	NA <sup>2</sup>
<b>Temporary Impacts<sup>3</sup></b>						
Streambed and Riparian	0.001	52	NA	NA	NA	NA

1. Permanent impacts will be mitigated through the purchase of 0.004-acre of re-established river credits from the San Luis Rey Mitigation Bank. Mitigation purchased from the San Luis Rey Mitigation Bank is required to be protected and maintained in perpetuity by Wildlands according to the conditions of Water Quality Certification No. R9-2013-0050. The mitigation provided for Project impacts contributes to the net gain of wetlands per the State of California Net Gain Policy (Executive Order W-59-93.)
2. The amount of mitigation credits purchased is not reported in terms of linear feet of mitigation.
3. All areas of temporary impacts must be restored to pre-project contours and re-vegetated with native species.

- C. **Compensatory Mitigation Plan Implementation.** The Applicant must fully and completely implement the Mitigation Plan; any deviations from, or revisions to, the Mitigation Plan must be pre-approved by the San Diego Water Board.
- D. **Temporary Project Impact Areas.** The Applicant must restore all areas of temporary impacts and all other areas of temporary disturbance which could result in a discharge or a threatened discharge of pollutants to waters of the United States and/or State. Restoration must include grading of disturbed areas to pre-project contours and re-

vegetation with native species. The Applicant must implement all necessary BMPs to control erosion and runoff from areas associated with the Project.

## VI. MONITORING AND REPORTING REQUIREMENTS

- A. **Representative Monitoring.** Samples and measurements taken for the purpose of monitoring under this Certification shall be representative of the monitored activity.
- B. **Monitoring Reports.** Monitoring results shall be reported to the San Diego Water Board at the intervals specified in section VI of this Certification.
- C. **Monitoring and Reporting Revisions.** The San Diego Water Board may make revisions to the monitoring program at any time during the term of this Certification and may reduce or increase the number of parameters to be monitored, locations monitored, the frequency of monitoring, or the number and size of samples collected.
- D. **Records of Monitoring Information.** Records of monitoring information shall include:
1. The date, exact place, and time of sampling or measurements;
  2. The individual(s) who performed the sampling or measurements;
  3. The date(s) analyses were performed;
  4. The individual(s) who performed the analyses;
  5. The analytical techniques or methods used; and
  6. The results of such analyses.
- E. **Geographic Information System Data.** The Applicant must submit Geographic Information System (GIS) shape files of the Project impact sites within 30 days of the start of project construction within 30 days of mitigation installation. All impact and mitigation site shape files must be polygons. Two GPS readings (points) must be taken on each line of the polygon and the polygon must have a minimum of 10 points. GIS metadata must also be submitted.
- F. **Annual Project Progress Reports.** The Applicant must submit annual Project progress reports describing status of BMP implementation, and compliance with all requirements of this Certification to the San Diego Water Board prior to **March 1** of each year following the issuance of this Certification, until the Project has reached completion. Annual Project Progress Reports must be submitted even if Project construction has not begun. The monitoring period for each Annual Project Progress Report shall be January 1<sup>st</sup> through December 31<sup>st</sup> of each year. Annual Project Progress Reports must include, at a minimum, the following:

1. **Project Status and Compliance Reporting.** The Annual Project Progress Report must include the following Project status and compliance information:
  - a. The names, qualifications, and affiliations of the persons contributing to the report;
  - b. The status, progress, and anticipated schedule for completion of Project construction activities including the installation and operational status of best management practices project features for erosion and storm water quality treatment;
  - c. A description of Project construction delays encountered or anticipated that may affect the schedule for construction completion; and
  - d. A description of each incident of noncompliance during the annual monitoring period and its cause, the period of the noncompliance including exact dates and times, and if the noncompliance has not been corrected, the anticipated time it is expected to continue; and the steps taken or planned to reduce, eliminate, and prevent reoccurrence of the noncompliance.
  
- G. **Final Project Completion Report.** The Applicant must submit a Final Project Completion Report to the San Diego Water Board **within 30 days of completion of the Project.** The final report must include the following information:
  1. Date of construction initiation;
  2. Date of construction completion;
  3. BMP installation and operational status for the Project;
  4. As-built drawings of the Project, no bigger than 11"X17"; and
  5. Photo documentation of implemented post-construction BMPs and all areas of permanent and temporary impacts, prior to and after project construction. Photo documentation must be conducted in accordance with guidelines posted at [http://www.waterboards.ca.gov/sandiego/water\\_issues/programs/401\\_certification/docs/401c/401PhotoDocRB9V713.pdf](http://www.waterboards.ca.gov/sandiego/water_issues/programs/401_certification/docs/401c/401PhotoDocRB9V713.pdf). In addition, photo documentation must include Global Positioning System (GPS) coordinates for each of the photo points referenced;
  
- H. **Reporting Authority.** The submittal of information required under this Certification, or in response to a suspected violation of any condition of this Certification, is required pursuant to Water Code section 13267 and 13383. Civil liability may be administratively imposed by the San Diego Water Board for failure to submit information pursuant to Water Code sections 13268 or 13385.



- I. **Electronic Document Submittal.** The Applicant must submit all reports and information required under this Certification in electronic format via e-mail to [SanDiego@waterboards.ca.gov](mailto:SanDiego@waterboards.ca.gov). Documents over 50 megabytes will not be accepted via e-mail and must be placed on a disc and delivered to:

California Regional Water Quality Control Board  
San Diego Region  
Attn: 401 Certification No. R9-2015-0158:818545:dbradford  
2375 Northside Drive, Suite 100  
San Diego, California 92108

Each electronic document must be submitted as a single file, in Portable Document Format (PDF), and converted to text searchable format using Optical Character Recognition (OCR). All electronic documents must include scanned copies of all signature pages; electronic signatures will not be accepted. Electronic documents submitted to the San Diego Water Board must include the following identification numbers in the header or subject line: Certification No. R9-2015-0158:818545:dbradford.

- J. **Document Signatory Requirements.** All applications, reports, or information submitted to the San Diego Water Board must be signed as follows:
1. For a corporation, by a responsible corporate officer of at least the level of vice president.
  2. For a partnership or sole proprietorship, by a general partner or proprietor, respectively.
  3. For a municipality, or a state, federal, or other public agency, by either a principal executive officer or ranking elected official.
  4. A duly authorized representative may sign applications, reports, or information if:
    - a. The authorization is made in writing by a person described above.
    - b. The authorization specifies either an individual or position having responsibility for the overall operation of the regulated activity.
    - c. The written authorization is submitted to the San Diego Water Board Executive Officer.

If such authorization is no longer accurate because a different individual or position has responsibility for the overall operation of the Project, a new authorization satisfying the above requirements must be submitted to the San Diego Water Board prior to or together with any reports, information, or applications, to be signed by an authorized representative.

- K. **Document Certification Requirements.** All applications, reports, or information submitted to the San Diego Water Board must be certified as follows:

*"I certify under penalty of law that I have personally examined and am familiar with the information submitted in this document and all attachments and that, based on my inquiry of those individuals immediately responsible for obtaining the information, I believe that the information is true, accurate, and complete. I am aware that there are significant penalties for submitting false information, including the possibility of fine and imprisonment."*

## VII. NOTIFICATION REQUIREMENTS

- A. **Twenty Four Hour Non-Compliance Reporting.** The Applicant shall report any noncompliance which may endanger health or the environment. Any such information shall be provided orally to the San Diego Water Board within **24 hours** from the time the Applicant becomes aware of the circumstances. A written submission shall also be provided within five days of the time the Applicant becomes aware of the circumstances. The written submission shall contain a description of the noncompliance and its cause; the period of noncompliance, including exact dates and times, and if the noncompliance has not been corrected; the anticipated time it is expected to continue; and steps taken or planned to reduce, eliminate, and prevent recurrence of the noncompliance. The San Diego Water Board, or an authorized representative, may waive the written report on a case-by-case basis if the oral report has been received within 24 hours.
- B. **Hazardous Substance Discharge.** Except as provided in Water Code section 13271(b), any person who, without regard to intent or negligence, causes or permits any hazardous substance or sewage to be discharged in or on any waters of the State, shall as soon as (a) that person has knowledge of the discharge, (b) notification is possible, and (c) notification can be provided without substantially impeding cleanup or other emergency measures, immediately notify the County of San Diego, in accordance with California Health and Safety Code section 5411.5 and the California Office of Emergency Services of the discharge in accordance with the spill reporting provision of the State toxic disaster contingency plan adopted pursuant to Government Code Title 2, Division 1, Chapter 7, Article 3.7 (commencing with section 8574.17), and immediately notify the State Water Board or the San Diego Water Board of the discharge. This provision does not require reporting of any discharge of less than a reportable quantity as provided for under subdivisions (f) and (g) of section 13271 of the Water Code unless the Applicant is in violation of a Basin Plan prohibition.
- C. **Oil or Petroleum Product Discharge.** Except as provided in Water Code section 13272(b), any person who without regard to intent or negligence, causes or permits any oil or petroleum product to be discharged in or on any waters of the State, or discharged or deposited where it is, or probably will be, discharged in or on any waters of the State, shall, as soon as (a) such person has knowledge of the discharge, (b) notification is possible, and (c) notification can be provided without substantially impeding cleanup or other emergency measures, immediately notify the California Office of Emergency Services of the discharge in accordance with the spill reporting provision of the State oil spill contingency plan adopted pursuant to Government Code Title 2, Division 1,

Chapter 7, Article 3.7 (commencing with section 8574.1). This requirement does not require reporting of any discharge of less than 42 gallons unless the discharge is also required to be reported pursuant to Clean Water Act section 311, or the discharge is in violation of a Basin Plan prohibition.

- D. **Anticipated Noncompliance.** The Applicant shall give advance notice to the San Diego Water Board of any planned changes in the Project or the Compensatory Mitigation project which may result in noncompliance with Certification conditions or requirements.
- E. **Commencement of Construction Notification.** The Applicant must notify the San Diego Water Board in writing at least 5 days prior to the start of initial Project construction ground disturbance
- F. **Transfers.** This Certification is not transferable in its entirety or in part to any person or organization except after notice to the San Diego Water Board in accordance with the following terms:

**Transfer of Property Ownership:** The Applicant must notify the San Diego Water Board of any change in ownership of the Project area. Notification of change in ownership must include, but not be limited to, a statement that the Applicant has provided the purchaser with a copy of the Section 401 Water Quality Certification and that the purchaser understands and accepts the certification requirements and the obligation to implement them or be subject to liability for failure to do so; the seller and purchaser must sign and date the notification and provide such notification to the San Diego Water Board **within 10 days of the transfer of ownership.**

Upon properly noticed transfers of responsibility, the transferee assumes responsibility for compliance with this Certification and references in this Certification to the Applicant will be interpreted to refer to the transferee as appropriate. Transfer of responsibility does not necessarily relieve the Applicant of responsibility for compliance with this Certification in the event that a transferee fails to comply.

#### VIII. CALIFORNIA ENVIRONMENTAL QUALITY ACT COMPLIANCE

- A. The San Diego Water Board is the lead agency under the California Environmental Quality Act (Public Resources Code section 21000, et seq., (CEQA)), and promulgated a Notice of Exemption on May 5, 2016 under CEQA Guidelines Title 14, California Code of Regulations. The San Diego Water Board has determined the project is categorically exempt from CEQA pursuant to CEQA Guidelines section 15301.

#### IX. SAN DIEGO WATER BOARD CONTACT PERSON

Darren Bradford, Environmental Scientist  
Telephone: (619) 521-3356  
Email: [darren.bradford@waterboards.ca.gov](mailto:darren.bradford@waterboards.ca.gov)

## X. WATER QUALITY CERTIFICATION

I hereby certify that the proposed discharge from the **ETS 21953 Access Road Repair to Z223141, CPEN Project** (Certification No. R9-2015-0158) will comply with the applicable provisions of sections 301 ("Effluent Limitations"), 302 ("Water Quality Related Effluent Limitations"), 303 ("Water Quality Standards and Implementation Plans"), 306 ("National Standards of Performance"), and 307 ("Toxic and Pretreatment Effluent Standards") of the Clean Water Act. This discharge is also regulated under State Water Board Order No. 2003-0017-DWQ, "*Statewide General Waste Discharge Requirements for Dredged or Fill Discharges that have Received State Water Quality Certification (General WDRs)*," which requires compliance with all conditions of this Water Quality Certification. Please note that enrollment under Order No. 2003-017-DWQ is conditional and, should new information come to our attention that indicates a water quality problem, the San Diego Water Board may issue individual waste discharge requirements at that time.

Except insofar as may be modified by any preceding conditions, all Certification actions are contingent on (a) the discharge being limited to, and all proposed mitigation being completed in strict compliance with, the applicants' Project description and/or the description in this Certification, and (b) compliance with all applicable requirements of the Basin Plan.

I, David W. Gibson, Executive Officer, do hereby certify the forgoing is a full, true, and correct copy of Certification No. R9-2015-0158 issued on May 6, 2016.

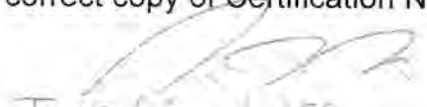
  
\_\_\_\_\_  
DAVID W. GIBSON  
Executive Officer  
San Diego Water Board

  
\_\_\_\_\_  
Date

# ATTACHMENT 1

## DEFINITIONS

**Activity** - when used in reference to a permit means any action, undertaking, or project including, but not limited to, construction, operation, maintenance, repair, modification, and restoration which may result in any discharge to waters of the state.

**Buffer** - means an upland, wetland, and/or riparian area that protects and/or enhances aquatic resource functions associated with wetlands, rivers, streams, lakes, marine, and estuarine systems from disturbances associated with adjacent land uses.

**California Rapid Assessment Method (CRAM)** - is a wetland assessment method intended to provide a rapid, scientifically-defensible and repeatable assessment methodology to monitor status and trends in the conditions of wetlands for applications throughout the state. It can also be used to assess the performance of compensatory mitigation projects and restoration projects. CRAM provides an assessment of overall ecological condition in terms of four attributes: landscape context and buffer, hydrology, physical structure and biotic structure. CRAM also includes an assessment of key stressors that may be affecting wetland condition and a "field to PC" data management tool (eCRAM) to ensure consistency and quality of data produced with the method.

**Compensatory Mitigation Project** - means compensatory mitigation implemented by the Applicant as a requirement of this Certification (i.e., applicant -responsible mitigation), or by a mitigation bank or an in-lieu fee program.

**Discharge of dredged material** – means any addition of dredged material into, including redeposit of dredged material other than incidental fallback within, the waters of the United States and/or State.

**Discharge of fill material** – means the addition of fill material into waters of the United States and/or State.

**Dredged material** – means material that is excavated or dredged from waters of the United States and/or State.

**Ecological Success Performance Standards** – means observable or measurable physical (including hydrological), chemical, and/or biological attributes that are used to determine if a compensatory mitigation project meets its objectives.

**Enhancement** – means the manipulation of the physical, chemical, or biological characteristics of an aquatic resource to improve a specific aquatic resource function(s). Enhancement results in the gain of selected aquatic resource function(s), but may also lead to a decline in other aquatic resource function(s). Enhancement does not result in a gain in aquatic resource area.

**Establishment** – means the manipulation of the physical, chemical, or biological characteristics present to develop an aquatic resource that did not previously exist. Creation results in a gain in aquatic resource area.

**Fill material** – means any material used for the primary purpose of replacing an aquatic area with dry land or of changing the bottom elevation of a water body.

**Isolated wetland** – means a wetland with no surface water connection to other aquatic resources.

**Mitigation Bank** – means a site, or suite of sites, where resources (e.g., wetlands, streams, riparian areas) are restored, established, enhanced, and/or preserved for the purpose of providing mitigation for impacts authorized by this Certification.

**Preservation** - means the removal of a threat to, or preventing the decline of, aquatic resources by an action in or near those aquatic resources. This term includes activities commonly associated with the protection and maintenance of aquatic resources through the implementation of appropriate legal and physical mechanisms. Preservation does not result in a gain of aquatic resource area or functions.

**Re-establishment** - means the manipulation of the physical, chemical, or biological characteristics of a site with the goal of returning natural/ historic functions to a former aquatic resource. Re-establishment results in rebuilding a former aquatic resource and results in a gain in aquatic resource area and functions.

**Rehabilitation** - means the manipulation of the physical, chemical, or biological characteristics of a site with the goal of repairing natural/ historic functions to a degraded aquatic resource. Rehabilitation results in a gain in aquatic resource function, but does not result in a gain in aquatic resource area.

**Restoration** - means the manipulation of the physical, chemical, or biological characteristics of a site with the goal of returning natural/historic functions to a former or degraded aquatic resource. For the purpose of tracking net gains in aquatic resource area, restoration is divided into two categories: re-establishment and rehabilitation.

**Start of Project Construction** - For the purpose of this Certification, "start of Project construction" means to engage in a program of on-site construction, including site clearing, grading, dredging, landfilling, changing equipment, substituting equipment, or even moving the location of equipment specifically designed for a stationary source in preparation for the fabrication, erection or installation of the building components of the stationary source within waters of the United States and/or State.

**Uplands** - means non-wetland areas that lack any field-based indicators of wetlands or other aquatic conditions. Uplands are generally well-drained and occur above (i.e., up-slope) from nearby aquatic areas. Wetlands can, however, be entirely surrounded by uplands. For example, some natural seeps and constructed stock ponds lack aboveground hydrological connection to other aquatic areas. In the watershed context, uplands comprise the landscape matrix in which aquatic areas form. They are the primary sources of sediment, surface runoff, and associated chemicals that are deposited in aquatic areas or transported through them.

**Water quality objectives and other appropriate requirements of state law** – means the water quality objectives and beneficial uses as specified in the appropriate water quality control plan(s); the applicable provisions of sections 301, 302, 303, 306, and 307 of the Clean Water Act; and any other appropriate requirement of state law.

**Waters of the State** - means any surface water or groundwater, including saline waters, within the boundaries of the State. [Water Code section 13050, subd. (e)].

San Diego Gas and Electric  
ETS 21953 Access Road Repair to Z223141, CPEN Project  
Certification No. R9-2015-0158

**ATTACHMENT 2  
PROJECT LOCATION MAPS**

**Figure 1 – Regional Vicinity Map**

**Figure 2 – Project Vicinity Map**





K:\San Diego\projects\SD\GE\_KP\BIO\000000\_00\_e\TSZ1593\_21595\mapdoc\JDI\Fig01\_Regional\_Vicinity.mxd Date: 8/13/2015 19:31:16



**Figure 1**  
**Regional Vicinity Map**  
**Access Road Repair to Z223141, CPEN**

K:\San\_Diego\projects\SD\GE\_KP\BIO\00000\_00\_e\TS21593\_21595\mapdoc\JD\Fr02\_Protect\_Vicinity.mxd Date: 8/13/2015 19:31:6



**Figure 2**  
**Project Vicinity Map**  
**Access Road Repair to Z223141, CPEN**



San Diego Gas and Electric  
ETS 21953 Access Road Repair to Z223141, CPEN Project  
Certification No. R9-2015-0158

**ATTACHMENT 3  
PROJECT SITE PLANS**

**Figure 3 – Jurisdictional Waters Map**

**Figure 4 – Project Impact Map**

**Sheet 1 of 1 – Scope of Work**

**Figures 1 & 2 – Site Photos**

K:\San Diego\projects\SDGE\_KPI\B\0\00000\_00\_eT\SZ1593\_21595\mapdoc\JDI\Fig03\_JD\_Waters.mxd Date: 8/14/2015 19:16

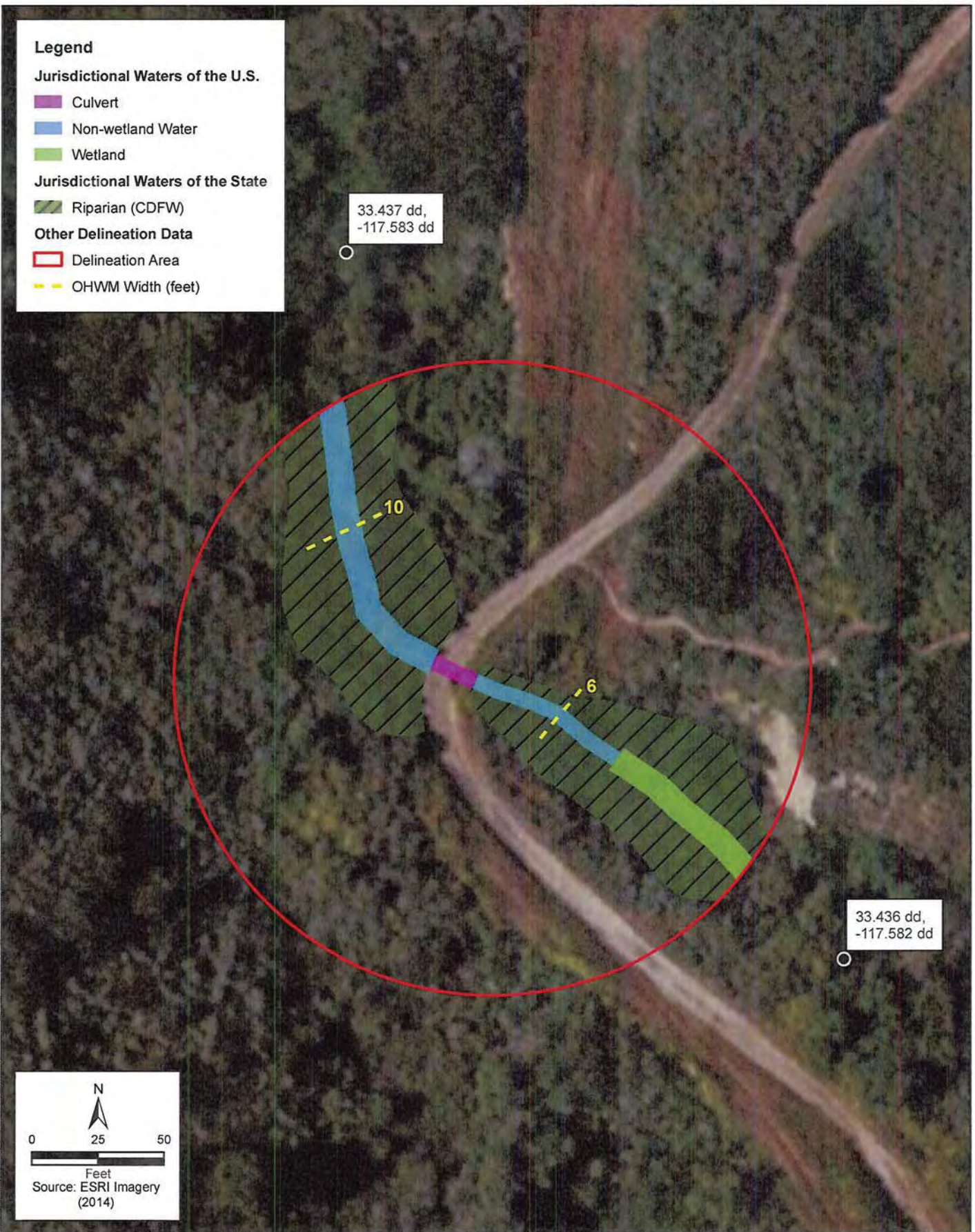

**Figure 3**  
Jurisdictional Waters Map  
Access Road Repair to Z223141, CPEN

K:\San Diego\projects\SDGE\_KP\Bp\00000\_00\_e\TS21583\_21595\mapdoc\JD\Fig05\_impacts.mxd Date: 8/14/2015 19316

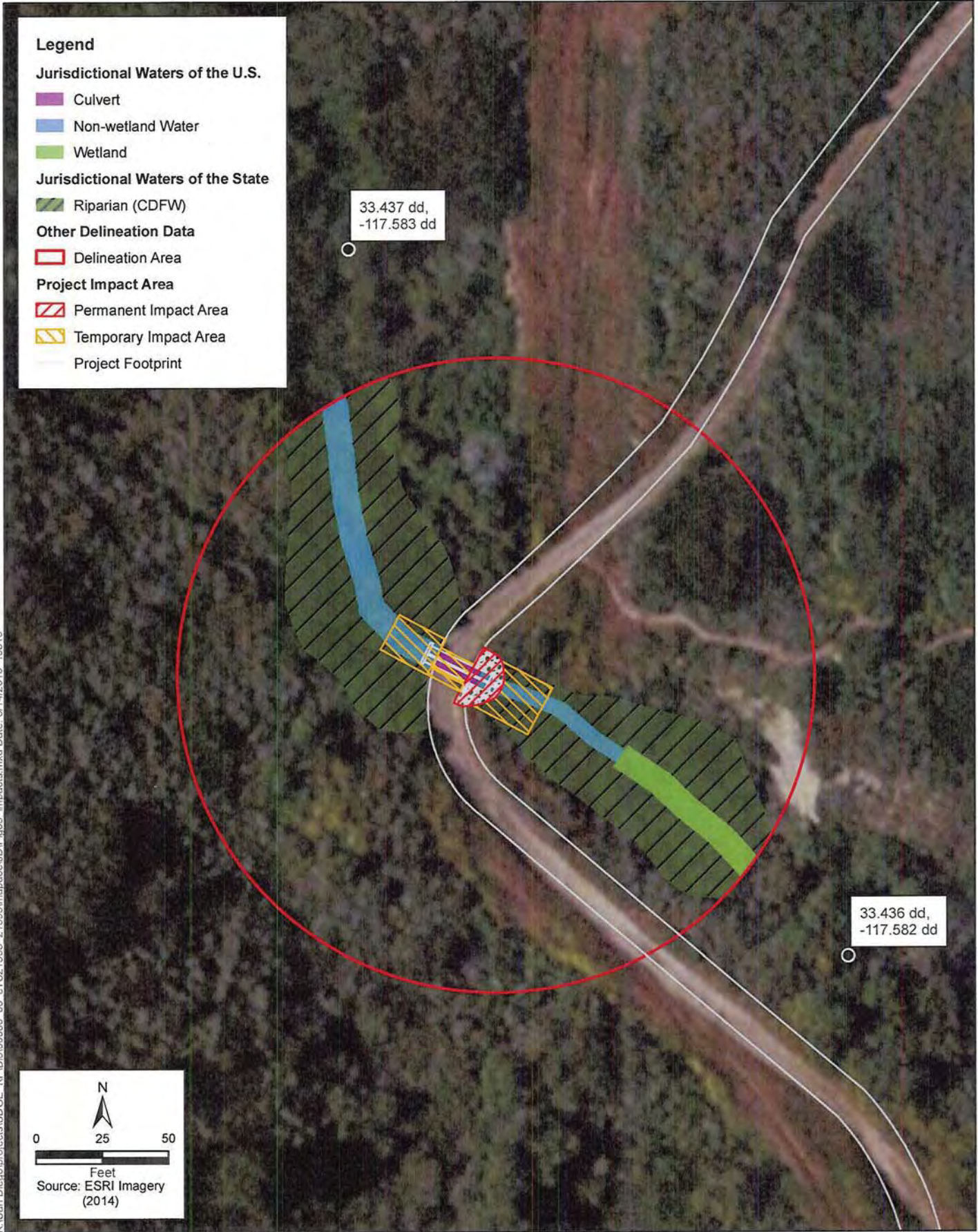
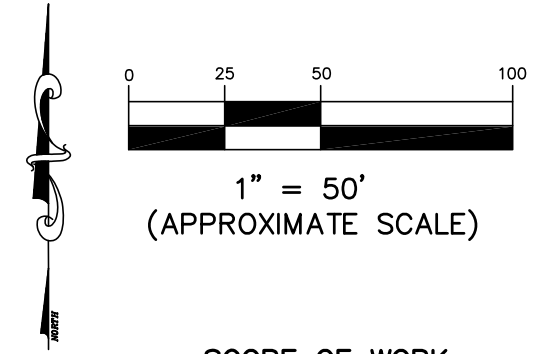

Figure 4  
Project Impact map  
Access Road Repair to Z223141, CPEN

S:\Civil\Data\TRANSMISSION\TCM & Task Trackers\TT10036\DWG\TT 10036.dwg, 11/18/2013 1:48:01 PM



**SCOPE OF WORK**

THIS SITE HAS TWO 36"Ø CMP'S THAT HAVE APPARENTLY CORRODED AWAY AND CONSEQUENTLY THE WATER HAS BEEN DISCHARGED INTO THE UNDERLYING SOIL AND EVENTUALLY UNDERMINED THE PIPES. THE FOLLOWING ARE STEPS RECOMMENDED TO REPAIR THE WORK.

1. THERE IS AN EXISTING HEADWALL ON THE WESTERN SIDE OF THE ACCESS ROAD THAT HAS PERFORMED ADEQUATELY. IF POSSIBLE LEAVE IN PLACE. EXCAVATE EXISTING PIPE THAT RUNS ACROSS THE ROAD TO DETERMINE THE EXTENT OF THE DAMAGE.
2. REPLACE THE EXISTING PIPE WITH TWO 36"Ø HDPE PIPE STRONG ENOUGH TO SUSTAIN H-20 TRAFFIC LOADING, 25' LONG AND BACKFILL WITH SOIL COMPACTED TO 90% DRY DENSITY, WIDE ENOUGH TO REGAIN THE 14' ACCESS ROAD. 2'-0" OF GROUND COVER IS REQUIRED OVER THE HDPE PIPE.
3. FILL IN ERODED AREA ON THE EAST SIDE OF THE ROAD AND UNDER THE NEW PIPES WITH NEW COMPACTED SOIL. CREATE A 2:1 SLOPE LEAVING PIPE TO EXTEND 1' BEYOND THE SLOPE.
4. PLACE A FILTER FABRIC (MIRAFI 700X OR EQUAL) OVER THE SLOPE AND THEN PLACE 9"-12" RIP RAP OVER THE FABRIC. REFER TO SECTION A-A.

NOTE:  
CONTRACTOR TO FIELD VERIFY SOIL AND ROCK QUANTITIES AND LENGTH OF HDPE REQUIRED.

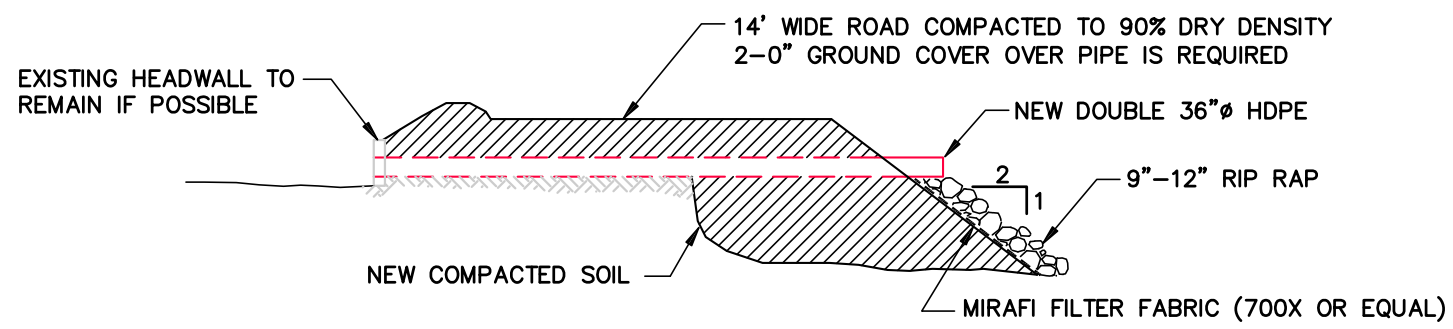

**SECTION A-A**  
SCALE: 1" = 10'

C									 <b>SAN DIEGO GAS &amp; ELECTRIC</b> CIVIL STRUCTURAL ENGINEERING <small>A Semptra Energy company</small>	<b>TASK TRACKER</b> W. OF TL13835/12 AND 223141 ACCESS ROAD EROSION REPAIR			
B													
A													
<b>REV</b>	<b>BUDGET</b>	<b>CONST</b>	<b>ORDER</b>	<b>ORIGINAL</b>		<b>CHANGE</b>	<b>DRAWN</b>	<b>CHK'D</b>	<b>APPV'D</b>	<b>DATE</b>	<b>SCALE: 1" = 50'</b>	<b>SHEET 1 OF 1</b>	<b>TT 10036</b>

**PHOTO DOCUMENT**  
**SDG&E WL 5.8 Road Repair, Z223141, CPEN TT10036, eTS 21593**  
Marine Corps Base Camp Pendleton  
AECOM Site Visit May 6, 2015



**Figure 1.** North-facing overview of road repair location.



**Figure 2.** East-facing view of drainage channel at outfall pipes.