

**CALIFORNIA REGIONAL WATER QUALITY CONTROL BOARD  
SAN DIEGO REGION**

2375 Northside Drive, Suite.100, San Diego, CA 92108  
Phone (619) 516-1990 • Fax (619) 516-1994  
<http://www.waterboards.ca.gov/sandiego/>

Clean Water Act Section 401 Water Quality Certification  
and Waste Discharge Requirements  
for Discharge of Dredged and/or Fill Materials

**PROJECT: Martha Residence Dock Replacement Project**  
**Certification Number R9-2019-0048**  
**WDID: 9 000003326**

Reg. Meas. ID: 422787 Place ID: 849177 Party ID: 581092 Person ID: 582743
--

**APPLICANT: Talal Martha**  
**7 Port of Spain**  
**Coronado, CA 92118**

**ACTION:**

<input checked="" type="checkbox"/> Order for Low Impact Certification	<input type="checkbox"/> Order for Denial of Certification
<input type="checkbox"/> Order for Technically-conditioned Certification	<input type="checkbox"/> Waiver of Waste Discharge Requirements
<input checked="" type="checkbox"/> Enrollment in SWRCB GWDR Order No. 2003-017-DWQ	<input type="checkbox"/> Enrollment in Isolated Waters Order No. 2004-004-DWQ

**PROJECT DESCRIPTION**

An application dated August 16, 2018 was submitted by Talal Martha (hereinafter Applicant), for Water Quality Certification pursuant to section 401 of the Clean Water Act (33 U.S.C. § 1341) for the proposed Martha Residence Dock Replacement (Project). The Applicant has also applied for authorization under Rivers and Harbors Act section 10 and Clean Water Act section 404 RGP 85 from the United States Army Corps of Engineers for the Project (USACE File No. SPL-2015-00366).

The Project is located within the City of Coronado, San Diego County, California at 7 Port of Spain. The Project center reading is located at latitude 32.372039 and longitude -117.080056.

The Applicant has paid all required fees for this Certification in the amount of \$1500.00. On an annual basis, the Applicant must also pay all active discharge fees and post discharge monitoring fees, as appropriate<sup>1</sup>. On January 2, 2019, the San Diego Water Board provided

<sup>1</sup> The Applicant shall pay an annual active discharge fee each fiscal year or portion of a fiscal year during which discharges occur until the regional water board or the State Water Resources Control Board (State Water Board) issues a Notice of Completion of Discharges Letter to the discharger. Dischargers shall pay an annual post-discharge monitoring fee each fiscal year or portion of a fiscal year commencing with the first fiscal year following the fiscal year in which the regional water board or State Water Board issued a Notice of Completion of Discharges Letter to the discharger, but continued water quality monitoring or compensatory mitigation monitoring is required. Dischargers shall pay the annual post-discharge monitoring fee each fiscal year until the regional water board or the State Water Board issues a Notice of Project Complete Letter to the discharger. Additional information regarding Water Quality Fees, Waste Discharge Requirement Fees, and Water Quality

*(footnote continued on next page)*

public notice of the Project application pursuant to California Code of Regulations, title 23, section 3858 by posting information describing the Project on the San Diego Water Board's web site and providing a period of twenty-one days for public review and comment. No comments were received.

The Applicant proposes to replace a dock system including dock, two guide piles, and a gangway. A barge and boom will be used to remove and install the system. Piles will be removed using the jetting method. A silt curtain will be utilized during removal and installation to prevent increases in turbidity. This project proposes to temporarily impact 0.002 acre of ocean waters through the removal and installation of the new pilings.

Additional Project details are provided in Attachments 2 of this Certification.

---

*(footnote continued from previous page)*

Certification Dredge and Fill Application Fee Calculator can be found electronically at the following location:  
[http://www.waterboards.ca.gov/resources/fees/water\\_quality/#wqfees](http://www.waterboards.ca.gov/resources/fees/water_quality/#wqfees).

## TABLE OF CONTENTS

I.	STANDARD CONDITIONS .....	4
II.	GENERAL CONDITIONS.....	4
III.	CONSTRUCTION BEST MANAGEMENT PRACTICES.....	7
IV.	PROJECT IMPACTS AND COMPENSATORY MITIGATION .....	8
V.	MONITORING AND REPORTING REQUIREMENTS.....	8
VI.	NOTIFICATION REQUIREMENTS .....	10
VII.	CALIFORNIA ENVIRONMENTAL QUALITY ACT COMPLIANCE .....	12
VIII.	SAN DIEGO WATER BOARD CONTACT PERSON.....	13
IX.	WATER QUALITY CERTIFICATION .....	13

### Attachments:

1. Definitions
2. Project Figures and Plans

The San Diego Water Board has independently reviewed the record of the Project to analyze the extent and nature of proposed Project impacts to the water quality and beneficial uses of waters of the United States and/or State and associated compensatory mitigation required to offset impacts attributed to the Project. In accordance with this Certification, the Applicant may proceed with the Project under the following terms and conditions:

## I. STANDARD CONDITIONS

Pursuant to section 3860 of title 23 of the California Code of Regulations, the following three standard conditions apply to all water quality certification actions:

- A. This Certification action is subject to modification or revocation upon administrative or judicial review, including review and amendment pursuant to section 13330 of the Water Code and chapter 28, article 6 (commencing with title 23, section 3867), of the California Code of Regulations.
- B. This Certification action is not intended and shall not be construed to apply to any discharge from any activity involving a hydroelectric facility and requiring a Federal Energy Regulatory Commission (FERC) license or an amendment to a FERC license unless the pertinent Certification application was filed pursuant to California Code of Regulations title 23, section 3855 subdivision (b), and that application specifically identified that a FERC license or amendment to a FERC license for a hydroelectric facility was being sought.
- C. This Certification action is conditioned upon total payment of any fee required under title 23, chapter 28 (commencing with section 3830) of California Code of Regulations and owed by the applicant.

## II. GENERAL CONDITIONS

- A. **Term of Certification.** Water Quality Certification No. R9-2019-0048 (Certification) shall expire upon a) the expiration or retraction of the Clean Water Act section 404 (33 U.S.C. §1344) permit issued by the U.S. Army Corps of Engineers for this Project, or b) five (5) years from the date of issuance of this Certification, whichever occurs first.
- B. **Duty to Comply.** The Applicant must comply with all conditions and requirements of this Certification. Any Certification noncompliance constitutes a violation of the Water Code and is grounds for enforcement action or Certification termination, revocation and reissuance, or modification.
- C. **General Waste Discharge Requirements.** The requirements of this Certification are enforceable through Water Quality Order No. 2003-0017-DWQ, *Statewide General Waste Discharge Requirements for Discharges of Dredged or Fill Material that have Received State Water Quality Certification* (Water Quality Order No. 2003-0017-DWQ). This provision shall apply irrespective of whether a) the federal permit for which the Certification was obtained is subsequently retracted or is expired, or b) the Certification is expired. Water Quality Order No. 2003-0017-DWQ is accessible at:

[http://www.waterboards.ca.gov/water\\_issues/programs/cwa401/docs/generalorders/gowdr401regulated\\_projects.pdf](http://www.waterboards.ca.gov/water_issues/programs/cwa401/docs/generalorders/gowdr401regulated_projects.pdf)

- D. **Project Conformance with Application.** All water quality protection measures and BMPs described in the application and supplemental information for water quality certification are incorporated by reference into this Certification as if fully stated herein. Notwithstanding any more specific conditions in this Certification, the Applicant shall construct, implement and comply with all water quality protection measures and BMPs described in the application and supplemental information. The conditions within this Certification shall supersede conflicting provisions within the application and supplemental information submitted as part of this Certification action.
- E. **Project Conformance with Water Quality Control Plans or Policies.** Notwithstanding any more specific conditions in this Certification, the Project shall be constructed in a manner consistent with the Basin Plan and any other applicable water quality control plans or policies adopted or approved pursuant to the Porter Cologne Water Quality Act (Division 7, commencing with Water Code Section 13000) or section 303 of the Clean Water Act (33 U.S.C §1313.). The Basin Plan is accessible on-line at:
- [http://www.waterboards.ca.gov/sandiego/water\\_issues/programs/basin\\_plan/index.shtml](http://www.waterboards.ca.gov/sandiego/water_issues/programs/basin_plan/index.shtml)  
!
- F. **Project Modification.** The Applicant must submit any changes to the Project, including Project operation, which would have a significant or material effect on the findings, conclusions, or conditions of this Certification, to the San Diego Water for prior review and written approval. If the San Diego Water Board is not notified of a significant change to the Project, it will be considered a violation of this Certification
- G. **Certification Distribution Posting.** During Project construction, the Applicant must maintain a copy of this Certification at the Project site. This Certification must be available at all times to site personnel and agencies. A copy of this Certification shall also be provided to any contractor or subcontractor performing construction work, and the copy shall remain in their possession at the Project site.
- H. **Inspection and Entry.** The Applicant must allow the San Diego Water Board or the State Water Resources Control Board, and/or their authorized representative(s) (including an authorized contractor acting as their representative), upon the presentation of credentials and other documents as may be required under law, to:
1. Enter upon the Project or Compensatory Mitigation site(s) premises where a regulated facility or activity is located or conducted, or where records must be kept under the conditions of this Certification;
  2. Have access to and copy, at reasonable times, any records that must be kept under the conditions of this Certification;

3. Inspect, at reasonable times, any facilities, equipment (including monitoring and control equipment), practices, or operations regulated or required under this Certification; and
  4. Sample or monitor, at reasonable times, for the purposes of assuring Certification compliance, or as otherwise authorized by the Clean Water Act or Water Code, any substances or parameters at any location.
- I. **Enforcement Notification.** In the event of any violation or threatened violation of the conditions of this Certification, the violation or threatened violation shall be subject to any remedies, penalties, process or sanctions as provided for under State law. For purposes of section 401(d) of the Clean Water Act, the applicability of any State law authorizing remedies, penalties, process or sanctions for the violation or threatened violation constitutes a limitation necessary to assure compliance with the water quality standards and other pertinent requirements incorporated into this Certification.
- J. **Certification Actions.** This Certification may be modified, revoked and reissued, or terminated for cause including but not limited to the following:
1. Violation of any term or condition of this Certification;
  2. Monitoring results indicate that continued Project activities could violate water quality objectives or impair the beneficial uses of San Diego Bay;
  3. Obtaining this Certification by misrepresentation or failure to disclose fully all relevant facts;
  4. A change in any condition that requires either a temporary or permanent reduction or elimination of the authorized discharge; and
  5. Incorporation of any new or revised water quality standards and implementation plans adopted or approved pursuant to the Porter-Cologne Water Quality Control Act or section 303 of the Clean Water Act.
- The filing of a request by the Applicant for modification, revocation and reissuance, or termination, or a notification of planned changes or anticipated noncompliance does not stay any Certification condition.
- K. **Duty to Provide Information.** The Applicant shall furnish to the San Diego Water Board, within a reasonable time, any information which the San Diego Water Board may request to determine whether cause exists for modifying, revoking and reissuing, or terminating this Certification or to determine compliance with this Certification.
- L. **Property Rights.** This Certification does not convey any property rights of any sort, or any exclusive privilege.
- M. **Petitions.** Any person aggrieved by this action of the San Diego Water Board may petition the State Water Resources Control Board (State Water Board) to review the

action in accordance with the California Code of Regulations, title 23, sections 3867 and following. The State Water Board must receive the petition by 5:00 p.m., 30 days after the date of this Certification. Copies of the law and regulations applicable to filing petitions may be found on the Internet at:

[http://www.waterboards.ca.gov/public\\_notices/petitions/water\\_quality](http://www.waterboards.ca.gov/public_notices/petitions/water_quality) or will be provided upon request.

### III. CONSTRUCTION BEST MANAGEMENT PRACTICES

- A. **Approvals to Commence Construction.** The Applicant shall not commence Project construction until all necessary federal, State, and local approvals are obtained.
- B. **Personnel Education.** Prior to the start of the Project, and annually thereafter, the Applicant must educate all personnel on the requirements in this Certification, pollution prevention measures, spill response measures, and BMP implementation and maintenance measures.
- C. **Spill Containment Materials.** The Applicant must, at all times, maintain appropriate types and sufficient quantities of materials on-site to contain any spill or inadvertent release of materials that may cause a condition of pollution or nuisance if the materials reach waters of the United States and/or State.
- D. **Waste Management.** The Applicant must properly manage, store, treat, and dispose of wastes in accordance with applicable federal, state, and local laws and regulations. Waste management shall be implemented to avoid or minimize exposure of wastes to precipitation or storm water runoff. The storage, handling, treatment, or disposal of waste shall not create conditions of pollution, contamination or nuisance as defined in Water Code section 13050. Upon Project completion, all Project generated debris, building materials, excess material, waste, and trash shall be removed from the Project site(s) for disposal at an authorized landfill or other disposal site in compliance with federal, state and local laws and regulations.
- E. **Waste Management.** Except for a discharge permitted under this Certification, the dumping, deposition, or discharge of trash, rubbish, unset cement or asphalt, concrete, grout, damaged concrete or asphalt, concrete or asphalt spoils, wash water, organic or earthen material, steel, sawdust or other construction debris waste from Project activities directly into waters of the United States and or State, or adjacent to such waters in any manner which may permit its being transported into the waters, is prohibited.
- F. **Construction Equipment.** All equipment must be washed prior to transport to the Project site and must be free of sediment, debris, and foreign matter. All equipment used in direct contact with surface water shall be steam cleaned prior to use. All equipment using gas, oil, hydraulic fluid, or other petroleum products shall be inspected for leaks prior to use and shall be monitored for leakage. Stationary equipment (e.g., motors, pumps, generator, etc.) shall be positioned over drip pans or other types of containment.

- G. **Process Water.** Water containing mud, silt, or other pollutants from equipment washing or other activities, must not be discharged to waters of the United States and/or State or placed in locations that may be subjected to storm water runoff flows. Pollutants discharged to areas within a stream diversion must be removed at the end of each work day or sooner if rain is predicted.
- H. **Hazardous Materials.** Except as authorized by this Certification, substances hazardous to aquatic life including, but not limited to, petroleum products, unused cement/concrete, asphalt, and coating materials, must be prevented from contaminating the soil and/or entering waters of the United States and/or State. BMPs must be implemented to prevent such discharges during each Project activity involving hazardous materials.
- I. **Beneficial Use Protection.** The Applicant must take all necessary measures to protect the beneficial uses of waters of San Diego Bay. This Certification requires compliance with all applicable requirements of the Basin Plan. If at any time, an unauthorized discharge to surface waters (including rivers or streams) occurs or monitoring indicates that the Project is violating, or threatens to violate, water quality objectives, the associated Project activities shall cease immediately and the San Diego Water Board shall be notified in accordance with Notification Requirement VI.B of this Certification. Associated Project activities may not resume without approval from the San Diego Water Board.

#### IV. PROJECT IMPACTS AND COMPENSATORY MITIGATION

- A. **Project Impacts Avoidance.** The Project must avoid and minimize adverse impacts to waters of the United States and/or State to the maximum extent practicable. In-water work must not cause a discharge of waste to San Diego Bay.
- B. **Eelgrass Impacts and Mitigation.** A pre-construction eelgrass survey must be completed in accordance with the requirements of the California Eelgrass Mitigation Policy (CEMP; National Marine Fisheries Service 2014) by a qualified biologist, prior to initiation of construction activities at the site. This survey must include both aerial and density characterization of the beds. If eelgrass is found during the pre-construction survey, a post-construction survey must be performed by a qualified biologist within 30 days following project completion to quantify any unanticipated losses to eelgrass habitat. Impacts must then be determined from a comparison of pre- and post-construction survey results. Impacts to eelgrass, if any, must be mitigated through conformance with the CEMP, which defines the mitigation ratio and other requirements to achieve mitigation for significant eelgrass impacts. If required following the post-construction survey, the CEMP defined mitigation must be developed; submitted and approved by the San Diego Water Board, U.S. Army Corps of Engineers, and National Marine Fisheries Service; and implemented to offset losses to eelgrass.

#### V. MONITORING AND REPORTING REQUIREMENTS

- A. **Annual Project Progress Reports.** The Applicant must submit annual Project progress reports describing compliance with all requirements of this Certification to the San Diego Water Board prior to **March 1** of each year following the issuance of this Certification, until the Project has reached completion. Annual Project Progress



Reports must be submitted even if Project construction has not begun. The monitoring period for each Annual Project Progress Report shall be January 1<sup>st</sup> through December 31<sup>st</sup> of each year. Annual Project Progress Reports must include, at a minimum, the following:

1. The names, qualifications, and affiliations of the persons contributing to the report;
2. The status, progress, and anticipated schedule for completion of Project construction activities;
3. A description of Project construction delays encountered or anticipated that may affect the schedule for construction completion; and
4. A description of each incident of noncompliance during the annual monitoring period and its cause, the period of the noncompliance including exact dates and times, and if the noncompliance has not been corrected, the anticipated time it is expected to continue; and the steps taken or planned to reduce, eliminate, and prevent reoccurrence of the noncompliance.

**B. Final Project Completion Report.** The Applicant must submit a Final Project Completion Report to the San Diego Water Board **within 30 days of completion** of the Project. The final report must include the following information:

1. Date of construction initiation;
2. Date of construction completion; and
3. As-built drawings of the Project, no bigger than 11”X17.”

**C. Reporting Authority.** The submittal of information required under this Certification, or in response to a suspected violation of any condition of this Certification, is required pursuant to Water Code section 13267 and 13383. Civil liability may be administratively imposed by the San Diego Water Board for failure to submit information pursuant to Water Code sections 13268 or 13385.

**D. Electronic Document Submittal.** The Applicant must submit all reports and information required under this Certification in electronic format via e-mail to [SanDiego@waterboards.ca.gov](mailto:SanDiego@waterboards.ca.gov). Documents over 50 megabytes will not be accepted via e-mail and must be placed on a disc and delivered to:

California Regional Water Quality Control Board  
San Diego Region  
Attn: 401 Certification No. R9-2019-0048849177:nnergans  
2375 Northside Drive, Suite 100  
San Diego, California 92108

Each electronic document must be submitted as a single file, in Portable Document Format (PDF), and converted to text searchable format using Optical Character

Recognition (OCR). All electronic documents must include scanned copies of all signature pages; electronic signatures will not be accepted. Electronic documents submitted to the San Diego Water Board must include the following identification numbers in the header or subject line: Certification No. R9-2019-0048:849177:ngergans.

**E. Document Signatory Requirements.** All applications, reports, or information submitted to the San Diego Water Board must be signed as follows:

1. For a corporation, by a responsible corporate officer of at least the level of vice president.
2. For a partnership or sole proprietorship, by a general partner or proprietor, respectively.
3. For a municipality, or a state, federal, or other public agency, by either a principal executive officer or ranking elected official.
4. A duly authorized representative may sign applications, reports, or information if:
  - a. The authorization is made in writing by a person described above.
  - b. The authorization specifies either an individual or position having responsibility for the overall operation of the regulated activity.
  - c. The written authorization is submitted to the San Diego Water Board Executive Officer.

If such authorization is no longer accurate because a different individual or position has responsibility for the overall operation of the Project, a new authorization satisfying the above requirements must be submitted to the San Diego Water Board prior to or together with any reports, information, or applications, to be signed by an authorized representative.

**F. Document Certification Requirements.** All applications, reports, or information submitted to the San Diego Water Board must be certified as follows:

*"I certify under penalty of law that I have personally examined and am familiar with the information submitted in this document and all attachments and that, based on my inquiry of those individuals immediately responsible for obtaining the information, I believe that the information is true, accurate, and complete. I am aware that there are significant penalties for submitting false information, including the possibility of fine and imprisonment."*

## **VI. NOTIFICATION REQUIREMENTS**

- A. Discharge Commencement.** The Applicant must notify the San Diego Water Board in writing **at least 5 days prior to** the start of Project construction.

- B. Twenty-Four Hour Non-Compliance Reporting.** The Applicant shall report any noncompliance which may endanger health or the environment. Any such information shall be provided orally to the San Diego Water Board within **24 hours** from the time the Applicant becomes aware of the circumstances. A written submission shall also be provided within five days of the time the Applicant becomes aware of the circumstances. The written submission shall contain a description of the noncompliance and its cause; the period of noncompliance, including exact dates and times, and if the noncompliance has not been corrected; the anticipated time it is expected to continue; and steps taken or planned to reduce, eliminate, and prevent recurrence of the noncompliance. The San Diego Water Board, or an authorized representative, may waive the written report on a case-by-case basis if the oral report has been received within 24 hours.
- C. Caulerpa Taxifolia.** The Applicant must conduct a surveillance-level survey for *Caulerpa taxifolia*, in accordance with the requirements in the National Marine Fisheries Service's *Caulerpa* Control Protocol (version 4), dated February 25, 2008, not more than 90 days before the initiation of construction to determine presence/absence of this species within the immediate vicinity of the project. If *Caulerpa taxifolia* is identified during a survey, or at any other time before, during, or within 120 days following completion of authorized activities, both National Marine Fisheries Service and California Department of Fish and Wildlife must be contacted within 24 hours of first noting the occurrence. In the event *Caulerpa taxifolia* is detected, all disturbing activity must cease until such time as the infestation has been isolated and treated, or the risk of spread from the disturbing activity is eliminated in accordance with the *Caulerpa* Control Protocol.
- D. Hazardous Substance Discharge.** Except as provided in Water Code section 13271(b), any person who, without regard to intent or negligence, causes or permits any hazardous substance or sewage to be discharged in or on any waters of the State, shall as soon as (a) that person has knowledge of the discharge, (b) notification is possible, and (c) notification can be provided without substantially impeding cleanup or other emergency measures, immediately notify the County of San Diego, in accordance with California Health and Safety Code section 5411.5 and the California Office of Emergency Services of the discharge in accordance with the spill reporting provision of the State toxic disaster contingency plan adopted pursuant to Government Code Title 2, Division 1, Chapter 7, Article 3.7 (commencing with section 8574.17), and immediately notify the State Water Board or the San Diego Water Board of the discharge. This provision does not require reporting of any discharge of less than a reportable quantity as provided for under subdivisions (f) and (g) of section 13271 of the Water Code unless the Applicant is in violation of a Basin Plan prohibition.
- E. Oil or Petroleum Product Discharge.** Except as provided in Water Code section 13272(b), any person who without regard to intent or negligence, causes or permits any oil or petroleum product to be discharged in or on any waters of the State, or discharged or deposited where it is, or probably will be, discharged in or on any waters of the State, shall, as soon as (a) such person has knowledge of the discharge, (b) notification is possible, and (c) notification can be provided without substantially impeding cleanup or other emergency measures, immediately notify the California Office of Emergency Services of the discharge in accordance with the spill reporting provision of the State oil

spill contingency plan adopted pursuant to Government Code Title 2, Division 1, Chapter 7, Article 3.7 (commencing with section 8574.1). This requirement does not require reporting of any discharge of less than 42 gallons unless the discharge is also required to be reported pursuant to Clean Water Act section 311, or the discharge is in violation of a Basin Plan prohibition.

- F. **Anticipated Noncompliance.** The Applicant shall give advance notice to the San Diego Water Board of any planned changes in the Project or the Compensatory Mitigation project which may result in noncompliance with Certification conditions or requirements.
- G. **Transfers.** This Certification is not transferable in its entirety or in part to any person or organization except after notice to the San Diego Water Board in accordance with the following terms:
1. **Transfer of Property Ownership:** The Applicant must notify the San Diego Water Board of any change in ownership of the Project area. Notification of change in ownership must include, but not be limited to, a statement that the Applicant has provided the purchaser with a copy of the Section 401 Water Quality Certification and that the purchaser understands and accepts the certification requirements and the obligation to implement them or be subject to liability for failure to do so; the seller and purchaser must sign and date the notification and provide such notification to the San Diego Water Board **within 10 days of the transfer of ownership.**
  2. **Transfer of Mitigation Responsibility:** Any notification of transfer of responsibilities to satisfy the mitigation requirements set forth in this Certification must include a signed statement from an authorized representative of the new party (transferee) demonstrating acceptance and understanding of the responsibility to comply with and fully satisfy the mitigation conditions and agreement that failure to comply with the mitigation conditions and associated requirements may subject the transferee to enforcement by the San Diego Water Board under Water Code section 13385, subdivision (a). Notification of transfer of responsibilities meeting the above conditions must be provided to the San Diego Water Board **within 10 days of the transfer date.**

Upon properly noticed transfers of responsibility, the transferee assumes responsibility for compliance with this Certification and references in this Certification to the Applicant will be interpreted to refer to the transferee as appropriate. Transfer of responsibility does not necessarily relieve the Applicant of this Certification in the event that a transferee fails to comply.

## VII. CALIFORNIA ENVIRONMENTAL QUALITY ACT COMPLIANCE

- A. The City of Coronado is the Lead Agency under the California Environmental Quality Act (CEQA) (Public Resources Code section 21000, et seq.) section 21067, and CEQA

Guidelines (California Code of Regulations, title 14, section 15000 et seq.) section 15367, and has determined that the Project is categorically exempt.<sup>2</sup>

- B. The San Diego Water Board is a Responsible Agency under CEQA (Public Resources Code section 21069; CEQA Guidelines section 15381). The San Diego Water Board has independently determined that the project is categorically exempt because the project replaces existing structures located on the same site and the replacement structures will have substantially the same purpose and capacity as the structures being replaced.<sup>3</sup>
- C. As a Responsible Agency under CEQA, the San Diego Water Board will file a Notice of Exemption in accordance with CEQA Guidelines section 15062.

## VIII. SAN DIEGO WATER BOARD CONTACT PERSON

Nicole Gergans, Environmental Scientist  
California Regional Water Quality Control Board, San Diego Region  
2375 Northside Drive, Suite 100  
San Diego, California, 92108  
Telephone: 619-521-3367  
Email: [nicole.gergans@waterboards.ca.gov](mailto:nicole.gergans@waterboards.ca.gov)

## IX. WATER QUALITY CERTIFICATION

I hereby certify that the proposed discharge from the **Martha Residence Dock Replacement Project** (Certification No. R9-2019-0048) will comply with the applicable provisions of sections 301 ("Effluent Limitations"), 302 ("Water Quality Related Effluent Limitations"), 303 ("Water Quality Standards and Implementation Plans"), 306 ("National Standards of Performance"), and 307 ("Toxic and Pretreatment Effluent Standards") of the Clean Water Act. This discharge is also regulated under State Water Board Order No. 2003-0017-DWQ, "*Statewide General Waste Discharge Requirements for Dredged or Fill Discharges that have Received State Water Quality Certification (General WDRs)*," which requires compliance with all conditions of this Water Quality Certification. Please note that enrollment under Order No. 2003-017-DWQ is conditional and, should new information come to our attention that indicates a water quality problem, the San Diego Water Board may issue individual waste discharge requirements at that time.

Except insofar as may be modified by any preceding conditions, all Certification actions are contingent on (a) the discharge being limited to, and all proposed mitigation being completed in strict compliance with, the applicants' Project description and/or the description in this Certification, and (b) compliance with all applicable requirements of the Basin Plan.

---

<sup>2</sup> 14 CCR § 15302

<sup>3</sup> 14 CCR § 15302

I, David W. Gibson, Executive Officer, do hereby certify the forgoing is a full, true, and correct copy of Certification No. R9-2019-0048 issued on February 14, 2019.

---

DAVID W. GIBSON  
Executive Officer  
San Diego Water Board

---

Date

# ATTACHMENT 1

## DEFINITIONS

**Activity** - when used in reference to a permit means any action, undertaking, or project including, but not limited to, construction, operation, maintenance, repair, modification, and restoration which may result in any discharge to waters of the state.

**Buffer** - means an upland, wetland, and/or riparian area that protects and/or enhances aquatic resource functions associated with wetlands, rivers, streams, lakes, marine, and estuarine systems from disturbances associated with adjacent land uses.

**California Rapid Assessment Method (CRAM)** - is a wetland assessment method intended to provide a rapid, scientifically-defensible and repeatable assessment methodology to monitor status and trends in the conditions of wetlands for applications throughout the state. It can also be used to assess the performance of compensatory mitigation projects and restoration projects. CRAM provides an assessment of overall ecological condition in terms of four attributes: landscape context and buffer, hydrology, physical structure and biotic structure. CRAM also includes an assessment of key stressors that may be affecting wetland condition and a "field to PC" data management tool (eCRAM) to ensure consistency and quality of data produced with the method.

**Compensatory Mitigation Project** - means compensatory mitigation implemented by the Applicant as a requirement of this Certification (i.e., applicant -responsible mitigation), or by a mitigation bank or an in-lieu fee program.

**Discharge of dredged material** – means any addition of dredged material into, including redeposit of dredged material other than incidental fallback within, the waters of the United States and/or State.

**Discharge of fill material** – means the addition of fill material into waters of the United States and/or State.

**Dredged material** – means material that is excavated or dredged from waters of the United States and/or State.

**Ecological Success Performance Standards** – means observable or measurable physical (including hydrological), chemical, and/or biological attributes that are used to determine if a compensatory mitigation project meets its objectives.

**Enhancement** – means the manipulation of the physical, chemical, or biological characteristics of an aquatic resource to improve a specific aquatic resource function(s). Enhancement results in the gain of selected aquatic resource function(s), but may also lead to a decline in other aquatic resource function(s). Enhancement does not result in a gain in aquatic resource area.

**Establishment** – means the manipulation of the physical, chemical, or biological characteristics present to develop an aquatic resource that did not previously exist. Creation results in a gain in aquatic resource area.

**Fill material** – means any material used for the primary purpose of replacing an aquatic area with dry land or of changing the bottom elevation of a water body.

**Isolated wetland** – means a wetland with no surface water connection to other aquatic resources.

**Mitigation Bank** – means a site, or suite of sites, where resources (e.g., wetlands, streams, riparian areas) are restored, established, enhanced, and/or preserved for the purpose of providing mitigation for impacts authorized by this Certification.

**Preservation** - means the removal of a threat to, or preventing the decline of, aquatic resources by an action in or near those aquatic resources. This term includes activities commonly associated with the protection and maintenance of aquatic resources through the implementation of appropriate legal and physical mechanisms. Preservation does not result in a gain of aquatic resource area or functions.

**Re-establishment** - means the manipulation of the physical, chemical, or biological characteristics of a site with the goal of returning natural/ historic functions to a former aquatic resource. Re-establishment results in rebuilding a former aquatic resource and results in a gain in aquatic resource area and functions.

**Rehabilitation** - means the manipulation of the physical, chemical, or biological characteristics of a site with the goal of repairing natural/ historic functions to a degraded aquatic resource. Rehabilitation results in a gain in aquatic resource function, but does not result in a gain in aquatic resource area.

**Restoration** - means the manipulation of the physical, chemical, or biological characteristics of a site with the goal of returning natural/historic functions to a former or degraded aquatic resource. For the purpose of tracking net gains in aquatic resource area, restoration is divided into two categories: re-establishment and rehabilitation.

**Start of Project Construction** - For the purpose of this Certification, "start of Project construction" means to engage in a program of on-site construction, including site clearing, grading, dredging, landfilling, changing equipment, substituting equipment, or even moving the location of equipment specifically designed for a stationary source in preparation for the fabrication, erection or installation of the building components of the stationary source within waters of the United States and/or State.

**Uplands** - means non-wetland areas that lack any field-based indicators of wetlands or other aquatic conditions. Uplands are generally well-drained and occur above (i.e., up-slope) from nearby aquatic areas. Wetlands can, however, be entirely surrounded by uplands. For example, some natural seeps and constructed stock ponds lack aboveground hydrological connection to other aquatic areas. In the watershed context, uplands comprise the landscape matrix in which aquatic areas form. They are the primary sources of sediment, surface runoff, and associated chemicals that are deposited in aquatic areas or transported through them.

**Water quality objectives and other appropriate requirements of state law** – means the water quality objectives and beneficial uses as specified in the appropriate water quality control plan(s); the applicable provisions of sections 301, 302, 303, 306, and 307 of the Clean Water Act; and any other appropriate requirement of state law.



public notice of the Project application pursuant to California Code of Regulations, title 23, section 3858 by posting information describing the Project on the San Diego Water Board's web site and providing a period of twenty-one days for public review and comment. No comments were received.

The Applicant proposes to replace a dock system including dock, two guide piles, and a gangway. A barge and boom will be used to remove and install the system. Piles will be removed using the jetting method. A silt curtain will be utilized during removal and installation to prevent increases in turbidity. This project proposes to temporarily impact 0.002 acre of ocean waters through the removal and installation of the new pilings.

Additional Project details are provided in Attachments 2 of this Certification.

---

*(footnote continued from previous page)*

Certification Dredge and Fill Application Fee Calculator can be found electronically at the following location:  
[http://www.waterboards.ca.gov/resources/fees/water\\_quality/#wqfees](http://www.waterboards.ca.gov/resources/fees/water_quality/#wqfees).

## TABLE OF CONTENTS

<b>I.</b>	<b>STANDARD CONDITIONS .....</b>	<b>4</b>
<b>II.</b>	<b>GENERAL CONDITIONS.....</b>	<b>4</b>
<b>III.</b>	<b>CONSTRUCTION BEST MANAGEMENT PRACTICES.....</b>	<b>7</b>
<b>IV.</b>	<b>PROJECT IMPACTS AND COMPENSATORY MITIGATION .....</b>	<b>8</b>
<b>V.</b>	<b>MONITORING AND REPORTING REQUIREMENTS.....</b>	<b>8</b>
<b>VI.</b>	<b>NOTIFICATION REQUIREMENTS .....</b>	<b>10</b>
<b>VII.</b>	<b>CALIFORNIA ENVIRONMENTAL QUALITY ACT COMPLIANCE .....</b>	<b>12</b>
<b>VIII.</b>	<b>SAN DIEGO WATER BOARD CONTACT PERSON.....</b>	<b>13</b>
<b>IX.</b>	<b>WATER QUALITY CERTIFICATION .....</b>	<b>13</b>

### Attachments:

- 1. Definitions**
- 2. Project Figures and Plans**

The San Diego Water Board has independently reviewed the record of the Project to analyze the extent and nature of proposed Project impacts to the water quality and beneficial uses of waters of the United States and/or State and associated compensatory mitigation required to offset impacts attributed to the Project. In accordance with this Certification, the Applicant may proceed with the Project under the following terms and conditions:

## I. STANDARD CONDITIONS

Pursuant to section 3860 of title 23 of the California Code of Regulations, the following three standard conditions apply to all water quality certification actions:

- A. This Certification action is subject to modification or revocation upon administrative or judicial review, including review and amendment pursuant to section 13330 of the Water Code and chapter 28, article 6 (commencing with title 23, section 3867), of the California Code of Regulations.
- B. This Certification action is not intended and shall not be construed to apply to any discharge from any activity involving a hydroelectric facility and requiring a Federal Energy Regulatory Commission (FERC) license or an amendment to a FERC license unless the pertinent Certification application was filed pursuant to California Code of Regulations title 23, section 3855 subdivision (b), and that application specifically identified that a FERC license or amendment to a FERC license for a hydroelectric facility was being sought.
- C. This Certification action is conditioned upon total payment of any fee required under title 23, chapter 28 (commencing with section 3830) of California Code of Regulations and owed by the applicant.

## II. GENERAL CONDITIONS

- A. **Term of Certification.** Water Quality Certification No. R9-2019-0048 (Certification) shall expire upon a) the expiration or retraction of the Clean Water Act section 404 (33 U.S.C. §1344) permit issued by the U.S. Army Corps of Engineers for this Project, or b) five (5) years from the date of issuance of this Certification, whichever occurs first.
- B. **Duty to Comply.** The Applicant must comply with all conditions and requirements of this Certification. Any Certification noncompliance constitutes a violation of the Water Code and is grounds for enforcement action or Certification termination, revocation and reissuance, or modification.
- C. **General Waste Discharge Requirements.** The requirements of this Certification are enforceable through Water Quality Order No. 2003-0017-DWQ, *Statewide General Waste Discharge Requirements for Discharges of Dredged or Fill Material that have Received State Water Quality Certification* (Water Quality Order No. 2003-0017-DWQ). This provision shall apply irrespective of whether a) the federal permit for which the Certification was obtained is subsequently retracted or is expired, or b) the Certification is expired. Water Quality Order No. 2003-0017-DWQ is accessible at:

[http://www.waterboards.ca.gov/water\\_issues/programs/cwa401/docs/generalorders/gowdr401regulated\\_projects.pdf](http://www.waterboards.ca.gov/water_issues/programs/cwa401/docs/generalorders/gowdr401regulated_projects.pdf)

- D. **Project Conformance with Application.** All water quality protection measures and BMPs described in the application and supplemental information for water quality certification are incorporated by reference into this Certification as if fully stated herein. Notwithstanding any more specific conditions in this Certification, the Applicant shall construct, implement and comply with all water quality protection measures and BMPs described in the application and supplemental information. The conditions within this Certification shall supersede conflicting provisions within the application and supplemental information submitted as part of this Certification action.
- E. **Project Conformance with Water Quality Control Plans or Policies.** Notwithstanding any more specific conditions in this Certification, the Project shall be constructed in a manner consistent with the Basin Plan and any other applicable water quality control plans or policies adopted or approved pursuant to the Porter Cologne Water Quality Act (Division 7, commencing with Water Code Section 13000) or section 303 of the Clean Water Act (33 U.S.C §1313.). The Basin Plan is accessible on-line at:
- [http://www.waterboards.ca.gov/sandiego/water\\_issues/programs/basin\\_plan/index.shtml](http://www.waterboards.ca.gov/sandiego/water_issues/programs/basin_plan/index.shtml)  
!
- F. **Project Modification.** The Applicant must submit any changes to the Project, including Project operation, which would have a significant or material effect on the findings, conclusions, or conditions of this Certification, to the San Diego Water for prior review and written approval. If the San Diego Water Board is not notified of a significant change to the Project, it will be considered a violation of this Certification
- G. **Certification Distribution Posting.** During Project construction, the Applicant must maintain a copy of this Certification at the Project site. This Certification must be available at all times to site personnel and agencies. A copy of this Certification shall also be provided to any contractor or subcontractor performing construction work, and the copy shall remain in their possession at the Project site.
- H. **Inspection and Entry.** The Applicant must allow the San Diego Water Board or the State Water Resources Control Board, and/or their authorized representative(s) (including an authorized contractor acting as their representative), upon the presentation of credentials and other documents as may be required under law, to:
1. Enter upon the Project or Compensatory Mitigation site(s) premises where a regulated facility or activity is located or conducted, or where records must be kept under the conditions of this Certification;
  2. Have access to and copy, at reasonable times, any records that must be kept under the conditions of this Certification;

3. Inspect, at reasonable times, any facilities, equipment (including monitoring and control equipment), practices, or operations regulated or required under this Certification; and
  4. Sample or monitor, at reasonable times, for the purposes of assuring Certification compliance, or as otherwise authorized by the Clean Water Act or Water Code, any substances or parameters at any location.
- I. **Enforcement Notification.** In the event of any violation or threatened violation of the conditions of this Certification, the violation or threatened violation shall be subject to any remedies, penalties, process or sanctions as provided for under State law. For purposes of section 401(d) of the Clean Water Act, the applicability of any State law authorizing remedies, penalties, process or sanctions for the violation or threatened violation constitutes a limitation necessary to assure compliance with the water quality standards and other pertinent requirements incorporated into this Certification.
- J. **Certification Actions.** This Certification may be modified, revoked and reissued, or terminated for cause including but not limited to the following:
1. Violation of any term or condition of this Certification;
  2. Monitoring results indicate that continued Project activities could violate water quality objectives or impair the beneficial uses of San Diego Bay;
  3. Obtaining this Certification by misrepresentation or failure to disclose fully all relevant facts;
  4. A change in any condition that requires either a temporary or permanent reduction or elimination of the authorized discharge; and
  5. Incorporation of any new or revised water quality standards and implementation plans adopted or approved pursuant to the Porter-Cologne Water Quality Control Act or section 303 of the Clean Water Act.
- The filing of a request by the Applicant for modification, revocation and reissuance, or termination, or a notification of planned changes or anticipated noncompliance does not stay any Certification condition.
- K. **Duty to Provide Information.** The Applicant shall furnish to the San Diego Water Board, within a reasonable time, any information which the San Diego Water Board may request to determine whether cause exists for modifying, revoking and reissuing, or terminating this Certification or to determine compliance with this Certification.
- L. **Property Rights.** This Certification does not convey any property rights of any sort, or any exclusive privilege.
- M. **Petitions.** Any person aggrieved by this action of the San Diego Water Board may petition the State Water Resources Control Board (State Water Board) to review the

action in accordance with the California Code of Regulations, title 23, sections 3867 and following. The State Water Board must receive the petition by 5:00 p.m., 30 days after the date of this Certification. Copies of the law and regulations applicable to filing petitions may be found on the Internet at:

[http://www.waterboards.ca.gov/public\\_notices/petitions/water\\_quality](http://www.waterboards.ca.gov/public_notices/petitions/water_quality) or will be provided upon request.

### III. CONSTRUCTION BEST MANAGEMENT PRACTICES

- A. **Approvals to Commence Construction.** The Applicant shall not commence Project construction until all necessary federal, State, and local approvals are obtained.
- B. **Personnel Education.** Prior to the start of the Project, and annually thereafter, the Applicant must educate all personnel on the requirements in this Certification, pollution prevention measures, spill response measures, and BMP implementation and maintenance measures.
- C. **Spill Containment Materials.** The Applicant must, at all times, maintain appropriate types and sufficient quantities of materials on-site to contain any spill or inadvertent release of materials that may cause a condition of pollution or nuisance if the materials reach waters of the United States and/or State.
- D. **Waste Management.** The Applicant must properly manage, store, treat, and dispose of wastes in accordance with applicable federal, state, and local laws and regulations. Waste management shall be implemented to avoid or minimize exposure of wastes to precipitation or storm water runoff. The storage, handling, treatment, or disposal of waste shall not create conditions of pollution, contamination or nuisance as defined in Water Code section 13050. Upon Project completion, all Project generated debris, building materials, excess material, waste, and trash shall be removed from the Project site(s) for disposal at an authorized landfill or other disposal site in compliance with federal, state and local laws and regulations.
- E. **Waste Management.** Except for a discharge permitted under this Certification, the dumping, deposition, or discharge of trash, rubbish, unset cement or asphalt, concrete, grout, damaged concrete or asphalt, concrete or asphalt spoils, wash water, organic or earthen material, steel, sawdust or other construction debris waste from Project activities directly into waters of the United States and or State, or adjacent to such waters in any manner which may permit its being transported into the waters, is prohibited.
- F. **Construction Equipment.** All equipment must be washed prior to transport to the Project site and must be free of sediment, debris, and foreign matter. All equipment used in direct contact with surface water shall be steam cleaned prior to use. All equipment using gas, oil, hydraulic fluid, or other petroleum products shall be inspected for leaks prior to use and shall be monitored for leakage. Stationary equipment (e.g., motors, pumps, generator, etc.) shall be positioned over drip pans or other types of containment.

- G. **Process Water.** Water containing mud, silt, or other pollutants from equipment washing or other activities, must not be discharged to waters of the United States and/or State or placed in locations that may be subjected to storm water runoff flows. Pollutants discharged to areas within a stream diversion must be removed at the end of each work day or sooner if rain is predicted.
- H. **Hazardous Materials.** Except as authorized by this Certification, substances hazardous to aquatic life including, but not limited to, petroleum products, unused cement/concrete, asphalt, and coating materials, must be prevented from contaminating the soil and/or entering waters of the United States and/or State. BMPs must be implemented to prevent such discharges during each Project activity involving hazardous materials.
- I. **Beneficial Use Protection.** The Applicant must take all necessary measures to protect the beneficial uses of waters of San Diego Bay. This Certification requires compliance with all applicable requirements of the Basin Plan. If at any time, an unauthorized discharge to surface waters (including rivers or streams) occurs or monitoring indicates that the Project is violating, or threatens to violate, water quality objectives, the associated Project activities shall cease immediately and the San Diego Water Board shall be notified in accordance with Notification Requirement VI.B of this Certification. Associated Project activities may not resume without approval from the San Diego Water Board.

#### IV. PROJECT IMPACTS AND COMPENSATORY MITIGATION

- A. **Project Impacts Avoidance.** The Project must avoid and minimize adverse impacts to waters of the United States and/or State to the maximum extent practicable. In-water work must not cause a discharge of waste to San Diego Bay.
- B. **Eelgrass Impacts and Mitigation.** A pre-construction eelgrass survey must be completed in accordance with the requirements of the California Eelgrass Mitigation Policy (CEMP; National Marine Fisheries Service 2014) by a qualified biologist, prior to initiation of construction activities at the site. This survey must include both aerial and density characterization of the beds. If eelgrass is found during the pre-construction survey, a post-construction survey must be performed by a qualified biologist within 30 days following project completion to quantify any unanticipated losses to eelgrass habitat. Impacts must then be determined from a comparison of pre- and post-construction survey results. Impacts to eelgrass, if any, must be mitigated through conformance with the CEMP, which defines the mitigation ratio and other requirements to achieve mitigation for significant eelgrass impacts. If required following the post-construction survey, the CEMP defined mitigation must be developed; submitted and approved by the San Diego Water Board, U.S. Army Corps of Engineers, and National Marine Fisheries Service; and implemented to offset losses to eelgrass.

#### V. MONITORING AND REPORTING REQUIREMENTS

- A. **Annual Project Progress Reports.** The Applicant must submit annual Project progress reports describing compliance with all requirements of this Certification to the San Diego Water Board prior to **March 1** of each year following the issuance of this Certification, until the Project has reached completion. Annual Project Progress

Reports must be submitted even if Project construction has not begun. The monitoring period for each Annual Project Progress Report shall be January 1<sup>st</sup> through December 31<sup>st</sup> of each year. Annual Project Progress Reports must include, at a minimum, the following:

1. The names, qualifications, and affiliations of the persons contributing to the report;
2. The status, progress, and anticipated schedule for completion of Project construction activities;
3. A description of Project construction delays encountered or anticipated that may affect the schedule for construction completion; and
4. A description of each incident of noncompliance during the annual monitoring period and its cause, the period of the noncompliance including exact dates and times, and if the noncompliance has not been corrected, the anticipated time it is expected to continue; and the steps taken or planned to reduce, eliminate, and prevent reoccurrence of the noncompliance.

**B. Final Project Completion Report.** The Applicant must submit a Final Project Completion Report to the San Diego Water Board **within 30 days of completion** of the Project. The final report must include the following information:

1. Date of construction initiation;
2. Date of construction completion; and
3. As-built drawings of the Project, no bigger than 11”X17.”

**C. Reporting Authority.** The submittal of information required under this Certification, or in response to a suspected violation of any condition of this Certification, is required pursuant to Water Code section 13267 and 13383. Civil liability may be administratively imposed by the San Diego Water Board for failure to submit information pursuant to Water Code sections 13268 or 13385.

**D. Electronic Document Submittal.** The Applicant must submit all reports and information required under this Certification in electronic format via e-mail to [SanDiego@waterboards.ca.gov](mailto:SanDiego@waterboards.ca.gov). Documents over 50 megabytes will not be accepted via e-mail and must be placed on a disc and delivered to:

California Regional Water Quality Control Board  
San Diego Region  
Attn: 401 Certification No. R9-2019-0048849177:nnergans  
2375 Northside Drive, Suite 100  
San Diego, California 92108

Each electronic document must be submitted as a single file, in Portable Document Format (PDF), and converted to text searchable format using Optical Character



Recognition (OCR). All electronic documents must include scanned copies of all signature pages; electronic signatures will not be accepted. Electronic documents submitted to the San Diego Water Board must include the following identification numbers in the header or subject line: Certification No. R9-2019-0048:849177:ngergans.

**E. Document Signatory Requirements.** All applications, reports, or information submitted to the San Diego Water Board must be signed as follows:

1. For a corporation, by a responsible corporate officer of at least the level of vice president.
2. For a partnership or sole proprietorship, by a general partner or proprietor, respectively.
3. For a municipality, or a state, federal, or other public agency, by either a principal executive officer or ranking elected official.
4. A duly authorized representative may sign applications, reports, or information if:
  - a. The authorization is made in writing by a person described above.
  - b. The authorization specifies either an individual or position having responsibility for the overall operation of the regulated activity.
  - c. The written authorization is submitted to the San Diego Water Board Executive Officer.

If such authorization is no longer accurate because a different individual or position has responsibility for the overall operation of the Project, a new authorization satisfying the above requirements must be submitted to the San Diego Water Board prior to or together with any reports, information, or applications, to be signed by an authorized representative.

**F. Document Certification Requirements.** All applications, reports, or information submitted to the San Diego Water Board must be certified as follows:

*"I certify under penalty of law that I have personally examined and am familiar with the information submitted in this document and all attachments and that, based on my inquiry of those individuals immediately responsible for obtaining the information, I believe that the information is true, accurate, and complete. I am aware that there are significant penalties for submitting false information, including the possibility of fine and imprisonment."*

**VI. NOTIFICATION REQUIREMENTS**

- A. Discharge Commencement.** The Applicant must notify the San Diego Water Board in writing **at least 5 days prior to** the start of Project construction.

- B. Twenty-Four Hour Non-Compliance Reporting.** The Applicant shall report any noncompliance which may endanger health or the environment. Any such information shall be provided orally to the San Diego Water Board within **24 hours** from the time the Applicant becomes aware of the circumstances. A written submission shall also be provided within five days of the time the Applicant becomes aware of the circumstances. The written submission shall contain a description of the noncompliance and its cause; the period of noncompliance, including exact dates and times, and if the noncompliance has not been corrected; the anticipated time it is expected to continue; and steps taken or planned to reduce, eliminate, and prevent recurrence of the noncompliance. The San Diego Water Board, or an authorized representative, may waive the written report on a case-by-case basis if the oral report has been received within 24 hours.
- C. Caulerpa Taxifolia.** The Applicant must conduct a surveillance-level survey for *Caulerpa taxifolia*, in accordance with the requirements in the National Marine Fisheries Service's *Caulerpa* Control Protocol (version 4), dated February 25, 2008, not more than 90 days before the initiation of construction to determine presence/absence of this species within the immediate vicinity of the project. If *Caulerpa taxifolia* is identified during a survey, or at any other time before, during, or within 120 days following completion of authorized activities, both National Marine Fisheries Service and California Department of Fish and Wildlife must be contacted within 24 hours of first noting the occurrence. In the event *Caulerpa taxifolia* is detected, all disturbing activity must cease until such time as the infestation has been isolated and treated, or the risk of spread from the disturbing activity is eliminated in accordance with the *Caulerpa* Control Protocol.
- D. Hazardous Substance Discharge.** Except as provided in Water Code section 13271(b), any person who, without regard to intent or negligence, causes or permits any hazardous substance or sewage to be discharged in or on any waters of the State, shall as soon as (a) that person has knowledge of the discharge, (b) notification is possible, and (c) notification can be provided without substantially impeding cleanup or other emergency measures, immediately notify the County of San Diego, in accordance with California Health and Safety Code section 5411.5 and the California Office of Emergency Services of the discharge in accordance with the spill reporting provision of the State toxic disaster contingency plan adopted pursuant to Government Code Title 2, Division 1, Chapter 7, Article 3.7 (commencing with section 8574.17), and immediately notify the State Water Board or the San Diego Water Board of the discharge. This provision does not require reporting of any discharge of less than a reportable quantity as provided for under subdivisions (f) and (g) of section 13271 of the Water Code unless the Applicant is in violation of a Basin Plan prohibition.
- E. Oil or Petroleum Product Discharge.** Except as provided in Water Code section 13272(b), any person who without regard to intent or negligence, causes or permits any oil or petroleum product to be discharged in or on any waters of the State, or discharged or deposited where it is, or probably will be, discharged in or on any waters of the State, shall, as soon as (a) such person has knowledge of the discharge, (b) notification is possible, and (c) notification can be provided without substantially impeding cleanup or other emergency measures, immediately notify the California Office of Emergency Services of the discharge in accordance with the spill reporting provision of the State oil

spill contingency plan adopted pursuant to Government Code Title 2, Division 1, Chapter 7, Article 3.7 (commencing with section 8574.1). This requirement does not require reporting of any discharge of less than 42 gallons unless the discharge is also required to be reported pursuant to Clean Water Act section 311, or the discharge is in violation of a Basin Plan prohibition.

- F. **Anticipated Noncompliance.** The Applicant shall give advance notice to the San Diego Water Board of any planned changes in the Project or the Compensatory Mitigation project which may result in noncompliance with Certification conditions or requirements.
- G. **Transfers.** This Certification is not transferable in its entirety or in part to any person or organization except after notice to the San Diego Water Board in accordance with the following terms:
1. **Transfer of Property Ownership:** The Applicant must notify the San Diego Water Board of any change in ownership of the Project area. Notification of change in ownership must include, but not be limited to, a statement that the Applicant has provided the purchaser with a copy of the Section 401 Water Quality Certification and that the purchaser understands and accepts the certification requirements and the obligation to implement them or be subject to liability for failure to do so; the seller and purchaser must sign and date the notification and provide such notification to the San Diego Water Board **within 10 days of the transfer of ownership.**
  2. **Transfer of Mitigation Responsibility:** Any notification of transfer of responsibilities to satisfy the mitigation requirements set forth in this Certification must include a signed statement from an authorized representative of the new party (transferee) demonstrating acceptance and understanding of the responsibility to comply with and fully satisfy the mitigation conditions and agreement that failure to comply with the mitigation conditions and associated requirements may subject the transferee to enforcement by the San Diego Water Board under Water Code section 13385, subdivision (a). Notification of transfer of responsibilities meeting the above conditions must be provided to the San Diego Water Board **within 10 days of the transfer date.**

Upon properly noticed transfers of responsibility, the transferee assumes responsibility for compliance with this Certification and references in this Certification to the Applicant will be interpreted to refer to the transferee as appropriate. Transfer of responsibility does not necessarily relieve the Applicant of this Certification in the event that a transferee fails to comply.

## VII. CALIFORNIA ENVIRONMENTAL QUALITY ACT COMPLIANCE

- A. The City of Coronado is the Lead Agency under the California Environmental Quality Act (CEQA) (Public Resources Code section 21000, et seq.) section 21067, and CEQA

Guidelines (California Code of Regulations, title 14, section 15000 et seq.) section 15367, and has determined that the Project is categorically exempt.<sup>2</sup>

- B. The San Diego Water Board is a Responsible Agency under CEQA (Public Resources Code section 21069; CEQA Guidelines section 15381). The San Diego Water Board has independently determined that the project is categorically exempt because the project replaces existing structures located on the same site and the replacement structures will have substantially the same purpose and capacity as the structures being replaced.<sup>3</sup>
- C. As a Responsible Agency under CEQA, the San Diego Water Board will file a Notice of Exemption in accordance with CEQA Guidelines section 15062.

## VIII. SAN DIEGO WATER BOARD CONTACT PERSON

Nicole Gergans, Environmental Scientist  
California Regional Water Quality Control Board, San Diego Region  
2375 Northside Drive, Suite 100  
San Diego, California, 92108  
Telephone: 619-521-3367  
Email: [nicole.gergans@waterboards.ca.gov](mailto:nicole.gergans@waterboards.ca.gov)

## IX. WATER QUALITY CERTIFICATION

I hereby certify that the proposed discharge from the **Martha Residence Dock Replacement Project** (Certification No. R9-2019-0048) will comply with the applicable provisions of sections 301 ("Effluent Limitations"), 302 ("Water Quality Related Effluent Limitations"), 303 ("Water Quality Standards and Implementation Plans"), 306 ("National Standards of Performance"), and 307 ("Toxic and Pretreatment Effluent Standards") of the Clean Water Act. This discharge is also regulated under State Water Board Order No. 2003-0017-DWQ, "*Statewide General Waste Discharge Requirements for Dredged or Fill Discharges that have Received State Water Quality Certification (General WDRs)*," which requires compliance with all conditions of this Water Quality Certification. Please note that enrollment under Order No. 2003-017-DWQ is conditional and, should new information come to our attention that indicates a water quality problem, the San Diego Water Board may issue individual waste discharge requirements at that time.

Except insofar as may be modified by any preceding conditions, all Certification actions are contingent on (a) the discharge being limited to, and all proposed mitigation being completed in strict compliance with, the applicants' Project description and/or the description in this Certification, and (b) compliance with all applicable requirements of the Basin Plan.

---

<sup>2</sup> 14 CCR § 15302

<sup>3</sup> 14 CCR § 15302

I, David W. Gibson, Executive Officer, do hereby certify the forgoing is a full, true, and correct copy of Certification No. R9-2019-0048 issued on February 14, 2019.



DAVID W. GIBSON  
Executive Officer  
San Diego Water Board

14 February 2019

Date

# ATTACHMENT 1

## DEFINITIONS

**Activity** - when used in reference to a permit means any action, undertaking, or project including, but not limited to, construction, operation, maintenance, repair, modification, and restoration which may result in any discharge to waters of the state.

**Buffer** - means an upland, wetland, and/or riparian area that protects and/or enhances aquatic resource functions associated with wetlands, rivers, streams, lakes, marine, and estuarine systems from disturbances associated with adjacent land uses.

**California Rapid Assessment Method (CRAM)** - is a wetland assessment method intended to provide a rapid, scientifically-defensible and repeatable assessment methodology to monitor status and trends in the conditions of wetlands for applications throughout the state. It can also be used to assess the performance of compensatory mitigation projects and restoration projects. CRAM provides an assessment of overall ecological condition in terms of four attributes: landscape context and buffer, hydrology, physical structure and biotic structure. CRAM also includes an assessment of key stressors that may be affecting wetland condition and a "field to PC" data management tool (eCRAM) to ensure consistency and quality of data produced with the method.

**Compensatory Mitigation Project** - means compensatory mitigation implemented by the Applicant as a requirement of this Certification (i.e., applicant -responsible mitigation), or by a mitigation bank or an in-lieu fee program.

**Discharge of dredged material** – means any addition of dredged material into, including redeposit of dredged material other than incidental fallback within, the waters of the United States and/or State.

**Discharge of fill material** – means the addition of fill material into waters of the United States and/or State.

**Dredged material** – means material that is excavated or dredged from waters of the United States and/or State.

**Ecological Success Performance Standards** – means observable or measurable physical (including hydrological), chemical, and/or biological attributes that are used to determine if a compensatory mitigation project meets its objectives.

**Enhancement** – means the manipulation of the physical, chemical, or biological characteristics of an aquatic resource to improve a specific aquatic resource function(s). Enhancement results in the gain of selected aquatic resource function(s), but may also lead to a decline in other aquatic resource function(s). Enhancement does not result in a gain in aquatic resource area.

**Establishment** – means the manipulation of the physical, chemical, or biological characteristics present to develop an aquatic resource that did not previously exist. Creation results in a gain in aquatic resource area.

**Fill material** – means any material used for the primary purpose of replacing an aquatic area with dry land or of changing the bottom elevation of a water body.

**Isolated wetland** – means a wetland with no surface water connection to other aquatic resources.

**Mitigation Bank** – means a site, or suite of sites, where resources (e.g., wetlands, streams, riparian areas) are restored, established, enhanced, and/or preserved for the purpose of providing mitigation for impacts authorized by this Certification.

**Preservation** - means the removal of a threat to, or preventing the decline of, aquatic resources by an action in or near those aquatic resources. This term includes activities commonly associated with the protection and maintenance of aquatic resources through the implementation of appropriate legal and physical mechanisms. Preservation does not result in a gain of aquatic resource area or functions.

**Re-establishment** - means the manipulation of the physical, chemical, or biological characteristics of a site with the goal of returning natural/ historic functions to a former aquatic resource. Re-establishment results in rebuilding a former aquatic resource and results in a gain in aquatic resource area and functions.

**Rehabilitation** - means the manipulation of the physical, chemical, or biological characteristics of a site with the goal of repairing natural/ historic functions to a degraded aquatic resource. Rehabilitation results in a gain in aquatic resource function, but does not result in a gain in aquatic resource area.

**Restoration** - means the manipulation of the physical, chemical, or biological characteristics of a site with the goal of returning natural/historic functions to a former or degraded aquatic resource. For the purpose of tracking net gains in aquatic resource area, restoration is divided into two categories: re-establishment and rehabilitation.

**Start of Project Construction** - For the purpose of this Certification, "start of Project construction" means to engage in a program of on-site construction, including site clearing, grading, dredging, landfilling, changing equipment, substituting equipment, or even moving the location of equipment specifically designed for a stationary source in preparation for the fabrication, erection or installation of the building components of the stationary source within waters of the United States and/or State.

**Uplands** - means non-wetland areas that lack any field-based indicators of wetlands or other aquatic conditions. Uplands are generally well-drained and occur above (i.e., up-slope) from nearby aquatic areas. Wetlands can, however, be entirely surrounded by uplands. For example, some natural seeps and constructed stock ponds lack aboveground hydrological connection to other aquatic areas. In the watershed context, uplands comprise the landscape matrix in which aquatic areas form. They are the primary sources of sediment, surface runoff, and associated chemicals that are deposited in aquatic areas or transported through them.

**Water quality objectives and other appropriate requirements of state law** – means the water quality objectives and beneficial uses as specified in the appropriate water quality control plan(s); the applicable provisions of sections 301, 302, 303, 306, and 307 of the Clean Water Act; and any other appropriate requirement of state law.

Talal Martha  
Martha Residence Dock Replacement Project  
Certification No. R9-2019-0048

**ATTACHMENT 2**  
**PROJECT FIGURES AND PLANS**

- 1) Construction Plans**
- 2) Turbidity Curtain**









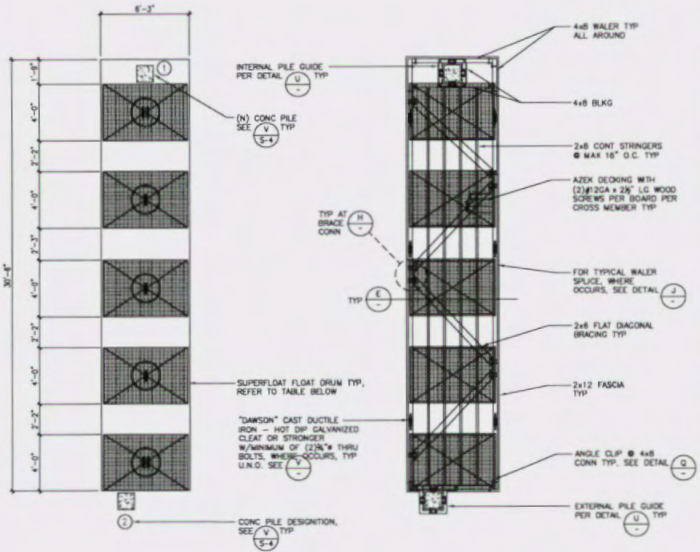

**FLOAT DRUMS PLAN**

**DOCK FRAMING PLAN**

FLOAT DRUM DIMENSIONS			
FLOAT DRUM TYPE	WIDTH	LENGTH	DEPTH
①	48"	72"	18"
②	48"	72"	20"

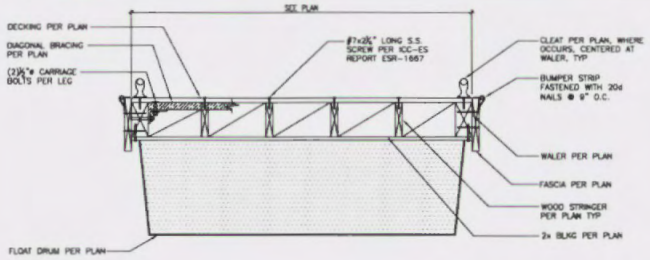

**SECTION AT FLOAT DRUM**

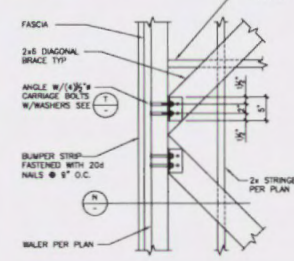

**CONNECTION DETAIL**

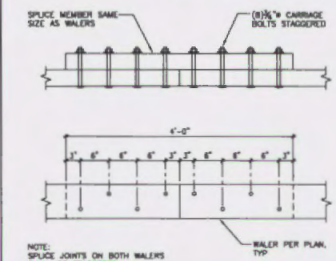

**TYPICAL SPLICE DETAIL**

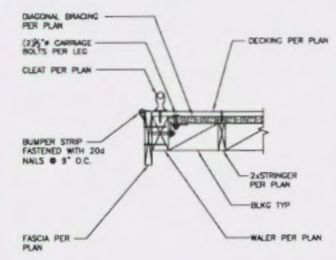

**CONNECTION DETAIL**

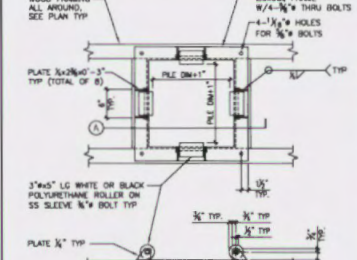

**PILE GUIDES DETAIL**

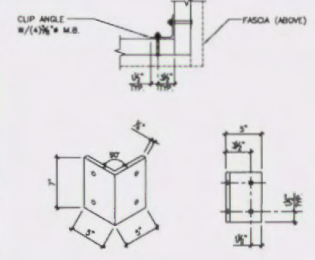

**CLIP ANGLE DETAIL**

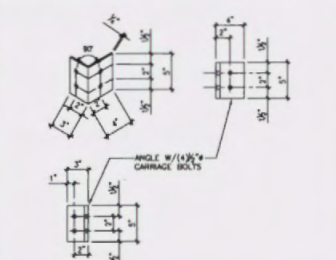

**CONNECTION DETAIL**

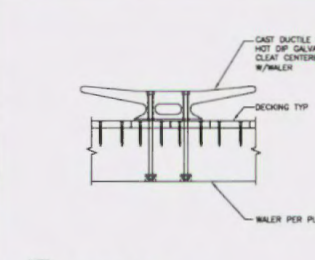

**CLEAT DETAIL**

5-35	FLOAT DRUMS PLAN & DOCK FRAMING PLAN	1/4"=1'-0"	S	CLIP ANGLE DETAIL	N.T.S.	T	PILE GUIDES DETAIL	N.T.S.	U	CLEAT DETAIL	N.T.S.	V
------	--------------------------------------	------------	---	-------------------	--------	---	--------------------	--------	---	--------------	--------	---

DATE: 12/08/2017  
 REVISIONS:  
 NO. 1  
 NO. 2  
 NO. 3  
 NO. 4  
 NO. 5  
 NO. 6  
 NO. 7  
 NO. 8  
 NO. 9  
 NO. 10

**PMA Consulting, Inc.**  
 Consulting Engineers, Inc.  
 20111 Florin Way, Suite 100  
 Folsom, CA 95630  
 P. Mark P. Petrova, P.E., S.E.  
 S. Mark P. Petrova, P.E., S.E.

OWNER / APPLICANT  
**Talal Martha**  
 7 Port of Spain Road  
 Coronado, CA 92118

**PLING, GANGWAY & FLOATING DOCK REPLACEMENT LOCATED AT:**  
 7 Port of Spain Road  
 Coronado, CA 92118

DATE: 12/08/2017  
 JOB NO.: 21417  
 DRAWN BY: M. PETROVA  
 CHECKED BY: P. PETROVA

**S-3**



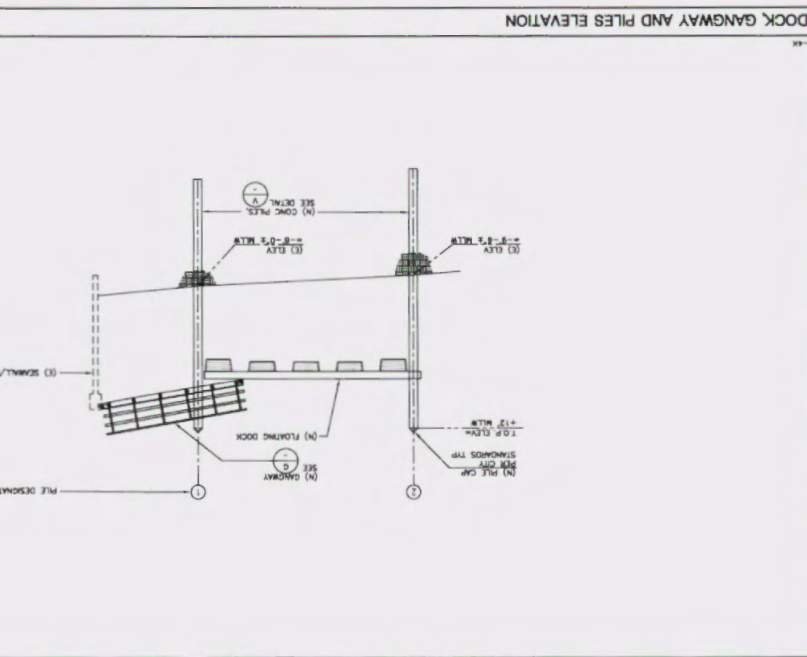
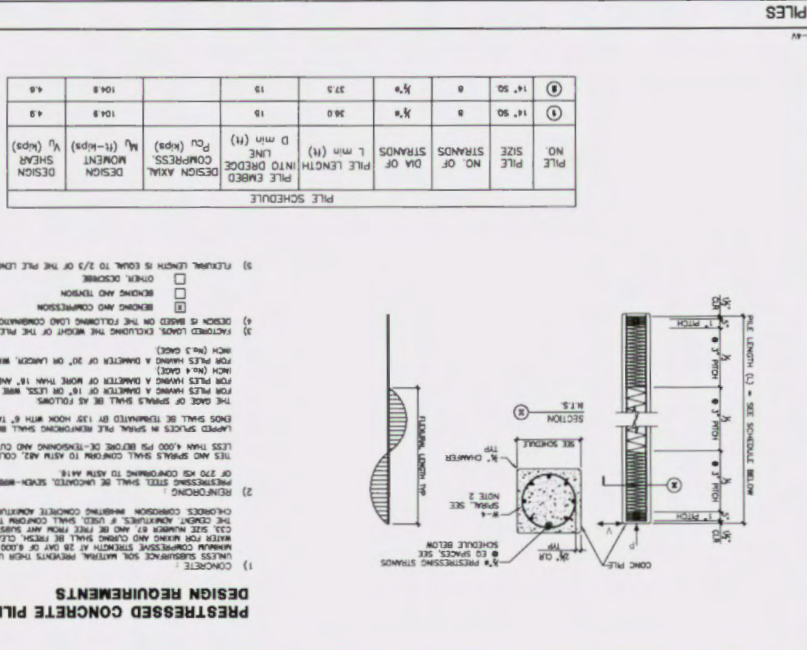
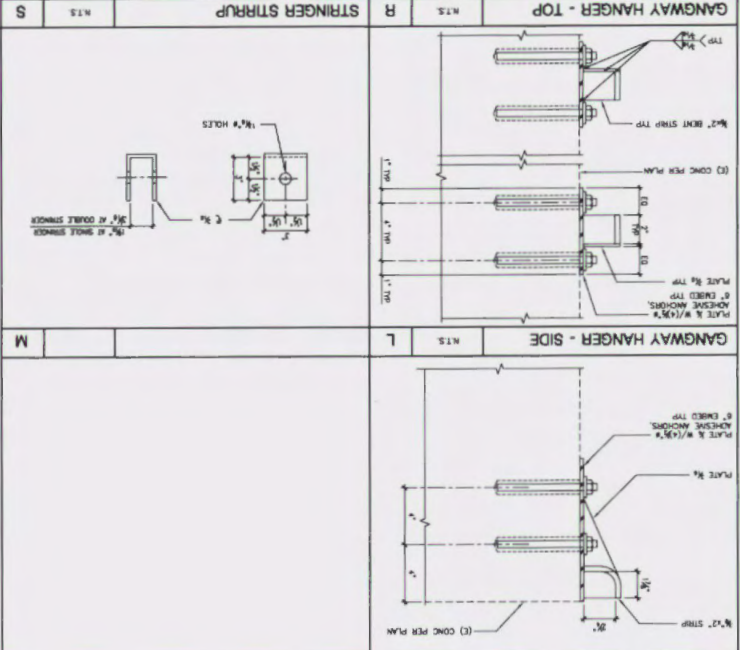
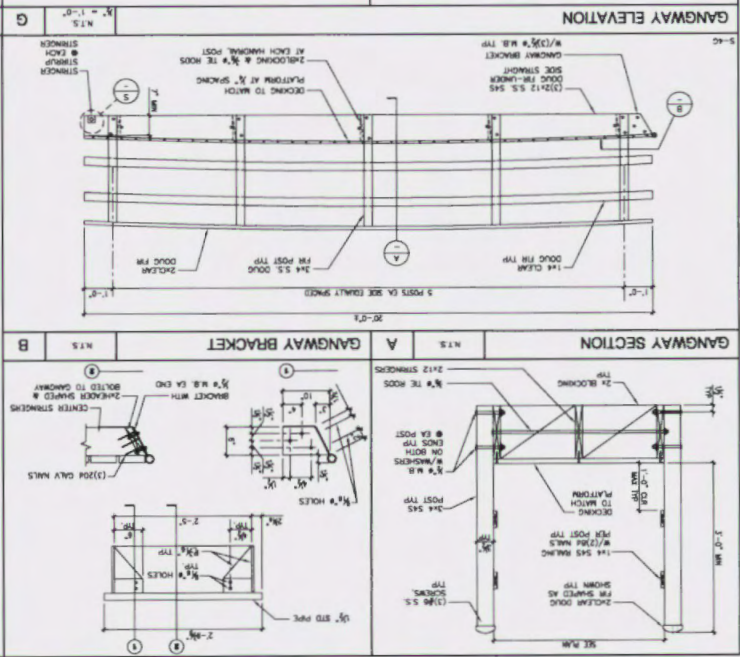

**REPLACEMENT LOCATED AT:**  
7 Port of Spain Road  
Coronado, CA 92718

**DESIGN REQUIREMENTS**  
**PRESTRESSED CONCRETE PILE ALTERNATE**

1) UNLESS SPECIFIED FOR MATERIAL, REINVENTS THEIR USE. PILING SHALL BE PRESTRESSED CONCRETE WITH A MINIMUM COMPRESSIVE STRENGTH AT 28 DAY OF 8,000 PSI. PORTLAND CEMENT SHALL BE ASTM C150 TYPE 2. WITH FOUR RINGS AND CURING SHALL BE FRESH CLEAN AND ROUGH. REINFORCERS SHALL CONFORM TO ASTM A615 GRADE 60. REINFORCERS SHALL BE ELEGANTLY FINISHED WITH THE ALKALI RESISTANT COATING. REINFORCERS SHALL CONFORM TO THE REQUIREMENTS OF ASTM A615 AND NOT CONTAIN CHLORIDES. CORROSION INHIBITING CONCRETE ADmixTURES ARE ENCOURAGED.

2) REINFORCING: PRESTRESSING STEEL SHALL BE LOCKED, STITCH-WELD STRESS RELIEVED STRANDS WITH MINIMUM ULTIMATE STRENGTH OF 270 KSI. CONFORMING TO ASTM A186.

3) PILES SHALL BE CAST IN PLACE. PILES SHALL HAVE A MINIMUM ULTIMATE STRENGTH OF 4,000 PSI BEFORE OR AFTER CAST. PILES SHALL HAVE A MINIMUM ULTIMATE STRENGTH OF 4,000 PSI BEFORE OR AFTER CAST. PILES SHALL HAVE A MINIMUM ULTIMATE STRENGTH OF 4,000 PSI BEFORE OR AFTER CAST. PILES SHALL HAVE A MINIMUM ULTIMATE STRENGTH OF 4,000 PSI BEFORE OR AFTER CAST.

4) DESIGN IS BASED ON THE FOLLOWING LOAD COMBINATIONS:  
 DEAD, LIVE, AND WIND  
 DEAD, LIVE, AND WIND, AND COMPRESSION  
 OTHER, DESCRIBE

5) PILE LENGTH IS EQUAL TO 2/3 OF THE PILE LENGTH.

**PILE SCHEDULE**

DATE: 12/08/2017  
 DRAWN BY: M. J. PETERSON  
 CHECKED BY: T. MARIN  
 PROJECT: REPLACEMENT LOCATED AT: 7 Port of Spain Road, Coronado, CA 92718

**PMMA Consulting, Inc.**  
 12/08/2017  
 10000 Wilshire Blvd, Suite 1000, Los Angeles, CA 90024  
 TEL: 310.206.1000 FAX: 310.206.1001  
 WWW.PMMA-CONSULTING.COM



## Turbidity Curtain Specifications

ABASCO Type 2 Turbidity Curtains combine standard high-strength fabric with heavy duty tension members (above floatation and at the bottom of the skirt), and aluminum stress plates at the bottom skirt corners. They are ideal for silt and sediment control during marine construction in areas with mild current, wind and wave activity. Meets or exceeds most state DOT requirements.

Fabric is a construction of 22 oz./sq. yd. PVC- Coated Polyester, and the floatation is 8 in. diameter expanded polystyrene foam contained in individually sealed float pockets. Top tension is created with 5/16 in. galvanized steel cable contained in a polyethylene tube, bottom tension is a 5/16 galvanized steel chain, and can be tapered to conform to bottom profile. The end connectors are made up of high tensile strength aluminum universal connector at float and top tension cable. ASTM 3/8 in. stainless steel locking pins. Lacing grommets on reinforced fabric on lower skirt. Chain ends are shackled section to section. Skirt depth is 50ft.

### Side View

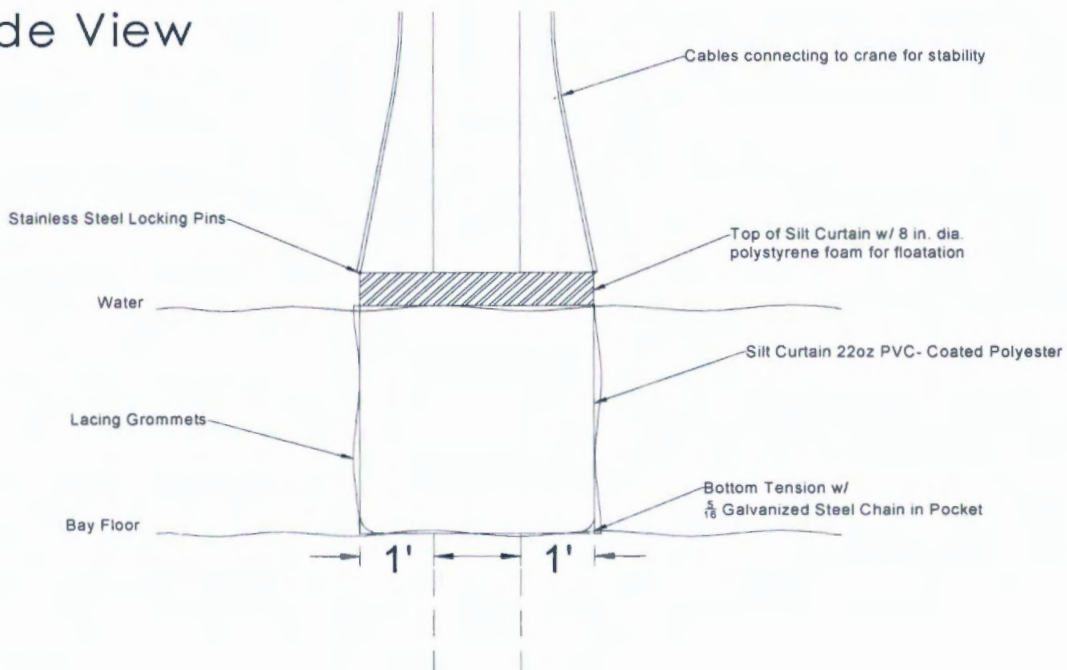

### Top View

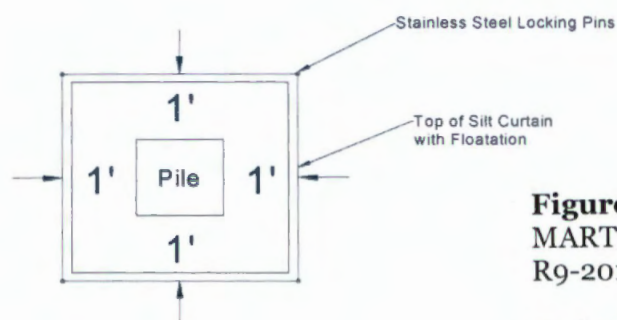

**Figure 4**  
MARTHA, TALAL -- 7 Port of Spain  
R9-2018-0134:849177:NGergans

Turbidity/Silt Curtain Specifications