

**CALIFORNIA REGIONAL WATER QUALITY CONTROL BOARD
SAN DIEGO REGION**

2375 Northside Drive, Suite.100, San Diego, CA 92108
Phone (619) 516-1990 • Fax (619) 516-1994
<http://www.waterboards.ca.gov/sandiego/>

Clean Water Act Section 401 Water Quality Certification
and Waste Discharge Requirements
for Discharge of Dredged and/or Fill Materials

PROJECT: Wildomar Crossings
Certification Number R9-2019-0081
WDID: 9000003311

Reg. Meas. ID: 421752 Place ID: 847771 Party ID: 578564 Person ID: 578564
--

APPLICANT: Wildomar Crossings, LLC
P.O. Box 77564
San Francisco, CA 94107

ACTION:

<input type="checkbox"/> Order for Low Impact Certification	<input type="checkbox"/> Order for Denial of Certification
<input checked="" type="checkbox"/> Order for Technically-conditioned Certification	<input type="checkbox"/> Enrollment in Isolated Waters Order No. 2004-004-DWQ
<input checked="" type="checkbox"/> Enrollment in SWRCB GWDR Order No. 2003-017-DWQ	

PROJECT DESCRIPTION

An application dated May 2, 2018, was submitted by Wildomar Crossings, LLC (hereinafter Applicant), for Water Quality Certification pursuant to section 401 of the Clean Water Act (United States Code (USC) Title 33, section 1341) for the proposed Wildomar Crossings Project (Project). The California Regional Water Quality Control Board, San Diego Region (San Diego Water Board) deemed the application to be complete on January 7, 2019. The Applicant proposes to discharge dredged or fill material to waters of the United States and/or State associated with construction activity at the Project site. The Applicant has also applied for a Clean Water Act section 404 permit from the United States Army Corps of Engineers for the Project (USACE File No. SPL-2018-00297-PJB).

The Project is located within the City of Wildomar, Riverside County, California at Street Address (if known). The Project center reading is located at latitude 33.89255 and longitude -117.24981. The Applicant has paid all required application fees for this Certification in the amount of \$1,235.00. On an annual basis, the Applicant shall also pay all fees.¹ On January 8, 2019, the San Diego Water Board provided public notice of the Project application pursuant to California Code of Regulations, title 23, section 3858 by posting information describing the Project on the San Diego Water Board's web site and providing a period of twenty-one days for public review and comment. No comments were received.

¹ Additional information regarding fees can be found electronically on the State Water Resources Control Board website at the following location: http://www.waterboards.ca.gov/water_issues/programs/cwa401/docs/dredgefillcalculator.xlsx

The Applicant proposes to construct a commercial retail shopping center comprised of a drive through restaurant and 3 additional commercial pads. The commercial retail shopping center consists of four buildings ranging from just over 3,000 square feet up to 10,000 square feet in size. The Project also includes parking facilities, off-site roadway and drainage improvements, and other associated infrastructure. The Project will convert approximately 1.92 acres of pervious ground cover to impervious surfaces. Runoff leaving the developed Project area would be significantly greater in volume, velocity, peak flow rate, and duration than pre-development runoff from the same area without mitigation. Post-construction best management practices (BMPs) to manage and control the effects of these runoff increases will consist of three bioretention basins, minimizing impervious surface and directing runoff from development to landscape and natural areas. These BMPs will be designed, constructed, and maintained to meet the city of Wildomar's low impact development (LID) capture volume and hydromodification treatment requirements. The Project application includes a description of the design objective, operation, and degree of treatment expected to be attained from equipment, facilities, or activities (including construction and post-construction BMPs) to treat waste and reduce runoff or other effluents which may be discharged. Compliance with the Certification conditions will help ensure that construction and post-construction discharges from the Project will not cause on-site or off-site downstream erosion, damage to downstream properties, or otherwise damage stream habitats in violation of water quality standards in the *Water Quality Control Plan for the San Diego Basin (9)* (Basin Plan).

Project construction will permanently impact 0.02 acre (287 linear feet) of unvegetated ephemeral streambed waters of the United States and/or State. Of the 0.05 acre of waters of the United States and/or State on the site, 0.03 acre, including all the wetlands, will be avoided. The Project will preserve an approximately 1.0-acre lot in the southwest corner that includes the avoided 0.03 acre of Waters of the United States and/or State. The Applicant reports that the Project purpose cannot be practically accomplished in a manner which would avoid or result in less adverse impacts to aquatic resources considering all potential practicable alternatives, such as the potential for alternate available locations, designs, reductions in size, configuration or density.

The Applicant reports that compensatory mitigation for the permanent loss of 0.02 acre (287 linear feet) of jurisdictional waters will be achieved through the purchase of 0.06 acre of re-established river credits. Mitigation purchased from the San Luis Rey Mitigation Bank is required to be protected and maintained in perpetuity by Wildlands according to the conditions of Water Quality Certification No. R9-2013-0050. By purchasing credits: the Performance Standards; Mitigation Site Design; Long Term Management, Maintenance, and Monitoring; and Mitigation Site Preservation Mechanism for the Project will be implemented by Wildlands through San Luis Rey Mitigation Bank according to the conditions of Water Quality Certification No. R9-2013-0050. Compensatory mitigation options within the watershed were deemed inadequate. No waters of the United States and/or State will receive temporary discharges of fill associated with the Project. Mitigation for discharges of fill material to waters of the United States and/or State will be completed by the Applicant at San Luis Rey River Mitigation Bank located in the Bonsall hydrologic sub-area (HSA 903.12) at a minimum compensation ratio of 3:1 (area mitigated:area impacted).

Additional Project details are provided in Attachments 1 through 4 of this Certification.

TABLE OF CONTENTS

I.	STANDARD CONDITIONS	4
II.	GENERAL CONDITIONS	4
III.	CONSTRUCTION BEST MANAGEMENT PRACTICES	7
IV.	POST-CONSTRUCTION BEST MANAGEMENT PRACTICES	9
V.	PROJECT IMPACTS AND COMPENSATORY MITIGATION	10
VI.	MONITORING AND REPORTING REQUIREMENTS	11
VII.	NOTIFICATION REQUIREMENTS	14
VIII.	CALIFORNIA ENVIRONMENTAL QUALITY ACT COMPLIANCE	16
IX.	SAN DIEGO WATER BOARD CONTACT PERSON	17
X.	WATER QUALITY CERTIFICATION	17

Attachments:

1. Definitions
2. Project Location Maps
3. Project Site Plans
4. CEQA Mitigation Monitoring and Reporting Program

The San Diego Water Board has independently reviewed the record of the Project to analyze the extent and nature of proposed Project impacts to the water quality and beneficial uses of waters of the United States and/or State and associated compensatory mitigation required to offset impacts attributed to the Project. In accordance with this Certification, the Applicant may proceed with the Project under the following terms and conditions:

I. STANDARD CONDITIONS

Pursuant to section 3860 of title 23 of the California Code of Regulations, the following three standard conditions apply to all water quality certification actions:

- A. This Certification action is subject to modification or revocation upon administrative or judicial review, including review and amendment pursuant to section 13330 of the Water Code and chapter 28, article 6 (commencing with title 23, section 3867), of the California Code of Regulations.
- B. This Certification action is not intended and shall not be construed to apply to any discharge from any activity involving a hydroelectric facility and requiring a Federal Energy Regulatory Commission (FERC) license or an amendment to a FERC license unless the pertinent Certification application was filed pursuant to California Code of Regulations title 23, section 3855 subdivision (b), and that application specifically identified that a FERC license or amendment to a FERC license for a hydroelectric facility was being sought.
- C. This Certification action is conditioned upon total payment of any fee required under title 23, chapter 28 (commencing with section 3830) of California Code of Regulations and owed by the applicant.

II. GENERAL CONDITIONS

- A. **Term of Certification.** Water Quality Certification No. R9-2019-0081(Certification) shall expire upon a) the expiration or retraction of the Clean Water Act section 404 (33 USC Title 33, section 1344) permit issued by the U.S. Army Corps of Engineers for this Project, or b) five (5) years from the date of issuance of this Certification, whichever occurs first.
- B. **Duty to Comply.** The Applicant must comply with all conditions and requirements of this Certification. Any Certification noncompliance constitutes a violation of the Water Code and is grounds for enforcement action or Certification termination, revocation and reissuance, or modification.
- C. **General Waste Discharge Requirements.** The requirements of this Certification are enforceable through Water Quality Order No. 2003-0017-DWQ, *Statewide General Waste Discharge Requirements for Discharges of Dredged or Fill Material that have Received State Water Quality Certification* (Water Quality Order No. 2003-0017-DWQ). This provision shall apply irrespective of whether a) the federal permit for which the Certification was obtained is subsequently retracted or is expired, or b) the Certification is expired. Water Quality Order No. 2003-0017-DWQ is accessible at:

http://www.waterboards.ca.gov/water_issues/programs/cwa401/docs/generalorders/gowdr401regulated_projects.pdf.

- D. Project Conformance with Application.** All water quality protection measures and BMPs described in the application and supplemental information for water quality certification are incorporated by reference into this Certification as if fully stated herein. Notwithstanding any more specific conditions in this Certification, the Applicant shall construct, implement and comply with all water quality protection measures and BMPs described in the application and supplemental information. The conditions within this Certification shall supersede conflicting provisions within the application and supplemental information submitted as part of this Certification action.
- E. Project Conformance with Water Quality Control Plans or Policies.** Notwithstanding any more specific conditions in this Certification, the Project shall be constructed in a manner consistent with the Basin Plan and any other applicable water quality control plans or policies adopted or approved pursuant to the Porter Cologne Water Quality Act (Division 7, commencing with Water Code Section 13000) or section 303 of the Clean Water Act (33 USC section 1313). The Basin Plan is accessible at:
- http://www.waterboards.ca.gov/sandiego/water_issues/programs/basin_plan/index.shtml
- F. Project Modification.** The Applicant must submit any changes to the Project, including Project operation, which would have a significant or material effect on the findings, conclusions, or conditions of this Certification, to the San Diego Water Board for prior review and written approval. If the San Diego Water Board is not notified of a significant change to the Project, it will be considered a violation of this Certification.
- G. Certification Distribution Posting.** During Project construction, the Applicant must maintain a copy of this Certification at the Project site. This Certification must be available at all times to site personnel and agencies. A copy of this Certification shall also be provided to any contractor or subcontractor performing construction work, and the copy shall remain in their possession at the Project site.
- H. Inspection and Entry.** The Applicant must allow the San Diego Water Board or the State Water Resources Control Board, and/or their authorized representative(s) (including an authorized contractor acting as their representative), upon the presentation of credentials and other documents as may be required under law, to:
1. Enter upon the Project or Compensatory Mitigation site(s) premises where a regulated facility or activity is located or conducted, or where records must be kept under the conditions of this Certification;
 2. Have access to and copy, at reasonable times, any records that must be kept under the conditions of this Certification;
 3. Inspect, at reasonable times, any facilities, equipment (including monitoring and control equipment), practices, or operations regulated or required under this Certification; and

4. Sample or monitor, at reasonable times, for the purposes of assuring Certification compliance, or as otherwise authorized by the Clean Water Act or Water Code, any substances or parameters at any location.
- I. **Enforcement Notification.** In the event of any violation or threatened violation of the conditions of this Certification, the violation or threatened violation shall be subject to any remedies, penalties, process or sanctions as provided for under State law. For purposes of section 401(d) of the Clean Water Act, the applicability of any State law authorizing remedies, penalties, process or sanctions for the violation or threatened violation constitutes a limitation necessary to assure compliance with the water quality standards and other pertinent requirements incorporated into this Certification.
- J. **Certification Actions.** This Certification may be modified, revoked and reissued, or terminated for cause including but not limited to the following:
1. Violation of any term or condition of this Certification;
 2. Monitoring results indicate that continued Project activities could violate water quality objectives or impair the beneficial uses of Murrieta Creek or its tributaries;
 3. Obtaining this Certification by misrepresentation or failure to disclose fully all relevant facts;
 4. A change in any condition that requires either a temporary or permanent reduction or elimination of the authorized discharge; and
 5. Incorporation of any new or revised water quality standards and implementation plans adopted or approved pursuant to the Porter-Cologne Water Quality Control Act or section 303 of the Clean Water Act.
- The filing of a request by the Applicant for modification, revocation and reissuance, or termination, or a notification of planned changes or anticipated noncompliance does not stay any Certification condition.
- K. **Duty to Provide Information.** The Applicant shall furnish to the San Diego Water Board, within a reasonable time, any information which the San Diego Water Board may request to determine whether cause exists for modifying, revoking and reissuing, or terminating this Certification or to determine compliance with this Certification.
- L. **Property Rights.** This Certification does not convey any property rights of any sort, or any exclusive privilege.
- M. **Petitions.** Any person aggrieved by this action of the San Diego Water Board may petition the State Water Resources Control Board (State Water Board) to review the action in accordance with the California Code of Regulations, title 23, sections 3867 and following. The State Water Board must receive the petition by 5:00 p.m., 30 days after the date of this Certification. Copies of the law and regulations applicable to filing

petitions may be found on the Internet at:
http://www.waterboards.ca.gov/public_notices/petitions/water_quality or will be provided upon request.

III. CONSTRUCTION BEST MANAGEMENT PRACTICES

- A. **Approvals to Commence Construction.** The Applicant shall not commence Project construction until all necessary federal, State, and local approvals are obtained.
- B. **Personnel Education.** Prior to the start of the Project, and annually thereafter, the Applicant must educate all personnel on the requirements in this Certification, pollution prevention measures, spill response measures, and BMP implementation and maintenance measures.
- C. **Spill Containment Materials.** The Applicant must, at all times, maintain appropriate types and sufficient quantities of materials on-site to contain any spill or inadvertent release of materials that may cause a condition of pollution or nuisance if the materials reach waters of the United States and/or State.
- D. **General Construction Storm Water Permit.** Prior to start of Project construction, the Applicant must, as applicable, obtain coverage under, and comply with, the requirements of State Water Resources Control Board Water Quality Order No. 2009-0009-DWQ, the *General Permit for Storm Water Discharges Associated with Construction and Land Disturbance Activity*, (General Construction Storm Water Permit) and any reissuance. If Project construction activities do not require coverage under the General Construction Storm Water Permit, the Applicant must develop and implement a runoff management plan (or equivalent construction BMP plan) to prevent the discharge of sediment and other pollutants during construction activities.
- E. **Waste Management.** The Applicant must properly manage, store, treat, and dispose of wastes in accordance with applicable federal, state, and local laws and regulations. Waste management shall be implemented to avoid or minimize exposure of wastes to precipitation or storm water runoff. The storage, handling, treatment, or disposal of waste shall not create conditions of pollution, contamination or nuisance as defined in Water Code section 13050. Upon Project completion, all Project generated debris, building materials, excess material, waste, and trash shall be removed from the Project site(s) for disposal at an authorized landfill or other disposal site in compliance with federal, state and local laws and regulations.
- F. **Waste Management.** Except for a discharge permitted under this Certification, the dumping, deposition, or discharge of trash, rubbish, unset cement or asphalt, concrete, grout, damaged concrete or asphalt, concrete or asphalt spoils, wash water, organic or earthen material, steel, sawdust or other construction debris waste from Project activities directly into waters of the United States and or State, or adjacent to such waters in any manner which may permit its being transported into the waters, is prohibited.

- G. **Downstream Erosion.** Discharges of concentrated flow during construction or after Project completion must not cause downstream erosion or damage to properties or stream habitat.
- H. **Construction Equipment.** All equipment must be washed prior to transport to the Project site and must be free of sediment, debris, and foreign matter. All equipment used in direct contact with surface water shall be steam cleaned prior to use. All equipment using gas, oil, hydraulic fluid, or other petroleum products shall be inspected for leaks prior to use and shall be monitored for leakage. Stationary equipment (e.g., motors, pumps, generator, etc.) shall be positioned over drip pans or other types of containment.
- I. **Process Water.** Water containing mud, silt, or other pollutants from equipment washing or other activities, must not be discharged to waters of the United States and/or State or placed in locations that may be subjected to storm water runoff flows. Pollutants discharged to areas within a stream diversion must be removed at the end of each work day or sooner if rain is predicted.
- J. **Surface Water Diversion.** All surface waters, including ponded waters, must be diverted away from areas of active grading, construction, excavation, vegetation removal, and/or any other activity which may result in a discharge to the receiving water. Diversion activities must not result in the degradation of beneficial uses or exceedance of the receiving water quality objectives. Any temporary dam or other artificial obstruction constructed must only be built from materials such as clean gravel which will cause little or no siltation. Normal flows must be restored to the affected stream immediately upon completion of work at that location.
- K. **Re-vegetation and Stabilization.** All areas that have 14 or more days of inactivity must be stabilized within 14 days of the last activity. The Applicant shall implement and maintain BMPs to prevent erosion of the rough graded areas. After completion of grading, all areas must be re-vegetated with native species appropriate for the area. The re-vegetation palette must not contain any plants listed on the California Invasive Plant Council Invasive Plant Inventory, which can be accessed at <http://www.cal-ipc.org/ip/inventory/>.
- L. **Hazardous Materials.** Except as authorized by this Certification, substances hazardous to aquatic life including, but not limited to, petroleum products, unused cement/concrete, asphalt, and coating materials, must be prevented from contaminating the soil and/or entering waters of the United States and/or State. BMPs must be implemented to prevent such discharges during each Project activity involving hazardous materials.
- M. **Vegetation Removal.** Removal of vegetation must occur by hand, mechanically, or through application of United States Environmental Protection Agency (USEPA) approved herbicides deployed using applicable BMPs to minimize adverse effects to beneficial uses of waters of the United States and/or State. Discharges related to the application of aquatic pesticides within waters of the United States must be done in compliance with State Water Resources Control Board Water Quality Order No. 2004-

0009-DWQ, the *Statewide General National Pollution Discharge Elimination System Permit for the Discharge of Aquatic Weed Control in Waters of the United States*, and any subsequent reissuance as applicable.

- N. **Limits of Disturbance.** The Applicant shall clearly define the limits of Project disturbance to waters of the United States and/or State using highly visible markers such as flag markers, construction fencing, or silt barriers prior to commencement of Project construction activities within those areas.
- O. **On-site Qualified Biologist.** The Applicant shall designate an on-site qualified biologist to monitor Project construction activities within or adjacent to waters of the United States and/or State to ensure compliance with the Certification requirements. The biologist shall be given the authority to stop all work on-site if a violation of this Certification occurs or has the potential to occur. Records and field notes of the biologist's activities shall be kept on-site and made available for review upon request by the San Diego Water Board.
- P. **Beneficial Use Protection.** The Applicant must take all necessary measures to protect the beneficial uses of waters of Murrieta Creek and its tributaries. This Certification requires compliance with all applicable requirements of the Basin Plan. If at any time, an unauthorized discharge to surface waters (including rivers or streams) occurs or monitoring indicates that the Project is violating, or threatens to violate, water quality objectives, the associated Project activities shall cease immediately and the San Diego Water Board shall be notified in accordance with Notification Requirement VII.A of this Certification. Associated Project activities may not resume without approval from the San Diego Water Board.
- Q. **Groundwater Dewatering.** If groundwater dewatering is required for the Project, the Applicant shall enroll in and comply with the requirements of San Diego Water Board Order No. R9-2015-0013 NPDES No. CAG919003, *General Waste Discharge Requirements For Groundwater Extraction Discharges to Surface Waters within the San Diego Region* or its successor permit.

IV. POST-CONSTRUCTION BEST MANAGEMENT PRACTICES

- A. **Post-Construction Discharges.** The Applicant shall not allow post-construction discharges from the Project site to cause or contribute to on-site or off-site erosion or damage to properties or stream habitats.
- B. **Storm Drain Inlets.** All storm drain inlet structures within the Project boundaries must be stamped or stenciled (or equivalent) with appropriate language prohibiting non-storm water discharges.
- C. **Post-Construction BMP Design.** The Project must be designed to comply with the requirements for priority development projects in section E.3 of the Regional MS4 Permit Order No. R9-2013-0001, *National Pollutant Discharge Elimination Systems Permit and Waste Discharge Requirements for Discharges of Urban Runoff from the MS4s Draining the Watersheds within the San Diego Region* (Regional MS4 Permit) as

well as the most current BMP Design Manual for the City of Wildomar. Where conflict exists between the referenced documents the most stringent requirements shall apply.

- D. Post-Construction BMP Maintenance.** The post construction BMPs must be designed, constructed, and maintained in accordance with the most recent California Storm Water Quality Association (CASQA)² guidance. The Applicant shall:
1. No less than two times per year, assess the performance of the BMPs to ensure protection of the receiving waters and identify any necessary corrective measures;
 2. Perform inspections of BMPs, at the beginning of the wet season no later than October 1 and the end of the wet season no later than April 1, for standing water, slope stability, sediment accumulation, trash and debris, and presence of burrows;
 3. Regularly perform preventative maintenance of BMPs, including removal of accumulated trash and debris, as needed to ensure proper functioning of the BMPs;
 4. Identify and promptly repair damage to BMPs; and
 5. Maintain a log documenting all BMP inspections and maintenance activities. The log shall be made available to the San Diego Water Board upon request.
- E. Bridge, Crossing, and Culvert Design.** Bridges, culverts, dip crossings, or other stream crossing structures shall be designed and installed so they will not cause scouring of the stream bed and/or erosion of the banks in the vicinity of the Project. Storm drain lines/culverts and other stream crossing structures shall be designed and maintained to accommodate at least a 100-year, 24-hour storm event, including associated bedload and debris, with a similar average velocity as upstream and downstream sections. Bottoms of temporary culverts shall be placed at stream channel grade and bottoms of permanent culverts shall be open bottom or embedded and backfilled below the grade of the stream greater than or equal to a depth of 1 foot.
- V. PROJECT IMPACTS AND COMPENSATORY MITIGATION**
- A. Project Impact Avoidance and Minimization.** The Project must avoid and minimize adverse impacts to waters of the United States and/or State to the maximum extent practicable.
- B. Project Impacts and Compensatory Mitigation.** Unavoidable Project impacts to Murrieta Creek and its unnamed tributaries within the Santa Margarita Watershed must not exceed the type and magnitude of impacts described in the table below. At a minimum, compensatory mitigation required to offset unavoidable temporary and permanent Project impacts to waters of the United States and/or State must be achieved as described in the table below:

² California Storm Water Quality Association (*California Storm Water BMP Handbook, New Development and Redevelopment 2003*), available on-line at: <http://www.cabmphandbooks.org/> [Accessed on January 15, 2012]

	Impacts (acres)	Impacts (linear ft.)	Mitigation for Impacts (acres)	Mitigation Ratio (area mitigated :area impacted)	Mitigation for Impacts (linear ft.)	Mitigation Ratio (linear feet mitigated :linear feet impacted)
Permanent Impacts						
Stream Channel	0.02 ✓	287	0.06 Re-establishment ¹ ✓	3:1 ✓	NA ²	NA
Temporary Impacts³						

1. Purchase of 0.06-acre of re-established river credits. Mitigation purchased from the San Luis Rey Mitigation Bank is required to be protected and maintained in perpetuity by Wildlands according to the conditions of Water Quality Certification No. R9-2013-0050. The mitigation provided for Project impacts contributes to the net gain of wetlands per the State of California Net Gain Policy (Executive Order W-59-93.)
2. The amount of mitigation credits purchased is not reported in terms of linear feet of mitigation.
3. No waters of the United States and/or State shall receive temporary discharges of fill associated with the Project.

C. **Mitigation Credit Purchase.** The Applicant must provide the San Diego Water Board proof of mitigation credit purchase from the San Luis Rey Mitigation Bank prior to the start of construction.

D. **Temporary Project Impact Areas.** The Applicant must restore all other areas of temporary disturbance which could result in a discharge or a threatened discharge of pollutants to waters of the United States and/or State. Restoration must include grading of disturbed areas to pre-project contours and re-vegetation with native species. The Applicant must implement all necessary BMPs to control erosion and runoff from areas associated with the Project.

VI. MONITORING AND REPORTING REQUIREMENTS

- A. **Representative Monitoring.** Samples and measurements taken for the purpose of monitoring under this Certification shall be representative of the monitored activity.
- B. **Monitoring Reports.** Monitoring results shall be reported to the San Diego Water Board at the intervals specified in section VI of this Certification.
- C. **Monitoring and Reporting Revisions.** The San Diego Water Board may make revisions to the monitoring program at any time during the term of this Certification and may reduce or increase the number of parameters to be monitored, locations monitored, the frequency of monitoring, or the number and size of samples collected.

- D. Records of Monitoring Information.** Records of monitoring information shall include:
1. The date, exact place, and time of sampling or measurements;
 2. The individual(s) who performed the sampling or measurements;
 3. The date(s) analyses were performed;
 4. The individual(s) who performed the analyses;
 5. The analytical techniques or methods used; and
 6. The results of such analyses.
- E. Discharge Commencement Notification.** The Applicant must notify the San Diego Water Board in writing **at least 5 days prior to** the start of Project construction.
- F. Geographic Information System Data.** The Applicant must submit Geographic Information System (GIS) shape files of the Project impact sites within 30 days of the start of project construction. All shape files must be polygons. Two GPS readings (points) must be taken on each line of the polygon and the polygon must have a minimum of 10 points. GIS metadata must also be submitted.
- G. Annual Project Progress Reports.** The Applicant must submit annual Project progress reports describing status of BMP implementation and compliance with all requirements of this Certification to the San Diego Water Board prior to **March 1** of each year following the issuance of this Certification, until the Project has reached completion. Annual Project Progress Reports must be submitted even if Project construction has not begun. The monitoring period for each Annual Project Progress Report shall be January 1st through December 31st of each year. Annual Project Progress Reports must include, at a minimum, the following:
1. **Project Status and Compliance Reporting.** The Annual Project Progress Report must include the following Project status and compliance information:
 - a. The names, qualifications, and affiliations of the persons contributing to the report;
 - b. The status, progress, and anticipated schedule for completion of Project construction activities including the installation and operational status of best management practices project features for erosion and storm water quality treatment;
 - c. A description of Project construction delays encountered or anticipated that may affect the schedule for construction completion; and
 - d. A description of each incident of noncompliance during the annual monitoring period and its cause, the period of the noncompliance including exact dates and

times, and if the noncompliance has not been corrected, the anticipated time it is expected to continue; and the steps taken or planned to reduce, eliminate, and prevent reoccurrence of the noncompliance.

H. **Final Project Completion Report.** The Applicant must submit a Final Project Completion Report to the San Diego Water Board **within 30 days of completion of the Project.** The final report must include the following information:

1. Date of construction initiation;
2. Date of construction completion;
3. BMP installation and operational status for the Project;
4. As-built drawings of the Project, no bigger than 11”X17”; and
5. Photo documentation of implemented post-construction BMPs and all areas of permanent and temporary impacts, prior to and after project construction. Photo documentation must be conducted in accordance with guidelines posted at http://www.waterboards.ca.gov/sandiego/water_issues/programs/401_certification/docs/StreamPhotoDocSOP.pdf. In addition, photo documentation must include Global Positioning System (GPS) coordinates for each of the photo points referenced.

I. **Reporting Authority.** The submittal of information required under this Certification, or in response to a suspected violation of any condition of this Certification, is required pursuant to Water Code section 13267 and 13383. Civil liability may be administratively imposed by the San Diego Water Board for failure to submit information pursuant to Water Code sections 13268 or 13385.

J. **Electronic Document Submittal.** The Applicant must submit all reports and information required under this Certification in electronic format via e-mail to SanDiego@waterboards.ca.gov. Documents over 50 megabytes will not be accepted via e-mail and must be placed on a disc and delivered to:

California Regional Water Quality Control Board
San Diego Region
Attn: 401 Certification No. R9-2018-0106: 847771:dbradford
2375 Northside Drive, Suite 100
San Diego, California 92108

Each electronic document must be submitted as a single file, in Portable Document Format (PDF), converted to text searchable format using Optical Character Recognition (OCR), and not be password protected. All electronic documents must include scanned copies of all signature pages; electronic signatures will not be accepted. Electronic documents submitted to the San Diego Water Board must include the following identification numbers in the header or subject line: Certification No. R9-2018-0106: 847771:dbradford.

K. Document Signatory Requirements. All applications, reports, or information submitted to the San Diego Water Board must be signed as follows:

1. For a corporation, by a responsible corporate officer of at least the level of vice president.
2. For a partnership or sole proprietorship, by a general partner or proprietor, respectively.
3. For a municipality, or a state, federal, or other public agency, by either a principal executive officer or ranking elected official.
4. A duly authorized representative may sign applications, reports, or information if:
 - a. The authorization is made in writing by a person described above.
 - b. The authorization specifies either an individual or position having responsibility for the overall operation of the regulated activity.
 - c. The written authorization is submitted to the San Diego Water Board Executive Officer.

If such authorization is no longer accurate because a different individual or position has responsibility for the overall operation of the Project, a new authorization satisfying the above requirements must be submitted to the San Diego Water Board prior to or together with any reports, information, or applications, to be signed by an authorized representative.

L. Document Certification Requirements. All applications, reports, or information submitted to the San Diego Water Board must be certified as follows:

"I certify under penalty of law that I have personally examined and am familiar with the information submitted in this document and all attachments and that, based on my inquiry of those individuals immediately responsible for obtaining the information, I believe that the information is true, accurate, and complete. I am aware that there are significant penalties for submitting false information, including the possibility of fine and imprisonment."

VII. NOTIFICATION REQUIREMENTS

A. Twenty Four Hour Non-Compliance Reporting. The Applicant shall report any noncompliance which may endanger health or the environment. Any such information shall be provided orally to the San Diego Water Board within **24 hours** from the time the Applicant becomes aware of the circumstances. A written submission shall also be provided within five days of the time the Applicant becomes aware of the circumstances. The written submission shall contain a description of the noncompliance and its cause; the period of noncompliance, including exact dates and times, and if the noncompliance has not been corrected; the anticipated time it is expected to continue; and steps taken

or planned to reduce, eliminate, and prevent recurrence of the noncompliance. The San Diego Water Board, or an authorized representative, may waive the written report on a case-by-case basis if the oral report has been received within 24 hours.

- B. Hazardous Substance Discharge.** Except as provided in Water Code section 13271(b), any person who, without regard to intent or negligence, causes or permits any hazardous substance or sewage to be discharged in or on any waters of the State, shall as soon as (a) that person has knowledge of the discharge, (b) notification is possible, and (c) notification can be provided without substantially impeding cleanup or other emergency measures, immediately notify the County of Riverside, in accordance with California Health and Safety Code section 5411.5 and the California Office of Emergency Services of the discharge in accordance with the spill reporting provision of the State toxic disaster contingency plan adopted pursuant to Government Code Title 2, Division 1, Chapter 7, Article 3.7 (commencing with section 8574.17), and immediately notify the State Water Board or the San Diego Water Board of the discharge. This provision does not require reporting of any discharge of less than a reportable quantity as provided for under subdivisions (f) and (g) of section 13271 of the Water Code unless the Applicant is in violation of a Basin Plan prohibition.
- C. Oil or Petroleum Product Discharge.** Except as provided in Water Code section 13272(b), any person who without regard to intent or negligence, causes or permits any oil or petroleum product to be discharged in or on any waters of the State, or discharged or deposited where it is, or probably will be, discharged in or on any waters of the State, shall, as soon as (a) such person has knowledge of the discharge, (b) notification is possible, and (c) notification can be provided without substantially impeding cleanup or other emergency measures, immediately notify the California Office of Emergency Services of the discharge in accordance with the spill reporting provision of the State oil spill contingency plan adopted pursuant to Government Code Title 2, Division 1, Chapter 7, Article 3.7 (commencing with section 8574.1). This requirement does not require reporting of any discharge of less than 42 gallons unless the discharge is also required to be reported pursuant to Clean Water Act section 311, or the discharge is in violation of a Basin Plan prohibition.
- D. Anticipated Noncompliance.** The Applicant shall give advance notice to the San Diego Water Board of any planned changes in the Project or the Compensatory Mitigation project which may result in noncompliance with Certification conditions or requirements.
- E. Transfers.** This Certification is not transferable in its entirety or in part to any person or organization except after notice to the San Diego Water Board in accordance with the following terms:
- 1. Transfer of Property Ownership:** The Applicant must notify the San Diego Water Board of any change in ownership of the Project area. Notification of change in ownership must include, but not be limited to, a statement that the Applicant has provided the purchaser with a copy of the Section 401 Water Quality Certification and that the purchaser understands and accepts the certification requirements and the obligation to implement them or be subject to liability for failure to do so; the

seller and purchaser must sign and date the notification and provide such notification to the San Diego Water Board **within 10 days of the transfer of ownership.**

2. **Transfer of Mitigation Responsibility:** Any notification of transfer of responsibilities to satisfy the mitigation requirements set forth in this Certification must include a signed statement from an authorized representative of the new party (transferee) demonstrating acceptance and understanding of the responsibility to comply with and fully satisfy the mitigation conditions and agreement that failure to comply with the mitigation conditions and associated requirements may subject the transferee to enforcement by the San Diego Water Board under Water Code section 13385, subdivision (a). Notification of transfer of responsibilities meeting the above conditions must be provided to the San Diego Water Board **within 10 days of the transfer date.**
3. **Transfer of Post-Construction BMP Maintenance Responsibility:** The Applicant assumes responsibility for the inspection and maintenance of all post-construction structural BMPs until such responsibility is legally transferred to another entity. At the time maintenance responsibility for post-construction BMPs is legally transferred the Applicant must submit to the San Diego Water Board a copy of such documentation and must provide the transferee with a copy of a long-term BMP maintenance plan that complies with manufacturer specifications. The Applicant must provide such notification to the San Diego Water Board within **10 days** of the transfer of BMP maintenance responsibility.

Upon properly noticed transfers of responsibility, the transferee assumes responsibility for compliance with this Certification and references in this Certification to the Applicant will be interpreted to refer to the transferee as appropriate. Transfer of responsibility does not necessarily relieve the Applicant of responsibility for compliance with this Certification in the event that a transferee fails to comply.

VIII. CALIFORNIA ENVIRONMENTAL QUALITY ACT COMPLIANCE

- A. The City of Wildomar is the Lead Agency under the California Environmental Quality Act (CEQA) (Public Resources Code section 21000, et seq.) section 21067, and CEQA Guidelines (California Code of Regulations, title 14, section 15000 et seq.) section 15367, and has filed a Notice of Determination dated May 10, 2018, for the Initial Study/Mitigated Negative Declaration (IS/MND) titled Initial Study for the Wildomar Crossing Retail Center Project. The Lead Agency has determined the Project will have a significant effect on the environment and mitigation measures were made a condition of the Project.
- B. The San Diego Water Board is a Responsible Agency under CEQA (Public Resources Code section 21069; CEQA Guidelines section 15381). The San Diego Water Board has considered the Lead Agency's IS/MND and finds that the Project as proposed will have a significant effect on resources within the San Diego Water Board's purview.
- C. The San Diego Water Board has required mitigation measures as a condition of this Certification to avoid or reduce the environmental effects of the Project to resources within the Board's purview to a less than significant level.

- D. The Lead Agency has adopted a mitigation monitoring and reporting program pursuant to Public Resources Code section 21081.6 and CEQA Guidelines section 15097 to ensure that mitigation measures and revisions to the Project identified in the IS/MND are implemented. The Mitigation Monitoring and Reporting Program (MMRP) is included and incorporated by reference in Attachment 5 to this Certification. The Applicant shall implement the Lead Agency's MMRP described in the IS/MND, as it pertains to resources within the San Diego Water Board's purview. The San Diego Water Board has imposed additional MMRP requirements as specified in sections V and VI of this Certification.
- E. As a Responsible Agency under CEQA, the San Diego Water Board will file a Notice of Determination in accordance with CEQA Guidelines section 15096 subdivision (i).

IX. SAN DIEGO WATER BOARD CONTACT PERSON

Darren Bradford, Environmental Scientist
Telephone: (619) 521-3356
Email: darren.bradford@waterboards.ca.gov

X. WATER QUALITY CERTIFICATION

I hereby certify that the proposed discharge from the **Wildomar Crossings** (Certification No. R9-2018-0106) will comply with the applicable provisions of sections 301 ("Effluent Limitations"), 302 ("Water Quality Related Effluent Limitations"), 303 ("Water Quality Standards and Implementation Plans"), 306 ("National Standards of Performance"), and 307 ("Toxic and Pretreatment Effluent Standards") of the Clean Water Act. This discharge is also regulated under State Water Board Order No. 2003-0017-DWQ, "*Statewide General Waste Discharge Requirements for Dredged or Fill Discharges that have Received State Water Quality Certification (General WDRs)*," which requires compliance with all conditions of this Water Quality Certification. Please note that enrollment under Order No. 2003-017-DWQ is conditional and, should new information come to our attention that indicates a water quality problem, the San Diego Water Board may issue individual waste discharge requirements at that time.

Except insofar as may be modified by any preceding conditions, all Certification actions are contingent on (a) the discharge being limited to, and all proposed mitigation being completed in strict compliance with, the applicants' Project description and/or the description in this Certification, and (b) compliance with all applicable requirements of the Basin Plan.

I, David W. Gibson, Executive Officer, do hereby certify the forgoing is a full, true, and correct copy of Certification No. R9-2019-0081 issued on February 28, 2019.

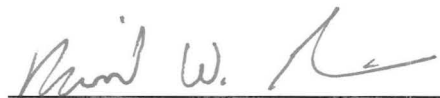

DAVID W. GIBSON
Executive Officer
San Diego Water Board

28 February 2019
Date

ATTACHMENT 1

DEFINITIONS

Activity - when used in reference to a permit means any action, undertaking, or project including, but not limited to, construction, operation, maintenance, repair, modification, and restoration which may result in any discharge to waters of the state.

Buffer - means an upland, wetland, and/or riparian area that protects and/or enhances aquatic resource functions associated with wetlands, rivers, streams, lakes, marine, and estuarine systems from disturbances associated with adjacent land uses.

California Rapid Assessment Method (CRAM) - is a wetland assessment method intended to provide a rapid, scientifically-defensible and repeatable assessment methodology to monitor status and trends in the conditions of wetlands for applications throughout the state. It can also be used to assess the performance of compensatory mitigation projects and restoration projects. CRAM provides an assessment of overall ecological condition in terms of four attributes: landscape context and buffer, hydrology, physical structure and biotic structure. CRAM also includes an assessment of key stressors that may be affecting wetland condition and a "field to PC" data management tool (eCRAM) to ensure consistency and quality of data produced with the method.

Compensatory Mitigation Project - means compensatory mitigation implemented by the Applicant as a requirement of this Certification (i.e., applicant -responsible mitigation), or by a mitigation bank or an in-lieu fee program.

Discharge of dredged material – means any addition of dredged material into, including redeposit of dredged material other than incidental fallback within, the waters of the United States and/or State.

Discharge of fill material – means the addition of fill material into waters of the United States and/or State.

Dredged material – means material that is excavated or dredged from waters of the United States and/or State.

Ecological Success Performance Standards – means observable or measurable physical (including hydrological), chemical, and/or biological attributes that are used to determine if a compensatory mitigation project meets its objectives.

Enhancement – means the manipulation of the physical, chemical, or biological characteristics of an aquatic resource to improve a specific aquatic resource function(s). Enhancement results in the gain of selected aquatic resource function(s), but may also lead to a decline in other aquatic resource function(s). Enhancement does not result in a gain in aquatic resource area.

Establishment – means the manipulation of the physical, chemical, or biological characteristics present to develop an aquatic resource that did not previously exist. Creation results in a gain in aquatic resource area.

Fill material – means any material used for the primary purpose of replacing an aquatic area with dry land or of changing the bottom elevation of a water body.

Isolated wetland – means a wetland with no surface water connection to other aquatic resources.

Mitigation Bank – means a site, or suite of sites, where resources (e.g., wetlands, streams, riparian areas) are restored, established, enhanced, and/or preserved for the purpose of providing mitigation for impacts authorized by this Certification.

Preservation - means the removal of a threat to, or preventing the decline of, aquatic resources by an action in or near those aquatic resources. This term includes activities commonly associated with the protection and maintenance of aquatic resources through the implementation of appropriate legal and physical mechanisms. Preservation does not result in a gain of aquatic resource area or functions.

Re-establishment - means the manipulation of the physical, chemical, or biological characteristics of a site with the goal of returning natural/ historic functions to a former aquatic resource. Re-establishment results in rebuilding a former aquatic resource and results in a gain in aquatic resource area and functions.

Rehabilitation - means the manipulation of the physical, chemical, or biological characteristics of a site with the goal of repairing natural/ historic functions to a degraded aquatic resource. Rehabilitation results in a gain in aquatic resource function, but does not result in a gain in aquatic resource area.

Restoration - means the manipulation of the physical, chemical, or biological characteristics of a site with the goal of returning natural/historic functions to a former or degraded aquatic resource. For the purpose of tracking net gains in aquatic resource area, restoration is divided into two categories: re-establishment and rehabilitation.

Start of Project Construction - For the purpose of this Certification, "start of Project construction" means to engage in a program of on-site construction, including site clearing, grading, dredging, landfilling, changing equipment, substituting equipment, or even moving the location of equipment specifically designed for a stationary source in preparation for the fabrication, erection or installation of the building components of the stationary source within waters of the United States and/or State.

Uplands - means non-wetland areas that lack any field-based indicators of wetlands or other aquatic conditions. Uplands are generally well-drained and occur above (i.e., up-slope) from nearby aquatic areas. Wetlands can, however, be entirely surrounded by uplands. For example, some natural seeps and constructed stock ponds lack aboveground hydrological connection to other aquatic areas. In the watershed context, uplands comprise the landscape matrix in which aquatic areas form. They are the primary sources of sediment, surface runoff, and associated chemicals that are deposited in aquatic areas or transported through them.

Water quality objectives and other appropriate requirements of state law – means the water quality objectives and beneficial uses as specified in the appropriate water quality control plan(s); the applicable provisions of sections 301, 302, 303, 306, and 307 of the Clean Water Act; and any other appropriate requirement of state law.

Wildomar Crossings, LLC
Wildomar Crossings Project
Certification No. R9-2018-0106

**ATTACHMENT 2
PROJECT LOCATION MAPS**

Figure 1 – Regional Location

Figure 2 – Project Vicinity Map (USGS Topography)

Figure 3 – Project Vicinity Map (Aerial Photograph)

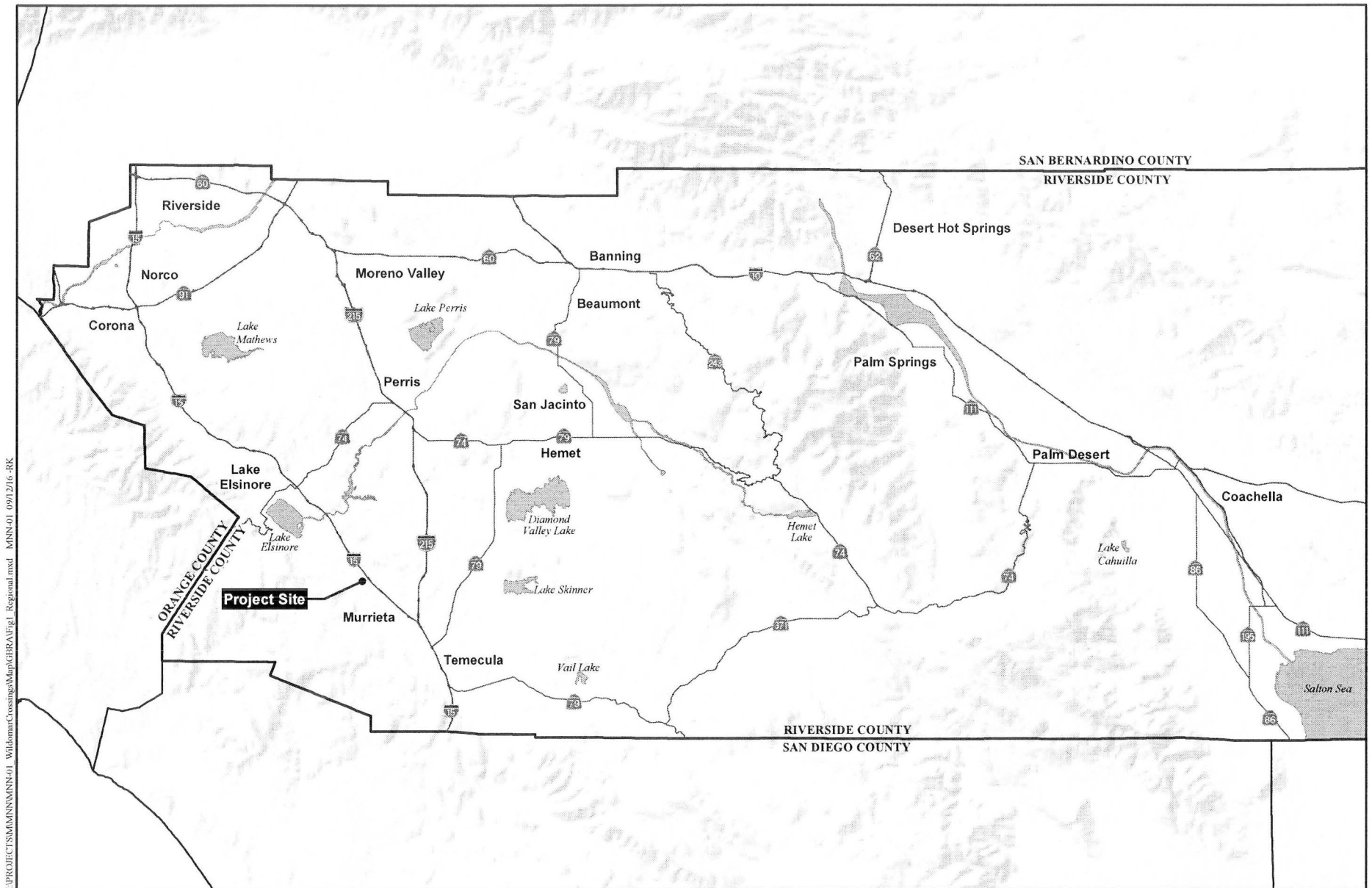

I:\PROJECTS\MAMM\MNN-01_WildomarCrossings\Map\GIBRA\Fig1_Regional.mxd MNN-01_09/12/16-RK

Regional Location

WILDOMAR CROSSINGS

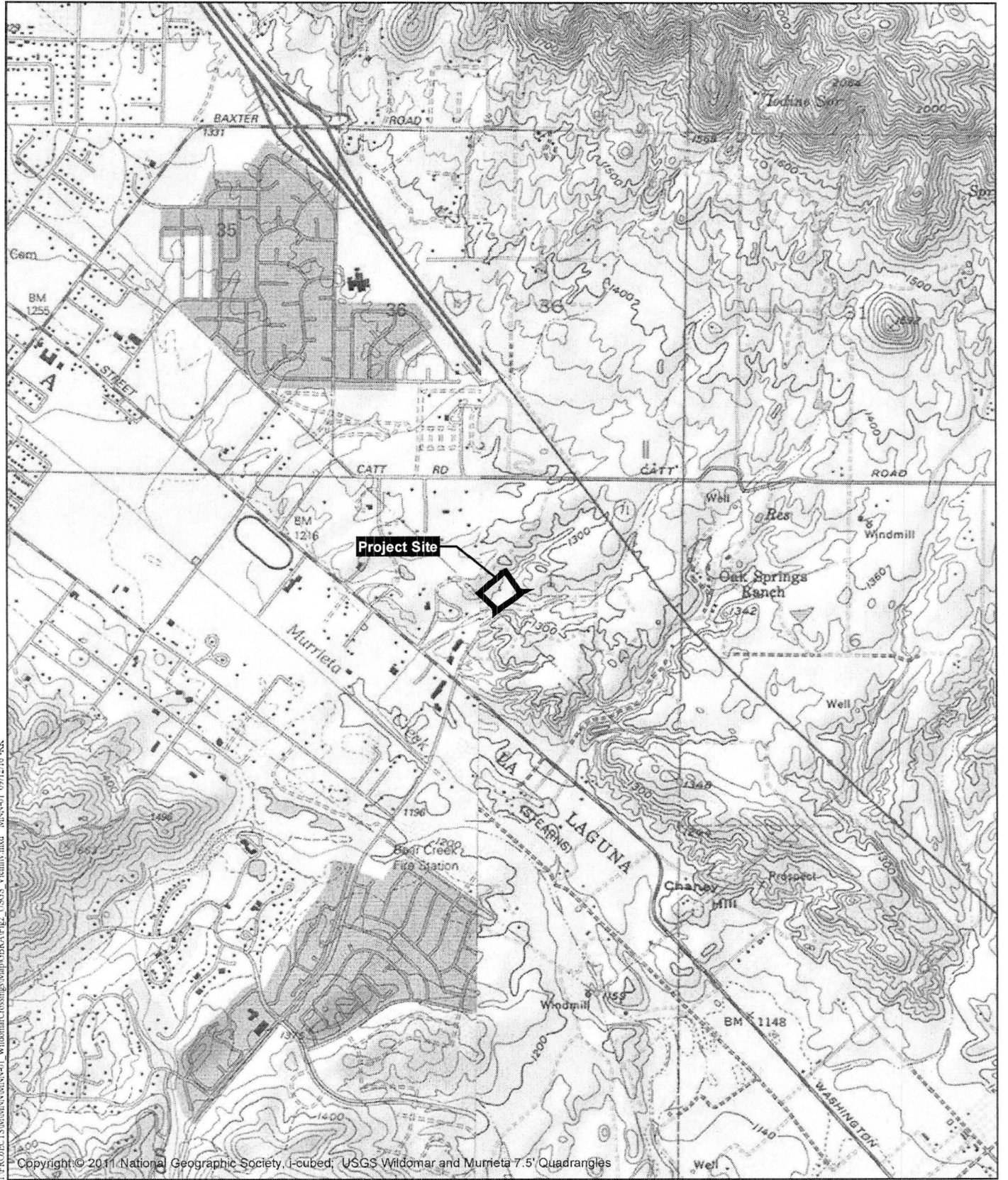

I:\PROJECTS\MANS\MANS-01_WildomarCrossing\Map\GHA\Fig2_USGS_Vicinity.mxd MNS-01_09/12/16-4K

Copyright © 2011 National Geographic Society, i-cubed; USGS Wildomar and Murrieta 7.5' Quadrangles

Project Vicinity Map (USGS Topography)

WILDOMAR CROSSINGS

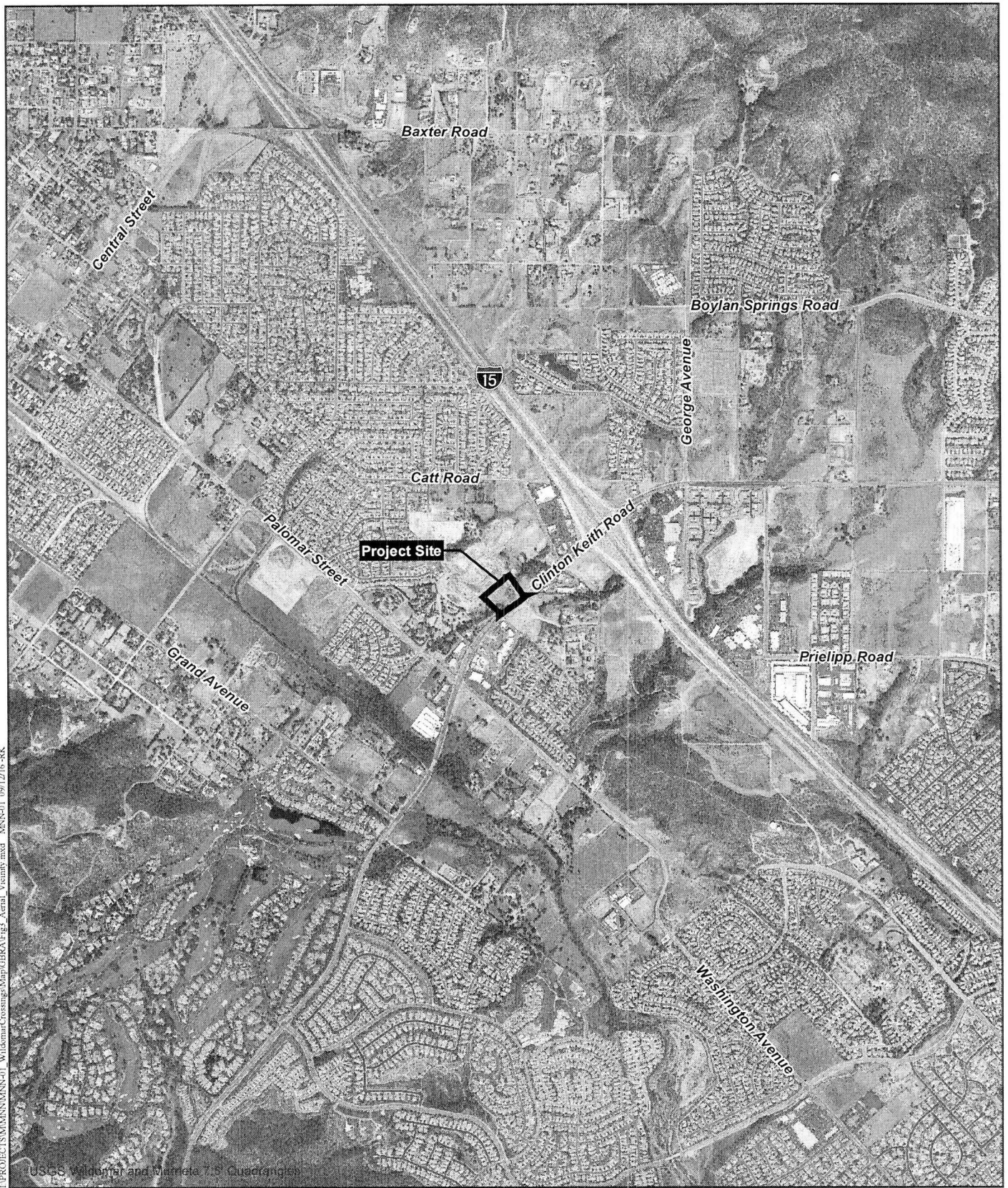

I:\PROJECTS\MMNNMANN-01_WildomarCrossings\Map\GBRA\Fig_Aerial_Vicinity.mxd MNS-01 09/12/16-RK

USGS Wildomar and Mariposa T.S. Quadrangles

Project Vicinity Map (Aerial Photograph)

WILDOMAR CROSSINGS

Wildomar Crossings, LLC
Wildomar Crossings Project
Certification No. R9-2018-0106

**ATTACHMENT 3
PROJECT SITE PLANS**

Figure 4 – USACE/RWQCB Jurisdiction
Exhibit C – Drainage Management Area (DMA) Map
Exhibit A – Pre-Development Hydrology Map
Exhibit B – Post-Development Hydrology Map
Sheet 1 of 11 – Title Sheet
Sheet 2 of 11 – Notes and Details
Sheet(s) 3 through 6 – Grading Plans
Sheet(s) 7 & 8 – Utility Plans
Sheet(s) 9 & 10 – Horizontal Control Plans
Sheet 11 of 11 – Erosion Control Plan

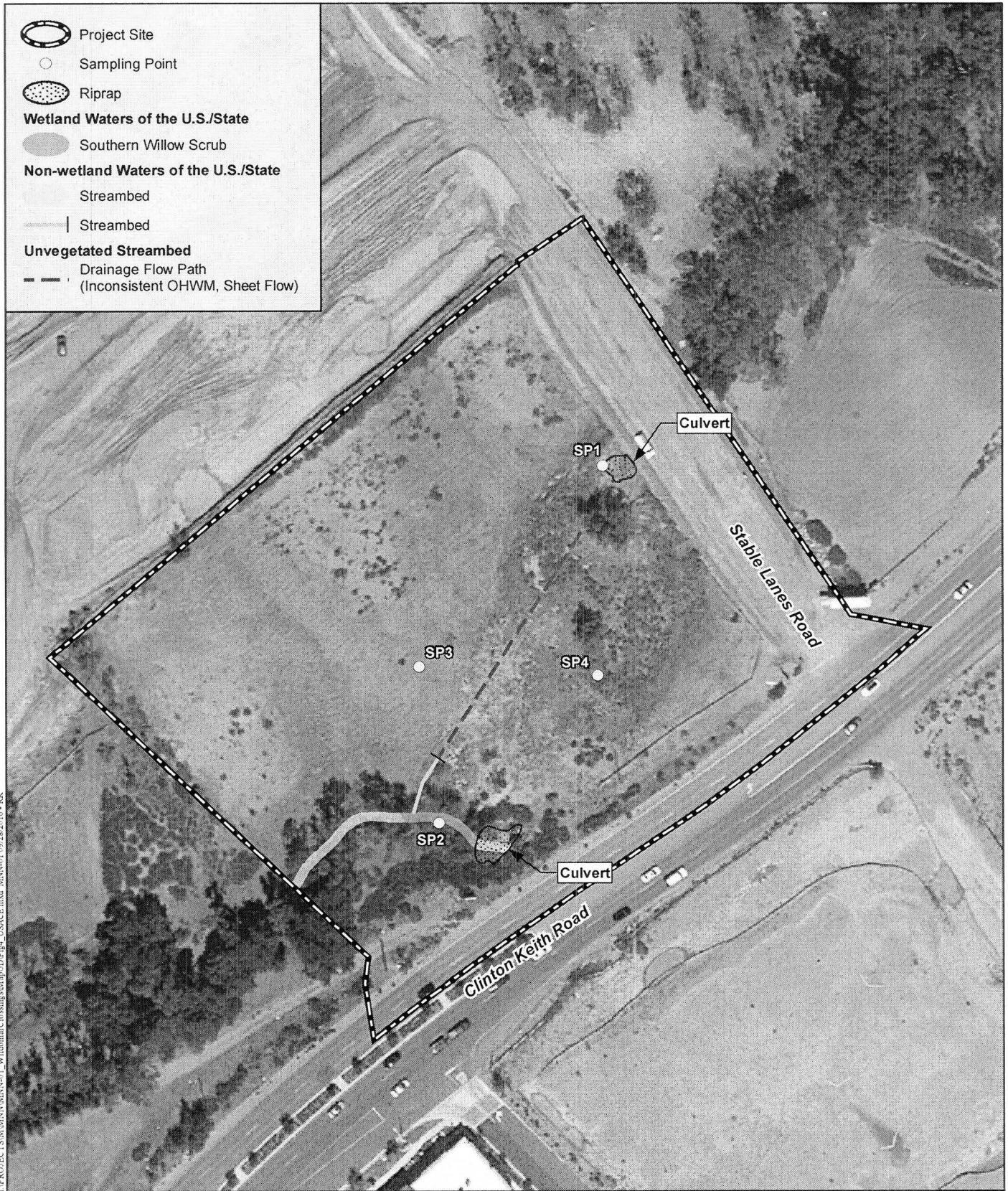

I:\PROJECTS\MN\MN\MNN-01_WildomarCrossings\Map\DFig_USACE.mxd MNN-01_09282016 - RK

USACE/RWQCB Jurisdiction

WILDOMAR CROSSINGS

WILDOMAR CROSSINGS

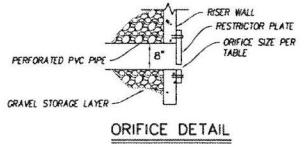
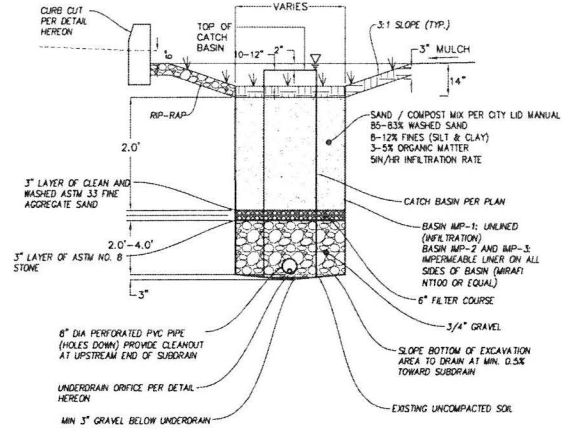

BMP	AREA PONDING	SOIL	GRAVEL	ORIFICE SIZE	
IMP 1 (BF-1)	1355 SF	10 IN	24 IN	24 IN	1/2 IN
IMP 2 (BF-1)	1130 SF	10 IN	24 IN	30 IN	1/2 IN
IMP 3 (BF-1)	2200 SF	12 IN	24 IN	48 IN	3/4 IN

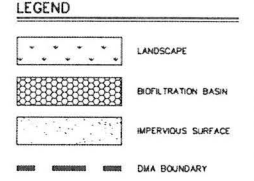
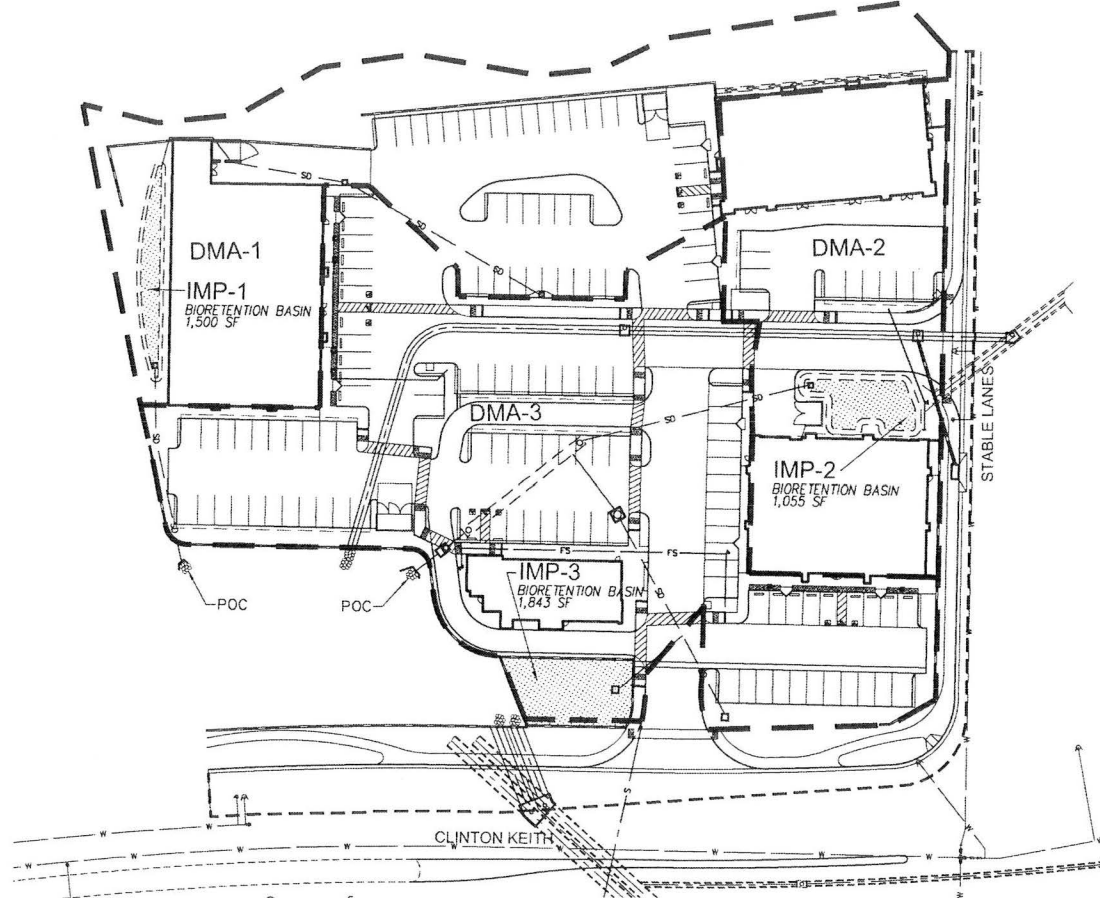

SUMMARY

SYMBOL	DESCRIPTION	DMA 1	DMA 2	DMA 3	TOTAL
[Symbol]	IMPERVIOUS SURFACE	27,059 SF	25,175 SF	54,282 SF	106,516 SF
[Symbol]	PERVIOUS SURFACE	16,096 SF	1,715 SF	5,288 SF	24,228 SF
[Symbol]	BIOFILTRATION BASIN	1,355 SF	1,130 SF	2,200 SF	3,555 SF
TOTAL		44,510 SF	28,020 SF	61,770 SF	134,300 SF

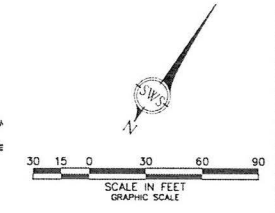

WILDOMAR CROSSINGS
EXHIBIT 'C'
DMA MAP

SWS ENGINEERING, INC.
 CIVIL ENGINEERS • LAND PLANNERS • ARCHITECTS
 27400 RIVER STREET, SUITE 100 • CLAYTON, CALIFORNIA 94520
 TEL: 925.746.8800 • FAX: 925.746.8801 • WWW.SWS-ENG.COM

WILDOMAR CROSSINGS

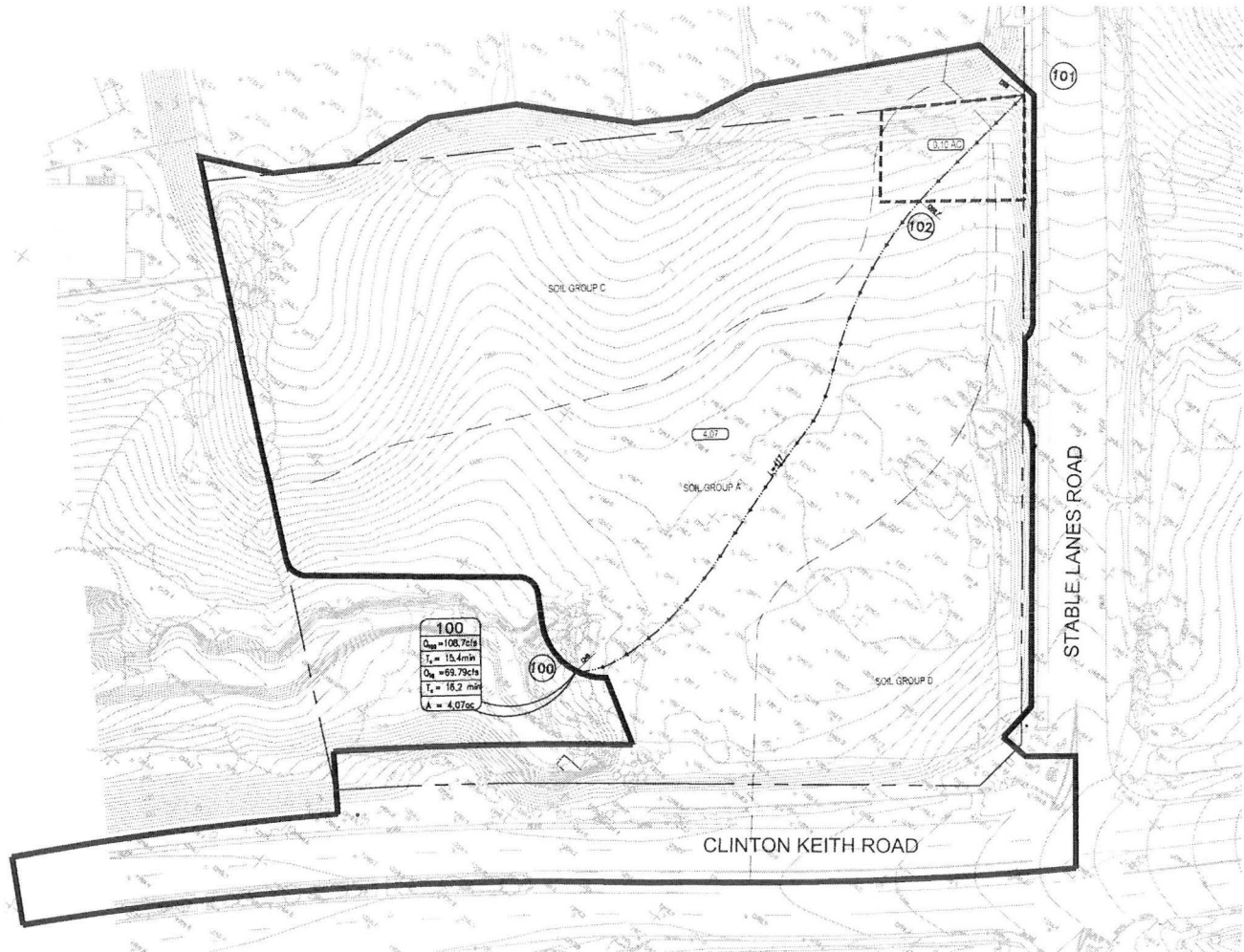

100
 $Q_{100} = 108.7 \text{ cfs}$
 $T_c = 15.4 \text{ min}$
 $Q_p = 69.79 \text{ cfs}$
 $T_p = 16.2 \text{ min}$
 $A = 4.07 \text{ ac}$

LEGEND

100 NODE

100 100-YEAR FREQUENCY DISCHARGE
 TIME OF CONCENTRATION
 AREA
 $Q_{100} = \text{XX cfs}$
 $T_c = \text{XX min}$
 $A = \text{XXX ac}$
 $Q_p = \text{XX cfs}$
 $T_p = \text{XX min}$
 $A = \text{X.XX ac}$

MAJOR BASIN BOUNDARY

FLOW PATH

BASIN AREA (ACRES)

PROPERTY LINE

SOIL BOUNDARY LINE

SUBBASIN BOUNDARY

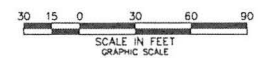

WILDOMAR CROSSINGS
EXHIBIT 'A'
PRE-DEVELOPMENT
HYDROLOGY MAP

SWS ENGINEERING, INC.
 Civil, Mechanical, • Land Planning • Surveying
 22100 Via Arroyo, Suite 100 • San Juan Capistrano, CA 92675
 San Jose, CA 95128 • Torrance, CA 90503
 P: 949.444.1111 • F: 949.444.1111 • E: info@swseng.com
 8425 Via De La Playa, San Diego, CA 92161 • P: 619.294.4277 • F: 619.294.4277