



Appendix KK
Final SEIR

Renewal of NPDES CA0109223
Carlsbad Desalination Project

FINAL

**Supplement to the
Precise Development Plan and Desalination Plant Project
Final Environmental Impact Report (EIR 03-05)
City of Carlsbad, California
SCH# 2004041081 and 2015091060
EIR Certified June 13, 2006**

Prepared for:

San Diego County Water Authority
4677 Overland Avenue
San Diego, California 92123
Contact: Mark Tegio

Prepared by:

DUDEK
605 Third Street
Encinitas, California 92024
Contact: Matthew Valerio

AUGUST 2016

TABLE OF CONTENTS

<u>Section</u>	<u>Page No.</u>
RESPONSES TO COMMENTS	RTC-1
A City of Escondido, Joanne Tasher (Letter dated April 15, 2016)	RTC-2
B U.S. Army Corps. of Engineers (USACE), Shari Johnson, Regulatory Assistant (Letter dated April 18, 2016)	RTC-3
C California Division of Oil, Gas and Geothermal Resources, Kathleen Andrews, Associate Oil and Gas Engineer (Letter dated April 19, 2016)	RTC-5
D The Flower Fields, Joni Miringoff (Letter dated May 2, 2016).....	RTC-6
E Carlsbad Aquafarm, Thomas Grimm, CEO and President (Letter dated May 3, 2016)	RTC-8
F Carlsbad Chamber of Commerce, Ted Owen, President and CEO (Letter dated May 4, 2016)	RTC-10
G Grand Pacific Resorts, Tim Stripe, Co-President (Letter dated May 4, 2016)	RTC-12
H San Diego Regional Economic Development Corporation (SDEDC), Mark Cafferty, President and CEO (Letter dated May 10, 2016)	RTC-13
I Agua Hedionda Lagoon Foundation (AHLF), Lisa Rodman, CEO (Letter dated May 23, 2016)	RTC-15
J City of Carlsbad, Pam Drew, Associate Planner (Letter dated May 26, 2016)	RTC-16
K California Department of Transportations (CALTRANS), Jacob Armstrong, Chief (Letter dated May 25, 2016)	RTC-18
L San Diego Regional Water Quality Control Board (RWQCB), James G. Smith, AEO for David Gibson, Executive Officer (Letter dated May 27, 2016)	RTC-19
M California Coastal Commission (CCC), Tom Luster (Letter dated May 27, 2016)	RTC-36
N Rincon Band of Luiseño Indians (Rincon), Vincent Whipple, Cultural Resources Manager (Letter dated May 27, 2016)	RTC-46
SECTION 1 EXECUTIVE SUMMARY	1-1
1.1 Introduction.....	1-1
1.2 Purpose.....	1-2
1.3 Project Location	1-4
1.4 Project Description.....	1-4
1.5 Environmental Review Requirements	1-7

TABLE OF CONTENTS (Continued)

<u>Section</u>	<u>Page No.</u>
1.5.1 Supplement to an EIR	1-7
1.5.2 Regional Water Quality Control Board – Amended Report of Discharge	1-7
1.6 Issues Of Concern	1-8
1.7 Environmental Analysis	1-9
SECTION 2 INTRODUCTION.....	2-1
2.1 Purpose And Scope of the Supplement to the FEIR	2-1
2.2 Noticing.....	2-4
2.3 Regulatory Changes	2-5
SECTION 3 PROJECT DESCRIPTION	3-1
3.1 Background And History	3-1
3.2 Project Location	3-14
3.3 Environmental Setting	3-14
3.4 Project Modifications	3-21
3.5 Purpose.....	3-46
3.6 Required Actions and Approvals	3-47
SECTION 4 ENVIRONMENTAL ANALYSIS.....	4.1-1
4.1 Air Quality	4.1-1
4.1.1 Existing Conditions.....	4.1-1
4.1.2 Significance Criteria	4.1-6
4.1.3 Impacts	4.1-7
4.1.4 Mitigation Measures	4.1-14
4.1.5 Level of Significance after Mitigation/Residual Impact.....	4.1-14
4.2 Biological Resources	4.2-1
4.2.1 Existing Conditions.....	4.2-1
4.2.2 Significance Criteria	4.2-3
4.2.3 Impacts	4.2-4
4.2.4 Mitigation Measures	4.2-18
4.2.5 Level of Significance after Mitigation/Residual Impact.....	4.2-20
4.3 Greenhouse Gas Emissions.....	4.3-1
4.3.1 Existing Conditions.....	4.3-4.3-1
4.3.2 Significance Criteria	4.3-9
4.3.3 Impacts	4.3-11
4.3.4 Mitigation Measures	4.3-18
4.3.5 Level of Significance after Mitigation/Residual Impact.....	4.3-18

TABLE OF CONTENTS (Continued)

Section	Page No.
4.4 Hydrology and Water Quality.....	4.4-1
4.4.1 Existing Conditions.....	4.4-1
4.4.2 Significance Criteria	4.4-2
4.4.3 Impacts	4.4-3
4.4.4 Mitigation Measures	4.4-11
4.4.5 Level of Significance after Mitigation/Residual Impact.....	4.4-12
4.5 Energy.....	4.5-1
4.5.1 Existing Conditions.....	4.5-1
4.5.2 Significance Criteria	4.5-3
4.5.3 Impacts	4.5-4
4.5.4 Mitigation Measures	4.5-7
4.5.5 Level of Significance after Mitigation/Residual Impact.....	4.5-7
SECTION 5 CUMULATIVE IMPACTS	5-1
5.1 Introduction/Methodology	5-1
5.1.1 Cumulative Projects	5-1
5.2 Analysis of Cumulative Impacts.....	5-3
5.2.1 Air Quality	5-4
5.2.2 Biological Resources	5-4
5.2.3 Greenhouse Gas Emissions.....	5-5
5.2.4 Hydrology and Water Quality.....	5-5
5.2.5 Energy.....	5-6
SECTION 6 GROWTH-INDUCING IMPACTS	6-1
6.1 Introduction.....	6-1
6.2 Existing Water Supplies.....	6-2
6.3 Regional Planning – Growth Forecasts And Water Demand Projections	6-3
6.4 Urban Water Management Plans	6-6
SECTION 7 REFERENCES AND REPORT PREPARERS	7-1
7.1 REFERENCES	7-1
7.2 REPORT PREPARERS.....	7-7

TABLE OF CONTENTS (Continued)

Page No.

APPENDICES

- S-A Initial Study
- S-B Air Quality and GHG Emissions Modelling Results
- S-C Energy Minimization and Greenhouse Gas Reduction Plan

FIGURES

1	Regional Vicinity Map.....	3-17
2	Location Map.....	3-19
3	Aerial.....	3-23
4	Intake/Discharge Site Location.....	3-25
6	Screened Flow Intake Section.....	3-31
7	Screened Flow Dilution Section.....	3-33
8	Bedford Pump’s Submersible Fish-Friendly Axial Flow Pump – Cutaway.....	3-35
9	Co-Location of Carlsbad Desalination Plant and Encina Power Station.....	3-37
10	Proposed Site Layout.....	3-39

TABLES

1-1	Project Modifications Summary Comparison to Final Environmental Impact Report/ Constructed Carlsbad Desalination Project	1-5
1-2	Proposed Intake/Discharge Modifications – Summary of Environmental Impacts and Applicable Mitigation.....	1-10
3-1	Construction Phasing.....	3-43
3-2	Daily Trips per Construction Phase Summary.....	3-45
4.1-1	Ambient Air Quality Standards	4.1-1
4.1-2	Ambient Air Quality Data (ppm unless otherwise indicated).....	4.1-5
4.1-3	Frequency of Air Quality Standard Violations	4.1-5
4.1-4	SDAPCD Air Quality Significance Thresholds.....	4.1-6
4.1-5	Construction Schedule	4.1-9
4.1-6	Estimated Maximum Daily Construction Emissions – Unmitigated (pounds per day)	4.1-10
4.2-1	Impingement Minimize Comparison	4.2-8
4.2-2	Entrainment Impact Comparison	4.2-8
4.2-3	Test Summary for Brine Dilution Study.....	4.2-12
4.3-1	Greenhouse Gas Sources in California	4.3-8
4.3-2	Estimated Construction Greenhouse Gas Emissions (total metric tons)	4.3-11

TABLE OF CONTENTS (Continued)

	<u>Page No.</u>
4.4-1 Summary of CDP Production and Discharge Flows Existing Permitted Discharge and Proposed Discharge	4.4-4
5-1 Cumulative Projects	5-2

TABLE OF CONTENTS (Continued)

INTENTIONALLY LEFT BLANK

ACRONYMS AND ABBREVIATIONS

Acronym/Abbreviations	Definition
AAQS	Ambient Air Quality Standards
AB	Assembly Bill
APCD	air pollution control districts
AQMD	air quality management district
BMP	best management practice
BMZ	brine mixing zone
BWT	Bilfinger Water Technology
CAA	Clean Air Act
CAAQS	California Ambient Air Quality Standards
CAFE	Corporate Average Fuel Economy
CAP	Climate Action Plan
CAPCOA	California Air Pollution Control Officers Association
CAR	Climate Action Registry
CARB	California Air Resources Board
CCAR	California Climate Action Registry
CCC	California Coastal Commission
CCR	California Code of Regulations
CDP	Carlsbad Desalination Project
CEC	California Energy Commission
CEQA	California Environmental Quality Act
CFR	Code of Federal Regulations
CH ₄	methane
CO	carbon monoxide
CO ₂	carbon dioxide
CO ₂ E	carbon dioxide equivalent
ECR	El Camino Real
EIR	environmental impact report
EPA	Environmental Protection Agency
EPS	Encina Power Station
EWA	<u>Encina Wastewater Authority</u>
FEIR	Final Environmental Impact Report
FERC	Federal Energy Regulatory Commission
GHG	greenhouse gas
GWP	global warming potential
HVAC	heating, ventilation, and air conditioning
IPCC	Intergovernmental Panel on Climate Change
LCP	Local Coastal Program
LEED	Leadership in Energy and Environmental Design
LTRP	long-term energy resource plan
MLMP	Marine Life Mitigation Plan
MMT	million metric tons
mm	millimeter

ACRONYMS AND ABBREVIATIONS

Acronym/Abbreviations	Definition
MT	metric tons
MWh/h	<u>megawatt-hours per hour</u>
MWD	Metropolitan Water District of Southern California
NAAQS	National Ambient Air Quality Standards
NF ₃	nitrogen trifluoride
NHTSA	National Highway Traffic Safety Administration
NO ₂	O ₃ , nitrogen dioxide
NOA	Notice of Availability
NOI	Notice of Intent
NOP	Notice of Preparation
NPDES	National Pollutant Discharge Elimination System
O ₃	ozone
OPR	Office of Planning and Research
PACE	Property Assessed Clean Energy
PDP	Precise Development Plan
PEIR	Program Environmental Impact Report
PM ₁₀	coarse particulate matter
PM _{2.5}	fine particulate matter
RAQS	Regional Air Quality Strategy
RCP	Regional Comprehensive Plan
RES	Regional Energy Strategy
RFS	Renewable Fuel Standard
RPS	Renewable Portfolio Standard
RTP	Regional Transportation Plan
RWQCB	Regional Water Quality Control Board
SANDAG	San Diego Association of Governments
SB	Senate Bill
SCCRP	South Carlsbad Coastal Redevelopment Plan
SCS	Sustainable Communities Strategy
SDAB	San Diego Air Basin
SDAPCD	San Diego Air Pollution Control District
SEIR	Supplement to the Environmental Impact Report
SF ₆	sulfur hexafluoride
<u>SIG</u>	<u>seafloor infiltration galleries</u>
SIP	State Implementation Plan
SO ₂	sulfur dioxide
SWMP	Storm Water Management Plan
SWPPP	Storm Water Pollution Prevention Plan
SWRCB	State Water Resources Control Board
SWRQB	State Water Resources Control Board
TAC	toxic air contaminant
USFWS	U.S. Fish and Wildlife Service

ACRONYMS AND ABBREVIATIONS

Acronym/Abbreviations	Definition
UWMP	Urban Water Management Plan
VMT	vehicle miles traveled
VOC	volatile organic compound
WET	whole effluent toxicity
WPA	Water Purchase Agreement

ACRONYMS AND ABBREVIATIONS

INTENTIONALLY LEFT BLANK

RESPONSES TO COMMENTS

INTRODUCTION

The Water Authority, as lead agency pursuant to the California Environmental Quality Act (CEQA) (California Public Resources, Section Code 21000 et seq.) and the CEQA Guidelines (14 CCR 15000 et seq.), has prepared this Final Supplement to the Environmental Impact Report (Final SEIR) and Responses to Comments on the Draft SEIR analyzing proposed modifications to the Carlsbad Desalination Plant (CDP) to support the planned transition from co-located operations with the Encina Power Station (EPS) to permanent stand-alone operations. The Water Authority is analyzing the project proposal of Poseidon Resources (Channelside) LP (Poseidon or Applicant). The Draft SEIR was available to the public for review in accordance with CEQA Guidelines §15087.2. A Notice of Availability (NOA) was released on April 13, 2016, starting the 45-day public review period for the Draft SEIR that ended on May 28, 2016, 2016. Consistent with CEQA Guidelines §15163(d), the Draft SEIR was circulated without the FEIR. However, the FEIR including Addenda was made available at <http://www.sdcwa.org/environmental-impact-reports-and-mitigated-negative-declarations>.

In addition, the NOA included notice of a public hearing on May 26, 2016 to receive comments on the Draft SEIR. No oral comments or public testimony was made at the public hearing. During the public review period 14 comment letters were received, for which responses are provided herein. Comment letters have been coded alphabetically based on the order in which they were received by the Water Authority.

Where responses to comments require modifications to the SEIR, those changes have been made in the Final SEIR text, and are detailed with each response. The revisions made to the Final SEIR do not result in significant new information as defined by CEQA, but merely amplifies and/or clarifies the intent of information provided within the Draft SEIR (CEQA Guidelines §15088.5). This document consists of the Responses to Comments followed by the Final SEIR.

RESPONSES TO COMMENTS

Comment Letter A

From: Joanne Tasher [<mailto:jtasher@escondido.org>]
Sent: Friday, April 15, 2016 3:21 PM
To: Tegio, Mark
Subject: FW: SDCWA - EIR Notice sent from Dudek

Mark,
The City of Escondido received the attached Notice of Availability a Draft EIR for the Desal plant. The envelope was addressed to Charles Grimm, Planning Director. Charles Grimm retired a couple years ago. Could you please have someone remove his name from your database?

Please address future mailings regarding any notices for SDCWA to City of Escondido Community Development Director. This way the notices will always go to the appropriate person.
Thank you.

Regards,
Joanne Tasher
City of Escondido
Planning Division
760-839-4671

A-1

Response to Comment Letter A

City of Escondido
Joanne Tasher
April 15, 2016

A-1

The City of Escondido provides updated contact information, which the Water Authority has updated their database to reflect. No further response is necessary.

RESPONSES TO COMMENTS

Comment Letter B

From: Johnson, Shari SPL [<mailto:Shari.Johnson@usace.army.mil>]
Sent: Monday, April 18, 2016 1:04 PM
To: Tegio, Mark
Subject: RE: Carlsbad Desalination Plant Intake and Discharge Facility Modifications Project

Dear Mr. Tegio:

It has come to our attention that you are evaluating the Carlsbad Desalination Plant Intake and Discharge Facility Modifications Project.

This activity may require a U.S. Army Corps of Engineers permit.

A Corps of Engineers permit is required for:

a) structures or work in or affecting "navigable waters of the United States" pursuant to Section 10 of the Rivers and Harbors Act of 1899.

Examples include, but are not limited to,

1. constructing a pier, revetment, bulkhead, jetty, aid to navigation, artificial reef or island, and any structures to be placed under or over a navigable water;

2. dredging, dredge disposal, filling and excavation;

b) the discharge of dredged or fill material into, including any redeposit of dredged material other than incidental fallback within, "waters of the United States" and adjacent wetlands pursuant to Section 404 of the Clean Water Act of 1972. Examples include, but are not limited to,

1. creating fills for residential or commercial development, placing bank protection, temporary or permanent stockpiling of excavated material, building road crossings, backfilling for utility line crossings and constructing outfall structures, dams, levees, groins, weirs, or other structures;

2. mechanized landclearing, grading which involves filling low areas or land leveling, ditching, channelizing and other excavation activities that would have the effect of destroying or degrading waters of the United States;

3. allowing runoff or overflow from a contained land or water disposal area to re-enter a water of the United States;

4. placing pilings when such placement has or would have the effect of a discharge of fill material;

c) the transportation of dredged or fill material by vessel or other vehicle for the purpose of dumping the material into ocean waters pursuant to Section 103 of the Marine Protection, Research and Sanctuaries Act of 1972;

d) any combination of the above.

An application for a Department of the Army permit is available on Our website:

B-1

Response to Comment Letter B

**U.S. Army Corps. of Engineers (USACE)
Shari Johnson, Regulatory Assistant
April 18, 2016**

B-1

The USACE identifies activities that require a permit from the USACE. Poseidon has met with the USACE to initiate securing necessary permit(s). No further response is necessary.

RESPONSES TO COMMENTS

<http://www.usace.army.mil/Portals/2/docs/civilworks/permitapplication.pdf> .

If you have any questions, please contact me (contact information below).

Shari Johnson
Regulatory Assistant
U.S. Army Corps of Engineers, Los Angeles District Regulatory Division, Carlsbad Field Office
5900 La Place Court, Suite 100
Carlsbad, CA 92008
Tel 760.602.4829; Fax 760.602.4848

↑ B-1
Cont.

RESPONSES TO COMMENTS

Comment Letter C

From: Andrews, Kathleen@DOC [<mailto:Kathleen.Andrews@conservation.ca.gov>]
Sent: Tuesday, April 19, 2016 11:40 AM
To: Tegio, Mark
Subject: Notice of Availability of a Draft Supplement to an EIR, Precise Development Plan and Desalination Plant Project

Hello, Mark,
I received the notice of availability of the DEIR for the Precise Development Plan and Desalination Plant Project. The Division of Oil, Gas, and Geothermal Resources comments on the potential effects of projects on oil, gas, and geothermal resources. There are no anticipated effects of the project on oil, gas, or geothermal resources, so the Division is not planning on sending a formal response.

However, the letter from Dudek was addressed to Dave Sanchez. Mr. Sanchez no longer works for the Division of Oil, Gas, and Geothermal Resources, and I am preparing the Division's response to CEQA projects in southern California. Please update your records appropriately, and address similar future letters to me. Thanks in advance.

Kathleen Andrews
Associate Oil and Gas Engineer
California Division of Oil, Gas and Geothermal Resources
Cypress, CA 90630
714-816-6847



Drought.CA.gov
WaterUseItWisely.com/WaysToConserve



C-1

C-2

Response to Comment Letter C

**California Division of Oil,
Gas and Geothermal Resources
Kathleen Andrews, Associate Oil and Gas Engineer
April 19, 2016**

- C-1** The Division states there are no potential effects of the project on oil, gas, or geothermal resources. This is consistent with the Water Authority's analysis and no further response is necessary.
- C-2** The Division provides updated contact information, which the Water Authority has updated their database to reflect. No further response is necessary.

RESPONSES TO COMMENTS

Comment Letter D

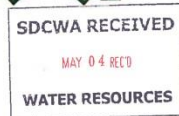

May 2, 2016

Mr. Mark Tegio
Senior Water Resources Specialist
San Diego County Water Authority
4677 Overland Ave.
San Diego, CA 92123

Subject: Comments on the Draft Supplement to the Precise Development Plan and Desalination Plant Project Final Environmental Impact Report

Dear Mark:

I represent The Flower Fields® in Carlsbad, CA, the only working ranunculus field in the world that is open to the public, and I am writing you to comment on the Supplement to the Precise Development Plan and Desalination Plant Project Final Environmental Impact Report (EIR 03-05). I appreciate the careful production of this document and encourage the San Diego County Water Authority's Board of Directors to certify the SEIR to ensure that the Claude "Bud" Lewis Carlsbad Desalination Plant continues to meet the highest environmental standards.

The Carlsbad plant is the largest seawater desalination plant in the nation and it provides tremendous benefits for our region's water supply reliability. Shortly after commercial operations began in December 2015, the State Water Resources Control Board certified supplies from the plant as drought-resilient, reducing the impacts of the state conservation mandates on our region. In addition, the Carlsbad plant represents a strategic long-term asset for our region's 3.2 million residents and \$218 billion economy that should be preserved and protected.

The Flower Fields has been an important part of Carlsbad's local heritage for over 60 years and attracts over 150,000 visitors each season. Each spring, The Flower Fields dazzle visitors with over 50 acres of Giant Tecolote Ranunculus, roses, poinsettias and orchids. Approximately 6-8 million ranunculus bulbs are harvested each season and sold at nurseries and garden centers across the country. We also provide educational activities for children, including classroom presentations, activity sheets, field trips and an on-site growing program, and composting workshops for adults.

With the dry weather conditions our region has experienced in the past few years, irrigation water has been a necessity for the survival of our operations. Many local farms have had to reduce the size of their crop planting to compensate for the reduced water supply. One of the few options our region has in dealing with the reduction in imported water is to diversify and increase the local water supplies through desalination. We believe that the Carlsbad Desalination Plant has been well-conceived, has undergone rigorous testing to ensure environmental safety, and has been providing multiple benefits to our entire region since December 2015.

7220 AVENIDA ENCINAS SUITE 204 • CARLSBAD, CA 92011
TELEPHONE (760) 930-9123 FAX (760) 431-9020 WWW.THEFLOWERFIELDS.COM

D-1

Response to Comment Letter D

The Flower Fields
Joni Miringoff
May 2, 2016

D-1

The Flower Fields provided statements supporting the CDP and the proposed modifications. No further response is necessary.

RESPONSES TO COMMENTS



A reliable and affordable water supply is crucial to the survival of The Flower Fields and hundreds of small farming operations in San Diego. We strongly urge the Board to certify the SEIR for the Carlsbad Desalination Project so that we can continue to benefit from this important new local water supply.

Thank you again for the opportunity to comment. I look forward to the certification of the SEIR and the upgrades at the Carlsbad plant.

Sincerely,

Joni Miringoff
The Flower Fields
7220 Avenida Encinas
Suite 204
Carlsbad, CA 92011
(760) 930-9123 x118

↑
D-1
Cont.

7220 AVENIDA ENCINAS SUITE 204 • CARLSBAD, CA 92011
TELEPHONE (760) 930-9123 FAX (760) 431-9020 WWW.THEFLOWERFIELDS.COM

RESPONSES TO COMMENTS

Comment Letter E



May 3, 2016

Mr. Mark Tegio
Senior Water Resources Specialist
San Diego County Water Authority
4677 Overland Ave.
San Diego, CA 92123

Subject: Comments on the Draft Supplement to the Precise Development Plan and Desalination Plant Project Final Environmental Impact Report

Dear Mr. Tegio:

My name is Thomas Grimm and I am the CEO & President of Carlsbad Aquafarm, located at 4600 Carlsbad Blvd., Carlsbad, CA 92008. Our business is located on the Agua Hedionda Lagoon and employs 20 workers and produces over 2 million oysters, 550,000 pounds of mussels, 50,000 pounds of culinary seaweed annually. The shellfish grown in the lagoon deliver many ecosystem benefits including providing habitat and foraging grounds for a diverse community of fish, invertebrate and bird species, improving water quality, cycling nutrients, sequestering carbon, stabilizing sediments and improving the photic zone that allows eelgrass and other seagrasses to thrive. As foundation species, oysters, mussel and eelgrass improve the environment and promote ecosystem health. The Carlsbad Aquafarm, Southern California only shellfish farm, is a model of sustainable aquaculture. Local aquaculture has become increasingly important, as California becomes ever more reliant on imported seafood, which accounts for over 92% of the seafood consumed in the state. As the global demand for seafood grows, aquaculture will play an increasingly important role in food security in providing a sustainable, reliable, local supply of quality seafood for California.

Our business, in particular, is heavily dependent upon clean water and beaches. That is why, when the Supplement to the Precise Development Plan and Desalination Plant Project Final Environmental Impact Report (SEIR) for the Carlsbad Desalination Plant was circulated I paid close attention to the potential effects on the Lagoon. The Carlsbad Aquafarm appreciates the careful production of this document and encourages the San Diego County Water Authority's Board of Directors to certify the SEIR to ensure that the Claude "Bud" Lewis Carlsbad Desalination Plant continues to meet the highest environmental standards.

The SEIR shows that proposed measures will mitigate all significant impacts related to the upgrades to biological resources and water quality, and that the project will have no significant impacts on greenhouse gas emissions. In addition, no significant impacts related to energy were identified associated with the proposed modifications. The project applicant (Poseidon) has committed to an Energy Minimization and GHG Reduction Plan that requires efficient energy use and net carbon neutral plant operations inclusive of the proposed modifications.

4600 Carlsbad Boulevard, Carlsbad, CA 92008

Response to Comment Letter E

**Carlsbad Aquafarm
Thomas Grimm, CEO and President
May 3, 2016**

- E-1** The Carlsbad Aquafarm provided statements supporting the CDP and the proposed modifications. No further response is necessary.
- E-2** The Carlsbad Aquafarm provided statements supporting the CDP and the proposed modifications. No further response is necessary.

E-1

E-2

RESPONSES TO COMMENTS

The proposed upgrades assessed in the SEIR were anticipated in the Water Purchase Agreement approved by the Water Authority Board in November 2012, and I appreciate the foresight by the Water Authority and the vision of Poseidon to ensure that the plant could become a stand-alone operation that serves the San Diego region for decades to come. Specifically, the incorporation of fish-friendly pumps, upgraded screening technology and a system to safely return fish caught in the intake to the ocean will further protect marine life. This is essential with the power plant ceasing operations that the desalination plant will continue to provide the lagoon with a new steward that has a shared interest in the Lagoon's long-term vitality and ecological health.

E-3

Thank you again for the opportunity to comment. I look forward to the certification of the SEIR and the upgrades at the Carlsbad plant.

Sincerely,



Thomas Grimm, CEO & President
Carlsbad Aquafarm

4600 Carlsbad Boulevard, Carlsbad, CA 92008

E-3

The Carlsbad Aquafarm provided statements supporting the CDP and the proposed modifications. No further response is necessary.

RESPONSES TO COMMENTS

Comment Letter F

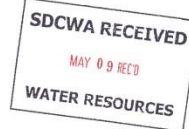

May 4, 2016

Mr. Mark Tegio
Senior Water Resources Specialist
San Diego County Water Authority
4677 Overland Ave.
San Diego, CA 92123

Subject: Comments on the Draft Supplement to the Precise Development Plan and Desalination Plant Project Final Environmental Impact Report

Dear Mr. Tegio:

Thank you for the opportunity to comment on the Supplement to the Precise Development Plan and Desalination Plant Project Final Environmental Impact Report (EIR 03-05). The Carlsbad Chamber of Commerce appreciates the careful production of this document and encourages the San Diego County Water Authority's Board of Directors to certify the SEIR to ensure that the Claude "Bud" Lewis Carlsbad Desalination Plant continues to meet the highest environmental standards.

Since 1923, the Carlsbad Chamber of Commerce has been working to promote a favorable business climate at the local, state and federal levels. We make certain the business perspective is heard on a variety of critical issues that affect our local economy. Currently, the Chamber represents more than 1,700 business members that employ over 35,000 employees.

The Carlsbad Chamber of Commerce and many of its many members have written and testified at public hearings numerous times on behalf of the Carlsbad Desalination Plant during the past decade. The Chamber believes that the Carlsbad Plant is an environmentally responsible solution to the region's water needs is a key component to achieving the goal of water reliability. San Diego now has its own locally-produced, drought-resistant supply.

The Carlsbad plant is also among the most environmentally responsible seawater desalination plants in the world, and it will be the first to incorporate the requirements of California's 2015 Ocean Plan Amendment. The SEIR shows that proposed measures will mitigate all significant impacts related to the upgrades to biological resources and water quality, and that the project will have no significant impacts on greenhouse gas emissions. In addition, no significant

5934 Priestly Drive | Carlsbad, CA 92008 | 760.831.8400 T | 760.831.9153 F
www.carlsbad.org

F-1

F-2

Response to Comment Letter F

Carlsbad Chamber of Commerce
Ted Owen, President and CEO
May 4, 2016

- F-1** The Carlsbad Chamber of Commerce acknowledges the commenting opportunity and provides a synopsis of the Chamber. No further response is necessary.
- F-2** The Carlsbad Chamber of Commerce provides a summary of their prior support for the project and the commitment to the environment as evidenced by the mitigation measures identified in the SEIR that mitigate all significant impacts of the project. No further response is necessary.

RESPONSES TO COMMENTS

<p style="text-align: right;">Page 2</p> <p>impacts related to energy were identified associated with the proposed modifications. The project applicant (Poseidon) has committed to an Energy Minimization and GHG Reduction Plan that requires efficient energy use and net carbon neutral plant operations inclusive of the proposed modifications.</p> <p>The proposed upgrades assessed in the SEIR were anticipated in the Water Purchase Agreement approved by the Water Authority Board in November 2012, and I appreciate the foresight by the Water Authority and Poseidon to ensure that the plant can become a stand-alone operation that serves the San Diego region for decades. Specifically, the incorporation of fish-friendly pumps, upgraded screening technology and a system to safely return fish caught in the intake to the ocean will further protect marine life.</p> <p>Thank you again for the opportunity to comment. I look forward to the certification of the SEIR and the upgrades at the Carlsbad plant.</p> <p>Sincerely,</p>  <p>Ted Owen President/CEO</p>	<p style="text-align: center;">F-2 Cont.</p> <p style="text-align: center;">F-3</p> <p>F-3 The Carlsbad Chamber of Commerce expresses their support for the CDP and specifically for the proposed modifications. No further response is necessary.</p>
---	--

RESPONSES TO COMMENTS

Comment Letter G



May 4, 2016

Mr. Mark Tegio
Senior Water Resources Specialist
San Diego County Water Authority
4677 Overland Ave.
San Diego, CA 92123

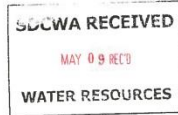

Subject: Comments on the Draft Supplement to the Precise Development Plan and Desalination Plant Project Final Environmental Impact Report

Dear Mr. Tegio:

Thank you for the opportunity to comment on the Supplement to the Precise Development Plan and Desalination Plant Project Final Environmental Impact Report (EIR 03-05).

My company, Grand Pacific Resorts, is headquartered in Carlsbad where we manage the Pacific Palisades Resort, Grand Pacific MarBrisa, the Carlsbad Inn and the Sheraton Carlsbad, as well as numerous properties throughout California. We have always promoted North County and the entire San Diego region as a premier vacation destination to our clients. Tourism is inarguably one of our region's most important industries; it employs hundreds of thousands of San Diegans and contributes billions towards our local economy. Unfortunately, San Diego's hospitality industry has been deeply impacted by the reduced availability of water supplies we rely on to maintain our properties and ensure the comfortable environment which keeps our guests returning year after year.

Today I encourage the San Diego County Water Authority's Board of Directors to certify the SEIR to ensure that the Claude "Bud" Lewis Carlsbad Desalination Plant continues to meet the highest environmental standards. The Carlsbad plant is the largest seawater desalination plant in the nation and it provides tremendous benefits for our region's water supply reliability. Shortly after commercial operations began in December 2015, the State Water Resources Control Board certified supplies from the plant as drought-resilient, reducing the impacts of the state conservation mandates on our region. In addition, the Carlsbad plant represents a strategic long-term asset for our region's 3.2 million residents and \$218 billion economy that should be preserved and protected. Without projects like the Carlsbad desalination plant, we simply will not be able to meet the needs of residents and visitors in the future.

Thank you again for the opportunity to comment. I look forward to the certification of the SEIR and the upgrades at the Carlsbad plant.

Sincerely,

Tim Stripe, Co-President
Grand Pacific Resorts

5900 PASTEUR COURT, SUITE 200 • CARLSBAD, CA 92008 • TELEPHONE 760-438-8500 • www.grandpacificresorts.com

Response to Comment Letter G

Grand Pacific Resorts
Tim Stripe, Co-President
May 4, 2016

G-1

The Grand Pacific Resorts provided statements supporting the CDP and the proposed modifications. No further response is necessary.

G-1

RESPONSES TO COMMENTS

Comment Letter H

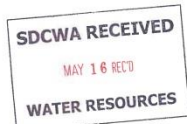

May 10, 2016

Mr. Mark Tegio
Senior Water Resources Specialist
San Diego County Water Authority
4677 Overland Ave.
San Diego, CA 92123

Subject: Comments on Draft Supplement to Precise Development Plan and Desalination Plant Project Final Environmental Impact Report

Dear Mr. Tegio:

Thank you for the opportunity to comment on the Supplement to the Precise Development Plan and Desalination Plant Project Final Environmental Impact Report. San Diego Regional Economic Development Corporation appreciates the careful production of this document and encourages the San Diego County Water Authority's Board of Directors to certify the SEIR to ensure that the Claude "Bud" Lewis Carlsbad Desalination Plant continues to meet the highest environmental standards.

As you know, the Carlsbad plant is the largest seawater desalination plant in the nation and it provides tremendous benefits for our region's water supply reliability. Shortly after commercial operations began in December 2015, the State Water Resources Control Board certified supplies from the plant as drought-resilient, reducing the impacts of the state conservation mandates on our region.

We applaud the investment as the Carlsbad plant represents a strategic long-term asset for our region's 3.2 million residents and \$218 billion economy. The Water Authority and its 24 member agencies should be commended for enhancing water supply reliability and setting a national example for water supply diversification – not only via seawater desalination but also through landmark conservation-and-transfer agreements with the Imperial Valley, potable reuse, groundwater development and water recycling.

530 B Street | 7th Floor
San Diego, CA 92101
p 619 234 8484

sded.org/business.org

H-1

Response to Comment Letter H

San Diego Regional Economic Development Corporation (SDED)

Mark Cafferty, President and CEO

May 10, 2016

H-1

The SDED provided statements supporting the CDP and the proposed modifications. No further response is necessary.

RESPONSES TO COMMENTS

Mr. Mark Tegio

May 10, 2016

Page 2

By enhancing the region's resiliency against drought and ensuring a safe, reliable supply, we can support businesses in the region's key industries as they continue to grow and compete globally. Numerous industry clusters will benefit greatly from this effort, most notably our life sciences sector, which will have access to a water supply supporting its \$14.2 billion direct economic impact and sustaining more than 34,000 jobs per year. A safe and affordable water supply will continue to make the region competitive with regions around the globe and ensure our economic prosperity long into the future.

Thank you again for the opportunity to comment.

Sincerely,



Mark Cafferty
President & CEO

↑
H-1
Cont.

RESPONSES TO COMMENTS

Comment Letter I



Board of Directors

Maureen Simons
Chairman

Ian McDaniel
Vice-chair

Graham Beatty
Treasurer

Kimberly Holmes
Secretary

Aaron Booth

Jim Brubaker

Jim Courtnay

Cameron Durckel

Michael Gazzano

Karen McClune

Becky Moore

Eric Munoz

Rebecca Richards

Sam Ross

Tim Stak

Dee Sodona

Jimmy Ukegawa

Wendy Wiegand

Staff

Lisa Rodman
Chief Executive Officer

Samantha Richter
Director of Education

Claire Russo
Administrative Manager

Morgan Wofford
Trail Development Manager

Mr. Mark Tegio
Senior Water Resources Specialist
San Diego County Water Authority
4677 Overland Ave.
San Diego, CA 92123

May 23, 2016

Subject: Comments on the Draft Supplement to the Precise Development Plan and Desalination Plant Project Final Environmental Impact Report

Dear Mr. Tegio:

Thank you for the opportunity to comment on the Supplement to the Precise Development Plan and Desalination Plant Project Final Environmental Impact Report (SEIR). The Agua Hedionda Lagoon Foundation (AHLF) appreciates the careful production of this document and requests the San Diego County Water Authority's Board of Directors to consider the comments on the draft SEIR to ensure that the Claude "Bud" Lewis Carlsbad Desalination Plant continues to meet the highest environmental standards.

The AHLF was created to promote conservation, restoration and enhancement of the Agua Hedionda Lagoon, marsh, wetlands and watershed area. We strive to protect sensitive land through acquisition or other means and promote balanced recreational and commercial uses that ensure the long-term health and vitality of the lagoon.

As such, the AHLF has carefully reviewed the SEIR for Carlsbad Desalination Project to ensure that it adequately addresses and mitigates for any potential impacts on the lagoon marine life. The proposed upgrades assessed in the SEIR were anticipated in the Water Purchase Agreement approved by the Water Authority Board in November 2012, and I appreciate the foresight by the Water Authority and Poseidon to ensure that the plant can become a stand-alone operation that serves the San Diego region for decades.

Specifically, the incorporation of fish-friendly pumps, upgraded screening technology and a system to safely return fish caught in the intake to the lagoon will further protect marine life. We would like to recommend that the SEIR include an option to route the fish return to the Pacific Ocean via the existing discharge pond onsite.

The Carlsbad plant is the largest seawater desalination plant in the nation and it provides tremendous benefits for our region's water supply reliability and we are pleased to be their neighbor on the Lagoon. With Poseidon's continued stewardship we can ensure that the lagoon will continue to provide a sanctuary for marine life, public access and a safe and reliable water supply.

Thank you again for the opportunity to comment. We look forward to the certification of the SEIR and the upgrades at the Carlsbad plant.

Sincerely,

Lisa Rodman, CEO
Agua Hedionda Lagoon Foundation

A California Non-Profit Corporation #501(C) 33-0411888
1580 Cannon Road, Carlsbad, CA, 92008 760.804.1969 www.aguahedionda.org

I-1
I-2
I-3

Response to Comment Letter I

Agua Hedionda Lagoon Foundation (AHLF)
Lisa Rodman, CEO
Mat 23, 2016

- I-1** The AHLF acknowledges the commenting opportunity and provides a synopsis of the AHLF. No further response is necessary.
- I-2** The AHLF provides a summary of their support for the CDP and specifically the proposed modifications. AHLF also recommends that the SEIR include an option to route the fish return to the Pacific Ocean via the existing discharge pond. The Applicant investigated the feasibility of an option to route the fish return to the Pacific Ocean via the existing discharge pond. The Water Authority has reviewed the Applicant's investigation into the suggested alternative fish return route and discharge location and has determined that there are no significant impacts associated with routing the fish return to the Pacific Ocean via the existing discharge pond. As such the Final SEIR revisions include an evaluation of the discharge pond fish return option as an alternative to the lagoon fish return option, see section 4.2 of the Final SEIR pages 4.2-15 to 4.2-17.
- I-3** The AHLF provided a general statement supporting the CDP. No further response is necessary.

RESPONSES TO COMMENTS

Comment Letter J



May 26, 2016
Mark Tegio
Senior Water Resources Specialist
San Diego County Water Authority
4677 Overland Avenue
San Diego, CA 92123-1233

SUBJECT: NOTICE OF AVAILABILITY OF A DRAFT SUPPLEMENT TO AN ENVIRONMENTAL IMPACT REPORT (EIR) FOR THE PRECISE DEVELOPMENT PLAN AND DESALINATION PLANT PROJECT (SCH #2004041081 AND #2015091060) FOR THE CARLSBAD DESALINATION PLANT RELATED TO FACILITY MODIFICATIONS FOR INTAKE, DISCHARGE AND CAPACITY

Dear Mr. Tegio,

Thank you for notifying the City of Carlsbad in regard to the San Diego County Water Authority's (SDCWA) Notice of Availability of a Supplemental Environmental Impact Report (EIR) for the Desalination Plant. In 2006, the City of Carlsbad, as Lead Agency, certified the Final Environmental Impact Report (FEIR) and issued local approvals for the original project. For the proposed modifications to the Carlsbad Desalination Plant (CDP) and this fifth addendum to the FEIR, the City of Carlsbad is a Responsible Agency under the meaning of the California Environmental Quality Act (CEQA). CEQA Guidelines Section 15381 states that, "for purposes of CEQA, the term "Responsible Agency" includes all public agencies other than the Lead Agency (SDCWA, in this case) which have discretionary approval power over the project."

In 2006, Poseidon Resources received the following permits from the City of Carlsbad to construct and operate the CDP:

- EIR 03-05
- PDP 00-02
- SP 144(H)
- CDP 04-41
- DA 05-01
- RP 05-12
- SUP 05-04
- HMP 05-08

As stated in my letter to Laurence J. Purcell, Water Resource Manager for the SDCWA, dated October 19, 2015, the proposed changes to the Desalination Plant will require amendments to the following permits and agreement:

- Precise Development Plan Permit (PDP 00-02)
- Review Permit (RP 05-12)
- Development Agreement (DA 05-01)

The City of Carlsbad has reviewed the Draft Supplemental EIR and does not have any additional comments or concerns. Please contact me at (760) 602-4644, if you have any questions.

Sincerely,

PAM DREW
Associate Planner

cc: Frank Belock, Deputy General Manager, San Diego County Water Authority, 4677 Overland Avenue, San Diego, CA 92123
Peter MacLaggan, Vice President, Poseidon Water, Suite 340, 5780 Fleet Street, Carlsbad, CA 92008
George Pineda, P.E., Director Environmental Business, M&G West, Suite 200, 5790 Fleet Street, Carlsbad, CA 92008
Scott Dornett, Senior Planner
Dana Enry

File Copy
Community & Economic Development
Planning Division | 1635 Faraday Avenue Carlsbad, CA 92008-7314 | 760-602-4600 | 760-602-8560 | www.carlsbadca.gov

J-1

J-2

Response to Comment Letter J

City of Carlsbad
Pam Drew, Associate Planner
May 26, 2016

J-1

The City of Carlsbad acknowledges the commenting opportunity and that the City of Carlsbad is a Responsible Agency as defined CEQA Guidelines § 15381. The Water Authority concurs and the SEIR identifies the City of Carlsbad as a Responsible Agency and identifies actions the City of Carlsbad is responsible for. No further response is necessary.

J-2

The City of Carlsbad provides a summary of prior permits on the project from the City and identifies the permits from the City of Carlsbad necessary for the proposed modifications, as provided in the comment letter on the NOP. The Water Authority acknowledges the City of Carlsbad's comment and the prior NOP comment letter. In response to this comment the Water Authority has added revised the list of City of Carlsbad actions as provided by the City of Carlsbad comment to restate that Review Permit is the appropriate term for "RP". As the confines of the disturbance areas are within the existing disturbed areas, the Water Authority understands that no new development agreement (or amendment thereto) is necessary. However, if the

RESPONSES TO COMMENTS

City determines an amendment to the development agreement is in fact necessary, that amendment will be addressed as part of the City's permitting process. That an amendment to the development agreement is or is not required does not affect physical environmental changes of the proposed modifications or the analysis and conclusions in the SEIR. See revisions to page 3-47 of the SEIR.

RESPONSES TO COMMENTS

Comment Letter K

STATE OF CALIFORNIA—CALIFORNIA STATE TRANSPORTATION AGENCY
DEPARTMENT OF TRANSPORTATION
DISTRICT 11
PLANNING DIVISION
4050 TAYLOR STREET, M.S. 240
SAN DIEGO, CA 92110
PHONE: (619) 688-4960
FAX: (619) 688-4299
TTY: 711

EDMUND G. BROWN, Jr., Governor



*Serious drought.
Help save water!*

May 25, 2016

11-SD-5
PM 47.98

Carlsbad Desalination Plant Intake and Discharge Facility Modification
SEIR / SCH#2015091060

Mr. Mark Tegio
San Diego County Water Authority
4677 Overland Avenue
San Diego, CA 92123

Dear Mr. Tegio:

The California Department of Transportation (Caltrans) received a copy of the Supplement/Subsequent Environmental Impact Report (SEIR) for the proposed Carlsbad Desalination Plant Intake and Discharge Facility Modifications Project located near I-5.

Caltrans has the following comments:

- Any work performed within Caltrans Right-of-Way (R/W) will require discretionary review and approval by Caltrans and an encroachment permit will be required for any work within the Caltrans R/W prior to construction. As part of the encroachment permit process, the applicant must provide an approved final environmental document including the California Environmental Quality Act (CEQA) determination addressing any environmental impacts with the Caltrans' R/W, and any corresponding technical studies. Please see Section 600 of the Encroachment Permits Manual for requirements regarding utilities and state R/W:
http://www.dot.ca.gov/hq/traffops/developserv/permits/pdfmanual/Chapter_6.pdf
- The I-5 North Coast Corridor (NCC) project is proposed to widen I-5. Please consider this for any future work along the corridor.

K-1

K-2

If you have any questions, please contact Kimberly Dodson, of the Caltrans Development Review Branch, at (619) 688-2510 or by e-mail sent to kimberly.dodson@dot.ca.gov.

Sincerely,

JACOB ARMSTRONG, Chief
Development Review Branch

*"Provide a safe, sustainable, integrated and efficient transportation system
to enhance California's economy and livability."*

Response to Comment Letter K

California Department of Transportations (CALTRANS)
Jacob Armstrong, Chief
May 25, 2016

K-1 CALTRANS identified the conditions under which an encroachment permit may be necessary and the necessary information to provide. The proposed modifications to the CDP do not involve any activities with the CALTRANS right-of-way or access from CALTRANS roadway. No further response is necessary.

K-2 CALTRANS requests that proposed work give consideration of pending widening of the I-5 in the area. The proposed modifications would not interfere with the I-5 widening, but as requested, the Applicant will give consideration to the widening activities during construction. No further response is necessary.

RESPONSES TO COMMENTS

<div data-bbox="247 321 380 393"></div> <div data-bbox="247 407 590 427"><p>San Diego Regional Water Quality Control Board</p></div> <div data-bbox="273 454 365 474"><p>May 27, 2016</p></div> <div data-bbox="606 453 743 474"><p>Sent Via Email Only</p></div> <div data-bbox="273 500 564 581"><p>Mark Tegio, Senior Water Resources Specialist San Diego County Water Authority 4677 Overland Avenue San Diego, CA 92123-1233 E-mail: mtegio@sdcwa.org</p></div> <div data-bbox="606 500 756 534"><p><u>In reply refer to / attn:</u> 640063; bneill</p></div> <div data-bbox="273 592 812 643"><p>Subject: Comments on the Draft Supplement to the Precise Development Plan and Desalination Plant Project Final Environmental Impact Report (EIR 03-05), City of Carlsbad, California, SCH Nos. 2004041081 and 2015091060</p></div> <div data-bbox="273 654 344 673"><p>Mr. Tegio:</p></div> <div data-bbox="273 685 848 828"><p>The California Regional Water Quality Control Board, San Diego Region (San Diego Water Board) and the State Water Resources Control Board (State Water Board) have reviewed the <i>Draft Supplement to the Precise Development Plan and Desalination Plant Project Final Environmental Impact Report (Draft SEIR)</i> dated April 2016. The Draft SEIR evaluates potential environmental impacts due to proposed modifications at the Claude "Bud" Lewis Carlsbad Desalination Plant (CDP) owned by Poseidon Resources (Channelside) LP (Discharger). The proposed modifications include the planned transition from co-located and temporary stand-alone operations with the Encina Power Station (EPS) to permanent stand-alone operations with a potential for increased water production.</p></div> <div data-bbox="273 839 852 1089"><p>The San Diego Water Board is the agency responsible for issuing the National Pollutant Discharge Elimination System (NPDES) permit for the discharge of brine and other wastes from the CDP to the Pacific Ocean and for making a determination regarding the factors set forth in California Water Code (CWC) section 13142.5, subdivision (b) (CWC section 13142.5(b))¹, for the CDP. The NPDES permit will implement the provisions of the <i>Water Quality Control Plan for Ocean Waters of California</i>, including the <i>Amendment to the Water Quality Control Plan for Ocean Waters of California Addressing Desalination Facility Intakes, Brine Discharges, and the Incorporation of Other Nonsubstantive Changes (Desalination Amendment)</i>. In developing the CWC section 13142.5(b) determination and the NPDES permit for the CDP, the San Diego Water Board, in consultation with the State Water Board, will rely on documents that the Discharger submitted with the Report of Waste Discharge (ROWD), information contained in the Final EIR as supplemented, and other available information. The San Diego Water Board may request that the Discharger submit additional information that is necessary for the CWC section 13142.5(b) determination or for the NPDES permit issuance. Although issuance of an NPDES permit is exempt from California Environmental Quality Act (CEQA) compliance pursuant to CWC section 13389, a CWC section 13142.5(b) determination is a discretionary approval.</p></div> <div data-bbox="273 1099 833 1144"><p>¹ CWC section 13142.5(b) requires each new or expanded coastal powerplant or other industrial installation using seawater for cooling, heating, or industrial processing, to use the best available site, design, technology, and mitigation measures feasible to minimize the intake and mortality of all forms of marine life.</p></div> <div data-bbox="399 1174 749 1221"><p>HENRY ASHBAH, Ph.D., Chair DAVID GIBSON, EXECUTIVE OFFICER 2375 Northside Drive, Suite 100, San Diego, California 92108-2708 www.waterboards.ca.gov/sandiego recycling news</p></div> <div data-bbox="787 293 926 313"><p>Comment Letter L</p></div> <div data-bbox="749 323 877 389"> </div>	<div data-bbox="1197 232 1766 274"><h2>Response to Comment Letter L</h2></div> <div data-bbox="1215 308 1749 514"><h3>San Diego Regional Water Quality Control Board (RWQCB) James G. Smith, AEO for David Gibson, Executive Officer May 27, 2016</h3></div> <div data-bbox="1054 552 1113 584"><p>L-1</p></div> <div data-bbox="1190 552 1925 963"><p>The RWQCB provides context and status of their ongoing permitting process for the CDP and the proposed modifications as well as their role as a responsible agency for the purposes of CEQA. The Water Authority appreciates the status update and concurs with the RWQCB responsible agency assertion, as identified in the SEIR, page 2-1. Additional materials are provided herein as responses to comments to support the RWQCB review as well as in direct response to comments.</p></div>
---	--

RESPONSES TO COMMENTS

Mr. Mark Tegio
San Diego County Water Authority

- 2 -

May 27, 2016

subject to CEQA compliance. The San Diego Water Board is a responsible agency for purposes of complying with CEQA for a CWC section 13142.5(b) determination requested by the Discharger.

The San Diego Water Board and the State Water Board offer the following comments on sections 1, 2, 3, 4.2, 4.4, 5.1, 5.2.2, and 5.2.4 of the Draft SEIR. The remaining sections were not reviewed.

Brine Mixing Zone and Flow Augmentation

1. In section 2.3, page 2.5, the Draft SEIR indicates that the outfall location is the effluent tunnel discharge point. This is inconsistent with the ROWD, as amended in September 2015, which indicates that the outfall location is the EPS surface discharge channel. The Draft SEIR should be amended to clarify the outfall location.

2. The Draft SEIR presumes (e.g. see Page 4.4-6) that the brine mixing zone (BMZ) for the CDP will be approximately 200 meters from the discharge point. However, the Desalination Amendment definition of the BMZ provides that a standard BMZ shall not exceed 100 meters laterally from each discharge point and throughout the water column. For the owner or operator of a facility that has received a conditional CWC section 13142.5(b) determination, was over 80 percent constructed by January 28, 2016, and proposes flow augmentation (additional intake of water for brine dilution) using a surface water intake, the Desalination Amendment provides the option for the Discharger to submit a proposal to the San Diego Water Board for approval of an alternative BMZ. The alternative BMZ shall not exceed 200 meters laterally from the discharge point and throughout the water column. This option is contingent upon the Discharger demonstrating and the San Diego Water Board approving in an NPDES permit, that the combination of the alternative BMZ and flow augmentation provides a level of intake and mortality of all forms of marine life that is comparable to the combination of the standard BMZ and wastewater dilution, if wastewater is available, or multiport diffusers, if wastewater is unavailable. The Desalination Amendment specifies that in no case may the discharge result in hypoxic conditions outside of the alternative BMZ.

The Discharger has submitted a request to the San Diego Water Board for approval of flow augmentation using a surface water intake and an alternative BMZ of 200 meters from the discharge point. The San Diego Water Board, in consultation with the State Water Board, is reviewing this request as part of the CWC section 13142.5(b) determination. As such, the Draft SEIR should be amended to evaluate whether the discharge would result in hypoxic conditions outside of the requested alternative BMZ. Additionally, the Draft SEIR should be amended to evaluate alternatives to flow augmentation and a BMZ greater than 100 meters that may have reduced environmental impacts. These alternatives should include withdrawing less seawater for flow augmentation, a BMZ less than 200 meters from the discharge point, diluting brine using multiport diffusers, and commingling brine with municipal wastewater prior to discharge.

3. In section 4.2, page 4.2-12, the Draft SEIR states that the proposed CDP modifications satisfy the Desalination Amendment's requirements for brine discharge using flow augmentation. In a meeting on April 12, 2016, San Diego Water Board staff verbally requested that the Discharger consult with the Encina Wastewater Authority about the possibility of diverting some of the effluent from the CDP to the Encina Ocean Outfall. The Draft SEIR should be amended to evaluate this alternative discharge option of commingling CDP's brine with wastewater.

L-1
Cont.

L-2

L-3

L-4

L-2

The RWQCB requests clarification with regards to references to the outfall location. In response to this comment the second bullet on page 2-5 of the SEIR has been revised to clarify the outfall location.

L-3

The RWQCB requests that the SEIR clarify that the brine mixing zone (BMZ) established in the Desalination Amendment is 100 meters and that the applicant has submitted to the RWQCB a request for the approval of flow augmentation and alternative BMZ of 200 meters. Further the comment requests that the SEIR be revised to include an analysis of whether hypoxic conditions outside of the alternative BMZ, and alternatives, including a reduced BMZ, reduced seawater withdrawal, dilution using multiport diffusers, and comingling with municipal wastewater. In response to this comment page 4.4-6 of the SEIR has been revised to clarify that the 200 meter BMZ is an alternative that the applicant has submitted to the RWQCB for approval.

The following is provided that further clarify how the alternative is consistent with the Ocean Plan (Desalination) Amendment, as follows:

The 200-meter brine mixing zone is consistent with the Ocean Plan Amendment as a facility-specific alternative receiving water salinity limitation. Chapter III.M.3.d provides that a facility which has received a conditional

RESPONSES TO COMMENTS

Mr. Mark Tegio
San Diego County Water Authority

- 3 -

May 27, 2016

Fish Return System

4. In section 3.4, page 3-15, the Draft SEIR states that the fish return pipe will have two cleanouts to facilitate cleaning and inspection. The Draft SEIR should be amended to describe the methods that will be used to clean the fish return pipe and the discharge pipe following the permanent cessation of operations at the EPS. Depending on the cleaning methods or agents selected, pollutants may be added to the CDP discharge, possibly resulting in additional environmental impacts. The Draft SEIR should be amended to evaluate the possible environmental impacts associated with discharge to surface waters of cleaning-in-place liquids, solvents, antiscalants, debris from cleaning, and biofouling and antifouling agents.

L-5

Construction Schedule

5. In section 3.4, page 3-30, the Draft SEIR identifies a schedule of approximately 18 months for the construction of intake and discharge modifications. Because this schedule will extend beyond the planned permanent cessation of operations at the EPS, which is currently scheduled for December 31, 2017, the Draft SEIR should be amended to describe CDP operations during the interim period when EPS is permanently shut down and prior to the new intake structure being constructed and operated.

L-6

Intake Structure Modifications

6. In section 4.2, page 4.2-5, there is a description of the proposed CDP modifications to the EPS intake structure, which consist of center-flow traveling water screens with 1 mm mesh, axial flow pumps, and a fish return system. Entrapment of marine life may occur in the intake tunnel, if organisms pass through the trash racks at the onset of the tunnel but cannot swim back through them. The Draft SEIR should be amended to evaluate alternative options, such as wedgewire screens, installation of traveling screens at the onset of intake, and an offshore intake structure, that were considered for modifications to the EPS intake structure and that may result in fewer impacts on marine life.

L-7

Alternative Receiving Water Limitation

7. In section 4.2, page 4.2-12, the Draft SEIR states that the chronic toxicity test results suggest that the CDP qualifies for a facility-specific alternative receiving water salinity limitation as provided in section III.M.3.c. of the Desalination Amendment. As part of the ROWD and the request for a CWC section 13142.5(b) determination for stand-alone operations of the CDP, the Discharger has requested guidance from the San Diego Water Board to identify future research, studies, and monitoring required to evaluate and identify a facility-specific alternative receiving water salinity limitation. The San Diego Water Board, in consultation with the State Water Board, is in the process of reviewing the Discharger's request and has yet to make a decision about whether an alternative receiving water salinity limitation for the CDP is appropriate. The Draft SEIR should be amended to more accurately describe the current status of the alternative receiving water limitation request and must also evaluate the scenario under which the San Diego Water Board does not approve an alternative receiving water salinity limitation.

L-8

Mitigation

8. In section 4.2, page 4.2-15, the Draft SEIR states that the San Diego Water Board found that the proposed measures for the CDP in the March 27, 2009 *Flow, Entrapment, and Impingement Minimization Plan* (Minimization Plan) are the best available CWC section

L-9

Water Code section §13142.5(b) determination and is over 80 percent constructed by the effective date of the Desalination Amendments, shall not exceed a daily maximum of 2.0 parts per thousand (ppt) above natural background salinity measured at the edge of the brine mixing zone 200 meters (656 ft.) away from the points of discharge. The owner or operator of such a facility must demonstrate, in accordance with chapter III.M.2.d.(2)(c), that the individual and cumulative effects of a combination of the alternative brine mixing zone and flow augmentation using a surface water intake provide a comparable level of intake and mortality of all forms of marine life as the combination of the standard brine mixing zone and wastewater dilution if wastewater is available, or multiport diffusers if wastewater is unavailable; and in no case may the discharge result in hypoxic conditions outside of the alternative brine mixing zone.

The RWQCB conducted and approved a conditional Water Code section §13142.5(b) determination in 2009 (Order R9-2009-0038) and the CDP is constructed and fully operational. The proposed modifications would continue to rely on flow augmentation using a surface water intake. The Submittal to the RWQCB includes a request that the Regional Water Board, in consultation with the State Water Board staff, approve of an alternative brine mixing zone not to exceed 200 meters

RESPONSES TO COMMENTS

Mr. Mark Tegio
San Diego County Water Authority

- 4 -

May 27, 2016

13142.5(b) mitigation feasible for the CDP. The Draft SEIR presumes that the San Diego Water Board will accept out-of-kind mitigation and a mitigation ratio of one to ten² for purposes of the requested CWC section 13142.5(b) determination. The Draft SEIR also states that no additional marine biological resources mitigation measures beyond those required by the Final Environmental Impact Report are necessary. For clarification, in Order No. R9-2009-0038, the San Diego Water Board found that the Minimization Plan will ensure that the CDP is in compliance with CWC section 13142.5(b) under *co-located and temporary shutdown* operations of EPS (emphasis added) only and that it will be necessary to evaluate compliance with CWC section 13142.5(b) for stand-alone operations if the EPS permanently ceases operations. The San Diego Water Board, in consultation with the State Water Board, is in the process of reviewing the Discharger's request for a CWC section 13142.5(b) determination for stand-alone operations of CDP, including evaluating compliance with the mitigation requirements contained in the Desalination Amendment. The San Diego Water Board has yet to make a decision regarding whether the proposed measures in the Minimization Plan constitute the best available mitigation for stand-alone operations of the CDP. The Draft SEIR should be amended to more accurately discuss the current situation with regards to mitigation.

↑
L-9
Cont.

9. In section 4.2, page 4.2-15, the Draft SEIR re-states section III.M.2.e(7) of the Desalination Amendment, which provides the San Diego Water Board with the discretion, when making a new CWC section 13142.5(b) determination, to account for previously-approved mitigation projects and to require additional mitigation for any additional mortality of marine life. The Draft SEIR should be amended to more accurately discuss the current situation with regards to mitigation considering 1) that the San Diego Water Board has yet to make a decision regarding these provisions and 2) that section III.M.2.e(7) of the Desalination Amendment does not obviate compliance with other mitigation requirements within section III.M.2.e of the Desalination Amendment. The San Diego Water Board will determine the appropriate mitigation requirements to compensate for the intake and mortality of all forms of marine life associated with the construction and operation of the long-term stand-alone facility when it makes the CWC section 13142.5(b) determination. As part of this process, the San Diego Water Board will assess whether to account for previously-approved mitigation as part of the mitigation for stand-alone operations of CDP. The Draft SEIR should be amended to address the possibility that previously approved mitigation will not be credited toward stand-alone operations of CDP.

↑
L-10

Groundwater Dewatering

10. In section 4.4.3, page 4.4-3, the Draft SEIR states that the construction of the proposed modifications will require groundwater extracted through dewatering to be discharged to the brine discharge structure. The Draft SEIR should be amended to explain and evaluate the impacts of the decision to discharge the groundwater to the brine discharge structure rather than to the intake system to supplement the CDP's process water requirements. The Draft SEIR should also be amended to examine whether the groundwater dewatering wells for construction may be put into permanent use after completion of construction to provide supplemental water for the CDP's process water requirements.

↑
L-11

² Section III.M.2.e.(3)(b)(vi) of the Desalination Amendment requires a mitigation ratio of no less than one acre of mitigation habitat for every ten acres of impacted open water or soft-bottom habitat.

(656 ft.) laterally from the discharge point and throughout the water column. Analysis provided as Appendix CC to the Submittal to the RWQCB demonstrated in accordance with chapter III.M.2.d.(2)(c), that wastewater dilution is not available. The Encina Wastewater Authority (EWA) confirmed that outfall capacity is unavailable because the Encina Water Pollution Control Facility requires the entire capacity of the outfall to discharge the peak flows during storm events up to two weeks out of the year. Therefore, the EWA outfall does not provide an opportunity to eliminate, or reduce the capacity of the proposed intake/discharge modifications. Analysis provided as Appendix B and Appendix K to the Submittal to the RWQCB demonstrated that the combination of the alternative brine mixing zone and flow augmentation using a surface water intake would result in a lower level of intake and mortality of all forms of marine life as the combination of the standard brine mixing zone with a multiport diffuser. The analysis provided as Appendix DD to the Submittal to the RWQCB demonstrated that the proposed discharge would not result in hypoxic conditions outside of the alternative brine mixing zone.

RESPONSES TO COMMENTS

Mr. Mark Tegio
San Diego County Water Authority

- 5 -

May 27, 2016

Low Impact Development

11. The Draft SEIR should be amended to address Low Impact Development (LID) requirements, as required by 1) section II.E.3 of San Diego Water Board Order No. R9-2013-0001, *National Pollutant Discharge Elimination System Permit and Waste Discharge Requirements for Discharges from the Municipal Separate Storm Sewer Systems Draining the Watersheds within the San Diego Region* (Order No. R9-2013-0001), as amended; and 2) the City of Carlsbad's *BMP Design Manual*. Where conflict exists between the two referenced documents the most stringent requirements shall apply. The proposed modifications to the CDP provide an opportunity to examine retrofitting or otherwise implement LID principles that would minimize storm water pollution impacts to the receiving waters. Section II.E.3.a(3) of Order No. R9-2013-0001, as amended, contains minimum LID measures that all development projects must implement.

L-12

For questions or concerns, please contact Ben Neill with the San Diego Water Board at (619) 521-3376, Ben.Neill@waterboards.ca.gov, or Kim Tenggardjaja with the State Water Board at (916) 341-5473, Kimberly.Tenggardjaja@Waterboards.ca.gov. In the subject line of any response, please include the reference "640063: bneill".

Respectfully,

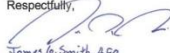

David Gibson
Executive Officer

DWG:jgs:dib:bno:bin

cc by email:

Peter MacLaggan, Poseidon Resources (Channelside), PMacLaggan@poseidon1.com
Kim Tenggardjaja, State Water Board, Kimberly.Tenggardjaja@Waterboards.ca.gov
Claire Waggoner, State Water Board, Claire.Waggoner@waterboards.ca.gov
Tom Luster, California Coastal Commission, Tom.Luster@coastal.ca.gov
Jamie Marincola, USEPA, Marincola.Jamespaul@epamail.epa.gov
Elaine Lukoy, City of Carlsbad, Elaine.Lukev@carlsbadca.gov

Tech Staff Info & Use	
Order No.	R9-2006-0065
Party ID	522151
WDID	9 000001429
NPDES No.	CA0109223
Reg. Measure ID	308381
Place ID	640063
Person ID	339921

The proposed brine mixing zone would be contained to 15.5-acre semicircular area extending 200 meters (656 ft.) from the end of the discharge channel. For comparison purposes, the area in which the brine mixing zone for the multiport diffuser considered in the Feasibility Study consisted of four duck-bill diffuser ports located 100 feet apart would eject the brine into the water column at a high velocity to promote rapid diffusion and dispersion. The Brine Mixing Zone would extend 100 meters (328 ft.) out from each of the four discharge points with the combined area inside the brine mixing zone covering 14.4 acres. Therefore, the size of the brine mixing zone associated with the screened intake combined with flow augmentation is slightly larger (7.6%) than the brine mixing zone for a screened intake combined with a multiport diffuser.

As part of the permitting process with RWQCB the Applicant has prepared a Feasibility Study and Addendum to the Feasibility Study (Appendix B and Appendix II to the Submittal to the RWQCB) that assessed the combined effects of each of these technologies on all forms of marine life as required by California Water Code Section §13142.5(b). The conclusion of that assessment was that the screened intake combined with flow augmentation would result in lower mortality to all forms of marine life than the

RESPONSES TO COMMENTS

	<p>screened intake combined with a multiport diffuser. The total area impacted by these technologies was found to be 99.5 acres for the screened intake combined with flow augmentation versus 118.4 acres with the screened intake combined with the multiport diffuser.</p> <p>Based on the results of the revised hydrodynamic discharge modeling study (Appendix BB to the Submittal to the RWQCB), a brine mixing zone of less than 200 meters would not be able to achieve compliance with the Ocean Plan receiving water salinity limitation of 2.0 ppt above natural background salinity at the edge of brine mixing zone during the worst case month without increasing the quantity of seawater used for flow augmentation or relaxing the receiving water salinity limitation.</p> <p>The Applicant has requested guidance from the RWQCB regarding the applicability of a facility-specific alternative receiving water salinity limitation in accordance with section §III.M.3.c. of the Ocean Plan. The Applicant conducted chronic toxicity testing to determine whether a facility-specific alternative receiving water limitation is adequately protective of beneficial uses. The chronic toxicity testing (Salinity Tolerance Interim Report Chronic Test Results included as Appendix H to the Submittal to the RWQCB) found that the lowest observed effect concentration (LOEC) for</p>
--	---

RESPONSES TO COMMENTS

the most sensitive species, red abalone, is 36.5 ppt. The RWQCB is reviewing the Applicant's request and has yet to make a decision about whether an alternative receiving water salinity limitation for the CDP is appropriate. Absent a determination by the RWQCB that an alternative receiving water salinity limitation for the CDP is appropriate, the SEIR assumes project operations in conformance with a daily maximum salinity requirement of 2.0 ppt above natural background salinity measured at the edge of a brine mixing zone 200 meters (656 ft.) away from the points of discharge.

The Water Authority has reviewed the alternative receiving water salinity limitation (200 meter BMZ) and believes that the proposed 200 meter BMZ is the least impactful technology noting that the combined effects of multiport diffuser on all forms of marine life are greater than that associated with flow augmentation (118.4 acres vs. 99.5) and that the proposed technology is consistent with the Ocean Plan (Desalination) Amendment, and prepared the SEIR accordingly. The RWQCB has an independent permitting responsibility as stated by the RWQCB, and can exercise judgement of the materials as part of their review and permitting process.

The analysis confirming the discharge would not result in hypoxic conditions outside the 200 meter BMZ has

RESPONSES TO COMMENTS

been conducted and included in the Analysis of Hypoxic Conditions Outside the BMZ provided as Appendix DD to the Submittal to the RWQCB, which is incorporated by reference in the SEIR. The SEIR incorporates by reference the entire submittal package submitted to the RWQCB including a Feasibility Study provided as Appendix B and the Addendum to the Feasibility Study provided in Appendix II in that package, which evaluates the alternative technologies and design for intake and discharge. The alternatives to the design and technologies for the intake and discharges are not 'project alternatives' for CEQA purposes as they represent components of the proposed project as described in the FEIR, rather than alternatives to the CDP, and the proposed modifications do not result in any significant impacts that any suggested alternate design or technological approach might reduce. The SEIR does not, and is not required to (see SEIR §2.1), include analysis of project alternatives as the modifications are responses to a foreseen condition of the proposed project (EPS closure) rather than selection of an alternative to the CDP identified in the FEIR or a new alternative. The Water Authority has reviewed the Feasibility Study and Addendum and concurs with the conclusions and findings supporting the proposed intake and discharge modifications, and prepared the SEIR accordingly. The RWQCB has an independent permitting

RESPONSES TO COMMENTS

responsibility as stated by the RWQCB, and can exercise judgement of the materials as part of their review and permitting process.

The opportunity for co-mingling with municipal wastewater was not expressly considered in the SEIR or any of the materials incorporated by reference therein. Alternatives analysis is not required in an SEIR, and as no significant impacts are identified in the SEIR or FEIR that would be avoided or reduced by the suggested alternate design or technologies for the proposed modifications, there is no rationale to include such an evaluation in the SEIR. However, as part of the permitting process with RWQCB the Applicant has prepared a supplement to the Feasibility Study (Appendix B to the submittal to the RWQCB) that addresses the feasibility of the suggested technologies. The assessment of the opportunity for co-mingling with municipal wastewater is included in Appendix CC to the Submittal to the RWQCB, which is incorporated by reference in the SEIR. The Water Authority has reviewed Appendix CC and concurs that the opportunity for co-mingling with municipal wastewater does not reduce or eliminate the need for the proposed intake and discharge modifications, and finds that the conclusions in the SEIR are unchanged. The RWQCB has an independent permitting responsibility as stated by the RWQCB, and can

RESPONSES TO COMMENTS

	<p>exercise judgement of the materials as part of their review and permitting process.</p> <p>L-4 The RWQCB requested that the EWA be consulted to determine the feasibility of comingling the discharge from the CDP by delivering a portion of the discharge to the Encina Water Pollution Control Facility and discharge to the ocean via the Encina Ocean Outfall. As part of the permitting process with RWQCB the Applicant is preparing an assessment of the opportunity for co-mingling with municipal wastewater, summary information from that study is provided in Section 3-1 of the SEIR.</p> <p>The SEIR incorporates by reference the entire submittal package submitted to the RWQCB including EWA's analysis of the available capacity in the Encina Ocean Outfall provided as Appendix CC. The Water Authority has reviewed Appendix CC and concurs that the opportunity for co-mingling with municipal wastewater does not reduce or eliminate the need for the proposed intake and discharge modifications, and finds that the conclusions in the SEIR are unchanged. Since the opportunity for co-mingling with municipal wastewater does not reduce or eliminate the need for the modifications, it will not be considered any further in the SEIR. The RWQCB has an independent permitting responsibility as stated by the RWQCB,</p>
--	---

RESPONSES TO COMMENTS

	<p>and can exercise judgement of the materials as part of their review and permitting process.</p> <p>L-5 The RWQCB asks for clarification in the project description for what cleaning of the fish return would involve and indicates that additional analysis may be warranted depending on the method identified. In response to this comment, the text on page 3-28 of the SEIR has been revised.</p> <p>The clarified method for cleaning is consistent with that described on page 3-41 of the SEIR for cleaning traveling screens and the debris that would be accumulated over time sourced from the Agua Hedionda Lagoon. The fish return pipe will be designed to minimize marine growth. As such the cleaning would not introduce any foreign agents that could result in possible impacts from discharge (return) to the Agua Hedionda Lagoon or the EPS discharge pond and no further analysis is necessary.</p> <p>L-6 The RWQCB requests clarification of CDP operations during the period when the EPS is closed and construction of the proposed modifications is underway. The SEIR provides supplemental analysis of the proposed modifications and the operations of the CDP during interim closure of the EPS while the modifications are under construction would be consistent with the periodic non-operation of EPS</p>
--	--

RESPONSES TO COMMENTS

	<p>included in the FEIR. In response to this comment, the text on page 3-21, 3-22, and 4.4-5 of the SEIR has been revised.</p> <p>L-7a The RWQCB identified a concern that marine life may be trapped in the intake tunnel by passing through the trash racks but being unable to swim back out through the trash racks or get through the traveling screens, and that an alternative intake should be evaluated. The SEIR (pages 3-27, 3-28, and 4.2-6) describes that under such circumstances the traveling screens include fish lifting buckets that would gather such marine life and transfer them to the fish return system for return to the lagoon. Section 4.2 of the SEIR, pages 4.2-5 through 4.2-7 have been revised to include the analysis of potential effects related to entrapment.</p> <p>L-7b The RWQCB recommended that the SEIR be amended to evaluate the marine life impacts of alternative intake options such as wedgewire screens, installation of traveling screens located at the edge of the lagoon, and an offshore intake structure. The SEIR incorporates by reference the entire submittal package submitted to the RWQCB including 2015 Intake/Discharge Feasibility Report provided as Appendix B and the 2016 Addendum to the Feasibility Report provided as Appendix II. Together, these reports provide a comprehensive assessment of marine life impacts and other feasibility criteria for 10 different combinations of intake and</p>
--	---

RESPONSES TO COMMENTS

	<p>discharge technologies (including the technologies recommended by the RWQCB). The summary of the findings from the Feasibility Report is provided in Section 3.1 of the SEIR.</p> <p>L-8 The RWQCB requests that the SEIR clarify that the studies provided to the RWQCB and incorporated by reference in the SEIR supporting qualification for the alternative receiving water salinity limitation under §III.M.3.c of the Ocean Plan (Desalination) Amendment are under review and the status should be more accurately reflected in the SEIR. In addition, the RWQCB suggests that the SEIR evaluate the scenario whereby approval is not granted for the alternative receiving water salinity limitation. In response to this comment and comment L-3, section 4.4.3 of the SEIR has been revised to clarify that the Applicant has requested guidance from the RWQCB regarding the applicability of a facility-specific alternative receiving water salinity limitation in accordance with §III.M.3.c. of the Ocean Plan. Pending receipt of such guidance, the SEIR provides an evaluation of project operations in conformance with a daily maximum salinity requirement of 2.0 ppt above natural background salinity measured at the edge of a brine mixing zone 200 meters (656 ft.) away from the points of discharge.</p> <p>Revisions to section 4.4.3 of the SEIR have also</p>
--	--

RESPONSES TO COMMENTS

	<p>been provided that further clarify that the RWQCB is currently reviewing the Applicant's request for guidance regarding facility-specific alternative receiving water salinity limitation, and that absent a determination by the RWQCB that an alternative receiving water salinity limitation for the CDP is appropriate, the SEIR assumes project operations in conformance with a daily maximum salinity requirement of 2.0 ppt above natural background salinity measured at the edge of a brine mixing zone 200 meters (656 ft.) away from the points of discharge.</p> <p>L-9 The RWQCB requests that the SEIR clarify that the mitigation for marine biological resources identified in the FEIR is under review by the RWQCB for application to the permanent standalone operation of the CDP. The SEIR identifies that there are no significant impacts to marine biological resources, consistent with the findings of the FEIR. The mitigation required by the RWQCB is for the co-located and temporary stand-alone CDP operations and by the California Coastal Commission (CCC) for permanent stand-alone operations have been voluntarily increased by the Applicant and were agreed to by the RWQCB and CCC for an operational condition resulting in greater impacts than would occur with implementation of the proposed modifications. In response to this comment, section 4.2.4 of the SEIR has been revised.</p>
--	---

RESPONSES TO COMMENTS

	<p>L-10 The RWQCB requests that the SEIR clarify that the mitigation for marine biological resources identified in the FEIR is under review by the RWQCB and that consideration of any additional impacts would require additional mitigation. The SEIR identifies that there are no significant impacts to marine biological resources, consistent with the findings of the FEIR. The mitigation plan approved by the CCC was designed to fully compensate for permanent stand-alone operations. The proposed mitigation for stand-alone operations is based on the expected mortality without the intake and discharge improvements. The proposed modifications to the intake are expected to result in a reduction in impingement and entrainment mortality of marine life. For example, the mitigation plan includes 11 acres of marine habitat restoration specifically for impingement impacts that are not expected to occur with implementation of the proposed modifications. The RWQCB approval of the mitigation plan approved by the CCC mitigate for co-located and temporary stand-alone operations pursuant to its 2009 California Water Code §13142.5(b) determination for the CDP. The RWQCB’s prior approval of the mitigation plan does not extend to stand-alone operations. The RWQCB has an independent permitting responsibility, and can exercise independent judgement of adequacy of the mitigation plan as part of its §13142.5(b) determination for the stand-alone operation of the CDP.</p>
--	--

RESPONSES TO COMMENTS

	<p>L-11 The RWQCB identifies that consideration and explanation be provided as to why the extracted groundwater during construction dewatering is to be discharged through the brine discharge rather than to supplement the CDP intake. The New Screening/Fish-friendly Pumping Structure and appurtenances would require dewatering throughout construction. Existing water systems such as the CDP that propose to add a source of supply are required to submit a permit application to the State Water Board Division of Drinking Water (DDW) (California Health and Safety Code §116525, e. seq.). As part of the permitting process for the intake/discharge modifications, the Applicant will submit an application to the State Water Board Division of Drinking Water (DDW) pursuant to California Health and Safety Code §116525, e. seq. (Drinking Water Source Water Assessment and Protection Program (DWSAP Program)) for consideration of use of the groundwater extracted during construction as a supplemental source water for the CDP. To the extent that DDW approves the application, the Applicant will supplement the source water to the CDP with the extracted groundwater. If the application is not approved by DDW, the Applicant will discharge the groundwater extracted during construction to the brine discharge vault in conformance with the Ocean Plan</p>
--	--

RESPONSES TO COMMENTS

	<p>requirements and the applicable discharge permit requirements. No significant impacts are identified in the SEIR or FEIR that would be avoided or reduced by the use of the groundwater extracted during construction as a supplemental source water for the CDP rather than the discharge of the extracted groundwater to the brine discharge vault when compared to that for the proposed modifications. There is no rationale to include such an evaluation in the SEIR.</p> <p>L-12 The RWQCB identifies that the SEIR be amended to address low impact development (LID) as required by the NPDES and Carlsbad BMP Design Manual. The SEIR notes that FEIR Mitigation Measure 4.7-1 requires adherence to National Pollution Discharge Elimination System (NPDES) permit requirements and implementation of BMPs is applicable to the proposed modifications. The NPDES and requirements from the City of Carlsbad in effect at the time of grading permit issuance will be implemented including the application of LID.</p>
--	--

RESPONSES TO COMMENTS

Comment Letter M

STATE OF CALIFORNIA—NATURAL RESOURCES AGENCY
EDMUND G. BROWN, JR., GOVERNOR
CALIFORNIA COASTAL COMMISSION
45 FREMONT, SUITE 2000
SAN FRANCISCO, CA 94105-2219
VOICE (415) 904-2300
FAX (415) 904-2400
TDD (415) 995-9885

May 27, 2016

Mark Tegio, Senior Water Resources Specialist
San Diego County Water Authority
4677 Overland Avenue
San Diego, CA 92123-1233

VIA EMAIL: mtegio@sdewa.org

RE: Comments on Draft Supplemental Environmental Impact Report ("SEIR") on proposed modifications to Poseidon Carlsbad Desalination Facility (SCH #2015091060)

Dear Mr. Tegio:

Thank you for the opportunity to comment on the above-referenced document. The proposed modifications will require a new or amended coastal development permit ("CDP") and federal consistency review from the Coastal Commission and will be subject to the state's 2015 Ocean Plan Amendment ("Amendment") related to desalination facilities. The Amendment requires that the State and Regional Water Boards and the Coastal Commission conduct formal consultation to determine whether key components of the proposed expansion – including its siting and design, intake method, discharge configuration, mitigation measures, and other project elements – are consistent with relevant provisions of the Amendment. We have provided below some specific but limited initial questions and comments on the Draft SEIR, but will likely have more detailed questions during the formal consultation process.

1) **General – Coordinated Environmental Review and Permitting:** We recommend the Water Authority coordinate with Commission and Board staff during the above-referenced consultation to ensure that the Final SEIR can incorporate at least a preliminary determination of project conformity to the Amendment. Alternatively, the Water Authority should consider including in the SEIR evaluations a wider range of reasonable alternative outcomes of that determination – for example, the determination may conclude that the project will require a different intake screening system or discharge configuration than those currently evaluated in the document. We have provided some examples of these alternative options and recommended additional evaluations below.

2) **SEIR Section 4.2 – Biological Resources:**

a) **Effects on marine life:** The SEIR mentions (at pages 4.2-7 and 4.2-15) that the proposed project modifications are likely to result in something less than the 100% mortality rate for entrained organisms that served as the basis of previous Commission and Board

M-1

M-2

M-3

Response to Comment Letter M

California Coastal Commission (CCC)

Tom Luster

May 27, 2016

M-1

The CCC asserts their role as a responsible agency for the purposes of CEQA and a formal consultation role for permitting purposes similar to the RWQCB. The Water Authority appreciates the status update and concurs with the CCC responsible agency assertion, as identified in the SEIR, page 2-1. The Water Authority has prepared the SEIR pursuant to CEQA and in support of the decision(s) the Water Authority must consider for the proposed modifications. The CCC has an independent permitting responsibility as stated by the CCC, and can exercise judgement of the materials as part of their review and permitting process. No further response is necessary.

M-2

The CCC identifies that the RWQCB and CCC consultation be coordinated with the preparation of the Final SEIR to incorporate preliminary determinations or broadening the SEIR to include evaluation of a range of alternatives. The Water Authority understands that the RWQCB requires that a certified CEQA document be completed prior to any determinations by the RWQCB and as such the SEIR will be completed without determinations from the

RESPONSES TO COMMENTS

Comments on Draft SEIR (SCH #2015091060) – Poseidon Carlsbad Desalination Facility
May 27, 2016

determinations and mitigation requirements. For several reasons, however, we recommend the SEIR continue to use the 100% entrainment mortality rate as the basis for its analyses. For example, the entrained organisms would experience many of the same or similar effects in the modified facility as in the existing facility and would additionally be subject to different or unquantified new effects that could result from cleaning the screens and the proposed fish return system, as-of-yet undetermined changes to the discharge, or others. Although the Amendment allows for a project owner to demonstrate that a facility results in something less than a 100% entrainment mortality rate, that burden of proof has not yet been met and the SEIR's impact assessment should therefore be based on the 100% rate.

M-3
Cont.

b) **Intake-related measures:** As noted above, the consultation conducted pursuant to the Amendment will determine whether the proposed intake and other project modifications conform to relevant Amendment provisions. In the interim, however, we recommend the SEIR evaluate additional alternatives that could reduce intake-related impacts. For example, Section 3 of the SEIR notes that some elements of project construction will require dewatering, so we recommend the SEIR evaluate whether using some or all of these dewatering wells during project operations could reduce the source water drawn in through the proposed screened open water intake and thereby reduce project entrainment.

M-4

c) **Discharge-related measures:** The document describes the project's expected salinity levels within a 200-meter brine mixing zone ("BMZ") and cites a provision of the above-referenced Ocean Plan Amendment as the basis of that 200-meter BMZ. However, the Amendment generally allows for no more than a 100-meter BMZ and provides for the described 200-meter BMZ only upon Board approval of an alternative proposal. We recommend the SEIR evaluate what measures would allow the proposed project to feasibly operate with a 100-meter BMZ or with a BMZ smaller than the assumed 200-meter size. For example, we understand that a nearby wastewater treatment facility may have the capacity to accept some amount of the project's discharge, so we recommend the SEIR evaluate whether this option would provide a feasible mitigation measure to reduce the impacts of the project's direct discharge to coastal waters and reduce the size of the BMZ.

M-5

d) **Marine life mitigation measures:** We understand the Board is reviewing mitigation requirements for the proposed modified project, which will also be the subject of consultation under the Amendment. Poseidon is currently implementing a Marine Life Mitigation Plan approved by the Coastal Commission, so we will work with the Board to ensure that any additional mitigation requirements will be coordinated with the Commission's required Plan.

M-6

3) **SEIR Section 4.3 – Greenhouse Gas ("GHG") Emissions:** The SEIR references the Coastal Commission's approval of Poseidon's Energy Minimization and Greenhouse Gas Reduction Plan and states that the Plan is adequate to "zero out" the project's net indirect GHG emissions. Please note that we recently completed review of the Initial Annual Report required by the Plan and have determined that Poseidon is not in compliance with the Coastal Commission's requirement that the facility operations be "net carbon neutral" (see attached

M-7

RWQCB or CCC. The Water Authority has prepared the SEIR pursuant to CEQA and in support of the decision(s) the Water Authority must consider for the proposed modifications. The CCC has an independent permitting responsibility as stated by the CCC, and can exercise judgement of the materials as part of their review and permitting process.

(See also response to L-7b) The SEIR incorporates by reference the entire submittal package submitted to the RWQCB including a Feasibility Study provided as Appendix B and an Addendum to the Feasibility Study provided as Appendix II in that package, which collectively evaluate 10 alternative technologies and design for intake and discharge. It should be noted that the alternatives to the design and technologies for the intake and discharges are not 'project alternatives' for CEQA purposes as they represent alternative technologies to designed components of the proposed project described in the FEIR aimed at accomplishing the same purpose and the proposed modifications do not result in any significant impacts that an alternative might reduce. The SEIR does not, and is not required to include analysis of project alternatives as the modifications are responses to a foreseen condition of the proposed project (EPS closure) rather than selection of an alternative identified in the FEIR or a new alternative (see SEIR §2.1). However, as part of

RESPONSES TO COMMENTS

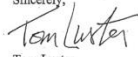
<p style="text-align: center;">Comments on Draft SEIR (SCH #2015091060) – Poseidon Carlsbad Desalination Facility May 27, 2016</p> <p>letter). We have recommended Poseidon submit a revised Plan for Commission review and approval that ensures the project meets this required standard. In the interim, we recommend the SEIR provide a fuller evaluation of the project's GHG-related impacts that doesn't rely on the current Plan.</p> <p>4) SEIR Section 5 – Cumulative Impacts: The SEIR lists a number of planned or proposed projects in the vicinity of the desalination facility, including construction of the new Carlsbad Energy Project at the location of the Encina Power Station ("EPS"). The SEIR's description of the Carlsbad Energy Project states that once the new energy facility is built, "the project includes the removal and remediation of existing EPS generating equipment and structures." We recommend the SEIR provide a detailed description of these EPS-related activities, especially those that could potentially affect construction or operation of the proposed desalination facility, such as removal or remediation of portions of the EPS intake and discharge, activities or timing of activities that would affect the facility's footprint within the EPS site, etc.</p> <p>Again, thank you for the opportunity to comment. Please contact me at 415-904-5248 or tluster@coastal.ca.gov if you have questions or would like additional information.</p> <p>Sincerely,  Tom Luster Energy, Ocean Resources, and Federal Consistency Division</p> <p>Cc: Peter MacLaggan, Poseidon Water Ben Neill, San Diego Regional Water Quality Control Board Claire Waggoner, State Water Resources Control Board</p> <p>Attachment: May 26, 2016 Coastal Commission condition compliance letter to Poseidon Channelside</p>	<p>the permitting process with RWQCB the Applicant has prepared the Feasibility Study (Appendix B to the submittal to the RWQCB) and an Addendum to the Feasibility Study (Appendix II to the submittal to the RWQCB) that collectively address the feasibility of the suggested technologies. The Water Authority has reviewed the Feasibility Study and the Addendum to the Feasibility Study and concurs with the conclusions and findings supporting the proposed intake and discharge modifications, and finds that the conclusions in the SEIR are unchanged. The CCC has an independent permitting responsibility, and can exercise judgement of the materials as part of their review and permitting process.</p> <p>M-3 The CCC recommends that the SEIR continue to assume 100% marine life mortality for entrainment, noting the SEIR mentions the modifications would likely reduce mortality rates (pages 4.2-7 through 4.2-18 of the SEIR). The SEIR does consider as worst-case scenario that mortality is experienced at 100% even with implementation of the proposed modifications designed to reduce such mortality in line with the Ocean Plan Amendment. The significance conclusion in the SEIR remains less than significant consistent with the conclusion of the FEIR.</p> <p>M-4 The CCC suggests that the SEIR evaluate</p>
--	--

M-7
Cont.
M-8

RESPONSES TO COMMENTS

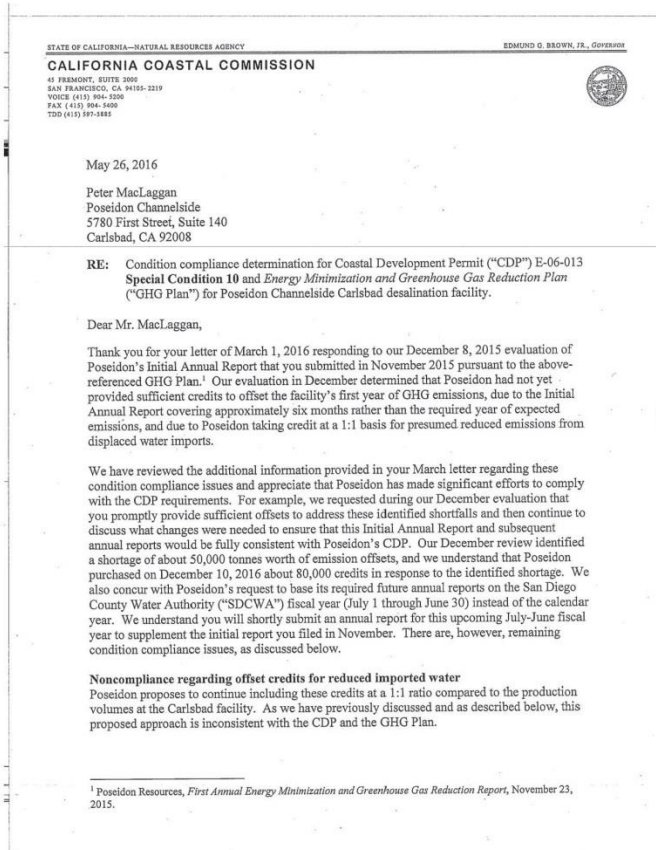

M-5

alternatives to the proposed modifications to reduce intake-related impacts including the use of dewatering wells to supplement the CDP intake See response to L-11 and M-2.

The CCC suggests that the SEIR evaluate alternatives to the presumed 200 meter BMZ. The 200 meter brine mixing zone is proposed rather than presumed, and is consistent with the Ocean Plan Amendment as a facility-specific alternative receiving water salinity limitation. As part of the permitting process for the transition to stand-alone operations, the RWQCB requested that the Encina Wastewater Authority (EWA) be consulted to determine the feasibility of comingling the discharge from the CDP with treated wastewater from the Encina Water Pollution Control Facility (Encina WPCF) and discharging the combined flow to the ocean via the Encina Ocean Outfall. The Applicant is assessing the opportunity for co-mingling a portion of the CDP discharge with municipal wastewater in the Encina Ocean Outfall. Through this assessment, the Encina Wastewater Authority (EWA) confirmed that outfall is not able to accept the CDP discharge during large storm events. Such events significantly increase the quantity of treated wastewater that is processed at the Encina WPCF, leaving no excess capacity in the outfall for the CDP discharge. According to EWA, such events can last up to two weeks.

RESPONSES TO COMMENTS

Condition Compliance – E-06-013, Poseidon Water
May 26, 2016

Background: The Commission's Final Adopted Findings for the CDP describe a number of adverse impacts caused by the indirect greenhouse gas emissions resulting from Poseidon's electrical use during project operations and require that Poseidon's facility and water deliveries be "net carbon neutral." The Commission included in the CDP **Special Condition 10**, which required Poseidon to submit a plan for subsequent Commission review and approval that showed how Poseidon would meet this "net carbon neutral" standard.

In August 2008, the Commission approved Poseidon's proposed GHG Plan. The Plan identified Poseidon's expected annual electrical use and the GHG emissions expected to result from that use, identified various measures Poseidon would implement to reduce or offset those emissions, and established ongoing monitoring and reporting requirements that would identify changes in electrical use and emissions to ensure that facility operations would continue to meet the "net carbon neutral" requirement. The GHG Plan required Poseidon to submit, prior to facility operations, an Initial Annual Report that identified the project's expected first year of electricity use and the resulting indirect GHG emissions from that electricity use, and that provided evidence of Poseidon having sufficient offsets to reduce to zero the first year's net GHG emissions.

The GHG Plan's single largest emission reduction measure, representing about two-thirds of Poseidon's expected indirect emissions, was based on Poseidon's proposal to credit its facility at a 1:1 basis for decreasing GHG emissions through reduced water imports delivered from the State Water Project to the Metropolitan Water District ("MWD") – that is, for every acre-foot of water Poseidon produced, it would be credited for reduced electricity and emissions from an acre-foot of water not delivered by the State Water Project. The GHG Plan stated that Poseidon's participation in an MWD program to subsidize Poseidon's water costs would be based on Poseidon producing water that would offset an equivalent amount of imported water and that MWD would conduct recordkeeping and audits to ensure these offsets occurred.

We understand, however, that after the Commission's approval of the CDP and the GHG Plan, Poseidon, MWD, and the San Diego County Water Authority did not reach agreement over participation in the MWD program referenced in the GHG Plan. Therefore, the expected offsets, recordkeeping, and audits presumed in the GHG Plan have not occurred as described and the project is not meeting the CDP's "net carbon neutral" requirement.

Recommendation: We request that Poseidon submit a revised GHG Plan for Commission review and approval that removes the presumed 1:1 imported water offset credit. Alternatively, Poseidon may propose to provide documentation showing that the offsets have occurred as presumed by the current GHG Plan. Any documentation provided will need to be adequate to establish that Poseidon will meet the Commission's required "net carbon neutral" standard.

Noncompliance with the GHG Plan's requirement for sufficient offsets
The GHG Plan requires Poseidon to submit its Initial Annual Report prior to project operations and requires that the report provide evidence of sufficient mitigation measures and offsets to reduce to zero the project's estimated net indirect GHG emissions for the upcoming first year of Poseidon's operations. Among the mitigation options the GHG Plan allows to meet the "net carbon neutral" standard are offsets obtained through the Climate Action Reserve ("CAR").

M-9
Cont.

The Ocean Plan Amendment requires that when comingling wastewater with brine discharges, there shall be at least one gallon of wastewater available for mixing with each gallon of brine introduced in the outfall. During dry weather, the wastewater flow in the Encina Ocean Outfall drops to less than 7 mgd for a period of two to three hours each day. This diurnal fluctuation in wastewater flow severely limits the amount of wastewater that is available for mixing with the CDP discharge. Therefore, the Encina Ocean Outfall is only able to accept about 10% of the CDP discharge.

As a result of these limitations, comingling the discharge from the CDP with treated wastewater from the Encina WPCF and discharging the combined flow to the ocean via the Encina Ocean Outfall would not reduce or eliminate the need for the proposed intake/discharge modifications nor would it reduce the size of the proposed BMZ. (See also responses to L-3, L-4.).

The SEIR incorporates by reference the entire submittal package submitted to the RWQCB, including EWA's analysis of the available capacity in the Encina Ocean Outfall provided as Appendix CC. The Water Authority has reviewed Appendix CC and concurs that the opportunity for co-mingling

RESPONSES TO COMMENTS

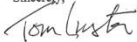
<p style="text-align: right;"><i>Condition Compliance – E-06-013, Poseidon Water May 26, 2016</i></p> <p>Poseidon states in its March 1, 2016 letter that it has purchased sufficient CAR carbon offsets to have a balance of 89,849 tonnes of offsets in its CAR account and that it expects to need about 78,048 tonnes of offsets for its first year of operations prior to consideration of any of the other mitigation options identified in the GHG Plan. As noted by CAR, however, purchased offsets do not fulfill a mitigation requirement until they are "retired."² We understand from CAR that Poseidon has not yet retired the offsets needed to "zero out" its first year emissions prior to operations. As a result, Poseidon is not yet in conformity with the GHG Plan's requirement to provide evidence that sufficient offsets have been provided to meet the required "net carbon neutral" standard.</p> <p>Recommendation: We request that Poseidon promptly provide evidence from CAR that it has retired sufficient offsets to reduce to zero the facility's expected first year of operations. As noted above, that appears to be approximately 78,048 tonnes worth of offsets. Once Poseidon retires the necessary offsets, we will apply them to the first full year of project operations and can adjust them as necessary for subsequent reporting years, as provided by the GHG Plan.</p> <p>Conclusion Thank you for your attention to these issues. We are happy to answer any questions you may have or discuss other options Poseidon may wish to propose.</p> <p>Sincerely,  Tom Luster Energy, Ocean Resources, and Federal Consistency Division</p> <p><small>² As stated by CAR, for example, "[r]etirement means CRTs have been permanently removed from further transactions after being used to offset an equivalent tonne of emissions. Retirement of CRTs is necessary to ensure that the environmental benefit actually occurs. Because of this, retirement is permanent. Once a CRT is transferred into a retirement account, it cannot be reactivated and transferred again."</small></p>	<p style="text-align: center;">M-9 Cont.</p> <p>with municipal wastewater does not reduce or eliminate the need for the proposed intake and discharge modifications, and finds that the conclusions in the SEIR are unchanged. Since the opportunity for co-mingling with municipal wastewater does not reduce or eliminate the need for the proposed intake/discharge modifications, it will not be considered any further in the SEIR.</p> <p>M-6 The CCC identifies that the Marine Life Mitigation Plan approved by the CCC is under review by the RWQCB and the CCC will work with the RWQCB to coordinate any additional measures. The SEIR identifies that there are no significant impacts to marine biological resources, consistent with the findings of the FEIR. As such any additional measures required by the RWQCB under their permitting authority would not be inconsistent with the analysis provided under CEQA unless new physical environmental effects would result, as is the case for implementation of (or revisions to) the Marine Life Mitigation Plan. See also responses to L-9 and L-10.</p> <p>M-7 The CCC identifies that Poseidon is not in compliance with the Energy Minimization and Greenhouse Gas Reduction Plan (GHG Plan) approved by the CCC, and as such the SEIR should provide an analysis that does not rely on that plan. That the CCC has identified non-</p>
---	---

RESPONSES TO COMMENTS

	<p>compliance and provided recommendations to obtain compliance indicates that the Plan is an effective measureable Plan under which the Applicant is accountable and must demonstrate achieving the required net zero. The Applicant disagrees with the statement that it is not in compliance with the GHG Plan (see response to M-9), and is committed to resolving the issues identified by the CCC and obtaining concurrence that the Plan is being successfully implemented. Successful implementation is achieving compliance with the Plan, which realizes a net carbon neutral facility consistent with the analysis provided in the SEIR. The Water Authority considers the use of the approved and enforceable Plan a necessary component of the analysis and that the analysis provided in the SEIR does not require revision. Please also see response to M-9.</p> <p>M-8 The CCC suggests that the cumulative impacts section (Section 5 of the SEIR) be revised to include more specific description and evaluation related to the removal and remediation of the EPS generating equipment and structures. The removal of EPS structures is an unrelated project (Carlsbad Energy Center), the details of which are not known at this time and not the within the decision authority of the Water Authority and is correctly identified as a cumulative project addressed under separate</p>
--	--

RESPONSES TO COMMENTS

	<p>environmental analysis. The removal and remediation of the existing EPS site is not expected to affect construction or operation of the CDP including proposed modifications. (See also response to L-6).</p> <p>M-9 The CCC attached to their comments on the SEIR a letter to Poseidon identifying two condition compliance issues with the CCC approved Coastal Development Permit, specifically for Special Condition 10 and Energy Minimization and Greenhouse Gas Reduction Plan. The two issues consist of realizing the 1:1 offset credit of CDP generated water to imported water, and ‘retirement’ of purchased offsets is necessary to fulfill mitigation obligations. The operation of the Carlsbad Desalination Project does not result in the direct emission of greenhouse gasses. However, the Applicant agreed to offset the indirect emissions associated with electricity purchases for the project such that the project is “net carbon neutral.” The letter the Coastal Commission attached to its comments on the SEIR asserts that while Poseidon had purchased sufficient Climate Action Reserve (CAR) certified carbon offsets to fully offset the first year of project operations prior to consideration of any other mitigation options identified in the GHG Plan, Poseidon’s obligation under the GHG Plan had not yet been fulfilled because the offsets had not been</p>
--	--

RESPONSES TO COMMENTS

“retired.” Applicant’s June 14, 2016 response to the CCC letter, notes this statement is in conflict with the explicit requirements the GHG Plan, which requires purchase of offsets prior to commencement of operation, but not the immediate retirement thereof:

“Prior to the commencement of Project operations, Poseidon will be required to purchase offsets sufficient to cover estimated net (indirect) emissions for at least the first year of operation...”

(GHG Plan at page 22, emphasis added). Nevertheless, in response to staff’s feedback, on May 27, 2016, the Applicant retired an additional 78,048 tons of the offsets purchased prior to commercial operation. This quantity of offsets is sufficient to 100% of the indirect emissions associated with CDP operations for at least the first year of operation.

With respect to the imported water offset credit, the GHG Plan provides that every acre foot of water produced by the project that results in a reduction in water supplied by MWD receives a credit for avoided GHG emissions from an acre foot that MWD would otherwise have imported from the State Water Project (the “imported water offset”):

“Because the Project will avoid the use of 56,000 AFY of imported water to Customers, once in operation, the

RESPONSES TO COMMENTS

*Project will also avoid 190,641 MWh/yr of electricity consumption otherwise required to deliver that water to Customers, as well as the GHG emissions associated with pumping, treatment and distribution of this imported water. At 780.79 lbs CO₂ per MWh, the total expected Avoided Emissions as a result of the Project is 67,506 metric tons CO₂/yr. Each year, **Poseidon will be credited with Avoided Emissions based on the most recent SWP emission factors and the amount of water Poseidon produces.**”*

(GHG Plan at page 19, emphasis added). While the CCC’s letter does not directly address the SEIR adequacy as it supports the CCC comment M-7, therefore, the Water Authority is including the Applicant’s response to that letter as part of the Final SEIR. Please see response to M-7.

RESPONSES TO COMMENTS

Comment Letter N

Rincon Band of Luiseño Indians Cultural Resources Department

1 West Tribal Road • Valley Center • CA 92082 • (760) 297-2635 • Fax: (760) 297-2639



May 27, 2016

Mark Tegio
Senior Water Resources Specialist
San Diego County Water Authority
4677 Overland Avenue
San Diego, CA 92123-1233

RE: Draft Supplement to the Environmental Impact Report (EIR) for the Precise Development Plan and Desalination Plant Project (SCH#2004041081 and 2015091060)

Dear Mr. Mark Tegio:

This letter is written on behalf of the Rincon Band of Luiseno Indians. We have received the Notice of Availability of a Draft Supplement to the EIR regarding the above named project.

The identified project location is within the Aboriginal Territory of the Luiseno people, and it is also within Rincon's historic area of cultural interest. Embedded in the Luiseno Territory are Rincon's history, culture, and identity, and the identified project is situated in our Traditional Use Area.

After reviewing the Draft Supplement to the EIR, we agree with the provision for Native American monitoring identified on pages 2-6 and 2-7 of the document. We still request any information you may have or will acquire regarding cultural resources on the project.

We again thank you for the opportunity consult and to protect and preserve our Luiseno cultural heritage.

Sincerely,

Vincent Whipple
Cultural Resources Manager
Rincon Band of Luiseno Indians

Bo Mazzetti Stephanie Spencer Steve Stallings Laurie E. Gonzalez Alfonso Kolb, Sr.
Tribal Chairman Vice Chairwoman Council Member Council Member Council Member

Response to Comment Letter N

Rincon Band of Luiseño Indians (Rincon) Vincent Whipple, Cultural Resources Manager May 27, 2016

- N-1** The Rincon Band of Luiseno Indians identifies their interest in the project and heritage in the area. The Water Authority identifies Rincon on page 2-6 in the SEIR consistent with their statements. No further response is necessary.
- N-2** Rincon agrees with the monitoring provision identified on pages 2-6 and 2-7 of the SEIR and request that any information the Water Authority has or may acquire from the project be shared. The Water Authority is committed to the monitoring as described on pages 2-6 and 2-7 of the SEIR. The Water Authority provided all materials related to cultural resources to Rincon during consultation and will share any further information obtained during the monitoring of the project.

SECTION 1

EXECUTIVE SUMMARY

1.1 INTRODUCTION

On June 13, 2006, the City of Carlsbad (City) approved an amendment to the Precise Development Plan (PDP) for the Encina Power Station (EPS) and certified the Carlsbad Precise Development Plan and Desalination Plant Final Environmental Impact Report (FEIR) for the Carlsbad Desalination Project (CDP). Since that certification, four separate Addenda to the FEIR have been approved. The first was prepared and approved by the City and a second, third, and fourth were prepared and approved by the San Diego County Water Authority (Water Authority). The project was constructed and is currently operational, but certain changes are required to the intake and discharge components, and there is a proposed capacity change; therefore, the Water Authority, as lead agency pursuant to the California Environmental Quality Act (CEQA) (California Public Resources, Section Code 21000 et seq.) and the CEQA Guidelines (14 CCR 15000 et seq.), has prepared this Supplement to the Environmental Impact Report (SEIR) to provide supplemental information to the previously certified FEIR. The proposed CDP modifications would support the planned transition from co-located operations with the Encina Power Station (EPS) to permanent stand-alone operations. These changes are necessary due to the upcoming decommissioning of the EPS once-through cooling water system and seawater intake pumps.

This SEIR evaluates the potential environmental effects resulting from the project as modified, which includes (1) seawater intake and discharge system improvements required to be constructed due to the decommissioning of the once-through cooling system of the EPS, and compliance with the 2015 Ocean Plan Amendment; and (2) desalination processing improvements that would increase production capacity of the CDP by approximately an annual average 5 million gallons per day (mgd) (proposed CDP modifications)¹. Specifically, the Water Authority is analyzing the project proposal of Poseidon Resources (Channelside) LP (Poseidon or Applicant) and must consider how to 1) ~~how~~ finance the CDP modifications and/or ~~how to~~ 2) supplement the Water Purchase Agreement (WPA) between the Water Authority and Poseidon, such that a stand-alone CDP facility could operate and an increased maximum volume of water could potentially be ~~purchased~~ produced.

¹ This represents a 10% increase in the maximum annual production capacity of the CDP from 56,000 acre-feet per year (AFY) to 61,600 AFY. The daily maximum production would increase from 54 MGD to 60 MGD, and the daily average production on an annualized basis would increase from 50 MGD to 55 MGD.

1.2 PURPOSE

The purpose of this SEIR is to provide minor additions and changes to the FEIR, presenting new information to make the FEIR adequate in assessing and disclosing potential impacts to the physical environment associated with proposed CDP modifications, and it should be read in conjunction with the FEIR (including all addendums and CEQA responsible agencies mitigation measures and permit conditions). This document provides relevant information for consideration by decision-makers and the general public. More information on this SEIR, including details about its preparation, may be found in Section 2, Introduction.

The purpose of the Water Authority's actions and the proposed CDP modifications are as follows:

- Preserve the Water Authority's right to determine ~~whether~~ how to finance the CDP modifications for permanent stand-alone operations of the CDP.
- To transition the CDP to permanent stand-alone operations as a consequence of the decommissioning of the EPS once-through cooling water system.
- To satisfy conditions to the project's National Pollutant Discharge Elimination System (NPDES) Permit No. CA0109223 (NPDES Permit) by addressing the requirements of Section 13142.5(b) of the California Water Code—specifically to develop “the best available site, design, technology, and mitigation measures feasible...to minimize the intake and mortality of all forms of marine life,” in light of EPS discontinuing use of the cooling water intake.
- To meet the Water Quality Control Plan for the Ocean Waters of California (Ocean Plan) requirements related to desalination. Key parts of the 2015 Ocean Plan Amendment are as follows:
 - Define dimensions of a “brine mixing zone” (a zone where elevated salinities may cause marine life toxicity) beyond which Ocean Plan salinity receiving water requirements are applicable.
 - Require that receiving water salinity is not to exceed 2 parts per thousand (ppt) above ambient at the edge of the brine mixing dilution zone unless the Regional Water Quality Control Board (RWQCB) authorizes a facility-specific receiving water salinity limitation.
 - Establish requirements under which the RWQCB may consider and approve a facility-specific receiving water salinity limitation of more than 2 ppt above ambient.

- Require use of the best feasible combination of available site, design, technology, and mitigation measures to minimize the intake and mortality impacts to marine organisms.
- Establish monitoring and reporting requirements for assessing receiving water, benthic communities, and sediments to ensure that brine discharges do not cause adverse effects to marine life.
- Utilize reverse osmosis membrane technology advances to potentially allow an increase in potable water production capabilities from an annual average of 50 mgd to an annual average of 55 mgd with minimal improvements to the plant.
- Preserve the Water Authority's future option to determine whether to purchase additional capacity-output of potable water from the stand-alone facility.

Background

On January 14, 2014, the City of Carlsbad, NRG Energy, and San Diego Gas & Electric (SDG&E) entered into an agreement that set a plan in motion to decommission the EPS, and to replace the plant with a new “air-cooled” plant that would provide approximately 500 megawatts of electricity. The new plant would replace all generating units of the EPS, resulting in the permanent decommissioning of the EPS once-through cooling water system and seawater intake pumps.

On May 5, 2014, Cabrillo Power I LLC (Cabrillo), a subsidiary of NRG Energy, which owns and operates the EPS, provided notice to the owner of the CDP, Poseidon, that the EPS is scheduled to permanently decommission the once-through cooling water system—specifically, the seawater intake pumps—effective June 1, 2017. This will result in the need for the CDP to directly withdraw seawater from the Agua Hedionda Lagoon for the desalination plant on a permanent basis (which was referred to as “stand-alone operations” in the FEIR and supporting documents), rather than making use of the discharged cooling waters from the EPS (referred to as “co-located operations” in the FEIR). The 2009 RWQCB NPDES permit for the CDP requires Poseidon to re-evaluate whether the CDP would comply with the requirements of California Water Code Section 13142.5(b) when the EPS permanently decommissions its once-through cooling system and the CDP transitions into permanent stand-alone operations. California Water Code Section 13142.5(b) requires that “the best available site, design, technology, and mitigation measures feasible shall be used to minimize the intake and mortality of all forms of marine life.” Permanent decommissioning of the EPS once-through cooling water system may allow opportunities to employ additional and/or better design or technology features for the CDP intake that are not feasible when the EPS is in operation.

On May 5, 2015, the State Water Resources Control Board (SWRQB) adopted revisions to the state's Ocean Plan, which established requirements governing operations and ocean intake and ocean discharges from seawater desalination facilities (Ocean Plan Amendment). The amendment supports the use of ocean water as a reliable supplement to traditional water supplies while protecting marine life and water quality. It provides direction for regional water boards when permitting new or expanded facilities, and provides specific implementation and monitoring and reporting requirements. Further details about the Ocean Plan Amendment are provided in Section 2.3, Regulatory Changes.

The Ocean Plan Amendment requires new or expanded seawater desalination plants to use the best available site, design, technology, and mitigation measures feasible to minimize intake and mortality of all forms of marine life. The proposed modifications to CDP intake and discharge components are designed to allow permanent stand-alone operations and to comply with the requirements of the Ocean Plan Amendment.

1.3 PROJECT LOCATION

The CDP is located on the EPS site, adjacent to the existing power plant, located immediately south of the Agua Hedionda Lagoon, within the City of Carlsbad, in northern San Diego County. The facility address is 4590 Carlsbad Boulevard, Carlsbad, California 92008. The proposed CDP modifications would occur within the existing CDP lease and easement areas.

1.4 PROJECT DESCRIPTION

The proposed CDP modifications involve changes to the existing intake and discharge operations, including direct seawater intake to supply the CDP, construction of new 1 mm screening to screen seawater for process water or brine dilution water, construction of a new fish return system into the Agua Hedionda Lagoon or the existing EPS discharge pond prior to discharge to the Pacific Ocean, construction of new fish-friendly pumps to direct dilution water, and potentially increased annual average production capacity from 50 mgd to 55 mgd. The proposed modifications would result in changes to the intake and discharge water characteristics (volume, velocity, and salinity). Table 1-1 provides a summary of the project components and proposed CDP modifications. The physical changes associated with the proposed CDP modifications compared to the operating CDP are described in more detail in Section 3 of this SEIR.

**Table 1-1
Project Modifications Summary Comparison to Final Environmental Impact Report/
Constructed Carlsbad Desalination Project**

Project Component	Certified FEIR Description (Built)	SEIR Modifications (Proposed)	Change
CDP annual average production capacity	50 mgd annual average	55 mgd annual average ²	Increase of 5 mgd
CDP daily maximum production capacity	54 mgd daily maximum	60 mgd daily maximum ²	Increase of 6 mgd
Intake tunnel structure	Existing EPS intake structure	Cut into existing EPS intake tunnel structure to connect with CDP intake. Seal off EPS intake and discharge tunnels.	Connection to CDP intake
Total intake tunnel volume	304 mgd from EPS discharge	299 mgd for processing at CDP and for dilution water	Decrease of 5 mgd
CDP intake/discharge structure dimensions	2,500 sqft intake structure	9,000 sqft* 1 mm screening and fish-friendly dilution pumping structure	Addition of structure for 1 mm screens and fish-friendly pumps
CDP annual average production intake volume	104 mgd from EPS outlet	118 mgd from Agua Hedionda Lagoon intake for processing at CDP	Increase of 14 mgd
CDP daily maximum production intake volume	114 mgd from EPS outlet	127 mgd from Agua Hedionda Lagoon intake for processing at CDP	Increase of 13 mgd
CDP annual average brine and backwash water discharge volume	54 mgd	62 mgd	Increase of 8 mgd
CDP daily maximum brine and backwash water discharge volume	60.3 mgd	67 mgd	Increase of 6.7 mgd
CDP discharge salinity	64.65 to 67 ppt	64.65 to 67 ppt	No change
Dilution volume	Up to 200 mgd from EPS	171 mgd to 198 mgd from fish-friendly pumps withdrawing dilution water from Agua Hedionda Lagoon	Decrease of up to 29 mgd needed for dilution
Discharge pond	Existing EPS discharge pond	Existing EPS discharge pond	No change
Discharge volume	254 mgd	238 mgd to 244 mgd	Decrease of 10 mgd to 16 mgd

**Table 1-1
Project Modifications Summary Comparison to Final Environmental Impact Report/
Constructed Carlsbad Desalination Project**

Project Component	Certified FEIR Description (Built)	SEIR Modifications (Proposed)	Change
Discharge pond salinity	40 ppt saline	Up to 42 ppt saline	Increase of 2 ppt salinity
Discharge location	Existing EPS discharge tunnel	Existing EPS discharge tunnel	No change
Offshore dilution area permitted	Requirement for 1,000 feet zone of initial dilution	Requirement for 656 feet brine mixing zone	Reduction in the area exposed to salinity greater than 2 ppt over background salinity per changes in applicable regulatory limits
Dilution pumps	Existing EPS pumps	Four fish-friendly pumps within an approximately 9,000 sqft (below grade) structure**	Addition of structure* and new fish-friendly dilution flow pumps to replace EPS pumps
Dilution pumps electrical building	EPS electrical service	512 sqft structure (16 x 32 feet and up to 12 feet tall)	Addition of ancillary electrical facility to power travelling screens and fish-friendly pumps
Fish screens – CDP intake and dilution pumps	Existing EPS screens with 9.5 mm to 14 mm openings and through-screen velocity of greater than 0.5 feet per second	Travelling screens with 1 mm slot openings and through-screen velocity of 0.5 feet per second or less	Addition of best available design and technology used to minimize impacts to marine organisms
Fish return system	None	1 mgd for fish return system designed to transport fish caught up in the intake back to a quiescent part of the lagoon <u>or</u> <u>the existing EPS discharge pond</u>	Addition of best available design and technology used to minimize impacts to marine organisms. 1 mgd needed for fish return system.
Trash Racks	Existing EPS trash racks	Not altered/affected by modifications	No change
Maintenance dredging	Periodic maintenance dredging of outer lagoon with sand deposited on local beaches	Not altered/affected by modifications	No change
Beach nourishment from dredging	Conducted by NRG on the beach	Not altered/affected by modifications	No change
CDP Buildings	60,700 sqft	Not altered/affected by modifications	No change
CDP site	5.7 acres	Not altered/affected by modifications	No change
CDP delivery system	Pipelines and storage outside of the PDP	Not altered/affected by modifications	No change

**Table 1-1
Project Modifications Summary Comparison to Final Environmental Impact Report/
Constructed Carlsbad Desalination Project**

Project Component	Certified FEIR Description (Built)	SEIR Modifications (Proposed)	Change
Electricity Demand	36.05 MWh/h worst case evaluated in the FEIR at maximum production of 54 mgd under co-located operations, compared to the actual energy consumption of 32.0 MWh/h at 50 mgd production under collocated operations	37.3 MWh/h expected annual average under standalone operations at 55 mgd and 45.0 MWh/h worst case maximum under standalone operations at 60 mgd operation	5.3 MWh/h average annual increase when compared to current average annual operating conditions; and 8.9 MWh/h increase in worst case maximum operating conditions evaluated in the FEIR

Notes:

* Potential increase in potable water production capability that would utilize reverse osmosis membrane technology advances.

** 9,000 sqft structure with fish-friendly dilution pumps also includes the new 1 mm travelling screens (see Figure 4)

FEIR = Final Environmental Impact Report; SEIR = Supplemental Environmental Impact Report; CDP = Carlsbad Desalination Project; mgd = million gallons a day; EPS = Encina Power Station; sqft = square feet; ppt = part per thousand; EWPCF = Encina Water Pollution Control Facility; mm = millimeter; PDP = Precise Development Plan

1.5 ENVIRONMENTAL REVIEW REQUIREMENTS

1.5.1 Supplement to an EIR

The Water Authority has determined that a Supplement to the previously certified FEIR is the appropriate document to address the proposed CDP modifications since the conditions described in Section 15162 of the CEQA Guidelines for a Subsequent EIR are met and only minor additions or changes are necessary to make the previous EIR adequately apply to the project in the changed situation (14 CCR 15163(a)). A more detailed discussion of the use of a Supplement to an EIR is provided in Section 2.

1.5.2 Regional Water Quality Control Board – Amended Report of Discharge

Poseidon assembled materials and submitted an Amended Report of Waste Discharge and Renewal of NPDES CA0109223 CDP to the San Diego RWQCB on September 4, 2015 (2015 Submittal to RWQCB), and is hereby incorporated by reference in its entirety to this SEIR. The 2015 Submittal to RWQCB is available at <http://www.sdcwa.org/environmental-impact-reports-and-mitigated-negative-declarations> and can be viewed at the Water Authority's offices at 4677 Overland Avenue, San Diego, California 92123. The submittal included a request that the existing discharge permit (NPDES CA0109223) be modified to allow permanent stand-alone operations upon termination of the EPS and ~~an~~ a potential increase in CDP production capacity.

The submittal also demonstrated how the proposed CDP modifications would ensure compliance with recent revisions to the state's Ocean Plan governing discharges to the ocean from seawater desalination facilities. The Water Authority has independently reviewed Poseidon's 2015 Submittal to RWQCB and concurs with its findings.

1.6 ISSUES OF CONCERN

A public scoping process was conducted in accordance with the requirements of the CEQA Guidelines Sections 15163 and 15087, as described in Section 2.2 of this SEIR. No comments were received during the Notice of Preparation (NOP) scoping process in writing or at the public scoping meeting that indicated concerns with the proposed CDP modifications. Only the City provided comments identifying the documents and actions they would have to revise and approve to include the proposed modifications. As such, there are no known issues of concern specific to the proposed CDP modifications.

It should be noted that in general, the principal areas of concern associated with any seawater desalination intake and discharge facilities are the potential effects on marine life. These effects include fish and fish larvae mortality from impingement and entrainment. Impingement is the pinning of larger organisms against a screen mesh by the flow of the withdrawn water. Entrainment is the passage of smaller organisms through a screening mesh. Concerns over marine life are also associated with increased salinity levels and exposure to high-saline water (brine).

The proposed CDP modifications have been designed through an extensive process to minimize the impacts of mortality of fish species and larvae as part of the submittal to and requirements of the RWQCB. The approaches considered for achieving the intake and discharge modifications are summarized in ~~in~~ Section 3.1, and a detailed review is provided in the Intake/Discharge Feasibility Report Study provided as Appendix B and the Addendum Intake/Discharge Feasibility Report provided as Appendix II to the ~~2015~~ Submittal to RWQCB. The Water Authority has independently reviewed the Feasibility Report Study and the Addendum and concurs with the analysis and conclusions regarding the likely effects of alternative technologies and design, and that the ~~selected technology and design~~ (proposed CDP modifications in combination with the existing CDP are) is the best available design and technology feasible for minimizing the intake and mortality of all forms of marine life at the project location~~for the Carlsbad Desalination location~~. In this instance, the evaluation of alternative sites was limited to intake and discharge siting opportunities in reasonable proximity to the existing CDP, which has already been constructed and is operating. As such, no remote locations for proposed CDP modifications are evaluated herein. Detailed discussion regarding the potential marine life impacts associated with the proposed modifications~~marine ecology~~ is provided in Section 4.2, Biological Resources.

1.7 ENVIRONMENTAL ANALYSIS

The Water Authority conducted an initial study (Appendix S-A) and public scoping process to determine the environmental topics to be addressed in this SEIR. The following resource topics were determined to be necessarily included in the SEIR to make minor additions or changes to make the previously certified EIR (FEIR) adequately apply with inclusion of the proposed CDP modifications. Table 1-2 summarizes the potential impacts related to the proposed CDP modifications for the following topics:

- Air quality
- Biological resources (marine)
- Greenhouse gas emissions
- Hydrology and water quality
- Energy
- Growth inducement

In addition to these resource topics, this SEIR includes an energy section. Since the FEIR was prepared, standard practice for preparation of EIRs has evolved to include a standalone Energy section to directly address CEQA Guidelines Appendix F. All other resource topic analyses in the previously certified FEIR were determined to be adequate for the purposes of considering the CDP impacts with implementation of the proposed CDP modifications. Land use and planning was indicated in the initial study as a topic that would be taken forward for discussion in the SEIR. However, upon further analysis and consistent with the conclusions of the initial study, no substantial new information is associated with this topic requiring any supplementary changes to the FEIR. Therefore, only the resource topics listed above are addressed in this SEIR, in accordance with CEQA Guidelines Section 15163(b).

**Table 1-2
Proposed Intake/Discharge Modifications – Summary of Environmental Impacts and Applicable Mitigation**

FEIR CDP Impact	SEIR CDP With Modifications Impact	FEIR Mitigation Measure	SEIR Mitigation	FEIR CDP Impact After Mitigation	SEIR CDP with Modifications Impact After Mitigation
<i>Air Quality</i>					
No significant <u>project level</u> impacts to air quality were identified for the project in the FEIR.	No new or more severe impacts with the inclusion of proposed CDP modifications are identified in this SEIR.	No significant impacts to air quality were identified; therefore, no mitigation measures are required for the Project in the FEIR.	No significant impacts to air quality were identified, therefore, no <u>or</u> mitigation measures <u>are</u> required in this SEIR with the inclusion of the proposed CDP modifications.	N.A.	N.A.
Significant unavoidable cumulative air quality impacts were identified in the FEIR for incremental indirect use of fossil fuels and emission of nonattainment pollutants associated with generating electricity within the SDAB to supply the electricity demand for the project.	Applying that same rationale, the proposed CDP modifications would substantially increase the incremental indirect emission of nonattainment pollutants within the SDAB to supply the increased electricity demand and result in a potentially significant and unavoidable cumulative air quality impact.	No mitigation measures were found feasible in the FEIR.	No mitigation measures were found feasible in this SEIR.	Since no mitigation measures are feasible, indirect cumulative air quality impacts are significant and unavoidable.	Since no mitigation measures are feasible, indirect cumulative air quality impacts remain significant and unavoidable.
<i>Biological Resources</i>					
Operation of the CDP net flow rates that represent both “co-located” and “stand-alone” conditions would not result in salinity levels that would exceed significance thresholds. However, a mitigation	Operation of the CDP with incorporation of the proposed modifications would not result in salinity levels that would exceed significance thresholds. However, a mitigation measure has been	The operator of the CDP shall continuously monitor the CDP discharge flow rates and salinity levels. The operator of the CDP shall on at least a semi-annual frequency conduct acute and chronic toxicity	The operator of the CDP with incorporated modifications shall continuously monitor the CDP discharge flow rates and salinity levels. The operator of the CDP shall on at least a semiannual	Impacts to biological resources from the CDP can be mitigated to less than significant levels by incorporation of mitigation measures. No significant adverse impacts would remain after mitigation.	Impacts to biological resources from the CDP with incorporation of proposed modifications can be mitigated to less than significant levels by incorporation of mitigation measures. No significant

**Table 1-2
Proposed Intake/Discharge Modifications – Summary of Environmental Impacts and Applicable Mitigation**

FEIR CDP Impact	SEIR CDP With Modifications Impact	FEIR Mitigation Measure	SEIR Mitigation	FEIR CDP Impact After Mitigation	SEIR CDP with Modifications Impact After Mitigation
measure has been included for purposes of requiring monitoring of the desalination plant operation to ensure that salinity levels remain within the parameters that have been analyzed.	included for purposes of requiring monitoring of the desalination plant operation to ensure that salinity levels remain within the parameters that have been analyzed.	testing to monitor the discharge for compliance with Ocean Plan acute and chronic toxicity requirements. The operator of the CDP shall and maintain records of the monitoring results to ensure compliance with Ocean Plan criteria and EPA guidelines. All semi-annual monitoring and testing required by this mitigation measure shall be summarized in a report and submitted to the RWQCB within 45 days of completion, and any noncompliance with Ocean Plan acute and chronic toxicity requirements shall be reported to the RWQCB. Such monitoring results shall be available for inspection by the Water Authority, City of Carlsbad, and the RWQCB. Should the RWQCB adopt a permit requirement that is intended to provide equal or greater protection to the	frequency conduct acute and chronic toxicity testing to monitor the discharge for compliance with Ocean Plan acute and chronic toxicity requirements. The operator of the CDP shall and maintain records of the monitoring results to ensure compliance with Ocean Plan criteria and EPA guidelines. All semi-annual monitoring and testing required by this mitigation measure shall be summarized in a report and submitted to the RWQCB within 45 days of completion, and any noncompliance with Ocean Plan acute and chronic toxicity requirements shall be reported to the RWQCB. Such monitoring results shall be available for inspection by the Water Authority, City of Carlsbad, and the RWQCB. Should the RWQCB adopt a permit requirement that is intended to provide equal		adverse impacts would remain after mitigation.

**Table 1-2
Proposed Intake/Discharge Modifications – Summary of Environmental Impacts and Applicable Mitigation**

FEIR CDP Impact	SEIR CDP With Modifications Impact	FEIR Mitigation Measure	SEIR Mitigation	FEIR CDP Impact After Mitigation	SEIR CDP with Modifications Impact After Mitigation
		marine environment, this mitigation measure shall be revised to conform to the RWQCB order.	or greater protection to the marine environment, this mitigation measure shall be revised to conform to the RWQCB order.		
Greenhouse Gas					
The FEIR did not make a determination regarding significance of GHG impacts because that was not a CEQA requirement at the time of the FEIR. The CCC conditioned the CDP project to include an Energy Minimization and GHG Reduction Plan (Appendix S-C) to avoid potential impacts to GHG and energy waste.	New CEQA requirements since preparation of the FEIR require inclusion of a GHG section in an EIR. No significant impacts to GHG emissions were identified associated with the proposed CDP modifications because the CDP project as now existing is subject to a CCC condition for an Energy Minimization and GHG Reduction Plan that offsets net indirect GHG emissions associated with the CDP operations. This CCC condition will be implemented inclusive of the proposed CDP modifications.	No significant impacts to GHG emissions were identified; therefore, no mitigation measures are required. An Energy Minimization and GHG Reduction Plan was implemented as a condition of CCC's approval.	No significant impacts to GHG emissions were identified; therefore, no mitigation measures are required. The Energy Minimization and GHG Reduction Plan will be implemented as a condition of CCC's approval for the CDP with incorporation of the proposed modifications.	N.A	N.A.
Hydrology and Water Quality					
If the construction areas are not properly managed	If the construction areas for the proposed CDP	Prior to issuance of a grading permits, building	Prior to issuance of a grading permits or building	The proposed mitigation measures and project	The proposed mitigation measures and project

**Table 1-2
Proposed Intake/Discharge Modifications – Summary of Environmental Impacts and Applicable Mitigation**

FEIR CDP Impact	SEIR CDP With Modifications Impact	FEIR Mitigation Measure	SEIR Mitigation	FEIR CDP Impact After Mitigation	SEIR CDP with Modifications Impact After Mitigation
to contain loose soils and liquid and solid contaminants, potentially significant short-term water quality impacts could occur.	modifications are not properly managed to contain loose soils and liquid and solid contaminants, potentially significant short-term water quality impacts could occur.	permit, or demolition permit, whichever occurs first or other permits, the project applicant shall demonstrate compliance with all applicable regulations established by the United States Environmental Protection Agency (USEPA) as set forth in the National Pollutant Discharge Elimination System (NPDES) permit requirements for urban runoff and storm water discharge and any regulations adopted by the city within which construction will take place, pursuant to the NPDES regulations or requirements of that city (Carlsbad). Further, the applicant shall file a Notice of Intent (NOI) with the State Water Resources Control Board to obtain coverage under the NPDES General Permit for Storm Water Discharges	permit, for the CDP modifications, whichever occurs first the project applicant shall demonstrate compliance with all applicable regulations established by the United States Environmental Protection Agency (USEPA) as set forth in the National Pollutant Discharge Elimination System (NPDES) permit requirements for urban runoff and storm water discharge and any regulations adopted by the city within which construction will take place, pursuant to the NPDES regulations or requirements of that city (Carlsbad). Further, the applicant shall file a Notice of Intent (NOI) with the State Water Resources Control Board to obtain coverage under the NPDES General Permit for Storm Water Discharges	design would mitigate all significant impacts of the CDP related to water quality to a less than significant level.	design would mitigate all significant impacts of the CDP with incorporation of the proposed modifications related to water quality to a less than significant level.

**Table 1-2
Proposed Intake/Discharge Modifications – Summary of Environmental Impacts and Applicable Mitigation**

FEIR CDP Impact	SEIR CDP With Modifications Impact	FEIR Mitigation Measure	SEIR Mitigation	FEIR CDP Impact After Mitigation	SEIR CDP with Modifications Impact After Mitigation
		<p>Associated with Construction Activity and shall implement a Storm Water Pollution Prevention Plan (SWPPP) concurrent with the commencement of grading activities. The SWPPP shall include both construction and post-construction pollution prevention and pollution control measures and shall identify funding mechanisms for post-construction control measures. The following best management practices shall be adhered to during construction:</p> <ul style="list-style-type: none"> • Gravel bags, silt fences, etc. shall be placed along the edge of all work areas as determined appropriate by the City's construction inspector to contain particulates prior to contact with receiving waters. • All concrete washing 	<p>Associated with Construction Activity and shall implement a Storm Water Pollution Prevention Plan (SWPPP) concurrent with the commencement of grading activities. The SWPPP shall include both construction and post-construction pollution prevention and pollution control measures and shall identify funding mechanisms for post-construction control measures. The following best management practices shall be adhered to during construction:</p> <ul style="list-style-type: none"> • Gravel bags, silt fences, etc. shall be placed along the edge of all work areas as determined appropriate by the City's construction inspector to contain particulates prior to contact with receiving waters. • All concrete washing 		

**Table 1-2
Proposed Intake/Discharge Modifications – Summary of Environmental Impacts and Applicable Mitigation**

FEIR CDP Impact	SEIR CDP With Modifications Impact	FEIR Mitigation Measure	SEIR Mitigation	FEIR CDP Impact After Mitigation	SEIR CDP with Modifications Impact After Mitigation
		<p>and spoils dumping will occur in a designated location.</p> <ul style="list-style-type: none"> • Construction stockpiles will be covered to prevent blow-off or runoff during weather events. • A pollution control education plan shall be developed by the General Contractor and implemented throughout all phases of development and construction. • Severe weather event erosion control materials and devices shall be stored on site for use as needed. • Other best management practices as determined necessary by the cities. 	<p>and spoils dumping will occur in a designated location.</p> <ul style="list-style-type: none"> • Construction stockpiles will be covered to prevent blow-off or runoff during weather events. • A pollution control education plan shall be developed by the General Contractor and implemented throughout all phases of development and construction. • Severe weather event erosion control materials and devices shall be stored on site for use as needed. • Other best management practices as determined necessary by the cities. 		

**Table 1-2
Proposed Intake/Discharge Modifications – Summary of Environmental Impacts and Applicable Mitigation**

FEIR CDP Impact	SEIR CDP With Modifications Impact	FEIR Mitigation Measure	SEIR Mitigation	FEIR CDP Impact After Mitigation	SEIR CDP with Modifications Impact After Mitigation
<p>During construction, placement of construction materials, including equipment, pipes, shoring, and spoils, could temporarily impede or redirect flows.</p>	<p>During construction for the proposed CDP modifications placement of construction materials, including equipment, pipes, shoring, and spoils, could temporarily impede or redirect flows.</p>	<p>Prior to issuance of grading or building permits, whichever occurs first, the applicant shall submit for City approval a Storm Water Management Plan (SWMP). The SWMP shall demonstrate compliance with the City of Carlsbad local Standard Urban Storm water Mitigation Plan (SUSMP), Order 2001-01, and Order 2007-01 issued by the San Diego Region of the California Regional Water Quality Control Board and City of Carlsbad Municipal Code.</p> <p>Construction of the CDP within any area the City of Carlsbad identifies as a 100-year flood hazard shall occur only during dry months (May 1–September 30). The City may waive this restriction if the applicant satisfactorily demonstrates, as determined by the City,</p>	<p>Prior to issuance of grading or building permits for the proposed CDP modifications, whichever occurs first, the applicant shall submit for City approval a Storm Water Management Plan (SWMP). The SWMP shall demonstrate compliance with the City of Carlsbad local Standard Urban Storm water Mitigation Plan (SUSMP), Order 2001-01, and Order 2007-01 issued by the San Diego Region of the California Regional Water Quality Control Board and City of Carlsbad Municipal Code.</p> <p>Construction of proposed CDP modifications within any area the City of Carlsbad identifies as a 100-year flood hazard shall occur only during dry months (May 1–September 30). The City may waive this restriction if the</p>	<p>The proposed mitigation measures and project design would mitigate all significant impacts of the CDP related to water quality to a less than significant level.</p>	<p>The proposed mitigation measures and project design would mitigate all significant impacts of the CDP with incorporation of the proposed modifications related to water quality to a less than significant level.</p>

**Table 1-2
Proposed Intake/Discharge Modifications – Summary of Environmental Impacts and Applicable Mitigation**

FEIR CDP Impact	SEIR CDP With Modifications Impact	FEIR Mitigation Measure	SEIR Mitigation	FEIR CDP Impact After Mitigation	SEIR CDP with Modifications Impact After Mitigation
		that construction would not impede or redirect flood flows and would not expose people or structures to flooding. Such demonstration shall occur before the City issues grading or other permits to permit construction in the flood hazard area in the wet months and may require the applicant to submit plans and details regarding the type, location, quantities and duration of construction equipment and materials, as well as any other information that the City may require.	applicant satisfactorily demonstrates, as determined by the City, that construction would not impede or redirect flood flows and would not expose people or structures to flooding. Such demonstration shall occur before the City issues grading or other permits to permit construction in the flood hazard area in the wet months and may require the applicant to submit plans and details regarding the type, location, quantities and duration of construction equipment and materials, as well as any other information that the City may require.		
Energy					
The FEIR did not make a determination regarding significance of inefficient or wasteful use of electricity. However, the CCC conditioned the CDP project to include an	No significant impacts to energy were identified associated with the proposed CDP modifications. The project applicant (Poseidon) has committed to an Energy	No significant impacts to energy were identified; therefore, no mitigation measures were required.	No significant impacts to energy were identified; therefore, no mitigation measures are required.	N.A.	N.A.

**Table 1-2
Proposed Intake/Discharge Modifications – Summary of Environmental Impacts and Applicable Mitigation**

FEIR CDP Impact	SEIR CDP With Modifications Impact	FEIR Mitigation Measure	SEIR Mitigation	FEIR CDP Impact After Mitigation	SEIR CDP with Modifications Impact After Mitigation
Energy Minimization and GHG Reduction Plan (Appendix S-C) to optimize energy efficiency and offset indirect GHG emissions associated with CDP operations.	Minimization and GHG Reduction Plan (12.10.2008) that commits to efficient energy use and net carbon neutral CDP operations inclusive of the proposed modifications.				

Note: FEIR = Final Environmental Impact Report; CDP = Carlsbad Desalination Project; SEIR = Supplemental Environmental Impact Report; NA = not applicable = SDAB = San Diego Air Basin; EPA = Environmental Protection Agency; RWQCB = Regional Water Quality Control Board = Water Authority = San Diego County Water Authority; GHG = greenhouse gas; CCC = California Coastal Commission; NPDES = National Pollutant Discharge Elimination System

In addition to the measures described in Table 1-2, all applicable mitigation measures identified in the FEIR and mitigation monitoring and reporting program (MMRP) and those minimization measures prescribed as permit conditions by the RWQCB and California Coastal Commission (CCC) for the construction and operation of the existing CDP remain in effect and will be required as appropriate for construction and operation of the proposed CDP modifications. Applicable measures include all those associated with construction and operation activities within the PDP area and those associated with operation of the CDP, but do not include those associated with distribution of treated water produced by the CDP.

SECTION 2 INTRODUCTION

2.1 PURPOSE AND SCOPE OF THE SUPPLEMENT TO THE FEIR

This SEIR has been prepared in compliance with Section 15163 of the CEQA Guidelines guiding the preparation of a Supplement to an EIR. The Water Authority is the CEQA lead agency because it is the agency for which the timing of an action related to the proposed CDP modifications occurs first. Responsible agencies from whom approvals are also required and that may use this Supplement include the City, RWQCB, the CCC, and the California State Lands Commission.

As defined in Section 15163(b) of the CEQA Guidelines, “The supplement to an EIR need only contain the information necessary to make the previous EIR adequate for the project as revised.” The Office of Planning and Research clarifies that a supplement is distinguished from a subsequent EIR in that it simply augments the previous EIR to the extent necessary to address the changed conditions described in CEQA Guidelines Section 15162 and examines mitigation and alternatives accordingly. It is intended to revise the previous EIR through supplementation. A subsequent EIR, in contrast, *is a complete EIR*, which focuses on the changed conditions.

According to Section 15163(a), the Lead Agency may choose to prepare a supplement to an EIR rather than a subsequent EIR if: (1) Any of the conditions described in Section 15162 would require the preparation of a subsequent EIR, and (2) Only minor additions or changes would be necessary to make the previous EIR adequately apply to the project in the changed situation.

The qualifying condition is found in Section 15162(a)(1): Substantial changes are proposed in the project which will require major [or minor for supplemental per §15163(a)(2)] revisions to the previous EIR due to the involvement of new significant environmental effects or a substantial increase in the severity of previously identified significant effects. These are:

Air Quality: Potential increased production capacity could also potentially result in substantially increasing the severity of impacts to air quality than those shown in the FEIR. The increased demand for resources associated with the increased production results in increased emissions including emission of air pollutants for which the San Diego Air Basin is non-compliant for. These impacts could be substantial because they involve increased operational emissions from an increased production capacity of the CDP beyond that previously shown in the FEIR. This is analyzed in Section 4.1 Air Quality.

Biology and Hydrology and Water Quality: Inclusion of an option for a fish return system that discharges directly back into the Agua Hedionda Lagoon compliant with the recent changes to the Ocean Plan, results in new impacts to the lagoon from discharge and fill (pipeline and rip-

rap) with effects on marine biological resources in the lagoon and water quality of the lagoon, which could ~~potentially be a substantial increase in~~ the severity of impacts compared to those shown in the FEIR. These impacts could be substantial because they involve new physical effects in areas of the Agua Hedionda Lagoon previously not shown in the FEIR. This is analyzed in Section 4.2 Biological Resources and 4.4 Hydrology and Water Quality.

The inclusion of an alternative a fish return system that discharges to the existing EPS discharge pond would not result in any new impacts because the construction would be confined to a man-made structure and the discharge from the existing EPS fish screens is already returned to this location. This option is analyzed in Section 4.2 Biological Resources and 4.4 Hydrology and Water Quality.

Energy: The proposed CDP modifications and expanded capacity would result in an increase demand for, and change in the efficiency of, electricity under permanent standalone conditions.. This increase is beyond that considered in the FEIR and could potentially substantially increase the severity of energy impacts. These impacts could be substantial because they involve a 8.9 MWh/h increase in the worst case maximum electricity demand and a 5.3 MWh/h increase in the current energy use at an average annual production of 50 mgd. This is analyzed in Section 4.5 Energy.

This SEIR addresses the minor additions or changes necessary so that the FEIR for the PDP and CDP is adequate for the proposed CDP modifications. It addresses increases in the severity of impacts associated with new components or operations that are not clearly (without analysis) minimal or are likely to affect impacts. The severity of impacts may increase substantially while the level of significance determination (no impact, less than significant, potentially significant) is not necessarily altered. This is consistent with the meaning of §15162(a)(1) "... due to the involvement of new significant environmental effects or a substantial increase in the severity of previously identified effects." [emphasis added]. The necessary topics have been determined through an initial study (Appendix S-A to this SEIR) and scoping process conducted by the Water Authority. As noted in the NOP, this SEIR addresses the following resource topics:

- Air quality
- Biological resources
- Greenhouse gas emissions
- Hydrology and water quality
- Energy*
- Growth inducement

*This SEIR includes an energy section that discusses whether or not the proposed CDP modifications would result in wasteful or inefficient use of energy. Consideration of the inefficient or wasteful use of energy is a requirement for EIRs, however it is not included in the Initial Study Checklist of Appendix G to CEQA guidelines. As such the topic was not identified as part of the Initial Study and identified in the NOP. The issue has been recognized as warranting evaluation by the Water Authority in analyzing the proposed CDP modifications and part of the rationale for preparation of this SEIR. Consistent with current standard practice, the topic is included in a separate Section (Section 4.5 Energy) of this SEIR.

Prior Environmental Review Process

On June 13, 2006, the City approved an amendment to the PDP for the EPS and certified the FEIR for the CDP. These actions provided the approvals to construct and operate an approximately 50 mgd annual average desalination plant and other appurtenant and ancillary water and support facilities to produce and deliver potable water to residents and businesses of San Diego County. The FEIR included an analysis of an “Operation of the Desalination Plant as a stand-alone facility separate from the EPS” (City of Carlsbad Resolution No. 2006-156). The FEIR analyses of an “Operation of Desalination Plant as a standalone facility – separate from EPS,” focused on Aesthetics, Air Quality, Marine Biology – brine discharge, Marine Biology – entrainment/impingement and Land Use. The conclusion was that a stand-alone 50 mgd desalination plant would not result in greater significant adverse impacts than the approved project. The PDP application was made jointly between Poseidon and Cabrillo. The CDP construction is now complete and is fully operational. The CDP is located on the EPS site, adjacent to the existing power plant, located immediately south of the Agua Hedionda Lagoon, within the City of Carlsbad. The CDP commenced operations in December 14, 2015.

Between the time that the FEIR was certified and when the CDP was constructed, the project was modified, and these minor modifications were addressed in four separate Addenda to the FEIR. The First Addendum was approved by the City and remaining Addenda were approved by the Water Authority. The First Addendum documented changes to the footprint of the desalination plant and off-site water conveyance facilities (September 15, 2009). The Second Addendum documented changes to the footprint associated with the Twin Oaks Valley Water Treatment Plant modifications, Pipeline 3 relining, aqueduct connection point modifications, Pipeline 4 modifications, and the Macario Canyon pipeline alignment modification and pumping well (November 29, 2012). The Third Addendum addressed minor changes to the Macario Canyon pipeline alignment and ancillary facilities of 2 to 4 feet aboveground on Faraday Avenue in Carlsbad (September 26, 2013). The Fourth Addendum addressed minor modifications to the approved off-site flow control and isolation valve buildings (July 9, 2014). The FEIR was updated with each of the addenda and is referred to herein as the “FEIR”. The baseline for

supplemental CEQA analysis herein is the existing operational CDP (including permit conditions, regulatory agencies mitigation requirements and owners' commitments to implement certain project design features, e.g., providing additional wetland acreage beyond mitigation requirement), under co-located conditions and temporary stand-alone conditions as a result of periods when the EPS is not in operation, which was analyzed in the FEIR.

The RWQCB issued NPDES Permit No. CA0109223, as amended for the CDP, on May 13, 2009. In doing so, the RWQCB found that no adverse effects on marine organisms would occur with average day effluent salinity concentrations in the discharge pond of 40 ppt or less.

The CCC approved a Coastal Development Permit for the CDP on August 6, 2008. After review of the CCC Board findings, CCC staff worked with Poseidon to develop the final language for the one of the permit conditions specifically that associated with the Marine Life Mitigation Plan (MLMP-) [See Section 3.1 Background and History]. The CCC subsequently provided final approval of the Coastal Development Permit with the revised condition language on December 10, 2008. The CCC required minimization measures of the CDP, including the MLMP, as part of their approval pursuant to the California Coastal Act. The measures are required as conditions of the CCC permit and not as mitigation to avoid or reduce below a level of significant any significant impact identified under CEQA. Also, as a condition of the Coastal Development Permit the CCC require the preparation of an Energy Minimization and Greenhouse Gas Reduction Plan, dated December 10, 2008. The plan includes identification of the amount of GHG [indirectly and directly] emitted, on-site and project-related reduction of GHG emissions, including a demonstration of energy efficiency, and the identification of mitigation options to offset any remaining GHG emissions.

2.2 NOTICING

Notice of Preparation

As stated in CEQA Guidelines Section 15163(c), "A supplement to an EIR shall be given the same kind of notice and public review as is given to draft EIR under Section 15087." In accordance with this section and Section 15082 of the CEQA Guidelines, the Water Authority released an NOP for a 38-day public review period, which was received and posted by the State Clearinghouse on September 21, 2015 (SCH#2015091060). The NOP identified the close of the public comment period as October 29, 2015. Public comment was received from the City of Carlsbad identifying necessary permits and agreements required by the City. No other public comments were received. The NOP also provided notice of a public scoping meeting held on October 1, 2015, in compliance with review procedures defined in CEQA Guidelines Sections 15082(c)(1) and 15206, for projects considered to be of statewide, regional, or area-wide

significance (includes all projects within the coastal zone). The public scoping meeting on October 1, 2015, was held at 1635 Faraday Avenue, Carlsbad, California 92008. Public attendees consisted of City planning staff.

Notice of Availability

This SEIR is available to the public for review in accordance with CEQA Guidelines Section 15087.2. A Notice of Availability (NOA) was released on April 13, 2016, starting the 45-day public review period for this Draft SEIR. Public review of this SEIR ends on May 28, 2016, 2016. Consistent with CEQA Guidelines Section 15163(d), this SEIR is circulated without the FEIR. However, the FEIR including Addenda is available at <http://www.sdcwa.org/environmental-impact-reports-and-mitigated-negative-declarations>.

2.3 REGULATORY CHANGES

Ocean Plan Amendment

On May 5, 2015, the State Water Resources Control Board (SWRCB) adopted revisions to the state's Ocean Plan that established requirements governing operations and ocean discharges from seawater desalination facilities. The Ocean Plan Amendment supports the use of ocean water as a reliable supplement to traditional water supplies while protecting marine life and water quality. It provides direction for regional water boards when permitting new or expanded discharges and/or intake structures, and provides specific implementation and monitoring and reporting requirements. Key parts of the Ocean Plan Amendment are as follows (SWRCB 2015):

- Define dimensions of a “brine mixing zone” (a zone where elevated salinities may cause marine life toxicity) beyond which Ocean Plan salinity receiving water requirements are applicable.
- Allow projects that are 80% constructed and have received a conditional California Water Code Section 13142.5(b) determination (at the time of adoption, which includes the CDP) to implement a brine mixing zone that extends a distance of 200 meters (656 feet) from the ~~effluent tunnel discharge point~~ EPS surface discharge channel.
- Require that receiving water salinity is not to exceed 2 ppt above ambient at the edge of the brine mixing dilution zone unless the RWQCB authorizes a facility-specific receiving water salinity limitation.
- Establish requirements under which the RWQCB may consider and approve a facility-specific receiving water salinity limitation of more than 2 ppt above ambient.

- Require use of the best combination of available site, design, technology, and mitigation measures to minimize the intake and mortality impacts to marine organisms.
- Establish monitoring and reporting requirements for assessing receiving water, benthic communities, and sediments to ensure that brine discharges do not cause adverse effects to marine life outside of the brine mixing zone.

The Ocean Plan Amendment requires new or expanded seawater desalination plants to use the best available site, design, technology, and mitigation measures feasible to minimize intake and mortality of all forms of marine life. Feasibility is defined in the Ocean Plan Amendments as being the same as that defined in Section 15364 of the CEQA Guidelines: as capable of being accomplished in a successful manner within a reasonable period of time, taking into account economic, environmental, social, and technological factors.

Assembly Bill 52

In September 2014, the Governor of California approved Assembly Bill 52 (AB 52), which requires lead agencies under CEQA to consult with California Native American tribes traditionally and culturally affiliated with the geographic area of the proposed project. Consultation must occur for all projects after July 1, 2015. In compliance with AB 52, the Water Authority initiated consultation with interested Native American tribes on September 18, 2015, after completing an initial assessment as to whether the available materials for the project were sufficient to begin the consultation and environmental review process.

Letters were sent to the Native American Heritage Commission asking which tribes should be contacted, and the San Luis Rey Band of Mission Indians was contacted directly pursuant to their request to be notified of all Water Authority projects in accordance with AB 52. The San Luis Rey Band of Mission Indians responded requesting a meeting, which was duly conducted. In attendance were Water Authority and Dudek staff, and tribal representatives Ms. Cami Majado and Mr. P.J. Stoneburner. The proposed CDP modifications and FEIR findings regarding cultural resources were discussed. Tribal representatives did not identify any tribal cultural resources within the project area. Construction will not occur within or adjacent to known cultural resource sites. As such, it is not anticipated that cultural resources (i.e., artifacts) will be discovered during construction.

Three other tribes also responded in writing to the Water Authority's request: the Pala Band of Mission Indians, who requested to be kept apprised of project progress and any changes and recommended approved cultural monitors be present during ground disturbing activities; the Rincon Band of Luiseño Indians, who requested continued consultation though identified they had no additional information; and the Soboba Band of Luiseño Indians, who identified they had

no additional information, requested that Native American monitors be present during ground-disturbing activities, and deferred to the San Luis Rey Band of Mission Indians.

As a result of the consultation, no significant cultural resources or tribal cultural resources are known or likely within the previously disturbed fill, no new conclusion is drawn, no analysis is necessary in the SEIR and impacts would remain less than significant. However, the Water Authority is committed to respecting the ~~tribe's~~tribes' request for Native American monitoring and will ensure that the project proponent, Poseidon, provides the opportunity to monitor soil stockpiles during construction.

AB 52 also requires that the CEQA Guidelines be amended to include analysis of tribal cultural resources by July 2016. Since the revisions to the CEQA Guidelines are not effective at this time and because no additional resources have been identified through the Native American tribal consultation process, no further analysis of this topic is necessary.

Senate Bill 97

Although several pieces of legislation have passed in California regarding climate change and GHG emissions (described in Section 4.3, Greenhouse Gas Emissions), the most directly consequential to the CEQA process is Senate Bill (SB) 97. SB 97 was expressly passed by California law makers to require analysis of GHG emissions as part of the CEQA process and required the development and adoption of amendments to the CEQA Guidelines to address GHG emissions. SB 97 became effective in March 2010. As a consequence of SB 97, this SEIR includes a section (Section 4.3) evaluating GHG emissions in accordance with the revised CEQA Guidelines for the proposed intake and discharge modifications and increased production capacity.

INTENTIONALLY LEFT BLANK

SECTION 3 PROJECT DESCRIPTION

The proposed CDP system modifications (proposed CDP modifications) to facilitate permanent stand-alone operation of the CDP consist of construction and operations of a new screening/fish-friendly pumping structure, a fish return system, auxiliary facilities. Additional processing improvements could potentially increase annual average production from the existing 50 mgd to 55 mgd in the future. As a permanent stand-alone facility, approximately a maximum of 299 mgd of seawater would be withdrawn from the lagoon: up to 127 mgd for processing by the CDP, approximately 171 mgd to 198 mgd for brine dilution to comply with the Ocean Plan receiving water limit for salinity, and approximately 1 mgd for screen wash and fish return. Up to 60 mgd of the diverted seawater would be converted to fresh water that is delivered to the Water Authority at the CDP property line. The remaining flow (up to 67 mgd) would be returned to the EPS discharge tunnel for blending with seawater prior to discharge to the Pacific Ocean. The discharge consists of brine produced by the reverse osmosis process (up to 60 mgd) and treated backwash water from the pretreatment filters (up to 7 mgd). The salinity of the discharge prior to dilution is approximately ~~6465~~ ppt (67 ppt with no backwash water included), whereas the average salinity of the seawater in the vicinity of the discharge tunnel is 33.5 ppt. Poseidon is proposing an initial dilution of the brine to 42 ppt or less prior to discharge to the ocean. This is accomplished by mixing the CDP discharge with approximately 171 mgd to 198 mgd of the seawater withdrawn from Agua Hedionda Lagoon to comply with the Ocean Plan receiving water limit for salinity. The combined CDP discharge and dilution water flow rate is approximately 238 mgd to 244 mgd. As compared to the existing project operations, the modified CDP operations described above would achieve a 10% average annual increase in fresh drinking water production while reducing the total quantity of seawater required for processing and brine dilution purposes.

3.1 BACKGROUND AND HISTORY

The proposed CDP modifications are limited in scope to addressing (1) those components associated with intake and discharge of the existing operational CDP in response to the EPS projected closure, the Ocean Plan Amendment, and the minimal improvements, and (2) improvements needed for an approximate annual average 5 mgd increase in production capacity. Furthermore, the options for the modifications are constrained by the existing infrastructure and the expressed limitation of Chapter III.M of the Ocean Plan Amendment. The Ocean Plan Amendment requires new or expanded seawater desalination plants to use the best available site, design, technology, and mitigation measures feasible to minimize intake and mortality of all forms of marine life. Following those requirements, Poseidon conducted an evaluation of the feasibility of design and technology alternatives to determine the best available design and

technology for modifications to minimize intake and mortality that take into consideration site constraints. In this instance the evaluation of alternative sites is foregone because the CDP is now in operation and the selected site benefits from the existing EPS operation currently and EPS infrastructure once EPS closes.

An alternatives analysis is not required in an SEIR, and there is no rationale to include such an evaluation in the SEIR as no significant impacts are identified in the SEIR or FEIR that would be avoided or reduced by the suggested alternative intake/discharge technologies when compared to that for the proposed modifications. However, in response to the RWQCB, the approaches considered for achieving the intake and discharge modifications are summarized below and a detailed review is provided in the Intake/Discharge Feasibility Report Study (Appendix B of the 2015-Submittal to RWQCB) and the Addendum to the Intake/Discharge Feasibility Report (Appendix II of the Submittal to RWQCB). These reports are incorporated by reference herein and is-are available at the Water Authority's offices at 4667 Overland Avenue, San Diego California 92123 and online at <http://www.sdcwa.org/environmental-impact-reports-and-mitigated-negative-declarations>.

Summary of Intake/Discharge Alternatives Considered

The Applicant prepared an Intake/Discharge Alternatives Feasibility Report and an Addendum to the Intake/Discharge Alternatives Feasibility Report (Appendix B and Appendix II, respectively to the Submittal to the RWQCB) to determine the best available site, design, technologies, and mitigation feasible to minimize intake and mortality of all forms of marine life while transitioning the CDP to long term stand-alone operation and increasing plant production to capture recent improvements in the reverse osmosis technology installed at the CDP. This evaluation relied on the definition of "feasible" set forth in the Ocean Plan Amendment:

"FEASIBLE for the purposes of chapter 111.M. shall mean "capable of being accomplished in a successful manner within a reasonable period of time, taking into account economic, environmental, social and technological factors"

CEQA and the Coastal Act also use this definition of "feasible" (Public Resources Code § 21061.1 and § 30108, respectively). The CDP Intake/Discharge Feasibility Study (Appendix B to the Submittal to the RWQCB) and the CDP Intake/Discharge Study Addendum (Appendix II to the Submittal to the RWQCB) considered each of the five feasibility criteria for 10 combinations of intake/discharge technologies. The intake/discharge technologies evaluated in the Feasibility Study and Addendum include:

1. Surface Screened Intake with Flow Augmentation

2. Surface Screened Intake with Multiport Diffuser
3. Subsurface Intake with Flow Augmentation
4. Subsurface Intake with Multiport Diffuser
5. Offshore Wedgewire Screen with Flow Augmentation
6. Offshore Wedgewire Screen with Multiport Diffuser
7. Lagoon Wedgewire Screen with Flow Augmentation
8. Lagoon Wedgewire Screen with Diffuser
9. Lagoon Traveling Screen with Flow Augmentation
10. Lagoon Traveling Screen with Diffuser Offshore Wedgewire Screen with Diffuser

The results of the Feasibility Study and Addendum are summarized in Table 3-1 below (Overall Feasibility Assessment).

The Feasibility Study concluded that the screened intake with discharge flow augmentation (proposed modifications) is the only feasible intake/discharge technology for the CDP when it begins long-term, stand-alone operation. When compared to the other alternative technologies, the proposed modifications were found to result in marginally higher marine life mortality (99.8 acres) than the two lowest ranked alternatives - Subsurface Intake with Flow Augmentation and Lagoon Wedgewire Screen with Flow Augmentation (Table 3-2 Comparison of Marine Life Mortality Impacts). These were found to be infeasible as described below:

Subsurface Intake with Flow Augmentation

The alternative using the subsurface intake with flow augmentation was found to have the lowest marine life mortality impacts (87.5 acres). However, the subsurface intake with flow augmentation was found to be infeasible with respect to the other four criteria, (1) economically infeasible (capital cost of \$1,037 million and total annual cost of \$159 million) (2) longest implementation period (10.2 years) resulting in \$424 million in the loss of fixed capital and fixed operating costs (debt and equity payments, plant maintenance, utility charges) not recovered while the plant is out of service; (3) technically infeasible due to the physical size of the subsurface intake, associated interconnecting piping and pump stations, and (4) socially infeasible due extensive impacts to the marine resources and recreational in Agua Hedionda Lagoon.

Lagoon Wedgewire Screen with Flow Augmentation

The alternative using the lagoon wedgewire screen with flow augmentation was found to have the next lowest marine life mortality impacts (99.6 acres). However, the lagoon wedgewire screen with flow augmentation was found to be infeasible with respect to three criteria, (1) economically infeasible (capital cost of \$126 million and total annual cost of \$34 million) (2) implementation period (6 years) resulting in \$200 million in the loss of fixed capital and fixed operating costs (debt and equity payments, plant maintenance, utility charges) not recovered while the plant is out of service; and (3) technically infeasible due to the lack of sweeping currents in the lagoon which are necessary to prevent fouling of the screen.

When calculated per the requirements set forth in the Ocean Plan, the marine life mortality impact associated with the alternatives ranged from 87.5 acres to 123.1 acres. The proposed modifications would impact 99.8 acres prior to mitigation (lowest impact after elimination of the subsurface intake with flow augmentation and the lagoon wedgewire screen with flow augmentation). In terms of time required for project completion, the alternatives ranged from 2.5 years (proposed modifications) to 10.2 years (subsurface intake with flow augmentation), with the proposed modifications requiring less than half the implementation period of the next closest alternative (Table 3-3) Comparison of Time Required for Project Completion). The potential delay costs (the fixed capital and fixed operating costs not recovered while the CDP was out of service) associated with the CDP potentially losing access to source water if the timeline for project completion extend beyond 2018, ranged from \$0 for the proposed modifications to \$424 million for the subsurface intake with flow augmentation.

Lastly, in terms of economic impacts, a detailed analysis of the life-cycle cost for the CDP subsurface intake/discharge alternatives is presented in Appendix OO of the Submittal to the RWQCB. The findings of this analysis are included in Table 3-4 (Economic Analysis of Intake/Discharge Alternatives). The life cycle costs provide a relative comparison of the net incremental cost and savings of each of the alternatives. Costs considered include permitting, design, land acquisition, financing, construction, operations, maintenance, mitigation, equipment replacement, insurance, taxes, management, and energy consumption over the lifetime of the facility and fixed capital and operating costs not recovered while the plant is out of service after 2018. Savings considered include construction and operating allowances that are applicable to each of the alternatives and operational savings due reduced chemical consumption, extended membrane life, and reduced membrane cleaning frequency that is applicable to the subsurface intake alternatives.

The findings of the economic analysis indicate that \$94 million would need to be added to the annual operating budget of the CDP to pay for the capital and operating costs associated with seafloor infiltration galleries (SIG) with the multiport diffuser alternative and \$159 million would need to be added to the annual operating budget of the CDP to pay for the capital and operating costs associated with the SIG with flow augmentation alternative. The primary difference between these figures and the lifecycle costs of these alternatives shown in Appendix B is the inclusion of the fixed capital and operating costs not recovered while the plant is out of service after 2018.

Chapter III.M of the Ocean Plan provides the following guidance for assessing the feasibility of subsurface intakes:

Subsurface intakes shall not be determined to be economically infeasible solely because subsurface intakes may be more expensive than surface intakes. Subsurface intakes may be determined to be economically infeasible if the additional costs or lost profitability associated with subsurface intakes, as compared to surface intakes, would render the desalination facility not economically viable.

Therefore, the RWQCB's determination of the economic feasibility of the intake/discharge alternatives turns on the basis of whether the additional costs or lost profitability associated with these alternatives would render the desalination facility not economically viable. One measure of economic viability is whether the anticipated plant revenues would cover cost of one or more of the intake/discharge alternatives.

The annual costs would be approximately \$94 million per year for the subsurface intake with a multiport diffuser and approximately \$159 million per year for the subsurface intake with flow augmentation. Absent an additional source of revenue, the SIG alternatives are economically infeasible.

The economic analysis summarized in Table 3-4 indicates that approximately \$8 million would need to be added to the annual operating budget of the CDP to pay for the capital and operating costs associated with proposed surface water intake with flow augmentation. The annual cost of the other intake/discharge alternatives under consideration (WWS and lagoon based intakes with flow augmentations or diffuser) range from \$29 million to \$76 million, rendering these alternatives economically infeasible.

Since the all of the alternative intake/discharge configurations were either found to be infeasible or resulted in greater marine life impacts than the proposed intake/discharge modifications, the

opportunity for incorporating the alternative intake/discharge configurations will not be considered any further in the SEIR.

Table 3-1
Overall Feasibility Assessment Intake and Discharge Alternatives

	<u>Project Capable of Being Accomplished in a Reasonable Period of Time?</u>	<u>Is Project Economically Feasible?</u>	<u>Marine Life Mortality Ranking</u>	<u>Socially Feasible</u>	<u>Technically Feasible</u>	<u>Overall Feasibility</u>
<u>Alternatives</u>	<u>Yes/No</u>	<u>Yes/No</u>	<u>Ranked Lowest to Highest Impact</u>	<u>Yes/No</u>	<u>Yes/No</u>	<u>Yes/No</u>
<u>Surface Screened Intake with Flow Augmentation</u>	<u>Yes</u>	<u>Yes</u>	<u>3</u>	<u>Yes</u>	<u>Yes</u>	<u>Yes</u>
<u>Surface Screened Intake with Multiport Diffuser</u>	<u>No</u>	<u>No</u>	<u>7</u>	<u>Yes</u>	<u>Yes</u>	<u>No</u>
<u>Subsurface Intake with Flow Augmentation</u>	<u>No</u>	<u>No</u>	<u>1</u>	<u>No</u>	<u>No</u>	<u>No</u>
<u>Subsurface Intake with Multiport Diffuser</u>	<u>No</u>	<u>No</u>	<u>6</u>	<u>No</u>	<u>Yes</u>	<u>No</u>
<u>Offshore Wedgewire Screen with Flow Augmentation</u>	<u>No</u>	<u>No</u>	<u>5</u>	<u>Yes</u>	<u>Yes</u>	<u>No</u>
<u>Offshore Wedgewire Screen with Diffuser</u>	<u>No</u>	<u>No</u>	<u>10</u>	<u>Yes</u>	<u>Yes</u>	<u>No</u>
<u>Lagoon Wedgewire Screen with Flow Augmentation</u>	<u>No</u>	<u>No</u>	<u>2</u>	<u>Yes</u>	<u>No</u>	<u>No</u>
<u>Lagoon Wedgewire Screen with Diffuser</u>	<u>No</u>	<u>No</u>	<u>8</u>	<u>No</u>	<u>Yes</u>	<u>No</u>

Table 3-1
Overall Feasibility Assessment Intake and Discharge Alternatives

	<u>Project Capable of Being Accomplished in a Reasonable Period of Time?</u>	<u>Is Project Economically Feasible?</u>	<u>Marine Life Mortality Ranking</u>	<u>Socially Feasible</u>	<u>Technically Feasible</u>	<u>Overall Feasibility</u>
<u>Lagoon Traveling Screen with Flow Augmentation</u>	<u>No</u>	<u>No</u>	<u>4</u>	<u>Yes</u>	<u>Yes</u>	<u>No</u>
<u>Lagoon Traveling Screen with Diffuser</u>	<u>No</u>	<u>No</u>	<u>9</u>	<u>Yes</u>	<u>Yes</u>	<u>No</u>

Table 3-2
Comparison of Marine Life Mortality Impacts at Maximum Production of 60 mgd Feasibility Assessment Intake and Discharge Alternatives

<u>Impacts</u>	<u>Intake Water Potentially Exposed to 100% Mortality</u>	<u>Flow Augmentation Water Potentially Exposed to 100% Mortality</u>	<u>Diffuser Water Potentially Exposed to 100% Mortality</u>	<u>Total Water Potentially Exposed to 100% Mortality</u>	<u>Area of Production Foregone</u>	<u>Brine Mixing Zone @ 35.5 ppt</u>	<u>Permanent Construction Impacts to Marine Environment</u>	<u>Total Area Impacted</u>	<u>Marine Life Mortality Ranking</u>
<u>Alternatives</u>	<u>MGD</u>	<u>MGD</u>	<u>MGD</u>	<u>MGD</u>	<u>Acres</u>	<u>Acres</u>	<u>Acres</u>	<u>Acres</u>	<u>Ranked Lowest to Highest</u>
<u>Surface Screened Intake with Flow Augmentation</u>	<u>128</u>	<u>171</u>	<u>0</u>	<u>299</u>	<u>84.3</u>	<u>15.5</u>	<u>0</u>	<u>99.8</u>	<u>3</u>
<u>Surface Screened Intake with Multiport Diffuser</u>	<u>128</u>	<u>0</u>	<u>217</u>	<u>345</u>	<u>103.3</u>	<u>14.4</u>	<u>1.5</u>	<u>118.9</u>	<u>7</u>
<u>Subsurface Intake with Flow Augmentation</u>	<u>0</u>	<u>0</u>	<u>0</u>	<u>0</u>	<u>0</u>	<u>15.5</u>	<u>72</u>	<u>87.5</u>	<u>1</u>

Table 3-2
Comparison of Marine Life Mortality Impacts at Maximum Production of 60 mgd
Feasibility Assessment Intake and Discharge Alternatives

<u>Impacts</u>	<u>Intake Water Potentially Exposed to 100% Mortality</u>	<u>Flow Augmentation Water Potentially Exposed to 100% Mortality</u>	<u>Diffuser Water Potentially Exposed to 100% Mortality</u>	<u>Total Water Potentially Exposed to 100% Mortality</u>	<u>Area of Production Foregone</u>	<u>Brine Mixing Zone @ 35.5 ppt</u>	<u>Permanent Construction Impacts to Marine Environment</u>	<u>Total Area Impacted</u>	<u>Marine Life Mortality Ranking</u>
<u>Subsurface Intake with Multiport Diffuser</u>	<u>0</u>	<u>0</u>	<u>217</u>	<u>217</u>	<u>67</u>	<u>14.4</u>	<u>33</u>	<u>114.4</u>	<u>6</u>
<u>Offshore Wedgewire Screen with Flow Augmentation</u>	<u>127</u>	<u>171</u>	<u>0</u>	<u>298</u>	<u>92</u>	<u>15.5</u>	<u>2.0</u>	<u>109.5</u>	<u>5</u>
<u>Offshore Wedgewire Screen with Diffuser</u>	<u>127</u>	<u>0</u>	<u>217</u>	<u>344</u>	<u>106.2</u>	<u>14.4</u>	<u>2.5</u>	<u>123.1</u>	<u>10</u>
<u>Lagoon Wedgewire Screen with Flow Augmentation</u>	<u>127</u>	<u>171</u>	<u>0</u>	<u>298</u>	<u>84</u>	<u>15.5</u>	<u>0.1</u>	<u>99.6</u>	<u>2</u>
<u>Lagoon Wedgewire Screen with Diffuser</u>	<u>127</u>	<u>0</u>	<u>217</u>	<u>344</u>	<u>103</u>	<u>14.4</u>	<u>1.6</u>	<u>119.0</u>	<u>8</u>
<u>Lagoon Traveling Screen with Flow Augmentation</u>	<u>128</u>	<u>171</u>	<u>0</u>	<u>299</u>	<u>84.3</u>	<u>15.5</u>	<u>0.1</u>	<u>99.9</u>	<u>4</u>
<u>Lagoon Traveling Screen with Diffuser</u>	<u>128</u>	<u>0</u>	<u>217</u>	<u>345</u>	<u>103.3</u>	<u>14.4</u>	<u>1.6</u>	<u>119.3</u>	<u>9</u>

Table 3-3
Comparison of Time Required for Project Completion
Feasibility Assessment Intake and Discharge Alternatives

	<u>Permitting and Property Acquisition</u>	<u>Construction, Commissioning and Startup</u>	<u>Total Time Required for Project Completion</u>	<u>Potential Duration CDP Is Without Source Water After 2018</u>	<u>Fixed Capital and Operating Costs Not Recovered While Plant is Out of Service After 2018</u>	<u>Project Capable of Being Accomplished in a Reasonable Period of Time?</u>
<u>Alternatives</u>	<u>Years</u>	<u>Years</u>	<u>Years</u>	<u>Years</u>	<u>\$</u>	<u>Yes/No</u>
<u>Surface Screened Intake with Flow Augmentation</u>	<u>1</u>	<u>1.5</u>	<u>2.5</u>	<u>0</u>	<u>\$0</u>	<u>Yes</u>
<u>Surface Screened Intake with Multiport Diffuser</u>	<u>3</u>	<u>3</u>	<u>6</u>	<u>3.5</u>	<u>\$199,925,313</u>	<u>No</u>
<u>Subsurface Intake with Flow Augmentation</u>	<u>3</u>	<u>7.2</u>	<u>10.2</u>	<u>7.7</u>	<u>\$423,770,193</u>	<u>No</u>
<u>Subsurface Intake with Multiport Diffuser</u>	<u>3</u>	<u>3.8</u>	<u>6.8</u>	<u>4.3</u>	<u>\$242,696,411</u>	<u>No</u>
<u>Offshore Wedgewire Screen with Flow Augmentation</u>	<u>3</u>	<u>3</u>	<u>6</u>	<u>3.5</u>	<u>\$199,925,313</u>	<u>No</u>
<u>Offshore Wedgewire Screen with Diffuser</u>	<u>3</u>	<u>3</u>	<u>6</u>	<u>3.5</u>	<u>\$199,925,313</u>	<u>No</u>
<u>Lagoon Wedgewire Screen with Flow Augmentation</u>	<u>3</u>	<u>3</u>	<u>6</u>	<u>3.5</u>	<u>199,925,313</u>	<u>No</u>
<u>Lagoon Wedgewire Screen with Diffuser</u>	<u>3</u>	<u>3</u>	<u>6</u>	<u>3.5</u>	<u>\$199,925,313</u>	<u>No</u>

Table 3-3
Comparison of Time Required for Project Completion
Feasibility Assessment Intake and Discharge Alternatives

	<u>Permitting and Property Acquisition</u>	<u>Construction, Commissioning and Startup</u>	<u>Total Time Required for Project Completion</u>	<u>Potential Duration CDP Is Without Source Water After 2018</u>	<u>Fixed Capital and Operating Costs Not Recovered While Plant is Out of Service After 2018</u>	<u>Project Capable of Being Accomplished in a Reasonable Period of Time?</u>
<u>Lagoon Traveling Screen with Flow Augmentation</u>	<u>3</u>	<u>3</u>	<u>6</u>	<u>3.5</u>	\$199,925,313	<u>No</u>

Table 3-4
Economic Analysis
Feasibility Assessment Intake and Discharge Alternatives

	<u>Total Project Cost</u>	<u>Fixed Capital and Operating Costs Not Recovered While Plant is Out of Service After 2018</u>	<u>Financing Period</u>	<u>Capital Charge</u>	<u>Out of Service Charge</u>	<u>O&M and Other Annual Costs</u>	<u>Total Annual Cost</u>	<u>Is Project Economically Feasible?</u>
<u>Alternatives</u>	<u>\$</u>	<u>\$</u>	<u>Years</u>	<u>\$/Year</u>	<u>\$/Year</u>	<u>\$/Year</u>	<u>\$/Year</u>	<u>Yes/No</u>
Surface Screened Intake with Flow Augmentation	\$49,061,041	\$0	27.5	\$4,077,205	\$0	\$4,455,035	\$8,532,239	Yes
Surface Screened Intake with Multiport Diffuser	\$428,639,220	\$199,925,313	24	\$37,464,471	\$17,481,175	\$6,790,828	\$61,736,474	No
Subsurface Intake with Flow Augmentation	\$1,037,702,060	\$423,770,193	19.8	\$100,112,270	\$37,988,099	\$20,965,196	\$159,065,565	No
Subsurface Intake with Multiport Diffuser	\$676,862,341	\$242,696,411	23.2	\$59,971,724	\$21,509,330	\$12,903,385	\$94,384,439	No
Offshore Wedgewire Screen with Flow Augmentation	\$285,490,487	\$199,925,313	24	\$24,952,799	\$17,481,175	\$6,566,746	\$49,000,720	No
Offshore Wedgewire Screen with Diffuser	\$576,823,886	\$199,925,313	24	\$50,416,311	\$17,481,175	\$8,211,320	\$76,108,807	No
Lagoon Wedgewire Screen with Flow Augmentation	\$126,904,462	\$199,925,313	24	\$11,100,609	\$17,481,175	\$5,246,746	\$33,828,529	No
Lagoon Wedgewire Screen with Diffuser	\$416,573,734	\$199,925,313	24	\$36,409,907	\$17,481,175	\$6,781,320	\$60,672,403	No

Table 3-4
Economic Analysis
Feasibility Assessment Intake and Discharge Alternatives

	<u>Total Project Cost</u>	<u>Fixed Capital and Operating Costs Not Recovered While Plant is Out of Service After 2018</u>	<u>Financing Period</u>	<u>Capital Charge</u>	<u>Out of Service Charge</u>	<u>O&M and Other Annual Costs</u>	<u>Total Annual Cost</u>	<u>Is Project Economically Feasible?</u>
<u>Lagoon Traveling Screen with Flow Augmentation</u>	\$80,783,075	\$199,925,313	24	\$7,060,814	\$17,481,175	\$4,960,539	\$29,502,528	No
<u>Lagoon Traveling Screen with Diffuser</u>	\$405,778,290	\$199,925,313	24	\$35,466,357	\$17,481,175	\$6,719,356	\$59,666,888	No

As part of the permitting process for the transition to stand-alone operations, the RWQCB requested that the EWA be consulted to determine the feasibility of comingling the discharge from the CDP with treated wastewater from the Encina Water Pollution Control Facility (Encina WPCF) and discharging the combined flow to the ocean via the Encina Ocean Outfall. The Applicant is assessing the opportunity for co-mingling a portion of the CDP discharge with municipal wastewater in the Encina Ocean Outfall. Through this assessment, the Encina Wastewater Authority (EWA) confirmed that outfall is not able to accept the CDP discharge during large storm events. Such events significantly increase the quantity of treated wastewater that is processed at the Encina WPCF, leaving no excess capacity in the outfall for the CDP discharge. According to EWA, such events can last up to two weeks.

As a result of these limitations, comingling the discharge from the CDP with treated wastewater from the Encina WPCF and discharging the combined flow to the ocean via the Encina Ocean Outfall does not reduce or eliminate the need for the proposed intake/discharge modifications. Therefore, this discharge alternative will not be considered any further in the SEIR. An alternatives analysis is not required in an SEIR, and as no significant impacts are identified in the SEIR or FEIR that would be avoided or reduced by the suggested alternative intake/discharge technologies when compared to that for the proposed modifications. There is no rationale to include such an evaluation in the SEIR.

The Water Authority has reviewed the Feasibility ~~Report~~Study and the Addendum thereto and determined that the selected design is the best available design and technology feasible for the CDP under stand-alone conditions, and that environmental impacts associated with any of the possible designs would be reduced compared to the existing conditions with the CDP and EPS in operation. ~~Ten~~~~Four~~ designs and technologies to intake and discharge modifications for the CDP are identified and evaluated in the Feasibility Study. Based on that analysis, the Surface Screened Intake with Flow Augmentation Design and Technology maximizes use of existing structural facilities within the smallest footprint feasible and, thus, minimizes permanent constructed components within the lagoon, avoids permanent constructed components on the seafloor, and uses technology that minimizes mortality for fish and fish larvae.

The best available mitigation measures are already established through permit conditions for the CDP. Although the FEIR found no significant impacts on marine organisms from either the intake or discharge effects of the existing CDP, both the RWQCB and the CCC required minimization measures as part of their CDP permit approvals pursuant to the Clean Water Act and California Coastal Act, respectively. While these permit conditions are not mitigation to avoid or reduce any significant impact identified under CEQA, the conditions do provide for increased minimization of CDP impacts on marine water quality and marine organisms, and are consistent with the guidance for assessing entrainment effects contained in Appendix E of the

staff report to the Ocean Plan Amendments (available at http://www.swrcb.ca.gov/water_issues/programs/ocean/desalination/docs/amendment/150424_appendix_e.pdf).

Both agencies required and approved the CDP Marine Life Mitigation Plan (MLMP), which sets forth a plan for offsetting entrainment impacts and monitoring as a means of complying with California Water Code 13142.5(b). It was developed by Poseidon in consultation with multiple resource agencies, including the RWQCB, and was approved by the CCC on August 6, 2008. CCC staff worked with Poseidon, and the final revised language for the MLMP was approved by the CCC on December 10, 2008. The MLMP was written for long-term stand-alone operation and includes phased implementation of up to 66.4 acres of wetland mitigation. (This includes 11 acres that Poseidon has voluntarily committed to provide to address potential impingement impacts under temporary stand-alone operation. With the proposed CDP modifications in place, the impingement impacts would be avoided altogether.) Poseidon entered into a Memorandum of Understanding with the U.S. Fish and Wildlife Service (USFWS) to locate the wetlands restoration project in the San Diego National Wildlife Refuge Complex at the south end of San Diego Bay (Appendix V of the 2015 Submittal to RWQCB). Since 2010, Poseidon, USFWS, RWQCB, and the CCC's Science Advisory Panel have been working to advance the planning, permitting, and design of the wetlands restoration project. The MLMP further offsets intake-related marine life mortality by including restoration and creation of habitat based on the "area of production foregone" acreage calculated for the CDP with incorporation of the proposed modifications.

3.2 PROJECT LOCATION

The CDP is located on the EPS site, adjacent to the existing power plant, located immediately south of the Agua Hedionda Lagoon, within the City of Carlsbad, in northern San Diego County (Figure 1). The facility address is 4590 Carlsbad Boulevard, Carlsbad, California 92008. The CDP intake and discharge system modification is located between the existing CDP intake pump station and the EPS intake tunnel (Figure 2).

3.3 ENVIRONMENTAL SETTING

After certification of the FEIR and issuance of all necessary approvals and permits, the CDP was constructed and is now operational. The CDP is co-located with the currently operational EPS, meaning that the feedwater for the CDP is currently drawn from the EPS discharge, and concentrated brine from the CDP mixes with discharge from the EPS prior to discharge into the Pacific Ocean as summarized in Table 1-1.

In addition to the FEIR mitigation measures, the RWQCB and the CCC required minimization measures for marine life impacts as part of their CDP approvals pursuant to the Clean Water Act

and California Coastal Act, respectively, as discussed in Section 3.1. Specifically, “Special Condition” #8 required in the Coastal Development Permit (No. E-06-013 by the CCC approved on November 15, 2007, and revised November 2008), required the following:

8) Marine Life Mitigation Plan: PRIOR TO ISSUANCE OF THE PERMIT, the Permittee shall submit to and obtain from the Commission approval of a Marine Life Mitigation Plan (the Plan) that complies with the following:

- a) Documentation of the project’s expected impacts to marine life due to entrainment and impingement caused by the facility’s intake of water from Agua Hedionda Lagoon. This requirement can be satisfied by submitting a full copy of the Permittee’s Entrainment Study conducted in 2004-2005 for this project.
- b) To the maximum extent feasible, the mitigation shall take the form of creation, enhancement, or restoration of aquatic and wetland habitat.
- c) Goals, objectives and performance criteria for each of the proposed mitigation sites. It shall identify specific creation, restoration, or enhancement measures that will be used at each site, including grading and planting plans, the timing of the mitigation measures, monitoring that will be implemented to establish baseline conditions and to determine whether the sites are meeting performance criteria. The Plan shall also identify contingency measures that will be implemented should any of the mitigation sites not meet performance criteria.
- d) Requires submittals of “as-built” plans for each site and annual monitoring reports for no less than five years or until the sites meet performance criteria.
- e) Defines legal mechanism(s) proposed to ensure permanent protection of each site – e.g., conservation easements, deed restriction, or other methods.

The Permittee shall comply with the approved Plan. Prior to implementing the Plan, the Permittee shall submit a proposed wetlands restoration project that complies with the Plan in the form of a separate coastal development permit application for the planned wetlands restoration project.

The actual physical conditions for current operations of the CDP involve use of the EPS discharge for both production and dilution water. The regulatory permitting process for the EPS under Clean Water Act Section 316(b) assumed that nearly all marine organisms are killed by the thermal and physical effects of the EPS once-through-cooling process and required applicable mitigation. However, as noted earlier, in their actions to permit the CDP, the RWQCB and CCC attributed all effects on marine organisms associated with withdrawal of 304 mgd of seawater to

the CDP (“long term stand-alone operations”). Therefore, the operational baseline assumption for the CDP with respect to marine life effects includes use of 304 mgd of seawater and compensation for the loss of marine organisms equivalent to direct withdrawal of the 304 mgd of seawater from Agua Hedionda Lagoon.

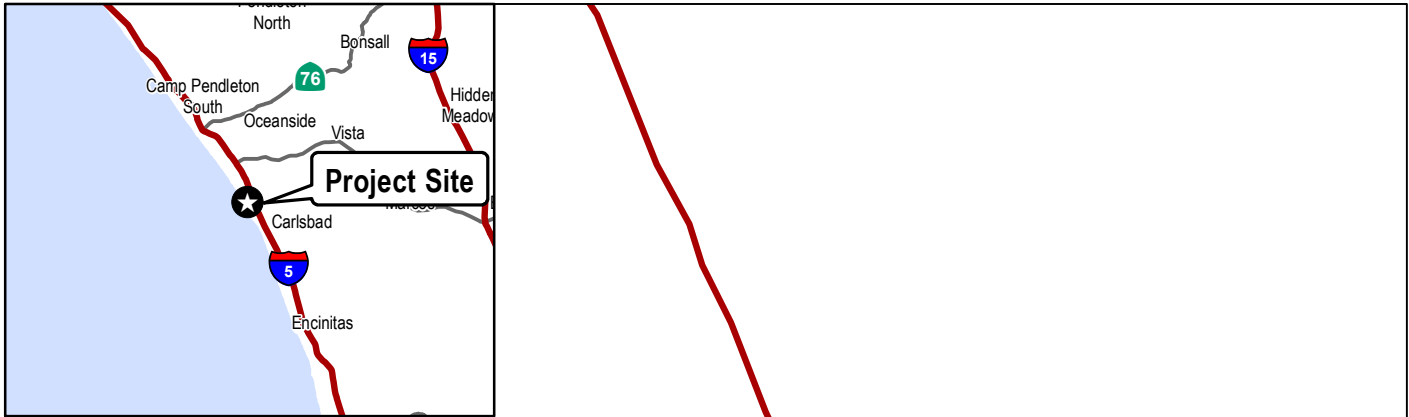

Project Site



0 1,000 2,000
Feet



Modified Intake Boundary

SOURCE: USGS 7.5-Minute Series - San Luis Ray Quadrangle.

FIGURE 1
Regional Vicinity Map

8426

Carlsbad Desal SEIR

INTENTIONALLY LEFT BLANK

- Existing EPS trash rack and intake
- Fish Return System
- Alternate Fish Return System
- Existing SWRO Pump Station
- New Screening/Fish-friendly Pumping Structure

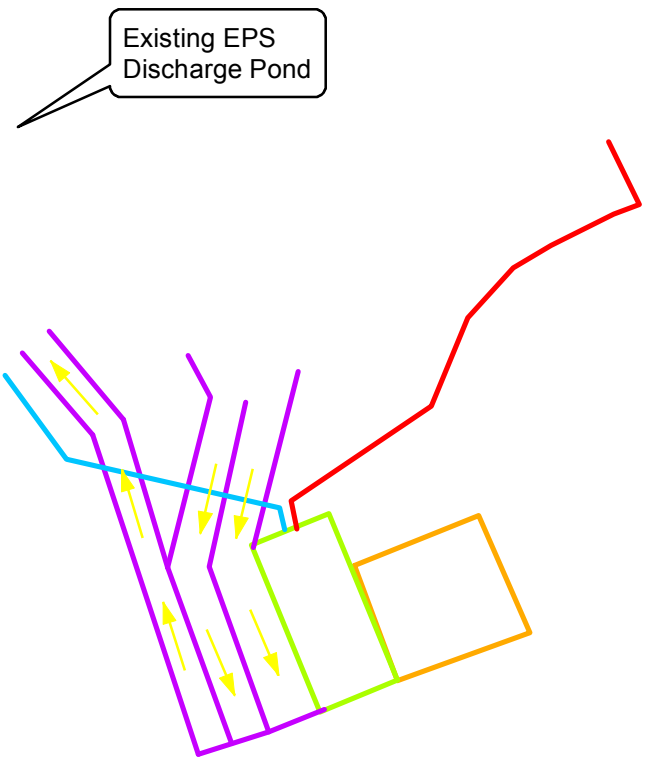

Existing EPS Discharge Pond

Existing EPS Ocean Outfall

INTENTIONALLY LEFT BLANK

3.4 PROJECT MODIFICATIONS

The proposed CDP modifications consist of changes to the project that was analyzed in the FEIR (and associated addenda), and that is currently constructed and operating. The changes involve construction of a new screening/fish-friendly pumping structure with a fish return system, auxiliary facilities, and minimal improvements to the plant, as further described below. The proposed CDP modifications would create a modified intake and discharge layout requiring physical modifications to facilities within the PDP area (Figures 3 and 4). Table 1-1 summarizes the components of the CDP as approved in the FEIR and currently operating, the modifications to those components, and the difference in operation between existing conditions and proposed operational conditions. This section presents an overall description of the project by summarizing the basic project characteristics associated with the CDP intake and discharge system modifications to meet Ocean Plan Amendment requirements; during interim CDP operations following decommissioning of the EPS while the modifications are under construction and permanent stand-alone operational changes once the modifications are complete, due to the permanent decommissioning of the EPS once through cooling water system, as well as and the potential increase in production capacity available due to improved reverse osmosis membrane technology. This SEIR provides an evaluation of the impacts of the proposed CDP modifications compared to those of the approved, and now constructed, CDP.

The CDP process water would pass through traveling screens equipped with a fish capture and return system. The screens are designed to minimize impingement mortality and reduce entrainment mortality through the use of 1-millimeter (mm) slot openings, and a through-screen velocity of less than 0.5 feet per second. After screening, the existing intake pump station would continue to deliver the process water to the CDP for processing through the pre-treatment and reverse osmosis membrane desalination system. Approximately half the water volume processed by the CDP would leave the CDP as potable drinking water, and the other half would be concentrated seawater with approximately twice the original intake water salinity.

The EPS is currently scheduled to suspend operation of the existing generating units in 2017. The intake and discharge modifications will not be operational by this date. The proposed modifications and the operations of the CDP following closure of the EPS while the modifications are under construction would be consistent with the periodic non-operation of EPS included in the FEIR (temporary stand-alone mode of operation). The Applicant is working with the owner of the EPS to ensure the EPS cooling water pumps will continue to be available to provide seawater for CDP operations until the intake and discharge modifications are operational. The NPDES Report of Waste Discharge submitted by the Applicant proposed that during this interim period, the CDP would continue to operate in the temporary stand-alone mode of operation as described in Table 3-5. Once the intake and discharge modifications are complete, the CDP would transition to permanent stand-

alone operating conditions. The CDP will comply with the Ocean Plan receiving water limitation (daily maximum of 2.0 parts per thousand (ppt) above natural background salinity measured at the edge of the brine mixing zone 200 meters (656 ft.) away from the points of discharge) while operating in both temporary and permanent stand-alone configurations.

Table 3-5
Summary of CDP Intake, Production and Discharge Flows
Temporary and Permanent Stand-Alone Operating Conditions

Parameter		Temporary Stand-Alone Operating Conditions (to be continued until the intake and discharge modifications are complete)		Permanent Stand-Alone Operating Conditions (Following completion of intake and discharge modifications)	
		Average Daily Flow	Maximum Daily Flow	Annual Average Flow	Maximum Daily Flow
Potable water production capacity		50 mgd	54 mgd	55 mgd	Up to 60 mgd
Intake Flows	Intake from EPS Lagoon Intake Structure	304	324	NA	NA
	Intake from CDP Lagoon Intake Structure	NA	NA	Up to 299 mgd	299 mgd
Discharge Flows	Granular Media Filtration Backwash	4 mgd	6 mgd	Up to 7 mgd	Up to 7 mgd
	RO concentrate	50 mgd	54 mgd	Up to 60 mgd	Up to 60 mgd
	Screen wash/fish return from CDP Intake	NA	NA	1 mgd	1 mgd
	CDP flow augmentation	NA	NA	Up to 198 mgd	Up to 198 mgd
	EPS minimum dilution flow	200 mgd	210 mgd	NA	NA
Total Discharge		254 mgd	270 mgd	Up to 244 mgd	Up to 244 mgd

Under permanent stand-alone operating conditions, ~~Up to 299~~ 74 mgd of seawater would be drawn into the new screening/fish-friendly pumping structure for processing by the desalination facility and dilution of the ~~and would be mixed with the CDP concentrated seawater byproduct~~ of the desalination process prior discharge to the ocean. ~~Both the process and the~~ This dilution water would pass through travelling screens equipped with a fish return system. The 1 mm mesh screens, with a through-screen velocity of 0.5 feet per second or less, are designed to minimize impingement mortality. The dilution water (and any entrained marine life) would be transferred to the discharge tunnel using fish-friendly low-impact pumps that have been demonstrated to minimize entrainment mortality. Consistent with existing CDP operation, the concentrated seawater byproduct of the desalination process would be returned to the discharge tunnel and mixed with the dilution water to reduce salinity in the discharge to 42 ppt or less, a level that has been demonstrated to avoid toxicity in the receiving water.



INTENTIONALLY LEFT BLANK

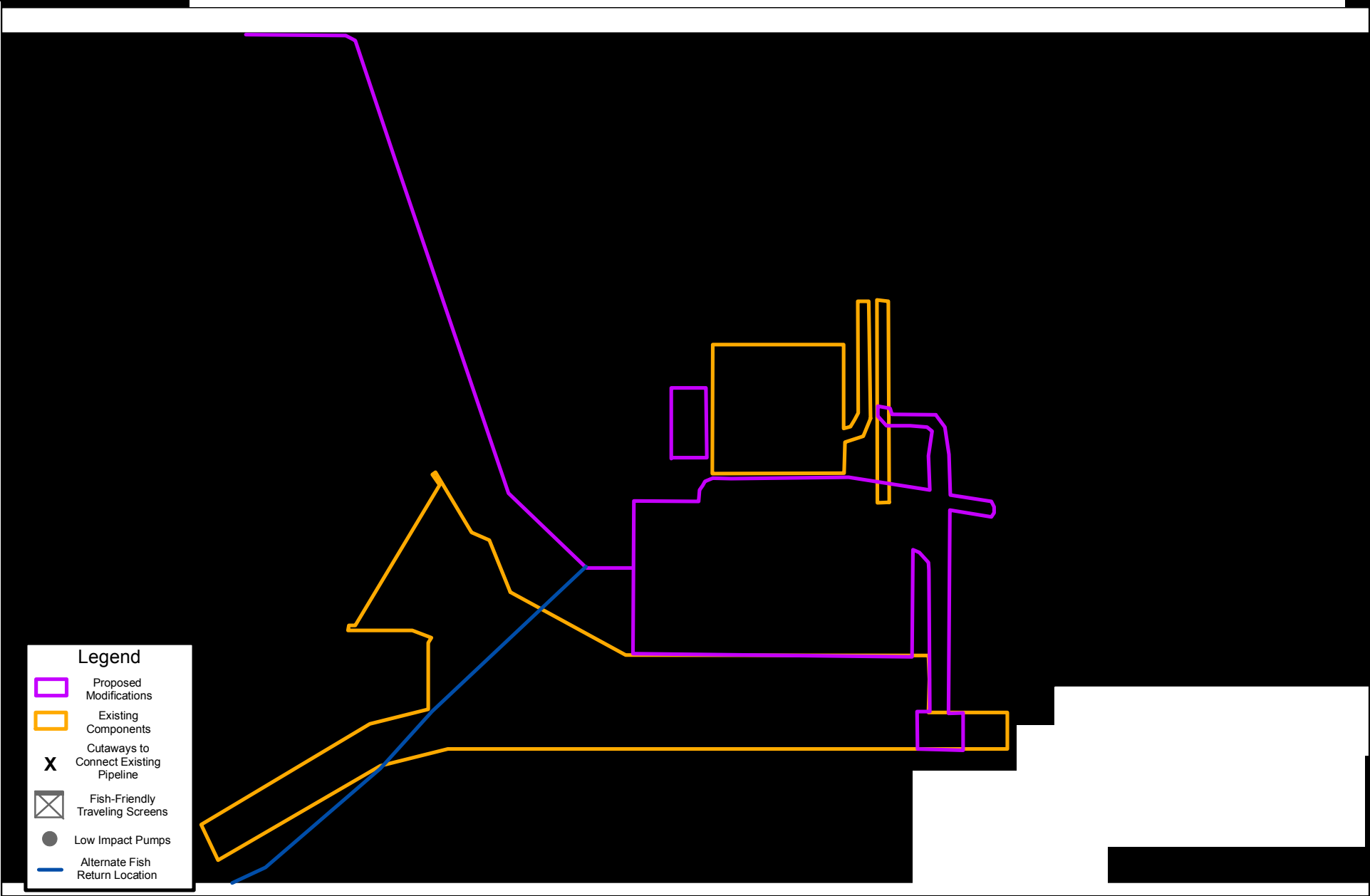

8426

Carlsbad Desal SEIR

FIGURE 4
Intake/Discharge Site Location

INTENTIONALLY LEFT BLANK

The new screening/fish-friendly pumping structure would house the screens, the fish-friendly low-impact pumps, and the fish return system. It would be constructed southwest of the existing intake pump station and adjacent to the existing intake tunnel. This structure would occupy approximately 9,000 square feet, at an elevation of approximately 2 feet above grade. An associated electrical building would be located adjacent to this structure that would be approximately 500 square feet and at an elevation of approximately 11 feet above grade.

In addition, since the CDP approvals, the production capability of the reverse osmosis system installed at the CDP has improved. While the CDP was under construction, the membrane area included in a standard reverse osmosis filtration element increased from 400 square feet to 440 square feet per element. The plant was designed to meet its average 50 mgd production requirements using 16,128 of the 400-square-foot membrane elements installed in 2,016 membrane housings. Each of the membrane housings holds 8 membrane elements. With the availability of the 440-square-foot membrane elements, Poseidon was able to install more membrane capacity in the individual membrane housings. As a result, only 15,232 membrane elements were required to meet the plant production requirements rather than 16,128, and 112 of the membrane housings installed in the plant have not been loaded with membrane. The empty membrane housings represent a potential opportunity to increase the average daily potable water output from approximately 50 mgd to approximately 55 mgd and the maximum daily output from 54 mgd to 60 mgd with minimal improvements to the plant. Improvements would include loading the remaining membrane elements in the empty housings, installation of additional energy recovery pressure exchangers and associated booster pumps, and other related accessories.

Proposed Improvements

New Screening/Fish-Friendly Pumping Structure (approximately 129 feet long by approximately 69 feet wide, approximately 30 feet high (predominantly below grade with approximately 2 feet above grade), 9,000 square feet): This structure would be made of concrete. The new screens would direct seawater to both the CDP intake pump station process water pipeline and to the new dilution water pumps. The up to eight screens (up to two redundant) use a 1 mm mesh with a smooth surface fabricated of woven stainless steel wire. The 1 mm screens have fish lifting buckets attached to the lower section of each screen panel (Figure 5). The buckets provide a sheltered area for organisms that may congregate by the screens and are designed to hold water to minimize air exposure during the collection and return process. The 1 mm screens have a low-pressure spray wash system (in addition to the standard high-pressure one used to clean the screen of debris) to gently rinse collected fish from the screen into a fish return system (see description below). The new screening/fish-friendly pumping structure would be almost entirely belowground (Figures 6 and 7). The fish-friendly pumping portion of the structure would also include four axial flow pumps (one redundant), which consist of a propeller within a pipe driven by a sealed motor (Figure 8). The pumps would direct lagoon water to the mixing tunnel to dilute processed brine via a 9-foot-diameter pipe.

Fish Return System: Organisms removed from the 1 mm screens by spray washes would be combined and directed into a single pipe that would return the organisms to the existing EPS discharge pond, or to a quiescent area of the lagoon. The return trough/pipe would be approximately 2 feet in diameter at a 1/16 per foot slope that continues for a run of approximately 280 feet for the fish return to the discharge pond and 382 feet for the fish return to the lagoon. The velocity in this section would be approximately 7 feet per second (less than 5 miles per hour) with a flow depth of approximately 4 inches. Except for a short section adjacent to the screening structure, the fish return would be buried. Two cleanouts would be located along its length to facilitate cleaning and inspection of the return pipe. The fish return pipe will be designed to minimize marine growth. Hydraulic design and materials selection are the primary means for maintaining the fish return system in clean condition. Cleaning would involve chemical free rinsing sprayers and/or pigging operations to remove debris. Additionally, provisions for pigging the fish return pipe will be installed in the event that visual monitoring reveals that fouling organisms are beginning to attach to the fish return line.

Electrical Building (approximately 32 feet long by 16 feet wide by 11 feet high; approximately 512 square feet): This structure would house all electrical needs to power the new screens, fish return system, and the fish-friendly axial pumps.

Plant Improvements: This would include installing reverse osmosis membranes into existing housing, and an additional energy recovery skid, piping, pressure exchangers, booster pumps, and other related accessories all to be located within the existing CDP.

Design Criteria for the New Screening/Fish-Friendly Pumping Structure and Permanent Stand-Alone Operation of the CDP

Cabrillo provided notice to Poseidon on May 5, 2014, that permanent decommissioning of the EPS once-through cooling water system will occur effective June 1, 2017, which will require Poseidon to transition to “permanent stand-alone” operation of the seawater intake. In addition, reverse osmosis membrane technology advances will allow a potential increase in potable water production capabilities from an annual average of 50 mgd to an annual average of 55 mgd and up to 60 mgd daily maximum. To facilitate “permanent stand-alone” operation of the seawater intake and discharge system, and increased production capacity, Poseidon has proposed changes to the CDP process water intake and discharge system operations.

It is important to note that the CDP is currently operational and co-located with the EPS. As shown in Figure 9, the EPS uses seawater that enters the existing EPS intake facilities located at the Agua Hedionda Lagoon, and after screening, is pumped through the EPS’s condensers to the discharge tunnel. The CDP’s intake pump station is connected to the EPS discharge tunnel and pumps approximately 100 mgd of EPS spent cooling water effluent for production of fresh drinking water.

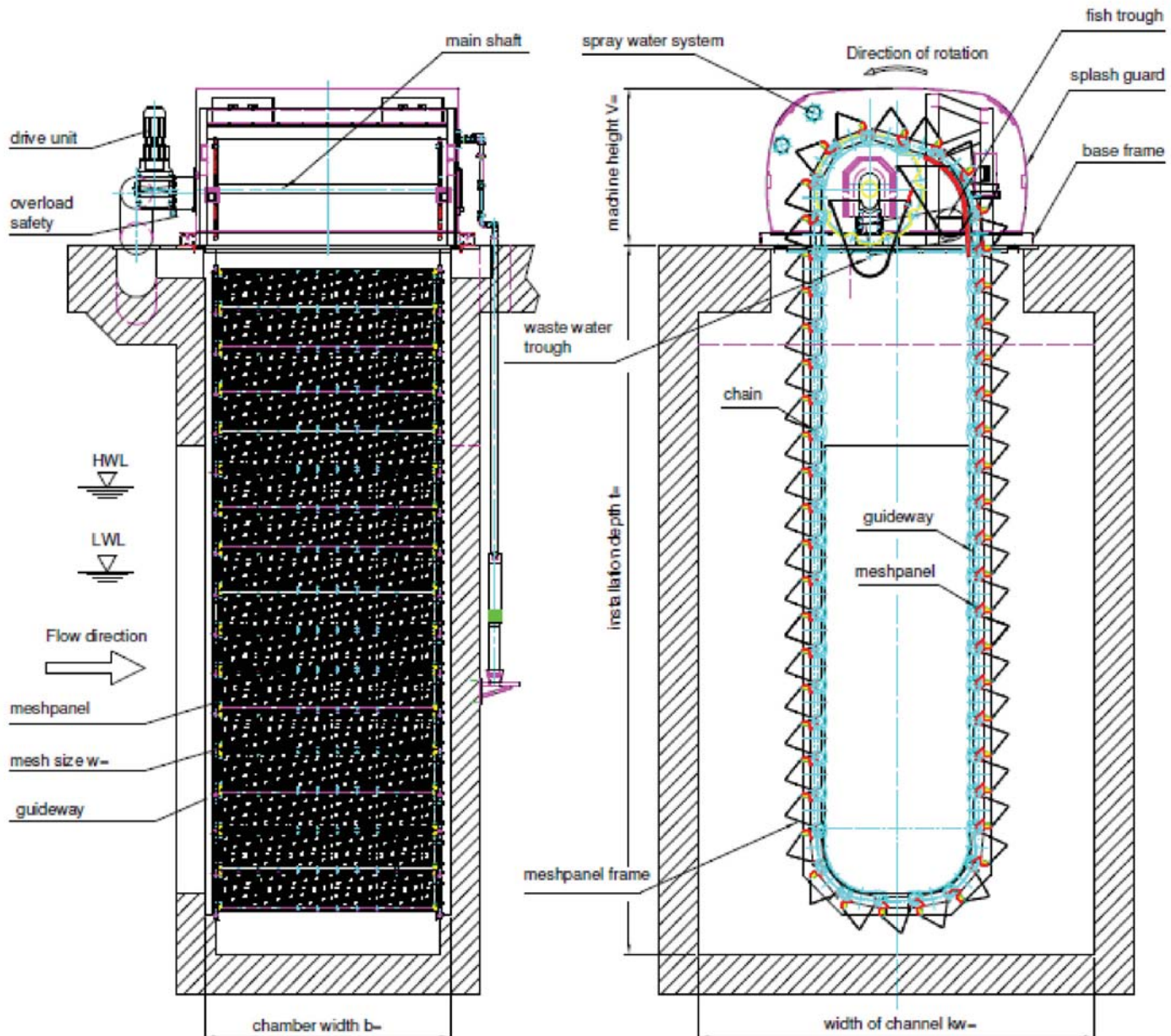
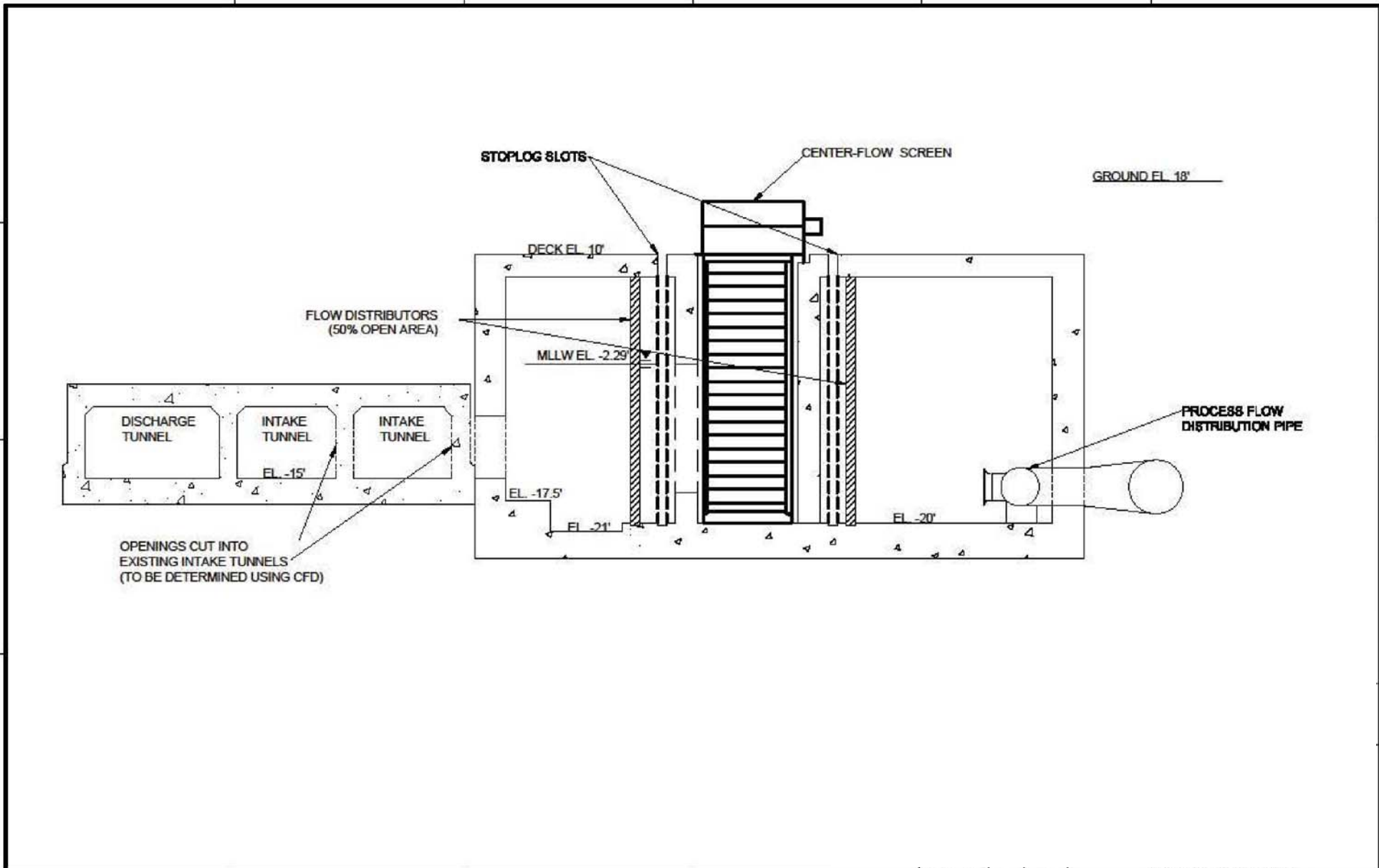
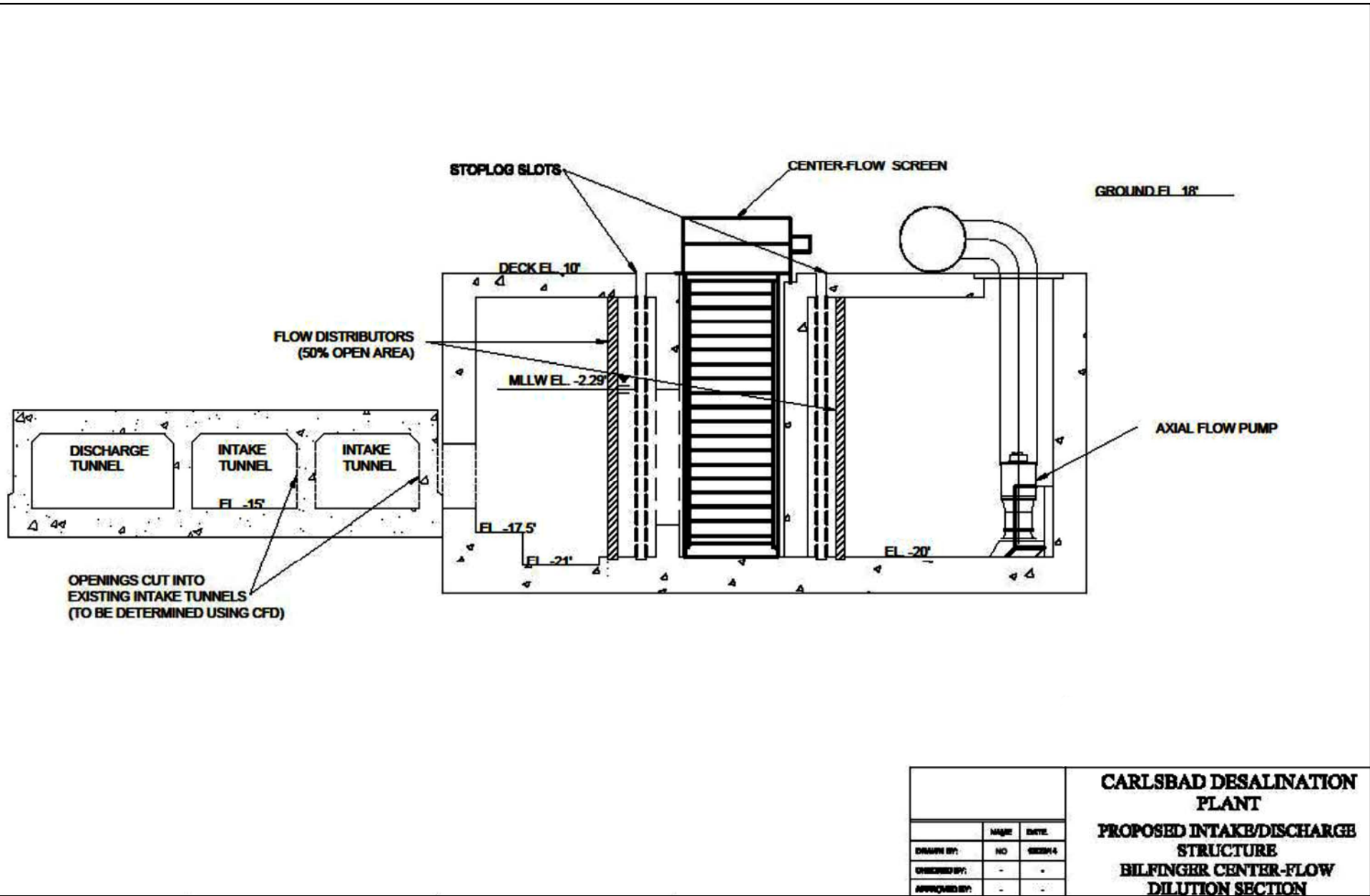

FIGURE 5
Sample Profile and Section View of Typical BWT Center-Flow Traveling Water Screen

INTENTIONALLY LEFT BLANK



INTENTIONALLY LEFT BLANK



CARLSBAD DESALINATION PLANT
PROPOSED INTAKE/DISCHARGE STRUCTURE
BILFINGER CENTER-FLOW DILUTION SECTION

FIGURE 7

Screened Flow Dilution Section

DUDEK

8426

Carlsbad Desal SEIR

INTENTIONALLY LEFT BLANK

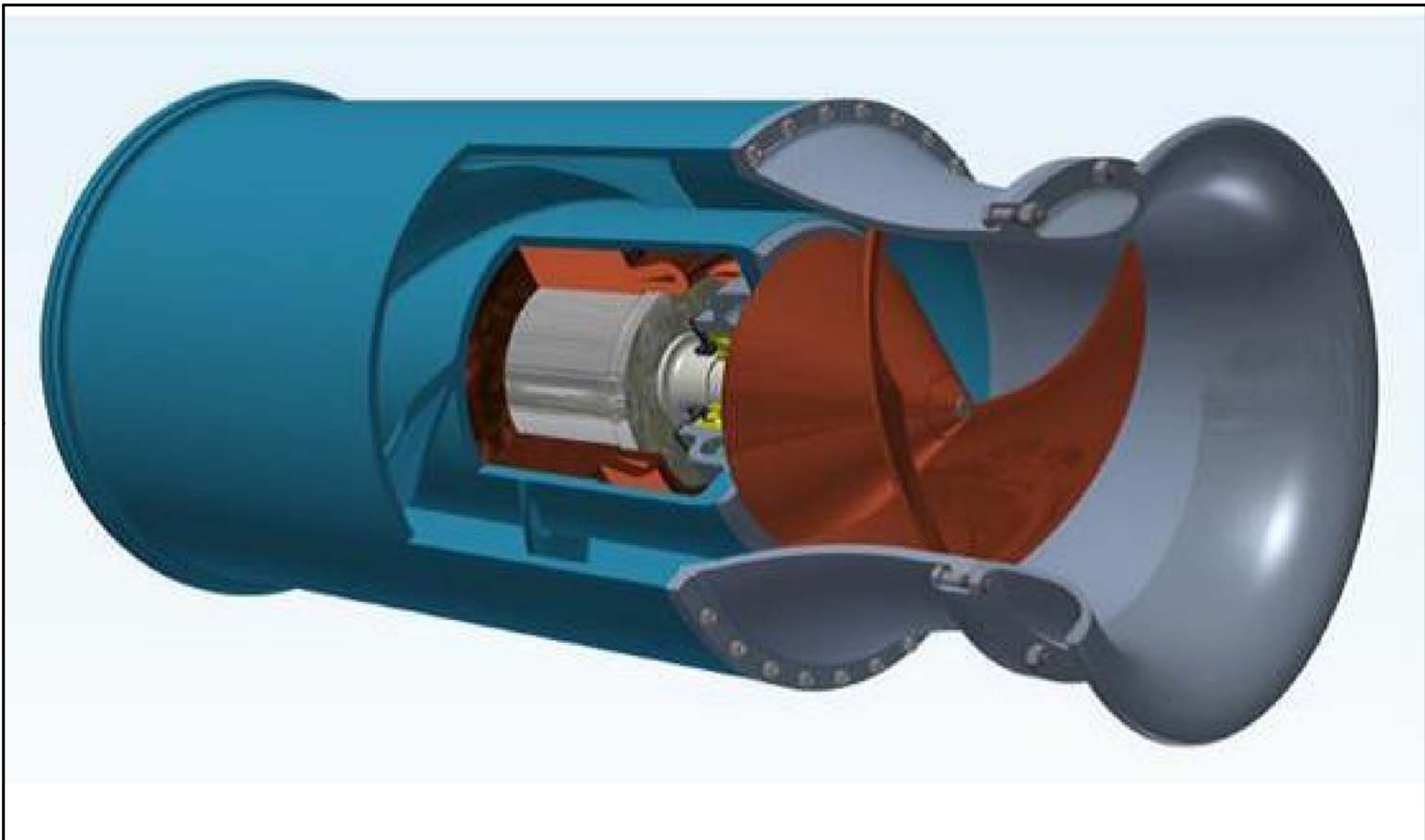

DUDEK

8426

Carlsbad Desal SEIR

FIGURE 8

Bedford Pump's Submersible Fish-Friendly Axial Flow Pump - Cutaway

INTENTIONALLY LEFT BLANK

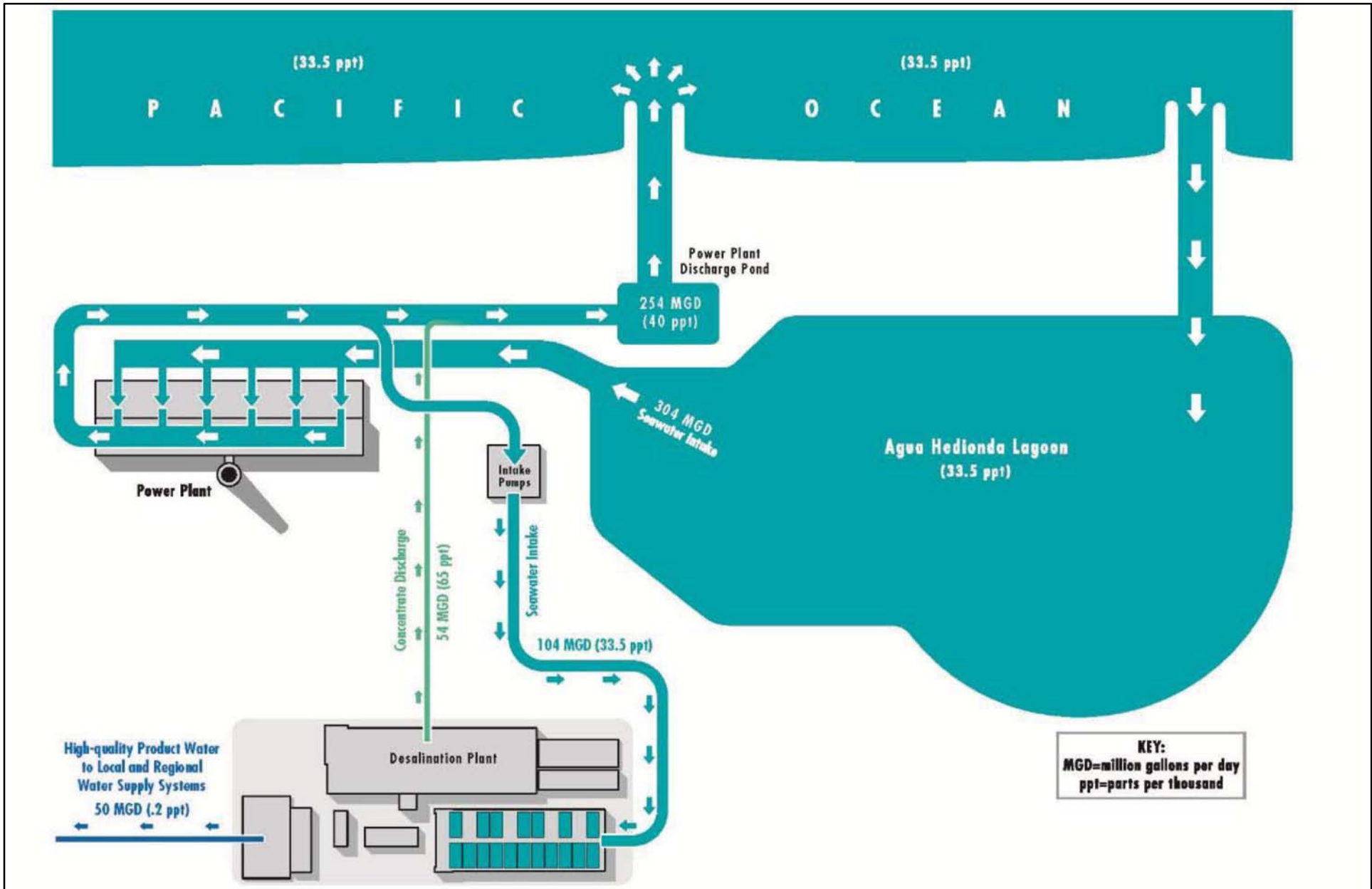
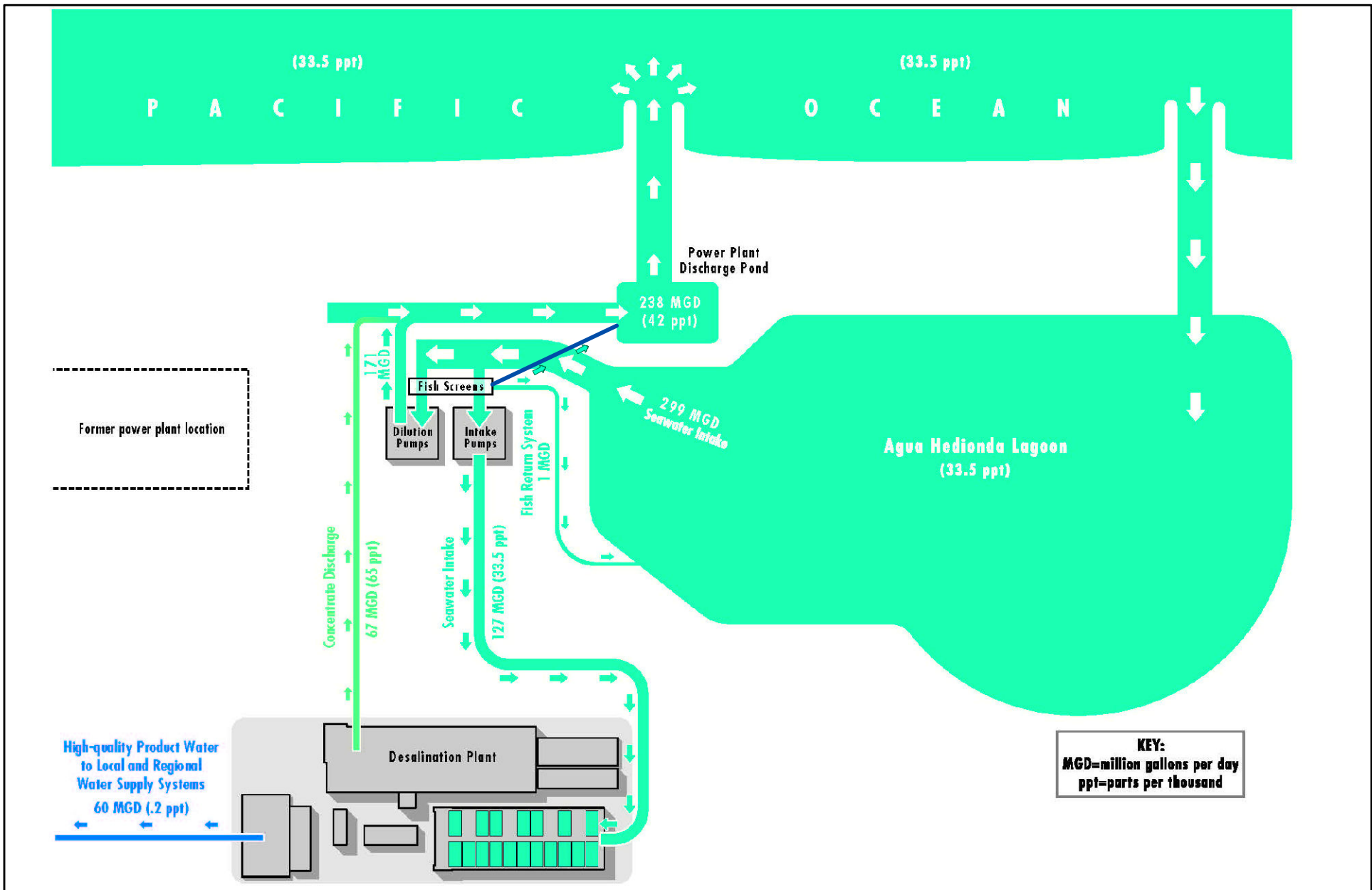

FIGURE 9
 Co-Location of Carlsbad Desalination Plant and Encina Power Station

INTENTIONALLY LEFT BLANK



INTENTIONALLY LEFT BLANK

The CDP's pretreatment and reverse osmosis membrane separation system currently converts an annual average of approximately 50 mgd (approximately half) of the diverted cooling seawater to fresh drinking water. The remaining (approximately half) has an average salinity of approximately 67 ppt or two times higher than that of the ocean water (approximately 33.5 ppt). This seawater concentrate is returned to the EPS discharge tunnel downstream of the point of intake for blending with the remaining EPS cooling water (minimum 200 mgd) prior to conveyance to the Pacific Ocean via an open surf zone discharge tunnel on the beach.

As a permanent stand-alone facility, with increased production capacity, process water for the CDP and brine dilution water (flow augmentation) would be withdrawn through the existing EPS intake structure located in the south west corner of Agua Hedionda Lagoon. There would be no change in the source waterbody, and no significant construction in the lagoon.

As shown in Figure 10, with the proposed new screening/fish-friendly pumping structure, seawater would continue to pass through the existing intake tunnel from the Agua Hedionda Lagoon. This seawater, with average salinity of approximately 33.5 ppt, would be taken into the new structure at approximately 299 mgd. Seawater would then pass at a velocity of 0.5 feet per second or less through up to eight traveling screens (up to two redundant screens) with 1 mm slot openings (as required by Ocean Plan Amendment). The mesh on the Bilfinger Water Technology (BWT) screens (or equal) for the CDP would be fabricated of woven stainless steel wire. The traveling screens have fish lifting buckets attached to the lower section of each screen panel. The buckets provide a sheltered area for organisms that may congregate near the screens and prevent them from becoming trapped against the screen mesh. The buckets are also designed to hold water to minimize air exposure during the collection and return process.

The traveling screens would be equipped with a low-pressure spray wash system (in addition to the standard high-pressure one used to clean the screen of debris) to gently rinse collected fish from the screen into a fish return system. The spray wash pressure is typically below 20 pounds per square inch, and the location and orientation of the nozzles is optimized for best performance. The BWT screens (or equal) would have a low-pressure spray wash to gently rinse marine organisms into the fish return ~~trough~~. The traveling screens are designed to operate continuously (Figure 5). Any Debris (generally kelp, eel grass, and shells) not removed by the low-pressure spray wash too large to pass through the screens would be rinsed into the fish return trough by a high-pressure spray wash~~collected and directed to the CDP outfall, separate from the marine organisms or collected and disposed of.~~

Fish, ~~and other organisms and debris~~ too large to pass through the screens would then be carried back to the discharge pond or the lagoon via a 1 mgd screen wash/fish return system. The fish return system would release fish to the discharge pond via a submerged outlet located directed

toward the outlet to the Pacific Ocean, or to the ~~and lagoon seawater~~ via a submerged outlet a sufficient distance from the intake tunnel (approximately 205 feet) so as to avoid immediate recirculation of fish and other organisms. The fish return system pipe would be approximately 2 feet in diameter and extend approximately 280 feet from the fish mesh screens to the discharge pond, or 382 feet from the fish mesh screens to the lagoon. The pipe would be buried so that it would not be visible, except for a short section adjacent to the screening structure and at the discharge point in the pond or lagoon. The visible short section in the screening structure would consist of a 2-foot-diameter half-round trough mounted to the intake deck on the downstream side of the screens.

The seawater velocity in the return pipeline would be approximately 7 feet per second with a flow depth of 4 inches. Two cleanouts would be located along its length to facilitate cleaning and inspection of the return pipe. From elevation 0 feet (mean sea level – msl) to below the low water level in the lagoon, the fish return would be an open trough to ensure that organisms are returned to the lagoon during all anticipated water levels. The discharge location would extend out into the pond or lagoon by approximately 6 feet, to ensure sufficient water depth during low water. Depending on the final arrangement, the ~~submerged-in-lagoon~~ section would be either anchored directly to the pond or lagoon floor, supported by small piles, or attached to the piers supporting the existing dock. An approximately 10-foot portion of the pond or lagoon shore would be stabilized to support the fish return pipe as it transitions from land to the pond or lagoon.

Once the seawater passes through the 1 mm mesh traveling screens, the seawater is directed to either the existing intake pumps or the proposed fish-friendly dilution pumps. At maximum plant production, ~~Seawater~~ with an ambient average salinity of approximately 33.5 ppt would be directed to the existing CDP intake pumps and on to the CDP at up to 127 mgd (120 mgd for processing and 7 mgd for filter backwash). Seawater would then be desalinated through the CDP and a daily maximum of 60 mgd of product water directed to local water supplies. Up to 60 mgd of saline water with a salt content of approximately 67 ppt and up to 7 mgd of filter backwash water with a salt content of 33.5 ppt is directed to the discharge tunnel for mixing with dilution water. ~~Up to~~ Between 171 mgd to 198 mgd of seawater for dilution would be pumped directly into the discharge tunnel for mixing with the higher concentrated CDP brine to comply with the Ocean Plan receiving water limit for salinity. After initial mixing, the CDP effluent arrives at the discharge pond at a rate of approximately 238 mgd to 244 mgd with a salinity of ~~approximately 42 ppt or less.~~ The effluent is further mixed with the discharge pond seawater and then discharged into the Pacific Ocean where it mixes and dilutes to within 2 ppt of background salt content levels (35.5 ppt) at the edge of the approximately 656-foot brine mixing zone (as required by the Ocean Plan Amendment). No modification to the discharge pond or point of discharge to the Pacific Ocean is proposed.

Construction

Construction of the proposed intake and discharge modifications would take approximately 74 weeks (18 months). Figure 3 shows the portions of the site layout where physical modifications are proposed. The construction of the new screening/fish-friendly pumping structure and the fish return system includes sheet piling, excavation, shoring, dewatering, building, demolition, backfill and grading, paving architecture coating, and landscaping.

Typical equipment involved in each of the construction activities includes excavators, tractors/backhoes, cranes, dewatering equipment, dumpers, lifts, and drill rigs. More detail on the phasing and duration anticipated for construction of the proposed CDP modifications are shown in Table 3-61.

Table 3-61
Construction Phasing

Phase	Duration	Week No.
Intake Modifications		
Phase 1 – Site Preparation	2 weeks	1–2
Phase 2 – Sheet Piling/Excavation	36 weeks	3–38
Phase 3 – Building Construction/Screen Installation	12 weeks	38–50
Phase 4 – Demolition	16 weeks	50–66
Phase 5 – Backfill	6 weeks	66–72
Phase 6 – Grading and Paving	2 weeks	72–74
Discharge Modifications		
Phase 1 – Paving	2 weeks	50–52
Phase 2 – Axial Pump Installation	8 weeks	52–60
Phase 3 – Trenching/Paving	8 weeks	60–68
Phase 4 – Building Construction	4 weeks	68–72
Phase 5 – Architectural Coatings	2 weeks	72–74

Demolition and site preparation for the new screening/fish-friendly pumping structure would involve clearing and demolition of approximately 0.6 acre of the existing paved/disturbed area west of the CDP and east of Carlsbad Boulevard. This includes approximately 7,000 square feet of ornamental vegetation clearing and 20,000 square feet of existing asphalt to be removed. Portions of the existing intake tunnel walls would be removed, to allow for new opening directing flows to the new screening/fish-friendly pumping structure, and are estimated to consist of approximately 72 tons of the existing intake wall material. The material from the intake walls would be reused where appropriate, or if unsuitable disposed of at a licensed landfill facility. Additionally, 27 cubic yards of material would be imported to construct the new walls that seal the tunnels to the EPS.

Sheet piling for the new screening/fish-friendly pumping structure would involve the removal of approximately 26,500 cubic yards of earth and the installation of an approximately 457 tons of shoring system. Removed earth would be reused where appropriate on site, sold for reuse commercially, or if unsuitable for reuse, disposed of at a licensed landfill facility.

Building construction would involve the installation of approximately 6,300 cubic yards of concrete for the intake structure and construction for discharge modifications of an approximately 9,000-square-foot new screening/fish-friendly pumping structure within which up to four fish-friendly pumps would be installed to provide dilution water to the discharge tunnel. The new screening/fish-friendly pumping structure and appurtenances would require dewatering throughout construction so that the vault could be constructed at depths approximately 30 feet below grade. An approximately 100-foot-long trench to provide new utility hooks up to the New Screening/Fish-Friendly Pumping Structure would be constructed.

Dewatering. The new screening/fish-friendly pumping structure and appurtenances would require dewatering throughout construction. As part of the permitting process for the intake/discharge modifications, the Applicant will submit an application to the State Water Board Division of Drinking Water (DDW) pursuant to California Health and Safety Code Section 116525, e. seq. (Drinking Water Source Water Assessment and Protection Program (DWSAP Program)) for consideration of use of the groundwater extracted during construction as a supplemental source water for the CDP. To the extent that DDW approves the application, the Applicant will supplement the source water to the CDP with the extracted groundwater. If the application is not approved by DDW, the Applicant will discharge the groundwater extracted during construction to the brine discharge vault in conformance with the Ocean Plan requirements and the applicable discharge permit requirements.

Backfill grading and paving for the new screening/fish-friendly pumping structure disturbed areas would be backfilled with approximately 16,800 cubic yards of re-compacted material previously removed, and then the area will be graded and paved.

Fish return construction would involving trenching and installation of an approximately 280 to 382-foot-long pipeline, mostly underground, that would discharge directly back into pond or the Agua Hedionda Lagoon approximately 6 feet from the bank. The fish return system would be constructed as part of the Intake Modifications Phase 2 construction phase (see Table 3-46). To support the pipe, a small portion of the pond or lagoon bank would be stabilized with rip-rap. The submerged trough itself would extend 6 feet into the pond or lagoon, and the discharge would be submerged at all stages of the tide.

Construction traffic would include disposal of cleared and demolished materials, as well as deliveries of materials and components. With approximately 9,700 cubic yards of material exported, a total of approximately 970, 10-cubic-yard-capacity trucks would be required to dispose of the material. The material would be disposed of during Intake Modifications Phase 2, phased over approximately 216 days (36 weeks), which averages to approximately five to six truck trips per day. In addition, approximately four truck trips per day throughout construction has been conservatively estimated for any and all deliveries. Deliveries would include approximately 12 trucks total to deliver 457 tons of shoring system, based on an 80,000-pound (36-ton) capacity of typical loader trucks, within the 36-week sheet piling construction phase. Throughout construction, deliveries of necessary materials such as sheet pilings, concrete, screens, pumps, and piping materials would be delivered as required. Construction workers would also result in vehicular trips as they commute to the job site each day. Up to 28 workers are necessary on a daily basis to construct the modifications. As shown in Table 3-72, the combined additional traffic trips from peak construction activity (Intake Modifications Phase 2) would total approximately 20 one-way trips and approximately 28 workers a day (no carpooling accounted for), or 96 average daily trips, in and out.

Table 3-72
Daily Trips per Construction Phase Summary

Phase	Worker Personal Vehicle Trips (one way per day)	Vendor Delivery Trips (one way per day)
Intake Modifications		
Phase 1 – Site Preparation	14	4
Phase 2 – Sheet Piling/Excavation	28	20
Phase 3 – Building Construction/Screen Instillation	26	14
Phase 4 – Demolition	22	4
Phase 5 – Backfill	26	4
Phase 6 – Grading and Paving	14	14
Discharge Modifications		
Phase 1 – Paving	12	18
Phase 2 – Axial Pump Installation	16	20
Phase 3 – Trenching/Paving	14	16
Phase 4 – Building Construction	26	20
Phase 5 – Architectural Coatings	8	8

Operations and Maintenance

The trash racks would continue to be operated and maintained as they are currently, with regular inspections and debris removal. The 1 mm fish screens would be continuously operated and

sprayed to avoid the need for intermittent removal of debris and would be in continual operation. The fish screen design includes redundant screening capability, which allows for repair if necessary by moving affected parts of the screen. The fish-friendly pumps include redundancy in capacity that allows for any one pump to be offline at any time for repair, maintenance, and/or cleaning. The fish-friendly pumps would generally operate 24 hours a day 7 days a week.

3.5 PURPOSE

The purpose for the Water Authority's actions and the proposed CDP modifications are as follows:

- Preserve the Water Authority's right to determine whether to finance the CDP modification for permanent stand-alone operation of the CDP.
- To transition the CDP to permanent stand-alone operations as a consequence of the decommissioning of the EPS once-through cooling water system.
- To satisfy conditions of the project's NPDES Permit No. CA0109223 by addressing the requirements of Section 13142.5(b) of the California Water Code—specifically to develop “the best available site, design, technology, and mitigation measures feasible” to minimize the intake and mortality of all forms of marine life.
- To meet the recently adopted Ocean Plan (Desalination) Amendment. Key parts of the 2015 Ocean Plan Amendment are as follows:
 - Define dimensions of a “brine mixing zone” (a zone where elevated salinities may cause marine life toxicity) beyond which Ocean Plan salinity receiving water requirements are applicable.
 - Require that receiving water salinity is not to exceed 2 ppt above ambient at the edge of the brine mixing dilution zone unless the RWQCB authorizes a facility-specific receiving water salinity limitation.
 - Establish requirements under which the RWQCB may consider and approve a facility-specific receiving water salinity limitation of more than 2 ppt above ambient.
 - Require use of the best feasible combination of available site, design, technology, and mitigation measures to minimize the intake and mortality impacts to marine organisms.
 - Establish monitoring and reporting requirements for assessing receiving water, benthic communities, and sediments to ensure that brine discharges do not cause adverse effects to marine life.

- Utilize reverse osmosis membrane technology advances to potentially allow an increase in potable water production capabilities from an annual average of 50 mgd to an annual average of 55 mgd with minimal improvements to the plant.
- Preserve the Water Authority's future option to determine whether to purchase additional capacity of potable water from the stand-alone facility.

3.6 REQUIRED ACTIONS AND APPROVALS

The proposed project requires several approvals from a number of agencies, which may include the following:

- Water Authority: Allocation of funds for CDP modifications (reimbursement)/supplement the WPA
- U.S. Army Corps of Engineers: 404 Permit (Nationwide Permit)
- CCC: CDP amendment
- California State Lands Commission: Lease Amendment
- California Department of Fish and Wildlife: Streambed Alteration Agreement
- RWQCB – Renewal of NPDES CA0109233 and 401 Permit
- City of Carlsbad
 - Amendment to the PDP (00-02)
 - Redevelopment Review Permit (05-12) amendment
 - Development Agreement Amendment

INTENTIONALLY LEFT BLANK

SECTION 4 ENVIRONMENTAL ANALYSIS

4.1 AIR QUALITY

This section describes the existing air quality setting, identifies associated regulatory requirements, evaluates potential air quality impacts of the proposed CDP modifications compared to the impacts evaluated in the FEIR and addenda for the existing CDP, and identifies whether any new or substantially modified mitigation measures are required or if those identified in the FEIR remain applicable and sufficient.

4.1.1 Existing Conditions

The overall existing conditions for the proposed CDP modifications has not changed since the time of the certification of the FEIR, with the exception of updates to the ambient air quality standards, San Diego Air Basin (SDAB) attainment status, local air quality conditions, and San Diego Air Pollution Control District (SDAPCD) rules, as discussed below. Refer to Section 4.2 of the FEIR for additional discussion of existing conditions and regulations related to air quality.

Regulatory Setting

Federal and California Clean Air Act

The National Ambient Air Quality Standards (NAAQS) and California Ambient Air Quality Standards (CAAQS) have been updated since the FEIR and are presented in Table 4.1-1.

**Table 4.1-1
Ambient Air Quality Standards**

Pollutant	Averaging Time	California Standards ^a	National Standards ^b	
		Concentration ^c	Primary ^{c,d}	Secondary ^{c,e}
O ₃	1-hour	0.09 ppm (180 µg/m ³)	—	Same as Primary Standard
	8-hour	0.070 ppm (137 µg/m ³)	0.070 ppm (137 µg/m ³)	
CO	1-hour	20 ppm (23 mg/m ³)	35 ppm (40 mg/m ³)	—
	8-hour	9.0 ppm (10 mg/m ³)	9 ppm (10 mg/m ³)	
NO ₂ ^f	1-hour	0.18 ppm (339 µg/m ³)	0.100 ppm (188 µg/m ³)	Same as Primary Standard
	Annual Arithmetic Mean	0.030 ppm (57 µg/m ³)	0.053 ppm (100 µg/m ³)	
SO ₂ ^g	1-hour	0.25 ppm (655 µg/m ³)	0.75 ppm (196 µg/m ³)	—
	3-hour	—	—	0.5 ppm (1300 µg/m ³)
	24-hour	0.04 ppm (105 µg/m ³)	0.14 ppm (for certain areas) ^g	—
	Annual Arithmetic Mean	—	0.030 ppm (for certain areas) ^g	—

**Table 4.1-1
Ambient Air Quality Standards**

Pollutant	Averaging Time	California Standards ^a		
		Concentration ^c	Primary ^{c,d}	Secondary ^{c,e}
PM ₁₀ ^h	24-hour	50 µg/m ³	150 µg/m ³	Same as Primary Standard
	Annual Arithmetic Mean	20 µg/m ³	—	
PM _{2.5} ^h	24-hour	—	35 µg/m ³	Same as Primary Standard
	Annual Arithmetic Mean	12 µg/m ³	12.0 µg/m ³	15.0 µg/m ³
Lead ^{i,j}	30-day Average	1.5 µg/m ³	—	—
	Calendar Quarter	—	1.5 µg/m ³ (for certain areas) ⁱ	Same as Primary Standard
	Rolling 3-Month Average	—	0.15 µg/m ³	
Hydrogen sulfide	1-hour	0.03 ppm (42 µg/m ³)	—	—
Vinyl chloride ^f	24-hour	0.01 ppm (26 µg/m ³)	—	—
Sulfates	24-hour	25 µg/m ³	—	—
Visibility reducing particles ^k	8-hour (10:00 a.m. to 6:00 p.m. PST)	See footnote k	—	—

Source: CARB 2013.

ppm = parts per million by volume; µg/m³ = micrograms per cubic meter; mg/m³ = milligrams per cubic meter; O₃ = ozone; CO = carbon monoxide; NO₂ = nitrogen dioxide; SO₂ = sulfur dioxide; PM₁₀ = coarse particulate matter; PM_{2.5} = fine particulate matter

- ^a California standards for ozone, carbon monoxide (except 8-hour Lake Tahoe), sulfur dioxide (1 and 24 hour), nitrogen dioxide, and particulate matter (PM₁₀, PM_{2.5}, and visibility reducing particles), are values that are not to be exceeded. All others are not to be equaled or exceeded. CAAQS are listed in the Table of Standards in Section 70200 of Title 17 of the California Code of Regulations.
- ^b National standards (other than O₃, NO₂, SO₂, particulate matter, and those based on annual averages or annual arithmetic mean) are not to be exceeded more than once a year. The O₃ standard is attained when the fourth highest 8-hour concentration in a year, averaged over 3 years, is equal to or less than the standard. For NO₂ and SO₂, the standard is attained when the 3-year average of the 98th and 99th percentile, respectively, of the daily maximum 1-hour average at each monitor within an area does not exceed the standard. For PM₁₀, the 24-hour standard is attained when the expected number of days per calendar year with a 24-hour average concentration above 150 µg/m³ is equal to or less than one. For PM_{2.5}, the 24-hour standard is attained when 98% of the daily concentrations, averaged over 3 years, are equal to or less than the standard.
- ^c Concentration expressed first in units in which it was promulgated. Equivalent units given in parentheses are based upon a reference temperature of 25°C and a reference pressure of 760 torr. Most measurements of air quality are to be corrected to a reference temperature of 25°C and a reference pressure of 760 torr; ppm in this table refers to ppm by volume, or micromoles of pollutant per mole of gas.
- ^d National Primary Standards: The levels of air quality necessary, with an adequate margin of safety to protect the public health.
- ^e National Secondary Standards: The levels of air quality necessary to protect the public welfare from any known or anticipated adverse effects of a pollutant.
- ^f To attain the 1-hour national standard, the 3-year average of the annual 98th percentile of the 1-hour daily maximum concentrations at each site must not exceed 100 ppb. Note that the national 1-hour standard is in units of parts per billion (ppb). California standards are in units of parts per million (ppm). To directly compare the national 1-hour standard to the California standards, the units can be converted from ppb to ppm. In this case, the national standard of 100 ppb is identical to 0.100 ppm.
- ^g On June 2, 2010, a new 1-hour SO₂ standard was established and the existing 24-hour and annual primary standards were revoked. To attain the 1-hour national standard, the 3-year average of the annual 99th percentile of the 1-hour daily maximum concentrations at each site must not exceed 75 ppb. The 1971 SO₂ national standards (24-hour and annual) remain in effect until one year after an area is designated for the 2010 standard, except that in areas designated nonattainment for the 1971 standards, the 1971 standards remain in effect until implementation plans to attain or maintain the 2010 standards are approved.
- ^h On December 14, 2012, the national annual PM_{2.5} primary standard was lowered from 15 µg/m³ to 12 µg/m³. The existing national 24-hour PM_{2.5} standards (primary and secondary) were retained at 35 µg/m³, as was the annual secondary standard of 15 µg/m³. The existing 24-hour PM₁₀ standards (primary and secondary) of 150 µg/m³ also were retained. The form of the annual primary and secondary standards is the annual mean, averaged over 3 years.

- i CARB has identified lead and vinyl chloride as 'toxic air contaminants' with no threshold level of exposure for adverse health effects determined. These actions allow for the implementation of control measures at levels below the ambient concentrations specified for these pollutants.
- j The national standard for lead was revised on October 15, 2008 to a rolling 3-month average. The 1978 lead standard (1.5 µg/m³ as a quarterly average) remains in effect until 1 year after an area is designated for the 2008 standard, except that in areas designated nonattainment for the 1978 standard, the 1978 standard remains in effect until implementation plans to attain or maintain the 2008 standard are approved.
- k In 1989, CARB converted both the general statewide 10-mile visibility standard and the Lake Tahoe 30-mile visibility standard to instrumental equivalents, which are "extinction of 0.23 per kilometer" and "extinction of 0.07 per kilometer" for the statewide and Lake Tahoe Air Basin standards, respectively.

Local

San Diego Air Pollution Control District

The California Air Resources Board (CARB) is responsible for the regulation of mobile emissions sources within the state, and local air quality management districts (AQMDs) and air pollution control districts (APCDs) are responsible for enforcing standards and regulating stationary sources. The project site is located within the SDAB and is subject to the guidelines and regulations of the SDAPCD.

In San Diego County, ozone (O₃) and particulate matter are the pollutants of main concern, since exceedances of CAAQS for those pollutants are experienced here in most years. For this reason, the SDAB has been designated as a nonattainment area for the state respirable particulate matter (PM₁₀), fine particulate matter (PM_{2.5}), and O₃ standards. The SDAB is also a federal O₃ attainment (maintenance) area for 1997 8-hour O₃ standard, an O₃ nonattainment area for the 2008 8-hour O₃ standard, and a carbon monoxide (CO) maintenance area (western and central part of the SDAB only). The project area is in the CO maintenance area.

The SDAPCD and the San Diego Association of Governments (SANDAG) are responsible for developing and implementing the clean air plan for attainment and maintenance of the ambient air quality standards in the SDAB. The San Diego County's Regional Air Quality Strategy (RAQS) was initially adopted in 1991 and is updated on a triennial basis, most recently in 2009 (SDAPCD 2009a). The RAQS outlines SDAPCD's plans and control measures designed to attain the state air quality standards for O₃. The RAQS relies on information from CARB and SANDAG, including mobile and area source emissions, and information regarding projected growth in the cities and San Diego County, to project future emissions and determine the strategies necessary for the reduction of emissions through regulatory controls. CARB mobile source emission projections and SANDAG growth projections are based on population, vehicle trends, and land use plans developed by the cities and San Diego County as part of the development of their general plans.

As stated earlier, the SDAPCD is responsible for planning, implementing, and enforcing federal and state ambient standards in the SDAB. The following rules and regulations that have become effective since the FEIR apply to all sources in the jurisdiction of SDAPCD:

- **SDAPCD Regulation IV: Prohibitions; Rule 55: Fugitive Dust.** Regulates fugitive dust emissions from any commercial construction or demolition activity capable of generating fugitive dust emissions, including active operations, open storage piles, and inactive disturbed areas, as well as track-out and carry-out onto paved roads beyond a project site (SDAPCD 2009b).
- **SDAPCD Regulation IV: Prohibitions; Rule 67.0.1: Architectural Coatings.** Requires manufacturers, distributors, and end users of architectural and industrial maintenance coatings to reduce volatile organic compound (VOC) emissions from the use of these coatings, primarily by placing limits on the VOC content of various coating categories (SDAPCD 2015).

Existing Air Quality

Air Quality Monitoring Data

The SDAPCD operates a network of ambient air monitoring stations throughout San Diego County, which measure ambient concentrations of pollutants and determine whether the ambient air quality meets the CAAQS and the NAAQS. The SDAPCD monitors air quality conditions at 10 locations throughout the basin. The Camp Pendleton monitoring station concentrations for O₃, nitrogen dioxide (NO₂), and PM_{2.5} were selected as the representative monitoring location concentrations for the project. The Escondido – East Valley Parkway monitoring station is the most representative location where CO and PM₁₀ concentrations are monitored. The El Cajon – Redwood Avenue station is the closest station where sulfur dioxide (SO₂) concentrations are monitored. Updates to the ambient concentrations of pollutants presented in the FEIR are presented in Table 4.1-2, from 2010 through 2014. The number of days exceeding the O₃ Ambient Air Quality Standards (AAQS) is shown in Table 4.1-3. The state 8-hour O₃ standards were exceeded in 2010, 2011, 2012, and 2014, and the federal 8-hour O₃ standard was exceeded in 2010, 2012, and 2014. The state 1-hour O₃ standard was exceeded in 2014. The federal 24-hour PM_{2.5} standard and state 24-hour PM₁₀ standard was exceeded in 2013. Air quality within the project region was in compliance with both CAAQS and NAAQS for NO₂, CO, and SO₂ during this monitoring period.

**Table 4.1-2
Ambient Air Quality Data
(ppm unless otherwise indicated)**

Pollutant	Averaging Time	2010	2011	2012	2013	2014	Most Stringent Ambient Air Quality Standard	Monitoring Station
O ₃	8-hour	0.079	0.071	0.081	0.066	0.080	0.070	Camp Pendleton
	1-hour	0.092	0.085	0.092	0.078	0.097	0.090	
PM ₁₀	Annual	21.0 µg/m ³	18.8 µg/m ³	18.1 µg/m ³	23.1 µg/m ³	21.5 µg/m ³	20 µg/m ³	Escondido – East Valley Parkway
	24-hour	43.0 µg/m ³	40.0 µg/m ³	33.0 µg/m ³	82.0 µg/m ³	44.0 µg/m ³	50 µg/m ³	
PM _{2.5}	Annual*	7.9 µg/m ³	12.0 µg/m ³	10.7 µg/m ³	8.5 µg/m ³	10.7 µg/m ³	12 µg/m ³	Camp Pendleton
	24-hour	27.3 µg/m ³	30.7 µg/m ³	28.0 µg/m ³	42.3 µg/m ³	28.0 µg/m ³	35 µg/m ³	
NO ₂	Annual	0.009	N/A	0.008	N/A	0.007	0.030	Camp Pendleton
	1-hour	0.081	0.066	0.061	0.081	0.060	0.180	
CO	8-hour	2.46	2.30	3.70	2.60	3.10	9.0	Escondido – East Valley Parkway
	1-hour*	3.90	3.50	4.40	3.20	3.80	20	
SO ₂	Annual	N/A	0.000	N/A	N/A	N/A	0.030	El Cajon – Redwood Avenue
	24-hour	N/A	0.001	0.001	0.001	N/A	0.040	

Sources: CARB 2014a; EPA 2014.

Notes: N/A = data not available; O₃ = ozone; CO = carbon monoxide; NO₂ = nitrogen dioxide; SO₂ = sulfur dioxide; PM₁₀ = coarse particulate matter; PM_{2.5} = fine particulate matter. Data represent maximum values.

* Data were taken from EPA 2014

**Table 4.1-3
Frequency of Air Quality Standard Violations**

Year	Number of Days Exceeding Standard				
	State 1-Hour O ₃	State 8-Hour O ₃	National 8-Hour O ₃	State 24-hour PM ₁₀ *	National 24-hour PM _{2.5} *
2010	0	1	1	0.0 (0)	N/A
2011	0	2	0	0.0 (0)	N/A
2012	0	1	1	0.0 (0)	0.0 (0)
2013	0	0	0	6.0 (1)	1.1 (1)
2014	1	6	1	0.0 (0)	N/A

Source: CARB 2014b.

Notes: N/A = data not available; O₃ = ozone; PM₁₀ = coarse particulate matter; PM_{2.5} = fine particulate matter

* Measurements of PM₁₀ and PM_{2.5} are usually collected every 6 days and daily, respectively. "Number of days exceeding the standards" is a mathematical estimate of the number of days concentrations would have been greater than the level of the standard had each day been monitored. The numbers in parentheses are the measured number of samples that exceeded the standard.

4.1.2 Significance Criteria

The State of California has developed guidelines to address the significance of air quality impacts based on Appendix G of the CEQA Guidelines (14 CCR 15000 et seq.), which provides guidance that a project would have a significant environmental impact if it would:

- A. Conflict with or obstruct the implementation of the applicable air quality plan
- B. Violate any air quality standard or contribute substantially to an existing or projected air quality violation
- C. Result in a cumulatively considerable net increase of any criteria pollutant for which the project region is nonattainment under an applicable federal or state ambient air quality standard (including releasing emissions which exceed quantitative thresholds for O₃ precursors)
- D. Expose sensitive receptors to substantial pollutant concentrations
- E. Create objectionable odors affecting a substantial number of people

San Diego Air Pollution Control District

As part of its air quality permitting process, the SDAPCD has established thresholds in Rule 20.2 requiring preparation of Air Quality Impact Assessments for permitted stationary sources. The SDAPCD sets forth quantitative emission thresholds below which a stationary source would not have a significant impact on ambient air quality. Project-related air quality impacts estimated in this environmental analysis would be considered significant if any of the applicable significance thresholds presented in Table 4.1-4 are exceeded.

**Table 4.1-4
SDAPCD Air Quality Significance Thresholds**

Construction Emissions	
Pollutant	Total Emissions (Pounds per Day)
Respirable Particulate Matter (PM ₁₀)	100
Fine Particulate Matter (PM _{2.5})	55*
Oxides of Nitrogen (NO _x)	250
Oxides of Sulfur (SO _x)	250
Carbon Monoxide (CO)	550
Volatile Organic Compounds (VOC)	75**

**Table 4.1-4
SDAPCD Air Quality Significance Thresholds**

Pollutant	Operational Emissions		
	Total Emissions		
	Pounds per Hour	Pounds per Day	Pounds per Year
Respirable Particulate Matter (PM ₁₀)	—	100	15
Fine Particulate Matter (PM _{2.5})	—	55*	10
Oxides of Nitrogen (NO _x)	25	250	40
Sulfur Oxides (SO _x)	25	250	40
Carbon Monoxide (CO)	100	550	100
Lead and Lead Compounds	—	3.2	0.6
Volatile Organic Compounds (VOC)	—	75**	13.7

Sources: SDAPCD Rules 1501 (SDAPCD 1995) and 20.2(d)(2) (SDAPCD 1998).

* PM_{2.5} threshold based on EPA Proposed Rule to Implement the Fine Particle NAAQS (CFR 40 Part 50.13 and Part 50.7), as derived by the SCAQMD's *Final – Methodology to Calculate PM_{2.5} and PM_{2.5} Significance Thresholds* (SCAQMD 2006), and referenced by the County of San Diego Guidelines for Determining Significance (County of San Diego 2007).

** VOC threshold based on the threshold of significance for VOCs from the South Coast Air Quality Management District for the Coachella Valley as stated in the San Diego County Guidelines for Determining Significance.

The thresholds listed in Table 4.1-4 represent screening-level thresholds that can be used to evaluate whether project-related emissions would cause a significant impact on air quality. Emissions below the screening-level thresholds would not cause a significant impact. In the event that emissions exceed these thresholds, modeling would be required to demonstrate that the project's total air quality impacts result in ground-level concentrations that are below the CAAQS and NAAQS, including appropriate background levels. For nonattainment pollutants, if emissions exceed the thresholds shown in Table 4.1-4, the project could have the potential to result in a cumulatively considerable net increase in these pollutants and thus could have a significant impact on the ambient air quality.

With respect to odors, SDAPCD Rule 51 (Public Nuisance) prohibits emission of any material that causes nuisance to a considerable number of persons or endangers the comfort, health, or safety of any person (SDAPCD 1969). A project that proposes a use that would produce objectionable odors would be deemed to have a significant odor impact if it would affect a considerable number of off-site receptors.

4.1.3 Impacts

A. *Conflict with or obstruct the implementation of the applicable air quality plan?*

If a project proposes development that is greater than that anticipated in the local plan and SANDAG's growth projections, the project might be in conflict with the SIP and RAQS and may contribute to a potentially significant cumulative impact on air quality.

The FEIR concluded the CDP is consistent with local General Plans for the County of San Diego and the cities within the County, as well as the regional growth plans developed and approved by SANDAG and CARB. Thus, the CDP would not conflict with or obstruct implementation of the RAQS and the SIP that use the land use, mobile emissions source, and area emissions source information as the basis for the emissions projections in the SDAB. The incorporation of the proposed CDP modifications would not change this conclusion. The CDP would remain consistent with the existing zoning and General Plan land use designations for the project site, and would not increase local population growth. Additionally, as discussed in Section 6, Growth-Inducing Impacts, the additional 5 mgd of annual average potable water output resulting from the proposed CDP modifications is contemplated in water projections for regional water sources and would not result in substantial growth beyond current projections. Therefore, the CDP with incorporation of the proposed modifications would remain consistent at a regional level with the underlying growth forecasts in the RAQS and SIP. Impacts would remain less than significant. The increase in capacity would ~~substantially-incrementally~~ increase the severity of impacts with the incorporation of the proposed CDP modifications. However, the increase would not be such that the determination of significance is altered from the FEIR.

B. Violate any air quality standard or contribute substantially to an existing or projected air quality violation?

Construction Impacts

Construction of the proposed CDP modifications would result in a temporary addition of pollutants to the local airshed caused by soil disturbance, fugitive dust emissions, and combustion pollutants from on-site construction equipment, as well as from off-site trucks hauling construction materials. Construction emissions can vary substantially from day to day, depending on the level of activity, the specific type of operation, and, for dust, the prevailing weather conditions. Fugitive dust (PM₁₀ and PM_{2.5}) emissions would primarily result from grading and site preparation activities. NO_x and CO emissions would primarily result from the use of construction equipment and motor vehicles.

Emissions from the construction phase of project were estimated using the California Emissions Estimator Model (CalEEMod) Version 2013.2.2, available online (www.caleemod.com). For the purposes of modeling, it was assumed that construction of the proposed modifications would commence in mid-September 2016 and would occur intermittently over an approximately 18-month period. Table 4.1-5 shows the anticipated construction schedule by phase. Construction emissions for the proposed CDP modifications are distinct from the construction emissions presented in the FEIR because the existing CDP construction is complete. The effects of the construction emissions are evaluated on a daily or per-day threshold basis.

**Table 4.1-5
Construction Schedule**

Phase	Duration
<i>Intake Structure</i>	
Phase 1a – Site Preparation	1 week
Phase 1b – Asphalt Removal	1 week
Phase 2a – Sheet Piling	18 weeks
Phase 2b – Excavation	18 weeks
Phase 3 – Building Construction	12 weeks
Phase 4 – Demolition	16 weeks
Phase 5 – Backfill	6 weeks
Phase 6a – Grading	1 week
Phase 6b – Paving	1 week
<i>Axial Pumps</i>	
Phase 1 – Paving	2 weeks
Phase 2 – Axial Pump Installation	8 weeks
Phase 3a – Trenching	4 weeks
Phase 3b – Paving	4 weeks
Phase 4 – Building Construction	4 weeks
Phase 5 – Architectural Coatings	2 weeks

See Appendix S-B for complete details.

Site preparation for the intake structure would consist of approximately 7,000 square feet of vegetation clearing and 20,000 square feet of asphalt removal, which would be exported off site. Grading and paving activities would cover approximately 27,000 square feet. Following cut and fill activities, approximately 9,700 cubic yards of soil would be exported off site.

Equipment mix assumptions for construction activity are based on typical infrastructure construction practices and CalEEMod default equipment where appropriate. The equipment mix is meant to represent a reasonably conservative estimate of construction activity. For this analysis, it is generally assumed that heavy construction equipment would be operating at the site for approximately 8 hours per day, 5 days per week. A detailed depiction of the construction schedule—including information regarding subphases and equipment assumed for each subphase—is included in Appendix S-B.

Construction of the proposed modifications would be subject to SDAPCD Rule 55 – Fugitive Dust Control. This rule requires that construction of the proposed modifications include steps to restrict visible emissions of fugitive dust beyond the property line (SDAPCD 2009b). Compliance with Rule 55 would limit fugitive dust (PM₁₀ and PM_{2.5}) that may be generated during grading and construction activities. Construction of the proposed modifications would also be subject to SDAPCD Rule 67.0.1 – Architectural Coatings. This rule requires

manufacturers, distributors, and end users of architectural and industrial maintenance coatings to reduce VOC emissions from the use of these coatings, primarily by placing limits on the VOC content of various coating categories (SDAPCD 2015).

Table 4.1-6 shows the estimated maximum unmitigated daily construction emissions associated with the construction phases of the proposed modifications. Complete details of the emissions calculations are provided in Appendix S-B.

Table 4.1-6
Estimated Maximum Daily Construction Emissions – Unmitigated (pounds per day)

Year	VOC	NO _x	CO	SO _x	PM ₁₀	PM _{2.5}
2016	3.89	37.50	24.35	0.05	3.48	2.17
2017	17.13	179.35	98.69	0.24	8.20	7.32
2018	15.12	153.76	91.47	0.24	7.00	6.19
Maximum Daily Emissions	17.13	179.35	98.69	0.24	8.20	7.32
<i>Emission Threshold</i>	75	250	550	250	100	55
Threshold Exceeded?	No	No	No	No	No	No

Source: CalEEMod Version 2013.2.2. See Appendix S-B for complete results.

The values shown are the maximum summer or winter daily emissions results from CalEEMod.

VOC = volatile organic compound; NO_x = oxides of nitrogen; CO = carbon monoxide; SO_x = sulfur oxides; PM₁₀ = coarse particulate matter; PM_{2.5} = fine particulate matter

As shown in Table 4.1-6, daily construction emissions for the proposed modifications would not exceed the County of San Diego's significance thresholds for VOC, NO_x, CO, SO_x, PM₁₀, or PM_{2.5}. Impacts would be less than significant, and no mitigation is required.

Operational Impacts

Following completion of construction activities, operations of the CDP would not change substantially, except for the additional energy needed to run modified intake components and increase the average annual product water output by 5 mgd. The CDP and the proposed modifications would be powered by electricity obtained from the electrical grid and would not result in any direct emissions of criteria air pollutants (see Section 4.3, Greenhouse Gas Emissions, for a discussion of indirect greenhouse gas emissions). Indirect criteria air pollutant emission sources would reflect that of the existing CDP, as analyzed in the FEIR. The FEIR estimated indirect criteria pollutant emissions from electrical generation required to operate the CDP based on the conservative estimate that all electricity would come from the EPS, which uses natural gas combustion to produce electricity, and that all criteria pollutant emissions from electrical generation would occur in the SDAB. Using these assumptions the FEIR found that indirect criteria pollutant emissions from the CDP's electricity demand would be below the SDAPCD's significance thresholds.

The proposed modifications would increase the average annual electricity demand by 5.3 megawatt-hours per hour of operation (MWh/h). The FEIR projected the CDP would have a maximum electricity demand of approximately 36.05 MWh/h. The expected average CDP electricity demand is 32.0 MWh/h when operating at 50 mgd in co-located operation. The addition of 5.3 MWh/h to the expected average CDP electricity demand would result in a total average annual energy demand of 37.3 MWh/h when operating at 55 mgd in stand-alone operation. The addition of 8.9 MWh/h to the worst case maximum energy demand evaluated in the FEIR would result in a total worst case energy demand of 45.0 MWh/h when operating at 60 mgd daily maximum in standalone operation under the most extreme operating conditions (cold seawater with elevated salinity).

However, the EPS is being replaced by the Carlsbad Energy Center Project that would use newer and more efficient equipment that would reduce the EPS's contribution of criteria pollutant emissions within the SDAB. Furthermore, electricity provided from the grid to operate the CDP and the proposed modifications would be producing fewer criteria pollutant emissions due to the increase in renewable energy sources mandated by the state's renewable portfolio standard of 33% by 2020. As of 2014, SDG&E is providing 32.2% of its electrical generation requirements from renewable energy sources that do not emit criteria pollutant emissions. Therefore, impacts from indirect criteria pollutant emissions resulting from operation of the CDP with incorporation of the proposed modifications would be less than significant. Impacts in the FEIR were identified as less than significant. Compared to that considered in the FEIR, inclusion of the CDP modifications ~~substantially-incrementally~~ increases the severity of the emissions of air pollutants. The increase in capacity results in an increase in indirect pollutant emissions from increased electricity consumption, which would ~~substantially-incrementally~~ increase the severity of impacts with the incorporation of the proposed CDP modifications. However, the increase would not be such that the determination of significance is altered from the FEIR. The level of significance remains less than significant, particularly considering the increasing contribution of renewable energy sources to SDG&E's energy portfolio.

C. Result in a cumulatively considerable net increase of any criteria pollutant for which the project region is nonattainment under an applicable federal or state ambient air quality standard (including releasing emissions which exceed quantitative thresholds for O₃ precursors)?

In analyzing cumulative impacts from the proposed modifications, the analysis must specifically evaluate a proposed modification's contribution to the cumulative increase in pollutants for which the SDAB is designated as nonattainment for the CAAQS and NAAQS. Though the CDP with incorporation of the proposed modifications does not exceed thresholds and is determined to have less-than-significant project-specific impacts, it could still contribute to a significant

cumulative impact on air quality if the emissions from the proposed modifications, in combination with the emissions from other proposed or reasonably foreseeable future projects, are in excess of established thresholds.

The SDAB has been designated as a federal nonattainment area for O₃ and a state nonattainment area for O₃, PM₁₀, and PM_{2.5}. Construction associated PM₁₀ and PM_{2.5} emissions generally result in near-field impacts. The nonattainment status is the result of cumulative emissions from all sources of these air pollutants and their precursors within the SDAB. As previously discussed, the CDP with incorporation of the proposed modifications would result in less-than-significant impacts to air quality relative to construction and operational direct emissions. However, applying the methodology used in the FEIR, the proposed modifications would generate additional indirect operational emissions from the generation of an increase demand for electricity. The electricity generation may be achieved via power plants within the air basin using fossil fuels, which would generate criteria pollutants for which the air basin is nonattainment. Therefore, applying that rationale, which resulted in finding that the CDP would have a significant indirect cumulative impact to air quality, the inclusion of the proposed modifications would also result in a potentially significant indirect cumulative air quality impact. Impacts in the FEIR were identified as significant. Compared to that considered in the FEIR, inclusion of the CDP modifications ~~substantially~~ incrementally increases the severity of the cumulative emissions of non-attainment criteria air pollutants. The increase in capacity results in an increase in indirect pollutant emissions from increased electricity consumption, which would ~~substantially~~ incrementally increase the severity of impacts with the incorporation of the proposed CDP modifications. However, the increase would not be such that the determination of significance is altered from the FEIR. The level of significance remains the same.

D. Expose sensitive receptors to substantial pollutant concentrations?

In addition to impacts from criteria pollutants, impacts from the proposed CDP modifications may include emissions of pollutants identified by the state and federal government as toxic air contaminants (TACs) or hazardous air pollutants (HAPs). State law has established the framework for California's TAC identification and control program, which is generally more stringent than the federal program, and is aimed at TACs that are a problem in California. The state has formally identified more than 200 substances as TACs, including the federal HAPs, and is adopting appropriate control measures for sources of these TACs.

The greatest potential for TAC emissions during construction would be diesel particulate emissions from heavy equipment operations and heavy-duty trucks, and the associated health impacts to sensitive receptors. The closest sensitive receptors to the project site are single-family residential homes located 0.33 mile south.

Construction of the proposed CDP modifications would not require the extensive use of heavy-duty construction equipment or diesel trucks, which are subject to a CARB Airborne Toxics Control Measure to reduce diesel particulate emissions. Construction of the proposed modifications would occur over 18 months. Following completion of construction activities, TAC emissions would cease. Additionally, the existing CDP does not contain any operational TAC emission sources, and operational emission sources would reflect that of the existing facility during operation of the proposed modifications. As a result, no additional sources of TACs would occur during operation of the CDP with the incorporation of the proposed modifications. Therefore, the proposed CDP modifications would not result in a long-term (i.e., 70-year), permanent source of TAC emissions. No residual TAC emissions are anticipated after construction, nor are any long-term sources of TAC emissions anticipated during operation of the CDP with incorporation of the proposed modifications. As such, the exposure of project-related TAC emission impacts to sensitive receptors would be less than significant. Impacts in the FEIR were identified as less than significant. The increased production capacity would not substantially increase the severity of impacts with the incorporation of the proposed CDP modifications. Therefore, the level of significance remains the same.

E. Create objectionable odors affecting a substantial number of people?

Odors would be generated from vehicles and/or equipment exhaust emissions during construction of the proposed CDP modifications. Odors produced during construction would be attributable to concentrations of unburned hydrocarbons from tailpipes of construction equipment and architectural coatings. Such odors are temporary and for the types of construction activities anticipated for the proposed modifications, would generally occur at magnitudes that would not affect substantial numbers of people. Therefore, impacts associated with odors during construction would be considered less than significant.

Operational odor sources typically occur from certain industrial processes and use of heavy industrial or commercial equipment. Due to the subjective nature of odor impacts, the number of variables that can influence the potential for an odor impact, and the variety of odor sources, there are no quantitative or formulaic methodologies to determine if potential odors would have a significant impact. Examples of land uses and industrial operations that are commonly associated with odor complaints include agricultural uses, wastewater treatment plants, food processing facilities, chemical plants, composting, refineries, landfills, dairies, and fiberglass molding. In addition to the odor source, the distance between the sensitive receptor(s) and the odor source, as well as the local meteorological conditions, are considerations in the potential for a project to frequently expose the public to objectionable odors. Although localized air quality impacts are focused on potential impacts to sensitive receptors, such as residences and schools, other land uses where people may congregate (e.g., workplaces) or uses with the intent to attract people

(e.g., restaurants and visitor-serving accommodations), should also be considered in the evaluation of potential odor nuisance impacts.

The proposed CDP modifications would include upgrades and modifications to the existing on-site facility and would not result in the creation of a land use or process that is associated with nuisance odors. Therefore, operation of the CDP with incorporation of the proposed modifications would result in less than significant odor impacts. Impacts in the FEIR were identified as less than significant. Therefore, the level of significance remains the same.

4.1.4 Mitigation Measures

No mitigation measures are required for direct impacts. For indirect cumulative impacts, no feasible mitigation measures are known.

4.1.5 Level of Significance after Mitigation/Residual Impact

All project direct impacts would be less than significant. No mitigation is required. No feasible mitigation measures are known for the indirect cumulative impacts; therefore, impacts from operation of the CDP with incorporation of the proposed modifications would remain significant and unmitigated, consistent with the conclusions in the FEIR.

4.2 BIOLOGICAL RESOURCES

This section describes the existing regulatory and biological resources setting, identifies significance criteria, evaluates potential biological impacts of the proposed CDP modifications, identifies mitigation measures related to implementation of the CDP, with incorporation of the proposed modifications, and determines significance of impacts.

Due to the limited area of the proposed modifications within an already developed portion of the EPS Precise Development Plan (PDP) area, the potential impacts to terrestrial biological resources would remain the same as that disclosed in the FEIR. As the proposed CDP modifications affect intake and discharge components of the CDP, this section focuses on potential impacts to marine biological resources.

4.2.1 Existing Conditions

Regulatory Setting

The overall regulatory setting associated with undertaking projects and for the project site (and PDP area) has not changed since the time of certification of the FEIR, with the exception of the recent amendment to the state's Water Quality Control Plan for the Ocean Waters of California (Ocean Plan Amendment). Refer to Section 2.3 of this SEIR for a summary of the relevant changes provided in the Ocean Plan Amendment. Refer to Section 4.3 of the FEIR for additional regulations related to biological resources.

Existing Conditions

Terrestrial Environment

On site and surrounding terrestrial resources are as described in the FEIR. Terrestrial resources relevant to the improvement impact footprints consist of developed and ornamental landscaping. Impacts to these resources remain less than significant.

Marine Environment

The site of the proposed CDP modifications includes existing developed areas and infrastructure that extend into the Agua Hedionda Lagoon.

The marine environment is described in the FEIR. Below is a summary of marine species found in the Agua Hedionda Lagoon and the nearshore coastal waters of the Pacific Ocean. The nearest Marine Protected Area or State Water Quality Protection Area is Batiquitos Lagoon, approximately 5 miles south of the CDP. Refer to Section 4.3 of the FEIR for a comprehensive description of the existing marine biological environment.

Aqua Hedionda Lagoon

Marine species known in the Agua Hedionda Lagoon include gobies (*Gobiidae* (CIQ complex)), blennies (*Hypsoblennius* spp.), the state fish Garibaldi (*Hypsypops rubicundus*), topsmelt (*Atherinops affinis*), California halibut (*Paralichthys californicus*), and diamond turbot (*Hypsopsetta guttulata*). In addition, the lagoon is host to an aqua farm that cultivates Mediterranean blue mussels (*Mytilus edulis*), Pacific oysters (*Crassostrea gigas*), and Ogonori seaweed (*Gracilaria* spp.).

As part of Clean Water Act requirements for operation of the EPS, extensive studies of the marine environment of the Agua Hedionda Lagoon and nearshore coastal waters have been conducted. Those studies included taking samples of larvae from within the lagoon in 2004 and 2005 (MBC 2015 – Entrainment Analysis for Dilution and Discharge Options, Appendix K of the NPDES Report to the RWQCB). A total of 20,601 larval fish were taken, with samples predominantly (90%) of gobies and combtooth blennies (*Hypsoblennius* spp.). In particular, a three-species goby complex was the most common taxonomic group. This complex, named CIQ goby, consists of arrow goby (*Clevelandia ios*), cheekspot goby (*Ilypnus gilberti*), and shadow goby (*Quietula y-cauda*).

Pacific Ocean Nearshore Coastal Waters

Marine species known in the nearshore coastal waters include giant kelp (*Macrocystis pyrifera*), Mysid shrimps (*Archaeomysis maculata*, *Metamysidopsis elongate*), Polychaete worms (*Euzonus mucronata*, *Scolelepis acuta*, *Prionospio pygmaeus*), mole crabs (*Emerita analoga*), California halibut (*Paralichthys californicus*), cheekspot goby, walleye surfperch (*Hyperprosopon argenteum*), queenfish (*Seriphus politus*), kelp bass (*Paralabrax clathratus*), California grunion (*Leuresthes tenuis*), northern anchovy (*Engraulis mordax*), pismo clam (*Tivela stultorum*), topsmelt (*Atherinops affinis*), barred surfperch (*Amphisticus argenteus*), and California corbina (*Menticirrhus undulatus*). In addition, the state fish Garibaldi is common to the lagoon and nearshore open coastal waters.

As discussed in the FEIR, larvae samples reported in 2004 and 2005 were also taken from the coastal waters offshore. In those samples, 16,763 larval fish were caught, with 46% of the catch represented by anchovies (northern anchovy (*Engraulis mordax*)). Combtooth blennies and the CIQ goby complex that dominated the lagoon were also relatively plentiful in coastal samples, accounting for a combined 17% of the total. White croaker (*Genyonemus lineatus*), California halibut, queenfish (*Seriphus politus*), and spotfin croaker (*Roncador stearnsii*) were four additional species caught in relatively high abundance in the coastal sampling (Appendix K of the NPDES Report to the RWQCB (MBC 2015)).

Discharge System Configuration

The brine discharge from the desalination plant is combined with the seawater flow from the dilution pumps in the existing EPS discharge tunnel (Figure 10). The concrete tunnel conveys the combined discharge into the existing EPS discharge pond before traveling through box culverts under Carlsbad Boulevard into a riprap-lined channel with a surface discharge into the Pacific Ocean (Figure 2).

Existing Biological Operational Baseline

As discussed in Section 3.3 the actual physical conditions for current operations of the CDP involve use of the EPS discharge water for both production and dilution water. The regulatory permitting process for the EPS under Clean Water Act Section 316(b) assumed that nearly all marine organisms are killed by the thermal and physical effects of the EPS once-through-cooling process and required applicable mitigation. The FEIR assumes 100% mortality of marine organisms in the 304 mgd water used in the once-through cooling water system. However, as noted earlier, in their actions to permit the CDP, the RWQCB and CCC attributed all effects on marine organisms associated with withdrawal of 304 mgd of seawater to the CDP (“long term stand-alone operations”) to be mitigated by Poseidon. Therefore, the operational baseline assumption for the CDP with respect to marine life effects includes use of 304 mgd of seawater and compensation for the loss of marine organisms equivalent to direct withdrawal of the 304 mgd of seawater from Agua Hedionda Lagoon.

4.2.2 Significance Criteria

Marine Environment

Guidance in developing appropriate significance thresholds identified in the FEIR for marine biological resources applicable for components in this SEIR include the following:

- Effects related to impingement, entrapment, and entrainment would be considered significant if the desalination plant operations result in impingement effects (trapping of larger organisms on intake screens), entrapment effects (trapping organisms in the intake tunnel or screen forebay), or entrainment effects (loss of small planktonic organisms passing through cooling water system) that constitute substantial ecological losses to source populations.
- Effects related to salinity would be considered significant if elevated salinity would occur and the project would not be able to satisfy the considerations for brine discharge using flow augmentation (brine dilution) provided in the Ocean Plan Amendment Chapter III.M.3.2.d.2(d)ii, which requires that the facility use low-turbulence intakes and conveyance pipes, and convey and mix dilution water in a manner that limits thermal

stress, osmotic stress, turbulent shear stress, and other factors that could cause intake and mortality of all forms of marine life.²

These generalized concerns encompass the range of potential effects of the CDP on marine organisms, were the primary focus for determination of significant effects in the FEIR, and are the primary focus for evaluating the level of impacts from the CDP with incorporation of the proposed modifications in this SEIR.

4.2.3 Impacts

The site of the proposed CDP modifications includes the existing pier that extends into, or are directly connected to, the Agua Hedionda Lagoon ~~where~~ and one of the fish return options under consideration would discharge water to the Agua Hedionda Lagoon (Agua Hedionda fish return option). The discharges to the and-nearshore open waters of the Pacific Ocean via the discharge pond include the (discharge pond fish return option, brine, backwash water, minor process flows, and flow augmentation~~dilution~~ water), as described in Section 3 of this SEIR. Ambient salinity levels in the lagoon and the nearshore coastal waters are approximately 33.5 parts per thousand (ppt), with an assumed natural variation of 4 ppt as recommended by the U.S. Environmental Protection Agency. Based on water chemistry Agua Hedionda Lagoon meets the Cowardin classification of a marine system, as the salinity is relatively stable at levels consistent with the open ocean.

The EPS and CDP currently affect the existing marine environment through operation of the EPS's once-through cooling system and the CDP's discharge of concentrated brine into the EPS effluent. These effects are regulated through the EPS's NPDES permit and through the CDP's NPDES and Coastal Development Permit. These permits regulate and require compensation for impacts related to impingement and entrainment of marine organisms. For the CDP, the average flow rate regulated through its permits is 304 million gallons per day (mgd). In its findings related to issuance of the Coastal Development Permit for the CDP, the CCC noted the estimated entrainment effects associated with the CDP under stand-alone operations to be approximately 12% of certain fish larvae, with smaller percentages for other species. Both the RWQCB and the CCC relied on an MLMP to address compensation for losses of marine life due to stand-alone operations of the CDP associated with impingement and entrainment of marine organisms. The MLMP is described in more detail in Section 4.2.34, and requires creation, enhancement, or restoration of aquatic and wetland habitat, and ensured long-term performance, monitoring, and

² This is an updated threshold compared to the FEIR, as the state has since adopted the Ocean Plan Amendment that further defines the considerations specific to discharge from desalination plants on the California coast to minimize impacts on marine biological resources.

protection of the approved mitigation. Total acreage compensation to be achieved by the MLMP is 55.4 acres, addressing impacts on all forms of marine life related to the stand-alone operation of the CDP at a flow rate of 304 mgd. Subsequent to approval of the MLMP by the SWRCB, Poseidon voluntarily increased the size of the wetlands project to 66.4 acres to remove any doubt that the wetlands project was capable of addressing the projected impingement and entrainment impacts associated with the CDP.

Marine Environment

Potential Effects during Tie-In Into Existing Inlet and Outlet Tunnels

To implement the improvements two new connections will be made to the existing seawater inlet tunnel and one new connection will be made to the water return tunnel. Work areas will be isolated and dewatered. The existing project required two connections to the water return tunnel. In addition, the standalone operation scenario (separate from the EPS was foreseen during the certification of the FEIR. Therefore, the impacts associated with connecting to the existing on site tunnels have already been evaluated in the FEIR, and determined to be less than significant. No additional biological analysis is necessary.

Potential Effects Related to Entrapment, Impingement and Entrainment

The Desalination Amendment does not define or explicitly regulate entrapment, and entrapment was not evaluated in the FEIR. The U.S. Environmental Protection Agency (USEPA 2014a) defines entrapment in the final 316(b) Rule as follows:

Entrapment means the condition where impingeable fish and shellfish lack the means to escape the cooling water intake. Entrapment includes but is not limited to: Organisms caught in the bucket of a traveling screen and unable to reach a fish return; organisms caught in the forebay of a cooling water intake system without any means of being returned to the source waterbody without experiencing mortality; or cooling water intake systems where the velocities in the intake pipes or in any channels leading to the forebay prevent organisms from being able to return to the source waterbody through the intake pipe or channel.

Based on the federal definition of entrapment, intake systems which provide at least one means of escape for fish are viewed as having eliminated entrapment. The proposed intake/discharge modifications provide two means of escape that will minimize the risk of entrapment that are described in Appendix HH of the Submittal to RWQCB: (i) fish-friendly modified 1-mm traveling water screens with a fish return system; and (ii) by keeping the velocity in the existing EPS tunnels low.

The New Screening/Fish-friendly Pumping Structure will utilize state-of-the-art, 1-mm traveling water screens. The screens specified will have all of the features known to minimize injury and mortality of fishes and organisms (i.e., fish lifting buckets on the screen baskets, low pressure spraywash system to stimulate the movement of fish into a fish return system, and a fish return system to transport collected fish and organisms back to the Lagoon or the EPS discharge pond).

An intake system designed with fish-friendly components provides a means of escape for fish that are unwilling or unable to exit the system through the EPS intake tunnels. The CDP, therefore, does not entrap fish if a means has been provided to “*escape the cooling water intake*”. The EPS intake tunnels were designed for a facility drawing full cooling water flows. At design capacity, the EPS is permitted to withdraw 857 million gallons per day (MGD) of cooling water through the intake tunnels (Tenera 2005). Based on the dimensions of the tunnels, the mean velocity at the maximum design flow would be approximately 7.5 ft/sec. When the EPS goes offline and the CDP enters long-term, stand-alone operation, the total intake flow will decrease to a maximum of 299 MGD. This represents a 65 percent reduction in flow and, therefore, a 65 percent reduction in velocity. The mean tunnel velocity will be approximately 2.6 ft/sec under long-term, stand-alone operation. At this velocity, the potential for fish to escape the intake flow will improve relative to the EPS operation. As shown in Table 4.2-1, Entrapment Minimization Comparison, Entrapment of marine life in the intake/discharge modifications is extremely unlikely. The use of modified 1-mm traveling water screens that are designed to collect and return organisms precludes entrapment. In addition, the intake tunnel velocity will be reduced by approximately 65 percent when the CDP enters long-term stand-alone operation increasing the potential for fish to escape through the intake structure to the lagoon. Therefore, the CDP would avoid entrapment effects, and the entrapment effects would be less than significant.

Table 4.2-1
Entrapment Minimization Comparison

	<u>EPS Intake Structure</u>	<u>CDP Standalone Intake/Discharge Structure Modifications</u>
Inlet Tunnel Length	735 ft	230 ft
Inlet Tunnel Velocity	7.5 ft/sec	2.6 ft/sec
Intake Screen Size	9 mm	1 mm
Through Screen Velocity	Varied with flows often greater than 0.5 fps	0.5 fps or less
Fish friendly screen design	No	Yes
Fish return system with low pressure screen-wash	No	Yes

Impingement is the pinning of larger organisms against the screen mesh by the flow of withdrawn water. The magnitude of impingement losses for any species from intake operation is a function of the involvement of the species with the intake (number or proportion impinged) and the subsequent mortality of those organisms (referred to as impingement mortality). Intake velocity is commonly accepted to be the strongest predictor of impingement. A through-screen velocity of 0.5 feet per second or less has been identified for being protective of impingeable-sized fish. Per the Ocean Plan Amendment, Section 2.d.(1)(c)iv, the SWRCB has prescribed a through-screen velocity of 0.5 feet per second to minimize impingement at surface-water desalination intakes. The screens for the long-term stand-alone CDP intake/discharge structure are designed for 0.5 feet per second or less through-screen velocity, and would, therefore, meet the Ocean Plan Amendment requirement for minimizing impingement at the new screening/fish-friendly pumping structure for the CDP.

The proposed CDP modifications include a fish return system that employs 1-millimeter (mm) mesh on a center-flow traveling water screen oriented perpendicular to the flow; both the ascending and descending sides of the screen provide screening area (Appendix B of the 2015 Submittal to RWQCB). The design increases screening area and reduces the potential for carryover of debris compared to traditional screens. The mesh is also designed to have a smooth surface to minimize the risk of scale loss during impingement. The 1 mm traveling screens have fish lifting buckets attached to the lower section of each screen panel. The buckets provide a sheltered area for organisms may congregate nears the screens and prevent them from becoming trapped against the screen mesh. The buckets are designed to hold water to minimize air exposure during the collection and return process. As the screens and buckets move (travel) continuously, a low-pressure spray wash (less than 20 pounds per square inch) “rinses” the marine organisms gently into the fish return system. The fish return system would consist of a 2-foot-diameter half-round trough where exposed, and 2-foot-diameter pipe where below grade. The velocity in the fish return would be approximately 7 feet per second, with a flow depth of 4 inches. Two cleanouts would be located along its length to facilitate cleaning and inspection of the return pipe.

Depending on the option ultimately selected, the fish return would extend approximately 280 feet from the 1 mm traveling screens to a location in the existing discharge pond that would expedite transfer to the Pacific Ocean, or 382 feet from the 1 mm screens to a quiescent area of the Agua Hedionda Lagoon. The location in the pond best suited for expediting fish return to the Pacific Ocean was determined through hydraulic modeling, as provided in Appendix EE of the Submittal to RWQCB. The lagoon location most suitable for fish return, avoiding risk of re-entrainment, was determined through hydraulic modeling, as provided in Appendix F of the 2015 Submittal to RWQCB. The end of the fish return would be an open trough from an approximately 0-foot elevation msl to below the water level to ensure that fish are returned to the discharge pond or the lagoon under all conditions. The discharge pond fish return system would

extend out into the pond and would be anchored directly to the pond bottom or supported by small piles. The lagoon fish return system would extend into the lagoon below the water surface, adjacent to the existing pier that supports a small dock in this area of the lagoon. The combination of gentle velocities, sufficient radii, and sufficient width and flow depths in the fish return would minimize any potential adverse effects on marine organism as they are returned to the lagoon. Therefore, as shown in Table 4.2-12, Impingement Minimization Comparison, with incorporation of the proposed modifications, the CDP would avoid impingement effects, and impingement effects would remain less than significant.

Table 4.2-12
Impingement Minimize Comparison

	EPS Intake Structure	CDP Standalone Intake/Discharge Structure Modifications
Intake Screen Size	9 mm	1 mm
Through Screen Velocity	Varied with flows often greater than 0.5 fps	0.5 fps or less
Screen w/Fish friendly coating	No	Yes
Fish return system with low pressure screen-wash	No	Yes

Entrainment is the passage of smaller organisms through the screening mesh by the flow of the withdrawn water. The magnitude of entrainment losses for any species from intake operation is a function of the involvement of the species with the intake (number or proportion entrained) and the subsequent mortality of those organisms as they pass through the process equipment (referred to as entrainment mortality). Per the Ocean Plan Amendment (Section 2.d.(1)(c)ii), the SWRCB has prescribed screens with 1 mm mesh to reduce entrainment at surface water desalination intakes. In accordance with the Ocean Plan Amendment, the proposed modifications include 1 mm screens for both the process and brine dilution sides of the new screening/fish-friendly pumping structure. Marine organisms that are too large to pass through the 1 mm screen would be collected in the fish lifting buckets and returned to the discharge pond or Agua Hedionda Lagoon, along with approximately 1 mgd of seawater intake via the fish return system described above.

Table 4.2-23
Entrainment Impact Comparison

	CDP Co-located with EPS	CDP Standalone with Intake/Discharge Modifications
Plant Production Capacity	50 mgd	Up to 60 mgd
Intake Flow	104 mgd	Up to 127 mgd
Dilution Flow (Flow Augmentation)	200 mgd	Up to 171 to 198 mgd
Total Flow	304 mgd	Up to 299 mgd

Table 4.2-23
Entrainment Impact Comparison

	CDP Co-located with EPS	CDP Standalone with Intake/Discharge Modifications
Screen Size	9 mm	1 mm
Through Screen Velocity	Varied with flows often greater than 0.5 fps	0.5 fps or less

¹ No fish screens/all water passed through EPS once-through cooling water system

² 100% entrainment mortality of fish and other organisms small enough to pass through 1-mm fish screens.

Up to 127 mgd of seawater passing through the new screening/fish-friendly pumping structure would be directed to the CDP Intake Pump Station. The larvae that are small enough to pass through the 1 mm screens would be pumped to the pretreatment filters with the seawater that is processed at the CDP and would not survive. The entrained organisms would be removed from the pretreatment filters with the filter media backwash. The previous CDP approvals for stand-alone operation assumed 100% mortality of all the entrained organisms, and mitigation was provided to fully compensate for this loss. With the inclusion of the proposed modifications to the intake that include 1 mm traveling screens and the fish return system, the larvae survival rate is expected to be better than that contemplated in the prior approvals, as shown in Table 4.2-3. As noted above, prior approvals include the RWQCB and CCC actions requiring compensation for losses of all forms of marine life through the MLMP, which addresses a higher flow rate of 304 mgd.

~~Up to~~ Between 171 mgd to 198 mgd of the seawater passing through the new screening/fish-friendly pumping structure would be directed to the CDP flow augmentation system for brine dilution prior to discharge. The proposed modifications include fish-friendly brine dilution pumps to minimize entrainment mortality in waters used for dilution purposes. Fish-friendly pumps were designed for transferring fish in the aquaculture industry, and have been used in fish passage and protection facilities to convey fish to a safe release location. Fish-friendly pumps limit entrained organisms' exposure to the stresses associated with pump passage, including pressure changes, blade strike, and shear. The lift pumps specified for the CDP brine dilution system would be fish-friendly axial flow Bedford pumps (or equal). The low head design of the pumps (approximately 5 pounds per square inch) would minimize the potential for pressure-related injuries. The pump specified for the CDP has been tested with juvenile and adult fish at a full scale for fish-friendliness (Appendix J of the 2015 Submittal to RWQCB).

The entrained organisms are also exposed to shear and turbulence forces during mixing of the brine and dilution flows in the flow augmentation conveyance system. The location of entrained organisms when the dilution and brine flows are mixed would affect whether they would be

exposed to areas of high shear in the discharge tunnel. The mixing point is designed to minimize the creation of high shear zones while still promoting efficient mixing of the two flows.

The CDP brine dilution system was designed to minimize shear and turbulence by specifying fish-friendly equipment and designing the new discharge conveyance system to minimize hydraulic disturbances that can contribute to excessive turbulence and shear. The system was designed for the dual purposes of efficiently mixing the brine and dilution flows and for minimizing the potential for injury and mortality of entrained organisms. The following features of the brine dilution system were designed to ensure compliance with the requirements to minimize shear and turbulence:

- Fish-friendly axial flow pumps
- Hydraulically optimized discharge from pumps to flow conveyance piping to reduce the risk of shear
- Long-radius bends to minimize turbulence and shear at junctions
- Gradual expansions and contractions in flow conveyances to gradually increase/decrease flow velocity to reduce the risk of shear
- Flow conveyances sized to minimize in-pipe velocity that reduces the risk of shear

The previous CDP approvals (i.e., RWQCB and CCC permits) for stand-alone operation and flow rate of 304 mgd assumed 100% mortality of all the organisms entrained in the brine dilution system, and required mitigation provided through the MLMP to fully compensate for this loss. With the inclusion of the proposed modifications to the intake that include 1 mm traveling screens, the fish return system, fish-friendly axial flow pumps, and a lower overall flow rate, the larvae survival rate is expected to be better than that contemplated in the prior approvals, and is already fully compensated through the MLMP.

The proposed modifications to the new screening/fish-friendly pumping structure components use the best available technologies and design to result in improved survival of marine organisms entrained in the system by reducing the number of organisms through the improved traveling screen and fish return system, and providing fish-friendly pumping of brine dilution waters (no longer passing through EPS). The species and proportionality of those species entrained would be generally consistent with that established in the FEIR, although the total intake volume would be reduced from 304 mgd to 299 mgd with the proposed modifications. Accordingly, the FEIR finding that the small proportion of marine organisms lost to entrainment as a result of the CDP would not have a substantial effect on the species' ability to sustain their populations because of their widespread distribution and high reproductive potential remains accurate with

implementation of the proposed modifications. Species of direct recreational and commercial value constitute less than 1% of the entrained organisms, and considering that, in general, less than 1% of all fish larvae become reproductive adults, operation of the CDP with incorporation of the proposed modifications would not result in significant impacts on those species' populations. Impacts in the FEIR were identified as less than significant. Compared to that considered in the FEIR, inclusion of the CDP modifications substantially reduces the severity of the impingement and entrainment impacts with the reduction in flow, velocity, screen slot size, inclusion of the fish return system, fish friendly pumps, and measures to reduce hydraulic shear and turbulence, and is biologically superior to the co-located CDP. The determination of significance related to impingement and entrainment impacts is not altered from the FEIR. The level of significance remains the same, less than significant.

Potential Effects from Elevated Salinity

The potential effect of varying salinity levels on sensitive larval-stage marine organisms was studied by Nautilus Environmental (Appendix I of the 2015-Submittal to RWQCB). The study focused on the potential effects of salinity fluctuations on organisms traveling into the intake from ambient seawater in the receiving environment through the brine dilution systems of the CDP, and then being discharged back into the receiving water (i.e., the Pacific Ocean). Species evaluated for this study included red abalone (*Haliotis rufescens*) development and purple sea urchin (*Strongylocentrotus purpuratus*) development. These species were identified as two of the most sensitive to elevated salinity levels relative to other monitored species in the Ocean Plan, based on previous studies and using standard U.S. Environmental Protection Agency whole effluent toxicity tests (Philips et al. 2012).

The study determined the salinity-induced adverse effects to these organisms as they travel through the brine dilution system as proposed. The study assessed several potential operating scenarios involving differing salinity levels and residence (or exposure) times that were within the plant's operational capabilities. Procedures were established to simulate the salinity fluctuations an organism might experience as it moves through the brine dilution system, encountering elevated salinity as the brine discharge is mixed with seawater from the brine dilution system, then a reduction in salinity to 35.5 ppt as it travels through the discharge system to the edge of the brine mixing zone (BMZ), and finally a reduction from 35.5 ppt to ambient salinity (33.5 ppt). The BMZ is the area where salinity may exceed 2.0 ppt above ambient salinity, or the concentration of salinity approved as part of an alternative receiving water limitation. Hence, outside of the BMZ, salinity cannot exceed 2 ppt over ambient background salinity. Within the BMZ, entrained organisms would experience elevated salinity. The BMZ for the CDP is a 200-meter (656-foot) semi-circle originating from the terminus of the discharge tunnel in the ocean, as established by the Ocean Plan Amendment Section III.M.3.d. The benthic area (i.e., the sea floor area) encompassed by the BMZ would be approximately 15.5 acres. The

BMZ is a smaller regulated area than the Zone of Initial Dilution (ZID) required by the applicable regulations in effect at the time of the FEIR, which was 1,000 feet.

Hydrodynamic modeling was conducted by Alden Research Laboratory (Appendix L of the 2015 Submittal to RWQCB) and Scott Jenkins (Appendix C of the 2015 Submittal to RWQCB) to determine the duration of larval exposure to elevated salinity with implementation of the proposed modifications. Table 4.2-34, Test Summary for Brine Dilution Study, presents the matrix of durations based on varying flows at the CDP during average ocean conditions. These exposure durations formed the basis of the salinity tolerance testing phases and scenarios. Three distinct phases are common to each exposure scenario:

- Phase 1 simulated the initial mixing of brine with seawater from the brine dilution system. The salinity of the dilution water was raised from ambient seawater (33.5 ppt) by adding 67 ppt brine at a rate calculated to reach 42 ppt salinity within approximately 1 minute, and then held there for a specified amount of time (1.7 to 2.8 minutes depending on the scenario being tested).
- Phase 2 simulated the dilution that occurs in the mixing pond and out to the edge of the BMZ. This simulation involved the continuous addition of ambient seawater at a rate calculated to reach 35.5 ppt within a specified period (34 to 39 minutes depending on the scenario being tested).
- Phase 3 simulated the dilution that occurs outside of the BMZ. This simulation involved the continuous addition of ambient seawater at a rate calculated to reach 33.5 ppt in 30 minutes.

The various scenarios tested, the species tested, the test dates, and a results summary are provided in Table 4.2-34.

Table 4.2-34
Test Summary for Brine Dilution Study

Scenario No.	Scenario Description	Test Date	Species Tested	Mean % Normal Development			
				Sample	Phase 1	Phase 2	Phase 3
1	P1: 44 ppt for 2.8 minutes (min.) P2: 39 min.; P3: 30 min.	2/6/15	Abalone Development	Control	83.8	77.7	80.5
				Brine Exposure	76.7*	79.1	78.8
1	P1: 44 ppt for 2.8 min. P2: 39 min.; P3: 30 min.	2/17/15	Urchin Development	Control	93.7	92.0	89.3
				Brine Exposure	91.3	90.3	91.3
2	P1: 42 ppt for 2.2 min. P2: 36 min.; P3: 30 min.	1/30/15	Abalone Development	Control	94.0	93.7	94.3
				Brine Exposure	95.7	92.7	91.7

Table 4.2-34
Test Summary for Brine Dilution Study

Scenario No.	Scenario Description	Test Date	Species Tested	Mean % Normal Development			
				Sample	Phase 1	Phase 2	Phase 3
3	P1: 40 ppt for 1.7 min. P2: 34 min.; P3: 30 min.	1/22/15	Abalone Development	Control**	66.0	61.0	67.3
				Brine Exposure	68.5	67.0	60.3

Source: Appendix I of the 2015 Submittal to RWQCB

P1, P2, P3 = Phase 1, 2, and 3; ppt = parts per thousand

* A statistically significant decrease compared to the control ($p < 0.05$).

** The abalone test Scenario #3 conducted on January 22, 2015, did not meet the 80% test acceptability criterion for normal development in the control; see QA section of Appendix I of the 2015 Submittal to RWQCB.

None of the three scenarios resulted in statistically significant effects after Phase 3 compared to the control exposure ($p < 0.05$). In all exposure scenarios, replicates were terminated after each of the phases. There was one statistically significant effect ($p < 0.05$) that was detected in Phase 1 of Exposure Scenario #2. However, the effect was small (8.5% compared to the Phase 1 control results), and there were no statistically significant effects observed in Phase 2 or 3 of this exposure compared to the controls. Since the organisms that were exposed to more than just the first phase of the test showed no significant effects, the study concluded that this finding was not due to the treatment itself. Although urchins were tested only with Scenario #1, the similarity of results to those obtained for abalone indicates that the abalone results are predictive of urchin results.

Any larval species “taken” from the lagoon would be exposed to elevated salinity levels through the brine dilution process, but the amount of time would not substantially affect larval development. Therefore, the impacts associated with exposure to varying salinity levels on sensitive larval-stage marine organisms traveling through the CDP brine dilution systems and then being discharge back into the Pacific Ocean would be less than significant.

Studies were also conducted that evaluated the acute toxicity effects of elevated ambient salinity levels of species in nearshore coastal waters, including mysid shrimp (*Americamysis bahia*) and Pacific topsmelt (*Atherinops affinis*) (Appendix G of the 2015 Submittal to RWQCB). No significant effects were recorded for Pacific topsmelt at any of the salinity concentrations. Significant effects in the percent normal development of mysid shrimp were recorded at saline concentrations of 44 ppt or greater. Ambient salinity levels resulting from the proposed CDP modifications would be less than 44 ppt; therefore, no impacts to shrimp from salinity levels are anticipated. Salinity is projected to be 42 ppt within the discharge pond, which is discharged into the Pacific Ocean. Ambient saline concentrations at the outer edge and beyond the 656-foot BMZ were modeled to be equal to or no more than 2 ppt more than existing ambient levels of 33.5 ppt (Appendix ~~BBG~~ of the 2015 Submittal to RWQCB). Salinity Ambient levels (calculated using

20.5-year dilution simulations) will average 35.5 ppt salinity concentrations at the outer edge of the 656-foot BMZ, unless the RWQCB approves an alternative facility-specific receiving water limitation, in which case the salinity level would not exceed 36.5 ppt. In either case, the salinity level would be~~which is~~ less than the 38.4 ppt salinity level threshold established in the FEIR.

The proposed CDP modifications, including the potential increased capacity, satisfy the considerations for brine discharge using flow augmentation (brine dilution) provided in the Ocean Plan Amendment. All components were designed to minimize mortality to marine organisms. Specifically, the modifications would include maintaining low velocities for intake of 0.5 feet per second or less at the intake screens, which would have 1 mm slot openings per the Ocean Plan Amendment, for both process water and dilution water. To achieve the necessary reduction salinity levels approximately 171 MGD to 199 MGD of the 299 MGD water passing through the intake screens would be directed to the fish-friendly low-impact axial flow (or equivalent) pumps for dilution water conveyance. The dilution water would mix directly with the brine in the discharge tunnel and the discharge pond seawater prior to discharge through the existing discharge tunnel into the Pacific Ocean. The discharged water would intermixed with ocean water which would dilute it to within 2 ppt of background salt content levels (35.5 ppt) at the edge of the approximately 656-foot BMZ, or to within 3 ppt of background salt content levels (36.5 ppt) at the edge of the approximately 656-foot BMZ if the RWQCB determines a facility-specific alternative salinity receiving water limitation is adequately protective of beneficial uses of the Pacific Ocean. The chronic toxicity test results contained in (Appendix H of the Submittal to RWQCB) Table 4.2-1-3 suggest that the CDP qualifies for a facility-specific alternative receiving-water limitation in accordance with Section III.M.3.d of the Ocean Plan Amendment.

Furthermore, the stand-alone facility would not involve substantial thermal increase or resultant stress, and the intake includes a fish return system to deliver marine organisms from the intake screens to the discharge pond or Agua Hedionda Lagoon thus diverting them from exposure to higher salinity levels. Therefore, the impacts from exposure to elevated salinity levels to marine species in nearshore coastal waters as a result of brine discharge would be less than significant. The establishment of a reduction in the regulated ~~Brine Mixing Zone (BMZ)~~ for area for brine dilution within the Pacific Ocean (1,000-foot ZID to 656-foot salinity increase of no more than 2 ppt over natural background salinity at the outside edge of the BMZ, or to within 3 ppt if the RWQCB determines a facility-specific alternative salinity receiving water limitation is adequately protective of beneficial uses of the Pacific Ocean), represents a change in existing permit requirements for the project (daily average salinity not to exceed 40 ppt in the discharge pond)~~substantial increase in the severity of salinity impacts to marine biology because the parameter around which the dilution is measured has been reduced.~~ However, the determination

of significance related to marine biology impacts is not altered from the FEIR, which were also identified as less than significant.

Fish Return

The fish return system is a project design feature intended to allow for organisms to be returned to the discharge pond or the lagoon. The through screen velocities represent the best available technology for minimizing impingement associated with the intake and discharge modifications. Depending on the option ultimately selected, the fish return would extend approximately 280 feet from the 1 mm traveling screens to a location in the existing discharge pond that would expedite transfer to the Pacific Ocean, or 382 feet from the 1 mm traveling screens to a quiescent area of the Agua Hedionda Lagoon.

Discharge Pond Fish Return Option

The fish return system would include installation of a new submerged pipe structure extending into the discharge pond and would be anchored directly to the pond bottom or supported by small piles. Temporary impacts to install the fish return system would include trenching in paved and ornamental vegetation areas or directional drilling, with staging accommodated on existing paved areas. The area of the pond bank that would be stabilized to support the emergence of the fish return system into the pond is currently a rip-rap bank adjacent to the abutment for the Carlsbad Boulevard crossing over the pond outlet to the Pacific Ocean. The offshore construction would be confined to the existing discharge pond that is serving the EPS once-through cooling water circulation system. Temporary construction effects to water quality would be minimized through BMPs that would control direct and indirect construction effects. Therefore, no significant impacts to marine organisms within the discharge pond or Pacific Ocean would result from construction or operation of the proposed discharge pond fish return system. These activities are also subject to review under Sections 10 of the Rivers and Harbors Act and Section 401 of the federal Clean Water Act.

Operation of the discharge pond fish return system would use approximately 1 mgd of fish screen wash/fish return water with a velocity of approximately 7 feet per second to be discharged back into the pond approximately 6 feet from the shoreline. No impacts would result from operation of the fish return pipe because the discharge would consist of lagoon water (from the intake process), including fish and larvae species and debris that are currently discharged to this location by the EPS.

The potential effects of elevated salinity on sensitive larval-stage marine organisms was studied by Nautilus Environmental (Appendix I of the Submittal to RWQCB). As noted in the summary of this study in the discussion of the potential effects of elevated salinity presented above, exposure of

sensitive marine organisms to elevated salinity while being transported from the fish return to the Pacific Ocean via the discharge would not substantially affect the organisms' development and would not result in increased mortality. Therefore, the impacts associated with exposure to elevated salinity levels on sensitive larval-stage marine organisms returned to the discharge pond prior to being discharge back into the Pacific Ocean would be less than significant.

Another aspect of the potential effect of sensitive larval-stage marine organisms being transported from the outer lagoon to the Pacific Ocean via the fish return system was studied by Jenkins (Appendix GG of the Submittal to RWQCB). Jenkins study focused on the potential effects of returning larval organisms to the ocean via the discharge pond rather than returning the organisms back to their original habitat in the lagoon. Specifically, Jenkins modeled the potential effects of the Project on the movement and residence time of three species of Goby (*Clevelandia*, *Ilypnus*, and *Quietula*), generally referred to as the CIQ Goby Complex. The non-motile CIQ Goby is a weak swimmer and is easily transported in and out of the lagoon by tidal exchange. Jenkins concluded that were the CIQ Goby residing in the outer lagoon not transported to the ocean via the fish return system, 50% of the population would have been flushed to the ocean within six hours, and 98% of the population would be transported to the ocean within 2.5 days. These changes in residence time represent a minor and insignificant fraction of the life cycle of the CIQ Goby. Therefore, the impacts associated with returning larval organisms from the outer lagoon to the discharge pond would be less than significant.

Impacts in the FEIR to marine biology were identified as less than significant. Compared to that considered in the FEIR, inclusion of the fish return system as part of the CDP modification identifies no new physical impact that was not foreseen and not analyzed in the FEIR. The construction and operation of the fish return system in the discharge pond in conjunction with the proposed CDP modifications does not represent a substantial increase in the severity of impacts to marine biology from the FEIR. The level of significance of impacts to marine biology with the inclusion of the fish return system to the marine environment remains the same, less than significant.

Agua Hedionda Lagoon Fish Return Option

The lagoon location most suitable for fish return, avoiding risk of re-circulation, was determined through hydraulic modeling, as provided in Appendix F of the Submittal to RWQCB. The lagoon fish return system would include installation of a new submerged pipe structure adjacent to the existing pier within the Agua Hedionda Lagoon. This site was selected for the lagoon fish return option as it is a quiescent area of the lagoon where returned marine organisms would not be subject to re-entrainment into the intake tunnel (Appendix ~~FK~~ of the 2015-Submittal to RWQCB). The 2-foot diameter pipe and minor bank stabilization where the pipe would emerge from land, and extend approximately 506-feet into the lagoon from the shoreline to ensure

sufficient water depth during low water and would be subject to a Nationwide Permit by the U.S. Army Corps of Engineers in accordance with the Rivers and Harbors Act Section 10 and the Clean Water Act Section 404. Design approaches for the submerged pipe section include attaching it to the existing support piles of the existing pier structure; constructing new, small support pilings; or ~~supported by small piles anchoring it directly to~~ on the lagoon floor. All options would occur within the same area and reflect methods for stabilizing the pipe in that location. ¶The area of the lagoon bank that would be stabilized to support the emergence of the fish return system into the lagoon is currently modified sandy bank with sporadic rocks, adjacent to the paved area and wall from which the pier extends. Temporary impacts to install the fish return system would include trenching in paved and ornamental vegetation areas or directional drilling, with staging accommodated on existing paved areas. The submerged portion of the fish return system in the lagoon would either be attached to the pilings ~~off~~ the existing pier or secured to the sandy bottom of the lagoon adjacent to the pier. Construction of the submerged portion within Agua Hedionda Lagoon and the associated shoreline stabilization would be conducted using best management practices (BMPs), including sediment screening, filtration, and proper handling and storage of construction equipment and materials. The final selection of BMPs would be made based on determination of the appropriate design approach for the submerged pipe section. Construction of the fish return system would not result in significant permanent impacts because it would involve only minor construction where the pipe enters the lagoon and approximately 10 square feet of bank stabilization at that location. Temporary construction effects to water quality would be minimized through BMPs that would control direct and indirect construction effects. Therefore, no significant impacts to marine organisms within Agua Hedionda Lagoon would result from construction or operation of the proposed lagoon fish return system. These activities are also subject to review under Sections 401 and 404 of the federal Clean Water Act and may be subject to review under Section 1602 of the California Fish and Game Code.

Operation the fish return system would use approximately 1 mgd of fish screen wash/fish return water with a velocity of approximately 7 feet per second to be discharged back into the lagoon at a quiescent point approximately 205 feet from the intake tunnel to avoid recirculation of fish and other organism. No impacts would result from operation of the fish return pipe because the discharge would consist of lagoon water (from the intake process), including fish and larvae species and debris.

Impacts in the FEIR to marine biology were identified as less than significant. Compared to that considered in the FEIR, inclusion of the lagoon fish return system as part of the CDP modification identifies a physical impact to the Agua Hedionda Lagoon that was not foreseen and not analyzed in the FEIR. The new impacts associated with construction of the fish return

system with the incorporation of the proposed CDP modifications, represents an substantial incremental increase in the severity of impacts to the marine biology because of the introduction of additional fill and construction within Agua Hedionda Lagoon. However, the increase would still not reach a level of significance, and impacts to marine biology are not altered from the FEIR. The level of significance of impacts to marine biology with the inclusion of the fish return system to the marine environment remains the same, less than significant.

4.2.4 Mitigation Measures

RWQCB and CCC Requirements

As described above, no significant impacts were identified pursuant to the CEQA or the thresholds set out above. Nonetheless, an MLMP for the CDP was approved by the RWQCB pursuant to the conditions set forth in Order R9-2009-0038. The MLMP sets forth a plan for further reducing and monitoring impacts due to entrainment from the CDP as a means of complying with Water Code 13142.5(b). The MLMP was developed by Poseidon in consultation with multiple resource agencies, including the RWQCB, and was approved by the CCC; the final revised language for the MLMP was approved by the CCC on December 10, 2008. The MLMP was written for long-term stand-alone operation, and proposes phased implementation of up to 55.4 acres of wetland mitigation within the Southern California Bight. Phase I requires creation of 37 acres of wetlands and Phase II requires an additional 18.4 acres that Poseidon may propose to eliminate or reduce if it proposes alternative measures, such as new entrainment-reduction technology or credits for dredging.

As part of compliance with the NPDES Permit for the CDP, Poseidon developed a Flow, Entrainment, and Impingement Minimization Plan (Appendix P of the 2015 Submittal to RWQCB) (Minimization Plan). The purpose of the Minimization Plan is to minimize the impingement and entrainment of marine life associated with the intake of seawater for desalination. The Minimization Plan assesses the feasibility of site-specific plans, procedures, and practices to be implemented and/or mitigation measures to minimize the impacts to marine organisms, including those listed in the MLMP. The Minimization Plan, incorporating the MLMP, would fully offset the projected entrainment and impingement losses for approximately 304 mgd of source water withdrawn directly from the Agua Hedionda Lagoon under conditions of stand-alone operation. Considering the March 27, 2009 Minimization Plan, the RWQCB found that the proposed measures for the CDP is the best available Water Code Section 13142.5(b) mitigation feasible for the CDP.

The CCC approved the MLMP to fully compensate for the impacts associated with permanent stand-alone operations. The RWQCB findings of approval of the MLMP were specific to the co-

located and temporary standalone operations. The RWQCB will determine the appropriate mitigation requirements to compensate for the intake and mortality of all forms of marine life associated with the construction and operation of the long-term stand-alone facility when it makes the California Water Code section 13142.5(b) determination. As part of this process, the RWQCB will assess whether to account for previously-approved mitigation as part of the mitigation for stand-alone operations of the CDP.

Subsequent to approval of the MLMP by the SWRCB, Poseidon voluntarily increased the size of the wetlands project to 66.4 acres to remove any doubt that the wetlands project was capable of addressing the projected impingement and entrainment impacts associated with the CDP.

In September 2010, Poseidon entered into a Memorandum of Understanding with the U.S. Fish and Wildlife Service (USFWS) to locate the wetlands restoration project in the San Diego National Wildlife Restoration Complex at the south end of San Diego Bay. Since 2010, Poseidon, USFWS, SWRCB, and the CCC's Science Advisory Panel have been working to advance the planning, permitting, and design of the wetlands restoration project.

On March 9, 2011, the RWQCB adopted Resolution R9-2011-0028 approving the preliminary wetlands restoration plan and selection of the Otay River Floodplain Wetland Mitigation Site to mitigate for entrainment and impingement impacts of the CDP. The total MLMP acreage established for the approved CDP is 66.4 acres. The specific location selected, Otay River Floodplain and Pond 15 in the South Bay of San Diego Bay, is the subject of an environmental impact statement, to be released by USFWS later this year.

As a result of the proposed modifications, the mortality rate for marine organisms entrained from intake to discharge is expected to be reduced compared to that established in the FEIR and MLMP. In addition, the average annual flows entering the intake tunnel would be reduced from 304 mgd to 299 mgd with implementation of the proposed modifications. The Ocean Plan states that for conditionally approved or expanded facilities such as the CDP, the RWQCB may account for previously approved mitigation projects associated with a facility when making a new Water Code 13142.5(b) determination, and require additional mitigation for any additional mortality of all forms of marine life resulting from the occurrence of the conditional event (i.e., transition to stand-alone operation). Since the transition to stand-alone operation of the CDP would not result in any additional impacts to marine life, the previously approved MLMP provides appropriate minimization measures in accordance with the Ocean Plan Amendment and CCC requirements for the CDP under the stand-alone conditions with implementation of the proposed modifications.

No additional marine biological resources mitigation measures beyond those required by the FEIR prior approvals are required, specifically monitoring and reporting CDP discharge flow rates and salinity levels. In addition, Poseidon would continue to implement the minimization measures identified in the MLMP as required during the permitting process by the RWQCB and CCC. While continuing to consider the worst-case conservative estimate of 100% mortality, which assumes greater effects than those resulting from the proposed modifications, the creation of approximately 66.4 acres (Appendix A of the 2015 Submittal to RWQCB) of compensation is required, including the voluntary increase committed to by the applicant after the original CDP approvals.

4.2.5 Level of Significance after Mitigation/Residual Impact

All impacts to marine biological resources would remain less than significant with implementation of the mitigation measures required by the FEIR, specifically monitoring and reporting CDP discharge flow rates and salinity levels. The mitigation measure would reduce impacts to below the level of significance consistent with FEIR. No new mitigation is required.

4.3 GREENHOUSE GAS EMISSIONS

This section describes the existing greenhouse gas (GHG) setting, identifies associated regulatory requirements, evaluates potential impacts, and identifies mitigation measures related to implementation of the CDP with incorporation of the proposed modifications.

4.3.1 Existing Conditions

Although the FEIR did not specifically quantify GHG emissions for the CDP, GHG emissions were addressed in the First Addendum to the FEIR and through the CCC's approval of the CDP's Energy Minimization and Greenhouse Gas Reduction Plan (Energy Minimization and GHG Reduction Plan). As described on page 14 of the First Addendum to the FEIR, various entities had extensively studied and regulated GHG emissions before certification of the FEIR in June 2006, including both the legislative and executive branches of the state of California. For example, in 2002, California passed legislation regulating GHG emissions from cars and trucks (Assembly Bill 1493), and in June 2005, Governor Arnold Schwarzenegger issued Executive Order S-3-05, which set statewide GHG emissions targets for 2010, 2020, and 2050, and ordered many executive branch agencies to take immediate action to meet those targets. In 2006, the California Legislature adopted Assembly Bill (AB) 32, the California Global Warming Solutions Act of 2006.

The current regulations and existing conditions related to climate change and GHG emissions are described below.

Regulatory Setting

State of California

Executive Order S-3-05. In June 2005, Governor Schwarzenegger established California's GHG emissions reduction targets in Executive Order S-3-05. The executive order established the following goals: GHG emissions should be reduced to 2000 levels by 2010, GHG emissions should be reduced to 1990 levels by 2020, and GHG emissions should be reduced to 80% below 1990 levels by 2050.

Assembly Bill 32. In furtherance of the goals established in Executive Order S-3-05, the legislature enacted AB 32 (Núñez and Pavley), the California Global Warming Solutions Act of 2006, which Governor Schwarzenegger signed on September 27, 2006. The GHG emissions limit is equivalent to the 1990 levels, which are to be achieved by 2020.

CARB has been assigned to carry out and develop the programs and requirements necessary to achieve the goals of AB 32. Under AB 32, CARB must adopt regulations requiring the reporting and verification of statewide GHG emissions. This program will be used to monitor and enforce compliance with the established standards. CARB is also required to adopt rules and regulations to achieve the maximum technologically feasible and cost-effective GHG emissions reductions. AB 32 allows CARB to adopt market-based compliance mechanisms to meet the specified requirements. CARB is ultimately responsible for monitoring compliance and enforcing any rule, regulation, order, emissions limitation, emissions reduction measure, and market-based compliance mechanism adopted.

On December 11, 2008, CARB approved the Climate Change Proposed Scoping Plan: A Framework for Change (Scoping Plan) (CARB 2008) to achieve the goals of AB 32. The Scoping Plan establishes an overall framework for the measures that will be adopted to reduce California's GHG emissions. The Scoping Plan evaluates opportunities for sector-specific reductions, integrates all CARB and Climate Action Team early actions and additional GHG reduction measures by both entities, identifies additional measures to be pursued as regulations, and outlines the role of a cap-and-trade program.

The key elements of the Scoping Plan are as follows:

- Expanding and strengthening existing energy efficiency programs and building and appliance standards.
- Achieving a statewide renewables energy mix of 33%.
- Developing a California cap-and-trade program that links with other Western Climate Initiative partner programs to create a regional market system and caps sources contributing 85% of California's GHG emissions.
- Establishing targets for transportation-related GHG emissions for regions throughout California, and pursuing policies and incentives to achieve those targets.
- Adopting and implementing measures pursuant to existing state laws and policies, including California's clean car standards, goods movement measures, and the Low Carbon Fuel Standard.
- Creating targeted fees, including a public goods charge on water use, fees on high global-warming-potential gases, and a fee to fund the administrative costs of California's long-term commitment to AB 32 implementation.

CARB is required to update its Scoping Plan at least once every 5 years (Health and Safety Code, Section 38561(h)). The First Update to the Climate Change Scoping Plan (Scoping Plan

Update) (CARB 2014a) was approved by the CARB Board on May 22, 2014. The Scoping Plan Update also recommends that a statewide mid-term target and mid-term and long-term sector targets be established toward meeting the 2050 goal established by Executive Order S-3-05 to reduce California's GHG emissions to 80% below 1990 levels, although no specific recommendations are made.

Executive Order B-30-15. On April 29, 2015, Governor Jerry Brown issued an Executive Order that identified an interim GHG reduction target in support of targets previously identified under Executive Order S-3-05 and AB 32. Executive Order B-30-15 set an interim target goal of reducing GHG emissions to 40% below 1990 levels by 2030 to keep California on its trajectory toward meeting or exceeding the long-term goal of reducing GHG emissions to 80% below 1990 levels by 2050 as set forth in Executive Order S-3-05. To facilitate achievement of this goal, Executive Order B-30-15 calls for an update to CARB's Scoping Plan to express the 2030 target in terms of million metric tons of CO₂E. CARB subsequently expressed its intention to initiate the Scoping Plan Update during summer 2015, with adoption scheduled for 2016.

Senate Bill 97. In August 2007, the legislature enacted SB 97 (Dutton), which directs the Governor's Office of Planning and Research (OPR) to develop guidelines under CEQA for the mitigation of GHG emissions. On June 19, 2008, OPR issued a technical advisory as interim guidance regarding the analysis of GHG emissions in CEQA documents (OPR 2008). The advisory indicated that a project's GHG emissions, including those associated with vehicular traffic, energy consumption, water usage, and construction activities, should be identified and estimated. The advisory further recommended that the lead agency determine significance of the impacts and impose all mitigation measures that are necessary to reduce GHG emissions to a level that is less than significant.

On April 13, 2009, OPR submitted to the Natural Resources Agency its proposed amendments to the CEQA Guidelines relating to GHG emissions. The Natural Resources Agency adopted the CEQA Guidelines Amendments and the amendments became effective on March 18, 2010. The amended guidelines establish several new CEQA requirements concerning the analysis of GHGs, including the following:

- Requiring a lead agency to "make a good faith effort, based to the extent possible on scientific and factual data, to describe, calculate or estimate the amount of GHG emissions resulting from a project" (Section 15064(a)).
- Providing a lead agency with the discretion to determine whether to use quantitative or qualitative analysis or performance standards to determine the significance of GHG emissions resulting from a particular project (Section 15064.4(a)).

- Requiring a lead agency to consider the following factors when assessing the significant impacts from greenhouse gas emissions on the environment:
 - The extent to which the project may increase or reduce greenhouse gas emissions as compared to the existing environmental setting.
 - Whether the project emissions exceed a threshold of significance that the lead agency determines applies to the project.
 - The extent to which the project complies with regulations or requirements adopted to implement a statewide, regional, or local plan for the reduction or mitigation of GHG emissions (Section 15064.4(b)).
- Allowing lead agencies to consider feasible means of mitigating the significant effects of GHG emissions, including reductions in emissions through the implementation of project features or off-site measures, including offsets that are not otherwise required (Section 15126.4(c)).

The amended guidelines also establish two new guidance questions regarding GHG emissions in the Environmental Checklist set forth in CEQA Guidelines Appendix G:

- Would the project generate greenhouse gas emissions, either directly or indirectly, that may have a significant impact on the environment?
- Would the project conflict with an applicable plan, policy, or regulation adopted for the purpose of reducing the emissions of greenhouse gases?

The adopted amendments do not establish a GHG emission threshold, and instead allow a lead agency to develop, adopt, and apply its own thresholds of significance or those developed by other agencies or experts.³ The Natural Resources Agency also acknowledged that a lead agency may consider compliance with regulations or requirements implementing AB 32 in determining the significance of a project's GHG emissions.⁴

³ “The CEQA Guidelines do not establish thresholds of significance for other potential environmental impacts, and SB 97 did not authorize the development of a statement threshold as part of this CEQA Guidelines update. Rather, the proposed amendments recognize a lead agency's existing authority to develop, adopt and apply their own thresholds of significance or those developed by other agencies or experts” (CNRA 2009, p. 84).

⁴ “A project's compliance with regulations or requirements implementing AB 32 or other laws and policies is not irrelevant. Section 15064.4(b)(3) would allow a lead agency to consider compliance with requirements and regulations in the determination of significance of a project's greenhouse gas emissions” (CNRA 2009, p. 100).

Senate Bill 375. In August 2008, the legislature passed and on September 30, 2008, Governor Schwarzenegger signed SB 375 (Steinberg), which addresses GHG emissions associated with the transportation sector through regional transportation and sustainability plans. Under SB 375 regional metropolitan planning organizations are responsible for preparing a Sustainable Communities Strategy within their Regional Transportation Plans (RTP/SCS). The goal of the SCS is to establish a development plan for the region, which, after considering transportation measures and policies, will achieve, if feasible, the GHG reduction targets. On September 23, 2010, CARB adopted the SB 375 targets for regional metropolitan planning organizations. The targets for the SANDAG are a 7% reduction in emissions per capita by 2020 and a 13% reduction by 2035. Achieving these goals through adoption of a Sustainable Communities Strategy will be the responsibility of the metropolitan planning organizations.

Senate Bill X1 2. On April 12, 2011, Governor Jerry Brown signed SB X1 2 in the First Extraordinary Session to expand the Renewable Portfolio Standard by establishing a goal of 20% of the total renewable electricity sold to retail customers in California per year by December 31, 2013, and 33% by December 31, 2020, and in subsequent years. Under the bill, a renewable electrical generation facility is one that uses biomass, solar thermal, photovoltaic, wind, geothermal, fuel cells using renewable fuels, small hydroelectric generation of 30 megawatts or less, digester gas, municipal solid waste conversion, landfill gas, ocean wave, ocean thermal, or tidal current, and that meets other specified requirements with respect to its location.

Senate Bill 350. Senate Bill 350 requires the state to double energy efficiency savings in electricity and natural gas by retail customers by 2030, and increases the Renewables Portfolio Standards so that half of the state's electricity be procured from renewable sources by 2030.

Local

San Diego Association of Governments 2050 Regional Transportation Plan/Sustainable Communities Strategy. In October 2015, SANDAG adopted the San Diego Forward Regional Plan, which includes a Regional Transportation Plan (RTP) and Sustainable Communities Strategy (SCS).⁵ The RTP and the SCS detail the region's planned transportation system and discuss how the region will reduce GHG emissions to state-mandated levels over time.

⁵ A prior RTP/SCS, adopted in 2011, was challenged in *Cleveland Nat'l Forest Foundation et al. v. San Diego Ass'n of Governments*, San Diego County Superior Court Case No. 37-2011-00101593-CU-TT-CTL, Court of Appeal Case No. D063288, California Supreme Court Case No. S223603, which is currently pending before the California Supreme Court. References to SANDAG's RTP/SCS in this SEIR refer to the RTP/SCS adopted in October 2015, which is not the subject of litigation.

The future GHG reductions projected by the RTP/SCS were sent to CARB for approval and incorporation into CARB's ongoing planning for compliance with California's GHG reduction goals.⁶

City of Carlsbad Climate Action Plan. The City of Carlsbad developed a Climate Action Plan (CAP) in September 2015 that serves as a comprehensive, long-term strategy to reduce GHG emissions in Carlsbad. The CAP outlines specific reduction methods to reduce GHG emissions city-wide, and provide the City of Carlsbad with a strategic plan for meeting state-mandated GHG reduction targets, including the CARB Scoping Plan. The CAP strategies extend through 2035, and reflect the Scoping Plan's guidance for local communities to meet AB 32 and Executive Order S-3-05 targets. The Scoping Plan recommends that local governments target 2020 emissions at 15% below 2005 levels to account for emissions growth since 1990, as proxy for 1990 emissions, since few localities know those levels. Total Carlsbad GHG emissions from the 2005 inventory were 630,310 metric tons CO₂E per year. Therefore, the 2020 target under state guidance is a 15% reduction from 2005 emissions, which corresponds to a target of 535,763 metric tons CO₂E (City of Carlsbad 2015).

Existing Greenhouse Gas Conditions

The Greenhouse Effect and Greenhouse Gases

Climate change refers to any significant change in measures of climate, such as temperature, precipitation, or wind, lasting for an extended period (decades or longer). Gases that trap heat in the atmosphere are often called "greenhouse gases." The greenhouse effect traps heat in the troposphere through a threefold process: Short-wave radiation emitted by the Sun is absorbed by the Earth; the Earth emits a portion of this energy in the form of long-wave radiation; and GHGs in the upper atmosphere absorb this long-wave radiation and emit it into space and toward the Earth. This "trapping" of the long-wave (thermal) radiation emitted back toward the Earth is the underlying process of the greenhouse effect. Principal GHGs include CO₂, CH₄, N₂O, O₃, and water vapor. Some GHGs, such as CO₂, CH₄, and N₂O, occur naturally and are emitted to the atmosphere through natural processes and human activities. Of these gases, CO₂ and CH₄ are emitted in the greatest quantities from human activities. Emissions of CO₂ are largely byproducts of fossil fuel combustion, and CH₄ results mostly from off-gassing associated with agricultural practices and landfills. Human-created GHGs, which have a much greater heat-absorption potential than CO₂, include fluorinated gases such as HFCs, PFCs, SF₆, and nitrogen trifluoride (NF₃), which are associated with certain industrial products and processes (CAT 2015).

⁶ See California Air Resources Board Executive Order G-15-075, December 2015 ("ARB Acceptance of GHG Quantification Determination") http://www.arb.ca.gov/cc/sb375/sandag_eo_15_075.pdf.

Temperatures are projected to rise 2°F to 4°F in most areas of the United States over the next few decades. Reductions in some short-lived human-induced emissions that contribute to warming, such as black carbon (soot) and methane, could reduce some of the projected warming over the next couple of decades, because, unlike carbon dioxide, these gases and particles have relatively short atmospheric lifetimes. The amount of warming projected beyond the next few decades is directly linked to the cumulative global emissions of heat-trapping gases and particles. By the end of this century, a roughly 3°F to 5°F rise is projected under a lower-emissions scenario, which would require substantial reductions in emissions, and a 5°F to 10°F rise is projected for a higher emissions scenario, assuming continued increases in emissions, predominantly from fossil fuel combustion (National Climatic Data Center 2014).

The effect each GHG has on climate change is measured as a combination of the mass of its emissions and the potential of a gas or aerosol to trap heat in the atmosphere, known as its “global warming potential” (or GWP). GWP varies between GHGs; for example, the GWP of CH₄ is 21, and the GWP of N₂O is 310. Total GHG emissions are expressed as a function of how much warming would be caused by the same mass of CO₂. Thus, GHG gas emissions are typically measured in terms of pounds or metric ton of “CO₂ equivalent.”⁷

Contributions to Greenhouse Gas Emissions

In 2012, the United States produced 6,525 million metric tons (MMT) of CO₂E (EPA 2014). The primary GHG emitted by human activities in the United States was CO₂, representing approximately 82.5% of total GHG emissions. The largest source of CO₂, and of overall GHG emissions, was fossil-fuel combustion, which accounted for approximately 94.2% of the CO₂ emissions.

According to the 2012 GHG inventory data compiled by CARB for the California Greenhouse Gas Inventory for 2000–2012, California emitted 459 MMT CO₂E of GHGs, including emissions resulting from out-of-state electrical generation (CARB 2014b). The primary contributors to GHG emissions in California are transportation, industry, electric power production from both in-state and out-of-state sources, agriculture, and other sources, which include commercial and residential activities. GHG emissions associated with water and wastewater supply, treatment, and conveyance are included in residential, commercial, and industrial activities, as well as

⁷ The CO₂E for a gas is derived by multiplying the mass of the gas by the associated GWP, such that metric tons of CO₂E = (metric tons of a GHG) × (GWP of the GHG). CalEEMod assumes that the GWP for CH₄ is 21, which means that emissions of 1 metric ton of CH₄ are equivalent to emissions of 21 metric tons of CO₂, and the GWP for N₂O is 310, based on the Intergovernmental Panel on Climate Change (IPCC) Second Assessment Report. Although the IPCC has released subsequent Assessment Reports with updated GWPs, CARB reporting and other statewide documents use the GWP in the IPCC Second Assessment Report. As such, it is appropriate to use the hardwired GWP values in CalEEMod from the IPCC Second Assessment Report.

electrical consumption associated with treatment and conveyance. These primary contributors to California's GHG emissions and their relative contributions in 2012 are presented in Table 4.3-1.

**Table 4.3-1
Greenhouse Gas Sources in California**

Source Category	Annual GHG Emissions (MMT CO ₂ E)	Percent of Total ^a
Agriculture	37.86	8.3%
Commercial uses	14.20	3.1%
Electric power	95.09 ^b	20.7%
Industrial uses	89.16	19.4%
Recycling and waste	8.49	1.9%
Residential uses	28.09	6.1%
Transportation	167.38	36.5%
High GWP substances	18.41	4.0%
Total^c	458.68	100%

Source: CARB 2014b.

MMT CO₂E = million metric tons of carbon dioxide equivalent; GWP = global warming potential

^a Percentage of total has been rounded.

^b Includes emissions associated with imported electricity, which account for 44.07 MMT CO₂E annually.

^c Totals may not sum due to rounding.

Potential Effects of Climate Change

According to CARB, some of the potential impacts from global warming in California may include loss in snow pack, sea level rise, more extreme heat days per year, more high O₃ days, more large forest fires, and more drought years (CAT 2010b). Several recent studies have attempted to explore the possible negative consequences that climate change, left unchecked, could have in California. These reports acknowledge that climate scientists' understanding of the complex global climate system, and the interplay of the various internal and external factors that affect climate change, remains too limited to yield scientifically valid conclusions on such a localized scale. Substantial work has been done at the international and national levels to evaluate climatic impacts, but far less information is available on regional and local impacts.

The primary effect of global climate change has been a rise in average global tropospheric temperature of 0.2°C per decade, determined from meteorological measurements worldwide between 1990 and 2005.

Although climate change is driven by global atmospheric conditions, climate change impacts are felt locally. Climate change is already affecting California: Average temperatures have increased, leading to more extreme hot days and fewer cold nights; shifts in the water cycle have been observed, with less winter precipitation falling in the form of snow, and both snowmelt and rainwater running off earlier in the year; sea levels have risen; and wildland fires are becoming

more frequent and intense due to dry seasons that start earlier and end later (CAT 2010b). Climate change modeling using 2000 emissions rates shows that further warming will occur, which would induce further changes in the global climate system during the current century. Changes to the global climate system and ecosystems and to California would include the following:

- Changes in precipitation or melting snow and ice that are altering hydrological systems and affecting water resources in terms of quantity and/or quality (IPCC 2014).
- Changes in terrestrial, freshwater, and marine species as to their geographic ranges, seasonal activities, migration patterns, and species interactions (IPCC 2014).
- Negative impacts on agricultural crop yields (IPCC 2014).
- Impacts from climate-related extremes such as heat waves, droughts, floods, wildfires, and other natural disasters (IPCC 2014).
- A decline of the Sierra Nevada snowpack, which is one of three primary water sources in California (in addition to reservoirs and groundwater). The Sierra Nevada snowpack is currently at 14% of normal (California Department of Water Resources 2015).
- Rising regional sea level increases high-tide water levels and augments extreme storm-forced sea-level fluctuations, allowing more wave energy to reach farther shoreward and thus increasing the potential for coastal flooding (CEC 2012b).

4.3.2 Significance Criteria

Appendix G of the CEQA Guidelines provides that a project would have a significant environmental impact if it would:

1. Generate greenhouse gas emissions, either directly or indirectly, that may have a significant impact on the environment.
2. Conflict with an applicable plan, policy, or regulation adopted for the purpose of reducing the emissions of greenhouse gases.

Neither the State of California (including CARB) nor the SDAPCD has adopted quantitative, emissions-based thresholds for GHG emissions under CEQA.

OPR's Technical Advisory, titled CEQA and Climate Change: Addressing Climate Change through California Environmental Quality Act (CEQA) Review, states that "public agencies are encouraged but not required to adopt thresholds of significance for environmental impacts. Even in the absence of clearly defined thresholds for GHG emissions, the law requires that such emissions from CEQA projects must be disclosed and mitigated to the extent feasible whenever

the lead agency determines that the project contributes to a significant, cumulative climate change impact” (OPR 2008). Further, the advisory document indicates that “in the absence of regulatory standards for GHG emissions or other scientific data to clearly define what constitutes a ‘significant impact,’ individual lead agencies may undertake a project-by-project analysis, consistent with available guidance and current CEQA practice” (OPR 2008).

In *Ctr. for Biological Diversity v. Dept. Fish & Wildlife*, 62 Cal. 4th 204 (2015), the California Supreme Court offered additional guidance to agencies evaluating the cumulative significance of GHG emissions impacts. The Court set forth the following potential options:

- a. Examination of the data behind the CARB Scoping Plan’s methodology to determine the level of expected project-level reductions from new land development at the proposed project’s location.
- b. Analyzing the project’s compliance with regulatory programs designed to reduce greenhouse gas emissions from particular activities.
- c. Using previously adopted local plans, such as general plans or climate action plans, or metropolitan regions’ “sustainable communities’ strategies” that may analyze greenhouse gas emission for the relevant area.
- d. Reliance on existing numerical thresholds of significance for greenhouse gas emissions adopted, for example, by local air districts.

County of San Diego Climate Change Analysis Criteria

The proposed project was analyzed using the County of San Diego’s 2015 GHG Guidance: Recommended Approach to Addressing Global Climate Change in CEQA Documents, which uses a screening threshold of 900 metric tons (MT) CO₂E per year (County of San Diego 2015). A project that exceeds the 900 MT CO₂E per year screening threshold is required to conduct a more detailed GHG analysis. A project that meets or falls below the screening thresholds would not require additional analysis, and the climate change impacts would be considered less than significant.

In the event that a project exceeds the screening threshold, the County of San Diego’s 2015 GHG Guidance requires an evaluation of whether the project would conform with the GHG reduction targets set forth in the Scoping Plan’s 2011 Final Supplement. Based on the County of San Diego’s 2015 GHG Guidance and the 2011 Final Supplement, a 16% reduction in GHG emissions from a project’s “unmitigated” emissions is required to meet AB 32’s mandate of reducing emissions to 1990 levels by 2020. The County of San Diego’s 2015 GHG Guidance also requires an analysis of a project’s consistency with 2030 and 2050 goals established by Executive Order S-3-05.

4.3.3 Impacts

- A. *Generate greenhouse gas emissions, either directly or indirectly, that may have a significant impact on the environment?*

Construction

GHG emissions would be associated with the construction phase of the proposed modifications through use of construction equipment and vehicle trips. Emissions of CO₂ were estimated using the California Emissions Estimator Model (CalEEMod), Version 2013.2.2, available online (www.caleemod.com). Construction is anticipated to begin in mid-September 2016 and would take approximately 18 months to complete. See Section 4.1, Air Quality, for the construction schedule, equipment, vehicle trips, and other assumptions associated with short-term construction activities.

A detailed depiction of the construction schedule—including information regarding subphases and equipment assumed for each subphase—is included in Appendix S-B of this SEIR.

Table 4.3-2 shows the estimated annual GHG construction emissions associated with the proposed modifications, as well as the annualized construction emissions over a 20-year period per County of San Diego guidance.

**Table 4.3-2
Estimated Construction Greenhouse Gas Emissions (total metric tons)**

Construction Year	CO ₂	CH ₄	N ₂ O	CO ₂ E
Construction in 2016	183	0.03	0.00	183
Construction in 2017	1,335	0.32	0.00	1,342
Construction in 2018	220	0.06	0.00	222
Total Construction Emissions	1,738	0.41	0.00	1,747
<i>Amortized Construction Emissions</i>	87	0.02	0.00	87

Source: See Appendix S-B for complete results.

Operation

Under the proposed modifications, the CDP could produce an additional annual average 5 million gallons per day (mgd) of product water. The added 5 mgd of product water would require additional electricity during operation of the CDP that would result in indirect GHG emissions from electrical generation. The potential production of an additional 5 mgd would result in an estimated maximum of 3.6 MWh/h of electricity. In addition to this potential 5 mgd annual average increase in production capacity, the proposed modifications would involve use of new traveling screen motors and increased pumping that would require an additional 1.7 MWh/h of

electricity during operations, for a total increase of 5.3 MWh/h. The generation of electricity through combustion of fossil fuels typically results in emissions of CO₂ and, to a smaller extent, CH₄ and N₂O.

The proposed CDP modifications would require electricity from the electrical grid within the San Diego Gas & Electric (SDG&E) service area. Although the proposed modifications are anticipated to begin operation in 2018, the 2014 SDG&E carbon intensity factor for electrical generation of 626.11 pounds of CO₂E per MWh was conservatively used in determining the estimated annual GHG emissions from the proposed modifications (SDG&E 2015). As such, the potential to produce the additional annual average of 5 mgd of product water and to operate the new traveling screens motors and increased pumping would result in approximately 13,156 MT CO₂E per year. However, as described below, these emissions will be offset, or “zeroed-out” by the CDP’s Energy Minimization and GHG Reduction Plan.

The Special Conditions of the Coastal Development Permit by the CCC mandated implementation of an Energy Minimization and GHG Reduction Plan, which requires the purchase of carbon offsets to “zero-out” the CDP’s net indirect emissions that are not otherwise reduced or offset through other measures. The Energy Minimization and GHG Reduction Plan is a reliable and enforceable mechanism for reducing the CDP and proposed modifications GHG emissions through the use of reputable sources for GHG reductions and Poseidon’s demonstrated past performance in obtaining emissions reductions. Per the Energy Minimization and GHG Reduction Plan, Poseidon will purchase carbon offset projects through/from CARB, the California Climate Action Registry, or any California APCD or AQMD. The California Climate Action Registry, or CCAR, changed its name to the Climate Action Registry (CAR) in 2008 and establishes the regulatory-quality standards for the development, quantification and verification of GHG carbon offset projects in North America; issuing carbon offset credits known as ‘Climate Reserve Tons’ (equal to 1 MT of GHGs reduced or sequestered) generated from such projects; and tracking the transaction of credits over time in a transparent, publicly accessible system.

As a demonstration of the Energy Minimization and GHG Reduction Plan’s ability to achieve the required GHG reductions for the CDP, Poseidon submitted its first annual report documenting compliance with the Energy Minimization and GHG Reduction Plan to the CCC in November 2015 (First Annual GHG Report). The First Annual GHG Report details the assessment and reduction of indirect GHG emissions from the operation of the CDP for the first year of commercial operation (December 12, 2015 to June 30, 2016).

Prior to commencing CDP operations, as required in Special Provision 2, Paragraph 10 of the lease amendment recorded on September 29, 2011, the California State Lands Commission required Poseidon to offset the construction and operational impacts of the desalination facility prior to commercial operation by obtaining 25,000 MT of carbon offsets, subject to the verification

procedures of the Energy Minimization and GHG Reduction Plan. The State Lands Commission has confirmed that Poseidon's submission of 25,000 MT of carbon offsets has satisfied the conditions of the lease and is consistent with the Energy Minimization and GHG Reduction Plan.

The CDP began commercial operations on December 23, 2015. As of December 10, 2015, Poseidon had a balance of 114,849 MT of carbon offsets in its CAR account. Of this total, 25,000 MT have been retired to offset the construction emissions for the CDP pursuant to subparagraph 10.a. of Section 2 of the State Lands Commission Amendment of Lease 8727.1. The remaining balance of 89,849 MT is available to offset indirect GHG emissions during the first year of project operations. The Water Authority expects to purchase 48,000 acre-feet of water from Poseidon during the first twelve months of project operations. At this rate of production, Poseidon would need 78,048 MT of carbon offsets to fully offset the indirect emissions during the first year of operations (prior to consideration of any of the credits described in the Energy Minimization and GHG Plan). Therefore, Poseidon has sufficient carbon offsets in its CAR account to demonstrate the neutralization of equivalent carbon emissions associated with the first 12 months of CDP commercial operations. Additionally, the Energy Minimization and GHG Reduction Plan requires annual reporting and offsets for the GHG emissions associated with operation of the CDP, including the proposed modifications. The permanent retirement of offsets is documented via CAR's online system, which removes the credits from the registry, preventing any double-counting of carbon reductions. Once offsets are retired, the CAR system produces an email confirming the credits' retirement for the purpose listed.

As a result, the GHG emissions for the CDP and the proposed modifications would be reduced to "net zero" or 0 MT CO₂E per year through implementation of the Energy Minimization and GHG Reduction Plan. Once the proposed modifications are operational, the annual GHG emissions from the proposed modifications would be counted towards the annual calculation of GHG emissions from the CDP and would be offset in the same manner as the CDP's GHG emissions. As a result of the proposed modifications combined amortized construction and operational emissions being below the County of San Diego's 900 MT CO₂E per year screening threshold, in addition to the commitment to be reduce annual operational GHG emissions from the CDP, including the proposed modifications, to "net zero" means the proposed modifications would have a less-than-significant impact from GHG emissions.

B. Conflict with an applicable plan, policy, or regulation adopted for the purpose of reducing the emissions of greenhouse gases?

City of Carlsbad CAP Consistency

At the local level, the proposed CDP modifications would be subject to the City of Carlsbad's adopted CAP. The GHG emissions from the CDP with proposed modifications were not

specifically accounted for in the CAP's GHG inventory; however, as stated in Section 2.1 of the CAP the emissions forecast (Chapter 3 of the City of Carlsbad's CAP) uses a regional average for water consumption emissions that accounts for the effect of the desalination plant (City of Carlsbad 2015). As a result, the CDP and proposed modifications have been anticipated in the local climate planning efforts for the City of Carlsbad, and would not conflict with the City of Carlsbad's CAP. In addition, the CDP and proposed modifications are reflected in the City of Carlsbad General Plan Policy 2-P.83, which anticipates continued use of the site as a desalination plant.

SANDAG RTP/SCS Consistency

At the regional level, SANDAG's RTP/SCS was adopted for the purpose of reducing GHG emissions attributable to passenger vehicles in the San Diego region. Although the RTP/SCS does not regulate land use or supersede the exercise of land use authority by SANDAG's member jurisdictions (i.e., the County of San Diego and cities therein), the RTP/SCS is a relevant regional reference for evaluating the intersection of land use and transportation patterns, and the corresponding GHG emissions. The underlying purpose of the RTP/SCS is to provide direction and guidance on future regional growth (i.e., the location of new residential and nonresidential land uses) and transportation patterns throughout San Diego County, as stipulated by SB 375. The proposed CDP modifications would be consistent with existing zoning and land use designations of the various jurisdictions in which the project would occur, and would not increase vehicle trips or land use intensities as provided in the RTP/SCS.

Per the RTP/SCS, from 2012 to 2050, the regional population is forecasted to increase by 29% (SANDAG 2011). Section 7.2.17 of the RTP/SCS explains that a greater amount of water would be needed for construction and operation of residential and nonresidential development, developed park space, and other necessary developments to accommodate this regional growth. The RTP/SCS also acknowledges that new or expanded water supplies or entitlements will be required to meet anticipated growth projections. Therefore, the CDP with the proposed modifications would not conflict with the intent of the RTP/SCS or impede achievement of the RTP/SCS' goals.

The RTP/SCS takes the above-described increase in population and water supplies into account when projecting anticipated GHG emissions from regional growth.⁸ Under implementation of the RTP/SCS, total GHG emissions in the San Diego region are projected to be approximately 28.1 MMT CO₂E in 2020, or approximately 19% lower than GHG emissions in 2012. The RTP/SCS's anticipated GHG reductions were evaluated by as part of CARB's ongoing planning for compliance with California's GHG reduction goals and were found to meet the GHG targets

⁸ See Section 4.8 of the RTP/SCS EIR.

from the region in 2020 and 2035.⁹ Therefore, the proposed CDP modifications would not conflict with CARB's GHG targets for the San Diego region.

Scoping Plan and Executive Order B-30-15 Consistency

At the state level, CARB's Scoping Plan and Scoping Plan Update provide a framework for actions to reduce California's GHG emissions, and requires CARB and other state agencies to adopt regulations and other initiatives to reduce GHGs. CARB and other state agencies have adopted many of the measures identified in the Scoping Plan. Most of these measures focus on area-source emissions (e.g., energy usage, high-GWP GHGs in consumer products) and changes to the vehicle fleet (hybrid, electric, and more fuel-efficient vehicles) and associated fuels (e.g., Low Carbon Fuel Standard). Additionally, as described in Section 4.3.1, Executive Order B-30-15 established a statewide emissions reduction target of 40% below 1990 levels by 2030. This interim measure was identified to keep the state on a trajectory to meet the 2050 goal of reducing GHG emissions to 80% below 1990 levels by 2050, pursuant to Executive Order S-3-05. CARB has already identified the target 2050 emissions levels of 431 MMT CO₂E. The proposed CDP modifications would comply with all applicable regulations adopted in furtherance of the Scoping Plan to the extent required by law and would be consistent with the goals of the executive orders as demonstrated below.

Evaluating Project Level GHG Emissions Relative To Statewide Goals

Due to the technological shifts required and the unknown parameters of the regulatory framework in 2030 and 2050, quantitatively analyzing the project's impacts further relative to the 2030 and 2050 goals currently is infeasible for purposes of CEQA. This fact is further supported through CARB's acknowledgement in the Scoping Plan that the "measures needed to meet the 2050 goal are too far in the future to define in detail" (CARB 2008). Moreover, CARB has not calculated and released the "business-as-usual" emissions projections for 2030 or 2050, which are necessary data points for quantitatively analyzing a CEQA project's consistency with these targets.

Statewide Programs Reducing GHG Emissions

CARB is implementing a variety of statewide programs to reduce GHG emissions that will contribute to meeting reduction goals of the Scoping Plan and Executive Order B-30-15. These efforts are within the control of other state agencies, including CARB and are appropriate to be considered in this analysis because the Water Authority believes that these agencies will

⁹ See California Air Resources Board Executive Order G-15-075, December 2015 ("ARB Acceptance of GHG Quantification Determination") http://www.arb.ca.gov/cc/sb375/sandag_eo_15_075.pdf.

implement these measures to reduce and control GHG emissions. Thus, it is reasonable to expect the CDP with proposed modifications' GHG emissions level to decline as the regulatory initiatives identified by CARB in the First Update are implemented, and other technological innovations occur. As such, given the reasonably anticipated decline in CDP and proposed modifications' GHG emissions once fully constructed and operational, the proposed CDP modifications would be consistent with the goals of the executive orders.

The Scoping Plan recognizes that AB 32 establishes an emissions reduction trajectory that will allow California to achieve the more stringent 2050 target: "These [GHG emissions reduction] measures also put the state on a path to meet the long-term 2050 goal of reducing California's greenhouse gas emissions to 80% below 1990 levels" (CARB 2011). Also, CARB's First Update provides that it "lays the foundation for establishing a broad framework for continued emission reductions beyond 2020, on the path to 80% below 1990 levels by 2050," and many of the emissions reduction strategies recommended by CARB would serve to reduce the CDP and proposed modifications' post-2020 emissions level to the extent applicable by law, such as transitioning the energy sector toward zero carbon (CARB 2014a).

CARB's Cap-and-Trade Program (California Code of Regulations Title 17, Sections 95800–96023) is designed to reduce GHG emissions from major sources (deemed "covered entities") by setting a firm cap on statewide GHG emissions and employing market mechanisms to achieve AB 32's emissions-reduction mandate of returning to 1990 levels of emissions by 2020. CARB has expressed its intention to extend the Cap-and-Trade Program beyond 2020 in conjunction with setting a mid-term target. The "recommended action" in the First Update for the Cap-and-Trade Program is to "Develop a plan for a post-2020 Cap-and-Trade Program, including cost containment, to provide market certainty and address a mid-term emissions target" (CARB 2014a). The expected completion date for this recommended action is 2017.

In addition to the measures in CARB's First Update, in January 2015, during his inaugural address, Governor Jerry Brown expressed a commitment to achieve "three ambitious goals" that he would like to see accomplished by 2030 to reduce the state's GHG emissions: (1) increasing the state's Renewable Portfolio Standard from 33% in 2020 to 50% in 2030, (2) cutting the petroleum use in cars and trucks in half, and (3) doubling the efficiency of existing buildings and making heating fuels cleaner. These expressions of Executive Branch policy may be become adopted legislative or regulatory action and include GHG reductions through actions such as SB 350, which requires the state to double energy efficiency saving in electricity and natural gas by retail customers by 2030, and increases the Renewable Portfolio Standard so that half of the state's electricity must be procured by renewable sources by 2030.

Further, recent studies shows that the state's existing and proposed regulatory framework will allow the state to reduce its GHG emissions level to 40% below 1990 levels by 2030, and to 80%

below 1990 levels by 2050. These studies demonstrated that various combinations of policies could allow the statewide emissions level to remain very low through 2050, suggesting that the combination of new technologies and other regulations not analyzed in the study could allow the state to meet the 2030 and 2050 targets. Some of these measures are likely to reduce the CDP and proposed modifications GHG emissions. For example, the vehicles traveling to and from the project site will continue to be subject to more stringent fuel standards, or future requirements for electrified engines or fuel cell technology, as determined by CARB. In addition, construction trucks and equipment could be subject to more stringent emissions standards, including the possibility of Tier IV emissions standards.

In addition, the CDP and proposed modifications would use electricity for operations. As described above, the State's electrical utilities are subject to increasing Renewable Portfolio Standard requirements, and compliance with such requirements is the responsibility of the electrical utilities. Therefore, the CDP and proposed modifications post-2020 emissions trajectory is expected to follow a declining trend, consistent with the 2030 and 2050 targets. The proposed CDP modifications would support achievement of the near-term 2020 goal (as codified in AB 32), the interim 2030 goal, and the long-term 2050 goal through continuing to provide a local water source for the region.

Conclusion

As discussed above, construction of the proposed modifications would not exceed the County of San Diego's screening threshold of 900 MT CO₂E per year or cause the CDP pro-rated emissions to exceed the screening threshold after offsets. Furthermore, the CDP is conditioned by the CCC to implement an Energy Minimization and GHG Reduction Plan that reduces the CDP's and proposed modification's GHG emissions to "net zero." The Energy Minimization and GHG Reduction Plan requires the following steps to be completed each year:

1. Determine the energy consumed by the CDP for the previous year
2. Determine SDG&E emission factor for delivered electricity from its most recently published Annual Emissions Report.
3. Calculate the CDP's gross indirect GHG emissions resulting from CDP operations by multiplying its electricity use by the emission factor.
4. Calculate the CDP's net indirect GHG emissions by subtracting emissions avoided as a result of the Project (Avoided Emissions) and any existing offset Projects and/or Renewable Energy Credits (RECs).
5. If necessary, purchase carbon offsets or RECs (or pay an in-lieu fee) to zero-out the CDP's net indirect GHG emissions.

As previously described, the Energy Minimization and GHG Reduction Plan has proven to be a reliable method for obtaining reputable and quantifiable GHG offsets for the CDP and would continue to do so for the proposed CDP modifications. Additional information regarding the Energy Minimization and GHG Reduction Plan can be found on pages 15-17 of the First Addendum.

The CDP, as modified pursuant to the proposed modifications, would continue to implement the Energy Minimization and GHG Reduction Plan. Because the proposed modifications would not exceed the County's screening threshold and would be further reduced by implementing the Energy Minimization and GHG Reduction Plan, the proposed modifications would not conflict with any applicable plan, policy, or regulation adopted for the purpose of reducing the emissions of greenhouse gases. Therefore, impacts would be less than significant.

4.3.4 Mitigation Measures

No mitigation measures are required. However, the Energy Minimization and GHG Reduction Plan as required as a Special Condition in the coastal development permit for the CDP would be applicable to the incorporation of the proposed modifications, and states:

- All indirect GHG emissions associated with the proposed modifications shall be offset in full, if necessary, through the purchase of carbon offsets or RECs (or an in-lieu fee) to zero-out the CDP and proposed modifications' net indirect GHG emissions.

4.3.5 Level of Significance after Mitigation/Residual Impact

All impacts would be less than significant. No mitigation is required.

4.4 HYDROLOGY AND WATER QUALITY

This section describes the existing hydrology and water quality setting, identifies associated regulatory requirements, evaluates potential impacts, and identifies mitigation measures related to implementation of the proposed CDP with incorporation of the proposed modifications.

4.4.1 Existing Conditions

Regulatory Setting

The California Ocean Plan Amendment

On May 6, 2015, the SWRCB approved an amendment to the state's Water Quality Control Plan for the Ocean Waters of California (Ocean Plan Amendment) to address effects associated with the construction and operation of seawater desalination facilities. The Ocean Plan Amendment supports the use of ocean water as a reliable supplement to traditional water supplies while protecting marine life and water quality. The desalination amendment will, for the first time, provide a uniform, consistent process for permitting of seawater desalination facilities statewide. In doing so, it provides direction for regional water boards when permitting new or expanded facilities, and provides specific implementation and monitoring and reporting requirements.

Desalination facilities and brine disposal were identified as Issue Number 4 in the SWRCB's California Ocean Plan 2011-2013 Triennial Review Workplan because several new desalination facilities have been planned along the California coast to augment existing water supplies. The Ocean Plan Amendment requires new or expanded seawater desalination plants to use the best available site, design, technology, and mitigation measures feasible to minimize intake and mortality of all forms of marine life. Based on the best available science, the amendment identifies preferred technologies; however, alternative intake methods can be used if the preferred method is found to be infeasible and alternative disposal methods can be used if demonstrated to be as protective of marine life as the preferred technologies. Additionally, mitigation measures are required to address damage to marine life that occurs after the best available site, design, and technology feasible are used. Determining whether or not a site, design, technology, and mitigation measure is feasible considers whether something is capable of being accomplished in a successful manner within a reasonable period of time, and takes into account economic, environmental, social, and technological factors.

Existing Site Conditions

The site of the proposed modifications is currently developed as the EPS intake and the CDP Intake Pump Station. The site consists of previously developed and disturbed areas including the

EPS intake structure, hardscape, ornamental plantings, and scatter grass on the slopes leading to Agua Hedionda Lagoon. The existing hydrological conditions of the project site have largely remained unchanged since the time of the certification of the FEIR. The drainage patterns have not been substantially affected by the construction of the CDP as it has occurred in a previously developed area. Refer to Section 4.7 of the FEIR for a full description of the existing hydrological setting of the Precise Development Plan area. Changes related to water quality since the certification of the FEIR include operation of the CDP and addition of brine concentrate to the EPS discharge in accordance with RWQCB Order R9-2009-0038.

Over the last 20 years, the natural background salinity at the closest reference site (Scripps Pier, approximately 19 miles south) has measured a minimum salinity of 30.4 ppt, maximum salinity of 34.2 ppt, and an average salinity of 33.5 ppt. The CDP discharges approximately 54 mgd of brine and backwash water at a salinity of approximately 65 ppt, which is mixed with the EPS discharge of approximately 200 mgd resulting in a salinity in the discharge pond of approximately 40 ppt. The water is discharged from the discharge pond and mixes in the nearshore waters (within the 1,000-foot ZID) to within 2 ppt of background salinity levels.

4.4.2 Significance Criteria

The significance criteria used to evaluate the project impacts to hydrology and water quality are based on the applicable criteria from Appendix G of the CEQA Guidelines. A significant impact related to hydrology and water quality would occur if the project would:

- A. Violate any water quality standards or waste discharge requirements?
- B. Substantially alter the existing drainage pattern of the site or area, including through the alteration of the course of a stream or river in a manner which would result in substantial erosion or siltation on- or off-site.
- C. Substantially alter the existing drainage pattern of the site or area, including through the alteration of the course of a stream or river, or substantially increase the rate or amount of surface runoff in a manner which would result in flooding on- or off-site.
- D. Create or contribute runoff water which would exceed the capacity of existing or planned stormwater drainage systems or provide substantial additional sources of polluted runoff?
- E. Otherwise substantially degrade water quality?
- F. Place within a 100-year flood hazard area structures which would impede or redirect flood flows.
- G. Inundation by seiche, tsunami, or mudflow?

4.4.3 Impacts

A. *Violate any water quality standards or waste discharge requirements?*

Construction

Construction of the proposed CDP modifications would be similar in nature to construction of the desalination plant's Intake Pump Station. Construction of the proposed modifications would require demolition, excavation, grading, which would expose soils and increase erosion potential. Additionally, material stockpiles, fuels, lubricants, and waste would be stored within the construction area. Under the proposed modifications, the Construction Activity Storm Water Permit and other permits obtained by the RWQCB would be amended due to the differences in construction activity as permitted under the FEIR. These include dewatering throughout construction and the discharge of the dewatered waters to the brine discharge structure. All applicable mitigation measures pertaining to hydrology and water quality required by the FEIR and all applicable permits and ordinances would still apply during construction of the proposed modifications. These include Mitigation Measure 4.7-1 that requires adherence to National Pollution Discharge Elimination System (NPDES) permit requirements and implementation of BMPs, and Mitigation Measure 4.7-2 that requires submittal of a Storm Water Management Plan. The increase in construction activity for the proposed CDP modifications would substantially increase the severity of potential impacts regarding water quality standards. The determination of significance is not altered from the FEIR. Short-term impacts in the FEIR were identified as potentially significant, necessitating mitigation. The level of significance remains the same. Therefore, short-term construction impacts resulting from the proposed modifications would be potentially significant.

Operation

Changes in potential impacts to water quality relative to the analysis provided in the FEIR are limited to operation of the modified intake and discharge facilities. As the proposed CDP modifications would not change the process for production of product water to be distributed and the CDP has received the necessary permits from the Division of Drinking Water, such impacts to drinking water quality would not change from the analysis provided in the FEIR. Since the time of the certification of the FEIR, the primary change in water quality standards and discharge requirements relevant to the proposed modifications is the recent adoption of the Ocean Plan Amendment in May 2015. Included in the Submittal of Report of Waste Discharge for the renewal of NPDES CA109233 for the CDP, submitted by the project applicant to the San Diego RWQCB, is a full discussion of the proposed modifications' compliance with the Ocean Plan Amendment (Appendix A of the 2015-Submittal to RWQCB). As shown in Appendix A of the

2015-Submittal to RWQCB, the CDP with incorporation of the proposed modifications would be fully compliant with the Ocean Plan Amendment.

The waste stream from the CDP with incorporation of the proposed modifications would consist of granular media filtration backwash and washing of the screens and fish return system. Table 4.4-1 presents a summary of the waste discharges associated with the CDP under co-located and temporary standalone conditions, and the CDP with incorporation of the proposed modifications under permanent standalone conditions. Backwash rinses particulate matter-residual particles-off retained by the granular media filtration system and the 1 mm screens are rinsed with low-pressure and high-pressure seawater to remove organisms and debris, respectively without addition of chemicals. The particulate matter and debris particles are associated with fine debris from the intake water. Any wastewater from treated chemical cleaning of other portions of the CDP system such as the reverse osmosis pretreating membranes, will be stored in a separate tank, neutralized and conveyed to the sanitary sewer system. The CDP with incorporation of the proposed modifications would not alter the constituents of the backwash, though volumes would increase by up to 2 – 3 mgd, as shown in Table 4.4-1. The CDP with incorporation of the proposed modifications would not result in significant impacts to water quality from the facilities waste stream. The increase in backwash volumes associated with the CDP modifications, represents a substantial increase in the severity of waste stream impacts to water quality. However, the discharge would be in compliance with RWQCB permit limits so the increase would not be such that it would reach a level of significance. Impacts in the FEIR were identified as less than significant. Therefore, the level of significance remains the same.

Table 4.4-1
Summary of CDP Production and Discharge Flows
Existing Permitted Discharge and Proposed Discharge

Parameter		Current Permitted Discharge ¹ (to be continued under the updated NPDES permit until the EPS once-through cooling water discharge is permanently terminated)				Proposed Revised Discharge (When EPS discharge is terminated)
		Co-Located Operating Conditions ²		Temporary Stand-Alone Operating Conditions ²		Permanent Stand- Alone Operating Conditions ³
		Average Daily Flow	Maximum Daily Flow	Average Daily Flow	Maximum Daily Flow	Annual Average Flow
Potable water production capacity		50 mgd	54 mgd	50 mgd	54 mgd	55/60mgd
CDP Intake Flows	Intake from EPS Effluent Tunnel	304104 mgd	NA114 mgd	304104 mgd	NA114 mgd	---
	Intake from CDP Lagoon Intake Structure	---	---	---	---	Up to 299 mgd

**Table 4.4-1
Summary of CDP Production and Discharge Flows
Existing Permitted Discharge and Proposed Discharge**

Parameter		Current Permitted Discharge ¹ (to be continued under the updated NPDES permit until the EPS once-through cooling water discharge is permanently terminated)				Proposed Revised Discharge (When EPS discharge is terminated)
		Co-Located Operating Conditions ²		Temporary Stand-Alone Operating Conditions ²		Permanent Stand- Alone Operating Conditions ³
		Average Daily Flow	Maximum Daily Flow	Average Daily Flow	Maximum Daily Flow	Annual Average Flow
Wastewater discharge components	Granular Media Filtration Backwash	4 mgd	6mgd	4 mgd	6mgd	Up to 7 mgd
	RO concentrate	50 mgd	54 mgd	50 mgd	54 mgd	55/60 mgd
	Screen wash/fish return from CDP Intake	NA	NA	NA	NA	1 mgd
	CDP stand-alone intake flows bypassed (augmentation) ⁴	NA	NA	NA	NA	Up to <u>198474</u> mgd ⁴
	Total CDP discharge flow	54 mgd	60 mgd	54 mgd	60 mgd	Up to <u>244238</u> mgd
	Minimum EPS discharge flow required to achieve salinity standard ⁵	200 mgd ⁵	210 mgd ⁵	200 mgd ⁵	210 mgd ⁵	NA

- Existing permitted conditions under Regional Water Board Order No. R9-2006-0065 (NPDES 0109223), as amended by Order No. R9-2009-0038. The NPDES Report of Waste Discharge submitted by Poseidon on March 29, 2011 proposed continuation of these requirements. The revised 2015 Poseidon Report of Waste Discharge presented herein requests continuation of these existing NPDES requirements as long as the EPS once-through cooling water discharge remains in operation. Once EPS is permanently taken out of operation and the intake and discharge modifications are complete and operational, the CDP would be operated in permanent stand-alone operating mode (per the far right hand column).
- For conditions under which EPS is not discharging sufficient power plant cooling water flows to the EPS effluent tunnel (pursuant to EPS NPDES discharge permit requirements), Order No. R9-2006-0065 authorizes the EPS to run the cooling water pumps under such "temporary stand-alone" conditions for CDP's benefit. Under such temporary stand-alone conditions, CDP discharge water is blended back into the EPS effluent tunnel (downstream from the co-located CDP intake point) where it is blended with sufficient flow from the EPS to meet the blended effluent salinity requirements prior to discharge to the EPS discharge pond (Monitoring Location M-002). The EPS is currently scheduled to suspend operation of the existing generating units in 2017. The intake and discharge modifications will not be operational by this date. The proposed modifications and the operations of the CDP during interim closure of the EPS while the modifications are under construction would be consistent with the periodic non-operation of EPS included in the FEIR. The Applicant is working with the owner of the EPS to ensure the EPS cooling water pumps will continue to be available to provide seawater for CDP operations until the intake and discharge modifications are operational. The NPDES Report of Waste Discharge submitted by the Applicant proposed that during this interim period, the CDP would continue to operate in the temporary stand-alone mode of operation. Once the intake and discharge modifications are complete, the CDP would transition to permanent stand-alone operating conditions. The CDP will comply with the Ocean Plan receiving water limitation (daily maximum of 2.0 parts per thousand (ppt) above natural background salinity measured at the edge of the brine mixing zone 200 meters (656 ft.) away from the points of discharge) while operating in both temporary and permanent stand-alone configurations.
- Conditions under which EPS operations are terminated and the CDP is operated in permanent stand-alone mode. Under such stand-alone conditions, CDP influent flows are withdrawn from the lagoon via a new stand-alone CDP intake system, a portion of the withdrawn flows are directed to CDP for desalination, and remaining withdrawn intake flows are blended back into the CDP RO concentrate and filter backwash streams prior to discharge to the final effluent pond (Monitoring Location M-002).

- 4 Intake water flows under stand-alone CDP operations that bypass CDP and are directed into the effluent tunnel for blending with CDP RO concentrate and filtration backwash (when backwash is not being recycled to CDP pretreatment). At the discretion of the plant operators, however, filtered backwash flows may instead be recycled to the plant headworks. When backwash flows are being recycled to CDP pretreatment processes rather than discharged to the ocean, a commensurate increase in the bypass flow rate will be required to ensure that effluent pond salinities are maintained at 42 ppt or less and receiving water salinities 200 meters (656 feet) from the discharge point are less than 2 ppt above ambient. Total CDP intake flows would ~~not exceed~~remain at 299 mgd and total CDP discharge flows would ~~be adjusted to meet receiving water limit while accounting for~~remain at 238 mgd ~~regardless of whether filter backwash is discharged to the ocean or recycled back to the headworks. When filtered backwash is recycled to the headworks, a greater portion~~478 mgd of the 299 mgd intake flow would be bypassed. When filter backwash is discharged to the ocean, ~~a smaller portion~~474 mgd of the 299 mgd intake flow would be bypassed.
- 5 Minimum EPS discharge flow (over and above CDP intake requirements) under EPS/CDP co-located operations required to ensure that the combined EPS and CDP discharges achieve a blended salinity equal to or lower than the average day salinity standard. To the extent that backwash flows are being recycled to the front of the CDP pretreatment rather than discharge to the ocean (see footnote 4), the reduction in the discharge flow rate will require an equivalent increase in the minimum EPS discharge flow to replace initial dilution of the RO concentrate discharge that would have been accomplished through commingling the RO concentrate with the filter backwash water.

Brine Mixing Zone

As part of the Report of Waste Discharge for the proposed CDP modifications, the brine mixing zone design was analyzed for compliance with the Ocean Plan Amendment and assessed for salinity levels. The Applicant has submitted for approval by the RWQCB an alternative brine mixing zone of 200 meters. Approximately A maximum of 299 mgd of seawater would be withdrawn from the Lagoon (up to 127 mgd for processing, 171 up to 198 mgd for brine dilution, up to 7 mgd for filter backwash and approximately 1 mgd for screen wash and fish return and meet a pond discharge of 42 ppt or less).

Up to 60 mgd of the diverted seawater is converted to fresh water that is piped to the Water Authority delivery system. The remaining flow (up to 67 mgd) is returned to the EPS discharge tunnel for blending with seawater prior to discharge to the Pacific Ocean. The discharge consists of brine produced by the reverse osmosis process (up to 60 mgd) and treated backwash water from the pretreatment filters (up to 7 mgd). The salinity of the discharge prior to dilution is approximately 64 parts per thousand (ppt) (67 ppt with no backwash water included), whereas the average salinity of the seawater in the vicinity of the discharge tunnel ranges approximately between 42 ppt and 33.5 ppt as the dilution process occurs. The brine would undergo an initial dilution to ~~approximately 42 ppt or less~~ by mixing the discharge with 171 mgd to 198 mgd of the seawater withdrawn from Agua Hedionda Lagoon within the discharge pond. The combined discharge and dilution water flow rate for the proposed modifications would be ~~up to 238 mgd to~~ 244 mgd. Per the Ocean Plan Amendment, the discharge is not to exceed a daily maximum of 2.0 ppt above natural background salinity measured at the edge of the brine mixing zone. Under average conditions, the seawater salinity is 33.5 ppt and the discharge would not exceed a daily maximum of 35.5 ppt at the edge of the brine mixing zone (approximately 200 meters (656 feet) from the discharge point) after initial dilution in the existing EPS discharge pond and further dilution within the brine mixing zone.

Analysis provided as Appendix B and Appendix K to the Submittal to the RWQCB demonstrated that the combination of the alternative brine mixing zone and flow augmentation using a surface water intake would result in a lower level of intake and mortality of all forms of marine life as the combination of the standard brine mixing zone with a multiport diffuser. The analysis provided as Appendix DD to the Submittal to the RWQCB demonstrated that the proposed discharge would not result in hypoxic conditions outside of the alternative brine mixing zone.

Based on the results of the revised hydrodynamic discharge modeling study (Appendix BB to the Submittal to the RWQCB), a brine mixing zone of less than 200 meters would not be able to achieve compliance with the Ocean Plan receiving water salinity limitation of 2.0 ppt above natural background salinity at the edge of brine mixing zone during the worst case month without increasing the quantity of seawater used for flow augmentation or relaxing the receiving water salinity limitation.

As noted in Section 4.2, the Applicant has requested guidance from the RWQCB regarding the applicability of and monitoring required to evaluate and identify a facility-specific alternative receiving water salinity limitation in accordance with section III.M.3.c. of the Ocean Plan. The Applicant conducted chronic toxicity testing to determine whether a facility-specific alternative receiving water limitation is adequately protective of beneficial uses. The chronic toxicity testing (Salinity Tolerance Chronic Test Results included as Appendix H to the Submittal to the RWQCB) found that the lowest observed effect concentration (LOEC) for the most sensitive species, red abalone, is 36.5 ppt. The RWQCB is reviewing the Applicant's request and has yet to make a decision about whether an alternative receiving water salinity limitation for the CDP is appropriate. Absent a determination by the RWQCB that an alternative receiving water salinity limitation for the CDP is appropriate, the SEIR assumes project operations in conformance with a daily maximum salinity requirement of 2.0 ppt above natural background salinity measured at the edge of a brine mixing zone 200 meters (656 ft.) away from the points of discharge.

~~The brine discharge would be in compliance with the Ocean Plan Amendment and impacts from the CDP with incorporation of the proposed modifications related to brine discharge would be less than significant. The establishment of a reduction in the regulated Brine Mixing Zone (BMZ) area for dilution within Pacific Ocean salinity increase of no more than 2 ppt over natural background salinity at the outside edge of the BMZ, represents a change in existing permit requirements for the project (daily average salinity not to exceed 40 ppt in the discharge pond) substantial increase in the severity of salinity impacts to the water quality because the parameter around which the dilution is measured has been reduced. However, the determination of significance related to impacts to water quality is not altered from the FEIR. Impacts in the FEIR were identified as less than significant. Therefore, the level of significance remains the same.~~

Fish Return

The new screening/fish-friendly pumping structure would be screened by up to eight center-flow traveling water screens (two redundant) with 1 mm mesh, modified with fish protection features (fish lifting buckets on each screen basket, low pressure spraywash, and fish return system). Approximately 1 mgd of the total intake water withdrawn from the Agua Hedionda Lagoon would be used for screen wash and fish return. The water discharged with the fish return would be the same untreated lagoon water that was withdrawn for intake and processing. The water quality of the fish return water would not be altered from when it was withdrawn from the lagoon. All fish and debris in the traveling screen fish buckets would be returned to the discharge pond at a location that expedites return to the Pacific Ocean, or Agua Hedionda Lagoon at a location that minimizes the potential recirculation of organisms and debris to the intake. Necessary permitting pursuant to the Clean Water Act for the discharge of the return water back into the lagoon would be required from the ~~U.S. Army Corps of Engineers and RWQCB~~ for both fish return options, and from the U.S. Army Corps of Engineers lagoon fish return option. Discussion related to impacts to marine biology is found in Section 4.2 of this SEIR. The new impacts associated with construction of the discharge pond fish return system with the incorporation of the proposed CDP modifications, does not represent a substantial increase in the severity of impacts to water quality because it is replacing an existing discharge of the same or similar quality from the EPS. The new impacts associated with construction of the lagoon fish return system with the incorporation of the proposed CDP modifications, represents a substantial increase in the severity of impacts to water quality because of the introduction of new discharge to the Agua Hedionda Lagoon. However, impacts to water quality and discharge requirements related to lagoon fish return would be less than significant because the fish return system would not add constituents to the receiving water other than what is withdrawn from the receiving waters through the intake. Therefore, the increase would not be such that the determination of significance related to impacts to the water quality is altered from the FEIR. Impacts related to drainage patterns from the CDP with incorporation of the proposed modifications would remain less than significant. Impacts in the FEIR were identified as less than significant. Therefore, the level of significance remains the same.

B. Substantially alter the existing drainage pattern of the site or area, including through the alteration of the course of a stream or river in a manner which would result in substantial erosion or siltation on- or off-site?

The proposed CDP modifications would be within the currently developed and impervious area and would not alter the drainage pattern. The proposed modifications would only increase erosion potential during construction, when bare soils are exposed. During construction, the proposed modifications would be required to implement BMPs and obtain a modification to the Construction Activity Storm Water Permit issued for the CDP as analyzed and provided as

mitigation in the FEIR. The increase in erosion potential during construction of the proposed CDP modifications would not substantially increase the severity of drainage impacts. The determination of significance is not altered from the FEIR. Impacts in the FEIR were identified as less than significant. Therefore, the level of significance remains the same. Therefore, impacts related to drainage patterns from the CDP with incorporation of the proposed modifications would remain less than significant.

C. Substantially alter the existing drainage pattern of the site or area, including through the alteration of the course of a stream or river, or substantially increase the rate or amount of surface runoff in a manner which would result in flooding on- or off-site?

The proposed CDP modifications would not change the existing drainage pattern of the proposed site. The proposed site is mostly covered by impervious hardscape, including paved parking area, the existing CDP Intake Pump Station, and the existing EPS intake and discharge structures. A portion of the existing pervious landscaped area would be impacted to implement the proposed modifications. The majority of the proposed modifications intake structure would be below grade. Any water collected in this area would end up being processed by the CDP or co-mingled with the brine dilution water. Therefore, the surface runoff from the site would be less after implementation of the proposed modifications than under existing conditions. The structure and paved areas would not substantially alter the current drainage pattern and would not alter the potential for flooding to occur. The proposed CDP modifications would not substantially increase the severity of impacts to the drainage pattern. The determination of significance is not altered from the FEIR. Impacts in the FEIR were identified as less than significant. The level of significance remains the same. Therefore, impacts from the CDP with incorporation of the proposed modifications would remain less than significant.

D. Create or contribute runoff water which would exceed the capacity of existing or planned stormwater drainage systems or provide substantial additional sources of polluted runoff?

The amount of impervious land cover would increase by less than 2,000 square feet as a result of the proposed CDP modifications, because the majority of the site is paved. However, the proposed modifications would not place additional demands on the existing drainage system because any water captured on the impervious surfaces would end up processed as part of the CDP or comingled with dilution waters. The proposed CDP modifications would not substantially increase the severity of impacts to stormwater systems. The determination of significance is not altered from the FEIR. Impacts in the FEIR were identified as less than significant. Therefore, the level of significance remains the same. Therefore, impacts from the CDP with incorporation of the proposed modifications would remain less than significant.

E. Otherwise substantially degrade water quality?

Refer to response (A), above. During construction, the proposed CDP modifications would be held to the same BMP requirements and mitigation measures for the construction of the CDP as described in the FEIR. These include Mitigation Measure 4.7-1 that requires adherence to NPDES permit requirements and implementation of BMPs, and Mitigation Measure 4.7-2 that requires submittal of a Storm Water Management Plan. Construction would include dewatering for construction of intake and discharge modifications including installing 1 mm screen and fish-friendly pumps. The proposed modifications would have to comply with the permit requirements in a new Construction Activity Storm Water Permit that would be obtained from the RWQCB for the construction of the proposed modifications, including dewatering activities. This permit would require the use of BMPs similar to those required for construction of the desalination plant as analyzed under the FEIR and would not result in any new or substantially more severe impacts. Also as described in response (A), the proposed modifications would comply with the Ocean Plan Amendment as it relates to desalination plants, brine discharge, and fish return. The increase in construction activity for the proposed CDP modifications would substantially increase the severity of potential impacts regarding water quality standards. The determination of significance is not altered from the FEIR. Short-term impacts in the FEIR were identified as potentially significant, necessitating mitigation. The level of significance remains the same. Therefore, short-term construction impacts resulting from the proposed modifications would be potentially significant necessitating mitigation.

F. Place within a 100-year flood hazard area structures which would impede or redirect flood flows?

Refer to response (G), above. The proposed CDP modifications would be located within the desalination plant site and outside of the 100-year flood hazard area, with the exception of the discharge pond and lagoon fish return system outlet. However, the outlet for the fish return system options would not be of sufficient size to impede or redirect any flood flows. Additionally, all applicable mitigation measures from the FEIR, including Mitigation Measure 4.7-3 that would require construction within the 100-year flood zone to occur outside of the wet season unless it can be demonstrated that construction would not impede flood flows, would be implemented to reduce potential flood hazard impacts. Therefore, impacts related to flood hazard areas from the CDP with incorporation of the proposed modifications would remain less than significant. The proposed CDP modifications would not substantially increase the severity of flood hazard impacts. The determination of significance is not altered from the FEIR. Impacts in the FEIR were identified as less than significant. Therefore, the level of significance remains the same.

G. *Inundation by seiche, tsunami, sea level rise or mudflow?*

The proposed CDP modifications are not located in an area of steep topography that would be susceptible to inundation from a mudflow. The proposed modifications site is located in a tsunami inundation zone, specifically the portion within Agua Hedionda Lagoon (Cal EMA 2009). However, the proposed modifications would not place housing or any buildings intended for occupancy within a tsunami inundation zone. The nature of some of the proposed structures, such as the pipelines, would have a low susceptibility for potential inundation by a tsunami. Any components that could be damaged if inundated would be at elevations above that reached in the unlikely event of a tsunami. The proposed modifications are located in an area adjacent to the sea and tidally influenced lagoon that would be subject to rising levels as a result of global sea level rise. The California Coastal Commission Sea Level Rise Guidance Policy (CCC 2015) identified that by 2050, sea level may rise by between 5 and 24 inches and by the year 2100, sea level may rise by between 17 and 66 inches. Such a rise would put the aquatic components of the proposed modifications further below the water surface level. These proposed structures would be suitable for operation in a submerged environment, such as the fish return, intake and discharge aquatic components and would not be at risk as a result of the rise in sea level. The electrical motors on the pumps and screens and electrical equipment in the electrical building to be located adjacent to the screening/pumping structure are susceptible to damage if inundated. However, finished grade in this area is approximately 17.6 feet above mean sea level. The top of the screen/pumping structure is at approximately 20 feet above mean sea level. The lowest elevation of the motors in the screen/pump well would be approximately 12 feet above mean sea level. The electrical equipment would sit at between 18 to 24 feet above mean sea level. Therefore, the components that could be damaged if inundated would be at elevations above that of the projected rise in sea level. The increased capacity of the CDP would not be at risk because the CDP is at an elevation above that of projected sea level rise. Therefore, impacts from the CDP with incorporation of the proposed modifications would remain less than significant. The proposed CDP modifications would not substantially increase the severity of inundation impacts. The determination of significance is not altered from the FEIR. Impacts in the FEIR were identified as less than significant. Therefore, the level of significance remains the same.

4.4.4 Mitigation Measures

No additional hydrology and water quality mitigation measures beyond those required by the FEIR Mitigation Measures 4.7-1, 4.7-2, and 4.7-3. In addition, minimization measures required by the RWQCB as part of the NPDES Permit No. CA0109223 would further reduce effects of the CDP with incorporation of the proposed modifications on water quality.

4.4.5 Level of Significance after Mitigation/Residual Impact

All impacts would be less than significant with implementation of the mitigation measures required by the FEIR. The mitigation measures would reduce impacts to below the level of significance consistent with FEIR. Impacts in the FEIR were identified as less than significant with the incorporation of mitigation measures. Therefore, the level of significance after mitigation is incorporated remains the same. No new mitigation is required.

4.5 ENERGY

This SEIR includes an Energy section. Since the FEIR was prepared, the standard practice for preparation of EIRs in addressing CEQA Guidelines Appendix F, has evolved to include a standalone Energy section. This section addresses the potential energy impacts associated with implementation of the proposed CDP modifications. The following discussion evaluates the energy conservation goals within Appendix F of the CEQA Guidelines with an emphasis on avoiding or reducing the inefficient, wasteful, or unnecessary consumption of energy. This section focusses mostly on electricity demand because this is the primary form of energy demand by the CDP with incorporation of the proposed modifications.

4.5.1 Existing Conditions

Although the FEIR did not specifically address the efficiency of using energy resources and conservation for the CDP in a separate section, electricity demand was discussed in the context of determining the CDP's criteria air pollutant emissions in Section 4.2, Air Quality, and energy demand on the electrical grid infrastructure in Section 4.11, Public Utilities and Service Systems, of the FEIR. As such, the specific regulations and existing conditions related to energy resources and conservation are described below.

Regulatory Setting

State of California

Senate Bill X1 2

On April 12, 2011, Governor Jerry Brown signed SB X1 2 in the First Extraordinary Session, which expands California's Renewable Portfolio Standard (RPS) by establishing a goal of 20% of the total electricity sold to retail customers in California per year by December 31, 2013; 25% by December 31, 2016; and 33% by December 31, 2020, and in subsequent years. Under the bill, a renewable electrical generation facility is one that uses biomass, solar thermal, photovoltaic, wind, geothermal, fuel cells using renewable fuels, small hydroelectric generation of 30 MW or less, digester gas, municipal solid waste conversion, landfill gas, ocean wave, ocean thermal, or tidal current, and that meets other specified requirements with respect to its location. In addition to the retail sellers covered by SB 107, SB X1 2 adds local publicly owned electric utilities to the RPS. The statute also requires that the governing boards for local publicly owned electric utilities establish the same targets, and the governing boards would be responsible for ensuring compliance with these targets. The California Public Utilities Commission will be responsible for enforcement of the RPS for retail sellers, and the CEC and CARB will enforce the requirements for local publicly owned electric utilities.

CEQA Guidelines Appendix F

Appendix F of the CEQA Guidelines outlines what information should be included within an EIR regarding energy conservation where considered applicable or relevant. This appendix includes a list of energy impact possibilities and potential conservation measures and the goals of efficient use of energy during development and operations.

Local**SDG&E Long-Term Resource Plan**

In 2004, SDG&E filed a long-term energy resource plan (LTRP) with the California Public Utilities Commission, which identifies how it will meet the future energy needs of customers in SDG&E's service area. The LTRP identifies several energy demand reduction (i.e., conservation) targets, and goals for increasing renewable energy supplies, new local power generation, and increased transmission capacity.

The LTRP sets a standard for acquiring 20% of SDG&E's energy mix from renewables by 2010 and 33% by 2020. The LTRP also calls for greater use of in-region energy supplies, including renewable energy installations. By 2020, the LTRP states that SDG&E intends to achieve and maintain the capacity to generate 75% of summer peak demand with in-county generation. The LTRP also identifies the procurement of 44% of its renewables to be generated and distributed in-region by 2020.

City of Carlsbad Sustainable Energy Master Plan

In December of 2008, the City of Carlsbad released its Sustainable Energy Master Plan, a report on potential renewable energy sources and measures to reduce power consumption. This report evaluated a variety of energy efficiency and reduction measures including automated meter readings to monitor water meters and reduce operating costs, off-peak water pumping to lower power costs, and variable speed motors to increase efficiency of heating, ventilation, and air conditioning (HVAC) systems and water pumps. The report also evaluated green roofs that reduce indoor building temperatures and reduce GHGs, and evaluated solar water heating systems and tankless water heating systems to reduce energy consumption. The master plan also addressed hybrid and electric vehicles, energy efficient chillers, Leadership in Energy and Environmental Design (LEED) green building standards, LED traffic signals and interconnection, induction and LED streetlights, and energy management systems (City of Carlsbad 2014).

CCC Required Energy Minimization and Greenhouse Gas Reduction Plan

The CCC required an Energy Minimization and GHG Reduction Plan as a condition of the Coastal Development Permit for the CDP. In addition to establishing a reputable process for quantifying the CDP's GHG emissions and for Poseidon to obtain the required GHG offsets, the Energy Minimization and GHG Reduction Plan describes a variety of energy efficiency measures that have been incorporated into the design of the CDP including:

- Use of a state-of-the art pressure exchanger based energy recovery system that allows recovery and reuse of 33.9% of the energy associated with the reverse osmosis process.
- Use of premium efficiency motors and variable frequency drives on desalination plant pumps that have motors of 500 horsepower or more.
- Construction of the plant using “green building design” principles.

These energy efficiency measures serve to further reduce the electricity requirements of the CDP.

Existing Electricity Conditions

Carlsbad Desalination Plant

The CDP currently uses electricity from the grid to power its operations to create desalinated product water. As described in Section 4.2, Air Quality, of the FEIR CDP intake water pump station, pretreatment facilities, reverse osmosis system, product water pump station, membrane cleaning system, chemical feed equipment, solids handling equipment, service facilities (i.e., HVAC, lighting), would all require electricity from the grid. The FEIR estimated that approximately of 36.05 MWh/year~~h~~ of electrical power would be required to operate the CDP at the maximum production rate evaluated in the FEIR (Poseidon Resources 2004).

4.5.2 Significance Criteria

Pursuant to California Public Resources Code Section 21100(b)(3) and as discussed in Appendix F of the CEQA Guidelines, CEQA “requires that EIRs include a discussion of the potential energy impacts of proposed projects.” Appendix F does not prescribe a threshold for the determination of significance. Rather, Appendix F focuses on the “potentially significant energy implications of a project...to the extent relevant and applicable to the project,” and on reducing and minimizing inefficient, wasteful, and unnecessary consumption of energy. Therefore, based on Appendix F of the CEQA Guidelines, for the purposes of this EIR, a significant impact to energy would result if the proposed modifications would result in the wasteful, inefficient, or unnecessary use of energy.

4.5.3 Impacts

Although the FEIR did not specifically address the efficiency of use of energy resources and conservation for the CDP in a separate section, electricity demand was discussed in the context of determining the CDP's criteria air pollutant emissions in Section 4.2, Air Quality, and the demand on the electrical grid infrastructure in Section 4.11, Public Utilities and Service Systems, of the FEIR. The electrical grid infrastructure analysis in Section 4.11, Public Utilities and Service Systems, of the FEIR concluded that impacts to the electricity grid infrastructure would be less than significant. The FEIR stated that the desalination plant intake water pump station, pretreatment facilities, reverse osmosis system, product water pump station, membrane cleaning system, chemical feed equipment, solids handling equipment, service facilities (i.e., HVAC, lighting), and the Oceanside pump station would all require electricity from the grid during operations.

The maximum electricity demand of these components evaluated in the FEIR was 36.05 MWh/year^h of electrical power (Poseidon Resources 2004). Furthermore, the FEIR stated that the CDP will not contain any electrical-power-generation facilities, and will purchase this electrical power from the local electric utility, or a power generator, broker or seller.

A. *Result in the wasteful, inefficient, or unnecessary use of energy?*

During construction of the proposed CDP modifications, energy in the form of diesel and gasoline would be used to power heavy construction equipment, construction worker vehicles, haul truck trips, and vendor trips traveling to and from the project site. However, construction equipment fleet turnover and increasingly stringent state and federal regulations on engine efficiency combined with local, state, and federal regulations such as limiting engine idling times would further reduce the amount of diesel and gasoline demand during construction of the proposed modifications. Regulations such as the Low Carbon Fuel Standard, Pavley Clean Car Standards, and Low Emission Vehicle Program would also serve to reduce the project's transportation fuel consumption progressively into the future. Additionally, the proposed modifications would be constructed intermittently over an approximately 18-month period. As such, the use of diesel and gasoline for construction would be temporary and would not represent a substantial demand in future years. Due to economic incentives for the construction contractors, vehicle trips and the use of heavy equipment during construction would be limited to those functions necessary for construction of the proposed modifications and would not represent a wasteful, inefficient, or unnecessary use of energy. Considering these reductions in diesel and gasoline use, as well as the temporary duration of when they would be used during construction, the proposed modifications would not result in the wasteful and inefficient use of energy resources during construction and impacts would be less than significant.

Operations of the CDP with incorporation of the proposed modifications would not substantially change the use of natural gas for heating purposes or the amount of diesel and gasoline from maintenance vehicles and worker vehicle trips. However, the CDP with incorporation of the proposed modifications could produce an additional annual average 5 mgd of product water during operations (up to 60 mgd daily maximum capacity). The added 5 mgd annual average of product water would require additional electricity during operation of the CDP that would be provided by SDG&E through the electrical grid. The potential annual average production of an additional 5 mgd would result in an estimated maximum of 3.6 MWh/year_h of additional electricity demand. In addition to this potential 5 mgd annual average increase in production capacity, the proposed modifications would involve the use of new traveling screen motors and increased pumping, including the fish friendly pumps that would require an additional 1.7 MWh/year_h of electricity during stand-alone operations. The increased demand for fish friendly pumps is offset by the closure of pumping by EPS of cooling water system. In total the proposed modifications, including the annual average increase of 5 mgd of product water, would result in an additional demand for electricity of 5.3 MWh/year_h. The FEIR projected the CDP would have a maximum electricity demand of approximately 36.05 MWh/year_h. The expected average CDP electricity demand is 32.0 MWh/year_h when operating at 50 mgd in co-located operation. The addition of 5.3 MWh/year_h to the CDP's expected average electricity demand would result in a total expected average demand of 37.3 MWh/year_h when operating at 55 mgd in stand-alone operation. The worst case maximum energy demand would be 45.0 MWh/h (8.9 MWh/h increase) when operating at a daily maximum of up to 60 mgd in standalone operation under the most extreme operating conditions (cold seawater with elevated salinity). This represents an increase in the existing average electricity demand of approximately 16.6% (5.3% for the transition to standalone operation and 11.3% for the expanded capacity) and a maximum increase in the worst case electricity demand of 24.7% (4.7% for the transition to standalone operation and 20.0% for the expanded capacity), representing an ostensible reduction in efficiency in the use of electricity. ~~The potential increase in energy demand includes those components associated with transition consisting of the fish friendly pumps and travelling intake screens.~~

Although the proposed modifications would increase the total electricity demand, many features of the CDP and the proposed modifications would be energy efficient. As a condition of approval through the CCC's permitting process, an Energy Minimization and GHG Reduction Plan was created for the CDP. The Energy Minimization and GHG Reduction Plan describes multiple aspects of the CDP that minimize energy use and that would also apply to the CDP with incorporation of the proposed modifications.

These energy saving features include:

- Energy efficient desalination plant process design including the following:
 - Use of a state-of-the art pressure exchanger based energy recovery system that allows recovery and reuse of 33.9% of the energy associated with the reverse osmosis process.
 - Use of premium efficiency motors and variable frequency drives on desalination plant pumps that have motors of 500 horsepower or more.
 - Construction of the plant using “green building design” principles.

These energy efficient features reduce the requirements for electricity resulting from the potential annual average increase in 5 mgd of product water, included as part of the proposed modifications. Additionally, increasingly stringent statewide regulations for renewable energy production, such as the 33% RPS by 2020, would increase the use of renewable energy sources by SDG&E and reducing the dependence on fossil fuel based sources for electricity generation into the future. Furthermore, although electricity consumption statewide has generally increased over the last decade, electricity use in San Diego County has remained relatively similar in part due to increased efficiencies of newly constructed buildings and SDG&E’s increase in renewable energy sources used for electricity generation.

The proposed CDP modifications, including the potential average annual increase ~~in~~ of 5 mgd of product water, secures a drought-proof, local source of water that ~~would provide~~ local water supply reliability and security and ~~reduce the effect of increasing water costs on rate payers in the Water Authority’s service area~~. The use of energy in this instance is necessary to support the additional source of potable water in drought stricken California in an area close to the demand for that water. Further discussion regarding the role of desalination in the regional water supply is included in Section 6, Growth-Inducing Impacts. The proposed modifications would also use the additional electricity demand to operate fish friendly pumps, traveling screens, and a fish return system that would greatly reduce the potential effects on marine life from operation of the ocean water intake. The proposed modifications to the CDP would use more energy and could potentially reduce some CDP equipment energy efficiencies ~~increase the inefficient or wasteful use of energy~~; however the proposed modifications provide additional benefits from the increase in electricity demand. With implementation of the state and City energy code and policies, and because the proposed modifications energy use would be rolled into the CDP’s Energy Minimization and GHG Reduction Plan, which commits to efficient and non-wasteful use of energy, the proposed CDP modifications would not result in the wasteful, inefficient, or unnecessary use of energy during operations. Impacts would be less than significant.

4.5.4 Mitigation Measures

No mitigation measures are required. However, the Energy Minimization and GHG Reduction Plan as required as a Special Condition in the coastal development permit for the CDP would be applicable to the incorporation of the proposed modifications

4.5.5 Level of Significance after Mitigation/Residual Impact

All impacts would be less than significant. No new mitigation is required.

INTENTIONALLY LEFT BLANK

SECTION 5 CUMULATIVE IMPACTS

5.1 INTRODUCTION / METHODOLOGY

As required by Section 15130 of the CEQA Guidelines, this SEIR analyzes whether the proposed modifications may have a significant impact on the environment due to cumulatively considerable environmental impacts, even when the environmental impacts are individually limited. Cumulatively considerable, as defined by Section 15065(c) of the CEQA Guidelines, means the incremental impacts of an individual project are considerable when viewed in connection with the related impact of recent past projects, other current projects and probable future projects. Section 15355 of the CEQA Guidelines defines cumulative impacts as “two or more individual environmental effects which, when considered together, are considerable or which compound or increase other environmental impacts.” Cumulative impacts may result from individual effects of a single project or the effects of several projects that are developed within a particular window of time.

The scope of the cumulative analysis varies by environmental topic, because cumulative projects that are relevant to one issue may not be to another. For example, projects that would contribute to cumulative traffic impacts are most likely unrelated to projects that would be relevant to cumulative marine biological resources.

The list of cumulative projects identified in Table 5-1 is intended to be comprehensive list of cumulative projects that would have the potential to result in cumulative impacts when considered in conjunction with the proposed CDP modifications. The overall effect of cumulative projects and the proposed modifications are described and analyzed in this section. The scope for identifying potential cumulative projects for this SEIR, unless otherwise stated, is established as approximately three-miles from the proposed modifications. The proposed modifications are of a relatively small scale and thus would not be expected to have direct environmental effects that extend beyond that geographic limit.

5.1.1 Cumulative Projects

Table 5-1 summarizes all potential projects within the above outlined study area that when considered together with the proposed CDP modifications could contribute to cumulative impacts . This table provides information relating to the project and the project status.

**Table 5-1
Cumulative Projects**

Cumulative Project	Description and Status	Location
El Camino Real (ECR) widening project from Tamarack to Chestnut	Widen ECR to 3 lanes in each direction; provide sidewalks, widened bike lanes and other improvements between Tamarack and Chestnut. Under construction.	El Camino Real from Tamarack to Chestnut
Improvements on Carlsbad Boulevard in the area of Cannon Road	In the planning stages - the improvements would improve the safety for pedestrians and bicyclists. Pending construction.	Carlsbad Blvd Cannon Rd – Manzano Dr
Agua Hedionda Sewer Lift Station replacement project	Extends in a north-south direction from the Agua Hedionda Lagoon to the Encina Water Pollution Control Facility. The project involves the installation of a sewer trunk line (3,960-foot-long force main and a 8,420-foot-long gravity sewer line), a sewer lift station (50 million gallons/day capacity), and a sewer support bridge (140-foot weathered steel span), and improvements to the Vista/Carlsbad Sewer Interceptor System. Under construction.	Behind the desalination plant and on the east side of the RR tracks.
Fire Station No. 3, Robertson Ranch	10,400 sq ft fire station. Under construction.	Cannon Road, east of ECR is nearing completion.
I-5 North Coast Corridor Project	I-5 Improvements including express lanes, widening, sound walls, bike and pedestrian paths, and interchange improvements. Double tracking and upgrades to rail stations and platforms. Also includes environmental enhancements such as habitat creation and preservation. Construction due to begin 2016.	I-5 and rail corridor, from La Jolla Village Dr in San Diego to Harbor Dr in Oceanside.
Agua Hedionda Lagoon Dredging	Periodic Dredging of Agua Hedionda Lagoon to ensure adequate flow to the cooling water in let for EPS. Ongoing episodic.	Agua Hedionda Lagoon
Carlsbad Energy Project	Construction of a new electric generating facility to be sited along the eastern boundary of the EPS that would replace the aging, inefficient EPS Units 1-5 that employ once-through cooling using seawater. Once constructed and operational, the project includes the removal and remediation of existing EPS generating equipment and structures. Pending construction.	EPS
Agua Hedionda South Shore Specific Plan Amendment – “85/15”	203.4 acres 85% of which (176.7 acres) would be open space and 15% (26.7 acres) of which would be developed with up to 585,000 sq ft of commercial uses (shopping mall). Application submitted 9/10/15. Under review.	N side of Cannon Rd between I-5 and Armada Dr
Beachwalk at Roosevelt	16 3-story townhomes. Application 11/05/14. Under review.	2683 + 2686 Roosevelt St
Carlsbad Blvd Bluff Erosion	Backfill stabilize and install rip rap. Application 1/23/15. Under review.	Carlsbad Blvd, s of Encinas Bridge N of State Campgrounds
Carlsbad Boat Club and Resort	3-story 20-unit timeshare development. Application 12/19/14.	4509 Adams St
Carlsbad Ranch Planning Area 5	Sheraton Resort and Timeshare remodel and new multistory buildings. Application 7/21/15. Under review.	E & W Side Of Grand Pacific Dr between Cannon Rd & The Crossings Dr
Home2 Carlsbad Suites	147 room hotel. Application submitted 8/31/15. Under review.	190 Wright Pl
Inns at Buena Vista Creek	3 hotels w central parking Application 11/26/14. Under review.	Corner of Jefferson St and SR 78 interchange (mostly in Oceanside)

**Table 5-1
Cumulative Projects**

Cumulative Project	Description and Status	Location
Ocean View Point	13 residential lot subdivision. Application 6/24/15. Under review.	S side of terminus of Twain Ave
Pacific Wind	Redevelopment of 120 affordable apartments Application 8/27/15. Under review.	901 Magnolia Ave
Westin Hotel & Timeshare	2 Hotel buildings & One 36-Unit Timeshare on 3.66 Acres. Application 5/07/15. Under review.	S side of Cannon Rd east of Grand Pacific Dr
The Wave	4-story mixed use retail timeshare residential. Application 6/10/15. Under review.	2646 State St
Hoehn Motors Dealership at Cannon and Paseo del Norte	Application 6/30/15. Under review.	6800 Avenida Encinas
New Floral Trade Center (North 40 Urban Farm)	Development of new 44,180 sq ft floral trade distribution center and marketplace, 9,900 sq ft micro-brewery and winery building, 1,984 sq ft culinary center, and 896 sq ft farm shed with remaining land dedicated to farm plots orchards, hops farm, vineyard and parking on 17.72 acres of land within a 45.60 acre site. Under construction.	South of Cannon Road and east of Car Country Drive, across from the strawberry fields.
Grand Pacific Resorts, phase 2, constructing 162 timeshare units	Application 6/10/15. Under review.	Cannon Road.
State Mixed Use 30	4-story mixed use building. 14 residential, 13 timeshares, 4,529 sq ft of commercial. Grading and building permits pending.	3068 State St. (corner of State Street and Oak Ave)
State Street Townhomes	41 market rate & 6 inclusionary housing units with ground level office/flex space for live-work. Includes demolition of approximately 32,000 sq ft of existing commercial and light industrial uses. Under construction.	2531-2586 State St
Tabata 10	26 single family residences. Recently constructed.	2311 Camino Hills Dr
Robertson Ranch East Village	469 residential units, of which 78 would be multi-family the remainder single family detached.	NE corner of El Camino Real and Cannon rd.
Robertson Ranch West Village	Masterplan development of 672 residential units (364 multifamily units with the remainder 308 single family) and 175,000 sq ft commercial. Under construction.	N Side Of El Camino Real between Cannon Rd & Tamarack Av
Quarry Creek MP	Master planned for 636 residential units (64 affordable units, 278 market apartments, 88 multi-family townhomes, 150 multi-family townhomes, 56 single-family detached small lot), 1.5 acre community facilities, 1.3 acre park and ride site, 92.4 acres of natural open space, and supporting infrastructure. Site total is 155.4 acres. Approved pending construction.	S side of Hwy 78, either side of Haymar Dr between Marron Rd and Buena Vista Creek Reserve

5.2 ANALYSIS OF CUMULATIVE IMPACTS

Analysis of cumulative impacts requires estimation in many cases, because specific quantification of impacts is not always possible due to variations in the status and timing of projects and environmental conditions that may exist when cumulative projects are developed.

CEQA notes that the discussion of cumulative impacts should be guided by standards of practicality and reasonableness (CEQA Guidelines, 15130 (b)).

5.2.1 Air Quality

Cumulative air quality impacts are analyzed in Section 4.1, including discussions of the CDP with incorporation of proposed modifications consistency with applicable air quality plans that guide regional air quality strategies and the proposed modifications potential to result in a cumulatively considerable net increase of any criteria pollutant. The cumulative area for air quality is the entire San Diego Air Basin. The proposed modifications would not result in a considerable direct contribution to any cumulatively significant air quality impact. However, the FEIR findings identified that the increased electricity demand could result in a significant indirect increase in criteria pollutants because the generation of that electricity could be achieved by fossil fueled power plants within the SDAB. This indirect contribution to a cumulative impact is significant and unavoidable. Compared to that considered in the FEIR, inclusion of the proposed CDP modifications substantially increases the severity of the cumulative air impacts. However, the level of significance would remain the same and no new feasible mitigation is known that would reduce the impacts to below the level of significance.

5.2.2 Biological Resources

The nearest cumulative projects are the Agua Hedionda periodic dredging, the Carlsbad Energy Center, and the Agua Hedionda South Shore Specific Plan (85/15). Of these projects only the Agua Hedionda periodic dredging has the potential to affect marine biological resources. It is reasonable to assume that each cumulative project would comply with applicable Clean Water Act, Endangered Species Act, Coastal Act, and other regulatory requirements designed to protect the marine biological environment, which would minimize impacts to marine biological resources. No other cumulative projects are anticipated to be under construction at the same time as construction of the proposed modifications. Therefore, during construction, a cumulative impact to marine biological resources would not occur, and the proposed modifications would not cumulatively contribute to a significant cumulative impact, consistent with the conclusions in the FEIR.

During operation of the proposed modifications, the only cumulative project that would reasonably have the potential to substantially affect ocean water quality would be periodic dredging activities of Agua Hedionda. No other cumulative project would result in lagoon water intake, brine discharge to the Pacific Ocean, or other direct effects to the lagoon or Ocean. The periodic dredging involves the removal of sediment build up from the lagoon, maintaining adequate depth of the lagoon to the intake tunnel for waters to flow. Material dredged is placed on adjacent beaches and provides sand nourishment for the beach. The dredging is a continual

periodic maintenance activity that would continue with operation of the CDP with proposed modifications and would not result in significant impacts to biological resources. Therefore, during operation, a significant cumulative impact would not occur, and the proposed modifications would not cumulatively contribute to a significant cumulative impact, consistent with the conclusions in the FEIR.

The proposed modifications would result in minor modifications to the approved CDP that would not change the function or use of the site as a desalination plant and the proposed modifications are located within a relatively small portion of the PDP area. The proposed modifications would not result in substantial changes to the CDP such that additional cumulative effects would occur beyond what was analyzed in the FEIR. Therefore, the CDP with incorporation of the proposed modifications would not result in a cumulatively considerable effect on biological resources and cumulative impacts would be less than significant, consistent with the conclusions in the FEIR.

5.2.3 Greenhouse Gas Emissions

Global climate change is by definition a cumulative impact; a project participates in this potential impact through its incremental contribution combined with the cumulative increase of all other sources of greenhouse gases (GHGs). Thus, GHG impacts are recognized as exclusively cumulative impacts; there are no non-cumulative GHG emission impacts from a climate change perspective (CAPCOA 2008). As such, cumulative impacts from GHG emissions are discussed above in Section 4.3. As described therein, the CDP with incorporation of the proposed modifications would not have a cumulatively considerable contribution of GHG emissions and would not result in a cumulative impact.

5.2.4 Hydrology and Water Quality

The nearest cumulative projects are the Agua Hedionda periodic dredging, the Carlsbad Energy Center, and the Agua Hedionda South Shore Specific Plan (85/15). All projects listed have the potential to affect water quality effects during construction due to the presence of hazardous materials, oils, lubricants, and other materials that may be released and affect local water quality. Additional, construction grading and excavation would increase erosion potential of each respective cumulative project site. During construction, each cumulative project would control for stormwater pollution and erosion in a similar way as the proposed modifications through implementation of construction BMPs (such as sediment screening, filtration, and proper handling and storage of construction materials) and compliance with the Construction General Permit. It is reasonable to assume that each cumulative project would comply with applicable construction stormwater and waste discharge requirements that would minimize impacts to water

quality. Therefore, during construction, a cumulative impact to water quality and hydrology would not occur, and the proposed modifications would not cumulatively contribute to a significant cumulative impact, consistent with the conclusions in the FEIR.

During operation of the CDP with incorporation of the proposed modifications, no other cumulative project would reasonably have the potential to substantially affect ocean water quality through brine discharge. Although cumulative projects would likely contribute to pollutants in stormwater runoff from new land uses, these pollutants would be typical of urban development and it would be too speculative to pinpoint the pollutant source once the stormwater runoff reaches the ocean. Therefore, during operation, a significant cumulative impact would not occur, and the CDP with incorporation of the proposed modifications would not cumulatively contribute to a significant cumulative impact, consistent with the conclusions in the FEIR.

The proposed modifications would result in minor modifications to the approved CDP that would not change the function or use of the site as a desalination plant and is located within a relatively small portion of the PDP area. The proposed modifications would not result in substantial changes to the CDP such that its potential for additional cumulative effects would occur beyond what was analyzed in the FEIR. Therefore, the CDP with incorporation of the proposed modifications would not result in a cumulatively considerable effect on hydrology and water quality and impacts would be less than significant, consistent with the conclusions in the FEIR.

5.2.5 Energy

The CDP with incorporation of the proposed modifications and cumulative projects are consistent with planned development anticipated under the General Plan and would increase future energy consumption within the plan area, resulting in additional demand for electricity and natural gas supply and services. The General Plan EIR identifies that planned development would result in an increase in energy consumption and generation of GHG emissions from mobile, stationary, and area sources. Federal, state, and local regulations, as well as policies in the General Plan and associated reduction measures in the CAP would make the impacts of the planned growth within the General Plan less than significant. Cumulative projects would increase the population and employment in the City, and associated energy demand above existing conditions. However, despite the overall increase in future energy use, the state's current and future energy code and the General Plan policies would ensure energy efficient designs in new development and encourage energy efficiency upgrades in existing development, both of which would minimize wasteful, inefficient energy consumption.

Each of the cumulative projects would be required to comply with the state's Title 24 energy performance standards and the City's General Plan energy conservation policies and actions. General

Plan Policy 9-P.2 promotes energy conservation throughout all municipal operations and the use of alternative transportation to reduce energy consumption. General Plan Policy 9-P.8 promotes energy efficiency through green building construction and building retrofits. General Plan Policy 9-P.10 promotes energy conservation through reductions in artificial cooling, heating and lighting energy use. General Plan Policy 9-P.12 directs the city to explore renewable energy resources and infrastructure. General Plan Policy 9-P.13 establishes the City's CAP as the platform for delineating and implementing energy conservation measures for future development.

With implementation of the state and City energy code and policies, cumulative impacts would be less than significant. Furthermore because the proposed modifications energy use would be rolled into the CDP's Energy Minimization and GHG Reduction Plan, which commits to efficient and non-wasteful use of energy, the proposed CDP modifications would not result in a cumulatively considerable contribution.

INTENTIONALLY LEFT BLANK

SECTION 6

GROWTH-INDUCING IMPACTS

6.1 INTRODUCTION

CEQA requires a discussion of the ways in which a project could be an inducement to growth. The CEQA Guidelines Section 15126.2(d) identify a project to be growth-inducing if it fosters economic or population growth or the construction of additional housing, either directly or indirectly, in the surrounding environment. As an example, population growth resulting from proposed residential development projects, and new employees hired for proposed commercial and industrial development projects represent direct forms of growth. Examples of projects that are indirectly growth-inducing are the expansion of urban services into a previously unserved or underserved area, the creation or extension of transportation links, or the removal of major obstacles to growth. It is important to note that direct forms of growth have secondary effects of expanding the size of local markets and attracting additional economic activity to the area.

Typically, the growth-inducing potential of a project would be considered significant if it stimulates population growth or a population concentration above what is assumed in local and regional land use plans, or in projections made by regional planning authorities such as SANDAG. Significant growth impacts could also occur if the project provides infrastructure or service capacity to accommodate growth levels beyond those anticipated by local or regional plans and policies. The key issue related to growth inducement for the proposed project is whether or to what extent water supplies provided by the proposed CDP modifications (i.e., the proposed project) would have indirect growth-inducing impacts. To understand this issue, it is first important to consider existing water supply issues within the project's service area. It is also important to consider water supply in the context of other growth-related constraints. Growth-limiting factors in San Diego County are primarily related to availability of buildable land and adequate infrastructure to support growth in new areas. Therefore, there is not a linear relationship between water availability and growth.

The FEIR analyzed growth impacts within Section 9, Growth-Inducing Impacts. The analysis relied upon population growth limited by buildable land, infrastructure, and planning and development processes. Additionally, the Water Authority uses SANDAG's most current population growth forecasts to properly plan for water supply. Through analysis of local and regional water supply management plans, including the Regional Water Facilities Master Plan and the City's Urban Water Management Plan, the FEIR determined that the CDP would not induce substantial population growth on a local level.

The proposed CDP modifications would not directly alter the average daily potable water output of 50 million gallons per day (mgd) that was analyzed in the FEIR and approved by the City of Carlsbad. However, since the time of the original CDP approvals, the efficiency of reverse osmosis membrane technology has improved. These advances enable the CDP to increase the average daily potable water output from approximately an annual average of 50 mgd to approximately an annual average of 55 mgd with minimal improvements to the plant. The daily maximum production would increase from 54 mgd to 60 mgd. The following evaluation follows an analysis approach similar to that presented in the FEIR, focusing only on the worst case potential increase to up to 60 mgd of potable water provided by the CDP.

6.2 EXISTING WATER SUPPLIES

Current water supplies in San Diego County include imported water purchased from the Metropolitan Water District of Southern California (MWD). ~~MWD is a consortium of 26 member public agencies that delivers~~ and conveys an average of 1.7 billion gallons of water per day to 26 member public agencies and more than 19 million people in parts of Los Angeles, Orange, San Diego, Riverside, San Bernardino and Ventura counties. MWD obtains its imported water supplies from two primary sources: the Colorado River and the State Water Project.

The Water Authority purchases imported water from MWD and from the Imperial Irrigation District through a water transfer agreement. The Water Authority also contracted for and receives conserved imported water resulting from the lining of the All-American and Coachella Canals. The Water Authority also purchases and delivers the water produced at the CDP. The Water Authority, and wholesales the imported water to its member agencies, which, in turn, deliver the water to individual homes and businesses throughout the county.

In addition to imported water, local water supplies comprise a portion of water delivered by Water Authority member agencies. Seven major stream systems originate in the mountains of San Diego County and drain into the Pacific Ocean, and 24 surface reservoirs are located within the service area, with a combined capacity of approximately 746,000 acre-feet. The total capacity of the Water Authority's surface reservoirs has increased by approximately 31% since 2003 (San Diego County Water Authority 2015a). Groundwater is also a component of local water supplies. Total existing groundwater production within the Water Authority service area is approximately 22,030 to 28,360 acre-feet per year (San Diego County Water Authority 2014).

Another local water supply source consists of water recycling. Currently, approximately 28,800 acre-feet of recycled water is used within the Water Authority's service area annually. This number is projected to increase to over 40,000 acre feet per year by 2020 (San Diego County Water Authority 2015b). Although not technically a water supply "source," conservation is also

an important strategy employed within the region to reduce demand for water supply. Water conservation programs are maintained by MWD, the Water Authority and local water agencies.

~~MWD, the Water Authority, and local water agencies are increasingly recognizing~~ the need to lessen the dependence on imported water to meet future demand generated by projected population growth. Accordingly, ~~diversifying water supplies and ensuring reliability,~~ acknowledging current and planned water supply diversification, is a primary component of the Water Authority's adopted 2013 Regional Water Facilities Master Plan Update (Master Plan) and the Urban Water Management Plan (UWMP) (most recent version is the 2015 UWMP; ~~with the 2015 UWMP currently under development~~).

6.3 REGIONAL PLANNING – GROWTH FORECASTS AND WATER DEMAND PROJECTIONS

San Diego County's population and employment base have grown and are expected to continue to grow at moderate rates. Since the time of the certification of the FEIR in December 2005, the County's population grew from approximately 2,976,492 people at the start of 2006 to approximately 3,227,496 people at the start of 2015 (approximately 8.4% increase) (Department of Finance 2012, 2015). The County's population is projected to reach approximately 4,068,759 people by 2050, an additional increase of approximately 26% from 2015 (SANDAG 2013). The water demand projected by SANDAG and the Water Authority is expected to increase as a direct function of the anticipated growth in population, and related housing and employment markets.

At the same time that water demand within the region increases as a result of increasing regional growth, imported water supplies are becoming more constrained. This is because growth in other regions that draw water from the same imported sources (the Colorado River and the State Water Project), coupled with increasing regulatory restrictions are placing increased pressures on imported water supplies, causing regional and local water agencies to develop strategies to increase drought-resilient local water sources to meet demand and provide a more reliable long-term water supply. In addition, regulatory changes including Governor's Executive Orders B-26-14, B-28-14, B-29-15, and B-36-15, and climate change have exerted additional pressures on water supply reliability providing further impetus for the consideration of alternative local water supply sources.

In July 2004, SANDAG adopted its Regional Comprehensive Plan (RCP), and certified the accompanying Final Program EIR. A draft of the RCP update, San Diego Forward: The Regional Plan, was published in April 2015 and approved by SANDAG on October 9, 2015; however, this updated draft does not address future water supply, but refers to the Water Authority's UWMP. The RCP was developed as the long-term planning framework for the San Diego region. It

provides a broad context in which local and regional decisions affecting regional growth can be made. The RCP integrates local land use and transportation decisions, and focuses attention on where and how growth should occur. The RCP includes a discussion of public facilities, and specifically addresses future water supply. Part of the vision stated in the RCP for Public Facilities is to “have a diversified water supply with a broad range of water resources including seawater desalination” (SANDAG 2015). The RCP’s long-range plans call for the region to diversify its water supply portfolio to become less reliant on a single supply source. In meeting future water needs, the RCP anticipates that the 2020 normal year projection for water supplies will include between 6% and 15% seawater desalination. The approved CDP represents approximately 106% of projected 2020 demands. The RCP expresses the importance of a balanced water supply through an identified continuing action: “Continue to coordinate with the San Diego County Water Authority on longer term demand forecasting to ensure adequate and reliable water supplies for the future” (SANDAG 2015). One of the Performance monitoring indicators of healthy environment and communities in the RCP is “Diversity of water supply” (SANDAG 2015).

The Water Authority and SANDAG have entered into a Memorandum of Agreement to maintain ongoing communication and coordination to ensure that the future water supply needs of the San Diego region can be accomplished. SANDAG prepares long-range forecasts of population, housing and employment through periodic updates to their Regional Growth Forecast. The Water Authority uses the most current growth forecast to develop demand projections to be used in its water supply planning. The Memorandum of Agreement ensures that the water demand projections for the San Diego region are linked with SANDAG’s growth forecasts and that water supply is a component of the overall growth management strategy and regional comprehensive planning efforts. In this way, regional water demand is made consistent with regional population growth projections.

As a part of the Water Authority’s planning efforts to meet future demands resulting from projected growth, it adopted the 2013 Master Plan, intended to serve as the region’s roadmap for new infrastructure development through the Water Authority’s 2035 planning horizon. A primary focus of the 2013 Master Plan is to optimize existing systems while maintaining the flexibility to adjust to a range of future planning outcomes. This planning approach is based on developing scenarios that represent a variety of reasonable future water supply and demand conditions (San Diego County Water Authority 2014). The Final Supplemental Program EIR was certified and the 2013 Master Plan was adopted in March 2014.

The 2013 Master Plan identifies the CDP as an approved and fully permitted seawater desalination plant and pipeline project that is “considered highly reliable and when completed,

the Carlsbad project is expected to produce a consistent 56,000 [acre-feet (approximately 50 mgd)] of water each year” (San Diego County Water Authority 2014).

The 2013 Master Plan incorporates demand projections calculated in the 2010 UWMP. Regional water demand forecasts based on SANDAG’s population growth projections were part of the water supply planning effort included in the 2010 UWMP and the 2013 Master Plan. As a result of the analysis performed for the 2013 Master Plan, multiple recommendations for both near-term and long-term water infrastructure projects were provided, which include pipeline conveyance facilities, pump stations, and enhanced system regulatory storage portfolio (San Diego County Water Authority 2014). Section 4.2 of the Final Supplemental Program EIR for the 2013 Master Plan (incorporated by reference herein) discusses the growth-inducing potential for the master plan, which includes consideration of approved and potential seawater desalination water supply component, and concludes that the 2013 Master Plan would not induce substantial growth directly, as it does not provide a vehicle for land use decisions, and indirectly, as it is too speculative to assume that an increase in water supply available would be the sole barrier to growth when all other barriers (access, land use planning, public services and other utilities) would not be removed by an increase in water supply.

Due to improved efficiencies in technology, the proposed project could result in an increase in average annual potable water output beyond what was analyzed and approved in the FEIR. Specifically, the proposed project could result in a total daily supply of an annual average of 55 mgd and up to 60 mgd daily maximum, instead of the previously approved an annual average of 50 mgd and daily maximum of 54 mgd. However, the increase is consistent with long-term projections in current regional planning documents. Similar to the analysis found in the Final Supplemental Program EIR for the 2013 Master Plan, the availability of additional water supply would not directly induce growth; the proposed project production capacity increase would not result in, provide for, or approve land development beyond the facilities associated with the CDP. Additionally, it would be speculative to conclude that an increase in water supply alone would indirectly result in substantial growth in the San Diego region when many other such barriers to growth, such as available land, land use planning, transportation infrastructure, employment, and other public services. The potential worst case increase to up to 60 mgd in production is consistent with the need for desalinated water identified in the Water Authority’s 2003 Regional Water Facilities Master Plan and the 2013 Update of the Regional Water Facilities Master Plan where desalinated water is identified as a potential long-term supply that could be developed, based on future local and statewide water resource conditions. Both the 2003 Regional Water Facilities Master Plan and 2013 Update identify seawater desalination as a potential future water supply.

In November 2003, the Water Authority Board of Directors certified a Program Environmental Impact Report (PEIR) for the Water Authority's Regional Water Facilities Master Plan Project and approved Alternative 2 – Conveyance of Supplies from the West, or Regional Seawater Desalination, as the new supply for development. In the 2003 PEIR, as part of the preferred alternative Project Description (Section 2.9.1.5, New Conveyance and Supply), it describes Phase I as the Seawater Desalination Project at the EPS, with an initial capacity of 50 mgd. The 2003 PEIR Project Description also considered a Phase II, where “seawater desalination development would include expansion of seawater desalination capacity between 30 and 50 mgd, up to a total of 100 mgd, at the existing Seawater Desalination Plant at the EPS, or construction of a new seawater desalination plant at a location other than the EPS by 2015” (San Diego County Water Authority 2003). The 2003 PEIR also looked at a third phase, where seawater desalination development would include expansion of capacity between 50 and 70 mgd, up to a total of 150 mgd, again at either the EPS or at another location by 2020.

One of the Project Objectives of the 2003 Master Plan, and the ~~recently~~-approved 2013 Regional Water Facilities Optimization and Master Plan Update and certified Supplemental PEIR, is to have the ability to adjust facility location, size, and timing to meet changes in future demands. Inherent in the Master Plan is a built-in flexibility designed to allow the Water Authority to respond to slowed or accelerated local supply development and/or population growth and associated water demand within the region. The Water Authority can adjust the implementation schedule for appropriate Master Plan elements (projects) consistent with future revisions of the SANDAG regional growth forecasts and/or the Water Authority's UWMP updates. As such, consideration of additional capacity expansion at the CDP to up to 60 mgd falls within the capacity ranges already considered and analyzed as part of the 2003 PEIR Alternative 2 Project Description. ~~So although the additional annual average potable water output potentially resulting from the proposed CDP modifications would be above current regional growth and water projections sourced from the CDP, thus increasing the severity of potential effects on growth, the CDP with incorporation of the proposed modifications would not result in significant growth beyond current projections because future additional water supply is planned to be sourced from desalinated water through the proposed development of the other seawater desalination water sources. Therefore, it is not anticipated that delivery of water from a different supplier would have any effect on planned growth within the service area of the CDP.~~

6.4 URBAN WATER MANAGEMENT PLANS

The Water Authority's 2015~~0~~ UWMP contains a water supply reliability assessment that identified the verifiable mix of water resources to meet the region's existing and future demands. In addition, the UWMP incorporates the additional annual average potable water output potentially resulting from the proposed CDP modifications as an adaptive management supply

that could be used to meet projected regional growth and water demands. incorporates a traditional scenario planning process to assess the reliability of the region's future resource mix and provide options to address potential supply uncertainties. The planning process evaluated the reliability of future potential supplies while considering uncertainties such as climate change, droughts, and regulatory restrictions. The scenario planning process also identified the potential strategies, or alternative supply sources, to help manage uncertainties that resulted in any gaps between demands and supplies.

One of the scenarios (Scenario 2) included in the 2010 UWMP is a severe multi-year drought situation, where imported supplies from MWD are limited. A potential supply gap of approximately 55,000 acre-feet in 2030 was identified, where alternative sources would be needed to help meet demands. This drought scenario is currently occurring, as California enters its fourth consecutive year of drought, MWD storage supplies have been drastically reduced and there is a high likelihood of a continued MWD supply shortage for the San Diego region. In addition, the frequency and severity of drought scenarios could increase due to climate change and/or increased regulatory restrictions (San Diego County Water Authority 2011).

The 2010 UWMP scenario planning process identified the potential strategies or alternative supply sources that can assist in managing drought scenarios by helping fill the supply gap and reduce the risk of shortages. The strategies are listed in Table 10-4 of the 2010 UWMP and include a combination of member agency and Water Authority local projects. One of the Water Authority's potential strategies is to increase regional seawater desalination capacity. A potential long-term project identified is a seawater desalination project on Marine Corps Base Camp Pendleton, the feasibility of which is currently being studied. The proposed increase in capacity at the CDP could serve, if needed, as an incremental supply strategy to help manage future water supply shortages identified in the 2010 UWMP (San Diego County Water Authority 2011).

It can, therefore, be reasonably assumed that the Water Authority has contemplated, conceptually evaluated, and planned for the inclusion of additional potable water supplies sourced from seawater desalination in its long-range future planning scenarios beyond that already approved for CDP, and it can be reasonably assumed that desalinated seawater that is potentially purchased directly from the operators of the CDP could serve, if needed, as an incremental supply strategy to help fill any supply gap and reduce the risk of future water supply shortages.

It is not anticipated that any such diversification of the water supply would result in any changes to existing land use plans, growth projections or growth management policies of the local land use authorities within the respective service areas of the districts. Local water agencies purchase and deliver water to retail customers, and do not have direct authority over land use, and cannot approve or disapprove any changes in land use that would directly affect population projections.

It would require speculation beyond the scope of this SEIR to attempt to predict whether the cities within San Diego County would make changes to any of their current land use, housing or population projections, or any of their existing growth management controls based on a change in the mix of water supply sources. In addition, the availability of developable land is the primary factor in future growth potential. As previously noted, desalinated seawater is already considered in regional growth analyses conducted by SANDAG, and the proposed project would not represent water supply in excess of what is already anticipated to meet future projected needs. As such, the potential increase of approximately an annual average of 5 mgd (or up to 6 mgd daily maximum) of potable water is not considered growth-inducing.

SECTION 7

REFERENCES AND REPORT PREPARERS

7.1 REFERENCES

Air Quality

14 CCR (California Code of Regulations) 15000–15387 and Appendices A–L. Guidelines for Implementation of the California Environmental Quality Act, as amended.

CARB (California Air Resources Board). 2013. “Ambient Air Quality Standards.” <http://www.arb.ca.gov/research/aaqs/aaqs2.pdf>.

CARB. 2008. Scoping Plan http://www.arb.ca.gov/cc/scopingplan/document/adopted_scoping_plan.pdf

CARB. 2014a. “Area Designations Maps / State and National.” Updated April 17, 2014. Accessed April 24, 2014. <http://www.arb.ca.gov/desig/adm/adm.htm>.

CARB. 2014b. “iADAM: Air Quality Data Statistics.” <http://arb.ca.gov/adam>.

County of San Diego. 2007. County of San Diego Guidelines for Determining Significance and Report Format and Content Requirements – Air Quality. Land Use and Environment Group. Department of Planning and Land Use, Department of Public Works. March 19, 2007. <http://www.sandiegocounty.gov/content/dam/sdc/pds/ProjectPlanning/docs/AQ-Guidelines.pdf>.

Department of Finance. 2012. E4 – Population Estimates, 2001–2010. <http://www.dof.ca.gov/research/demographic/reports/estimates/e4/200110/view.php>.

Department of Finance. 2015. E1 – Current Population Estimates. <http://www.dof.ca.gov/research/demographic/reports/estimates/e1/view.php>.

EPA (Environmental Protection Agency). 2014. “AirData: Access to Air Pollution Data.” <http://www.epa.gov/airdata>.

SANDAG (San Diego Association of Governments). 2013. Series 13 Regional Growth Forecast – San Diego Region. October 2013.

SANDAG. 2015. San Diego Forward: The Regional Plan. October 2015. http://www.sdforward.com/pdfs/RP_final/The%20Plan%20-%20combined.pdf.

- San Diego County Water Authority. 2014. Final 2013 Regional Water Facilities Optimization and Master Plan Update. March 2014.
- SCAQMD (South Coast Air Quality Management District). 2006. Final – Methodology to Calculate PM_{2.5} and PM_{2.5} Significance Thresholds. October 2006.
[http://www.aqmd.gov/docs/default-source/ceqa/handbook/localized-significance-thresholds/particulate-matter-\(pm\)-2.5-significance-thresholds-and-calculation-methodology/final_pm2_5methodology.pdf?sfvrsn=2](http://www.aqmd.gov/docs/default-source/ceqa/handbook/localized-significance-thresholds/particulate-matter-(pm)-2.5-significance-thresholds-and-calculation-methodology/final_pm2_5methodology.pdf?sfvrsn=2).
- SDAPCD (San Diego Air Pollution Control District). 1969. Rules and Regulations. Regulation IV. Prohibitions. Rule 51. Nuisance. Effective January 1, 1969.
- SDAPCD. 1995. Regulation XV – Federal Conformity. Rule 1501 – Conformity of General Federal Actions. Adopted March 7, 1995. EPA Approval Effective June 22, 1999.
<http://www.sdapcd.org/rules/Reg15pdf/R1501.pdf>.
- SDAPCD. 1998. Rule 20.2 – New Source Review Non-Major Stationary Sources. Adopted and effective May 17, 1994; revisions adopted and effective December 17, 1997. Revisions adopted November 4, 1998; effective December 17, 1998.
- SDAPCD. 2001. Rules and Regulations. Regulation IV. Prohibitions. Rule 67.0. Architectural Coatings. Revised December 12, 2001.
- SDAPCD. 2005. Measures to Reduce Particulate Matter in San Diego County. December 2005.
<http://www.sdapcd.org/planning/PM-Measures.pdf>.
- SDAPCD. 2007. Eight-Hour Ozone Attainment Plan for San Diego County. May 2007.
<http://www.sdapcd.org/planning/8-Hour-O3-Attain-Plan.pdf>.
- SDAPCD. 2009a. 2009 Regional Air Quality Strategy Revision. April 2009.
<http://www.sdapcd.org/planning/2009-RAQS.pdf>.
- SDAPCD. 2009b. Rules and Regulations. Regulation IV. Prohibitions. Rule 55. Fugitive Dust. Adopted June 24, 2009; effective December 24, 2009.
- SDAPCD. 2012. Redesignation Request and Maintenance Plan for the 1997 National Ozone Standard for San Diego County. December 15, 2012. http://www.sdapcd.org/planning/8_Hour_O3_Maint-Plan.pdf.
- SDAPCD. 2015. SDAPCD Regulation IV: Prohibitions; Rule 67.0.1: Architectural Coatings.

Biological Resources

Philips et al. 2012. University of California, Davis, Department of Environmental Toxicology. Hyper-Salinity Toxicity Thresholds for Nine California Ocean Plan Toxicity Test Protocols. Prepared for California State Water Resources Control Board, Agreement Number 11-133-250. July 2012.

SWRCB (State Water Resources Control Board). 2015. Revisions to the State's Ocean Plan Amendment, adopted May 5, 2015.

Greenhouse Gas Emissions

14 CCR (California Code of Regulations) 15000–15387 and Appendices A–L. Guidelines for Implementation of the California Environmental Quality Act, as amended.

California Department of Water Resources. 2015. Drought Information. Water Conditions. Storms, Drought and California's Water Situation: Key Points. May 4, 2015. <http://www.water.ca.gov/waterconditions/waterconditions.cfm>.

CAPCOA (California Air Pollution Control Officers Association). 2008. CEQA & Climate Change: Evaluating and Addressing Greenhouse Gas Emissions from Projects Subject to the California Environmental Quality Act. January 2008.

CARB. 2008. Climate Change Proposed Scoping Plan: A Framework for Change. October 2008; approved December 12, 2008. <http://www.arb.ca.gov/cc/scopingplan/document/psp.pdf>.

CARB. 2014a. "California Greenhouse Gas Inventory for 2000–2012 – by Category as Defined in the 2008 Scoping Plan." March 24, 2014. http://www.arb.ca.gov/cc/inventory/data/tables/ghg_inventory_scopingplan_00-12_2014-03-24.pdf.

CARB. 2014b. First Update to the Climate Change Scoping Plan: Building on the Framework. May 2014. http://www.arb.ca.gov/cc/scopingplan/2013_update/first_update_climate_change_scoping_plan.pdf.

CAT (Climate Action Team). 2006. California Environmental Protection Agency Climate Action Team Report to Governor Schwarzenegger and the Legislature. March 2006. http://www.climatechange.ca.gov/climate_action_team/reports/2006report/2006-04-03_FINAL_CAT_REPORT.PDF.

- CAT. 2010a. Climate Action Team Report to Governor Schwarzenegger and the California Legislature. Sacramento, California: CAT. December 2010. <http://www.energy.ca.gov/2010publications/CAT-1000-2010-005/CAT-1000-2010-005.PDF>.
- CAT. 2010b. Climate Action Team Biennial Report. Sacramento, California: CAT. April 2010. <http://www.energy.ca.gov/2010publications/CAT-1000-2010-004/CAT-1000-2010-004.PDF>.
- CAT. 2015. Climate Change Research Plan for California. California Environmental Protection Agency, Climate Action Team. February 2015.
- CEC (California Energy Commission). 2012a. Coastal Flooding Potential Projections: 2000–2100. A White Paper from the California Energy Commission’s California Climate Change Center. July 2012. <http://www.energy.ca.gov/2012publications/CEC-500-2012-011/CEC-500-2012-011.pdf>.
- CEC. 2012b. “New Title 24 Standards Will Cut Residential Energy Use by 25 Percent, Save Water, and Reduce Greenhouse Gas Emissions.” Released July 1, 2014. http://www.energy.ca.gov/releases/2014_releases/2014-07-01_new_title24_standards_nr.html.
- City of Carlsbad. 2015. City of Carlsbad Climate Action Plan. September 2015. <http://www.carlsbadca.gov/civicax/filebank/blobdload.aspx?BlobID=29361>.
- CNRA (California Natural Resources Agency). 2009. 2009 California Climate Adaptation Strategy. <http://www.energy.ca.gov/2010publications/CNRA-1000-2010-010/CNRA-1000-2010-010>.
- County of San Diego. 2015. 2015 GHG Guidance: Recommended Approach to Addressing Climate Change in CEQA Documents. Department of Planning and Development Services. January 21, 2015. <http://www.sandiegocounty.gov/content/dam/sdc/pds/ProjectPlanning/docs/PDS2015GHG%20Guidance%20-1-21-15.pdf>.
- EPA (U.S. Environmental Protection Agency). 2010. EPA and NHTSA Finalize Historic National Program to Reduce Greenhouse Gases and Improve Fuel Economy for Cars and Trucks. Regulatory Announcement. Office of Transportation and Air Quality. EPA-420-F-10-014. April. <http://www.epa.gov/oms/climate/regulations/420f10014.pdf>.

EPA. 2011. Final Rulemaking: Light-Duty Vehicle Greenhouse Gas Emissions Standards and Corporate Average Fuel Economy Standards. Regulations and Standards–Vehicles and Engines. Last updated February 2011. <http://www.epa.gov/otaq/climate/regulations.htm>.

EPA. 2014. “Inventory of U.S. Greenhouse Gas Emissions and Sinks: 1990-2012.” April 15, 2014. <http://www.epa.gov/climatechange/ghgemissions/usinventoryreport.html>.

IPCC (Intergovernmental Panel on Climate Change). 2014. Climate Change 2014: Impacts, Adaptation, and Vulnerability – Summary for Policymakers. http://www.ipcc.ch/pdf/assessment-report/ar5/wg2/ar5_wgII_spm_en.pdf.

National Climatic Data Center. 2014. Climate Change Impacts in the United States. U.S. National Climate Assessment. U.S. Global Change Research Program. http://s3.amazonaws.com/nca2014/low/NCA3_Climate_Change_Impacts_in_the_United%20States_LowRes.pdf?download=1.

OPR (Office of Planning and Research). 2008. Technical Advisory – CEQA and Climate Change: Addressing Climate Change through California Environmental Quality Act (CEQA) Review.

SDG&E (San Diego Gas & Electric). 2015. Personal communication between Graham Beatty of Poseidon Resources and Kazeem Omidiji of SDG&E. November 11, 2015.

Hydrology and Water Quality

Cal EMA (California Emergency Management Agency). 2009. Tsunami Inundation Map for Emergency Planning – Oceanside Quadrangle/San Luis Rey Quadrangle. June 1, 2009. http://www.conservation.ca.gov/cgs/geologic_hazards/Tsunami/Inundation_Maps/SanDiego/Documents/Tsunami_Inundation_OceansideSanLuisRey_Quads_SanDiego.pdf.

CCC (California Coastal Commission). 2015. Sea Level Rise Guidance Policy. August 2015.

City of Carlsbad. 2015. City of Carlsbad Zoning Map. Updated November 2015. <http://www.carlsbadca.gov/civicax/filebank/blobdload.aspx?BlobID=24153>.

SWRCB (State Water Resources Control Board). 2015. Ocean Standards – Desalination Facilities and Brine Disposal. Updated November 5, 2015. http://www.swrcb.ca.gov/water_issues/programs/ocean/desalination/.

Land Use/Planning

- City of Carlsbad. 1986. Chapter 21.90 of the Carlsbad Municipal Code, Growth Management. Adopted in 1986. http://www.qcode.us/codes/carlsbad/?view=desktop&topic=21-21_90.
- City of Carlsbad. 1988. Scenic Corridor Guidelines. Adopted in 1988.
- City of Carlsbad. 1996. Local Coastal Program (LCP). Adopted in 1996.
- City of Carlsbad. 2000. South Carlsbad Coastal Redevelopment Plan (SCCRP). Adopted in 2000.
- City of Carlsbad. 2015. City of Carlsbad General Plan. Updated September 22, 2015. <http://www.carlsbadca.gov/services/depts/planning/general.asp>.

Energy

- CARB (California Air Resources Board). 2013. “Ambient Air Quality Standards.” <http://www.arb.ca.gov/research/aaqs/aaqs2.pdf>.
- CEC (California Energy Commission). 2000. *California Energy Demand 2000–2010*. Staff Report. Technical Report to California Energy Outlook 2000. Docket No. 99-CEO-1. June 2000. http://www.energy.ca.gov/reports/2000-07-14_200-00-002.PDF.
- CEC. 2013a. *Preliminary California Energy Demand Forecast 2014–2024*. Draft staff report. May 2013. Accessed August 6, 2014. <http://www.energy.ca.gov/2013publications/CEC-200-2013-004/CEC-200-2013-004-SD-V2.pdf>.
- CEC. 2013b. *2013 Integrated Energy Policy Report*. May 2013. Accessed August 6, 2014. http://www.energy.ca.gov/2013_energypolicy/.
- City of Carlsbad. 2015. City of Carlsbad Climate Action Plan. September 2015. <http://www.carlsbadca.gov/civicax/filebank/blobdload.aspx?BlobID=29361>.
- EIA (U.S. Energy Information Administration). 2012. State Energy Data 2012: Consumption. Table C10. Energy Consumption by End-Use Section, Ranked by State, 2012.
- EIA. 2014a. “California State Profile and Energy Estimates. Profile Analysis.” Last updated June 19, 2014. Accessed August 6, 2014. <http://www.eia.gov/state/analysis.cfm?sid=ca>.
- EIA. 2014b. “Natural Gas Consumption by End Use” and “Natural Gas Delivered to Consumers in California (Including Vehicle Fuel).” Accessed August 6, 2014.

EPA (U.S. Environmental Protection Agency). 2013. “Fuels and Fuel Additives: Renewable Fuel Standard (RFS).” Last updated December 10, 2013. Accessed August 14, 2014. <http://www.epa.gov/renewable-fuel-standard-program>.

Growth Inducing-Impacts

Department of Finance. 2012. E4 – Population Estimates, 2001–2010. <http://www.dof.ca.gov/research/demographic/reports/estimates/e4/200110/view.php>.

Department of Finance. 2015. E1 – Current Population Estimates. <http://www.dof.ca.gov/research/demographic/reports/estimates/e1/view.php>.

SANDAG (San Diego Association of Governments). 2013. Series 13 Regional Growth Forecast – San Diego Region. October 2013.

SANDAG. 2015. San Diego Forward: The Regional Plan. October 2015. http://www.sdforward.com/pdfs/RP_final/The%20Plan%20-%20combined.pdf.

San Diego County Water Authority. 2003. Regional Water Facilities Master Plan Final Program Environmental Impact Report. November 2003. <http://www.sdcwa.org/rwfmp-peir>.

San Diego County Water Authority. 2011. 2010 Urban Water Management Plan. June 2011.

San Diego County Water Authority. 2014. Final 2013 Regional Water Facilities Optimization and Master Plan Update. March 2014.

San Diego County Water Authority. 2015a. Local Rainfall and Reservoirs. September 2015.

San Diego County Water Authority. 2015b. Recycled Water – A Locally Developed Water Supply. September 2015.

7.2 REPORT PREPARERS

Joe Monaco, Environmental Division Manager
Matt Valerio, Senior Project Manager
Austin Melcher, Environmental Planner/Specialist
Andrew Talbert, Environmental Analyst

INTENTIONALLY LEFT BLANK

APPENDIX S-A

Initial Study

Initial Study for the Carlsbad Seawater Desalination Plant Intake and Discharge Facility Modifications

Prepared for:

San Diego County Water Authority

4677 Overland Avenue

San Diego, CA 92123

Contact: Larry Purcell

Prepared by:

DUDEK

605 Third Street

Encinitas, California 92024

Contact: Joe Monaco

SEPTEMBER 2015

Initial Study for the Carlsbad Seawater Desalination Plant Intake and Discharge Facility Modifications

TABLE OF CONTENTS

<u>Section</u>	<u>Page No.</u>
1 INTRODUCTION.....	1
1.1 Project Overview	1
1.2 California Environmental Quality Act Compliance	2
1.3 Public Review Process	2
2 SUMMARY OF FINDINGS	2
3 INITIAL STUDY CHECKLIST	3
3.1 Aesthetics	19
3.2 Agriculture and Forestry Resources.....	22
3.3 Air Quality	23
3.4 Biological Resources	28
3.5 Cultural Resources	33
3.6 Geology and Soils	35
3.7 Greenhouse Gas Emissions.....	40
3.8 Hazards and Hazardous Materials	41
3.9 Hydrology and Water Quality.....	45
3.10 Land Use and Planning	50
3.11 Mineral Resources	52
3.12 Noise	53
3.13 Population and Housing.....	58
3.14 Public Services.....	60
3.15 Recreation	62
3.16 Transportation and Traffic	63
3.17 Utilities and Service Systems.....	66
3.18 Mandatory Findings of Significance.....	70
4 REFERENCES.....	72
4.1 References Cited	72

FIGURES

Figure 1	Vicinity Map	75
Figure 2	Site Layout	77

Initial Study for the Carlsbad Seawater Desalination Plant Intake and Discharge Facility Modifications

TABLE OF CONTENTS (CONTINUED)

Page No.

TABLES

Table 1 San Diego Air Pollution Control District Air Quality Significance Thresholds25
Table 2 Construction Equipment Noise Emission Levels56

Initial Study for the Carlsbad Seawater Desalination Plant Intake and Discharge Facility Modifications

1 INTRODUCTION

1.1 Project Overview

The San Diego County Water Authority (Water Authority) is the Lead Agency under the California Environmental Quality Act (CEQA) for preparation of a Supplement to the EIR for the Precise Development Plan and Desalination Plant Project to address changes related to intake and discharge facility modifications. Poseidon Water (Poseidon) is the owner/operator of the Carlsbad Desalination Plant (CDP) under contract to the Water Authority to deliver between 48,000 and 56,000 acre-feet per year (AFY) of drinking water from the CDP. On May 5, 2014, Cabrillo Power I LLC (Cabrillo) provided notice that the Encina Power Station (EPS), and the associated seawater intake pump, is scheduled to be permanently shut down on June 1, 2017. This will result in the need for the CDP to directly withdraw seawater from the Agua Hedionda Lagoon for the desalination plant, rather than making use of the discharged cooling waters from the EPS. The project modifications are intended to comply with the requirements of Water Code section 13142.5(b), when the EPS permanently shuts down.

Certain modifications to the CDP intake and discharge facilities are required to allow the CDP to operate independent of the EPS. In addition, since the CDP approvals, the efficiency of reverse osmosis membrane technology has improved. These advances enable the CDP to increase the average daily potable water output from approximately 50 million gallons per day (MGD) to approximately 60 MGD with minimal improvements to the plant. No other components or operational aspects associated with the CDP would be altered as part of the changes to the intake and discharge facilities.

The CDP is located in the City of Carlsbad (City) adjacent to the Agua Hedionda Lagoon and immediately east of Carlsbad Boulevard, in close proximity to the Pacific Ocean. The CDP is co-located with the operational EPS, which has been operating at the location since 1952. The site is designated as “U” Public Utilities in the Carlsbad General Plan, and zoned by the City as “P-U” Public Utility.

Initial Study for the Carlsbad Seawater Desalination Plant Intake and Discharge Facility Modifications

1.2 California Environmental Quality Act Compliance

This Initial Study was prepared in accordance with CEQA Guidelines Section 15063 and Appendix G.

1.3 Public Review Process

A Notice of Preparation (NOP) will be circulated in accordance with CEQA Guidelines Section 15082 for a period of 30 days starting September 18, 2015 and ending October 29, 2015. Additionally, in accordance with CEQA Guidelines sections 15082 and 15206, the Water Authority will hold a public scoping meeting on October 1, 2015 at 1635 Faraday Avenue, Carlsbad, CA 92008. The Supplement to the EIR will be made available to the public for review in accordance with CEQA Guidelines Section 15087.2.

2 SUMMARY OF FINDINGS

This Initial Study identified that the proposed project modifications to intake and discharge facilities would not result in greater impacts or increased severity of impacts than those identified in the previously certified Final EIR (FEIR), as amended. The need to modify the intake and discharge facilities is triggered by the EPS decommissioning timeline occurring sooner than anticipated in the FEIR. The modifications would affect only a small portion or component of the previously approved project and require only minor revisions to make the previously certified FEIR adequate to address the proposed project changes. The changes would not result in the level or severity of impacts changing, though the specific location for impacts would change. The Water Authority has determined that a Supplement to an EIR is appropriate.

Initial Study for the Carlsbad Seawater Desalination Plant Intake and Discharge Facility Modifications

3 INITIAL STUDY CHECKLIST

1. Project title:

Carlsbad Seawater Desalination Plant Intake and Discharge Facility Modifications

2. Lead agency name and address:

San Diego County Water Authority

3. Contact person and phone number:

Laurence J. Purcell

4. Project location:

4600 Carlsbad Boulevard, Carlsbad, CA 92008

5. Project sponsor's name and address:

Poseidon Water, 5780 Fleet Street, Suite 140, Carlsbad, CA 92008

6. General plan designation:

U Public Utility

7. Zoning:

P-U Public Utility

8. Description of project. (Describe the whole action involved, including but not limited to later phases of the project, and any secondary, support, or off-site features necessary for its implementation. Attach additional sheets if necessary):

Introduction

On June 13, 2006, the City of Carlsbad approved an amendment to the Precise Development Plan (PDP) for the Encina Power Station (EPS) and certified the Carlsbad Precise Development Plan and Desalination Plant Final Environmental Impact Report (FEIR) for the Carlsbad Desalination Project. These actions provided the approvals to construct and operate an approximately 50 MGD desalination plant and other appurtenant and ancillary water and support

Initial Study for the Carlsbad Seawater Desalination Plant Intake and Discharge Facility Modifications

facilities to produce potable water. The PDP application was made jointly between Poseidon Resources (Channelside) LLC (Poseidon) and Cabrillo Power I LLC (Cabrillo), a subsidiary of NRG Energy, which owns and operates the EPS. The Carlsbad Desalination Plant (CDP) is located on the EPS site, adjacent to the existing power plant, located immediately south of the Agua Hedionda Lagoon, within the City of Carlsbad, in northern San Diego County.

The project was subsequently modified, and these modifications were addressed in four separate Addenda to the FEIR that was prepared for the project. The First Addendum to the FEIR was approved by the City of Carlsbad on September 15, 2009. The First Addendum documented changes to the footprint of the desalination plant and off-site water conveyance facilities. The San Diego County Water Authority (Water Authority) prepared and approved a Second Addendum for the Carlsbad Desalination Project on November 29, 2012. The Second Addendum documented changes to the footprint associated with the Twin Oaks Valley Water Treatment Plant modifications, Pipeline 3 relining, aqueduct connection point modifications, Pipeline 4 modifications, and the Macario Canyon pipeline alignment modification and pumping well. The Third Addendum was approved by the Water Authority on September 26, 2013 for minor changes to the Macario Canyon pipeline alignment. The Third Addendum addressed ancillary facilities of 2 to 4 feet above ground on Faraday Avenue in Carlsbad. The Fourth Addendum, approved by the Water Authority on July 9, 2014, documented changes to the design and layout of above and below ground structures at the aqueduct connection point in the City of San Marcos.

The closure of the EPS necessitates the proposed modifications to the Intake/Discharge Facility to allow the continued provision of feedwater to the CDP. The Intake/Discharge modifications would include the travelling screens, fish friendly low impact pumps, and a fish return system. It would be constructed southwest of the existing intake pump station and adjacent to the existing intake forebay (see Figure 1).

In addition, since the CDP approvals, the efficiency of reverse osmosis membrane technology has improved. These advances enable the CDP to increase the average daily potable water output from approximately 50 MGD to approximately 60 MGD with minimal improvements to the plant. Improvements would include installing reverse osmosis membranes into existing housing, and an additional skid, piping, pressure exchangers, booster pumps and other related accessories.

In issuing the NPDES permit for the CDP, the Regional Water Quality Control Board (RWQCB) determined that no adverse effects on marine organisms would occur with average salinity concentrations in the discharge pond of 42 ppt (a 5:1 dilution ratio) or less. Upon further mixing at the point of discharge in the high-energy surf zone, the receiving water salinity concentrations

Initial Study for the Carlsbad Seawater Desalination Plant Intake and Discharge Facility Modifications

outside the zone of initial dilution (1,000 foot radius from the end of the discharge channel) will be 35 ppt or less (a 20:1 dilution ratio).

Background

On January 14, 2014, the City of Carlsbad, NRG Energy and San Diego Gas & Electric Company entered into an agreement to decommission the EPS, and to replace the existing plant with a new “peaker” plant, that would provide approximately 600 megawatts of electricity. The proposed simple-cycle plant would also require amendment to NRG’s Carlsbad Energy Center Project, which was approved by the California Energy Commission as a combined-cycle natural gas-fired power plant that was to be operated in conjunction with Units 4 and 5 of the EPS. The new project would replace all generating units of the EPS, resulting in the permanent shut down of the EPS once-through seawater cooling system and associated intake pumps.

Project Description

Process Overview

Cabrillo provided notice on May 5, 2014 that a permanent shutdown of the EPS seawater cooling system, including the intake, would occur on June 1, 2017. This will require the CDP to transition to “stand-alone” operation of the seawater intake by making changes to the previously approved CDP seawater intake and discharge facilities (Proposed Project).

As shown in Figure 2, Site Layout , seawater would enter the existing intake tunnels from the outer basin of the Agua Hedionda Lagoon into a new Intake/Discharge Structure. The intake water would pass through a series of traveling screens equipped with a fish capture and return system and directed either to the CDP as feedwater to be treated and made available as potable water to local supplies, or to the discharge channel to be used as dilution water. The screens are designed to eliminate impingement mortality and reduce entrainment mortality through the use of 1-millimeter (mm) slot openings, and a through-screen velocity of less than 0.5 feet per second.

After screening, the existing intake pump station will continue to deliver about half of the seawater volume drawn through the intake tunnels to the CDP for processing through the pre-treatment and reverse osmosis membrane desalination system. Approximately half the feedwater volume processed by the CDP will leave the CDP as potable drinking water, and the other half will be concentrated seawater with about twice the original feedwater salinity.

The remaining half of the seawater volume drawn into the new Intake/Discharge Structure would be for initial dilution of the CDP concentrated seawater prior to discharge to the Pacific Ocean.

Initial Study for the Carlsbad Seawater Desalination Plant Intake and Discharge Facility Modifications

The dilution water (and any entrained marine life) would be transferred to the discharge channel using fish friendly low impact pumps that have been demonstrated to minimize entrainment mortality. Consistent with existing CDP operation, the concentrated seawater byproduct of the desalination process would be returned to the discharge channel and mixed with the dilution water to reduce salinity in the discharge to a level that has been demonstrated to eliminate toxicity in the receiving water.

The new Intake/Discharge Structure would house the screens, the fish friendly low impact pumps and the fish return system. It would be constructed southwest of the existing intake pump station and adjacent to the existing intake forebay. This structure and an associated electrical building would occupy approximately 8,000 square feet, at an elevation of approximately 2 and 12 feet above grade, respectively.

The efficiency of reverse osmosis membrane technology has improved such that the CDP can increase the average daily potable water output from approximately 50 MGD to approximately 60 MGD with minimal improvements to the plant. Improvements would include installing reverse osmosis membranes into existing housing, and an additional skid, piping, pressure exchangers, booster pumps and other related accessories.

It is important to note that the CDP will be in operation prior to the shutdown of the EPS intake pumps. Therefore, the focus of the Supplemental to the EIR will be the reconfiguration of the CDP intake and discharge facilities in a manner and on a schedule that maintains continuous CDP operation.

9. Surrounding land uses and setting (Briefly describe the project's surroundings):

Land uses surrounding the CDP area include residential and active and passive recreational uses such as swimming, surfing, walking, bird watching, fishing, and aquaculture facility to the north; residential, commercial and industrial uses to the south; Interstate Freeway 5 and NCTD railroad tracks to the east; and beyond that open space and agriculture, and the Pacific Ocean to the west. As noted above, the NCTD railroad tracks bisect the PDP area. Also to the north, adjacent to the outer lagoon is the Hubbs-Seaworld Research Institute and fish hatchery. This facility has been in operation since 1995, and includes a 22,000-square-foot hatchery which is contributing to the restoration of the California white sea bass population through aquaculture and fishery enhancement.

Agua Hedionda Lagoon is one of three coastal lagoons within the City of Carlsbad and is located in the west-central portion of the City. The lagoon is managed by the Agua Hedionda Lagoon Foundation and comprises approximately 230 acres of water surface and extends 1.7 miles inland

Initial Study for the Carlsbad Seawater Desalination Plant Intake and Discharge Facility Modifications

from the coast. At its widest point, the lagoon is 0.5 mile wide. Agua Hedionda Creek enters the lagoon at its easternmost point. The area surrounding the lagoon is characterized by open areas along the northern and southern shorelines with residential development occurring on the bluffs above the lagoon to the north. Active agricultural fields occupy a portion of the slopes along the southern shoreline. The middle and inner lagoons are leased to the City as an aquatic-oriented recreational area. The middle lagoon has a recreation facility that is used by the YMCA for water sports and overnight camp groups. The inner lagoon is used for water sports, such as boating and jet skiing, and is administered by the City of Carlsbad, which issues recreational use permits and collects fees.

South of the power plant area is the SDG&E Operations Center and Cannon Park. Single-family residential neighborhoods are located generally south of Cannon Road, and west of Carlsbad Boulevard. The neighborhood west of Carlsbad Boulevard is referred to as the Terra Mar subdivision. North and south of Cannon Road between the NCTD Railroad right-of-way and Interstate 5 are commercially and industrially zoned areas.

To the west of power plant across Carlsbad Boulevard, which forms the western boundary of the power plant, is the Pacific Ocean and the southern end of Carlsbad State Beach. Interstate 5 forms the eastern boundary of the EPS site.

10. Other public agencies whose approval is required (e.g., permits, financing approval, or participation agreement):

Approvals and/or amendments to approvals would be necessary from agencies including, but not limited to, the following:

USACE - 404 Permit (NWP)

California Coastal Commission – CDP Amendment

CDFW – Streambed Alteration Agreement

RWCB – NPDES and 401 Permit

City of Carlsbad

- Approval of Amendment to the Encina Power Station Precise Development Plan;
- An Amendment to the Encina Specific Plan No. 144 to incorporate the PDP into the specific plan;

Initial Study for the Carlsbad Seawater Desalination Plant Intake and Discharge Facility Modifications

- A Development Agreement Amendment
- Approval of Amended Improvement Plans
- Easements/Acquisition of Right-of-Way
- Grading Permit Amendment
- Water Purchase Agreement Amendment
- Redevelopment Permit Amendment

ENVIRONMENTAL FACTORS POTENTIALLY AFFECTED

The environmental factors checked below would be potentially affected by the proposed modifications to this project, additionally factors may be checked below to ensure disclosure of changes to associated planning or environmental documents and/or regulations, as indicated by the checklist on the following pages.

- | | | |
|--|---|--|
| <input type="checkbox"/> Aesthetics | <input type="checkbox"/> Agriculture and Forestry Resources | <input checked="" type="checkbox"/> Air Quality |
| <input checked="" type="checkbox"/> Biological Resources | <input type="checkbox"/> Cultural Resources | <input type="checkbox"/> Geology and Soils |
| <input checked="" type="checkbox"/> Greenhouse Gas Emissions | <input type="checkbox"/> Hazards and Hazardous Materials | <input checked="" type="checkbox"/> Hydrology and Water Quality |
| <input checked="" type="checkbox"/> Land Use and Planning | <input type="checkbox"/> Mineral Resources | <input type="checkbox"/> Noise |
| <input checked="" type="checkbox"/> Population and Housing | <input type="checkbox"/> Public Services | <input type="checkbox"/> Recreation |
| <input type="checkbox"/> Transportation and Traffic | <input type="checkbox"/> Utilities and Service Systems | <input checked="" type="checkbox"/> Mandatory Findings of Significance |

Initial Study for the Carlsbad Seawater Desalination Plant Intake and Discharge Facility Modifications

DETERMINATION: (To be completed by the Lead Agency)

On the basis of this initial evaluation:

- I find that the proposed project modifications COULD NOT have a significant effect on the environment, and a NEGATIVE DECLARATION will be prepared.
- I find that although the proposed project modifications could have a significant effect on the environment, there will not be a significant effect in this case because revisions in the project have been made by or agreed to by the project proponent. A MITIGATED NEGATIVE DECLARATION will be prepared.
- I find that the proposed project modifications MAY have a significant effect on the environment, and an ENVIRONMENTAL IMPACT REPORT is required.
- I find that the proposed project modifications MAY have a “potentially significant impact” or “potentially significant unless mitigated” impact on the environment, but at least one effect (1) has been adequately analyzed in an earlier document pursuant to applicable legal standards, and (2) has been addressed by mitigation measures based on the earlier analysis as described on attached sheets. An ENVIRONMENTAL IMPACT REPORT is required, but it must analyze only the effects that remain to be addressed.
- I find that although the proposed project modifications could have a significant effect on the environment, because all potentially significant effects (a) have been analyzed adequately in an earlier ENVIRONMENTAL IMPACT REPORT or NEGATIVE DECLARATION pursuant to applicable standards, and (b) have been avoided or mitigated pursuant to that earlier ENVIRONMENTAL IMPACT REPORT or NEGATIVE DECLARATION, including revisions or mitigation measures that are imposed upon the proposed project, nothing further is required.
- I find that the proposed project modifications evaluated in a prior certified ENVIRONMENTAL IMPACT REPORT would result in new or substantially more severe significant effects and major revisions to that ENVIRONMENTAL IMPACT REPORT are necessary, and a SUBSEQUENT ENVIRONMENTAL IMPACT REPORT will be prepared.
- I find that the proposed project modifications evaluated in a prior certified ENVIRONMENTAL IMPACT REPORT would not result in new or substantially more severe significant effects and only minor revisions to that ENVIRONMENTAL IMPACT REPORT are necessary, and a SUPPLEMENT to the ENVIRONMENTAL IMPACT REPORT will be prepared.

Robert R. Yamada
Director of Water Resources

Date

Initial Study for the Carlsbad Seawater Desalination Plant Intake and Discharge Facility Modifications

EVALUATION OF ENVIRONMENTAL IMPACTS:

- 1) A brief explanation is required for all answers except “No Impact” answers that are adequately supported by the information sources a lead agency cites in the parentheses following each question. A “No Impact” answer is adequately supported if the referenced information sources show that the impact simply does not apply to projects like the one involved (e.g., the project falls outside a fault rupture zone). A “No Impact” answer should be explained where it is based on project-specific factors as well as general standards (e.g., the project will not expose sensitive receptors to pollutants, based on a project-specific screening analysis).
- 2) All answers must take account of the whole action involved, including off-site as well as on-site, cumulative as well as project-level, indirect as well as direct, and construction as well as operational impacts.
- 3) Once the lead agency has determined that a particular physical impact may occur, then the checklist answers must indicate whether the impact is potentially significant, less than significant with mitigation, or less than significant. “Potentially Significant Impact” is appropriate if there is substantial evidence that an effect may be significant. If there are one or more “Potentially Significant Impact” entries when the determination is made, an Environmental Impact Report (EIR) is required.
- 4) “Negative Declaration: Less Than Significant With Mitigation Incorporated” applies where the incorporation of mitigation measures has reduced an effect from “Potentially Significant Impact” to a “Less Than Significant Impact.” The lead agency must describe the mitigation measures, and briefly explain how they reduce the effect to a less than significant level (mitigation measures from “Earlier Analyses,” as described in (5) below, may be cross-referenced).
- 5) Earlier analyses may be used where, pursuant to the tiering, program EIR, or other CEQA process, an effect has been adequately analyzed in an earlier EIR or negative declaration. Section 15063(c)(3)(D). In this case, a brief discussion should identify the following:
 - a) Earlier Analysis Used. Identify and state where they are available for review.
 - b) Impacts Adequately Addressed. Identify which effects from the above checklist were within the scope of and adequately analyzed in an earlier document pursuant to applicable legal standards, and state whether such effects were addressed by mitigation measures based on the earlier analysis.
 - c) Mitigation Measures. For effects that are “Less than Significant with Mitigation Measures Incorporated,” describe the mitigation measures which were

Initial Study for the Carlsbad Seawater Desalination Plant Intake and Discharge Facility Modifications

incorporated or refined from the earlier document and the extent to which they address site-specific conditions for the project.

- 6) Lead agencies are encouraged to incorporate into the checklist references to information sources for potential impacts (e.g., general plans, zoning ordinances). Reference to a previously prepared or outside document should, where appropriate, include a reference to the page or pages where the statement is substantiated.
- 7) Supporting Information Sources: A source list should be attached, and other sources used or individuals contacted should be cited in the discussion.
- 8) This is only a suggested form, and lead agencies are free to use different formats; however, lead agencies should normally address the questions from this checklist that are relevant to a project’s environmental effects in whatever format is selected.
- 9) The explanation of each issue should identify:
 - a) The significance criteria or threshold, if any, used to evaluate each question; and
 - b) The mitigation measure identified, if any, to reduce the impact to less than significance

	Potentially Significant Impact	Less Than Significant with Mitigation Incorporated	Less Than Significant Impact	No Impact
I. AESTHETICS – Would the project:				
a) Have a substantial adverse effect on a scenic vista?	<input type="checkbox"/>	<input type="checkbox"/>	<input checked="" type="checkbox"/>	<input type="checkbox"/>
b) Substantially damage scenic resources including, but not limited to, trees, rock outcroppings, and historic buildings within a state scenic highway?	<input type="checkbox"/>	<input type="checkbox"/>	<input checked="" type="checkbox"/>	<input type="checkbox"/>
c) Substantially degrade the existing visual character or quality of the site and its surroundings?	<input type="checkbox"/>	<input type="checkbox"/>	<input checked="" type="checkbox"/>	<input type="checkbox"/>
d) Create a new source of substantial light or glare which would adversely affect day or nighttime views in the area?	<input type="checkbox"/>	<input type="checkbox"/>	<input checked="" type="checkbox"/>	<input type="checkbox"/>
II. AGRICULTURE AND FORESTRY RESOURCES – In determining whether impacts to agricultural resources are significant environmental effects, lead agencies may refer to the California Agricultural Land Evaluation and Site Assessment Model (1997) prepared by the California Department of Conservation as an optional model to use in assessing impacts on agriculture and farmland. In determining whether impacts to forest resources, including timberland, are significant environmental effects, lead agencies may refer to information compiled by the California Department of Forestry and Fire Protection regarding the state’s inventory of forest land, including the Forest and Range Assessment Project and the Forest Legacy Assessment project; and forest carbon measurement methodology provided in Forest Protocols adopted by the California Air Resources Board. Would the project:				
a) Convert Prime Farmland, Unique Farmland, or Farmland of Statewide Importance (Farmland), as shown on the maps prepared pursuant to the Farmland Mapping and Monitoring Program of the California Resources Agency, to non-agricultural use?	<input type="checkbox"/>	<input type="checkbox"/>	<input type="checkbox"/>	<input checked="" type="checkbox"/>

Initial Study for the Carlsbad Seawater Desalination Plant Intake and Discharge Facility Modifications

	Potentially Significant Impact	Less Than Significant with Mitigation Incorporated	Less Than Significant Impact	No Impact
b) Conflict with existing zoning for agricultural use, or a Williamson Act contract?	<input type="checkbox"/>	<input type="checkbox"/>	<input type="checkbox"/>	<input checked="" type="checkbox"/>
c) Conflict with existing zoning for, or cause rezoning of, forest land (as defined in Public Resources Code section 12220(g)), timberland (as defined by Public Resources Code section 4526), or timberland zoned Timberland Production (as defined by Government Code section 51104(g))?	<input type="checkbox"/>	<input type="checkbox"/>	<input type="checkbox"/>	<input checked="" type="checkbox"/>
d) Result in the loss of forest land or conversion of forest land to non-forest use?	<input type="checkbox"/>	<input type="checkbox"/>	<input type="checkbox"/>	<input checked="" type="checkbox"/>
e) Involve other changes in the existing environment which, due to their location or nature, could result in conversion of Farmland, to non-agricultural use or conversion of forest land to non-forest use?	<input type="checkbox"/>	<input type="checkbox"/>	<input type="checkbox"/>	<input checked="" type="checkbox"/>
III. AIR QUALITY – Where available, the significance criteria established by the applicable air quality management or air pollution control district may be relied upon to make the following determinations. Would the project:				
a) Conflict with or obstruct implementation of the applicable air quality plan?	<input type="checkbox"/>	<input type="checkbox"/>	<input checked="" type="checkbox"/>	<input type="checkbox"/>
b) Violate any air quality standard or contribute substantially to an existing or projected air quality violation?	<input type="checkbox"/>	<input checked="" type="checkbox"/>	<input type="checkbox"/>	<input type="checkbox"/>
c) Result in a cumulatively considerable net increase of any criteria pollutant for which the project region is non-attainment under an applicable federal or state ambient air quality standard (including releasing emissions which exceed quantitative thresholds for ozone precursors)?	<input type="checkbox"/>	<input checked="" type="checkbox"/>	<input type="checkbox"/>	<input type="checkbox"/>
d) Expose sensitive receptors to substantial pollutant concentrations?	<input type="checkbox"/>	<input type="checkbox"/>	<input checked="" type="checkbox"/>	<input type="checkbox"/>
e) Create objectionable odors affecting a substantial number of people?	<input type="checkbox"/>	<input type="checkbox"/>	<input checked="" type="checkbox"/>	<input type="checkbox"/>
IV. BIOLOGICAL RESOURCES – Would the project:				
a) Have a substantial adverse effect, either directly or through habitat modifications, on any species identified as a candidate, sensitive, or special status species in local or regional plans, policies, or regulations, or by the California Department of Fish and Game or U.S. Fish and Wildlife Service?	<input type="checkbox"/>	<input type="checkbox"/>	<input checked="" type="checkbox"/>	<input type="checkbox"/>
b) Have a substantial adverse effect on any riparian habitat or other sensitive natural community identified in local or regional plans, policies, regulations, or by the California Department of Fish and Game or U.S. Fish and Wildlife Service?	<input type="checkbox"/>	<input checked="" type="checkbox"/>	<input type="checkbox"/>	<input type="checkbox"/>

Initial Study for the Carlsbad Seawater Desalination Plant Intake and Discharge Facility Modifications

	Potentially Significant Impact	Less Than Significant with Mitigation Incorporated	Less Than Significant Impact	No Impact
c) Have a substantial adverse effect on federally protected wetlands as defined by Section 404 of the Clean Water Act (including, but not limited to, marsh, vernal pool, coastal, etc.) through direct removal, filling, hydrological interruption, or other means?	<input type="checkbox"/>	<input checked="" type="checkbox"/>	<input type="checkbox"/>	<input type="checkbox"/>
d) Interfere substantially with the movement of any native resident or migratory fish or wildlife species or with established native resident or migratory wildlife corridors, or impede the use of native wildlife nursery sites?	<input type="checkbox"/>	<input type="checkbox"/>	<input checked="" type="checkbox"/>	<input type="checkbox"/>
e) Conflict with any local policies or ordinances protecting biological resources, such as a tree preservation policy or ordinance?	<input type="checkbox"/>	<input type="checkbox"/>	<input checked="" type="checkbox"/>	<input type="checkbox"/>
f) Conflict with the provisions of an adopted Habitat Conservation Plan, Natural Community Conservation Plan, or other approved local, regional, or state habitat conservation plan?	<input type="checkbox"/>	<input type="checkbox"/>	<input checked="" type="checkbox"/>	<input type="checkbox"/>
V. CULTURAL RESOURCES – Would the project:				
a) Cause a substantial adverse change in the significance of a historical resource as defined in §15064.5?	<input type="checkbox"/>	<input type="checkbox"/>	<input checked="" type="checkbox"/>	<input type="checkbox"/>
b) Cause a substantial adverse change in the significance of an archaeological resource pursuant to §15064.5?	<input type="checkbox"/>	<input checked="" type="checkbox"/>	<input type="checkbox"/>	<input type="checkbox"/>
c) Directly or indirectly destroy a unique paleontological resource or site or unique geologic feature?	<input type="checkbox"/>	<input checked="" type="checkbox"/>	<input type="checkbox"/>	<input type="checkbox"/>
d) Disturb any human remains, including those interred outside of formal cemeteries?	<input type="checkbox"/>	<input checked="" type="checkbox"/>	<input type="checkbox"/>	<input type="checkbox"/>
VI. GEOLOGY AND SOILS – Would the project:				
a) Expose people or structures to potential substantial adverse effects, including the risk of loss, injury, or death involving:				
i) Rupture of a known earthquake fault, as delineated on the most recent Alquist-Priolo Earthquake Fault Zoning Map issued by the State Geologist for the area or based on other substantial evidence of a known fault? Refer to Division of Mines and Geology Special Publication 42.	<input type="checkbox"/>	<input type="checkbox"/>	<input checked="" type="checkbox"/>	<input type="checkbox"/>
ii) Strong seismic ground shaking?	<input type="checkbox"/>	<input type="checkbox"/>	<input checked="" type="checkbox"/>	<input type="checkbox"/>
iii) Seismic-related ground failure, including liquefaction?	<input type="checkbox"/>	<input type="checkbox"/>	<input checked="" type="checkbox"/>	<input type="checkbox"/>
iv) Landslides?	<input type="checkbox"/>	<input type="checkbox"/>	<input checked="" type="checkbox"/>	<input type="checkbox"/>

Initial Study for the Carlsbad Seawater Desalination Plant Intake and Discharge Facility Modifications

	Potentially Significant Impact	Less Than Significant with Mitigation Incorporated	Less Than Significant Impact	No Impact
b) Result in substantial soil erosion or the loss of topsoil?	<input type="checkbox"/>	<input type="checkbox"/>	<input checked="" type="checkbox"/>	<input type="checkbox"/>
c) Be located on a geologic unit or soil that is unstable, or that would become unstable as a result of the project, and potentially result in on- or off-site landslide, lateral spreading, subsidence, liquefaction or collapse?	<input type="checkbox"/>	<input type="checkbox"/>	<input checked="" type="checkbox"/>	<input type="checkbox"/>
d) Be located on expansive soil, as defined in Table 18-1-B of the Uniform Building Code (1994), creating substantial risks to life or property?	<input type="checkbox"/>	<input type="checkbox"/>	<input checked="" type="checkbox"/>	<input type="checkbox"/>
e) Have soils incapable of adequately supporting the use of septic tanks or alternative waste water disposal systems where sewers are not available for the disposal of waste water?	<input type="checkbox"/>	<input type="checkbox"/>	<input type="checkbox"/>	<input checked="" type="checkbox"/>
VII. GREENHOUSE GAS EMISSIONS – Would the project:				
a) Generate greenhouse gas emissions, either directly or indirectly, that may have a significant impact on the environment?	<input type="checkbox"/>	<input type="checkbox"/>	<input checked="" type="checkbox"/>	<input type="checkbox"/>
b) Conflict with an applicable plan, policy or regulation adopted for the purpose of reducing the emissions of greenhouse gases?	<input type="checkbox"/>	<input type="checkbox"/>	<input checked="" type="checkbox"/>	<input type="checkbox"/>
VIII. HAZARDS AND HAZARDOUS MATERIALS – Would the project:				
a) Create a significant hazard to the public or the environment through the routine transport, use, or disposal of hazardous materials?	<input type="checkbox"/>	<input type="checkbox"/>	<input checked="" type="checkbox"/>	<input type="checkbox"/>
b) Create a significant hazard to the public or the environment through reasonably foreseeable upset and accident conditions involving the release of hazardous materials into the environment?	<input type="checkbox"/>	<input type="checkbox"/>	<input checked="" type="checkbox"/>	<input type="checkbox"/>
c) Emit hazardous emissions or handle hazardous or acutely hazardous materials, substances, or waste within one-quarter mile of an existing or proposed school?	<input type="checkbox"/>	<input type="checkbox"/>	<input type="checkbox"/>	<input checked="" type="checkbox"/>
d) Be located on a site that is included on a list of hazardous materials sites compiled pursuant to Government Code Section 65962.5 and, as a result, would it create a significant hazard to the public or the environment?	<input type="checkbox"/>	<input type="checkbox"/>	<input checked="" type="checkbox"/>	<input type="checkbox"/>
e) For a project located within an airport land use plan or, where such a plan has not been adopted, within two miles of a public airport or public use airport, would the project result in a safety hazard for people residing or working in the project area?	<input type="checkbox"/>	<input type="checkbox"/>	<input type="checkbox"/>	<input checked="" type="checkbox"/>

Initial Study for the Carlsbad Seawater Desalination Plant Intake and Discharge Facility Modifications

	Potentially Significant Impact	Less Than Significant with Mitigation Incorporated	Less Than Significant Impact	No Impact
f) For a project within the vicinity of a private airstrip, would the project result in a safety hazard for people residing or working in the project area?	<input type="checkbox"/>	<input type="checkbox"/>	<input type="checkbox"/>	<input checked="" type="checkbox"/>
g) Impair implementation of or physically interfere with an adopted emergency response plan or emergency evacuation plan?	<input type="checkbox"/>	<input type="checkbox"/>	<input checked="" type="checkbox"/>	<input type="checkbox"/>
h) Expose people or structures to a significant risk of loss, injury or death involving wildland fires, including where wildlands are adjacent to urbanized areas or where residences are intermixed with wildlands?	<input type="checkbox"/>	<input type="checkbox"/>	<input type="checkbox"/>	<input checked="" type="checkbox"/>
IX. HYDROLOGY AND WATER QUALITY – Would the project:				
a) Violate any water quality standards or waste discharge requirements?	<input type="checkbox"/>	<input checked="" type="checkbox"/>	<input type="checkbox"/>	<input type="checkbox"/>
b) Substantially deplete groundwater supplies or interfere substantially with groundwater recharge such that there would be a net deficit in aquifer volume or a lowering of the local groundwater table level (e.g., the production rate of pre-existing nearby wells would drop to a level which would not support existing land uses or planned uses for which permits have been granted)?	<input type="checkbox"/>	<input type="checkbox"/>	<input checked="" type="checkbox"/>	<input type="checkbox"/>
c) Substantially alter the existing drainage pattern of the site or area, including through the alteration of the course of a stream or river, in a manner which would result in substantial erosion or siltation on- or off-site?	<input type="checkbox"/>	<input type="checkbox"/>	<input checked="" type="checkbox"/>	<input type="checkbox"/>
d) Substantially alter the existing drainage pattern of the site or area, including through the alteration of the course of a stream or river, or substantially increase the rate or amount of surface runoff in a manner which would result in flooding on- or off-site?	<input type="checkbox"/>	<input type="checkbox"/>	<input checked="" type="checkbox"/>	<input type="checkbox"/>
e) Create or contribute runoff water which would exceed the capacity of existing or planned stormwater drainage systems or provide substantial additional sources of polluted runoff?	<input type="checkbox"/>	<input type="checkbox"/>	<input checked="" type="checkbox"/>	<input type="checkbox"/>
f) Otherwise substantially degrade water quality?	<input type="checkbox"/>	<input checked="" type="checkbox"/>	<input type="checkbox"/>	<input type="checkbox"/>
g) Place housing within a 100-year flood hazard area as mapped on a federal Flood Hazard Boundary or Flood Insurance Rate Map or other flood hazard delineation map?	<input type="checkbox"/>	<input type="checkbox"/>	<input checked="" type="checkbox"/>	<input type="checkbox"/>
h) Place within a 100-year flood hazard area structures which would impede or redirect flood flows?	<input type="checkbox"/>	<input type="checkbox"/>	<input checked="" type="checkbox"/>	<input type="checkbox"/>

Initial Study for the Carlsbad Seawater Desalination Plant Intake and Discharge Facility Modifications

	Potentially Significant Impact	Less Than Significant with Mitigation Incorporated	Less Than Significant Impact	No Impact
i) Expose people or structures to a significant risk of loss, injury or death involving flooding, including flooding as a result of the failure of a levee or dam?	<input type="checkbox"/>	<input type="checkbox"/>	<input checked="" type="checkbox"/>	<input type="checkbox"/>
j) Inundation by seiche, tsunami, or mudflow?	<input type="checkbox"/>	<input type="checkbox"/>	<input checked="" type="checkbox"/>	<input type="checkbox"/>
X. LAND USE AND PLANNING – Would the project:				
a) Physically divide an established community?	<input type="checkbox"/>	<input type="checkbox"/>	<input checked="" type="checkbox"/>	<input type="checkbox"/>
b) Conflict with any applicable land use plan, policy, or regulation of an agency with jurisdiction over the project (including, but not limited to the general plan, specific plan, local coastal program, or zoning ordinance) adopted for the purpose of avoiding or mitigating an environmental effect?	<input type="checkbox"/>	<input type="checkbox"/>	<input checked="" type="checkbox"/>	<input type="checkbox"/>
c) Conflict with any applicable habitat conservation plan or natural community conservation plan?	<input type="checkbox"/>	<input type="checkbox"/>	<input checked="" type="checkbox"/>	<input type="checkbox"/>
XI. MINERAL RESOURCES – Would the project:				
a) Result in the loss of availability of a known mineral resource that would be of value to the region and the residents of the state?	<input type="checkbox"/>	<input type="checkbox"/>	<input checked="" type="checkbox"/>	<input type="checkbox"/>
b) Result in the loss of availability of a locally-important mineral resource recovery site delineated on a local general plan, specific plan, or other land use plan?	<input type="checkbox"/>	<input type="checkbox"/>	<input checked="" type="checkbox"/>	<input type="checkbox"/>
XII. NOISE – Would the project result in:				
a) Exposure of persons to or generation of noise levels in excess of standards established in the local general plan or noise ordinance, or applicable standards of other agencies?	<input type="checkbox"/>	<input type="checkbox"/>	<input checked="" type="checkbox"/>	<input type="checkbox"/>
b) Exposure of persons to or generation of excessive groundborne vibration or groundborne noise levels?	<input type="checkbox"/>	<input type="checkbox"/>	<input checked="" type="checkbox"/>	<input type="checkbox"/>
c) A substantial permanent increase in ambient noise levels in the project vicinity above levels existing without the project?	<input type="checkbox"/>	<input type="checkbox"/>	<input checked="" type="checkbox"/>	<input type="checkbox"/>
d) A substantial temporary or periodic increase in ambient noise levels in the project vicinity above levels existing without the project?	<input type="checkbox"/>	<input type="checkbox"/>	<input checked="" type="checkbox"/>	<input type="checkbox"/>
e) For a project located within an airport land use plan or, where such a plan has not been adopted, within two miles of a public airport or public use airport, would the project expose people residing or working in the project area to excessive noise levels?	<input type="checkbox"/>	<input type="checkbox"/>	<input type="checkbox"/>	<input checked="" type="checkbox"/>

Initial Study for the Carlsbad Seawater Desalination Plant Intake and Discharge Facility Modifications

	Potentially Significant Impact	Less Than Significant with Mitigation Incorporated	Less Than Significant Impact	No Impact
f) For a project within the vicinity of a private airstrip, would the project expose people residing or working in the project area to excessive noise levels?	<input type="checkbox"/>	<input type="checkbox"/>	<input type="checkbox"/>	<input checked="" type="checkbox"/>
XIII. POPULATION AND HOUSING – Would the project:				
a) Induce substantial population growth in an area, either directly (for example, by proposing new homes and businesses) or indirectly (for example, through extension of roads or other infrastructure)?	<input type="checkbox"/>	<input type="checkbox"/>	<input checked="" type="checkbox"/>	<input type="checkbox"/>
b) Displace substantial numbers of existing housing, necessitating the construction of replacement housing elsewhere?	<input type="checkbox"/>	<input type="checkbox"/>	<input type="checkbox"/>	<input checked="" type="checkbox"/>
c) Displace substantial numbers of people, necessitating the construction of replacement housing elsewhere?	<input type="checkbox"/>	<input type="checkbox"/>	<input type="checkbox"/>	<input checked="" type="checkbox"/>
XIV. PUBLIC SERVICES				
a) Would the project result in substantial adverse physical impacts associated with the provision of new or physically altered governmental facilities, need for new or physically altered governmental facilities, the construction of which could cause significant environmental impacts, in order to maintain acceptable service ratios, response times, or other performance objectives for any of the public services:				
Fire protection?	<input type="checkbox"/>	<input type="checkbox"/>	<input checked="" type="checkbox"/>	<input type="checkbox"/>
Police protection?	<input type="checkbox"/>	<input type="checkbox"/>	<input checked="" type="checkbox"/>	<input type="checkbox"/>
Schools?	<input type="checkbox"/>	<input type="checkbox"/>	<input checked="" type="checkbox"/>	<input type="checkbox"/>
Parks?	<input type="checkbox"/>	<input type="checkbox"/>	<input checked="" type="checkbox"/>	<input type="checkbox"/>
Other public facilities?	<input type="checkbox"/>	<input type="checkbox"/>	<input checked="" type="checkbox"/>	<input type="checkbox"/>
XV. RECREATION				
a) Would the project increase the use of existing neighborhood and regional parks or other recreational facilities such that substantial physical deterioration of the facility would occur or be accelerated?	<input type="checkbox"/>	<input type="checkbox"/>	<input checked="" type="checkbox"/>	<input type="checkbox"/>
b) Does the project include recreational facilities or require the construction or expansion of recreational facilities which might have an adverse physical effect on the environment?	<input type="checkbox"/>	<input type="checkbox"/>	<input type="checkbox"/>	<input checked="" type="checkbox"/>

Initial Study for the Carlsbad Seawater Desalination Plant Intake and Discharge Facility Modifications

	Potentially Significant Impact	Less Than Significant with Mitigation Incorporated	Less Than Significant Impact	No Impact
XVI. TRANSPORTATION/TRAFFIC – Would the project:				
a) Conflict with an applicable plan, ordinance or policy establishing measures of effectiveness for the performance of the circulation system, taking into account all modes of transportation including mass transit and non-motorized travel and relevant components of the circulation system, including but not limited to intersections, streets, highways and freeways, pedestrian and bicycle paths, and mass transit?	<input type="checkbox"/>	<input type="checkbox"/>	<input checked="" type="checkbox"/>	<input type="checkbox"/>
b) Conflict with an applicable congestion management program, including, but not limited to level of service standards and travel demand measures, or other standards established by the county congestion management agency for designated roads or highways?	<input type="checkbox"/>	<input type="checkbox"/>	<input checked="" type="checkbox"/>	<input type="checkbox"/>
c) Result in a change in air traffic patterns, including either an increase in traffic levels or a change in location that results in substantial safety risks?	<input type="checkbox"/>	<input type="checkbox"/>	<input checked="" type="checkbox"/>	<input type="checkbox"/>
d) Substantially increase hazards due to a design feature (e.g., sharp curves or dangerous intersections) or incompatible uses (e.g., farm equipment)?	<input type="checkbox"/>	<input type="checkbox"/>	<input checked="" type="checkbox"/>	<input type="checkbox"/>
e) Result in inadequate emergency access?	<input type="checkbox"/>	<input type="checkbox"/>	<input checked="" type="checkbox"/>	<input type="checkbox"/>
f) Conflict with adopted policies, plans, or programs regarding public transit, bicycle, or pedestrian facilities, or otherwise decrease the performance or safety of such facilities?	<input type="checkbox"/>	<input type="checkbox"/>	<input checked="" type="checkbox"/>	<input type="checkbox"/>
XVII. UTILITIES AND SERVICE SYSTEMS – Would the project:				
a) Exceed wastewater treatment requirements of the applicable Regional Water Quality Control Board?	<input type="checkbox"/>	<input type="checkbox"/>	<input checked="" type="checkbox"/>	<input type="checkbox"/>
b) Require or result in the construction of new water or wastewater treatment facilities or expansion of existing facilities, the construction of which could cause significant environmental effects?	<input type="checkbox"/>	<input type="checkbox"/>	<input checked="" type="checkbox"/>	<input type="checkbox"/>
c) Require or result in the construction of new storm water drainage facilities or expansion of existing facilities, the construction of which could cause significant environmental effects?	<input type="checkbox"/>	<input type="checkbox"/>	<input checked="" type="checkbox"/>	<input type="checkbox"/>
d) Have sufficient water supplies available to serve the project from existing entitlements and resources, or are new or expanded entitlements needed?	<input type="checkbox"/>	<input type="checkbox"/>	<input type="checkbox"/>	<input checked="" type="checkbox"/>

Initial Study for the Carlsbad Seawater Desalination Plant Intake and Discharge Facility Modifications

	Potentially Significant Impact	Less Than Significant with Mitigation Incorporated	Less Than Significant Impact	No Impact
e) Result in a determination by the wastewater treatment provider, which serves or may serve the project that it has adequate capacity to serve the project's projected demand in addition to the provider's existing commitments?	<input type="checkbox"/>	<input type="checkbox"/>	<input checked="" type="checkbox"/>	<input type="checkbox"/>
f) Be served by a landfill with sufficient permitted capacity to accommodate the project's solid waste disposal needs?	<input type="checkbox"/>	<input type="checkbox"/>	<input checked="" type="checkbox"/>	<input type="checkbox"/>
g) Comply with federal, state, and local statutes and regulations related to solid waste?	<input type="checkbox"/>	<input type="checkbox"/>	<input checked="" type="checkbox"/>	<input type="checkbox"/>
XVIII. MANDATORY FINDINGS OF SIGNIFICANCE				
a) Does the project have the potential to degrade the quality of the environment, substantially reduce the habitat of a fish or wildlife species, cause a fish or wildlife population to drop below self-sustaining levels, threaten to eliminate a plant or animal community, reduce the number or restrict the range of a rare or endangered plant or animal or eliminate important examples of the major periods of California history or prehistory?	<input type="checkbox"/>	<input checked="" type="checkbox"/>	<input type="checkbox"/>	<input type="checkbox"/>
b) Does the project have impacts that are individually limited, but cumulatively considerable? ("Cumulatively considerable" means that the incremental effects of a project are considerable when viewed in connection with the effects of past projects, the effects of other current projects, and the effects of probable future projects)?	<input type="checkbox"/>	<input checked="" type="checkbox"/>	<input type="checkbox"/>	<input type="checkbox"/>
c) Does the project have environmental effects which will cause substantial adverse effects on human beings, either directly or indirectly?	<input type="checkbox"/>	<input type="checkbox"/>	<input checked="" type="checkbox"/>	<input type="checkbox"/>

3.1 Aesthetics

a) *Would the project have a substantial adverse effect on a scenic vista?*

The FEIR concluded that demolition of any existing structures and construction of the desalination plant would result in short-term aesthetic impacts due to presence of construction equipment and staging areas. These short-term construction impacts to aesthetics were determined to be less than significant due to their temporary nature.

The FEIR also analyzed long-term aesthetic impacts of the desalination plant. It concluded, with the use of visual simulations, that the desalination plant would not have a

Initial Study for the Carlsbad Seawater Desalination Plant Intake and Discharge Facility Modifications

significant impact on a scenic vista due to the desalination plant having a maximum height of 37 feet above existing grade, the use of different materials and architectural details to provide visual variety, and metal screen panel enclosures.

Scenic vistas and scenic corridors in the City of Carlsbad that are near the proposed modifications include the coastline views as well as the beach and coastal corridor (City of Carlsbad 2014). The proposed modifications would introduce a new above ground pump station immediately south of Aqua Hedionda Lagoon, near the current water intake for the Encina Power Station (EPS). While the modifications would include a new pump station building as an additional component, it would be lower in height and smaller in scale than the components evaluated in the previously certified FEIR and would not alter existing views from any scenic vistas. As such, there are no changes that would require revisions of the previous environmental documents, changes with respect to the circumstances under which the project is undertaken, or new information of importance concerning an adverse effect on a scenic vista. Modifications would result in a less than significant impact to a scenic vista, consistent with the previously certified FEIR. No revisions to the FEIR are necessary and this issue will not be evaluated in the SEIR.

b) *Would the project substantially damage scenic resources including, but not limited to, trees, rock outcroppings, and historic buildings within a state scenic highway?*

The FEIR concluded that the existing vegetative screening (mature eucalyptus trees) for the desalination plant site may be affected by activities necessary for the construction of the desalination plant and would result in a potentially significant impact to scenic resources. The FEIR stated that the construction and operation of the desalination plant would comply with the City of Carlsbad's Scenic Corridor Guidelines for portions of the desalination plant site adjacent to or within the Carlsbad Boulevard Theme Corridor and NCTD railroad corridor. Additionally, a mitigation measure was included in the FEIR to provide for appropriate replacement of any trees that are removed as a result of construction of the desalination plant, which reduced the potentially significant impact to scenic resources to a less than significant level.

There are no officially designated or eligible State scenic highways or identified scenic resources in proximity to the proposed modifications or desalination plant site (Caltrans 2013). The proposed modifications would involve construction of a new above ground pump station, portions of which could be visible from Route 101 (Carlsbad Boulevard). However, these proposed above ground structures would be required to comply with the City of Carlsbad's Scenic Corridor Guidelines, similar to the analysis in the FEIR.

Initial Study for the Carlsbad Seawater Desalination Plant Intake and Discharge Facility Modifications

Therefore, impacts from the proposed modifications are anticipated to be less than significant, consistent with the previously certified FEIR. No revisions to the FEIR are necessary and this issue will not be evaluated in the SEIR.

c) *Would the project substantially degrade the existing visual character or quality of the site and its surroundings?*

The FEIR concluded that visual exposure of certain facilities associated with the desalination plant, such as chemical storage tanks, could potentially result in the degradation of the visual character or quality of the desalination plant site. As a result, a potentially significant impact was identified and mitigation measures incorporating the use of visual screening techniques for the desalination plant were required by the City of Carlsbad to reduce impacts to a less than significant level.

The visual character of the desalination plant site is dominated by the existing EPS and other industrial structures (including the CDP under construction, and the future Carlsbad Energy Center Power Project). The proposed modifications would develop an above ground pump station on the desalination plant site. The proposed modifications would be subject to the same mitigation measures related to visual screening provided in the FEIR. As such, impacts from the proposed modifications are anticipated to be less than significant with mitigation, consistent with the previously certified FEIR. No revisions to the FEIR are necessary and this issue will not be evaluated in the SEIR.

d) *Would the project create a new source of substantial light or glare which would adversely affect day or nighttime views in the area?*

The FEIR concluded that the new lighting sources resulting from the desalination plant would not contribute to a substantial increase in lighting, specifically during nighttime. However, due to proximity to sensitive biological resources, impacts from lighting sources could be potentially significant. Therefore, mitigation measures to control nighttime exterior lighting fixture were provided in the FEIR to reduce potential lighting impacts to surrounding areas and nighttime views to a less than significant level. Additionally, while the surface coatings and materials used on the exterior of the new building and structures of the desalination plant are not expected to result in substantial glare impacts, the FEIR mitigation measures require that reflective glass is not used in the final design.

Initial Study for the Carlsbad Seawater Desalination Plant Intake and Discharge Facility Modifications

The proposed modifications would create an aboveground pump station near the existing EPS intake that would include nighttime security lighting. The proposed modifications would include outdoor safety and security lighting for plant operators. All outdoor lighting fixtures would be subject to City ordinances to reduce light pollution, glare, and nighttime sky glow. The proposed modifications would not include large amounts of windows or other potentially reflective surfaces that could produce substantial amounts glare. Further, the proposed modifications would be subject to similar mitigation measures related to lighting and glare provided in the FEIR. Therefore, impacts from the proposed modifications are anticipated to be mitigated to less than significant levels, consistent with the previously certified FEIR. No revisions to the FEIR are necessary and this issue will not be evaluated in the SEIR.

3.2 Agriculture and Forestry Resources

- a) *Would the project convert Prime Farmland, Unique Farmland, or Farmland of Statewide Importance (Farmland), as shown on the maps prepared pursuant to the Farmland Mapping and Monitoring Program of the California Resources Agency, to non-agricultural use?*

The analysis in the FEIR concluded that no portion of the on-site facilities of the desalination plant would impact agricultural resources or forestry resources on site and any impacts that would occur off-site and would be temporary. The proposed modifications would involve the construction of a new intake system on a currently developed site that does not contain any agriculture or forestry resources (State of California 2008). According to the Department of Conservation's *San Diego County Important Farmland 2010* map, the proposed intake structure and associated facilities would be located on "Urban and Built Up Land" and "Other Land", neither of which are consider land important to farming or agriculture (Department of Conservation 2013). Therefore, there are no changes that would require revisions of the previous environmental documents, no changes with respect to the circumstances under which the project is undertaken, and no new information of importance with regards to impacts to agricultural or forestry resources. The previous environmental documents found that there would be no impact to agricultural or forestry resources on site and any impacts that would occur off-site and would be temporary. No new information is available that would change this conclusion under the proposed modifications. Impacts from the proposed modifications would be less than significant, consistent with the previously certified FEIR. No revisions to the FEIR are necessary and this issue will not be evaluated in the SEIR.

Initial Study for the Carlsbad Seawater Desalination Plant Intake and Discharge Facility Modifications

- b) *Would the project conflict with existing zoning for agricultural use, or a Williamson Act contract?*

See Response (a) above.

- c) *Would the project conflict with existing zoning for, or cause rezoning of, forest land (as defined in Public Resources Code section 12220(g)), timberland (as defined by Public Resources Code section 4526), or timberland zoned Timberland Production (as defined by Government Code section 51104(g))?*

See Response (a) above.

- d) *Would the project result in the loss of forest land or conversion of forest land to non-forest use?*

See Response (a) above.

- e) *Would the project involve other changes in the existing environment which, due to their location or nature, could result in conversion of Farmland, to non-agricultural use or conversion of forest land to non-forest use?*

See Response (a) above.

3.3 Air Quality

- a) *Would the project conflict with or obstruct implementation of the applicable air quality plan?*

The FEIR concluded that construction of the on-site desalination plant facilities would result in exceedance of the NO_x threshold emission levels during peak construction of on-site facilities. Construction would not exceed the threshold emission levels of CO, ROC, SO_x, and PM₁₀. Due to the temporary nature of construction, the FEIR concluded that construction impacts to air quality would be less than significant. Construction of the desalination plant was found to be consistent with the City of Carlsbad General Plan and Zoning Ordinance, and did not propose or require any change in land use designations. Therefore, the FEIR found that desalination plant construction and operation would not conflict or obstruct the implementation of the San Diego Regional Air Quality Strategy (RAQS) or applicable portions of the State Implementation Plan (SIP).

Initial Study for the Carlsbad Seawater Desalination Plant Intake and Discharge Facility Modifications

The proposed modifications would result in criteria pollutant emissions during construction, and would increase electricity consumption from the operation of low-impact pumps that would result in indirect criteria pollutant emissions.

The emissions that would result from construction and operation of the proposed modifications are subject to the rules and regulations of the San Diego Air Pollution Control District (SDAPCD). The SDAPCD and are responsible for developing and implementing the clean air plan for attainment and maintenance of the ambient air quality standards in the San Diego Air Basin (SDAB).

If a project proposes development that is greater than that anticipated in the local plan and the San Diego Association of Governments (SANDAG) growth projections, the project might be in conflict with the RAQS and may contribute to a potentially significant cumulative impact on air quality. The proposed modifications would not change the land use or zoning designations of the project site, would not change the existing uses related to seawater desalination on the site, and would not conflict with applicable policies in the City of Carlsbad's General Plan. The proposed modifications would not increase population nor would it require additional employment. As such, the proposed modifications would not increase development density and would be considered consistent at the regional level with the underlying growth forecasts in the RAQS.

Impacts from the proposed modifications are anticipated to be less than significant, consistent with the previously certified FEIR. However, because of the introduction of new construction and mechanical components minor revisions to the FEIR will be necessary and this issue will be included in the SEIR.

b) Would the project violate any air quality standard or contribute substantially to an existing or projected air quality violation?

As discussed under response (a) above, the FEIR concluded that on-site peak construction would exceed the NO_x emission threshold levels; however, due to the temporary nature of construction this exceedance would have less than significant impacts to air quality. The FEIR also analyzed direct and indirect operational emissions from the desalination plant. All desalination plant components would utilize electrical power; thus, no direct operational emissions would occur. Indirect emissions include minor and less than significant emissions from operational worker vehicles, maintenance vehicles, landscaping. Indirect operational emissions also include emissions from power generation. The FEIR found that the electric power required by the desalination plant is not expected to cause any power supplier to exceed the permitted levels of its emissions.

Initial Study for the Carlsbad Seawater Desalination Plant Intake and Discharge Facility Modifications

Regulation of and potential mitigation for any changes in air emissions from electrical generating facilities resulting from increased power usage is within the responsibility and jurisdiction of local air pollution control districts in California, not the City of Carlsbad. Therefore, operational impacts were determined to be less than significant in the FEIR.

During construction, the proposed modifications would introduce additional emissions beyond what analyzed in the FEIR. Operation of the proposed modifications would utilize low-impact pumps, which may increase electricity use and consequently indirect emissions.

The SDAPCD does not provide quantitative thresholds for determining the significance of construction or mobile source-related impacts. However, as part of its air quality permitting process, the SDAPCD has established thresholds in Rule 20.2 requiring the preparation of air quality impact assessments for permitted stationary sources. The SDAPCD sets forth quantitative emission thresholds below which a stationary source would not have a significant impact on ambient air quality. Although these thresholds do not generally apply to mobile sources or general land development projects, for comparative purposes these levels may be used to evaluate the increased emissions that would be discharged to the SDAB from proposed development projects. For CEQA purposes, project-related air quality impacts estimated in this environmental analysis would be considered significant if any of the applicable significance thresholds presented in Table 1, SDAPCD Air Quality Significance Thresholds, are exceeded during construction or operation. In the event that emissions exceed these thresholds, modeling would be required to demonstrate that the project’s total air quality impacts result in ground-level concentrations that are below the California Ambient Air Quality Standards (CAAQS) and the National Ambient Air Quality Standards (NAAQS), including appropriate background levels.

Table 1
San Diego Air Pollution Control District Air Quality Significance Thresholds

Construction Emissions	
<i>Pollutant</i>	<i>Total Emissions (Pounds per Day)</i>
Respirable particulate matter (PM ₁₀)	100
Fine particulate matter (PM _{2.5})	55
Oxides of nitrogen (NO _x)	250
Sulfur oxides (SO _x)	250
Carbon monoxide (CO)	550
Volatile organic compounds (VOCs)	75*

Source: County of San Diego 2007.

Initial Study for the Carlsbad Seawater Desalination Plant Intake and Discharge Facility Modifications

*Threshold for VOCs based on the threshold of significance for VOCs from the South Coast Air Quality Management District for the Coachella Valley.

The SDAB has been designated by the state as a nonattainment area for PM₁₀ and PM_{2.5} and O₃ under the CAAQS. The SDAB has recently been designated by the EPA as an attainment area for the 1997 8-hour NAAQS for O₃ and remains a marginal nonattainment area for the 2008 8-hour NAAQS for O₃. The air quality issues in the SDAB are the result of cumulative emissions from motor vehicles, off-road equipment, commercial and industrial facilities, and other emission sources. Projects that emit these pollutants or their precursors (e.g., VOCs and NO_x for ozone) potentially contribute to poor air quality.

The proposed modifications are anticipated to result in less than significant impacts, consistent with the previously certified FEIR. However, because of the introduction of new construction and mechanical components minor revisions to the FEIR will be necessary and this issue will be included in the SEIR.

- c) ***Would the project result in a cumulatively considerable net increase of any criteria pollutant for which the project region is non-attainment under an applicable federal or state ambient air quality standard (including releasing emissions which exceed quantitative thresholds for ozone precursors)?***

As discussed in response (b) above, the FEIR concluded that operation of the desalination plant would not exceed emission threshold levels and peak construction exceedance of NO_x would be temporary, therefore impacts to air quality would be less than significant. The FEIR also concluded that construction and operation of the desalination plant would not contribute a considerable net increase of any criteria pollutant or contribute substantially to an existing air quality violation.

The proposed modifications would result in criteria pollutant emissions during construction, and would include electricity consumption from the operation of low-impact pumps that would result in indirect criteria pollutant emissions. The construction and operational emissions from the proposed modifications are not anticipated to exceed the SDAPCD significant thresholds. The proposed modifications would also not conflict with the RAQS, which addresses the cumulative emissions in the SDAB. Accordingly, the proposed modifications are not expected to result in a cumulatively considerable increase in emissions of nonattainment pollutants. Therefore, impacts from the proposed modifications are anticipated to be less than significant, consistent with the previously certified FEIR. However, because of the introduction of new construction and mechanical

Initial Study for the Carlsbad Seawater Desalination Plant Intake and Discharge Facility Modifications

components minor revisions to the FEIR will be necessary and this issue will be included in the SEIR.

d) Would the project expose sensitive receptors to substantial pollutant concentrations?

The FEIR concluded that construction of the desalination plant would not expose sensitive receptors to substantial diesel exhaust concentrations. Because of the short-term nature of the construction project (which was assumed to occur for 8-10 hours per day, six days per week, over the course of 24 months), adverse long-term impacts associated with diesel exhaust particulate matter would not occur as a result of project construction. The FEIR determined that impacts would be less than significant during construction. Operational emissions from vehicle trips and landscaping would not create substantial pollutant concentrations; components of the desalination plant would utilize electric power. The FEIR concluded that operation of the desalination plant would have less than significant impacts to sensitive receptors.

Sensitive receptors to pollutant concentrations generally include land uses such as schools, residential, or other such similar uses where people are present for extended periods. The nearest sensitive receptors are located across Agua Hedionda Lagoon, approximately 0.46 miles to the north. Construction of the proposed modifications would not require the simultaneous operation of large amounts of diesel construction equipment. The diesel construction equipment would also be subject to the Airborne Toxic Control Measure for in-use mobile construction equipment promulgated by CARB, which would minimize diesel particulate matter. As a result, construction activities would not generate substantial emissions of toxic air contaminants, specifically diesel exhaust particulate matter. As stated in the previously certified FEIR, during operations the desalination plant does not involve the direct emission of toxic air contaminants. The proposed modifications would similarly not involve the direct emission of toxic air contaminants during operations and would therefore not have the potential to expose sensitive receptors to substantial pollutant concentrations during operations. Impacts from the proposed modifications are anticipated to be less than significant, consistent with the previously certified FEIR. However, because of the introduction of new construction and mechanical components minor revisions to the FEIR will be necessary and this issue will be included in the SEIR.

Initial Study for the Carlsbad Seawater Desalination Plant Intake and Discharge Facility Modifications

e) *Would the project create objectionable odors affecting a substantial number of people?*

The FEIR concluded that the desalination plant would not utilize odor generating equipment as defined by SCAQMD and that impacts from odors would be less than significant.

Odors are a form of air pollution that is most obvious to the public. Potential sources that may emit odors during construction activities include diesel equipment and gasoline-powered engines. Odors from these sources would be localized, temporary, and are not expected to be created in substantial quantities as a result of construction of the proposed modifications. The operation of the intake and discharge modifications would not involve any odor-generating sources and is not classified as an odor-generating process. Therefore, impacts from the proposed modifications are anticipated to be less than significant, consistent with the previously certified FEIR. However, because of the introduction of new construction and mechanical components minor revisions to the FEIR will be necessary and this issue will be included in the SEIR.

3.4 Biological Resources

a) *Would the project have a substantial adverse effect, either directly or through habitat modifications, on any species identified as a candidate, sensitive, or special status species in local or regional plans, policies, or regulations, or by the California Department of Fish and Game or U.S. Fish and Wildlife Service?*

Terrestrial Environment

The FEIR concluded that the majority of potential impacts to terrestrial biological resources would occur off-site as construction and operation of the desalination plant would occur entirely within the EPS site. However, as shown in Figures 4.3-1 and 4.3-1 of the FEIR, portions of pipeline construction within the desalination plant site would occur in areas with coastal sage scrub and disturbed coastal sage scrub vegetation communities. No sensitive plant species occur within the desalination plant site. Coastal sage scrub is considered suitable habitat for the California gnatcatcher, a sensitive wildlife species and would have potential to occur within those vegetation communities; however, no other sensitive wildlife species would be substantially impacted by the desalination plant. The FEIR concluded that all direct impacts to sensitive terrestrial biological resources would be mitigated to a less than significant level by returning construction areas to pre-construction conditions and operating the desalination plant

Initial Study for the Carlsbad Seawater Desalination Plant Intake and Discharge Facility Modifications

within the EPS developed site. Therefore, due to the temporary nature of construction impacts, the FEIR concluded that indirect impacts would be less than significant.

The site of the proposed modifications is currently developed as the EPS intake structure and is proposed for a similar use as the new intake structure for desalination plant. The proposed modifications would include ground disturbance during construction and the development of an above ground pump station on the desalination plant site. The proposed modification of the intake would not affect any natural vegetation of plant communities. The portions of disturbed and undisturbed coastal sage scrub within the desalination plant site identified in the FEIR would not be affected by the development of the proposed modifications. The construction of the above ground pump station and other proposed modifications would occur in previously disturbed areas that do not contain sensitive biological resources and no sensitive terrestrial species would be affected by implementation of the proposed modifications. Therefore, impacts to terrestrial biological resources from the proposed modifications are anticipated to be less than significant, consistent with the previously certified FEIR. No revisions to the FEIR are necessary and this issue will not be evaluated in the SEIR.

Marine Environment

The FEIR analyzed the desalination plant's potential effects on the marine environment related to effects of chemical additives, impingement, entrainment, and salinity. The desalination plant as analyzed under the FEIR would either not require the EPS to increase the quantity or velocity of water withdrawn, or if operated in the "stand-alone" condition, would not withdraw seawater with a velocity greater than 0.5 feet per second, and therefore would not result in significant impacts related to impingement of marine life. With regards to entrainment, the FEIR concluded that the small proportion of marine organisms lost to entrainment as a result of the desalination plant operated either in the co-located or stand-alone scenarios, would not have a substantial effect on the species' ability to sustain their populations because of their widespread distribution and high reproductive potential. The most frequently entrained species are very abundant in the area of EPS intake, Agua Hedionda Lagoon, and the Southern California Bight; and therefore, the actual ecological effects due to any additional entrainment from the desalination plant were determined to be less than significant. However, despite these findings in the FEIR, the RWQCB and the Coastal Commission required mitigation under the standards that those agencies applied in issuing permits to operate the CDP. The mitigation consists of creation of 66 acres of estuarine habitat to fully offset all impacts associated with impingement and entrainment of all forms of marine life.

Initial Study for the Carlsbad Seawater Desalination Plant Intake and Discharge Facility Modifications

The FEIR also concluded that chemical additives would be neutralized prior to discharge and that impacts from these chemical additives on marine life would be less than significant. Additionally, the FEIR concluded that under typical conditions, the discharge from the desalination plant would not exceed a salinity level of 36.2 parts per thousand (ppt) within the Zone of Initial Dilution (ZID), which is below the significance criteria of 38.4 ppt. To ensure that impacts remain at a less than significant level, a mitigation measure was included in the FEIR for purposes of requiring monitoring of the combined operations of the desalination plant and the EPS to ensure that salinity levels remain within the parameters that have been analyzed.

The proposed modifications would utilize low-impact pumps and filters to lift dilution water from Agua Hedionda Lagoon into the dilution pond, which differs from the current intake and dilution method of the EPS intake structure. The primary purpose of the proposed modifications is to address California Water Code 13142.5(b) requirements related to best available technology and design of the intake system. The technology and design options being considered would reduce impingement and entrainment effects over what was estimated and mitigated for under the stand-alone operating scenario for the CDP. Additionally, the proposed modifications would result in receiving water salinity of 35 ppt or less at the edge of the ZID, which is a lower than the maximum salinity value analyzed in the FEIR. Therefore, impacts from the proposed modifications are anticipated to be less than significant, consistent with the previously certified FEIR. However, because of the introduction of modified intake and discharge components, minor revisions to the FEIR will be necessary and this issue will be included in the SEIR.

- b) Would the project have a substantial adverse effect on any riparian habitat or other sensitive natural community identified in local or regional plans, policies, regulations, or by the California Department of Fish and Game or U.S. Fish and Wildlife Service?***

The FEIR determined that no jurisdictional waters occur within the desalination plant site and that impacts to developed land and non-jurisdictional land cover types were determined to be less than significant.

Initial Study for the Carlsbad Seawater Desalination Plant Intake and Discharge Facility Modifications

The proposed modifications site is currently developed as the EPS intake structure and would have a similar use as the intake structure for the desalination plant under the proposed modifications. Therefore, impacts from the proposed modifications are anticipated to be less than significant, consistent with the previously certified FEIR. However, because of the introduction of modified intake and discharge components, minor revisions to the FEIR will be necessary and this issue will be included in the SEIR.

- c) *Would the project have a substantial adverse effect on federally protected wetlands as defined by Section 404 of the Clean Water Act (including, but not limited to, marsh, vernal pool, coastal, etc.) through direct removal, filling, hydrological interruption, or other means?*

The FEIR concluded that land cover types within the desalination plant site are not wetlands as defined by Section 404 of the Clean Water Act. As a result, any impacts as a result of the desalination plant were determined to be less than significant with the incorporation of mitigation measures including a Storm Water Pollution Prevention Plan (SWPPP).

The proposed modifications site is currently developed as the EPS intake structure and would have a similar use as the modified intake for the desalination plant. However, the proposed modifications would include modifications to the intake of water from the lagoon. Mitigation measures similar to those identified in the FEIR, including amending the construction best management practices (BMPs) and SWPPP, would be required to address the proposed modifications. Therefore, impacts from the proposed modifications are anticipated to be less than significant after mitigation, consistent with the previously certified FEIR. However, because of the introduction of modified intake and discharge components, and fish return channel, minor revisions to the FEIR will be necessary and this issue will be included in the SEIR.

- d) *Would the project interfere substantially with the movement of any native resident or migratory fish or wildlife species or with established native resident or migratory wildlife corridors, or impede the use of native wildlife nursery sites?*

Terrestrial Environment

The FEIR concluded that no significant impacts to habitat linkages would occur due to the temporary nature of construction. Additionally, the FEIR notes that no wildlife corridors or habitat linkages have been identified within the desalination plant site.

Initial Study for the Carlsbad Seawater Desalination Plant Intake and Discharge Facility Modifications

The proposed modifications would occur within an area that is currently developed as the EPS intake structure and surrounding pavement and landscaping. The proposed modifications would have a small development footprint on the previously developed EPS site and would not have substantial impacts on the terrestrial environment. Therefore, impacts from the proposed modifications are anticipated to be less than significant, consistent with the previously certified FEIR. No revisions to the FEIR are necessary and this issue will not be evaluated in the SEIR.

Marine Environment

Construction of the CDP does not involve work within the marine environment, and therefore, the FEIR does not directly analyze migratory marine species because CDP construction would not affect migration patterns of marine organisms. However, as stated in response (a) above, the FEIR provided analysis and direct significance conclusions for the marine environment in terms of chemical additives, impingement, entrainment, and salinity. The FEIR concluded that, with mitigation incorporated, the desalination plant would have less than significant impacts to the marine environment.

The proposed modifications would utilize similar discharge and intake areas as were analyzed in the previous environmental documents and that are currently used by the EPS. The proposed modifications would not result in a change in tidal flows that would alter the movement of marine species. Additionally, the intake of water from the Agua Hedionda Lagoon would not substantially change the basic flow characteristics of ocean water within or through the lagoon. The proposed modification would include a fish return that would enable fish captured in the intake process to escape back to the lagoon. The fish return discharge would be lagoon waters returned to the lagoon and would not result in impacts to the receiving waters and is designed to minimize impacts to fish. Therefore, impacts from the proposed modifications are anticipated to be less than significant, consistent with the previously certified FEIR. However, because of the introduction of modified intake and discharge components, minor revisions to the FEIR will be necessary and this issue will be included in the SEIR.

- e) ***Would the project conflict with any local policies or ordinances protecting biological resources, such as a tree preservation policy or ordinance?***

The FEIR does not identify any portion of the desalination plant site to be within the hardline preserve areas of the HMP and other conservation planning documents, which was found to be the only relevant and applicable policy related to this threshold.

Initial Study for the Carlsbad Seawater Desalination Plant Intake and Discharge Facility Modifications

The proposed modifications are within an area that is currently developed as the EPS intake structure, and related pavement and landscaping. As with the CDP plant itself, the proposed modifications are not within the hardline preserve area of the HMP, and moreover, does not contain any natural habitats, plant communities or sensitive species. Construction of the proposed modifications is not expected to substantially affect any biological resources protected by local policies or ordinances. Therefore, impacts from the proposed modifications are anticipated to be less than significant, consistent with the previously certified FEIR. No revisions to the FEIR are necessary and this issue will not be evaluated in the SEIR. .

- f) *Would the project conflict with the provisions of an adopted Habitat Conservation Plan, Natural Community Conservation Plan, or other approved local, regional, or state habitat conservation plan?*

The FEIR does not identify any portion of the desalination plant site to be within the hardline preserve areas of the HMP which is an HCP/NCCP, and which was found to be the only relevant and applicable policy related to this threshold.

The project site is currently developed as the EPS intake structure and is proposed for a similar use as the new intake structure for the desalination plant. Therefore, impacts from the proposed modification are anticipated to be less than significant, consistent with the previously certified FEIR. However, because of the introduction of modified intake and discharge components, minor revisions to the FEIR will be necessary and this issue will be included in the SEIR.

3.5 Cultural Resources

- a) *Would the project cause a substantial adverse change in the significance of a historical resource as defined in §15064.5?*

The FEIR utilized a records search and literature review to determine that 30 cultural resources sites lie within the on-site and off-site areas of the desalination plant. Two cultural sites were found to be located within the on-site desalination plant area, neither of which were determined to be historic resources. The FEIR concluded that impacts to historical resources were less than significant.

The proposed modifications would result in ground disturbing activities of an already developed site that does not contain historical resources. Therefore, impacts from the proposed modifications would be less than significant, consistent with the previously

Initial Study for the Carlsbad Seawater Desalination Plant Intake and Discharge Facility Modifications

certified FEIR. No revisions to the FEIR are necessary and this issue will not be evaluated in the SEIR.

b) *Would the project cause a substantial adverse change in the significance of an archaeological resource pursuant to §15064.5?*

The FEIR concluded that the two cultural resources, CA-SDI 6751 and CA-SDI-16885, found on the desalination plant site would be potentially impacted by construction. CA-SDI-16885 has been partially inspected and determined to not be significant, while the significance eastern portion of CA-SDI-16885 is unknown. The significance of CA-SI-6751 is also unknown. The FEIR determined that while the potential for impacts is considered low, construction activities may reveal that significant impacts could occur. Therefore, the FEIR provided mitigation measures in the form of demolition and construction monitoring to ensure that impacts remain at a less than significant level.

The proposed modifications require ground-disturbing activities for the construction of an above ground pump station. Mitigation in the form of cultural monitoring that was identified in the previously certified FEIR would be required during all phases ground disturbing construction activities for the modifications. In general, the potential for unknown cultural resources to occur within the proposed modifications site has not changed since the time of the analysis conducted in the previously certified FEIR. Therefore, impacts from the proposed modifications are anticipated to be less than significant with mitigation, consistent with the previously certified FEIR. No revisions to the FEIR are necessary and this issue will not be evaluated in the SEIR.

c) *Would the project directly or indirectly destroy a unique paleontological resource or site or unique geologic feature?*

The FEIR concluded that construction activities would not involve substantial excavation into the Loma Linda Terrace deposits, where there is potential for fossiliferous rock to exist. However, the FEIR provides mitigation measures in the form of construction monitoring to ensure that impacts to paleontological resources remain at a less than significant level.

Initial Study for the Carlsbad Seawater Desalination Plant Intake and Discharge Facility Modifications

As with cultural resources, the potential for unknown paleontological resources to occur within the proposed modifications site has not changed since the time of the analysis conducted in the previous environmental documents. The proposed modifications would require ground disturbing activities for the construction of a new above ground pump station . During grading and excavation, there is potential to discover previously unknown paleontological resources. Similar to discovery of unknown cultural resources described above, a paleontological monitoring program would be required during all phases of ground disturbing construction activities, as provided as mitigation measures in the FEIR. Therefore, impacts from the proposed modifications are anticipated to be less than significant with mitigation, consistent with the previously certified FEIR. No revisions to the FEIR are necessary and this issue will not be evaluated in the SEIR.

d) *Would the project disturb any human remains, including those interred outside of formal cemeteries?*

The FEIR did not conclude that human remains were present within the development area of the CDP, but did include mitigation measures for cultural monitoring during construction, including procedures for actions should any human remains be discovered during construction activities. The FEIR determined that cultural mitigation measures provided would ensure that impacts remain at a less than significant level.

Construction monitoring programs that were outlined in the previous environmental documents would also be required during the development of the proposed modifications. Therefore, impacts from the proposed modifications are anticipated to be less than significant with mitigation, consistent with the previously certified FEIR. No revisions to the FEIR are necessary and this issue will not be evaluated in the SEIR.

3.6 Geology and Soils

a) *Would the project expose people or structures to potential substantial adverse effects, including the risk of loss, injury, or death involving:*

i) *Rupture of a known earthquake fault, as delineated on the most recent Alquist-Priolo Earthquake Fault Zoning Map issued by the State Geologist for the area or based on other substantial evidence of a known fault? Refer to Division of Mines and Geology Special Publication 42.*

The FEIR states that the desalination plant site is not located within any Earthquake Fault Zones as defined by the Alquist-Priolo Act. With adherence to the Uniform Building Code (UBC) and design parameters of the Structural

Initial Study for the Carlsbad Seawater Desalination Plant Intake and Discharge Facility Modifications

Engineers Association of California, impacts from rupture of the nearest active fault (Rose Canyon Fault) were determined to be less than significant.

The proposed modifications would be located on a site with existing structures that were analyzed previously for impacts relate to geologic hazards. Information regarding earthquake fault zones has not changed since the time of the analysis in the previous environmental documents, which states that the desalination plant site is not located in an Alquist-Priolo Earthquake Fault Zone. As noted in the previously certified FEIR, Rose Canyon fault is the nearest active fault, approximately 4.3 miles away. Structures constructed as part of the proposed modifications would be designed to the most current building design standards as they relate to seismic safety in the California Building Code (CBC), similar to analysis found in the FEIR. Therefore, impacts from the proposed modifications are anticipated to be less than significant, consistent with the previously certified FEIR. No revisions to the FEIR are necessary and this issue will not be evaluated in further detail in the SEIR.

ii) Strong seismic ground shaking?

As discussed above in response (a)(i) above, the FEIR concluded that the effect of seismic shaking would be reduced by adhering to the Uniform Building Code and state-of-the art seismic design parameters of the Structural Engineers Association of California. Accordingly, impacts related to seismic shaking were determined to be less than significant.

As discussed in the above response (a)(i), information pertaining to seismic activity of the proposed modifications site has not changed since the time of the analysis in the previously certified FEIR. The proposed modifications would be located in the seismically active region of Southern California and would be subject to the same periodic occurrence of ground shaking as the entire region. Compliance with the most current seismic safety building standards in the CBC would ensure all structures are adequately constructed, as discussed in the FEIR. Therefore, impacts from the proposed modifications are anticipated to be less than significant, consistent with the previously certified FEIR. No revisions to the FEIR are necessary and this issue will not be evaluated in further detail in the SEIR.

Initial Study for the Carlsbad Seawater Desalination Plant Intake and Discharge Facility Modifications

iii) Seismic-related ground failure, including liquefaction?

The FEIR determined that the overall subsurface profile (including formational deposits of the Santiago Formation) and overlying thickness of non-saturated soils indicated that the potential for large-scale liquefaction to occur at the desalination plant site is very low. In addition, the desalination plant would adhere to current building code standards that are intended to reduce potential for structural damage resulting from liquefaction. Therefore, the FEIR concluded that impacts were determined to be less than significant.

While the proposed modifications site is currently graded, paved, and developed for water intake for the EPS. However the proposed modifications would develop an above ground pump station and other structures on localized soils with the potential for liquefaction. Additional geologic analysis of supporting soils would be required prior to excavation/grading to soil suitability for support of proposed structures and potential for liquefaction. The proposed intake structure and associated facilities would be developed on an area not previously analyzed in the FEIR for geologic hazards related to new construction. Upon completion of this analysis, design specific analyses would be completed in order to ensure proposed structures are built to adequate safety standards of the CBC. Therefore, impacts from the proposed modifications would be less than significant, consistent with the previously certified FEIR. No revisions to the FEIR are necessary and this issue will not be evaluated in the SEIR.

iv) Landslides?

The FEIR concluded that due to the gently sloping nature of the desalination plant site and with adherence to current building code standards, slope instability and landslide potential is low and that impacts were determined to be less than significant.

Initial Study for the Carlsbad Seawater Desalination Plant Intake and Discharge Facility Modifications

The proposed modifications would be within the evaluated desalination plant site with the exception of components within the forebay, which would involve modifications to the existing structures and devices for intake and discharge. Therefore, impacts from the proposed modifications are anticipated to be less than significant, consistent with the previously certified FEIR. No revisions to the FEIR are necessary and this issue will not be evaluated in further detail in the SEIR.

b) Would the project result in substantial soil erosion or the loss of topsoil?

The FEIR determined that during construction of the desalination plant site, underlying soils would be temporarily exposed which would increase their susceptibility to erosion. This exposed soil would potentially impact downstream water quality. Mitigation measures in the form of construction BMPs and an approved SWPPP provided in Section 4.7.5 of the FEIR would provide for soil erosion control, ensuring that impacts were less than significant.

Construction of the proposed modifications would result in temporary exposure of topsoil, increasing the potential of erosion and downstream siltation, similar to the described in the FEIR. The proposed modifications would be subject to the same erosion control measures including mitigation measure 4.3-3, which requires implementation of construction BMPs and an approved SWPPP. Additional discussion about soil erosion is found in Section 3.9 Hydrology and Water Quality. Impacts from the proposed modifications are anticipated to be less than significant with the incorporation of mitigation measures, consistent with the previously certified FEIR. No revisions to the FEIR are necessary and this issue will not be evaluated in the SEIR.

c) Would the project be located on a geologic unit or soil that is unstable, or that would become unstable as a result of the project, and potentially result in on- or off-site landslide, lateral spreading, subsidence, liquefaction or collapse?

The FEIR concluded that soils found on the desalination plant site would result in significant impacts related to stability. Therefore, the FEIR provided mitigation measures in the form of proper grading, re-compaction, and remedial grading per appropriate soil engineering standards would ensure that impacts were reduced to a less than significant level.

Initial Study for the Carlsbad Seawater Desalination Plant Intake and Discharge Facility Modifications

As discussed in response (a) above, while the proposed modifications would be located on land that has been previously graded, paved, and developed. Excavation within the intake area as part of the proposed modifications could potentially result in unstable soil and additional geologic analysis would be required to determine soil suitability and susceptibility to subsidence, liquefaction, or collapse. As stated in the previously certified FEIR, without proper grading and recompaction or remedial design features for building foundations, soil stability could be affected the proposed modifications. However, the proposed modifications would be required to implement the mitigation measures in Section 4.5, Geology and Soils, that would design and recompact soils and foundations of structures for stability. Therefore, impacts from the proposed modifications would be less than significant with the incorporation of mitigation, consistent with the previously certified FEIR. No revisions to the FEIR are necessary and this issue will not be evaluated in the SEIR.

d) *Would the project be located on expansive soil, as defined in Table 18-1-B of the Uniform Building Code (1994), creating substantial risks to life or property?*

The FEIR determined that, based on the results of subsurface exploration and laboratory testing, the pad-grade fill soils are generally considered to have a low expansion potential as defined by the UBC. Therefore, impacts at the desalination plant site related to soil expansion potential were determined to be less than significant.

The proposed modifications would include excavation for the proposed pump station. The soil characteristic on the site have not altered since the FEIR and soil characteristics in the localized area beneath the proposed modifications are expected to be the same as those identified throughout the EPS and CDP site. Therefore, impacts from the proposed modifications would be less than significant, consistent with the previously certified FEIR. No revisions to the FEIR are necessary and this issue will not be evaluated in the SEIR.

e) *Would the project have soils incapable of adequately supporting the use of septic tanks or alternative waste water disposal systems where sewers are not available for the disposal of waste water?*

The FEIR did not analyze impacts related to septic tanks and the desalination plant as analyzed in the FEIR did not propose the use of septic tanks.

The proposed modifications do not require or propose the use of septic tanks. Therefore, there are no changes that would require revisions of the previous environmental documents,

Initial Study for the Carlsbad Seawater Desalination Plant Intake and Discharge Facility Modifications

no changes with respect to the circumstances under which the project is undertaken, and no new information of importance with regards to impacts from soil erosion. The proposed modifications would result in no impact, consistent with the previously certified FEIR. No revisions to the FEIR are necessary and this issue will not be evaluated in the SEIR.

3.7 Greenhouse Gas Emissions

a) *Generate greenhouse gas emissions, either directly or indirectly, that may have a significant impact on the environment?*

The FEIR did not address specific thresholds related to greenhouse gas emissions (GHGs). However, the First Addendum to the FEIR prepared in 2009 discussed GHGs, and noted that the project is required to demonstrate a “net zero” impact on greenhouse gas emissions from indirect sources (electrical energy consumption), as part of voluntary measures to reduce GHGs, which were incorporated into Special Conditions of the Coastal Development Permit by the California Coastal Commission. Therefore, while the FEIR does not provide any significance conclusion for GHG impacts, the requirement net zero emissions would result in no increases in GHGs being generated through indirect sources, and therefore the project would not have an impact related to GHG emissions.

Construction of the proposed modifications would result in temporary emissions of GHGs, and would be short term in nature and would not substantially contribute to effects associated with GHG emissions. Operation of the desalination plant with the proposed modifications would increase GHG emissions from the electricity generated to operate the low-impact pumps.

The proposed modifications could generate GHG emissions.. However, these emissions would be reduced as part of the updated Energy Minimization and Greenhouse Gas Reduction Plan. Therefore, impacts would be less than significant. However, because of the introduction of modified facilities that would generate GHG emissions and the change in CEQA requirements for inclusion of a specific GHG section in an EIR, minor revisions to the FEIR will be necessary and this issue will be included in the SEIR.

b) *Conflict with an applicable plan, policy or regulation adopted for the purpose of reducing the emissions of greenhouse gases?*

The proposed modifications would increase electrical energy consumption from operation of the low-impact pumps that would emit GHGs. However, these emissions would be reduced as part of the updated Energy Minimization and Greenhouse Gas Reduction Plan,. Therefore, it is not anticipated that implementation of the modifications

Initial Study for the Carlsbad Seawater Desalination Plant Intake and Discharge Facility Modifications

would conflict with an applicable plan, policy or regulation adopted for the purpose of reducing the emissions of greenhouse gases, and impacts would be less than significant. However, because of the introduction of modified facilities that would generate GHG emissions and the change in CEQA requirements for inclusion of a specific GHG section in an EIR, minor revisions to the FEIR will be necessary and this issue will be included in the SEIR.

3.8 Hazards and Hazardous Materials

a) *Would the project create a significant hazard to the public or the environment through the routine transport, use, or disposal of hazardous materials?*

The FEIR analyzed both short-term construction impacts and long-term operational impacts related to hazardous materials for risk of exposure, release, combustion, and odor. Through adherence with the applicable local, state, and federal regulations related to hazardous materials use and disposal, it was determined that short-term construction impacts were determined to be less than significant. During operation of the desalination plant, workers would use and store chemical cleaning solutions to remove deposits from the reverse osmosis membranes. Additionally, chemicals would be used to treat product water. Through adherence with local, state, and federal hazardous materials handling and management regulations, as outlined in provided mitigation measures, impacts related to transport, use, storage, and disposal of hazardous materials were determined to be less than significant.

The proposed modifications would introduce a new structure to the desalination plant site that may require additional transport, use, and disposal of hazardous materials used in construction. These materials are expected to be similar to those required for general construction and operation of desalination plant.

Operation of the desalination plant would remain the same as analyzed under the previously certified FEIR with respect to the storage, use, and transport of potentially hazardous chemicals and the same provided mitigation in the FEIR would be implemented for the proposed modification. Therefore, impacts from the proposed modifications would be less than significant with the incorporation of mitigation measures, consistent with the previously certified EIR. No changes to the FEIR are necessary and this issue will not be evaluated in the SEIR.

Initial Study for the Carlsbad Seawater Desalination Plant Intake and Discharge Facility Modifications

- b) *Would the project create a significant hazard to the public or the environment through reasonably foreseeable upset and accident conditions involving the release of hazardous materials into the environment?*

The FEIR concluded that with adherence to local, state, and federal regulations and the requirements of the Occupational Safety and Health Administration, impacts from short-term construction of the desalination plant site were determined to be less than significant. During operation, hazardous materials would be stored in appropriate tanks made of non-reactive materials. Water treatment chemical tanks would be stored within concrete block enclosures to contain any potential release of materials. Requirements for storage, inspection, tanks, concrete enclosures, safety programs, and containment protocols provided as mitigation measures would ensure that impacts would remain at a less than significant level.

Construction of the proposed modifications would require additional, but similar, excavation activities as those analyzed for the desalination plant. The proposed modifications site was not identified as having contaminated soils that would be released into the environment upon excavation in the previously certified FEIR. However, the FEIR stated that there was the potential for release or exposure of subsurface contamination during construction at other parts of the desalination plant site and provided a mitigation measure to reduce this potential impact to less than significant. The proposed modifications would be subject to the same or equivalent mitigation measures identified in the FEIR, which would reduce potential impacts from the exposure of subsurface contamination during construction. Therefore, impacts from the proposed modifications would be less than significant with the incorporation of mitigation measures, consistent with the previously certified FEIR. No changes to the FEIR are necessary and this issue will not be evaluated in the SEIR.

- c) *Would the project emit hazardous emissions or handle hazardous or acutely hazardous materials, substances, or waste within one-quarter mile of an existing or proposed school?*

The FEIR states that the desalination plant site does not lie within one-quarter mile of an existing or proposed school; and therefore, no impact were determined to occur.

No school lies within one-quarter mile of the proposed modifications site. Therefore, there are no substantial changes that would require major revisions of the previous environmental documents, no substantial changes with respect to the circumstances under which the project is undertaken, and no new information of substantial importance with

Initial Study for the Carlsbad Seawater Desalination Plant Intake and Discharge Facility Modifications

regards to hazardous impacts to schools. No impact would occur from the proposed modifications, consistent with the previously certified FEIR. No changes to the FEIR are necessary and this issue will not be evaluated in the SEIR.

- d) Would the project be located on a site that is included on a list of hazardous materials sites compiled pursuant to Government Code Section 65962.5 and, as a result, would it create a significant hazard to the public or the environment?***

Utilizing an Environmental Database Search (consisting of local, county, state, and federal databases), the FEIR concluded that no hazardous materials sites lie within 0.25 mile of the desalination plant site. Therefore, it was determined that impacts would be less than significant.

The proposed modifications site is within the area for which the previous hazardous materials search was conducted in the FEIR. Therefore, there are no changes that would require revisions of the previous environmental documents, no changes with respect to the circumstances under which the project is undertaken, and no new information of importance with regards to impacts from hazardous materials sites. The records search conducted for the previously certified FEIR concluded that no hazardous materials sites lie within 0.25 miles of desalination plant. Further, sites identified in the previously certified FEIR are not in proximity to the proposed modifications site. Therefore, impacts from the proposed modifications would be less than significant, consistent with the previously certified FEIR. No changes to the FEIR are necessary and this issue will not be evaluated in the SEIR.

- e) For a project located within an airport land use plan or, where such a plan has not been adopted, within two miles of a public airport or public use airport, would the project result in a safety hazard for people residing or working in the project area?***

The FEIR determined that no portion of the desalination plant site is location within the influence area of the McClellan-Palomar Airport, as defined by the McClellan-Palomar Airport Land Use Compatibility Plan. As a result, the FEIR determined that impacts would be less than significant.

The proposed structures would be contained within the desalination plant site. Therefore, there are no changes that would require revisions of the previous environmental documents, no changes with respect to the circumstances under which the project is undertaken, and no new information of importance with regards to airport safety hazards. McClellan-Palomar Airport is located approximately 2.8 miles west of the project site. According to the

Initial Study for the Carlsbad Seawater Desalination Plant Intake and Discharge Facility Modifications

Revised Draft McClellan-Palomar Airport Land Use Compatibility Plan, the proposed modifications site is located outside Review Area 2, and therefore is not subject to airport policies, including safety compatibility (San Diego Regional Airport Authority 2010). Therefore, no impacts would occur, consistent with the previously certified FEIR. No changes to the FEIR are necessary and this issue will not be evaluated in the SEIR.

f) *For a project within the vicinity of a private airstrip, would the project result in a safety hazard for people residing or working in the project area?*

The FEIR did not analyze impacts from private airstrips, only impacts from the McClellan-Palomar Airport, as no portion of the desalination plant site lies within an airport influence area for private airstrips.

The proposed modifications site is not within the vicinity of a private airstrip and the proposed modifications would be entirely contained on the desalination plant site. There would be no impacts from the proposed modifications, consistent with the previously certified FEIR. No changes to the FEIR are necessary and this issue will not be evaluated in the SEIR.

g) *Would the project impair implementation of or physically interfere with an adopted emergency response plan or emergency evacuation plan?*

The FEIR concluded that, with incorporation of the traffic control plan and adherence to applicable regulations as discussed in Section 4.10 of the FEIR, construction traffic would not significantly impact the City of Carlsbad Emergency Plan. Therefore, it was determined that impacts would be less than significant.

The proposed modifications would be constructed on land developed as part of the existing EPS. Additionally, the proposed modifications would not remove any emergency access routes on the desalination plant site. Therefore, there are no changes that would require revisions of the previous environmental documents, no changes with respect to the circumstances under which the project is undertaken, and no new information of importance with regards to conflicts with emergency response plans.

The proposed modifications location and general operational characteristics would not change from what was analyzed in the previously certified FEIR regarding emergency plans for the area. Further, construction traffic would be subject to the traffic control plan provided as a mitigation measure in the FEIR to ensure adequate safety and emergency access. Therefore, impacts from the proposed modifications would be less than significant,

Initial Study for the Carlsbad Seawater Desalination Plant Intake and Discharge Facility Modifications

consistent with the previously certified FEIR. No changes to the FEIR are necessary and this issue will not be evaluated in the SEIR.

- h) Would the project expose people or structures to a significant risk of loss, injury or death involving wildland fires, including where wildlands are adjacent to urbanized areas or where residences are intermixed with wildlands?*

The FEIR did not analyze wildfire hazard because the site is outside the wildland interface and only portions of off-site pipelines would be located in areas where there is potential for wildfire hazard.

The proposed modifications site is located within the boundaries of the EPS and part of the desalination plant in development. Therefore, there are no changes that would require revisions of the previous environmental documents, no changes with respect to the circumstances under which the project is undertaken, and no new information of importance with regards to impacts from wildfires.

The proposed modifications sites is located immediately south of Agua Hedionda Lagoon. As noted in the CalFire's map of *Very High Fire Hazard Severity Zones in LRA* for Carlsbad, the project site is classified as "Non-VHFHSZ" or Non-Very High Fire Hazard Severity Zones (CalFire 2009). No wildlands where wildfires have potential to occur are adjacent to the proposed modifications site. Therefore, no impacts would result from the proposed modifications, consistent with the previously certified FEIR. No changes to the FEIR are necessary and this issue will not be evaluated in the SEIR.

3.9 Hydrology and Water Quality

- a) Would the project violate any water quality standards or waste discharge requirements?*

The FEIR analyzed both short-term construction impacts and long-term operational impacts to water quality. As discussed in Section 3.7 above, construction of the desalination plant would expose underlying soils, increasing the potential for erosion. Through implementation of construction BMPs, preparation of a SWPPP, and development of a Storm Water Management Plan (SWMP), as provided within mitigation measures, impacts to water quality during construction were determined to be less than significant. For analysis of operational discharge impacts to ocean water quality, the FEIR utilized a hydrological modeling study. Discharge from the desalination plant would have less than significant impacts to salinity (including under the "historical

Initial Study for the Carlsbad Seawater Desalination Plant Intake and Discharge Facility Modifications

extreme” scenario), temperature, recirculation into Agua Hedionda Lagoon, sediment transport, chemical and metal transport, and surfing points.

Construction of the proposed modifications would be similar to construction of the desalination plant. Construction of the proposed modifications would require demolition, excavation, grading, which would expose soils and increase erosion potential. Additionally, material stockpiles, fuels, lubricants, and waste would be stored within the construction area. Under the proposed modifications, the Construction Activity Storm Water Permit and other permits obtained by the RWQCB would be changed due to the differences in construction activity as permitted under the FEIR. These changes are not expected to be substantial. Additionally, operations of the desalination plant that would alter water quality or waste discharge would not substantially change as a result of the proposed modifications, and discharge requirements established for the desalination plant that have been imposed by the RWQCB to protect receiving waters will be adhered to with the operation of the desalination plant’s modified intake and discharge facilities. Therefore, impacts from the proposed modifications would be less than significant, consistent with the previously certified FEIR. However, because of the introduction of modified intake and discharge components, minor revisions to the FEIR will be necessary and this issue will be included in the SEIR.

- b) Would the project substantially deplete groundwater supplies or interfere substantially with groundwater recharge such that there would be a net deficit in aquifer volume or a lowering of the local groundwater table level (i.e., the production rate of pre-existing nearby wells would drop to a level that would not support existing land uses or planned uses for which permits have been granted)?***

The FEIR identified that a groundwater table exists at an approximate depth of 20 to 29 feet below the desalination plant site and that the Water Quality Control Plan for the San Diego Basin does not include beneficial uses for the Agua Hedionda Watershed.

The proposed modifications would not utilize groundwater resources; and would only draw surface water from Agua Hedionda Lagoon. The proposed modifications would not result in a change in groundwater infiltration when compared to the analysis found within the FEIR or interfere with groundwater recharge. Therefore, no impacts would result from the proposed modifications, consistent with the previously certified FEIR. No changes to the FEIR are necessary and this issue will not be evaluated in the SEIR.

Initial Study for the Carlsbad Seawater Desalination Plant Intake and Discharge Facility Modifications

- c) *Would the project substantially alter the existing drainage pattern of the site or area, including through the alteration of the course of a stream or river, in a manner which would result in substantial erosion or siltation on- or off-site?*

The FEIR notes that the desalination plant site would increase the amount of impervious surface by 2.5 acres, altering the existing drainage pattern of the site. Through implementation of a SWMP and SWPPP to control for erosion, siltation, sedimentation, and contaminant runoff, as provided in mitigation measures, impacts were determined to be less than significant.

The proposed modifications would be within the currently developed and impervious area and would not alter the drainage pattern. As discussed in response (a) above, the proposed modifications would only increase erosion potential during construction, when bare soils are exposed. The proposed modifications would be required to implement BMPs and obtain a modification to Construction Activity Storm Water Permit issued for the desalination plant as analyzed and provided as mitigation in the FEIR. Therefore, impacts from the proposed modifications would be less than significant with the incorporation of mitigation measures, consistent with the previously certified FEIR. No changes to the FEIR are necessary and this issue will not be evaluated in the SEIR.

- d) *Would the project substantially alter the existing drainage pattern of the site or area, including through the alteration of the course of a stream or river, or substantially increase the rate or amount of surface runoff in a manner which would result in flooding on- or off-site?*

As discussed in response (c) above, the FEIR states that the desalination plant site would add 2.5 acres of impervious surface. As part of the desalination plant project, runoff from roof and parking areas would be captured for filtration in the plant and improvements to the stormwater conveyance system would route any additional flows into the ocean discharge channel. Additionally, during construction placement of materials and equipment that could potentially resulting in flooding on-site would only result in temporary impacts. Therefore, the desalination plant would not cause flooding and impacts were determined to be less than significant.

As discussed in response (c) above, the proposed modifications would not change the existing drainage pattern of the proposed modifications site. The proposed modifications site is covered by impervious hardscape and the existing EPS intake and discharge structures. The structure and paved areas would not substantially alter the current drainage pattern and would not alter the potential for flooding to occur. Therefore,

Initial Study for the Carlsbad Seawater Desalination Plant Intake and Discharge Facility Modifications

impacts from the proposed modifications would be less than significant, consistent with the previously certified FEIR. No changes to the FEIR are necessary and this issue will not be evaluated in the SEIR.

- e) ***Would the project create or contribute runoff water which would exceed the capacity of existing or planned stormwater drainage systems or provide substantial additional sources of polluted runoff?***

The FEIR determined that runoff from the desalination plant would either be captured for filtration or conveyed to the ocean discharge channel. The desalination plant included improvements to the stormwater conveyance system to ensure that impacts would be less than significant.

The amount of impervious land cover would be decreased as a result of the proposed modifications, which would not place additional demands on the existing drainage system. Therefore, there are no changes that would require revisions of the previous environmental documents, no changes with respect to the circumstances under which the project is undertaken, and no new information of importance with regards to creation of substantial amounts of runoff. The proposed intake and discharged modifications would not modify the current site drainage pattern. Therefore, impacts from the proposed modifications would be less than significant, consistent with the previously certified FEIR. No changes to the FEIR are necessary and this issue will not be evaluated in the SEIR.

- f) ***Would the project otherwise substantially degrade water quality?***

As discussed in response (a) above, the FEIR utilized a hydrology model study to determine that the desalination plant would not significantly impact salinity (including under the “historical extreme” scenario), temperature, recirculation into Agua Hedionda Lagoon, sediment transport, chemical and metal transport, and surfing points. Through implementation of BMPs, SWPPP, and SWMP, as provided in mitigation measures, impacts to water quality would be less than significant.

The proposed modifications would not substantially affect groundwater quality as described above. During construction, the proposed modifications would be held to the same BMP requirements as construction of the desalination plant as described in the previously certified FEIR. The proposed modifications would require a change to the Construction Activity Storm Water Permit obtained from the RWQCB for the construction of the desalination plant as analyzed under the FEIR. Operation of the desalination plant would not be substantially altered by the proposed modifications;

Initial Study for the Carlsbad Seawater Desalination Plant Intake and Discharge Facility Modifications

discharge requirements established for the desalination plant that have been imposed by the RWQCB to protect receiving waters will be adhered to with the operation of the desalination plant's modified intake and discharge facilities. Therefore, impacts from the proposed modifications would be less than significant, consistent with the previously certified FEIR. However, because of the introduction of modified intake and discharge components, minor revisions to the FEIR will be necessary and this issue will be included in the SEIR.

- g) ***Would the project place housing within a 100-year flood hazard area as mapped on a federal Flood Hazard Boundary or Flood Insurance Rate Map or other flood hazard delineation map?***

The FEIR noted that the desalination plant site is not located within a 100-year flood hazard area as defined by the Final Master EIR for the 1994 City of Carlsbad General Plan Update. Additionally, the desalination plant site is not within the Special Flood Hazard Area as defined by the 2003 City of Carlsbad Zoning Map [updated 2014 <http://web.carlsbadca.gov/services/departments/planning/Documents/zone1117.pdf>]. As a result, impacts were determined to be less than significant.

The proposed modifications are located within the desalination plant site and would not be within the 100-year flood zone boundary. Additionally, the proposed modifications would not involve the creation of any housing or structure for permanent residence. Therefore, impacts from the proposed modifications would be less than significant, consistent with the previously certified FEIR. No changes to the FEIR are necessary and this issue will not be evaluated in further detail in the SEIR.

- h) ***Would the project place within a 100-year flood hazard area structures which would impede or redirect flood flows?***

See response (g) above.

- i) ***Would the project expose people or structures to a significant risk of loss, injury or death involving flooding, including flooding as a result of the failure of a levee or dam?***

The FEIR did not directly provide a significance conclusion related to flooding due a dam or levee failure because the project is not downstream of a dam or levee that could affect the facility. However, as discussed in response (g) above, the FEIR noted that the desalination plant site is not located within a 100-year flood hazard area as defined by the Final Master EIR for the 1994 City of Carlsbad General Plan Update. Additionally, the

Initial Study for the Carlsbad Seawater Desalination Plant Intake and Discharge Facility Modifications

desalination plant site is not within the Special Flood Hazard Area as defined by the 2003 City of Carlsbad Zoning Map [updated 2014]. Impacts related to flooding hazards were determined to be less than significant. The proposed modifications site would not be located within a dam failure inundation zone (County of San Diego 2009).

The proposed modifications would be designed and constructed to avoid flooding and would not result in the long-term exposure of people to significant flooding hazards because no housing is included as part of the proposed modifications. Therefore, impacts from the proposed modifications would be less than significant, consistent with the previously certified FEIR. No changes to the FEIR are necessary and this issue will not be evaluated in the SEIR.

j) *Inundation by seiche, tsunami, or mudflow?*

The FEIR determined that there is low potential for damage resulting from a tsunami due to general geographic and seismic factors of the San Diego County Coastline. The desalination plant site was also determined to be at a high enough elevation relative to Agua Hedionda Lagoon for potential of inundation by seiche to be low. As a result, the FEIR determined that impacts would be less than significant.

The proposed modifications are not located in an area of steep topography that would be susceptible to inundation from a mudflow. The proposed modifications site is located in a tsunami inundation zone, specifically the portion within Agua Hedionda Lagoon (Cal EMA 2009). Therefore, there are changes that would require revisions of the previous environmental documents, changes with respect to the circumstances under which the project is undertaken, and new information of importance with regards to inundation by tsunami. However, the proposed modifications would not place housing or any buildings intended for occupancy within a tsunami inundation zone. Additionally, any proposed structures would be designed and constructed to reduce potential inundation by a tsunami. Therefore, impacts from the proposed modifications would be less than significant, consistent with the previously certified FEIR. No revisions to the FEIR are necessary and this issue will not be evaluated in the SEIR.

3.10 Land Use and Planning

a) *Would the project physically divide an established community?*

The FEIR determined that the desalination plant would not divide an established community. Through the approval of the EPS Precise Development Plan (PDP) and

Initial Study for the Carlsbad Seawater Desalination Plant Intake and Discharge Facility Modifications

compatibility with existing on-site uses, impacts were determined to be less than significant.

The proposed modifications would be located within the EPS property, which only contains existing public utility uses. Therefore, there are no changes that would require revisions of the previous environmental documents, no changes with respect to the circumstances under which the project is undertaken, and no new information of importance with regards to division of established communities. The proposed modifications would not eliminate any routes of transportation or movement within a community and would not physically divide any existing community. The proposed modifications would be incorporated in the EPS PDP by way of an Amendment in order to ensure land use and plan compatibility. Therefore, no impact would occur from the proposed modifications, consistent with the previously certified FEIR. However, because of the PDP Amendment, minor revisions to the FEIR will be necessary and this issue will be included in the SEIR.

- b) Would the project conflict with any applicable land use plan, policy, or regulation of an agency with jurisdiction over the project (including, but not limited to the general plan, specific plan, local coastal program, or zoning ordinance) adopted for the purpose of avoiding or mitigating an environmental effect?***

The FEIR determined that the PDP and desalination plant are consistent with the land use designations of the City of Carlsbad General Plan and Zoning Ordinance. The desalination plant would be consistent with the Public Utilities land use designation and would adhere to the Scenic Corridor Guidelines along Carlsbad Boulevard and the AT&SF/NCTD rail corridor, Specific Plan 144, the Local Coastal Program and Agua Hedionda Land Use Plan, the South Carlsbad Coast Redevelopment Plan, and the McClellan-Palomar Airport Land Use Compatibility Plan. However to avoid any potential hazards during construction, mitigation was included to coordinate with the Operations Manager of McClellan Airport. As such, the FEIR determined that impacts would be less than significant with the incorporation of mitigation.

The proposed modifications would modify the intake and discharge, but would not change any aspect of the existing or proposed use of the desalination plant site for seawater intake that was analyzed under the previous environmental documents. This proposed use would be compatible use under the General Plan Land Use designation of Utility, and Zoning designation of Public Utility. Therefore, there are no changes that would require revisions of the previous environmental documents, no changes with respect to the circumstances under which the project is undertaken, and no new information of

Initial Study for the Carlsbad Seawater Desalination Plant Intake and Discharge Facility Modifications

importance with regards to conflicts with applicable land use plans. While the proposed modification do not include any tall facilities, in keeping with the general construction program for the CDP, the mitigation for coordination with the Operations Manager of the McClellan Airport will be implemented. Therefore, impacts from the proposed modifications would be less than significant with the incorporation of mitigation, consistent with the previously certified FEIR. However, because of the PDP Amendment, minor revisions to the FEIR will be necessary and this issue will be included in the SEIR.

c) ***Would the project conflict with any applicable habitat conservation plan or natural community conservation plan?***

See Section 3.4 above. The FEIR determined that the desalination plant would be consistent with the San Diego County Multiple Habitat Conservation Program, Carlsbad HMP, the Oceanside Subarea Plan, and the Comprehensive Open Space and Conservation Resource Management Plan. As a result, the FEIR concluded that impacts would be less than significant.

The proposed modifications would be located within the existing desalination plant site and the developed boundary of EPS. While widening the intake at Agua Hedionda Lagoon would disturb some plant species, it would only remove non-sensitive or landscape plantings. Therefore, there are no changes that would require revisions of the previous environmental documents, no changes with respect to the circumstances under which the project is undertaken, and no new information of importance with regards to conflicts with applicable habitat conservations plans. As noted in the previously certified FEIR, the on-site portions of the desalination plant would not include hardline preserve areas identified in the City of Carlsbad HMP and thus, would not conflict with the City of Carlsbad HMP. Therefore, impacts from the proposed modifications would be less than significant, consistent with the previously certified FEIR. However, because of the introduction of modified intake and discharge components, minor revisions to the FEIR will be necessary and this issue will be included in the SEIR.

3.11 Mineral Resources

a) ***Would the project result in the loss of availability of a known mineral resource that would be of value to the region and the residents of the state?***

The FEIR states that the desalination plant site is located within a Mineral Resource Zone 3 (MRZ-3), which includes areas where the significance of mineral deposits is unknown with present information. Additionally, the desalination plant site has not been delineated

Initial Study for the Carlsbad Seawater Desalination Plant Intake and Discharge Facility Modifications

as an important mineral resource recovery site within the City of Carlsbad's General Plan. The site-specific geotechnical investigation for the desalination plant site did not reveal the presence of important mineral resources. Therefore, impacts related to the loss of availability of a known mineral resource that would be of future value to the region and the residents of the State were determined to be less than significant.

The proposed modifications is located within the boundaries of EPS and the desalination plant in development. No new information regarding mineral resources is available that would alter the analysis found in the previously certified FEIR. The proposed modifications site is classified by the state and local plans as an MRZ-3, which includes areas where the significance of mineral deposits is unknown with present information (Miller 1996). The proposed modifications site is not designated as having an important mineral resource by any local plans. The City's Open Space, Conservation, and Recreation Element of the Draft General Plan does not specify the proposed modifications site as an area for managed resource use or identify any locations of mineral resources within the City limits (City of Carlsbad 2014). Therefore, impacts from the proposed modifications would be less than significant, consistent with the previously certified FEIR. No changes to the FEIR are necessary and this issue will not be evaluated in the SEIR.

- b) Would the project result in the loss of availability of a locally important mineral resource recovery site delineated on a local general plan, specific plan, or other land use plan?*

See response (a) above.

3.12 Noise

- a) Would the project result in exposure of persons to or generation of noise levels in excess of standards established in the local general plan or noise ordinance, or applicable standards of other agencies?*

The FEIR analyzed both short-term construction impacts and long-term operational impacts to noise levels. During construction, the FEIR determined that less than significant impacts would occur due to: (1) worst case scenario construction traffic noise levels would not exceed the applicable noise significance thresholds, (2) construction equipment noise would be approximately 70 decibels (dB) or less at the nearest residence, and (3) construction would only occur during permitted hours within the City

Initial Study for the Carlsbad Seawater Desalination Plant Intake and Discharge Facility Modifications

of Carlsbad. During operation, the FEIR determined that less than significant impacts would occur due to noise attenuation from intervening structures and on-site structures.

The proposed modifications would utilize low-impact pumps that may increase noise levels relative to the current EPS intake structure.

The closest residences would be located approximately 450 feet or more from the closest onsite ancillary facility construction area and more than approximately 1,800 feet from the proposed desalination plant. All construction activity will be limited to the City of Carlsbad's permitted hours of construction. As such, impacts from onsite construction activities would be less than significant since the impact would occur only during permitted construction hours and would represent only a minor temporary increase in noise levels in the project vicinity.

Operational noise levels would not be increased as a result of operations as the pumps proposed would be enclosed within a building and located over 450 feet from the nearest sensitive receptor. Additionally, there would be intervening topography that would block the line-of-sight to the nearest residences. Therefore, the proposed modifications would result in less than significant impacts, consistent with the previously certified FEIR. No changes to the FEIR are necessary and this issue will not be evaluated in the SEIR.

b) Would the project result in exposure of persons to or generation of excessive groundborne vibration or groundborne noise levels?

The FEIR concluded that construction of the desalination plant would potentially generated groundborne vibration; however, impacts were determined to be less than significant because construction activities would not occur in proximity of sensitive receptors or structures.

The proposed modifications would require construction in an area not previously analyzed for groundborne vibration potential and may substantially affect nearby sensitive uses. Additionally, low-impact pump operation could result in groundborne vibration beyond the current EPS intake structure.

Excavation, piling, and heavy grading during the potential widening of the intake area may result in a small amount of localized ground-borne vibration and/or noise associated with heavy equipment use. However, construction would not necessitate the use of blasting; therefore, any ground-borne vibration and/or ground-borne noise would be minimal and highly localized. As previously stated, the closest residences would be located approximately 450 feet or more from the closest onsite ancillary facility

Initial Study for the Carlsbad Seawater Desalination Plant Intake and Discharge Facility Modifications

construction area and more than approximately 1,800 feet from the proposed desalination plant. The site is separated from residences by intervening topography, which would ensure that minor levels of vibration and/or ground-borne noise from construction would dissipate before reaching residents.

Operational groundborne vibration could result from the operation of the proposed pumps, but would be localized to the proposed modifications site and would not affect the nearest sensitive receptors. Therefore, the proposed modifications would result in less than significant impacts, consistent with the previously certified FEIR. No changes to the FEIR are necessary and this issue will not be evaluated in the SEIR.

c) *Would the project result in a substantial permanent increase in ambient noise levels in the project vicinity above levels existing without the project?*

The FEIR analyzes operational noise levels for on-site facilities including the intake pump station, pretreatment filter structure, product water pump station, membrane cleaning system, chemical feed equipment, service facilities, solids handling equipment, and the reverse osmosis process area. The FEIR determined that with the inclusion of noise attenuation provided by intervening structures as well as the proposed on-site structures the noise level would be less than approximately 35 dB Community Noise Equivalent Level (CNEL) at the closest residential property. Additionally, the FEIR determined that the worst-case scenario of daily operational worker truck trips (120) would not contribute substantially to a permanent ambient noise level increase. As a result, the FEIR determined that impacts would be less than significant.

The noise level increase from the operation of the proposed pumps is expected to be minimal at the nearest sensitive receptor and would not represent a substantial permanent increase in the existing ambient noise level. Additionally, the proposed modifications would not increase the number of daily workers that could increase ambient noise levels resulting from vehicle trips to and from the site. Therefore, the proposed modifications would result in less than significant impacts, consistent with the previously certified FEIR. No changes to the FEIR are necessary and this issue will not be evaluated in the SEIR.

d) *Would the project result in a substantial temporary or periodic increase in ambient noise levels in the project vicinity above levels existing without the project?*

See response (a) above. During construction, the FEIR determined that less than significant impacts would occur due to: (1) worst case scenario construction traffic noise

Initial Study for the Carlsbad Seawater Desalination Plant Intake and Discharge Facility Modifications

levels would not exceed the applicable noise significance thresholds, (2) construction equipment noise would be approximately 70 decibels (dB) or less at the nearest residence, and (3) construction would only occur during permitted hours within the City of Carlsbad.

Although specific construction details and equipment fleet specifications of the proposed modifications are not available at this time, construction would be expected to temporarily increase ambient noise levels in the vicinity of the proposed modifications site.

Construction equipment anticipated for development of the proposed modifications includes standard equipment that would be employed for any routine construction project of this scale including tractors/backhoes, trenchers, paving equipment, loaders, graders, cranes, off-highway trucks, and other pieces of heavy construction equipment. The use of construction equipment with substantially higher noise and vibration generation characteristics (such as pile drivers, rock drills, blasting equipment, etc.) is not anticipated for development of the proposed modifications. Construction noise is difficult to quantify because of the many variables involved, including the size of equipment used, percentage of time, and number of pieces of equipment that will actually operate on the site. However, maximum construction noise levels at 50 feet would typically range from approximately 75 to 85 dB for the type of equipment anticipated to be used for construction of the proposed project. The range of maximum noise levels associated with various pieces of construction equipment is depicted in Table 2.

**Table 2
Construction Equipment Noise Emission Levels**

Equipment	Typical Sound Level (dB) 50 Feet from Source
Air compressor	81
Backhoe	80
Compactor	82
Concrete mixer	85
Concrete pump	82
Concrete vibrator	76
Crane, derrick	88
Crane, mobile	83
Dozer	85
Generator	81
Grader	85
Impact wrench	85

Initial Study for the Carlsbad Seawater Desalination Plant Intake and Discharge Facility Modifications

Table 2
Construction Equipment Noise Emission Levels

Equipment	Typical Sound Level (dB) 50 Feet from Source
Jackhammer	88
Loader	85
Paver	89
Pile-driver (impact)	101
Pile-driver (sonic)	96
Pneumatic tool	85
Pump	76
Rail saw	90
Rock drill	98
Roller	74
Saw	76
Scraper	89
Truck	88

Source: FTA 2006.

The closest residences would be located approximately 450 feet or more from the closest onsite ancillary facility construction area and more than approximately 1,800 feet from the proposed modifications. Based on the construction equipment and distance to the closest residences, the construction noise is anticipated to generate maximum noise levels of up to approximately 67 dB at the nearest adjacent residences. This noise level could intermittently occur for a few days when construction equipment is operating immediately adjacent to the residential properties. All construction activity will be limited to the City of Carlsbad’s permitted hours of construction. Therefore, the proposed modifications would result in less than significant impacts, consistent with the previously certified FEIR. No changes to the FEIR are necessary and this issue will not be evaluated in the SEIR.

- e) ***Would the project be located within an airport land use plan or, where such a plan has not been adopted, within two miles of a public airport or public use airport, would the project expose people residing or working in the project area to excessive noise levels?***

The FEIR determined that the desalination plant site is not within the airport influence area of McClellan-Palomar Airport. As a result, the FEIR determined that impacts would be less than significant.

The proposed modifications are not located within an airport land use plan or within two miles of a public airport. According to the *Revised Draft McClellan-Palomar Airport*

Initial Study for the Carlsbad Seawater Desalination Plant Intake and Discharge Facility Modifications

Land Use Compatibility Plan, the proposed modifications site is located outside Review Area 2, and therefore is not subject to airport policies, including noise contours (San Diego Regional Airport Authority 2010). Therefore, no impacts would result from the proposed modifications, consistent with the previously certified FEIR. No changes to the FEIR are necessary and this issue will not be evaluated in the SEIR.

- f) ***Would the project be within the vicinity of a private airstrip, would the project expose people residing or working in the project area to excessive noise levels?***

The FEIR does not identify or discuss impacts related to private airstrips. As such, the FEIR does not provide a direct significance conclusion related to this threshold. However, as discussed in response (e), the desalination plant site is not located within the influence area of McClellan-Palomar Airport.

The proposed modifications are not located within the vicinity of a private air strip. Therefore, there are no changes that would require revisions of the previous environmental documents, no changes with respect to the circumstances under which the project is undertaken, and no new information of importance concerning the exposure of persons to excessive noise levels. No impacts would result from the proposed modifications, consistent with the previously certified FEIR. No changes to the FEIR are necessary and this issue will not be evaluated in the SEIR.

3.13 Population and Housing

- a) ***Would the project induce substantial population growth in an area, either directly (for example, by proposing new homes and businesses) or indirectly (for example, through extension of roads or other infrastructure)?***

The FEIR analyzed population impacts within Section 9.0, Growth Inducing Impacts, of the FEIR. Within Section 9.0 of the FEIR, the analysis relied upon population growth limited by buildable land, infrastructure, and planning and development processes. Additionally, the Water Authority utilizes SANDAG's most current population growth forecasts to properly plan for water supply. Through analysis of local and regional water supply management plans, including the Regional Water Facilities Master Plan and the City's Urban Water Management Plan, the FEIR determined that the desalination plant would not induce substantial population growth on a local level.

The previously certified FEIR analyzed the existing water supplies, regional water demand and growth projections, and the urban water management plans in Section 9.0, Growth Inducing Impacts, and determined that desalinated seawater is already considered

Initial Study for the Carlsbad Seawater Desalination Plant Intake and Discharge Facility Modifications

in regional growth analyses and that the annual average 50 mgd supply of water would not result in a substantial effect on growth. The potential for efficiencies from the updated technologies could result in increased water availability to the Water Authority, but would similarly not result in excess of water supply or result in substantial population growth. Therefore, impacts from the proposed modifications would be less than significant, consistent with the FEIR. However, because the modifications could potentially realize increased efficiency, minor revisions to the FEIR will be necessary and this issue will be included in the SEIR under the discussion of growth inducement, as with the previously certified FEIR.

b) *Would the project displace substantial numbers of existing housing, necessitating the construction of replacement housing elsewhere?*

Section 4.8, Land Use, of FEIR, states that the desalination plant site would be located on a site designation as Public Utilities with existing land uses related to the EPS. The desalination plant site does not include housing.

The proposed modifications site does not currently support housing, nor would any adjacent existing housing be displaced, similar to that analyzed within the FEIR. The proposed modifications would not add any housing or residential developments. Therefore, no impacts would result from the proposed modifications, consistent with the previously certified FEIR. No changes to the FEIR are necessary and this issue will not be evaluated in the SEIR.

c) *Would the project displace substantial numbers of people, necessitating the construction of replacement housing elsewhere?*

As stated in response (a) above, Section 4.8, Land Use, of FEIR, states that the desalination plant site would be located on a site designation as Public Utilities with existing land uses related to the EPS. The desalination plant site does not include housing.

The proposed modifications would not displace substantial numbers of people as the project site is currently developed for industrial uses and would not change these uses or result in the demolition of any housing, similar to that analyzed within the FEIR. No impacts would result from the proposed modifications, consistent with the previously certified FEIR. No changes in the FEIR are necessary and this issue will not be evaluated in the SEIR.

Initial Study for the Carlsbad Seawater Desalination Plant Intake and Discharge Facility Modifications

3.14 Public Services

- a) *Would the project result in substantial adverse physical impacts associated with the provision of new or physically altered governmental facilities, need for new or physically altered governmental facilities, the construction of which could cause significant environmental impacts, in order to maintain acceptable service ratios, response times, or other performance objectives for any of the public services:*

Fire protection?

The FEIR concluded that the desalination plant would have less than significant impacts to fire protection services though compliance with all of the standards and design requirements of the Carlsbad Fire Department.

Operational characteristics of desalination plant that would affect public services would not substantially change because of the proposed modifications. Due to this, no change in the analysis or conclusions of the previously certified FEIR would occur. The proposed modifications would also be required to comply with all of the standards and design requirements of the Carlsbad Fire Department, similar to the analysis within the FEIR. Therefore, impacts as a result of the proposed modifications would be less than significant, consistent with the previously certified FEIR. No changes to the FEIR would be necessary and this issue will not be evaluated in the SEIR.

Police protection?

The FEIR concluded that the desalination plant would have less than significant impacts to police protection services due to minimal demand for police protection and on-site security.

The proposed modifications would not alter the analysis and conclusions found in the previously certified FEIR with regard to police services. The addition of the proposed modifications would not substantially increase demand for police services and would also be monitored by CDP staff 24 hours per day, similar to the analysis within the FEIR. Therefore, impacts from the proposed modifications would be less than significant, consistent with the previously certified FEIR. No changes to the FEIR are necessary and this issue will not be evaluated in the SEIR.

Initial Study for the Carlsbad Seawater Desalination Plant Intake and Discharge Facility Modifications

Schools?

Section 9.0, Growth Inducing Impacts, of the FEIR, determined that the desalination plant would not induce substantial population growth. Therefore, the desalination plant would not create substantial demand for schools.

The proposed modifications would not result in additional staffing needs, nor would it introduce a new student population to the area. No change from the analysis and conclusions of the previous environmental documents would occur. Impacts from the proposed modifications would be less than significant, consistent with the previously certified FEIR. No changes to the FEIR are necessary and this issue will not be evaluated in the SEIR.

Parks?

The FEIR noted that construction of the desalination plant would not interfere with the nearby Cannon Park. Additionally, the desalination plant would not generate substantial additional population, and therefore would not create substantial demand for recreational facilities or services. Further, the PDP includes measures to enhance nearby local recreational areas. Therefore, the FEIR concluded that the desalination plant would have less than significant impacts to parks.

The proposed modifications would not introduce a population that would increase the demand for parkland, similar to that analyzed within the FEIR. No change from the analysis and conclusions of the previous environmental documents would occur. Impacts from the proposed modifications would be less than significant, consistent with the previously certified FEIR. No changes to the FEIR are necessary and this issue will not be evaluated in the SEIR.

Other public facilities?

In general, the FEIR concluded that the desalination plant, in both construction and operation, would have less than significant impacts to public facilities.

The proposed modifications would not substantially alter the operations of the desalination plant. No changes to the analysis or conclusions of the previously certified FEIR would occur and all impacts to public services and facilities would be less than significant. Impacts from the proposed modifications would be less than significant, consistent with the previously certified FEIR. No changes to the FEIR are necessary and this issue will not be evaluated in the SEIR.

Initial Study for the Carlsbad Seawater Desalination Plant Intake and Discharge Facility Modifications

3.15 Recreation

- a) *Would the project increase the use of existing neighborhood and regional parks or other recreational facilities such that substantial physical deterioration of the facility would occur or be accelerated?*

The FEIR concluded that the desalination plant would have less than significant impacts to parks and recreation because it would not create a substantial increase in demand.

The proposed modifications would not introduce an increase in parkland or recreational facilities demand, similar to findings of the analysis in the FEIR. Operation of the desalination plant would not be substantially altered due to the proposed modifications, and would not require the need for additional staffing. Impacts from the proposed modifications would be less than significant, consistent with the previously certified FEIR. No changes to the FEIR are necessary and this issue will not be evaluated in the SEIR.

- b) *Does the project include recreational facilities or require the construction or expansion of recreational facilities, which might have an adverse physical effect on the environment?*

The FEIR discusses that the approval of the desalination plant includes adoption of the PDP. The PDP include enhancement of specific parks and recreation areas, including, Fishing Beach, Bluff Area, Hubbs Site, and South Power Plant public parking area. Impacts of related to these facilities would be analyzed as part of the approval of the PDP. The FEIR concluded that impacts would be less than significant.

Operation of the desalination plant would not be substantially altered due to the proposed modifications, and would not require the need for additional staffing. No impact would occur from the proposed modifications, consistent with the previously certified FEIR. No changes to the FEIR are necessary and this issue will not be evaluated in the SEIR.

Initial Study for the Carlsbad Seawater Desalination Plant Intake and Discharge Facility Modifications

3.16 Transportation and Traffic

- a) *Would the project conflict with an applicable plan, ordinance or policy establishing measures of effectiveness for the performance of the circulation system, taking into account all modes of transportation including mass transit and non-motorized travel and relevant components of the circulation system, including but not limited to intersections, streets, highways and freeways, pedestrian and bicycle paths, and mass transit?*

The FEIR analyzed both short-term construction impacts and long-term operational impacts. During construction, the FEIR determined that the most traffic intensive phase of construction for the facility, represented by the simultaneous construction of improvements identified in stages 2 and 3, could result in the addition of a maximum of 78 trips per day on Carlsbad Boulevard, Cannon Road, Interstate 5 (I-5), Faraday Avenue, El Camino Real and Palomar Airport Road. The addition of a temporary amount of 78 trips (worst case scenario) would have less than significant impacts with mitigation incorporated (traffic control plan). During operation, the FEIR determined that the maximum trips expected to occur if all operational activities were to occur one the same day (worst case scenario) is 120 daily trips on I-5, Cannon Road, and Carlsbad Boulevard. The FEIR concluded that the addition of 120 daily trips would not substantially impact the surrounding circulation network and impacts would be less than significant. The desalination plant site does not encroach upon the nearby rail facilities and would not disrupt service, therefore impacts to mass transit would be less than significant. As part of the traffic control plan mitigation measure, bicycle and pedestrian facilities would be managed to ensure safety and minimal disruption of service. Further, all construction of the desalination plant site would occur within the EPS site. As a result, the FEIR determined that impacts would be less than significant.

The proposed modifications would not result in additional workers at the desalination plant and construction related traffic would be temporary and are not expected to be substantial due to the limited size and schedule for construction related activities. Additionally, construction activities would be confined to the EPS site location, and would not utilize public roadways for construction, as with the offsite water delivery pipelines. Construction traffic due to the proposed modifications would be required to adhere to the approved traffic control plan provided as mitigation within the FEIR to ensure minimal disruption to the level of service of nearby roadways. Therefore, impacts from the proposed modifications would be less than significant with the incorporation of mitigation, consistent with the previously certified FEIR. No changes to the FEIR are necessary and this issue will not be evaluated in the SEIR.

Initial Study for the Carlsbad Seawater Desalination Plant Intake and Discharge Facility Modifications

- b) *Would the project conflict with an applicable congestion management program, including, but not limited to level of service standards and travel demand measures, or other standards established by the county congestion management agency for designated roads or highways?*

See the FEIR summary of impacts in response (a) above. The FEIR concluded that construction traffic and activity would potentially affect road right-of-ways resulting in a potentially significant impact to congestion management. Mitigation in the form of a traffic control plan would ensure safety and adequate circulation of the affected roadways. Further, all construction of the desalination plant site would occur within the EPS site. Therefore, the FEIR concluded that impacts would be less than significant.

As previously stated, the proposed modifications would not result in additional workers at the desalination plant and construction related traffic would be temporary and are not expected to be substantial due to the limited size and schedule for construction related activities. Construction traffic due to the proposed modifications would be required to adhere to the approved traffic control plan provided at mitigation within the FEIR to ensure minimal disruption to the level of service of nearby roadways. As such, impacts from the proposed modifications would be less than significant with incorporation of mitigation, consistent with the previously certified FEIR. No change to the FEIR are necessary and this issue will not be evaluated in further detail in the SEIR.

- c) *Would the project result in a change in air traffic patterns, including either an increase in traffic levels or a change in location that results in substantial safety risks?*

The FEIR determined that the desalination plant site is not within the airport influence area of McClellan-Palomar Airport as defined by the McClellan-Palomar Airport Land Use Compatibility Plan. As a result, the FEIR determined that impacts would be less than significant.

The proposed modifications do not include any aviation components. According to the *Revised Draft McClellan-Palomar Airport Land Use Compatibility Plan*, the proposed modifications site is located outside Review Area 2, and therefore is not subject to airport policies, including safety compatibility and overflight regulations (San Diego Regional Airport Authority 2010). As such, the proposed modifications would not result in a change of air traffic patterns or result in substantial safety risks. Therefore, impacts would be less than significant as a result of the proposed modifications, consistent with the previously certified FEIR. No changes to the FEIR are necessary and this issue will not be evaluated in the SEIR.

Initial Study for the Carlsbad Seawater Desalination Plant Intake and Discharge Facility Modifications

- d) *Would the project substantially increase hazards due to a design feature (e.g., sharp curves or dangerous intersections) or incompatible uses (e.g., farm equipment)?*

The FEIR does not directly analyze design features that could potentially increase hazards; therefore, it does not directly provide a significance conclusion. However, the desalination plant site does not propose new public roadways or intersections; all on-site traffic would consist of employees or deliveries. Construction could potentially result in hazards to motorists, bicyclists, and pedestrians. However, a traffic control plan provided as a mitigation measure would ensure safety for both construction workers and people utilizing roadways, sidewalks, and bicycle lanes. Further, all construction of the desalination plant site would occur within the EPS site. Therefore, impacts related to safety hazards during construction were determined to be less than significant.

The proposed modifications would not include any design features that would substantially increase hazards and would be compatible with the existing public utility uses. Construction traffic due to the proposed modifications would be required to adhere to the approved traffic control plan provided at mitigation within the FEIR to ensure safety of workers and users of affect portions of the transportation system. As such, less than significant impacts would result from the proposed modifications with the incorporation of mitigation, consistent with the previously certified FEIR. No changes to the FEIR are necessary and this issue will not be evaluated in the SEIR.

- e) *Would the project result in inadequate emergency access?*

The FEIR concluded that construction of the desalination plant would have less than significant impacts to emergency access because no roadway closures would be required. However, as mitigation, a traffic control plan will be approved that will include coordination with emergency services to ensure that emergency access is maintained or alternate access is coordinated. The FEIR concluded that impacts would be less than significant with incorporation of this mitigation measure.

During construction, workers would use local roadways to access the proposed modifications site and could substantially affect access due to the potential for construction overlap with the construction of the Carlsbad Energy Center Project (CECP).

Construction traffic due to the proposed modifications would be required to adhere to the approved traffic control plan provided at mitigation within the FEIR to ensure adequate emergency access within the site and along the surrounding roadway network. However,

Initial Study for the Carlsbad Seawater Desalination Plant Intake and Discharge Facility Modifications

the proposed modifications would not be located within or directly adjacent to the construction area for the CECP, which would reduce the potential for conflicts with construction of the CECP resulting in inadequate emergency access. Therefore, impacts from the proposed modifications would be less than significant with incorporation of mitigation, consistent with the previously certified FEIR. No changes to the FEIR are necessary and this issue will not be evaluated in the SEIR.

f) Would the project conflict with adopted policies, plans, or programs regarding public transit, bicycle, or pedestrian facilities, or otherwise decrease the performance or safety of such facilities?

The FEIR concluded that construction of the desalination plant would occur entirely within the EPS site. Therefore, it would not require the closure of any transportation facility outside the site. However, as mitigation, a traffic control plan will be approved to ensure that the performance and safety of transit, bicycle, and pedestrian facilities are not substantially affected. As such, the FEIR determined that impacts would be less than significant.

The proposed modifications would add temporary vehicle trips to local roadways during construction. The proposed modifications would not alter or conflict with public transit, bicycle, or pedestrian facilities. During construction, workers would use local roadways to access the project site and would not substantially increase traffic on these roadways. Construction traffic due to the proposed modifications would be required to adhere to the approved traffic control plan provided at mitigation within the FEIR to ensure minimal disruption to the level of service of nearby roadways. Therefore, the proposed modifications would result in less than significant impacts with incorporation of mitigation, consistent with the previously certified FEIR. No changes to the FEIR are necessary and this issue will not be evaluated in the SEIR.

3.17 Utilities and Service Systems

a) Would the project exceed wastewater treatment requirements of the applicable Regional Water Quality Control Board?

According to the FEIR, the wastewater generated by the desalination plant would be treated at the Encina Water Pollution Control Facility (EWPCF). The desalination plant would be required to comply with applicable discharge limits and pretreatment requirements of the EWPCF. The FEIR analyzed wastewater conditions with two scenarios: (1) without membrane pretreatment and (2) with membrane pretreatment. The

Initial Study for the Carlsbad Seawater Desalination Plant Intake and Discharge Facility Modifications

FEIR concluded that if the desalination plant operates without membrane pretreatment, the total dissolved solids (TDS) conditions would have a less than significant impact on wastewater systems. However, if the desalination plant should select membrane pretreatment, then a permanent increase in TDS would occur and the wastewater system would be significantly impacted. Mitigation provided in the FEIR was determined to reduce impacts to a less than significant level.

The proposed modifications would not alter the general operations of desalination plant. However, the discharge method for the desalination plant would be altered under the proposed modifications. The intake and discharge modifications would employ alternative technologies design to be reduce effects to the marine environment consistent with RWQCB permitting requirements. The FEIR contemplated the introduction of improved membrane technologies and the proposed modifications would implement best available technologies (BAT) resulting in a reduction of impacts than those identified in the FEIR. No changes to the FEIR are necessary and this issue will not be evaluated in the SEIR.

b) Would the project require or result in the construction of new water or wastewater treatment facilities or expansion of existing facilities, the construction of which could cause significant environmental effects?

The FEIR concluded that the desalination plant would not require or result in the construction of new wastewater facilities or expansion of existing facilities that could cause significant environmental impacts. The City of Carlsbad has determined that it does have sufficient capacity to meet the project's demands in consideration of existing commitments. The desalination plant is a new water treatment facility and its environmental effects were analyzed throughout the FEIR. The FEIR also utilized a surge modeling study to determine potential impacts to the water delivery system. Desalination plant pumping facilities would be designed in a manner to minimize the potential for a surge on the water delivery system to occur. As a result, the FEIR determined that impacts would be less than significant.

The desalination process includes treatment of the product water and dilution of the discharge water; however, these processes would not be changed by the proposed modifications and were analyzed in the previously certified FEIR. Therefore, there are no changes that would require revisions of the previous environmental documents, no changes with respect to the circumstances under which the project is undertaken, and no new information of importance with regards to construction of a portion of a water treatment facility. The proposed intake alterations and systems would not substantially change the general operation of the desalination plant. All environmental effects for desalination

Initial Study for the Carlsbad Seawater Desalination Plant Intake and Discharge Facility Modifications

plant were also analyzed in the previously certified FEIR. As a result, impacts from the proposed modifications would be less than significant, consistent with the previously certified FEIR. No changes to the FEIR are necessary and this issue will not be evaluated in the SEIR.

- c) *Would the project require or result in the construction of new storm water drainage facilities or expansion of existing facilities, the construction of which could cause significant environmental effects?*

The FEIR states that the desalination plant site would add 2.5 acres of impervious surface, increasing runoff flows. As part of the desalination plant project, runoff from roof and parking areas would be captured for filtration in the plant and improvements to the stormwater conveyance system would route any additional flows into the ocean discharge channel. The FEIR concluded that the runoff from the desalination plant site would be adequately served by existing facilities. As such, the FEIR determined that impacts would be less than significant.

The proposed modifications would reduce the amount of impervious surface or increase stormwater runoff from the site by creating additional open water area through the widening of the Agua Hedionda Lagoon intake. Therefore, there are no changes that would require revisions of the previous environmental documents, no changes with respect to the circumstances under which the project is undertaken, and no new information of importance with regards to site drainage. Impacts from the proposed modifications would be less than significant, consistent with the previously certified FEIR. No changes to the FEIR are necessary and this issue will not be evaluated in the SEIR.

- d) *Would the project have sufficient water supplies available to serve the project from existing entitlements and resources, or are new or expanded entitlements needed?*

The FEIR does not analyze sufficient water supplies and does not directly provide a significance conclusion because the construction of a desalination plant would increase the available water supplies to northern San Diego County.

The proposed modifications would not result in additional use of potable water. The proposed modifications are a portion of the desalination plant, which would increase the available water supplies to northern San Diego County. As such, there would be no impacts from the proposed modifications, consistent with the previously certified FEIR. No changes to the FEIR are necessary and this issue will not be evaluated in the SEIR.

Initial Study for the Carlsbad Seawater Desalination Plant Intake and Discharge Facility Modifications

- e) *Would the project result in a determination by the wastewater treatment provider, which serves or may serve the project that it has adequate capacity to serve the project's projected demand in addition to the provider's existing commitments?*

The FEIR notes that the desalination plant's total combined wastewater flow of a maximum of 200,000 gallons per day and an instantaneous flow maximum below 150 gallons per minute would not exceed the wastewater system capacity of the Vista/Carlsbad Sewer Interceptor or the EWCPF. However, the FEIR provides a mitigation measure to ensure that capacity is not exceeded. As a result, the FEIR determined that impacts would be less than significant.

Operation of the desalination plant would not be substantially altered because of the proposed modifications. The project would not generate substantial additional wastewater that would be treated by the local wastewater treatment provider, and the mitigation implemented by the FEIR would continue to apply. As such, the proposed modification would result in less than significant impacts with the incorporation of mitigation, consistent with the previously certified FEIR. No changes to the FEIR are necessary and this issue will not be evaluated in the SEIR.

- f) *Would the project be served by a landfill with sufficient permitted capacity to accommodate the project's solid waste disposal needs?*

The FEIR notes that the primary sources of solid waste from the desalination plant would consist of sludge generated as a result of the intake water pretreatment filtration and disposal of other wastes such as filter cartridges. The FEIR determined, based upon estimated daily sludge generation and yearly filter/membrane disposal, that operation of the desalination plant would have less than significant impacts to landfill capacity.

The proposed modifications would require demolition of the existing EPS intake structure and pavement, thereby generating additional solid waste. Demolished materials would be transported to the Palomar Transfer Station where it would be delivered to an existing permitted landfill. Demolished materials would not constitute a substantial amount of solid waste that would require additional permitted capacity of the landfill. Additionally, demolition debris would be a temporary creation of solid waste that would not be generated continually. Upon completion of the project, operations of the desalination plant would not substantially change from what was analyzed under the previous environmental documents; solid waste would generally be the same as analyzed in the FEIR. As such, impacts from the proposed modifications would be less than significant.

Initial Study for the Carlsbad Seawater Desalination Plant Intake and Discharge Facility Modifications

consistent with the previously certified FEIR. No changes to the FEIR are necessary and this issue will not be evaluated in the SEIR.

- g) *Would the project comply with federal, state, and local statutes and regulations related to solid waste?*

The FEIR states that waste sludge would be disposed of through a contractor specialize in waste disposal and that general waste would be disposed of in a proper manner through Waste Management, Inc. at a sanitary landfill. The FEIR determined that impacts would be less than significant. All demolished materials would be handled and disposed of in proper waste facilities through compliance with applicable local, state, and federal waste regulations. Impacts from the proposed modifications would be less than significant, consistent with the previously certified FEIR. No changes to the FEIR are necessary and this issue will not be evaluated in the SEIR.

3.18 Mandatory Findings of Significance

- a) *Does the project have the potential to degrade the quality of the environment, substantially reduce the habitat of a fish or wildlife species, cause a fish or wildlife population to drop below self-sustaining levels, threaten to eliminate a plant or animal community, reduce the number or restrict the range of a rare or endangered plant or animal, or eliminate important examples of the major periods of California history or prehistory?*

As previously stated, there are changes to the project that could result in changes to potential impacts to biological resources and hydrology/water quality. Therefore, this issue will be evaluated in the SEIR.

- b) *Does the project have impacts that are individually limited, but cumulatively considerable? (“Cumulatively considerable” means that the incremental effects of a project are considerable when viewed in connection with the effects of past projects, the effects of other current projects, and the effects of probable future projects)?*

Since certification of the FEIR new information regarding the demolition of the EPS and construction of the CECP on the EPS site has become available. Therefore, the potential for the proposed modifications to result in a cumulatively considerable contribution to a potentially cumulative impact when considering this new information will be analyzed in the appropriate sections of the SEIR.

Initial Study for the Carlsbad Seawater Desalination Plant Intake and Discharge Facility Modifications

- c) *Does the project have environmental effects which will cause substantial adverse effects on human beings, either directly or indirectly?*

Based on the above analysis, all impacts related to the proposed project modifications can be mitigated to a level below significance; therefore, substantial adverse effects on human beings would not occur as a result of the proposed modifications. No changes to the FEIR are necessary and this issue will not be evaluated in the SEIR.

Initial Study for the Carlsbad Seawater Desalination Plant Intake and Discharge Facility Modifications

4 REFERENCES

4.1 References Cited

14 CCR 15000–15387 and Appendices A through L. Guidelines for Implementation of the California Environmental Quality Act, as amended.

Cal EMA. 2009. *Tsunami Inundation Map for Emergency Planning, Oceanside Quadrangle, San Luis Rey Quadrangle*. June 1, 2009.

CalFire. 2009. *Very High Fire Hazard Severity Zone for LRA, Carlsbad*. Department of Forestry and Fire Protection. June 11, 2009.

California Public Resources Code, Section 21000–21177. California Environmental Quality Act, as amended.

Caltrans (California Department of Transportation). 2013. Eligible And Officially Designated Routes. Updated December 19, 2013. Accessed June 30, 2014. <http://www.caltrans.ca.gov/hq/LandArch/scenic/cahisys.htm>.

CAPCOA (California Air Pollution Control Officers Association). 2008. *CEQA & Climate Change: Evaluating and Addressing Greenhouse Gas Emissions from Projects Subject to the California Environmental Quality Act*. January 2008.

CPUC (California Public Utilities Commission). 2014. California Renewables Portfolio Standard (RPS). Accessed April 29, 2014. <http://www.cpuc.ca.gov/PUC/energy/Renewables/>.

City of Carlsbad. 2005. Final Environmental Impact Report: Precise Development Plan and Desalination Plant. SCH#2004041081. December 2005. Prepared by Dudek & Associates, Inc.

City of Carlsbad. 2014. Draft Carlsbad General Plan. February 2014. Accessed April 21, 2014. <http://www.carlsbadca.gov/services/departments/community/envision-carlsbad/Pages/Documents.aspx>.

County of San Diego. 2009. *Draft - Dam Failure County of San Diego Hazard Mitigation Planning*. 2009.

County of San Diego. 2012. *County of San Diego Climate Action Plan*. June 2012. <http://www.sdcounty.ca.gov/pds/advance/climateactionplan.html>.

Initial Study for the Carlsbad Seawater Desalination Plant Intake and Discharge Facility Modifications

Department of Conservation. 2013. *San Diego County Important Farmland 2010*. Division of Land Resource Protection, Farmland Mapping and Monitoring Program. 2013.

FEMA. 2012. *Flood Insurance Rate Map 06073C0764G*. May 16, 2012.

Miller, Russell. 1996. *Generalized Mineral Land Classification Map of Western San Diego County, California*. Department of Conservation, Division of Mines and Geology. 2009.

OPR (Governor's Office of Planning and Research). 2008. *CEQA and Climate Change: Addressing Climate Change through California Environmental Quality Act (CEQA) Review*. Technical Advisory. Sacramento, California: OPR. June 19, 2008. Accessed February 3, 2009. <http://opr.ca.gov/docs/june08-ceqa.pdf>.

Poseidon Resources. 2008. Carlsbad Seawater Desalination Project Energy Minimization and Greenhouse Gas Reduction Plan. July 3, 2008.

San Deigo Regional Airport Authority. 2010. *Revised Draft McClellan-Palomar Airport Land Use Compatibility Plan*. January 2010.

SDAPCD (San Diego Air Pollution Control District). 1969. SDAPCD Regulation IV: Prohibitions; Rule 51: Nuisance. January 1, 1969.

SDAPCD. 1998. SDAPCD Regulation II: Permits; Rule 20.2(d)(2): Air Quality Impact Analysis (AQIA). December 22, 1998.

SDAPCD. 1999. SDAPCD Regulation XV: Federal Conformity; Rule 1501: Conformity of General Federal Actions. EPA approved June 22, 1999.

SDAPCD. 2009. SDAPCD Regulation IV: Prohibitions; Rule 55: Fugitive Dust Control. Effective date December 24, 2009.

State of California. 2008. San Diego County Important Farmland. Department of Conservation, Division of Land Resource Protection. August 2008.

Initial Study for the Carlsbad Seawater Desalination Plant Intake and Discharge Facility Modifications

INTENTIONALLY LEFT BLANK

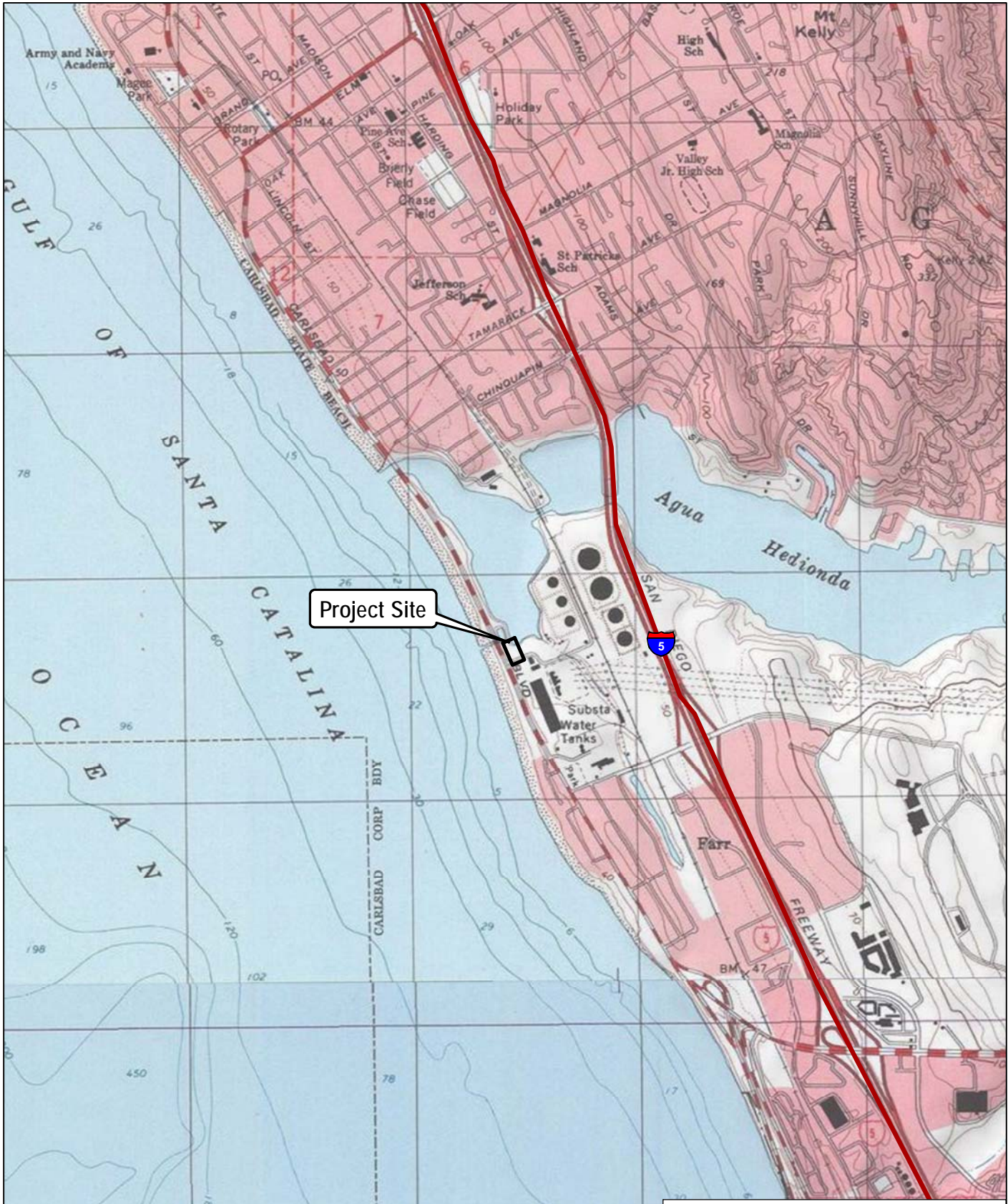

Project Site

Modified Intake Boundary



0 1,000 2,000 Feet

Copyr

DUDEK

SOURCE: USGS 7.5-Minute Series - San Luis Rey Quadrangle.

FIGURE 1
Vicinity Map

8426

Carlsbad Desal SEIR

Initial Study for the Carlsbad Seawater Desalination Plant Intake and Discharge Facility Modifications

INTENTIONALLY LEFT BLANK

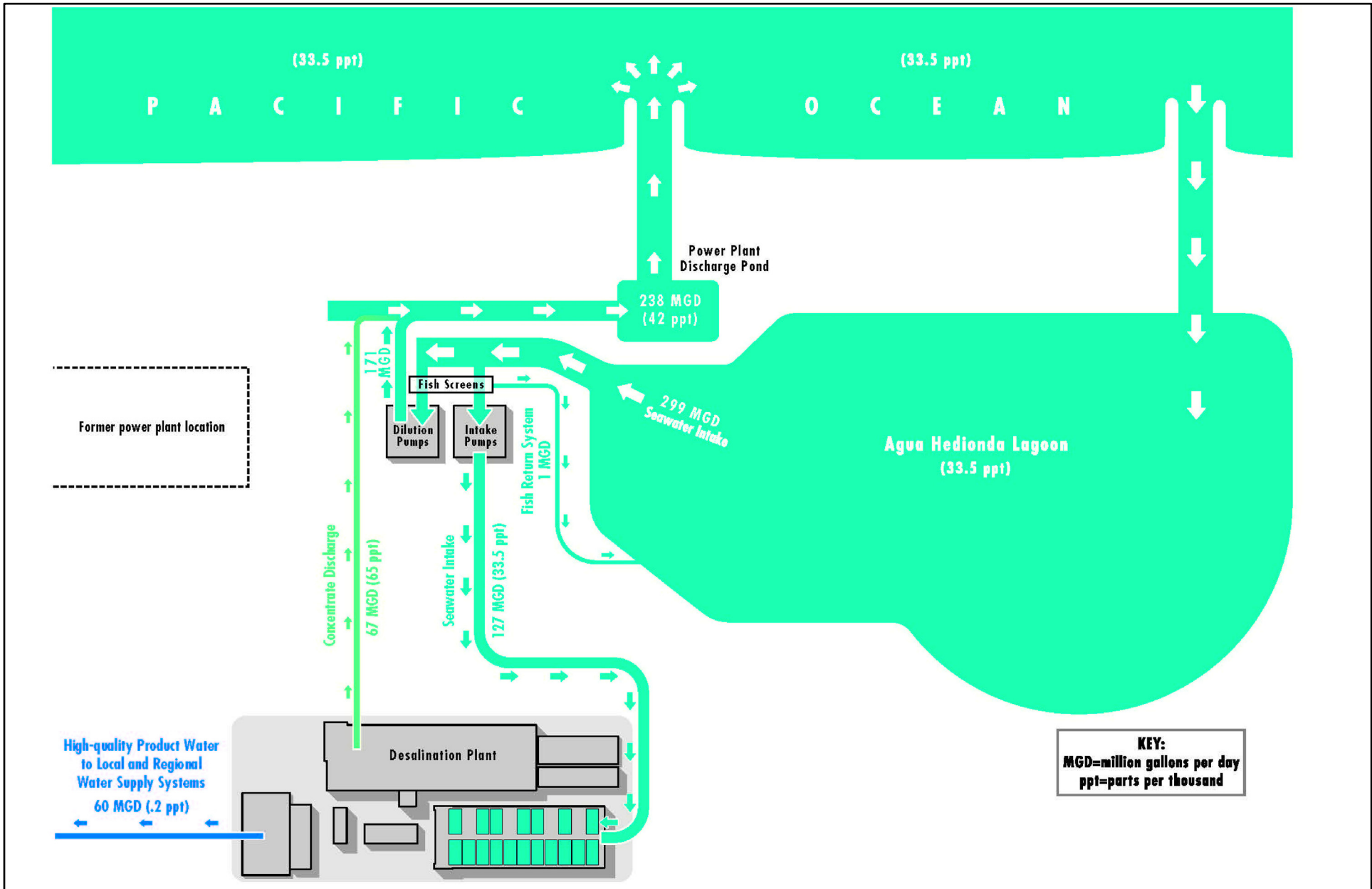

Initial Study for the Carlsbad Seawater Desalination Plant Intake and Discharge Facility Modifications

APPENDIX S-B

Air Quality and GHG Emissions Modeling Results

**AIR QUALITY AND GREENHOUSE GAS
TECHNICAL REPORT
FOR THE
CARLSBAD DESALINATION PLANT INTAKE
MODIFICATIONS PROJECT
CITY OF CARLSBAD, CALIFORNIA**

Prepared for:

San Diego County Water Authority
4677 Overland Avenue
San Diego, California 92123
Contact: Larry Purcell

Prepared by:

DUDEK
605 Third Street
Encinitas, California 92024
760.479.4856

MARCH 2016

Air Quality and Greenhouse Gas Technical Report for the Carlsbad Desalination Plant Intake Modifications Project

TABLE OF CONTENTS

<u>Section</u>	<u>Page No.</u>
ACRONYMS AND ABBREVIATIONS.....	III
SUMMARY	V
1 INTRODUCTION.....	1
1.1 Purpose.....	1
1.2 Project Location	1
1.3 Project Description.....	1
2 AIR QUALITY.....	7
2.1 Existing Conditions.....	7
2.1.1 Climate and Topography.....	7
2.1.2 Air Pollution Climatology.....	7
2.1.3 Sensitive Receptors	8
3 POLLUTANTS AND EFFECTS.....	9
4 REGULATORY SETTING	13
4.1 Federal.....	13
4.2 State.....	13
4.3 Local	16
5 LOCAL AIR QUALITY	19
5.1 SDAB Attainment Designation.....	19
5.2 Air Quality Monitoring Data	20
6 THRESHOLDS OF SIGNIFICANCE.....	23
7 IMPACTS	25
7.1 Consistency with Air Quality Plans	25
7.2 Construction Impacts	27
7.3 Operational Impacts	29
7.4 Cumulative Impacts	30
7.5 Toxic Air Contaminants.....	31
7.6 Odors.....	32
8 SUMMARY AND CONCLUSIONS	33
9 GREENHOUSE GASES	35
9.1 Background.....	35
9.1.1 The Greenhouse Effect and Greenhouse Gases	35

Air Quality and Greenhouse Gas Technical Report for the Carlsbad Desalination Plant Intake Modifications Project

TABLE OF CONTENTS

<u>Section</u>	<u>Page No.</u>
9.1.2 Contributions to Greenhouse Gas Emissions.....	36
9.1.3 Potential Effects of Human Activity on Climate Change.....	37
10 REGULATORY SETTING	39
10.1 Federal Activities	39
10.2 State of California.....	41
10.3 City of Carlsbad	49
11 SIGNIFICANCE CRITERIA AND ANALYSIS METHODOLOGIES	51
11.1 Methodology and Assumptions	51
11.2 Appendix G of the CEQA Guidelines	51
11.3 County Climate Change Analysis Criteria.....	52
12 IMPACTS	53
12.1 Construction.....	53
12.2 Operation.....	53
12.3 Consistency with GHG Plans.....	54
13 REFERENCES.....	57

APPENDICES

- A CalEEMod Outputs and Estimated Construction Emissions
- B Estimated Operational Emissions

TABLES

1 Construction Schedule	4
2 Ambient Air Quality Standards	14
3 SDAB Attainment Classification.....	19
4 Ambient Air Quality Data (ppm unless otherwise indicated).....	20
5 Frequency of Air Quality Standard Violations	21
6 SDAPCD Air Quality Significance Thresholds.....	23
7 Construction Schedule	27
8 Estimated Maximum Daily Construction Emissions (pounds per day).....	28
9 GHG Sources in California.....	36
10 Estimated Construction GHG Emissions (total metric tons).....	53

Air Quality and Greenhouse Gas Technical Report for the Carlsbad Desalination Plant Intake Modifications Project

ACRONYMS AND ABBREVIATIONS

Acronym/Abbreviation	Definition
ADT	average daily trips
APCD	Air Pollution Control District
AQMD	Air Quality Management District
ATCM	Airborne Toxic Control Measure
CAA	Clean Air Act
CAAQS	California Ambient Air Quality Standards
CAP	Climate Action Plan
CARB	California Air Resources Board
CalEEMod	California Emissions Estimator Model
CEQA	California Environmental Quality Act
City	City of Carlsbad
CO	carbon monoxide
EPA	United States Environmental Protection Agency
GHG	greenhouse gas emissions
IPCC	Intergovernmental Panel on Climate Change
MGD	million gallons per day
NAAQS	National Ambient Air Quality Standards
NO ₂	nitrogen dioxide
N ₂ O	nitrous oxide
NO _x	oxides of nitrogen
O ₃	ozone
Pb	lead
PM _{2.5}	fine particulate matter
PM ₁₀	coarse particulate matter
RAQS	Regional Air Quality Strategy
SANDAG	San Diego Association of Governments
SB	Senate Bill
SDAB	South Diego Air Basin
SDAPCD	San Diego Air Pollution Control District
SDG&E	San Diego Gas & Electric
SIP	State Implementation Plan
SO ₂	sulfur dioxide
SO _x	oxides of sulfur
VOC	volatile organic compound

Air Quality and Greenhouse Gas Technical Report for the Carlsbad Desalination Plant Intake Modifications Project

INTENTIONALLY LEFT BLANK

Air Quality and Greenhouse Gas Technical Report for the Carlsbad Desalination Plant Intake Modifications Project

SUMMARY

Due to a permanent intake pump shutdown at the Carlsbad Desalination Plant that will occur effective June 1, 2017, the project applicant will have to transition to “stand-alone” operation of the seawater intake by this date to keep the Carlsbad Desalination Plant in service. To facilitate “stand-alone” operation of the seawater intake, the project applicant has proposed changes to the Carlsbad Desalination Plant seawater intake and discharge (proposed project).

The air quality impact analysis provides an evaluation of the potential for significant adverse impacts to the ambient air quality due to construction and operational emissions resulting from the project. Construction of the project would result in a temporary addition of pollutants to the local airshed caused by soil disturbance, fugitive dust emissions, and combustion pollutants from on-site construction equipment, as well as from off-site trucks hauling construction materials. The analysis concludes that the daily construction emissions would not exceed the County of San Diego’s significance thresholds for criteria pollutants (VOC, NO_x, CO, SO_x, PM₁₀ and PM_{2.5}). Operational emissions would reflect that of the existing facility; therefore, no increase in operational criteria air pollutant emissions would occur and impacts during project operation would be **less than significant**. Additionally, impacts to sensitive receptors during temporary construction activities and operation of the proposed project were determined to be **less than significant**. Lastly, odor impacts would be considered **less than significant**.

The proposed project’s potential effect on global climate change was evaluated, and emissions of greenhouse gases (GHGs) were estimated based on the use of construction equipment and vehicle trips associated with construction activities, as well as operational emissions once construction phases are complete. The annual project-generated GHG emissions were estimated to result in a approximately XX metric tons of carbon dioxide equivalent (MT CO₂E) per year as a result of amortized project construction emissions and project operations, which would be below the 900 MT CO₂E per year screening threshold that has been established for the purposes of assessing GHG emissions of projects in the County of San Diego. Therefore, GHG impacts would be considered **less than significant**.

Air Quality and Greenhouse Gas Technical Report for the Carlsbad Desalination Plant Intake Modifications Project

INTENTIONALLY LEFT BLANK

Air Quality and Greenhouse Gas Technical Report for the Carlsbad Desalination Plant Intake Modifications Project

1 INTRODUCTION

1.1 Purpose

The purpose of this report is to estimate and evaluate the potential air quality impacts associated with implementation of the proposed project relative to the County of San Diego's *Guidelines for Determining Significance and Report Format and Content Requirements* (County of San Diego 2007). Additionally, greenhouse gas (GHG) emissions are analyzed relative to the County of San Diego's *Recommended Approach to Addressing Climate Change in CEQA Documents* (County of San Diego 2015).

1.2 Project Location

The Carlsbad Desalination Plant (CDP) is located on the Encina Power Station (EPS) site, adjacent to the existing power plant, located immediately south of the Agua Hedionda Lagoon, within the City of Carlsbad, in northern San Diego County. The facility address is 4600 Carlsbad Boulevard, Carlsbad, CA 92008.

1.3 Project Description

Cabrillo provided notice to Poseidon on May 5, 2014 that a permanent intake pump shutdown will occur effective June 1, 2017 that will require Poseidon to transition to "stand-alone" operation of the seawater intake by this date to keep the CDP in service. To facilitate "stand-alone" operation of the seawater intake, Poseidon has proposed changes to the CDP seawater intake and discharge (proposed project).

The approved CDP uses seawater that enters the existing EPS intake facilities located at the Agua Hedionda Lagoon and after screening, is pumped through the EPS's condensers to the discharge channel. The CDP intake structure is designed to be connected to the discharge canal and would divert approximately one third of cooling water for production of fresh water. The CDP's pretreatment and reverse osmosis membrane separation system would convert an annual averaged of approximately 50 million gallons a day (MGD) (approximately half) of the diverted cooling seawater to fresh drinking water. The remaining (approximately one-half) would have a salinity of approximately 66 parts per thousand (ppt) or two times higher than that of the ocean water (approximately 33.5 ppt). This seawater concentrate would be returned to the EPS discharge canal downstream of the point of intake for blending with the remaining cooling water prior to conveyance to the Pacific Ocean via an open surf zone discharge channel on the beach.

Air Quality and Greenhouse Gas Technical Report for the Carlsbad Desalination Plant Intake Modifications Project

The membrane technology advances enable the CDP to increase potable water output from a production rate of up to 54 MGD to a production rate of up to 60 MGD with minimal improvements to the plant.

The screened surface intake under consideration would be located in Agua Hedionda Lagoon. Feedwater for the CDP, and brine dilution water (in the case of the flow augmentation alternatives), would be withdrawn through the existing EPS intake structure located in the south west corner of Agua Hedionda Lagoon. There would be no change in the source waterbody, and no significant construction in the lagoon.

Under the proposed changes water would continue to enter the existing seawater intake channel from the Agua Hedionda Lagoon. Water from Agua Hedionda Lagoon with a salt content of approximately 33.5 ppt is taken into the forebay at approximately 299 MGD. Water from the forebay travels at a velocity of approximately 0.5 feet per second through fish screens (also referred to as ‘traveling screens’) with one millimeter (mm) slot openings. Fish-friendly traveling water screens use a mesh with a smooth surface to minimize the risk of scale loss during the impingement process. The fish-friendly mesh on the Bilfinger Water Technology (BWT) screens for the CDP would be fabricated of woven stainless steel wire. Fish-friendly screens have fish lifting buckets attached to the lower section of each screen panel. The buckets provide a sheltered area for organisms that cannot escape the intake flow to congregate and prevent them from becoming trapped against the screen mesh. The buckets are also designed to hold water to minimize air exposure during the collection and return process. Fish-friendly screens have low pressure spray wash system (in addition to the standard high pressure one used to clean the screen of debris) to gently rinse collected fish from the screen into a fish return system. The spray wash pressure is typically below 20 psi and the location and orientation of the nozzles is optimized for best performance. The BWT screens would have a low-pressure spray wash to gently rinse marine organisms into the fish return trough. Fish-friendly screens are designed to operate continuously in comparison to standard traveling water screens that typically rotate on a schedule or a set pressure differential.

Fish and other organisms too large to pass through the screens are then carried via a one MGD fish return system, back to the lagoon. The fish return system would release fish and lagoon water via a submerged outlet a sufficient distance from the intake channel (approximately 205 feet) so as to avoid immediate recirculation of fish and other organisms. The fish return system pipe would be approximately two feet in diameter and extend for approximately 382 feet below grade and submerged such that it would not be visible, except for a short section adjacent to the screening structure. This visible short section would consist of a two-foot diameter half-round trough mounted to the intake deck on the downstream side of the screens.

Air Quality and Greenhouse Gas Technical Report for the Carlsbad Desalination Plant Intake Modifications Project

The water is directed to either the existing intake pumps or the proposed fish friendly dilution pumps. Water still with a salt content of approximately 33.5 ppt would be directed to the intake pumps and on to the CDP at approximately 127 MGD (120 MGD for processing and seven MGD for filter backwash). Water is then desalinated through the constructed CDP and up to 60 MGD directed to local water supplies. Approximately 60 MGD of saline water with a salt content of approximately 67 ppt, and 7 MGD of filter backwash water with a salt content of 33.5 ppt, is directed to the discharge tunnel for mixing with dilution water via the discharge pond prior to discharging into the Pacific Ocean. Water from the forebay that passes through fish screens and directed to the fish friendly low impact dilution pumps would be pumped at approximately 171 MGD directly into the discharge tunnel for mixing with the water from the CDP prior to discharging into the ocean via the discharge pond. This flow augmentation system would pump flow using four (three plus one redundant) fish-friendly, axial flow pumps (Bedford submersible or equal). The flows would be conveyed to a junction with the existing brine pipeline and be discharged through a common vault into the existing EPS discharge tunnel. The Bedford Pumps fish-friendly axial flow pumps proposed consist of a propeller within a pipe driven by a sealed motor. These pumps are smaller in dimension than many conventional pumps and are designed for low heads and high flows. The low head design of the pumps (approximately 5 psi) minimizes the potential for pressure-related injuries.

The pump specified for this application has a two-bladed impellor. The pumps would be housed in a structure that would be below grade with access from ground level. Water arrives at the discharge pond at a rate of approximately 238 MGD with a salt content of approximately 42 ppt. Water is then discharged into the Pacific Ocean where it mixes and dilutes to within 2 ppt of background salt content levels (35.5 ppt) at the edge of the approximately 656 foot brine mixing zone. No modification to the discharge pond or point of discharge to the Pacific Ocean is proposed as part of the proposed modifications.

Construction

Construction of the proposed intake and discharge modifications would take 18 months. The physical modifications include the shore pilings around the intake channel and a small area of bank stabilization/sheet pilings at the lagoon edge where the fish return pipe returns approximately 1 MGD of lagoon water along with fish to the lagoon.

Typical equipment involved in each of the construction activities includes excavators, tractors/backhoes, cranes, dewatering equipment, dumpers, lifts, and drill rigs. More detail on the phasing and duration anticipated for construction of the proposed modifications are shown below:

Air Quality and Greenhouse Gas Technical Report for the Carlsbad Desalination Plant Intake Modifications Project

**Table 1
Construction Schedule**

Phase	Duration
<i>Intake Structure</i>	
Phase 1a – Site Preparation	1 week
Phase 1b – Asphalt Removal	1 week
Phase 2a – Sheet Piling	18 weeks
Phase 2b – Excavation	18 weeks
Phase 3 – Building Construction	12 weeks
Phase 4 – Demolition	16 weeks
Phase 5 – Backfill	6 weeks
Phase 6a – Grading	1 week
Phase 6b – Paving	1 week
<i>Axial Pumps</i>	
Phase 1 – Paving	2 weeks
Phase 2 – Axial Pump Installation	8 weeks
Phase 3a – Trenching	4 weeks
Phase 3b – Paving	4 weeks
Phase 4 – Building Construction	4 weeks
Phase 5 – Architectural Coatings	2 weeks

Demolition and site preparation for both the intake and discharge modifications would take approximately 17 weeks and involve clearing and demolition of approximately 0.6 acre of the existing paved/disturbed area west of the CDP and east of Carlsbad Boulevard. This includes approximately 7,000 square feet of vegetation clearing and 20,000 square feet of existing asphalt to be removed. The existing intake walls would be removed once the sheet piling is installed and are estimated to consist of approximately 72 tons of the existing intake wall material. Additionally, 27 cubic yards of material will be imported to construction the new partition walls.

Sheet piling for both the intake and discharge modifications activities would last approximately 18 weeks involving the removal of approximately 26,500 cubic yards of earth and the installation of an approximately 457 tons of shoring system. Removed earth would be reused where appropriate, or if unsuitable it would be disposed of at a licensed landfill facility.

Buildings construction would involve the installation of approximately 6,300 cubic yards of concrete for the intake structure and construction for discharge modifications of a pump house within which up to 4 fish friendly pumps would be installed to provide dilution water to the mixing pond. A concrete pad for the pump house would be constructed as would an approximately 100 foot trench to provide new utility hooks up to the pump house. Construction for buildings construction, including final sealants treatments would take approximately 12 weeks.

Air Quality and Greenhouse Gas Technical Report for the Carlsbad Desalination Plant Intake Modifications Project

Backfill grading and paving for both the intake and discharge modifications would last for approximately 8 weeks. Disturbed areas would be backfilled with approximately 16,800 cy of re-compacted material previously removed, and graded and paved.

Fish return construction would involve trenching and installation of a pipeline below grade that would discharge directly back into the Agua Hedionda Lagoon. The fish return system would be constructed as part of the Intake Phase 2 construction phase. To support the pipe a small portion of the lagoon bank would be stabilized with sheet pilings/rip-rap. The pipe itself would be submerged at all stages of the tide.

Construction traffic would occur throughout construction and include disposal of cleared and demolished materials as well as deliveries of materials and components. With approximately 9,700 cubic yards of material exported a total of approximately 970, 10 cubic yard capacity, trucks would be required to dispose of the material. The material would be disposed of during sheet piling phase over approximately 18 weeks. In addition, approximately 5 truck trips per day throughout construction has conservatively been estimated for any and all deliveries. Deliveries would include approximately 12 trucks total to deliver 457 tons of shoring system, based on 80,000lbs (36 tons) capacity of typical loader trucks, within the 36 week sheet piling construction phase. Throughout construction deliveries of necessary materials such as sheet pilings, concrete, screens, pumps, and piping materials would be delivered as required. Construction workers would also result in vehicular trips as they commute to the job site each day. Approximately 20 workers are necessary on a daily basis to construct the modifications. The combined additional traffic trips from constructions would total approximately 45 one way trips (5 truck trips per day disposal [using a passenger vehicle equivalent (PVE)¹ of 2.5 = 12.5], plus 5 truck trips a day for deliveries [again with a PVE of 2.5 = 12.5], plus approximately 20 workers a day [no carpooling accounted for]) or 90 average daily trips (ADT), in and out.

¹ Passenger vehicle equivalent is used because haul and delivery trucks take up additional queuing space and move through intersections slower than passenger vehicles for which roadway metrics are typically design around. The ration 2.5 is derived from the ITE

Air Quality and Greenhouse Gas Technical Report for the Carlsbad Desalination Plant Intake Modifications Project

INTENTIONALLY LEFT BLANK

Air Quality and Greenhouse Gas Technical Report for the Carlsbad Desalination Plant Intake Modifications Project

2 AIR QUALITY

2.1 Existing Conditions

2.1.1 Climate and Topography

The weather of the San Diego region, as in most of Southern California, is influenced by the Pacific Ocean and its semi-permanent high-pressure systems that result in dry, warm summers and mild, occasionally wet winters. The average temperature ranges (in degrees Fahrenheit (°F)) from the mid-40s to the high 90s. Most of the region's precipitation falls from November to April, with infrequent (approximately 10%) precipitation during the summer. The average seasonal precipitation along the coast is approximately 10 inches; the amount increases with elevation as moist air is lifted over the mountains.

The topography in the San Diego region varies greatly, from beaches on the west to mountains and desert on the east; along with local meteorology, it influences the dispersal and movement of pollutants in the basin. The mountains to the east prohibit dispersal of pollutants in that direction and help trap them in inversion layers.

The interaction of ocean, land, and the Pacific High Pressure Zone maintains clear skies for much of the year and influences the direction of prevailing winds (westerly to northwesterly). Local terrain is often the dominant factor inland, and winds in inland mountainous areas tend to blow through the valleys during the day and down the hills and valleys at night.

2.1.2 Air Pollution Climatology

The project area is located within the San Diego Air Basin (SDAB or basin) and is subject to the San Diego Air Pollution Control District (SDAPCD) guidelines and regulations. The SDAB is one of 15 air basins that geographically divide the State of California. The SDAB is currently classified as a federal nonattainment area for ozone (O₃) and a state nonattainment area for particulate matter less than 10 microns (PM₁₀), particulate matter less than 2.5 microns (PM_{2.5}), and O₃.

The SDAB lies in the southwest corner of California and comprises the entire San Diego region, covering 4,260 square miles, and is an area of high air pollution potential. The basin experiences warm summers, mild winters, infrequent rainfalls, light winds, and moderate humidity. This usually mild climatological pattern is interrupted infrequently by periods of extremely hot weather, winter storms, or Santa Ana winds.

The SDAB experiences frequent temperature inversions. Subsidence inversions occur during the warmer months as descending air associated with the Pacific High Pressure Zone meets cool marine

Air Quality and Greenhouse Gas Technical Report for the Carlsbad Desalination Plant Intake Modifications Project

air. The boundary between the two layers of air creates a temperature inversion that traps pollutants. The other type of inversion, a radiation inversion, develops on winter nights when air near the ground cools by heat radiation and air aloft remains warm. The shallow inversion layer formed between these two air masses also can trap pollutants. As the pollutants become more concentrated in the atmosphere, photochemical reactions occur that produce O₃, which contributes to the formation of smog. Smog is a combination of smoke and other particulates, O₃, hydrocarbons, oxides of nitrogen (NO_x) and other chemically reactive compounds which, under certain conditions of weather and sunlight, may result in a murky brown haze that causes adverse health effects (CARB 2014a).

Light daytime winds, predominately from the west, further aggravate the condition by driving air pollutants inland, toward the mountains. During the fall and winter, air quality problems are created due to carbon monoxide (CO) and NO_x emissions. CO concentrations are generally higher in the morning and late evening. In the morning, CO levels are elevated due to cold temperatures and the large number of motor vehicles traveling. Higher CO levels during the late evenings are a result of stagnant atmospheric conditions trapping CO in the area. Since CO is produced almost entirely from automobiles, the highest CO concentrations in the basin are associated with heavy traffic. Nitrogen dioxide (NO₂) levels are also generally higher during fall and winter days.

Under certain conditions, atmospheric oscillation results in the offshore transport of air from the Los Angeles region to San Diego County. This often produces high O₃ concentrations, as measured at air pollutant monitoring stations within the County. The transport of air pollutants from Los Angeles to San Diego has also occurred within the stable layer of the elevated subsidence inversion, where high levels of O₃ are transported.

2.1.3 Sensitive Receptors

Air quality varies as a direct function of the amount of pollutants emitted into the atmosphere, the size and topography of the air basin, and the prevailing meteorological conditions. Air quality problems arise when the rate of pollutant emissions exceeds the rate of dispersion. Reduced visibility, eye irritation, and adverse health impacts upon those persons termed sensitive receptors are the most serious hazards of existing air quality conditions in the area.

Some land uses are considered more sensitive to changes in air quality than others, depending on the population groups and the activities involved. People most likely to be affected by air pollution include children, the elderly, athletes, and people with cardiovascular and chronic respiratory diseases. Facilities and structures where these air pollution-sensitive people live or spend considerable amounts of time are known as sensitive receptors. Land uses where air pollution-sensitive individuals are most likely to spend time include schools and schoolyards, parks and playgrounds, daycare centers, nursing homes, hospitals, and residential communities (sensitive sites or sensitive land uses) (CARB 2005).

Air Quality and Greenhouse Gas Technical Report for the Carlsbad Desalination Plant Intake Modifications Project

3 POLLUTANTS AND EFFECTS

Criteria air pollutants are defined as pollutants for which the federal and state governments have established ambient air quality standards, or criteria, for outdoor concentrations to protect public health. The federal and state standards have been set, with an adequate margin of safety, at levels above which concentrations could be harmful to human health and welfare. These standards are designed to protect the most sensitive persons from illness or discomfort. Pollutants of concern include: O₃, NO₂, CO, sulfur dioxide (SO₂), PM₁₀, PM_{2.5}, and lead (Pb). These pollutants are discussed in the following paragraphs.² In California, sulfates, vinyl chloride, hydrogen sulfide, and visibility-reducing particles are also regulated as criteria air pollutants.

Ozone. O₃ is a colorless gas that is formed in the atmosphere when volatile organic compounds (VOCs), sometimes referred to as reactive organic gases, and NO_x react in the presence of ultraviolet sunlight. O₃ is not a primary pollutant; it is a secondary pollutant formed by complex interactions of two pollutants directly emitted into the atmosphere. The primary sources of VOCs and NO_x, the precursors of O₃, are automobile exhaust and industrial sources. Meteorology and terrain play major roles in O₃ formation and ideal conditions occur during summer and early autumn, on days with low wind speeds or stagnant air, warm temperatures, and cloudless skies. Short-term exposures (lasting for a few hours) to O₃ at levels typically observed in Southern California can result in breathing pattern changes, reduction of breathing capacity, increased susceptibility to infections, inflammation of the lung tissue, and some immunological changes.

Nitrogen Dioxide. Most NO₂, like O₃, is not directly emitted into the atmosphere but is formed by an atmospheric chemical reaction between nitric oxide (NO) and atmospheric oxygen. NO and NO₂ are collectively referred to as NO_x and are major contributors to O₃ formation. High concentrations of NO₂ can cause breathing difficulties and result in a brownish-red cast to the atmosphere with reduced visibility. There is some indication of a relationship between NO₂ and chronic pulmonary fibrosis and some increase in bronchitis in children (2 and 3 years old) has also been observed at concentrations below 0.3 parts per million by volume (ppm).

Carbon Monoxide. CO is a colorless and odorless gas formed by the incomplete combustion of fossil fuels. CO is emitted almost exclusively from motor vehicles, power plants, refineries, industrial boilers, ships, aircraft, and trains. In urban areas, such as the project area, automobile exhaust accounts for the majority of CO emissions. CO is a non-reactive air pollutant that

² The following descriptions of health effects for each of the criteria air pollutants associated with project construction and operations are based on the U.S. Environmental Protection Agency's "Six Common Air Pollutants" (EPA 2012) and the California Air Resources Board's "Glossary of Air Pollutant Terms" (CARB 2014a) published information.

Air Quality and Greenhouse Gas Technical Report for the Carlsbad Desalination Plant Intake Modifications Project

dissipates relatively quickly; therefore, ambient CO concentrations generally follow the spatial and temporal distributions of vehicular traffic. CO concentrations are influenced by local meteorological conditions; primarily wind speed, topography, and atmospheric stability. CO from motor vehicle exhaust can become locally concentrated when surface-based temperature inversions are combined with calm atmospheric conditions, a typical situation at dusk in urban areas between November and February. The highest levels of CO typically occur during the colder months of the year when inversion conditions are more frequent. In terms of health, CO competes with oxygen, often replacing it in the blood, thus reducing the blood's ability to transport oxygen to vital organs. The results of excess CO exposure can be dizziness, fatigue, and impairment of central nervous system functions.

Sulfur Dioxide. SO₂ is a colorless, pungent gas formed primarily by the combustion of sulfur-containing fossil fuels. Main sources of SO₂ are coal and oil used in power plants and industries; as such, the highest levels of SO₂ are generally found near large industrial complexes. In recent years, SO₂ concentrations have been reduced by the increasingly stringent controls placed on stationary source emissions of SO₂ and limits on the sulfur content of fuels. SO₂ is an irritant gas that attacks the throat and lungs and can cause acute respiratory symptoms and diminished ventilator function in children. SO₂ can also yellow plant leaves and erode iron and steel.

Particulate Matter. Particulate matter pollution consists of very small liquid and solid particles floating in the air, which can include smoke, soot, dust, salts, acids, and metals. Particulate matter can form when gases emitted from industries and motor vehicles undergo chemical reactions in the atmosphere. PM_{2.5} and PM₁₀ represent fractions of particulate matter. Fine particulate matter, or PM_{2.5}, is roughly 1/28 the diameter of a human hair. PM_{2.5} results from fuel combustion (e.g., motor vehicles, power generation, and industrial facilities), residential fireplaces, and wood stoves. In addition, PM_{2.5} can be formed in the atmosphere from gases such as sulfur oxides (SO_x), NO_x, and VOC. Inhalable or coarse particulate matter, or PM₁₀, is about 1/7 the thickness of a human hair. Major sources of PM₁₀ include crushing or grinding operations; dust stirred up by vehicles traveling on roads; wood burning stoves and fireplaces; dust from construction, landfills, and agriculture; wildfires and brush/waste burning; industrial sources; windblown dust from open lands; and atmospheric chemical and photochemical reactions.

PM_{2.5} and PM₁₀ pose a greater health risk than larger-size particles. When inhaled, these tiny particles can penetrate the human respiratory system's natural defenses and damage the respiratory tract. PM_{2.5} and PM₁₀ can increase the number and severity of asthma attacks, cause or aggravate bronchitis and other lung diseases, and reduce the body's ability to fight infections. Very small particles of substances, such as Pb, sulfates, and nitrates, can cause lung damage directly or be absorbed into the blood stream, causing damage elsewhere in the body. Additionally, these substances can transport absorbed gases, such as chlorides or ammonium,

Air Quality and Greenhouse Gas Technical Report for the Carlsbad Desalination Plant Intake Modifications Project

into the lungs, also causing injury. Whereas PM_{10} tends to collect in the upper portion of the respiratory system, $PM_{2.5}$ is so tiny that it can penetrate deeper into the lungs and damage lung tissues. Suspended particulates also damage and discolor surfaces on which they settle, as well as produce haze and reduce regional visibility.

Lead. Lead in the atmosphere occurs as particulate matter. Sources of lead include leaded gasoline, the manufacturing of batteries, paint, ink, ceramics, and ammunition and secondary lead smelters. Prior to 1978, mobile emissions were the primary source of atmospheric lead. Between 1978 and 1987, the phase-out of leaded gasoline reduced the overall inventory of airborne lead by nearly 95%. With the phase-out of leaded gasoline, secondary lead smelters, battery recycling, and manufacturing facilities are becoming lead-emission sources of greater concern.

Prolonged exposure to atmospheric lead poses a serious threat to human health. Health effects associated with exposure to lead include gastrointestinal disturbances, anemia, kidney disease, and in severe cases, neuromuscular and neurological dysfunction. Of particular concern are low-level lead exposures during infancy and childhood. Such exposures are associated with decrements in neurobehavioral performance including intelligence quotient performance, psychomotor performance, reaction time, and growth.

Toxic Air Contaminants. A substance is considered toxic if it has the potential to cause adverse health effects in humans, including increasing the risk of cancer upon exposure, or acute and/or chronic noncancer health effects. A toxic substance released into the air is considered a toxic air contaminant (TAC). Examples include certain aromatic and chlorinated hydrocarbons, certain metals, and asbestos. TACs are generated by a number of sources, including stationary sources such as dry cleaners, gas stations, combustion sources, and laboratories; mobile sources such as automobiles; and area sources such as landfills. Adverse health effects associated with exposure to TACs may include carcinogenic (i.e., cancer-causing) and noncarcinogenic effects. Noncarcinogenic effects typically affect one or more target organ systems and may be experienced either on short-term (acute) or long-term (chronic) exposure to a given TAC.

Air Quality and Greenhouse Gas Technical Report for the Carlsbad Desalination Plant Intake Modifications Project

INTENTIONALLY LEFT BLANK

Air Quality and Greenhouse Gas Technical Report for the Carlsbad Desalination Plant Intake Modifications Project

4 REGULATORY SETTING

4.1 Federal

Clean Air Act

The federal Clean Air Act (CAA), passed in 1970 and last amended in 1990, forms the basis for the national air pollution control effort. The U.S. Environmental Protection Agency (EPA) is responsible for implementing most aspects of the CAA, including the setting of National Ambient Air Quality Standards (NAAQS) for major air pollutants, hazardous air pollutant standards, approval of state attainment plans, motor vehicle emission standards, stationary source emission standards and permits, acid rain control measures, stratospheric O₃ protection, and enforcement provisions.

NAAQS are established by the EPA for “criteria pollutants” under the CAA, which are O₃, carbon monoxide (CO), nitrogen dioxide (NO₂), sulfur dioxide (SO₂), particulate matter (PM₁₀ and PM_{2.5}), and lead (Pb).

The NAAQS describe acceptable air quality conditions designed to protect the health and welfare of the citizens of the nation. The CAA requires the EPA to reassess the NAAQS at least every 5 years to determine whether adopted standards are adequate to protect public health based on current scientific evidence. States with areas that exceed the NAAQS must prepare a State Implementation Plan (SIP) that demonstrates how those areas will attain the standards within mandated time frames.

4.2 State

California Clean Air Act

The California Clean Air Act was adopted in 1988 and establishes the state’s air quality goals, planning mechanisms, regulatory strategies, and standards of progress. Under the California Clean Air Act, the task of air quality management and regulation has been legislatively granted to the California Air Resources Board (CARB), with subsidiary responsibilities assigned to air quality management districts (AQMDs) and air pollution control districts (APCDs) at the regional and county levels. CARB is responsible for ensuring implementation of the California Clean Air Act, responding to the federal CAA, and regulating emissions from motor vehicles and consumer products. Pursuant to the authority granted to it, CARB has established California Ambient Air Quality Standards (CAAQS), which are generally more restrictive than the NAAQS.

Air Quality and Greenhouse Gas Technical Report for the Carlsbad Desalination Plant Intake Modifications Project

The NAAQS and CAAQS are presented in Table 2, Ambient Air Quality Standards.

Table 2
Ambient Air Quality Standards

Pollutant	Averaging Time	California Standards ^a	National Standards ^b	
		Concentration ^c	Primary ^{c,d}	Secondary ^{c,e}
O ₃	1-hour	0.09 ppm (180 µg/m ³)	—	Same as Primary Standard
	8-hour	0.070 ppm (137 µg/m ³)	0.070 ppm (137 µg/m ³)	
CO	1-hour	20 ppm (23 mg/m ³)	35 ppm (40 mg/m ³)	—
	8-hour	9.0 ppm (10 mg/m ³)	9 ppm (10 mg/m ³)	
NO ₂ ^f	1-hour	0.18 ppm (339 µg/m ³)	0.100 ppm (188 µg/m ³)	Same as Primary Standard
	Annual Arithmetic Mean	0.030 ppm (57 µg/m ³)	0.053 ppm (100 µg/m ³)	
SO ₂ ^g	1-hour	0.25 ppm (655 µg/m ³)	0.75 ppm (196 µg/m ³)	—
	3-hour	—	—	0.5 ppm (1300 µg/m ³)
	24-hour	0.04 ppm (105 µg/m ³)	0.14 ppm (for certain areas) ^g	—
	Annual Arithmetic Mean	—	0.030 ppm (for certain areas) ^g	—
PM ₁₀ ^h	24-hour	50 µg/m ³	150 µg/m ³	Same as Primary Standard
	Annual Arithmetic Mean	20 µg/m ³	—	
PM _{2.5} ^h	24-hour	—	35 µg/m ³	Same as Primary Standard
	Annual Arithmetic Mean	12 µg/m ³	12.0 µg/m ³	
Lead ^{i,j}	30-day Average	1.5 µg/m ³	—	—
	Calendar Quarter	—	1.5 µg/m ³ (for certain areas) ^j	Same as Primary Standard
	Rolling 3-Month Average	—	0.15 µg/m ³	
Hydrogen sulfide	1-hour	0.03 ppm (42 µg/m ³)	—	—
Vinyl chloride ⁱ	24-hour	0.01 ppm (26 µg/m ³)	—	—
Sulfates	24-hour	25 µg/m ³	—	—
Visibility reducing particles ^k	8-hour (10:00 a.m. to 6:00 p.m. PST)	See footnote k	—	—

Source: CARB 2013.

ppm= parts per million by volume; µg/m³ = micrograms per cubic meter; mg/m³= milligrams per cubic meter

^a California standards for ozone, carbon monoxide (except 8-hour Lake Tahoe), sulfur dioxide (1 and 24 hour), nitrogen dioxide, and particulate matter (PM₁₀, PM_{2.5}, and visibility reducing particles), are values that are not to be exceeded. All others are not to be equaled or exceeded. CAAQS are listed in the Table of Standards in Section 70200 of Title 17 of the California Code of Regulations.

^b National standards (other than O₃, NO₂, SO₂, particulate matter, and those based on annual averages or annual arithmetic mean) are not to be exceeded more than once a year. The O₃ standard is attained when the fourth highest 8-hour concentration in a year, averaged over 3 years, is

Air Quality and Greenhouse Gas Technical Report for the Carlsbad Desalination Plant Intake Modifications Project

equal to or less than the standard. For NO₂ and SO₂, the standard is attained when the 3-year average of the 98th and 99th percentile, respectively, of the daily maximum 1-hour average at each monitor within an area does not exceed the standard. For PM₁₀, the 24-hour standard is attained when the expected number of days per calendar year with a 24-hour average concentration above 150 µg/m³ is equal to or less than one. For PM_{2.5}, the 24-hour standard is attained when 98% of the daily concentrations, averaged over 3 years, are equal to or less than the standard.

- c Concentration expressed first in units in which it was promulgated. Equivalent units given in parentheses are based upon a reference temperature of 25°C and a reference pressure of 760 torr.
Most measurements of air quality are to be corrected to a reference temperature of 25°C and a reference pressure of 760 torr; ppm in this table refers to ppm by volume, or micromoles of pollutant per mole of gas.
- d National Primary Standards: The levels of air quality necessary, with an adequate margin of safety to protect the public health.
- e National Secondary Standards: The levels of air quality necessary to protect the public welfare from any known or anticipated adverse effects of a pollutant.
- f To attain the 1-hour national standard, the 3-year average of the annual 98th percentile of the 1-hour daily maximum concentrations at each site must not exceed 100 ppb. Note that the national 1-hour standard is in units of parts per billion (ppb). California standards are in units of parts per million (ppm). To directly compare the national 1-hour standard to the California standards, the units can be converted from ppb to ppm. In this case, the national standard of 100 ppb is identical to 0.100 ppm.
- g On June 2, 2010, a new 1-hour SO₂ standard was established and the existing 24-hour and annual primary standards were revoked. To attain the 1-hour national standard, the 3-year average of the annual 99th percentile of the 1-hour daily maximum concentrations at each site must not exceed 75 ppb. The 1971 SO₂ national standards (24-hour and annual) remain in effect until one year after an area is designated for the 2010 standard, except that in areas designated nonattainment for the 1971 standards, the 1971 standards remain in effect until implementation plans to attain or maintain the 2010 standards are approved.
- h On December 14, 2012, the national annual PM_{2.5} primary standard was lowered from 15 µg/m³ to 12 µg/m³. The existing national 24-hour PM_{2.5} standards (primary and secondary) were retained at 35 µg/m³, as was the annual secondary standard of 15 µg/m³. The existing 24-hour PM₁₀ standards (primary and secondary) of 150 µg/m³ also were retained. The form of the annual primary and secondary standards is the annual mean, averaged over 3 years.
- i CARB has identified lead and vinyl chloride as 'toxic air contaminants' with no threshold level of exposure for adverse health effects determined. These actions allow for the implementation of control measures at levels below the ambient concentrations specified for these pollutants.
- j The national standard for lead was revised on October 15, 2008 to a rolling 3-month average. The 1978 lead standard (1.5 µg/m³ as a quarterly average) remains in effect until 1 year after an area is designated for the 2008 standard, except that in areas designated nonattainment for the 1978 standard, the 1978 standard remains in effect until implementation plans to attain or maintain the 2008 standard are approved.
- k In 1989, CARB converted both the general statewide 10-mile visibility standard and the Lake Tahoe 30-mile visibility standard to instrumental equivalents, which are "extinction of 0.23 per kilometer" and "extinction of 0.07 per kilometer" for the statewide and Lake Tahoe Air Basin standards, respectively.

Toxic Air Contaminants

California regulates TACs primarily through the Tanner Air Toxics Act (Assembly Bill 1807) and the Air Toxics Hot Spots Information and Assessment Act of 1987 (Assembly Bill 2588). The Tanner Act sets forth a formal procedure for CARB to designate substances as TACs. This includes research, public participation, and scientific peer review before CARB can designate a substance as a TAC. To date, CARB has identified over 21 TACs and has adopted the EPA's list of hazardous air pollutants as TACs. Once a TAC is identified, CARB then adopts an airborne toxics control measure for sources that emit that particular TAC. If there is a safe threshold for a substance at which there is no toxic effect, the control measure must reduce exposure below that threshold. If there is no safe threshold, the measure must incorporate best available control technology for toxics to minimize emissions. None of the TACs identified by CARB have a safe threshold.

Under the Air Toxics "Hot Spots" Act existing facilities that emit air pollutants above specified level were required to (1) prepare a TAC emission inventory plan and report, (2) prepare a risk

Air Quality and Greenhouse Gas Technical Report for the Carlsbad Desalination Plant Intake Modifications Project

assessment if TAC emissions were significant, (3) notify the public of significant risk levels, and (4) if health impacts were above specified levels, prepare and implement risk reduction measures.

California Health and Safety Code Section 41700

This section of the Health and Safety Code states that a person shall not discharge from any source whatsoever quantities of air contaminants or other material that cause injury, detriment, nuisance, or annoyance to any considerable number of persons or to the public, or that endanger the comfort, repose, health, or safety of any of those persons or the public, or that cause, or have a natural tendency to cause, injury or damage to business or property. This section also applies to sources of objectionable odors.

4.3 Local

San Diego Air Pollution Control District

While CARB is responsible for the regulation of mobile emission sources within the state, local AQMDs and APCDs are responsible for enforcing standards and regulating stationary sources. The project site is located within the SDAB and is subject to the guidelines and regulations of the SDAPCD.

In San Diego County, O₃ and particulate matter are the pollutants of main concern, since exceedances of CAAQS for those pollutants are experienced here in most years. For this reason, the SDAB has been designated as a nonattainment area for the state PM₁₀, PM_{2.5}, and O₃ standards. The SDAB is also a federal O₃ attainment (maintenance) area for 1997 8-hour O₃ standard, a O₃ nonattainment area for the 2008 8-hour O₃ standard, and a CO maintenance area (western and central part of the SDAB only). The project area is in the CO maintenance area.

The SDAPCD and the San Diego Association of Governments (SANDAG) are responsible for developing and implementing the clean air plan for attainment and maintenance of the ambient air quality standards in the SDAB. The County *Regional Air Quality Strategy* (RAQS) was initially adopted in 1991, and is updated on a triennial basis, most recently in 2009 (SDAPCD 2009a). The RAQS outlines SDAPCD's plans and control measures designed to attain the state air quality standards for O₃. The RAQS relies on information from CARB and SANDAG, including mobile and area source emissions, and information regarding projected growth in the cities and San Diego County, to project future emissions and determine the strategies necessary for the reduction of emissions through regulatory controls. CARB mobile source emission projections and SANDAG growth projections are based on population, vehicle trends, and land use plans developed by the cities and San Diego County as part of the development of their general plans.

Air Quality and Greenhouse Gas Technical Report for the Carlsbad Desalination Plant Intake Modifications Project

The *Eight-Hour Ozone Attainment Plan for San Diego County* indicates that local controls and state programs would allow the region to reach attainment of the federal 1997 8-hour O₃ standard by 2009 (SDAPCD 2007). In this plan, SDAPCD relies on the RAQS to demonstrate how the region will comply with the federal O₃ standard. The RAQS details how the region will manage and reduce O₃ precursors (oxides of nitrogen (NO_x) and VOCs) by identifying measures and regulations intended to reduce these contaminants. The control measures identified in the RAQS generally focus on stationary sources; however, the emissions inventories and projections in the RAQS address all potential sources, including those under the authority of CARB and the EPA. Incentive programs for reduction of emissions from heavy-duty diesel vehicles, off-road equipment, and school buses are also established in the RAQS. According to the *Redesignation Request and Maintenance Plan for the 1997 National Ozone Standard for San Diego County*, the SDAB did not reach attainment of the federal 1997 standard until 2011 (SDAPCD 2012). This plan, however, demonstrates the region's attainment of the 1997 O₃ NAAQS and outlines the plan for maintaining attainment status.

In December 2005, SDAPCD prepared a report titled *Measures to Reduce Particulate Matter in San Diego County* to address implementation of Senate Bill (SB) 656 in San Diego County (SB 656 required additional controls to reduce ambient concentrations of PM₁₀ and PM_{2.5}) (SDAPCD 2005). In the report, SDAPCD evaluated the implementation of source-control measures that would reduce particulate matter emissions associated with residential wood combustion; various construction activities including earthmoving, demolition, and grading; bulk material storage and handling; carryout and trackout removal and cleanup methods; inactive disturbed land; disturbed open areas; unpaved parking lots/staging areas; unpaved roads; and windblown dust.

As stated earlier, the SDAPCD is responsible for planning, implementing, and enforcing federal and state ambient standards in the SDAB. The following rules and regulations apply to all sources in the jurisdiction of SDAPCD:

- **SDAPCD Regulation IV: Prohibitions; Rule 51: Nuisance.** Prohibits the discharge, from any source, of such quantities of air contaminants or other materials that cause or have a tendency to cause injury, detriment, nuisance, annoyance to people and/or the public, or damage to any business or property (SDAPCD 1969).
- **SDAPCD Regulation IV: Prohibitions; Rule 55: Fugitive Dust.** Regulates fugitive dust emissions from any commercial construction or demolition activity capable of generating fugitive dust emissions, including active operations, open storage piles, and

Air Quality and Greenhouse Gas Technical Report for the Carlsbad Desalination Plant Intake Modifications Project

inactive disturbed areas, as well as track-out and carry-out onto paved roads beyond a project site (SDAPCD 2009b).

- **SDAPCD Regulation IV: Prohibitions; Rule 67.0.1: Architectural Coatings.** Requires manufacturers, distributors, and end users of architectural and industrial maintenance coatings to reduce VOC emissions from the use of these coatings, primarily by placing limits on the VOC content of various coating categories (SDAPCD 2015).

Air Quality and Greenhouse Gas Technical Report for the Carlsbad Desalination Plant Intake Modifications Project

5 LOCAL AIR QUALITY

5.1 SDAB Attainment Designation

An area is designated in attainment when it is in compliance with the NAAQS and/or CAAQS. These standards are set by the EPA or CARB for the maximum level of a given air pollutant that can exist in the outdoor air without unacceptable effects on human health or the public welfare. The criteria pollutants of primary concern that are considered in this analysis are O₃, NO₂, CO, SO₂, PM₁₀, and PM_{2.5}. Although there are no ambient standards for VOCs or NO_x, they are important as precursors to O₃.

The portion of the SDAB where the project site is located is designated by the EPA as an attainment area for the 1997 8-hour NAAQS for O₃ and as a marginal nonattainment area for the 2008 8-hour NAAQS for O₃. The SDAB is designated in attainment for all other criteria pollutants under the NAAQS with the exception of PM₁₀, which was determined to be unclassifiable. The SDAB is currently designated nonattainment for O₃ and particulate matter, PM₁₀ and PM_{2.5}, under the CAAQS. It is designated attainment for the CAAQS for CO, NO₂, SO₂, lead, and sulfates.

Table 3, SDAB Attainment Classification, summarizes the SDAB's federal and state attainment designations for each of the criteria pollutants.

**Table 3
SDAB Attainment Classification**

Pollutant	Federal Designation ^a	State Designation ^b
O ₃ (1-hour)	Attainment ¹	Nonattainment
O ₃ (8-hour – 1997) (8-hour – 2008)	Attainment (Maintenance) Nonattainment (Marginal)	Nonattainment
CO	Unclassifiable/Attainment ²	Attainment
PM ₁₀	Unclassifiable ³	Nonattainment
PM _{2.5}	Attainment	Nonattainment
NO ₂	Unclassifiable/Attainment	Attainment
SO ₂	Attainment	Attainment
Lead	Attainment	Attainment
Sulfates	(no federal standard)	No designation
Hydrogen sulfide	(no federal standard)	Unclassified
Visibility-reducing particles	(no federal standard)	Unclassified

Sources:

^a EPA 2014a;

^b CARB 2014b.

¹ The federal 1-hour standard of 0.12 ppm was in effect from 1979 through June 15, 2005. The revoked standard is referenced here because it was employed for such a long period and because this benchmark is addressed in State Implementation Plans.

² The western and central portions of the SDAB are designated attainment, while the eastern portion is designated unclassifiable/attainment.

Air Quality and Greenhouse Gas Technical Report for the Carlsbad Desalination Plant Intake Modifications Project

³ At the time of designation, if the available data does not support a designation of attainment or nonattainment, the area is designated as unclassifiable.

5.2 Air Quality Monitoring Data

The SDAPCD operates a network of ambient air monitoring stations throughout San Diego County, which measure ambient concentrations of pollutants and determine whether the ambient air quality meets the CAAQS and the NAAQS. The SDAPCD monitors air quality conditions at 10 locations throughout the basin. The Camp Pendleton monitoring station concentrations for ozone, NO₂ and PM_{2.5} were selected as the representative monitoring location concentrations for the project. The Escondido – East Valley Parkway monitoring station is the most representative location where CO and PM₁₀ concentrations are monitored. The El Cajon – Redwood Avenue station is the closets station where SO₂ concentrations are monitored. Ambient concentrations of pollutants from 2010 through 2014 are presented in Table 4, Ambient Air Quality Data. The number of days exceeding the ozone AAQS is shown in Table 5, Frequency of Air Quality Standard Violations. The state 8-hour O₃ standards were exceeded in 2010, 2011, 2012 and 2014; while the federal 8-hour O₃ standard was exceeded in 2010, 2012 and 2014. The state 1-hour O₃ standard was exceeded in 2014. The federal 24-hour PM_{2.5} standard and state 24-hour PM₁₀ standard was exceeded in 2013. Air quality within the project region was in compliance with both CAAQS and NAAQS for NO₂, CO and SO₂ during this monitoring period.

Table 4
Ambient Air Quality Data
(ppm unless otherwise indicated)

Pollutant	Averaging Time	2010	2011	2012	2013	2014	Most Stringent Ambient Air Quality Standard	Monitoring Station
O ₃	8-hour	0.079	0.071	0.081	0.066	0.080	0.070	Camp Pendleton
	1-hour	0.092	0.085	0.092	0.078	0.097	0.090	
PM ₁₀	Annual	21.0 µg/m ³	18.8 µg/m ³	18.1 µg/m ³	23.1 µg/m ³	21.5 µg/m ³	20 µg/m ³	Escondido – East Valley Parkway
	24-hour	43.0 µg/m ³	40.0 µg/m ³	33.0 µg/m ³	82.0 µg/m ³	44.0 µg/m ³	50 µg/m ³	
PM _{2.5}	Annual*	7.9 µg/m ³	12.0 µg/m ³	10.7 µg/m ³	8.5 µg/m ³	10.7 µg/m ³	12 µg/m ³	Camp Pendleton
	24-hour	27.3 µg/m ³	30.7 µg/m ³	28.0 µg/m ³	42.3 µg/m ³	28.0 µg/m ³	35 µg/m ³	
NO ₂	Annual	0.009	N/A	0.008	N/A	0.007	0.030	Camp Pendleton
	1-hour	0.081	0.066	0.061	0.081	0.060	0.180	
CO	8-hour	2.46	2.30	3.70	2.60	3.10	9.0	Escondido – East Valley Parkway
	1-hour*	3.90	3.50	4.40	3.20	3.80	20	
SO ₂	Annual	N/A	0.000	N/A	N/A	N/A	0.030	El Cajon –

Air Quality and Greenhouse Gas Technical Report for the Carlsbad Desalination Plant Intake Modifications Project

Table 4
Ambient Air Quality Data
(ppm unless otherwise indicated)

Pollutant	Averaging Time	2010	2011	2012	2013	2014	Most Stringent Ambient Air Quality Standard	Monitoring Station
	24-hour	N/A	0.001	0.001	0.001	N/A	0.040	Redwood Avenue

Sources: CARB 2014c; EPA 2014b.

Notes: N/A = data not available. Data represent maximum values.

* Data were taken from EPA 2014b

Table 5
Frequency of Air Quality Standard Violations

Year	Number of Days Exceeding Standard				
	State 1-Hour O ₃	State 8-Hour O ₃	National 8-Hour O ₃	State 24-hour PM ₁₀ *	National 24-hour PM _{2.5} *
2010	0	1	1	0.0 (0)	N/A
2011	0	2	0	0.0 (0)	N/A
2012	0	1	1	0.0 (0)	0.0 (0)
2013	0	0	0	6.0 (1)	1.1 (1)
2014	1	6	1	0.0 (0)	N/A

Source: CARB 2014b.

Notes: N/A = data not available.

* Measurements of PM₁₀ and PM_{2.5} are usually collected every 6 days and daily, respectively. "Number of days exceeding the standards" is a mathematical estimate of the number of days concentrations would have been greater than the level of the standard had each day been monitored. The numbers in parentheses are the measured number of samples that exceeded the standard.

Air Quality and Greenhouse Gas Technical Report for the Carlsbad Desalination Plant Intake Modifications Project

INTENTIONALLY LEFT BLANK

Air Quality and Greenhouse Gas Technical Report for the Carlsbad Desalination Plant Intake Modifications Project

6 THRESHOLDS OF SIGNIFICANCE

The State of California has developed guidelines to address the significance of air quality impacts based on Appendix G of the California Environmental Quality Act (CEQA) Guidelines (14 CCR 15000 et seq.), which provides guidance that a project would have a significant environmental impact if it would:

1. Conflict with or obstruct the implementation of the applicable air quality plan;
2. Violate any air quality standard or contribute substantially to an existing or projected air quality violation;
3. Result in a cumulatively considerable net increase of any criteria pollutant for which the project region is nonattainment under an applicable federal or state ambient air quality standard (including releasing emissions which exceed quantitative thresholds for O₃ precursors);
4. Expose sensitive receptors to substantial pollutant concentrations; or
5. Create objectionable odors affecting a substantial number of people.

SDAPCD

As part of its air quality permitting process, the SDAPCD has established thresholds in Rule 20.2 requiring the preparation of Air Quality Impact Assessments for permitted stationary sources. The SDAPCD sets forth quantitative emission thresholds below which a stationary source would not have a significant impact on ambient air quality. Project-related air quality impacts estimated in this environmental analysis would be considered significant if any of the applicable significance thresholds presented in Table 6, SDAPCD Air Quality Significance Thresholds, are exceeded.

For CEQA purposes, these screening criteria can be used as numeric methods to demonstrate that a project's total emissions would not result in a significant impact to air quality.

Table 6
SDAPCD Air Quality Significance Thresholds

Construction Emissions	
Pollutant	Total Emissions (Pounds per Day)
Respirable Particulate Matter (PM ₁₀)	100
Fine Particulate Matter (PM _{2.5})	55
Oxides of Nitrogen (NO _x)	250
Oxides of Sulfur (SO _x)	250
Carbon Monoxide (CO)	550
Volatile Organic Compounds (VOC)	75*

Air Quality and Greenhouse Gas Technical Report for the Carlsbad Desalination Plant Intake Modifications Project

Table 6
SDAPCD Air Quality Significance Thresholds

Operational Emissions			
<i>Pollutant</i>	<i>Total Emissions</i>		
	<i>Pounds per Hour</i>	<i>Pounds per Day</i>	<i>Pounds per Year</i>
Respirable Particulate Matter (PM ₁₀)	—	100	15
Fine Particulate Matter (PM _{2.5})	—	55	10
Oxides of Nitrogen (NO _x)	25	250	40
Sulfur Oxides (SO _x)	25	250	40
Carbon Monoxide (CO)	100	550	100
Lead and Lead Compounds	—	3.2	0.6
Volatile Organic Compounds (VOC)	—	75*	13.7

Sources: SDAPCD Rules 1501 (SDAPCD 1995) and 20.2(d)(2) (SDAPCD 1998).

* VOC threshold based on the threshold of significance for VOCs from the South Coast Air Quality Management District for the Coachella Valley as stated in the San Diego County Guidelines for Determining Significance.

The thresholds listed in Table 6 represent screening-level thresholds that can be used to evaluate whether project-related emissions would cause a significant impact on air quality. Emissions below the screening-level thresholds would not cause a significant impact. In the event that emissions exceed these thresholds, modeling would be required to demonstrate that the project's total air quality impacts result in ground-level concentrations that are below the CAAQS and NAAQS, including appropriate background levels. For non-attainment pollutants, if emissions exceed the thresholds shown in Table 6, the project could have the potential to result in a cumulatively considerable net increase in these pollutants and thus could have a significant impact on the ambient air quality.

With respect to odors, SDAPCD Rule 51 (Public Nuisance) prohibits emission of any material that causes nuisance to a considerable number of persons or endangers the comfort, health, or safety of any person. A project that proposes a use that would produce objectionable odors would be deemed to have a significant odor impact if it would affect a considerable number of off-site receptors.

Air Quality and Greenhouse Gas Technical Report for the Carlsbad Desalination Plant Intake Modifications Project

7 IMPACTS

7.1 Consistency with Air Quality Plans

The SDAPCD and SANDAG are responsible for developing and implementing the clean air plans for attainment and maintenance of the AAQS in the SDAB; specifically, the SIP and RAQS.³ The federal O₃ maintenance plan, which is part of the SIP, was adopted in 2012. The SIP includes a demonstration that current strategies and tactics will maintain acceptable air quality in the SDAB based on the NAAQS. The RAQS was initially adopted in 1991 and is updated on a triennial basis (most recently in 2009). The RAQS outlines SDAPCD's plans and control measures designed to attain the state air quality standards for O₃. The SIP and RAQS rely on information from CARB and SANDAG, including mobile and area source emissions, as well as information regarding projected growth in San Diego County and the cities in county, to project future emissions and then determine from that the strategies necessary for the reduction of emissions through regulatory controls. CARB mobile source emission projections and SANDAG growth projections are based on population, vehicle trends, and land use plans developed by San Diego County and the cities in the county as part of the development of their general plans.

If a project proposes development that is greater than that anticipated in the local plan and SANDAG's growth projections, the project might be in conflict with the SIP and RAQS and may contribute to a potentially significant cumulative impact on air quality. The proposed modifications would be consistent with the existing zoning and General Plan land use designations for the project site, and would modify the existing on-site facility. Additionally, the proposed modifications would neither include a residential component that would increase local population growth.

San Diego County's population and employment base have grown and are expected to continue to grow at moderate rates and water demand is expected to increase as a direct function of this growth (Department of Finance 2012; 2015; & SANDAG 2013). Various long range planning documents for the regions water supply and demand, including SANDAG's Regional Comprehensive Plan's (RCP's) and the Water Authority's 2013 Regional Water Facilities Optimization and Master Plan Update (Master Plan), call for the region to diversify its water supply portfolio to become less reliant on a single supply source. In meeting future water needs, the RCP anticipates that the 2020 normal year projection for water supplies will include between 6% and 15% seawater desalination. The approved CDP represents approximately 6% of

³ For the purpose of this discussion, the relevant federal air quality plan is the ozone maintenance plan (SDAPCD 2012). The RAQS is the applicable plan for purposes of state air quality planning. Both plans reflect growth projections in the SDAB.

Air Quality and Greenhouse Gas Technical Report for the Carlsbad Desalination Plant Intake Modifications Project

projected 2020 demands. The Water Authority's later projection's present a more conservation 7% to 10% of 2020 demands (SANDAG 2015). Furthermore, the Water Authority's 2013 Master Plan identifies the CDP as an approved and fully permitted seawater desalination plant and pipeline project (San Diego County Water Authority 2014). The 2013 Master Plan also anticipates the proposed Camp Pendleton Desalination Project, which would provide a new water supply of up to 150 MGD to the San Diego region (San Diego County Water Authority 2014). SANDAG's RCP and the Water Authority's supply projections offer a range of flexibility for the excepted provision of desalinated water that also includes an additional desalination plant at Camp Pendleton. While the additional 10 MGD of average potable water output resulting from the proposed project would be above current regional growth and water projections sourced from the CDP, given that future additional water supply is planned to be sourced from desalinated water through the proposed development of the Camp Pendleton Desalination Plant, the proposed project would not result in substantial growth beyond current projections. Therefore, it is not anticipated that delivery of water from a different supplier would have any effect on planned growth within the service area of the proposed project.

Section 4.2 of the Final Supplemental Program EIR for the 2013 Master Plan (incorporated by reference herein) discusses the growth-inducing potential for the master plan, which includes consideration of approved and projected seawater desalination water supply component, and concludes that the 2013 Master Plan would not induce substantial growth directly, as it does not provide a vehicle for land use decisions, and indirectly, as it is too speculative to assume that an increase in water supply available would be the sole barrier to growth when all other barriers (access, land use planning, public services and other utilities) would not be removed by an increase in water supply. Similar to the analysis found in the Final Supplemental Program EIR for the 2013 Master Plan, the availability of additional water supply would not directly induce growth; the proposed project would not result in, provide for, or approve land development beyond the facilities associated with the CDP. Furthermore, it is not anticipated that the purchase of water from a different supplier by any of the affected water agencies would result in any changes to existing land use plans, growth projections or growth management policies of the local land use authorities within the respective service areas of the districts.

Based on the nature of the proposed water utilities infrastructure improvements, implementation of the proposed modifications would not result in development in excess of that anticipated in local plans or increases in population/housing growth beyond those contemplated by SANDAG. As such, vehicle trip generation and planned development for the various project component locations is considered to be anticipated in the SIP and RAQS. Because the proposed land uses and associated vehicle trips are anticipated in local air quality plans, the proposed modifications would be consistent at a regional level with the underlying growth forecasts in the RAQS. Impacts would be **less than significant**.

Air Quality and Greenhouse Gas Technical Report for the Carlsbad Desalination Plant Intake Modifications Project

7.2 Construction Impacts

Construction of the project modifications would result in a temporary addition of pollutants to the local airshed caused by soil disturbance, fugitive dust emissions, and combustion pollutants from on-site construction equipment, as well as from off-site trucks hauling construction materials. Construction emissions can vary substantially from day to day, depending on the level of activity, the specific type of operation, and, for dust, the prevailing weather conditions. Fugitive dust (PM₁₀ and PM_{2.5}) emissions would primarily result from grading and site preparation activities. NO_x and CO emissions would primarily result from the use of construction equipment and motor vehicles.

Emissions from the construction phase of project were estimated using the California Emissions Estimator Model (CalEEMod) Version 2013.2.2, available online (www.caleemod.com). For the purposes of modeling, it was assumed that construction of the project would commence in July 2016 and would occur intermittently over an approximately 18-month period. Table 7 shows the anticipated construction schedule by phase.

**Table 7
Construction Schedule**

Phase	Duration
<i>Intake Structure</i>	
Phase 1a – Site Preparation	1 week
Phase 1b – Asphalt Removal	1 week
Phase 2a – Sheet Piling	18 weeks
Phase 2b – Excavation	18 weeks
Phase 3 – Building Construction	12 weeks
Phase 4 – Demolition	16 weeks
Phase 5 – Backfill	6 weeks
Phase 6a – Grading	1 week
Phase 6b – Paving	1 week
<i>Axial Pumps</i>	
Phase 1 – Paving	2 weeks
Phase 2 – Axial Pump Installation	8 weeks
Phase 3a – Trenching	4 weeks
Phase 3b – Paving	4 weeks
Phase 4 – Building Construction	4 weeks
Phase 5 – Architectural Coatings	2 weeks

Air Quality and Greenhouse Gas Technical Report for the Carlsbad Desalination Plant Intake Modifications Project

Site preparation for the intake structure would consist of approximately 7,000 square feet of vegetation clearing and 20,000 square feet of asphalt removal, which would be exported off site. Grading and paving activities would cover approximately 27,000 square feet. Following cut and fill activities, approximately 9,700 cubic yards of soil would be exported off site.

Equipment mix assumptions for construction activity are based on typical infrastructure construction practices and CalEEMod default equipment where appropriate. The equipment mix is meant to represent a reasonably conservative estimate of construction activity. For the analysis, it is generally assumed that heavy construction equipment would be operating at the site for approximately 8 hours per day, 5 days per week. Construction schedule, equipment fleet, construction worker trips, vendor trips and soil hauling quantities were provided by the project applicant. A detailed depiction of the construction schedule — including information regarding subphases and equipment assumed for each subphase—is included in Attachment A of this report. The information contained in Attachment A was used as CalEEMod model inputs.

Construction of project components would be subject to SDAPCD Rule 55 – Fugitive Dust Control. This rule requires that construction of the project include steps to restrict visible emissions of fugitive dust beyond the property line (SDAPCD 2009b). Compliance with Rule 55 would limit fugitive dust (PM₁₀ and PM_{2.5}) that may be generated during grading and construction activities. Construction of the project would also be subject to SDAPCD Rule 67.0.1 – Architectural Coatings. This rule requires manufacturers, distributors, and end users of architectural and industrial maintenance coatings to reduce VOC emissions from the use of these coatings, primarily by placing limits on the VOC content of various coating categories (SDAPCD 2015).

Table 8, Estimated Maximum Daily Construction Emissions - Unmitigated, shows the estimated maximum unmitigated daily construction emissions associated with the construction phases of the project. Complete details of the emissions calculations are provided in Attachment A of this document.

Table 8
Estimated Maximum Daily Construction Emissions (pounds per day)

Year	VOC	NO _x	CO	SO _x	PM ₁₀	PM _{2.5}
2016	3.89	37.50	24.35	0.05	3.48	2.17
2017	17.13	179.35	98.69	0.24	8.20	7.32
2018	15.12	153.76	91.47	0.24	7.00	6.19
Maximum Daily Emissions	17.13	179.35	98.69	0.24	8.20	7.32
<i>Emission Threshold</i>	75	250	550	250	100	55
Threshold Exceeded?	No	No	No	No	No	No

Air Quality and Greenhouse Gas Technical Report for the Carlsbad Desalination Plant Intake Modifications Project

Source: CalEEMod Version 2013.2.2. See Attachment A for complete results.

The values shown are the maximum summer or winter daily emissions results from CalEEMod.

VOC = volatile organic compound; NO_x = oxides of nitrogen; CO = carbon monoxide; SO_x = sulfur oxides; PM₁₀ = coarse particulate matter; PM_{2.5} = fine particulate matter

As shown in Table 8, daily construction emissions for the proposed project would not exceed the County of San Diego's significance thresholds for VOC, NO_x, CO, SO_x, PM₁₀, or PM_{2.5}. Impacts would be less than significant, and no mitigation is required.

7.3 Operational Impacts

Under the proposed modifications, the CDP could produce an additional annual average 10 million gallons per day (mgd) of product water. The added 10 mgd of product water would require additional electricity during operation of the CDP that would result in indirect GHG emissions from electrical generation. The potential production of an additional 10 mgd would result in an estimated maximum of 7.2 megawatt hours (MWh) of electricity. In addition to this potential 10 mgd annual average increase in production capacity, the proposed modifications would involve use of new traveling screen motors and increased pumping that would require an additional 1.7 MWh of electricity during operations, for a total increase of 8.9 MWh. The generation of electricity through combustion of fossil fuels typically results in emissions of CO₂ and, to a smaller extent, CH₄ and N₂O.

The CDP and proposed modifications would be provided electricity from the electrical grid within the San Diego Gas & Electric (SDG&E) service area. Although the proposed modifications are anticipated to begin operation in 2018, the 2014 SDG&E carbon intensity factor for electrical generation of 626.11 pounds of CO₂E per MWh was conservatively used in determining the estimated annual GHG emissions from the proposed modifications (SDG&E 2015). As such, the potential operation of the CDP to produce the additional annual average of 10 mgd of product water and to operate the new traveling screens motors and increased pumping would result in approximately 22,092 MT CO₂E per year (see Attachment B for details).

The Special Conditions of the Coastal Development Permit by the CCC require implementation of an Energy Minimization and GHG Reduction Plan, which requires the purchase of carbon offsets to "zero-out" the CDP's net indirect emissions that are not otherwise reduced or offset through other measures. As a result, the GHG emissions for the CDP and the proposed modifications would be reduced to "net zero" through implementation of the Energy Minimization and GHG Reduction Plan. The combination of proposed modifications, amortized CO₂E at well below the screening levels, and an operational emissions commitment to be "net zero" means that construction of the proposed modifications and operation of the CDP would not

Air Quality and Greenhouse Gas Technical Report for the Carlsbad Desalination Plant Intake Modifications Project

exceed the County of San Diego's 900 MT CO₂E per year screening threshold, and the project would have a less-than-significant impact from GHG emissions.

7.4 Cumulative Impacts

In analyzing cumulative impacts from the proposed project, the analysis must specifically evaluate a proposed project's contribution to the cumulative increase in pollutants for which the SDAB is designated as nonattainment for the CAAQS and NAAQS. If the proposed project does not exceed thresholds and is determined to have less-than-significant project-specific impacts, it may still contribute to a significant cumulative impact on air quality if the emissions from the project, in combination with the emissions from other proposed or reasonably foreseeable future projects, are in excess of established thresholds. However, the project would only be considered to have a significant cumulative impact if its contribution accounts for a significant proportion of the cumulative total emissions (i.e., it represents a "cumulatively considerable contribution" to the cumulative air quality impact).

Additionally, for the San Diego Air Basin, the RAQS serves as the long-term regional air quality planning document for the purpose of assessing cumulative operational emissions within the basin to ensure the SDAB continues to make progress toward NAAQS and CAAQS attainment status. As such, cumulative projects located in the San Diego region would have the potential to result in a cumulative impact to air quality if, in combination, they would conflict with or obstruct implementation of the RAQS. Similarly, individual projects that are inconsistent with the regional planning documents upon which the RAQS is based would have the potential to result in cumulative impacts if they represent development beyond regional projections.

The SDAB has been designated as a federal nonattainment area for O₃ and a state nonattainment area for O₃, PM₁₀, and PM_{2.5}. PM₁₀ and PM_{2.5} emissions associated with construction generally result in near-field impacts. The nonattainment status is the result of cumulative emissions from all sources of these air pollutants and their precursors within the SDAB. As discussed in Section 7.2, the emissions of all criteria pollutants would be below the significance thresholds. Construction would be short term and temporary in nature lasting approximately 18 months. Additionally, construction activities required for the implementation of project modifications would be considered typical of a utility infrastructure project and would not require atypical construction practices that would include high-emitting activities. Once construction is completed, construction-related emissions would cease. Operational emissions generated by the project would not result in a significant impact. As such, the project would result in less-than-significant impacts to air quality relative to operational emissions.

Air Quality and Greenhouse Gas Technical Report for the Carlsbad Desalination Plant Intake Modifications Project

Regarding long-term cumulative operational emissions in relation to consistency with local air quality plans, the SIP and RAQS serve as the primary air quality planning documents for the state and SDAB, respectively. The SIP and RAQS rely on SANDAG growth projections based on population, vehicle trends, and land use plans developed by the cities and by the county as part of the development of their general plans. Therefore, projects that propose development that is consistent with the growth anticipated by local plans would be consistent with the SIP and RAQS and would not be considered to result in cumulatively considerable impacts from operational emissions. As discussed in Section 7.1, the project is consistent with the existing zoning and land use designations on site. Additionally, implementation of the project would not result in additional population growth or substantial growth-inducing effects that have not been anticipated in local planning documents; thus, it would be consistent at a regional level with the underlying growth forecasts in the SIP and RAQS. As a result, the project would not result in a cumulatively considerable contribution to regional O₃ concentrations or other criteria pollutant emissions. Cumulative impacts would be **less than significant**.

7.5 Toxic Air Contaminants

In addition to impacts from criteria pollutants, project impacts may include emissions of pollutants identified by the state and federal government as TACs or hazardous air pollutants (HAPs). State law has established the framework for California's TAC identification and control program, which is generally more stringent than the federal program, and is aimed at TACs that are a problem in California. The state has formally identified more than 200 substances as TACs, including the federal HAPs, and is adopting appropriate control measures for sources of these TACs.

The greatest potential for TAC emissions during construction would be diesel particulate emissions from heavy equipment operations and heavy-duty trucks, and the associated health impacts to sensitive receptors. The closest sensitive receptors to the project site are single family residential homes located 0.33 mile south.

Health effects from carcinogenic air toxics are usually described in terms of cancer risk. The SDAPCD recommends an incremental cancer risk threshold of 10 in a million. "Incremental cancer risk" is the likelihood that a person continuously exposed to concentrations of TACs resulting from a project over a 70-year lifetime will contract cancer based on the use of standard risk-assessment methodology. Construction of the proposed project would not require the extensive use of heavy-duty construction equipment, which is subject to a CARB Airborne Toxics Control Measure for in-use diesel construction equipment to reduce diesel particulate emissions, and would not involve extensive use of diesel trucks, which are also subject to an ATCM. Construction of the proposed project would occur over 18 months. Following completion of construction activities, project-related TAC emissions would cease. Additionally, operational

Air Quality and Greenhouse Gas Technical Report for the Carlsbad Desalination Plant Intake Modifications Project

emission sources would reflect that of the existing facility; therefore, no additional sources of TACs would occur during project operations. Therefore, the project would not result in a long-term (i.e., 70-year), permanent source of TAC emissions. No residual TAC emissions and corresponding cancer risk are anticipated after construction, nor are any long-term sources of TAC emissions anticipated during operation of the project. As such, the exposure of project-related TAC emission impacts to sensitive receptors would be less than significant.

7.6 Odors

Odors would be generated from vehicles and/or equipment exhaust emissions during construction of the project. Odors produced during construction would be attributable to concentrations of unburned hydrocarbons from tailpipes of construction equipment and architectural coatings. Such odors are temporary and for the types of construction activities anticipated for the project, would generally occur at magnitudes that would not affect substantial numbers of people. Therefore, impacts associated with odors during construction would be considered less than significant.

Due to the subjective nature of odor impacts, the number of variables that can influence the potential for an odor impact, and the variety of odor sources, there are no quantitative or formulaic methodologies to determine if potential odors would have a significant impact. Examples of land uses and industrial operations that are commonly associated with odor complaints include agricultural uses, wastewater treatment plants, food processing facilities, chemical plants, composting, refineries, landfills, dairies, and fiberglass molding. In addition to the odor source, the distance between the sensitive receptor(s) and the odor source, as well as the local meteorological conditions, are considerations in the potential for a project to frequently expose the public to objectionable odors. Although localized air quality impacts are focused on potential impacts to sensitive receptors, such as residences and schools, other land uses where people may congregate (e.g., workplaces) or uses with the intent to attract people (e.g., restaurants and visitor-serving accommodations), should also be considered in the evaluation of potential odor nuisance impacts.

The proposed project would include upgrades and modifications to the existing on-site facility would not result in the creation of a land use or process that is associated with nuisance odors. Therefore, project operations would result in an odor impact that is less than significant.

Air Quality and Greenhouse Gas Technical Report for the Carlsbad Desalination Plant Intake Modifications Project

8 SUMMARY AND CONCLUSIONS

The air quality impact analysis evaluates the potential for significant adverse impacts to the ambient air quality due to construction and operational emissions resulting from the proposed project. Construction of the proposed project would result in a temporary addition of pollutants to the local airshed caused by soil disturbance, fugitive dust emissions, and combustion pollutants from on-site construction equipment, as well as from off-site trucks hauling construction materials. The analysis concludes that the daily construction emissions would not exceed the County's significance thresholds for criteria pollutants, and impacts during construction would be **less than significant**. The project would not result in operational emissions beyond existing activities for the existing on-site facility; therefore, impacts during project operation would be **less than significant**. Additionally, impacts to sensitive receptors during temporary construction activities and operation of the proposed project were determined to be **less than significant**. Lastly, the proposed project would not result in a new land use or process associated with nuisance odors; therefore, odor impacts would be considered **less than significant**.

Air Quality and Greenhouse Gas Technical Report for the Carlsbad Desalination Plant Intake Modifications Project

INTENTIONALLY LEFT BLANK

Air Quality and Greenhouse Gas Technical Report for the Carlsbad Desalination Plant Intake Modifications Project

9 GREENHOUSE GASES

9.1 Background

9.1.1 The Greenhouse Effect and Greenhouse Gases

Climate change refers to any significant change in measures of climate, such as temperature, precipitation, or wind, lasting for an extended period (decades or longer). Gases that trap heat in the atmosphere are often called “greenhouse gases” (GHGs). The greenhouse effect traps heat in the troposphere through a threefold process as follows: Short-wave radiation emitted by the Sun is absorbed by the Earth; the Earth emits a portion of this energy in the form of long-wave radiation; and GHGs in the upper atmosphere absorb this long-wave radiation and emit it into space and toward the Earth. This “trapping” of the long-wave (thermal) radiation emitted back toward the Earth is the underlying process of the greenhouse effect. Principal GHGs include carbon dioxide (CO₂), methane (CH₄), nitrous oxide (N₂O), ozone (O₃), and water vapor (H₂O). Some GHGs, such as CO₂, CH₄, and N₂O, occur naturally and are emitted to the atmosphere through natural processes and human activities. Of these gases, CO₂ and CH₄ are emitted in the greatest quantities from human activities. Emissions of CO₂ are largely byproducts of fossil fuel combustion, whereas CH₄ results mostly from off-gassing associated with agricultural practices and landfills. Man-made GHGs, which have a much greater heat-absorption potential than CO₂, include fluorinated gases, such as hydrofluorocarbons (HFCs), perfluorocarbons (PFCs), sulfur hexafluoride (SF₆), and nitrogen trifluoride (NF₃), which are associated with certain industrial products and processes (CAT 2015).

Temperatures are projected to rise 2°F to 4°F in most areas of the United States over the next few decades. Reductions in some short-lived human-induced emissions that contribute to warming, such as black carbon (soot) and methane, could reduce some of the projected warming over the next couple of decades, because, unlike carbon dioxide, these gases and particles have relatively short atmospheric lifetimes. The amount of warming projected beyond the next few decades is directly linked to the cumulative global emissions of heat-trapping gases and particles. By the end of this century, a roughly 3°F to 5°F rise is projected under a lower emissions scenario, which would require substantial reductions in emissions, and a 5°F to 10°F rise for a higher emissions scenario assuming continued increases in emissions, predominantly from fossil fuel combustion (National Climatic Data Center 2014).

The effect each GHG has on climate change is measured as a combination of the mass of its emissions and the potential of a gas or aerosol to trap heat in the atmosphere, known as its “global warming potential” (GWP). GWP varies between GHGs; for example, the GWP of CH₄ is 21, and the GWP of N₂O is 310. Total GHG emissions are expressed as a function of how

Air Quality and Greenhouse Gas Technical Report for the Carlsbad Desalination Plant Intake Modifications Project

much warming would be caused by the same mass of CO₂. Thus, GHG gas emissions are typically measured in terms of pounds or tons of “CO₂ equivalent” (CO₂E).⁴

9.1.2 Contributions to Greenhouse Gas Emissions

In 2012, the United States produced 6,525 million metric tons (MMT) of CO₂E (EPA 2014c). The primary GHG emitted by human activities in the United States was CO₂, representing approximately 82.5% of total GHG emissions. The largest source of CO₂, and of overall GHG emissions, was fossil-fuel combustion, which accounted for approximately 94.2% of the CO₂ emissions.

According to the 2012 GHG inventory data compiled by the California Air Resources Board (CARB) for the California Greenhouse Gas Inventory for 2000–2012, California emitted 459 MMT CO₂E of GHGs, including emissions resulting from out-of-state electrical generation (CARB 2014d). The primary contributors to GHG emissions in California are transportation, industry, electric power production from both in-state and out-of-state sources, agriculture, and other sources, which include commercial and residential activities. GHG emissions associated with water and wastewater supply, treatment and conveyance are included in residential, commercial, industrial activities as well as electrical consumption associated with treatment and conveyance. These primary contributors to California’s GHG emissions and their relative contributions in 2012 are presented in Table 9.

**Table 9
GHG Sources in California**

Source Category	Annual GHG Emissions (MMT CO ₂ E)	% of Total ^a
Agriculture	37.86	8.3%
Commercial uses	14.20	3.1%
Electric power	95.09 ^b	20.7%
Industrial uses	89.16	19.4%
Recycling and waste	8.49	1.9%
Residential uses	28.09	6.1%
Transportation	167.38	36.5%
High GWP substances	18.41	4.0%
Totals^c	458.68	100%

Source: CARB 2014d.

⁴ The CO₂ equivalent for a gas is derived by multiplying the mass of the gas by the associated GWP, such that metric tons of CO₂E = (metric tons of a GHG) × (GWP of the GHG). CalEEMod assumes that the GWP for CH₄ is 21, which means that emissions of 1 metric ton of CH₄ are equivalent to emissions of 21 metric tons of CO₂, and the GWP for N₂O is 310, based on the Intergovernmental Panel on Climate Change (IPCC) Second Assessment Report. Although the IPCC has released subsequent Assessment Reports with updated GWPs, CARB reporting and other statewide documents utilize the GWP in the IPCC Second Assessment Report. As such, it is appropriate to use the hardwired GWP values in CalEEMod from the IPCC Second Assessment Report.

Air Quality and Greenhouse Gas Technical Report for the Carlsbad Desalination Plant Intake Modifications Project

MMT CO₂E = million metric tons of carbon dioxide equivalent

^a Percentage of total has been rounded.

^b Includes emissions associated with imported electricity, which account for 44.07 MMT CO₂E annually.

^c Totals may not sum due to rounding.

9.1.3 Potential Effects of Human Activity on Climate Change

According to CARB, some of the potential impacts in California of global warming may include loss in snow pack, sea level rise, more extreme heat days per year, more high O₃ days, more large forest fires, and more drought years (CAT 2010a). Several recent studies have attempted to explore the possible negative consequences that climate change, left unchecked, could have in California. These reports acknowledge that climate scientists' understanding of the complex global climate system, and the interplay of the various internal and external factors that affect climate change, remains too limited to yield scientifically valid conclusions on such a localized scale. Substantial work has been done at the international and national level to evaluate climatic impacts, but far less information is available on regional and local impacts.

The primary effect of global climate change has been a rise in average global tropospheric temperature of 0.2°C per decade, determined from meteorological measurements worldwide between 1990 and 2005.

Although climate change is driven by global atmospheric conditions, climate change impacts are felt locally. Climate change is already affecting California: Average temperatures have increased, leading to more extreme hot days and fewer cold nights; shifts in the water cycle have been observed, with less winter precipitation falling in the form of snow, and both snowmelt and rainwater running off earlier in the year; sea levels have risen; and wildland fires are becoming more frequent and intense due to dry seasons that start earlier and end later (CAT 2010a). Climate change modeling using 2000 emission rates shows that further warming would occur, which would induce further changes in the global climate system during the current century. Changes to the global climate system and ecosystems and to California would include, but would not be limited to:

- Changes in precipitation or melting snow and ice that are altering hydrological systems and affecting water resources in terms of quantity and/or quality (IPCC 2014).
- Changes in terrestrial, freshwater and marine specific as to their geographic ranges, seasonal activities, migration patterns and species interactions (IPCC 2014).
- Negative impacts on agricultural crop yields (IPCC 2014).
- Impacts from climate-related extremes such as heat waves, droughts, floods, wildfires and other natural disasters (IPCC 2014).

Air Quality and Greenhouse Gas Technical Report for the Carlsbad Desalination Plant Intake Modifications Project

- A decline of Sierra snowpack, which is one of three primary water sources in California (in addition to reservoirs and groundwater). The Sierra Nevada snowpack is currently at 14% of normal (California Department of Water Resources 2015).
- Rising regional sea level increases high-tide water levels and augments extreme storm-forced sea-level fluctuations, allowing more wave energy to reach farther shoreward and thus increasing the potential for coastal flooding (CEC 2012a).

Air Quality and Greenhouse Gas Technical Report for the Carlsbad Desalination Plant Intake Modifications Project

10 REGULATORY SETTING

10.1 Federal Activities

Massachusetts vs. EPA. On April 2, 2007, in *Massachusetts v. EPA*, the Supreme Court directed the U.S. Environmental Protection Agency (EPA) Administrator to determine whether GHG emissions from new motor vehicles cause or contribute to air pollution that may reasonably be anticipated to endanger public health or welfare, or whether the science is too uncertain to make a reasoned decision. In making these decisions, the EPA Administrator is required to follow the language of Section 202(a) of the Clean Air Act (CAA). On December 7, 2009, the Administrator signed a final rule with two distinct findings regarding GHGs under Section 202(a) of the CAA:

- The Administrator found that elevated concentrations of GHGs—CO₂, CH₄, N₂O, HFCs, PFCs, and SF₆—in the atmosphere threaten the public health and welfare of current and future generations. This is referred to as the “endangerment finding.”
- The Administrator further found the combined emissions of GHGs—CO₂, CH₄, N₂O, and HFCs—from new motor vehicles and new motor vehicle engines contribute to the GHG air pollution that endangers public health and welfare. This is referred to as the “cause or contribute finding.”

These two findings were necessary to establish the foundation for regulation of GHGs from new motor vehicles as air pollutants under the CAA.

Energy Independence and Security Act. On December 19, 2007, President Bush signed the Energy Independence and Security Act of 2007. Among other key measures, the Act would do the following, which would aid in the reduction of national GHG emissions:

1. Increase the supply of alternative fuel sources by setting a mandatory Renewable Fuel Standard (RFS) requiring fuel producers to use at least 36 billion gallons of biofuel in 2022.
2. Set a target of 35 miles per gallon (mpg) for the combined fleet of cars and light trucks by model year 2020 and direct National Highway Traffic Safety Administration (NHTSA) to establish a fuel economy program for medium- and heavy-duty trucks and create a separate fuel economy standard for work trucks.
3. Prescribe or revise standards affecting regional efficiency for heating and cooling products and procedures for new or amended standards, energy conservation, energy efficiency labeling for consumer electronic products, residential boiler efficiency, electric motor efficiency, and home appliances.

Air Quality and Greenhouse Gas Technical Report for the Carlsbad Desalination Plant Intake Modifications Project

EPA and NHTSA Joint Final Rule for Vehicle Standards. On April 1, 2010, the EPA and NHTSA announced a joint final rule to establish a national program consisting of new standards for light-duty vehicles model years 2012 through 2016. The joint rule is intended to reduce GHG emissions and improve fuel economy. The EPA is finalizing the first-ever national GHG emissions standards under the CAA, and NHTSA is finalizing Corporate Average Fuel Economy (CAFE) standards under the Energy Policy and Conservation Act (EPA 2010). This final rule follows the EPA and Department of Transportation's joint proposal on September 15, 2009, and is the result of President Obama's May 2009 announcement of a national program to reduce greenhouse gases and improve fuel economy (EPA 2011). The final rule became effective on July 6, 2010 (75 FR 25324–25728).

The EPA GHG standards require new passenger cars, light-duty trucks, and medium-duty passenger vehicles to meet an estimated combined average emissions level of 250 grams of CO₂ per mile in model year 2016, equivalent to 35.5 mpg if the automotive industry were to meet this CO₂ level through fuel economy improvements alone. The CAFE standards for passenger cars and light trucks will be phased in between 2012 and 2016, with the final standards equivalent to 37.8 mpg for passenger cars and 28.8 mpg for light trucks, resulting in an estimated combined average of 34.1 mpg. Together, these standards will cut GHG emissions by an estimated 960 MMT and 1.8 billion barrels of oil over the lifetime of the vehicles sold under the program. The rules will simultaneously reduce GHG emissions, improve energy security, increase fuel savings, and provide clarity and predictability for manufacturers (EPA 2011).

In August 2012, the EPA and NHTSA approved a second round of GHG and CAFE standards for model years 2017 and beyond (77 FR 62623–63200). These standards will reduce motor vehicle GHG emissions to 163 grams of CO₂ per mile, which is equivalent to 54.5 mpg if this level were achieved solely through improvements in fuel efficiency, for cars and light-duty trucks by model year 2025. A portion of these improvements, however, will likely be made through improvements in air conditioning leakage and through use of alternative refrigerants, which would not contribute to fuel economy. The first phase of the CAFE standards, for model year 2017 to 2021, are projected to require, on an average industry fleet-wide basis, a range from 40.3 to 41.0 mpg in model year 2021. The second phase of the CAFE program, for model years 2022 to 2025, are projected to require, on an average industry fleet-wide basis, a range from 48.7 to 49.7 mpg in model year 2025. The second phase of standards have not been finalized due to the statutory requirement that NHTSA set average fuel economy standards not more than five model years at a time. The regulations also include targeted incentives to encourage early adoption and introduction into the marketplace of advanced technologies to dramatically improve vehicle performance, including:

- Incentives for electric vehicles, plug-in hybrid electric vehicles, and fuel cells vehicles.

Air Quality and Greenhouse Gas Technical Report for the Carlsbad Desalination Plant Intake Modifications Project

- Incentives for hybrid technologies for large pickups and for other technologies that achieve high fuel economy levels on large pickups.
- Incentives for natural gas vehicles.
- Credits for technologies with potential to achieve real-world greenhouse gas reductions and fuel economy improvements that are not captured by the standards test procedures.

10.2 State of California

Title 24

Title 24 of the California Code of Regulations was established in 1978, and serves to enhance and regulate California's building standards. While not initially promulgated to reduce GHG emissions, Part 6 of Title 24 specifically establishes energy efficiency standards for residential and non-residential buildings constructed in the State of California in order to reduce energy demand and consumption. Part 6 is updated periodically to incorporate and consider new energy efficiency technologies and methodologies. The most recent amendments, referred to as the 2013 standards, become effective on July 1, 2014. Buildings constructed in accordance with the 2013 standards will use 25% less energy for lighting, heating, cooling, ventilation, and water heating than the 2008 standards. Additionally, the standards will save 200 million gallons of water per year and avoid 170,500 tons of GHG emissions per year (CEC 2012b).

Title 24 also includes Part 11, known as California's Green Building Standards (CALGreen). The CALGreen standards took effect in January 2011, and instituted mandatory minimum environmental performance standards for all ground-up, new construction of commercial, low-rise residential and state-owned buildings, as well as schools and hospitals. The mandatory standards require:

- 20% mandatory reduction in indoor water use.
- 50% of construction and demolition waste must be diverted from landfills.
- Mandatory inspections of energy systems to ensure optimal working efficiency.
- Low-pollutant emitting exterior and interior finish materials, such as paints, carpets, vinyl flooring and particle boards.

The CALGreen standards also include voluntary efficiency measures that are provided at two separate tiers and implemented per the discretion of local agencies and applicants. CALGreen's Tier 1 standards call for a 15% improvement in energy requirements; more strict water conservation; 65% diversion of construction and demolition waste; 10% recycled content in building materials; 20% permeable paving; 20% cement reduction; and, cool/solar reflective roofs. CALGreen's more rigorous Tier 2 standards call for a 30% improvement in energy

Air Quality and Greenhouse Gas Technical Report for the Carlsbad Desalination Plant Intake Modifications Project

requirements; more strict water conservation; 75% diversion of construction and demolition waste; 15% recycled content in building materials; 30% permeable paving; 30% cement reduction; and, cool/solar reflective roofs.

Assembly Bill (AB) 1493. In a response to the transportation sector accounting for more than half of California's CO₂ emissions, AB 1493 (Pavley) was enacted on July 22, 2002. AB 1493 required CARB to set GHG emission standards for passenger vehicles, light-duty trucks, and other vehicles determined by the state board to be vehicles whose primary use is noncommercial personal transportation in the state. The bill required that CARB set GHG emission standards for motor vehicles manufactured in 2009 and all subsequent model years. CARB adopted the standards in September 2004. When fully phased in, the near-term (2009–2012) standards will result in a reduction of about 22% in GHG emissions compared to the emissions from the 2002 fleet, while the mid-term (2013–2016) standards will result in a reduction of about 30%.

Before these regulations could go into effect, the EPA had to grant California a waiver under the federal CAA, which ordinarily preempts state regulation of motor vehicle emission standards. The waiver was granted by Lisa Jackson, the EPA Administrator, on June 30, 2009. On March 29, 2010, the CARB Executive Officer approved revisions to the motor vehicle GHG standards to harmonize the state program with the national program for 2012–2016 model years (see “EPA and NHTSA Joint Final Rule for Vehicle Standards” above). The revised regulations became effective on April 1, 2010.

Executive Order S-3-05. In June 2005, Governor Schwarzenegger established California's GHG emissions reduction targets in Executive Order S-3-05. The Executive Order established the following goals: GHG emissions should be reduced to 2000 levels by 2010; GHG emissions should be reduced to 1990 levels by 2020; and GHG emissions should be reduced to 80% below 1990 levels by 2050. The California EPA secretary is required to coordinate efforts of various agencies to collectively and efficiently reduce GHGs. The Climate Action Team is responsible for implementing global warming emissions reduction programs. Representatives from several state agencies comprise the Climate Action Team. The Climate Action Team fulfilled its report requirements through the March 2006 Climate Action Team Report to the governor and the legislature (CAT 2006).

The 2009 *Climate Action Team Biennial Report* (CAT 2010b), published in April 2010, expands on the policy outlined in the 2006 assessment. The 2009 report provides new information and scientific findings regarding the development of new climate and sea level projections using new information and tools that have recently become available and evaluates climate change within the context of broader social changes, such as land use changes and demographics. The 2009 report also identifies the need for additional research in several different aspects that affect climate change in order to

Air Quality and Greenhouse Gas Technical Report for the Carlsbad Desalination Plant Intake Modifications Project

support effective climate change strategies. The aspects of climate change determined to require future research include vehicle and fuel technologies, land use and smart growth, electricity and natural gas, energy efficiency, renewable energy and reduced carbon energy sources, low GHG technologies for other sectors, carbon sequestration, terrestrial sequestration, geologic sequestration, economic impacts and considerations, social science, and environmental justice.

Subsequently, the 2010 *Climate Action Team Report to Governor Schwarzenegger and the California Legislature* (CAT 2010a) reviews past climate action milestones including voluntary reporting programs, GHG standards for passenger vehicles, the Low Carbon Fuel Standard, a statewide renewable energy standard, and the cap-and-trade program. Additionally, the 2010 report includes a cataloging of recent research and ongoing projects; mitigation and adaptation strategies identified by sector (e.g., agriculture, biodiversity, electricity, and natural gas); actions that can be taken at the regional, national, and international levels to mitigate the adverse effects of climate change; and today's outlook on future conditions.

AB 32. In furtherance of the goals established in Executive Order S-3-05, the legislature enacted AB 32 (Núñez and Pavley), the California Global Warming Solutions Act of 2006, which Governor Schwarzenegger signed on September 27, 2006. The GHG emissions limit is equivalent to the 1990 levels, which are to be achieved by 2020.

CARB has been assigned to carry out and develop the programs and requirements necessary to achieve the goals of AB 32. Under AB 32, CARB must adopt regulations requiring the reporting and verification of statewide GHG emissions. This program will be used to monitor and enforce compliance with the established standards. CARB is also required to adopt rules and regulations to achieve the maximum technologically feasible and cost-effective GHG emission reductions. AB 32 allows CARB to adopt market-based compliance mechanisms to meet the specified requirements. Finally, CARB is ultimately responsible for monitoring compliance and enforcing any rule, regulation, order, emission limitation, emission reduction measure, or market-based compliance mechanism adopted.

The first action under AB 32 resulted in the adoption of a report listing early action GHG emission reduction measures on June 21, 2007. The early actions include three specific GHG control rules. On October 25, 2007, CARB approved an additional six early action GHG reduction measures under AB 32. The three original early action regulations meeting the narrow legal definition of “discrete early action GHG reduction measures” include:

1. A low-carbon fuel standard to reduce the “carbon intensity” of California fuels.
2. Reduction of refrigerant losses from motor vehicle air conditioning system maintenance to restrict the sale of “do-it-yourself” automotive refrigerants.

Air Quality and Greenhouse Gas Technical Report for the Carlsbad Desalination Plant Intake Modifications Project

3. Increased methane capture from landfills to require broader use of state-of-the-art methane capture technologies.

The additional six early action regulations, which were also considered “discrete early action GHG reduction measures,” consist of:

1. Reduction of aerodynamic drag, and thereby fuel consumption, from existing trucks and trailers through retrofit technology
2. Reduction of auxiliary engine emissions of docked ships by requiring port electrification
3. Reduction of PFCs from the semiconductor industry
4. Reduction of propellants in consumer products (e.g., aerosols, tire inflators, and dust removal products)
5. Requirements that all tune-up, smog check, and oil change mechanics ensure proper tire inflation as part of overall service in order to maintain fuel efficiency
6. Restriction on the use of SF₆ from non-electricity sectors if viable alternatives are available.

As required under AB 32, on December 6, 2007, CARB approved the 1990 GHG emissions inventory, thereby establishing the emissions limit for 2020. The 2020 emissions limit was set at 427 MMT CO₂E. In addition to the 1990 emissions inventory, CARB also adopted regulations requiring mandatory reporting of GHGs for large facilities that account for 94% of GHG emissions from industrial and commercial stationary sources in California. About 800 separate sources fall under the new reporting rules and include electricity generating facilities, electricity retail providers and power marketers, oil refineries, hydrogen plants, cement plants, cogeneration facilities, and other industrial sources that emit CO₂ in excess of specified thresholds.

On December 11, 2008, CARB approved the *Climate Change Proposed Scoping Plan: A Framework for Change* (Scoping Plan; CARB 2008) to achieve the goals of AB 32. The Scoping Plan establishes an overall framework for the measures that will be adopted to reduce California’s GHG emissions. The Scoping Plan evaluates opportunities for sector-specific reductions, integrates all CARB and Climate Action Team early actions and additional GHG reduction measures by both entities, identifies additional measures to be pursued as regulations, and outlines the role of a cap-and-trade program.

The key elements of the Scoping Plan include:

- Expanding and strengthening existing energy efficiency programs as well as building and appliance standards.

Air Quality and Greenhouse Gas Technical Report for the Carlsbad Desalination Plant Intake Modifications Project

- Achieving a statewide renewables energy mix of 33%.
- Developing a California cap-and-trade program that links with other Western Climate Initiative partner programs to create a regional market system and caps sources contributing 85% of California's GHG emissions.
- Establishing targets for transportation-related GHG emissions for regions throughout California, and pursuing policies and incentives to achieve those targets.
- Adopting and implementing measures pursuant to existing state laws and policies, including California's clean car standards, goods movement measures, and the Low Carbon Fuel Standard.
- Creating targeted fees, including a public goods charge on water use, fees on high global warming potential gases, and a fee to fund the administrative costs of the State of California's long-term commitment to AB 32 implementation.

CARB is required to update its Scoping Plan at least once every 5 years (Health and Safety Code, Section 38561(h)). The First Update to the Climate Change Scoping Plan (Scoping Plan Update; CARB 2014e) was approved by the CARB Board on May 22, 2014. The Scoping Plan Update builds upon the initial Scoping Plan with new strategies and recommendations. The update identifies opportunities to leverage existing and new funds to further drive GHG emission reductions through strategic planning and targeted low carbon investments. The update adjusts California's target GHG emissions for 2020 at 431 MMT CO₂E based on use of GWP factors in the IPCC's Fourth Assessment Report, which was published in 2007. The update defines CARB's climate change priorities for the next 5 years and sets the groundwork to reach California's long-term climate goals set forth in Executive Orders S-3-05 and B-16-2012. The update highlights California's progress toward meeting the near-term 2020 GHG emission reduction goals defined in the initial Scoping Plan and finds that California is on track to meet the near-term 2020.

These efforts were pursued to achieve the near-term 2020 goal and have created a framework for ongoing climate action that can be built upon to maintain and continue economic sector-specific reductions beyond 2020, as required by AB 32. The document recommends efforts to reduce so-called short-lived climate pollutants (black carbon, methane, and hydrofluorocarbons). These pollutants remain in the atmosphere for shorter periods of time and have much larger GWPs compared to CO₂. The Scoping Plan Update identifies a number of key focus areas or sectors (energy, transportation, agriculture, water, waste management, and natural and working lands), along with short-lived climate pollutants, green buildings, and the cap-and-trade program. The update also recommends that a statewide mid-term target and mid-term and long-term sector targets be established toward meeting the 2050 goal established by Executive Order S-3-05 to

Air Quality and Greenhouse Gas Technical Report for the Carlsbad Desalination Plant Intake Modifications Project

reduce California's GHG emissions to 80% below 1990 levels, although no specific recommendations are made.

Executive Order B-30-15. On April 29, 2015, Governor Jerry Brown issued an executive order which identified an interim GHG reduction target in support of targets previously identified under S-3-05 and AB 32. Executive Order B-30-15 set an interim target goal of reducing GHG emissions to 40% below 1990 levels by 2030 to keep California on its trajectory toward meeting or exceeding the long-term goal of reducing GHG emissions to 80% below 1990 levels by 2050 as set forth in S-3-05. To facilitate achievement of this goal, B-30-15 calls for an update to CARB's Scoping Plan to express the 2030 target in terms of million metric tons of carbon dioxide equivalent. The Executive Order also calls for state agencies to continue to develop and implement GHG emission reduction programs in support of the reduction targets. Sector-specific agencies in transportation, energy, water, and forestry will be required to prepare GHG reduction plans by September 2015, followed by a report on actions taken in relation to these plans in June 2016. The Executive Order does not require local agencies to take any action to meet the new interim GHG reduction threshold. It is important to note that Executive Order B-30-15 was not adopted by a public agency through a public review process that requires analysis pursuant to CEQA Guidelines Section 15064.4 and that it has not been subsequently validated by a statute as an official GHG reduction target of the State of California. The Executive Order itself states it is "not intended to create, and does not, create any rights of benefits, whether substantive or procedural, enforceable at law or in equity, against the State of California, its agencies, departments, entities, officers employees, or any other person."

Senate Bill (SB) 1368. In September 2006, Governor Schwarzenegger signed SB 1368, which requires the California Energy Commission (CEC) to develop and adopt regulations for GHG emissions performance standards for the long-term procurement of electricity by local publicly owned utilities. These standards must be consistent with the standards adopted by the California Public Utilities Commission (CPUC). This effort will help protect energy customers from financial risks associated with investments in carbon-intensive generation by allowing new capital investments in power plants whose GHG emissions are as low or lower than new combined-cycle natural gas plants, by requiring imported electricity to meet GHG performance standards in California, and by requiring that the standards be developed and adopted in a public process.

SB 97. In August 2007, the legislature enacted SB 97 (Dutton), which directs the Governor's Office of Planning and Research (OPR) to develop guidelines under the California Environmental Quality Act (CEQA) for the mitigation of GHG emissions. OPR was to develop proposed guidelines by July 1, 2009, and the Natural Resources Agency was directed to adopt the guidelines by January 1, 2010. On April 13, 2009, OPR submitted to the Secretary for Natural Resources its proposed amendments to the State CEQA Guidelines.

Air Quality and Greenhouse Gas Technical Report for the Carlsbad Desalination Plant Intake Modifications Project

On June 19, 2008, OPR issued a technical advisory as interim guidance regarding the analysis of GHG emissions in CEQA documents (OPR 2008). The advisory indicated that a project's GHG emissions, including those associated with vehicular traffic, energy consumption, water usage, and construction activities, should be identified and estimated. The advisory further recommended that the lead agency determine significance of the impacts and impose all mitigation measures that are necessary to reduce GHG emissions to a level that is less than significant.

On April 13, 2009, OPR submitted to the Natural Resources Agency its proposed amendments to the state CEQA Guidelines relating to GHG emissions. On July 3, 2009, the Natural Resources Agency commenced the Administrative Procedure Act rulemaking process for certifying and adopting the proposed amendments, starting the public comment period.

The Natural Resources Agency adopted the CEQA Guidelines Amendments on December 30, 2009, and transmitted them to the Office of Administrative Law on December 31, 2009. On February 16, 2010, the Office of Administrative law completed its review and filed the amendments with the secretary of state. The amendments became effective on March 18, 2010. The amended guidelines establish several new CEQA requirements concerning the analysis of GHGs, including the following:

- Requiring a lead agency to “make a good faith effort, based to the extent possible on scientific and factual data, to describe, calculate or estimate the amount of GHG emissions resulting from a project” (Section 15064(a))
- Providing a lead agency with the discretion to determine whether to use quantitative or qualitative analysis or performance standards to determine the significance of GHG emissions resulting from a particular project (Section 15064.4(a))
- Requiring a lead agency to consider the following factors when assessing the significant impacts from greenhouse gas emissions on the environment:
 - The extent to which the project may increase or reduce greenhouse gas emissions as compared to the existing environmental setting.
 - Whether the project emissions exceed a threshold of significance that the lead agency determines applies to the project.
 - The extent to which the project complies with regulations or requirements adopted to implement a statewide, regional, or local plan for the reduction or mitigation of GHG emissions. (Section 15064.4(b))
- Allowing lead agencies to consider feasible means of mitigating the significant effects of GHG emissions, including reductions in emissions through the implementation of project features or off-site measures, including offsets that are not otherwise required (Section 15126.4(c)).

Air Quality and Greenhouse Gas Technical Report for the Carlsbad Desalination Plant Intake Modifications Project

The amended guidelines also establish two new guidance questions regarding GHG emissions in the Environmental Checklist set forth in CEQA Guidelines Appendix G:

- Would the project generate greenhouse gas emissions, either directly or indirectly, that may have a significant impact on the environment?
- Would the project conflict with an applicable plan, policy, or regulation adopted for the purpose of reducing the emissions of greenhouse gases?

The adopted amendments do not establish a GHG emission threshold, and instead allow a lead agency to develop, adopt, and apply its own thresholds of significance or those developed by other agencies or experts.⁵ The Natural Resources Agency also acknowledges that a lead agency may consider compliance with regulations or requirements implementing AB 32 in determining the significance of a project's GHG emissions.⁶

SB 375. In August 2008, the legislature passed and on September 30, 2008, Governor Schwarzenegger signed SB 375 (Steinberg), which addresses GHG emissions associated with the transportation sector through regional transportation and sustainability plans. Regional GHG reduction targets for the automobile and light-truck sector for 2020 and 2035, as determined by CARB, are required to consider the emission reductions associated with vehicle emission standards (see SB 1493), the composition of fuels (see Executive Order S-1-07), and other CARB-approved measures to reduce GHG emissions.

Regional metropolitan planning organizations (MPOs) will be responsible for preparing a Sustainable Communities Strategy within their Regional Transportation Plan. The goal of the Sustainable Communities Strategy is to establish a development plan for the region, which, after considering transportation measures and policies, will achieve, if feasible, the GHG reduction targets. If a Sustainable Communities Strategy is unable to achieve the GHG reduction target, an MPO must prepare an Alternative Planning Strategy demonstrating how the GHG reduction target would be achieved through alternative development patterns, infrastructure, or additional transportation measures or policies.

⁵ “The CEQA Guidelines do not establish thresholds of significance for other potential environmental impacts, and SB 97 did not authorize the development of a statement threshold as part of this CEQA Guidelines update. Rather, the proposed amendments recognize a lead agency's existing authority to develop, adopt and apply their own thresholds of significance or those developed by other agencies or experts” (California Natural Resources Agency 2009, p. 84).

⁶ “A project's compliance with regulations or requirements implementing AB 32 or other laws and policies is not irrelevant. Section 15064.4(b)(3) would allow a lead agency to consider compliance with requirements and regulations in the determination of significance of a project's greenhouse gas emissions” (California Natural Resources Agency 2009, p. 100).

Air Quality and Greenhouse Gas Technical Report for the Carlsbad Desalination Plant Intake Modifications Project

SB 375 provides incentives for streamlining California Environmental Quality Act (CEQA) requirements by substantially reducing the requirements for “transit priority projects,” as specified in SB 375, and eliminating the analysis of the impacts of certain residential projects on global warming and the growth-inducing impacts of those projects when the projects are consistent with the Sustainable Communities Strategy or Alternative Planning Strategy. On September 23, 2010, CARB adopted the SB 375 targets for the regional MPOs. The targets for the San Diego Association of Governments (SANDAG) are a 7% reduction in emissions per capita by 2020 and a 13% reduction by 2035. Achieving these goals through adoption of a Sustainable Communities Strategy will be the responsibility of the MPOs.

SB XI 2. On April 12, 2011, Governor Jerry Brown signed SB XI 2 in the First Extraordinary Session, which would expand the Renewable Portfolio Standard (RPS) by establishing a goal of 20% of the total electricity sold to retail customers in California per year, by December 31, 2013, and 33% by December 31, 2020, and in subsequent years. Under the bill, a renewable electrical generation facility is one that uses biomass, solar thermal, photovoltaic, wind, geothermal, fuel cells using renewable fuels, small hydroelectric generation of 30 megawatts or less, digester gas, municipal solid waste conversion, landfill gas, ocean wave, ocean thermal, or tidal current and that meets other specified requirements with respect to its location.

In addition to the retail sellers covered by SB 107, SB XI 2 adds local publicly owned electric utilities to the RPS. By January 1, 2012, the CPUC is required to establish the quantity of electricity products from eligible renewable energy resources to be procured by retail sellers in order to achieve targets of 20% by December 31, 2013; 25% by December 31, 2016; and 33% by December 31, 2020. The statute also requires that the governing boards for local publicly owned electric utilities establish the same targets, and the governing boards would be responsible for ensuring compliance with these targets. The CPUC will be responsible for enforcement of the RPS for retail sellers, while the CEC and CARB will enforce the requirements for local publicly owned electric utilities.

California Air Pollution Control Officers Association. The California Air Pollution Control Officers Association (CAPCOA) is the association of Air Pollution Control Officers representing all 35 air quality agencies throughout California. CAPCOA is not a regulatory body, but has been an active organization in providing guidance in addressing the CEQA significance of GHG emissions and climate change as well as other air quality issues.

10.3 City of Carlsbad

City of Carlsbad Climate Action Plan. The City of Carlsbad developed a Climate Action Plan (CAP) in September 2015 which serves as a comprehensive, long-term strategy guide to reduce

Air Quality and Greenhouse Gas Technical Report for the Carlsbad Desalination Plant Intake Modifications Project

GHG emissions in the City. The CAP outlines specific reduction methods to reduce GHG emissions city-wide, and provide the City with a strategic plan for meeting State mandated GHG reduction targets. The CAP strategies extend through 2035. CARB first approved the Scoping Plan in 2008, which provides guidance for local communities to meet AB 32 and EO S-3-05 targets. The Scoping Plan recommends that local governments target 2020 emissions at 15% below 2005 levels to account for emissions growth since 1990, as proxy for 1990 emissions, since few localities know those levels. Total Carlsbad GHG emissions from the 2005 inventory were 630,310 metric tons carbon dioxide equivalents (MTCO_{2e}) per year. Therefore, the 2020 target under State guidance is a 15% reduction from 2005 emissions, which corresponds to a target of 535,763 MTCO_{2e} (City of Carlsbad 2015).

City of Carlsbad General Plan. The City of Carlsbad General Plan was updated and approved by City Council on September 22, 2015, and was updated in conjunction with the development of the City's CAP. The General Plan includes strategies such as mixed-use development, higher density infill development, integrated transportation and land use planning, promotion of bicycle and pedestrian movements, and transportation demand management. It also includes goals and policies to promote energy efficiency, waste reduction, and resource conservation and recycling. These strategies, goals, and policies would result in GHG reduction compared to baseline trends (City of Carlsbad 2015).

Air Quality and Greenhouse Gas Technical Report for the Carlsbad Desalination Plant Intake Modifications Project

11 SIGNIFICANCE CRITERIA AND ANALYSIS METHODOLOGIES

11.1 Methodology and Assumptions

GHG impacts associated with the proposed project are related to emissions from short-term construction activities and long-term operations. Construction-related GHG emissions are a result of construction equipment and vehicles driven to/from the proposed project site by construction workers and material and water delivery trucks. Construction emissions may be amortized over the expected (long-term) operational life of a project, which were conservatively estimated at 20 years per County of San Diego guidance (County of San Diego 2015).

Operational emissions would result primarily from both direct and indirect sources. Direct sources produce emissions from the on-site combustion of energy, such as natural gas used in furnaces and boilers, industrial processes, and fuel combustion from mobile sources. Indirect sources produce emissions from off-site energy production and water conveyance activities. Generally speaking, operational GHG emissions result from energy use (including electricity, natural gas and water and wastewater), transportation/VMT, area sources (e.g., landscaping equipment), and solid waste.

Emissions from the construction phase of the proposed project were estimated using CalEEMod Version 2013.2.2, available online (<http://www.caleemod.com/>). The equipment mix anticipated for construction activity was based on the CalEEMod default equipment list for the proposed project's land uses. The CalEEMod equipment mix is meant to represent a reasonably conservative estimate of construction activity.

11.2 Appendix G of the CEQA Guidelines

Appendix G of the CEQA Guidelines provides guidance that a project would have a significant environmental impact if it would:

1. Generate greenhouse gas emissions, either directly or indirectly, that may have a significant impact on the environment.
2. Conflict with an applicable plan, policy, or regulation adopted for the purpose of reducing the emissions of greenhouse gases.

However, neither the State of California (including ARB) nor the San Diego Air Pollution Control District (SDAPCD) has adopted quantitative, emission-based thresholds for GHG emissions under CEQA.

Air Quality and Greenhouse Gas Technical Report for the Carlsbad Desalination Plant Intake Modifications Project

OPR's Technical Advisory, titled *CEQA and Climate Change: Addressing Climate Change through California Environmental Quality Act (CEQA) Review*, states that "public agencies are encouraged but not required to adopt thresholds of significance for environmental impacts. Even in the absence of clearly defined thresholds for GHG emissions, the law requires that such emissions from CEQA projects must be disclosed and mitigated to the extent feasible whenever the lead agency determines that the project contributes to a significant, cumulative climate change impact" (OPR 2008). Furthermore, the advisory document indicates that "in the absence of regulatory standards for GHG emissions or other scientific data to clearly define what constitutes a 'significant impact,' individual lead agencies may undertake a project-by-project analysis, consistent with available guidance and current CEQA practice."

11.3 County Climate Change Analysis Criteria

The proposed project was analyzed using the *2015 GHG Guidance: Recommended Approach to Addressing Global Climate Change in CEQA Documents*, which uses a screening threshold of 900 MT CO₂e per year (San Diego County 2015). A project that exceeds the 900 MT CO₂e per year screening threshold is required to conduct a more detailed GHG analysis.

In the event that a project exceeds the screening threshold, the County's 2015 GHG Guidance requires an evaluation of whether the project would conform with the GHG reduction targets set forth in the *Scoping Plan's* 2011 Final Supplement. Based on the 2015 GHG Guidance and the 2011 Final Supplement, a 16% reduction in GHG emissions from a project's "unmitigated" emissions is required to meet AB 32's mandate of reducing emissions to 1990 levels by 2020.

Air Quality and Greenhouse Gas Technical Report for the Carlsbad Desalination Plant Intake Modifications Project

12 IMPACTS

12.1 Construction

GHG emissions would be associated with the construction phase of the project through use of construction equipment and vehicle trips. Emissions of CO₂ were estimated using the California Emissions Estimator Model (CalEEMod), Version 2013.2.2, available online (www.caleemod.com). Construction is anticipated to begin in July 2016 and would take approximately 18 months to complete. See Section 7.2 for construction schedule, equipment, vehicle trips and other assumptions associated with short-term construction activities.

A detailed depiction of the construction schedule—including information regarding subphases and equipment assumed for each subphase—is included in Attachment A of this report. The information contained in Attachment A was used as CalEEMod model inputs.

Table 10, Estimated Annual Construction GHG Emissions, shows the estimated annual GHG construction emissions associated with the proposed project, as well as the annualized construction emissions over a 20-year period per County guidance.

Table 10
Estimated Construction GHG Emissions (total metric tons)

Construction Year	CO ₂	CH ₄	N ₂ O	CO ₂ e Emissions
Construction in 2016	183	0.03	0.00	183
Construction in 2017	1,335	0.32	0.00	1,342
Construction in 2018	220	0.06	0.00	222
Total Construction	1,738	0.41	0.00	1,747
Amortized Construction Emissions	87	0.02	0.00	87

Source: See Attachment A for complete results.

12.2 Operation

Under the proposed modifications the CDP could produce an additional 10 million gallons per day (MGD) of product water. The added 10 MGD of product water would require additional electricity during operation of the CDP that would result in the production of indirect GHG emissions from electrical generation. The generation of electricity through combustion of fossil fuels typically results in emissions of CO₂ and, to a smaller extent, CH₄ and N₂O.

The proposed modifications would include three new dilution pumps with an estimated total power rating of approximately 300 kilowatts (kW) each, motors for the traveling screens with an estimated total power rating of approximately 40 kW, and traveling screen spray wash pumps that would have

Air Quality and Greenhouse Gas Technical Report for the Carlsbad Desalination Plant Intake Modifications Project

an estimated total power rating of approximately 40 kW. As such, the total new power rating for the proposed modifications was conservatively estimated to be 400 kW.

The CDP and proposed modifications would be provided electricity from the electrical grid, within the San Diego Gas & Electric (SDG&E) service area. The proposed modifications are anticipated to begin operation in 2018, when the SDG&E carbon intensity factor for electrical generation is expected to be 544.67 MT CO₂E per megawatt of electricity generated, conservatively accounting for SDG&E's renewable energy portfolio as of 2014 (SDG&E 2014). As such, the potential operation of the CDP to produce the additional 10 MGD of product water would result in approximately 865.69 MT CO₂E per year.

As previously stated, the Special Conditions of the Coastal Development Permit by the CCC require implementation of GHG Plan, which would assessment, reduction, and mitigation of GHG emissions, and establishes a protocol for identifying, securing, monitoring, and updating measures to eliminate the CDP's net carbon footprint. As a result, the GHG emissions for the CDP and the proposed modifications would be reduce to "net zero" through implementation of the GHG Plan. The combination of proposed modifications amortized CO₂E, at well below the screening levels, with the operational emissions commitment to be 'net zero' means that the construction and operation of the proposed modifications would not exceed the County's 900 MT CO₂E screening threshold and would have a less than significant impact from GHG emissions.

12.3 Consistency with GHG Plans

The proposed project would be subject to the City of Carlsbad's adopted Climate Action Plan (CAP). The proposed project has been accounted for the in the CAP as stated in Section 2.1 of the CAP: "The Carlsbad Desalination Plant, which will begin operations in 2016, would therefore not contribute emissions to the 2011 GHG inventory. The emissions forecast (Chapter 3) uses a regional average for water consumption emissions, which accounts for the effect of the desalination plant" (City of Carlsbad 2015). As a result, the proposed project modifications have been anticipated in the local climate planning efforts in the City and project components would not conflict with the City's CAP.

In addition to the City's CAP, the Scoping Plan, approved by CARB on December 12, 2008, provides a framework for actions to reduce California's GHG emissions and requires CARB and other state agencies to adopt regulations and other initiatives to reduce GHGs. As such, the Scoping Plan is not directly applicable to specific projects. Relatedly, in the Final Statement of Reasons for the amendments to the CEQA Guidelines, the California Natural Resources Agency observed that "[t]he Scoping Plan may not be appropriate for use in determining the

Air Quality and Greenhouse Gas Technical Report for the Carlsbad Desalination Plant Intake Modifications Project

significance of individual projects because it is conceptual at this stage and relies on the future development of regulations to implement the strategies identified in the Scoping Plan” (CNRA 2009). Under the Scoping Plan, however, there are several state regulatory measures aimed at the identification and reduction of GHG emissions. CARB and other state agencies have adopted many of the measures identified in the Scoping Plan. Most of these measures focus on area source emissions (e.g., energy usage, high-GWP GHGs in consumer products) and changes to the vehicle fleet (hybrid, electric, and more fuel-efficient vehicles) and associated fuels (e.g., Low Carbon Fuel Standard), among others. The project will comply with all applicable regulations adopted in furtherance of the Scoping Plan to the extent required by law.

As described in Section 3.2, Executive Order B-30-15 established a statewide emissions reduction target of 40% below 1990 levels by 2030. This interim measure was identified to keep the State on a trajectory needed to meet the 2050 goal of reducing GHG emissions to 80% below 1990 levels by 2050 pursuant to Executive Order S-3-05. CARB has already identified the target 2050 emission levels of 431 MMT CO₂E. Executive Order B-30-15 instructs CARB to similarly express the 2030 target in terms of million metric tons of carbon dioxide equivalent.

CARB has expressed optimism with regard to both the 2030 and 2050 goals. It states in the First Update to the Climate Change Scoping Plan that “California is on track to meet the near-term 2020 greenhouse gas limit and is well positioned to maintain and continue reductions beyond 2020 as required by AB 32” (see First Update to Scoping Plan, p. ES2). With regard to the 2050 target for reducing GHG emissions to 80% below 1990 levels, the First Update to the Climate Change Scoping Plan (CARB 2014e, page 34) states:

This level of reduction is achievable in California. In fact, if California realizes the expected benefits of existing policy goals (such as 12,000 megawatts [MW] of renewable distributed generation by 2020, net zero energy homes after 2020, existing building retrofits under AB 758, and others) it could reduce emissions by 2030 to levels squarely in line with those needed in the developed world and to stay on track to reduce emissions to 80% below 1990 levels by 2050. Additional measures, including locally driven measures and those necessary to meet federal air quality standards in 2032, could lead to even greater emission reductions.

In other words, CARB believes the state is on a trajectory to meet the 2020, 2030 and 2050 GHG reduction targets set forth in AB 32, Executive Order B-30-15 and Executive Order S-3-05.

The proposed project would not interfere with implementation of any of the above-described GHG reduction goals for 2030 or 2050. The project would support achievement of the near-term

Air Quality and Greenhouse Gas Technical Report for the Carlsbad Desalination Plant Intake Modifications Project

2020 goal (as codified in AB 32), the interim 2030 goal, and the long-term 2050 goal through providing a domestic water source for the region.

As discussed above, the project would not exceed the County of San Diego's screening threshold of 900 MT CO₂E per year. Because the project would not exceed the County's screening threshold, the project would not conflict with Executive Order S-3-05's GHG reduction goals for the State of California.

At the regional level, SANDAG's Regional Transportation Plan/Sustainable Communities Strategy (RTP/SCS) has been adopted for the purpose of reducing GHG emissions attributable to passenger vehicles in the San Diego region. While the RTP/SCS does not regulate land use or supersede the exercise of land use authority by SANDAG's member jurisdictions (i.e., the County of San Diego and cities therein), the RTP/SCS is a relevant regional reference document for purposes of evaluating the intersection of land use and transportation patterns, and the corresponding GHG emissions. Here, the RTP/SCS is not directly applicable to the proposed project because the underlying purpose of the RTP/SCS is to provide direction and guidance on future regional growth (i.e., the location of new residential and non-residential land uses) and transportation patterns throughout San Diego County as stipulated under SB 375. The project would be consistent with existing zoning and land use designations through the various jurisdictions in which the project would occur, and would not increase vehicle trips or land use intensities as provided in the RTP/SCS. Therefore, the project would not conflict with the intent of the RTP/SCS.

Lastly, the project would not exceed the County's 900 MT CO₂E screening threshold for the purposes of analyzing the significance of GHG emissions under CEQA. Additionally, the project would not generate GHG emissions in quantities such that its implementation would conflict with the goals of AB-32, the City's Climate Action Plan, or General Plan. Impacts would be **less than significant**.

Air Quality and Greenhouse Gas Technical Report for the Carlsbad Desalination Plant Intake Modifications Project

13 REFERENCES

14 CCR 15000–15387 and Appendices A–L. Guidelines for Implementation of the California Environmental Quality Act, as amended.

California Department of Water Resources. 2015. Drought Information. Water Conditions. Storms, Drought and California’s Water Situation: Key Points. May 4, 2015.

CAPCOA (California Air Pollution Control Officers Association). 2008. *CEQA & Climate Change: Evaluating and Addressing Greenhouse Gas Emissions from Projects Subject to the California Environmental Quality Act*. January 2008.

CARB (California Air Resources Board). 2005. *Air Quality and Land Use Handbook: A Community Health Perspective*. April 2005. <http://www.arb.ca.gov/ch/landuse.htm>.

CARB. 2006. Public Workshop to Discuss Establishing the 1990 Emissions Level and the California 2020 Limit and Developing Regulations to Require Reporting of Greenhouse Gas Emissions. Sacramento, California. December 1, 2006. http://www.arb.ca.gov/cc/inventory/meet/2006_12_01_presentation_intro.pdf.

CARB. 2008. *Climate Change Proposed Scoping Plan: A Framework for Change*. October 2008; approved December 12, 2008. <http://www.arb.ca.gov/cc/scopingplan/document/psp.pdf>.

CARB. 2011. Final Regulation Order – Amendments to the Airborne Toxic Control Measure for Stationary Compression Ignition Engines. <http://www.arb.ca.gov/diesel/documents/FinalReg2011.pdf>.

CARB. 2013. “Ambient Air Quality Standards.” <http://www.arb.ca.gov/research/aaqs/aaqs2.pdf>.

CARB. 2014a. “Glossary of Air Pollutant Terms.” <http://www.arb.ca.gov/html/gloss.htm>.

CARB. 2014b. “Area Designations Maps / State and National.” Updated April 17, 2014. Accessed April 24, 2014. <http://www.arb.ca.gov/desig/adm/adm.htm>.

CARB. 2014c. “iADAM: Air Quality Data Statistics.” <http://arb.ca.gov/adam>.

CARB. 2014d. “California Greenhouse Gas Inventory for 2000–2012 – by Category as Defined in the 2008 Scoping Plan.” March 24, 2014. http://www.arb.ca.gov/cc/inventory/data/tables/ghg_inventory_scopingplan_00-12_2014-03-24.pdf.

Air Quality and Greenhouse Gas Technical Report for the Carlsbad Desalination Plant Intake Modifications Project

- CARB. 2014e. First Update to the Climate Change Scoping Plan: Building on the Framework. May 2014. http://www.arb.ca.gov/cc/scopingplan/2013_update/first_update_climate_change_scoping_plan.pdf.
- CARB, California Climate Action Registry, ICLEI - Local Governments for Sustainability, and The Climate Registry. 2010. Local Government Operations Protocol – For the Quantification and Reporting of Greenhouse Gas Emissions Inventories. Version 1.1. May 2010. http://www.arb.ca.gov/cc/protocols/localgov/pubs/lgo_protocol_v1_1_2010-05-03.pdf.
- CAT (California Climate Action Team). 2006. *Final 2006 Climate Action Team Report to the Governor and Legislature*. Sacramento, California: CAT. March 2006.
- CAT. 2010a. *Climate Action Team Report to Governor Schwarzenegger and the California Legislature*. Sacramento, California: CAT. December 2010. <http://www.energy.ca.gov/2010publications/CAT-1000-2010-005/CAT-1000-2010-005.PDF>.
- CAT. 2010b. *Climate Action Team Biennial Report*. Sacramento, California: CAT. April 2010. <http://www.energy.ca.gov/2010publications/CAT-1000-2010-004/CAT-1000-2010-004.PDF>.
- CAT. 2015. *Climate Change Research Plan for California*. California Environmental Protection Agency, Climate Action Team. February 2015.
- CEC (California Energy Commission). 2012a. Coastal Flooding Potential Projections: 2000 – 2100. A White Paper from the California Energy Commission’s California Climate Change Center. July 2012. <http://www.energy.ca.gov/2012publications/CEC-500-2012-011/CEC-500-2012-011.pdf>
- CEC. 2012b. “New Title 24 Standards Will Cut Residential Energy Use by 25 Percent, Save Water, and Reduce Greenhouse Gas Emissions.” Released July 1, 2014. http://www.energy.ca.gov/releases/2014_releases/2014-07-01_new_title24_standards_nr.html.
- City of Carlsbad. 2015. City of Carlsbad Climate Action Plan. September 2015. <http://www.carlsbadca.gov/civicax/filebank/blobdload.aspx?BlobID=29361>
- CNRA (California Natural Resources Agency). 2009. 2009 California Climate Adaptation Strategy. <http://www.energy.ca.gov/2010publications/CNRA-1000-2010-010/CNRA-1000-2010-010.PDF>.

Air Quality and Greenhouse Gas Technical Report for the Carlsbad Desalination Plant Intake Modifications Project

- CSU (California State University). 2004. *Executive Order No. 917 – Policy Statement on Energy Conservation, Sustainable Building Practices, and Physical Plant Management for the California State University*. September 29, 2004. <http://www.calstate.edu/eo/EO-917.pdf>.
- County of San Diego. 2007. *County of San Diego Guidelines for Determining Significance and Report Format and Content Requirements – Air Quality*. Land Use and Environment Group. Department of Planning and Land Use, Department of Public Works. March 19, 2007. <http://www.sandiegocounty.gov/content/dam/sdc/pds/ProjectPlanning/docs/AQ-Guidelines.pdf>.
- County of San Diego. 2015. *2015 GHG Guidance: Recommended Approach to Addressing Climate Change in CEQA Documents*. Department of Planning and Development Services. January 21, 2015.
- EPA (U.S. Environmental Protection Agency). 2010. *EPA and NHTSA Finalize Historic National Program to Reduce Greenhouse Gases and Improve Fuel Economy for Cars and Trucks*. Regulatory Announcement. Office of Transportation and Air Quality. EPA-420-F-10-014. April. <http://www.epa.gov/oms/climate/regulations/420f10014.pdf>.
- EPA. 2011. *Final Rulemaking: Light-Duty Vehicle Greenhouse Gas Emissions Standards and Corporate Average Fuel Economy Standards*. Regulations and Standards–Vehicles and Engines. Last updated February 2011. <http://www.epa.gov/otaq/climate/regulations.htm>.
- EPA. 2012. “Six Common Air Pollutants.” Last updated April 20, 2012. <http://www.epa.gov/air/urbanair/>.
- EPA. 2014a. “Region 9: Air Programs, Air Quality Maps.” Last updated February 11, 2014. <http://www.epa.gov/region9/air/maps/index.html>.
- EPA. 2014b. “AirData: Access to Air Pollution Data.” <http://www.epa.gov/airdata>.
- EPA. 2014c. “Inventory of U.S. Greenhouse Gas Emissions and Sinks: 1990-2012.” April 15, 2014. <http://www.epa.gov/climatechange/ghgemissions/usinventoryreport.html>.
- IPCC (Intergovernmental Panel on Climate Change). 2014. *Climate Change 2014: Impacts, Adaptation, and Vulnerability – Summary for Policymakers*. http://www.ipcc.ch/pdf/assessment-report/ar5/wg2/ar5_wgII_spm_en.pdf.
- National Climatic Data Center. 2014. *Climate Change Impacts in the United States*. U.S. National Climate Assessment. U.S. Global Change Research Program.

Air Quality and Greenhouse Gas Technical Report for the Carlsbad Desalination Plant Intake Modifications Project

- NWRI (National Water Resource Institute). 2012. *Direct Potable Reuse: Benefits for Public Water Supplies, Agriculture, the Environment, and Energy Conservation*.
- OPR (Office of Planning and Research). 2004. *Guide to the California State Executive Branch*. October 2004. OPR. 2008. *Technical Advisory – CEQA and Climate Change: Addressing Climate Change through California Environmental Quality Act (CEQA) Review*.
- OPR. 2008. *Technical Advisory – CEQA and Climate Change: Addressing Climate Change through California Environmental Quality Act (CEQA) Review*.
- SDAPCD (San Diego Air Pollution Control District). 1969. Rules and Regulations. Regulation IV. Prohibitions. Rule 51. Nuisance. Effective January 1, 1969.
- SDAPCD. 1998. Rule 20.2 – New Source Review Non-Major Stationary Sources. Adopted and effective May 17, 1994; revisions adopted and effective December 17, 1997. Revisions adopted November 4, 1998; effective December 17, 1998.
- SDAPCD. 2001. Rules and Regulations. Regulation IV. Prohibitions. Rule 67.0. Architectural Coatings. Revised December 12, 2001.
- SDAPCD. 2005. *Measures To Reduce Particulate Matter in San Diego County*. December 2005. <http://www.sdapcd.org/planning/PM-Measures.pdf>.
- SDAPCD. 2007. *Eight-Hour Ozone Attainment Plan for San Diego County*. May 2007. <http://www.sdapcd.org/planning/8-Hour-O3-Attain-Plan.pdf>.
- SDAPCD. 2009a. *2009 Regional Air Quality Strategy Revision*. April 2009. <http://www.sdapcd.org/planning/2009-RAQS.pdf>.
- SDAPCD. 2009b. Rules and Regulations. Regulation IV. Prohibitions. Rule 55. Fugitive Dust. Adopted June 24, 2009; effective December 24, 2009.
- SDAPCD. 2012. *Redesignation Request and Maintenance Plan for the 1997 National Ozone Standard for San Diego County*. December 15, 2012. http://www.sdapcd.org/planning/8_Hour_O3_Maint-Plan.pdf.
- SDG&E (San Diego Gas & Electric). 2014. 2014 Annual Power Content Label. Accessed December 4, 2015. [http://www.energy.ca.gov/sb1305/labels/2014_labels/all_labels/San_Diego_Gas_and_Electric_\(SDGandE\).pdf](http://www.energy.ca.gov/sb1305/labels/2014_labels/all_labels/San_Diego_Gas_and_Electric_(SDGandE).pdf).

ATTACHMENT A
*CalEEMod Outputs and
Estimated Construction Emissions*

Carlsbad Desal Plant Intake Modifications San Diego County, Annual

1.0 Project Characteristics

1.1 Land Usage

Land Uses	Size	Metric	Lot Acreage	Floor Surface Area	Population
User Defined Industrial	1.00	User Defined Unit	2.00	300.00	0

1.2 Other Project Characteristics

Urbanization	Urban	Wind Speed (m/s)	2.6	Precipitation Freq (Days)	40
Climate Zone	13			Operational Year	2018
Utility Company	San Diego Gas & Electric				
CO2 Intensity (lb/MW hr)	720.49	CH4 Intensity (lb/MW hr)	0.029	N2O Intensity (lb/MW hr)	0.006

1.3 User Entered Comments & Non-Default Data

Construction Phase - construction schedule per applicant

Off-road Equipment - Off-road Equipment - 9 off HW trucks = concrete and pump trucks

Off-road Equipment - all off-road equipment provided by project applicant

Grading - grading acreages per applicant

Demolition - demolition quantities per applicant

Trips and VMT - trips per applicant

Architectural coatings per SDACPD Rule 67.0.1

Construction Off-road Equipment Mitigation - water 3x per day

Table Name	Column Name	Default Value	New Value
tblArchitecturalCoating	EF_Nonresidential_Exterior	250.00	150.00
tblArchitecturalCoating	EF_Nonresidential_Interior	250.00	150.00

tblArchitecturalCoating	EF_Residential_Exterior	250.00	150.00
tblArchitecturalCoating	EF_Residential_Interior	250.00	150.00
tblConstructionPhase	NumDays	10.00	11.00
tblConstructionPhase	NumDays	200.00	20.00
tblConstructionPhase	NumDays	200.00	108.00
tblConstructionPhase	NumDays	200.00	60.00
tblConstructionPhase	NumDays	200.00	40.00
tblConstructionPhase	NumDays	20.00	6.00
tblConstructionPhase	NumDays	20.00	79.00
tblConstructionPhase	NumDays	4.00	5.00
tblConstructionPhase	NumDays	4.00	71.00
tblConstructionPhase	NumDays	10.00	20.00
tblConstructionPhase	NumDays	10.00	6.00
tblConstructionPhase	NumDays	10.00	11.00
tblConstructionPhase	NumDays	2.00	5.00
tblConstructionPhase	NumDays	2.00	30.00
tblConstructionPhase	PhaseEndDate	2/16/2018	2/9/2018
tblConstructionPhase	PhaseEndDate	2/22/2018	1/25/2018
tblConstructionPhase	PhaseEndDate	2/8/2018	11/2/2017
tblConstructionPhase	PhaseEndDate	12/27/2017	12/14/2017
tblConstructionPhase	PhaseEndDate	6/2/2017	6/3/2017
tblConstructionPhase	PhaseEndDate	2/19/2018	2/9/2018
tblConstructionPhase	PhaseEndDate	9/11/2017	9/7/2017
tblConstructionPhase	PhaseEndDate	9/16/2016	9/18/2016
tblConstructionPhase	PhaseEndDate	2/8/2018	1/25/2018
tblConstructionPhase	PhaseStartDate	2/2/2018	1/26/2018
tblConstructionPhase	PhaseStartDate	1/26/2018	12/29/2017
tblConstructionPhase	PhaseStartDate	12/15/2017	9/8/2017
tblConstructionPhase	PhaseStartDate	9/8/2017	8/26/2017
tblConstructionPhase	PhaseStartDate	2/10/2018	2/2/2018

tblConstructionPhase	PhaseStartDate	8/26/2017	8/24/2017
tblConstructionPhase	PhaseStartDate	12/29/2017	12/15/2017
tblGrading	AcresOfGrading	2.50	0.62
tblGrading	AcresOfGrading	0.00	1.00
tblGrading	AcresOfGrading	0.00	0.16
tblGrading	MaterialExported	0.00	9,700.00
tblGrading	MaterialImported	0.00	27.00
tblLandUse	LandUseSquareFeet	0.00	300.00
tblLandUse	LotAcreage	0.00	2.00
tblOffRoadEquipment	HorsePower	400.00	300.00
tblOffRoadEquipment	HorsePower	400.00	300.00
tblOffRoadEquipment	HorsePower	162.00	300.00
tblOffRoadEquipment	HorsePower	400.00	167.00
tblOffRoadEquipment	HorsePower	400.00	200.00
tblOffRoadEquipment	HorsePower	162.00	300.00
tblOffRoadEquipment	HorsePower	9.00	300.00
tblOffRoadEquipment	LoadFactor	0.36	0.36
tblOffRoadEquipment	LoadFactor	0.40	0.40
tblOffRoadEquipment	LoadFactor	0.38	0.38
tblOffRoadEquipment	LoadFactor	0.38	0.38
tblOffRoadEquipment	LoadFactor	0.50	0.50
tblOffRoadEquipment	LoadFactor	0.29	0.29
tblOffRoadEquipment	LoadFactor	0.36	0.36
tblOffRoadEquipment	LoadFactor	0.38	0.38
tblOffRoadEquipment	LoadFactor	0.38	0.38
tblOffRoadEquipment	LoadFactor	0.38	0.38
tblOffRoadEquipment	LoadFactor	0.31	0.31
tblOffRoadEquipment	LoadFactor	0.38	0.38
tblOffRoadEquipment	LoadFactor	0.38	0.38
tblOffRoadEquipment	LoadFactor	0.38	0.38

tblOffRoadEquipment	LoadFactor	0.29	0.29
tblOffRoadEquipment	LoadFactor	0.31	0.31
tblOffRoadEquipment	LoadFactor	0.38	0.38
tblOffRoadEquipment	LoadFactor	0.38	0.38
tblOffRoadEquipment	LoadFactor	0.38	0.38
tblOffRoadEquipment	LoadFactor	0.50	0.50
tblOffRoadEquipment	LoadFactor	0.36	0.36
tblOffRoadEquipment	LoadFactor	0.38	0.38
tblOffRoadEquipment	LoadFactor	0.38	0.38
tblOffRoadEquipment	LoadFactor	0.31	0.31
tblOffRoadEquipment	OffRoadEquipmentType		Rubber Tired Loaders
tblOffRoadEquipment	OffRoadEquipmentType		Rubber Tired Dozers
tblOffRoadEquipment	OffRoadEquipmentType		Excavators
tblOffRoadEquipment	OffRoadEquipmentType		Off-Highway Trucks
tblOffRoadEquipment	OffRoadEquipmentType		Bore/Drill Rigs
tblOffRoadEquipment	OffRoadEquipmentType		Pumps
tblOffRoadEquipment	OffRoadEquipmentType		Cranes
tblOffRoadEquipment	OffRoadEquipmentType		Rubber Tired Loaders
tblOffRoadEquipment	OffRoadEquipmentType		Pumps
tblOffRoadEquipment	OffRoadEquipmentType		Off-Highway Trucks
tblOffRoadEquipment	OffRoadEquipmentType		Excavators
tblOffRoadEquipment	OffRoadEquipmentType		Excavators
tblOffRoadEquipment	OffRoadEquipmentType		Aerial Lifts
tblOffRoadEquipment	OffRoadEquipmentType		Off-Highway Trucks
tblOffRoadEquipment	OffRoadEquipmentType		Pumps
tblOffRoadEquipment	OffRoadEquipmentType		Off-Highway Trucks
tblOffRoadEquipment	OffRoadEquipmentType		Off-Highway Trucks
tblOffRoadEquipment	OffRoadEquipmentType		Cranes
tblOffRoadEquipment	OffRoadEquipmentType		Pumps
tblOffRoadEquipment	OffRoadEquipmentType		Aerial Lifts

tblOffRoadEquipment	UsageHours	6.00	8.00
tblOffRoadEquipment	UsageHours	7.00	8.00
tblProjectCharacteristics	OperationalYear	2014	2018
tblTripsAndVMT	HaulingTripNumber	3.00	25.00
tblTripsAndVMT	HaulingTripNumber	9.00	25.00
tblTripsAndVMT	HaulingTripNumber	0.00	606.00
tblTripsAndVMT	HaulingTripNumber	1,213.00	606.00
tblTripsAndVMT	HaulingTripNumber	0.00	114.00
tblTripsAndVMT	HaulingTripNumber	7.00	22.00
tblTripsAndVMT	VendorTripNumber	0.00	4.00
tblTripsAndVMT	VendorTripNumber	0.00	16.00
tblTripsAndVMT	VendorTripNumber	0.00	4.00
tblTripsAndVMT	VendorTripNumber	0.00	20.00
tblTripsAndVMT	VendorTripNumber	0.00	14.00
tblTripsAndVMT	VendorTripNumber	0.00	8.00
tblTripsAndVMT	VendorTripNumber	0.00	14.00
tblTripsAndVMT	VendorTripNumber	0.00	4.00
tblTripsAndVMT	VendorTripNumber	0.00	20.00
tblTripsAndVMT	VendorTripNumber	0.00	20.00
tblTripsAndVMT	VendorTripNumber	0.00	14.00
tblTripsAndVMT	VendorTripNumber	0.00	18.00
tblTripsAndVMT	VendorTripNumber	0.00	4.00
tblTripsAndVMT	VendorTripNumber	0.00	20.00
tblTripsAndVMT	WorkerTripNumber	5.00	14.00
tblTripsAndVMT	WorkerTripNumber	5.00	14.00
tblTripsAndVMT	WorkerTripNumber	30.00	26.00
tblTripsAndVMT	WorkerTripNumber	0.00	26.00
tblTripsAndVMT	WorkerTripNumber	10.00	14.00
tblTripsAndVMT	WorkerTripNumber	0.00	8.00
tblTripsAndVMT	WorkerTripNumber	5.00	14.00

tblTripsAndVMT	WorkerTripNumber	8.00	14.00
tblTripsAndVMT	WorkerTripNumber	0.00	28.00
tblTripsAndVMT	WorkerTripNumber	23.00	28.00
tblTripsAndVMT	WorkerTripNumber	0.00	26.00
tblTripsAndVMT	WorkerTripNumber	5.00	12.00
tblTripsAndVMT	WorkerTripNumber	38.00	22.00
tblTripsAndVMT	WorkerTripNumber	0.00	16.00

2.0 Emissions Summary

2.1 Overall Construction

Unmitigated Construction

	ROG	NOx	CO	SO2	Fugitive PM10	Exhaust PM10	PM10 Total	Fugitive PM2.5	Exhaust PM2.5	PM2.5 Total	Bio- CO2	NBio- CO2	Total CO2	CH4	N2O	CO2e
Year	tons/yr										MT/yr					
2016	0.1442	1.4170	0.9033	2.0300e-003	0.0343	0.0675	0.1018	0.0134	0.0651	0.0784	0.0000	182.6699	182.6699	0.0323	0.0000	183.3475
2017	1.0938	10.9942	6.8260	0.0147	0.0594	0.5126	0.5720	0.0159	0.4840	0.4998	0.0000	1,334.8718	1,334.8718	0.3163	0.0000	1,341.5149
2018	0.1562	1.5500	0.9521	2.4600e-003	7.5300e-003	0.0658	0.0734	2.0000e-003	0.0620	0.0640	0.0000	220.4582	220.4582	0.0568	0.0000	221.6514
Total	1.3941	13.9611	8.6814	0.0192	0.1012	0.6460	0.7471	0.0312	0.6110	0.6422	0.0000	1,737.9998	1,737.9998	0.4054	0.0000	1,746.5138

Mitigated Construction

	ROG	NOx	CO	SO2	Fugitive PM10	Exhaust PM10	PM10 Total	Fugitive PM2.5	Exhaust PM2.5	PM2.5 Total	Bio- CO2	NBio- CO2	Total CO2	CH4	N2O	CO2e
Year	tons/yr										MT/yr					

2016	0.1442	1.4170	0.9033	2.0300e-003	0.0244	0.0675	0.0919	8.2100e-003	0.0651	0.0733	0.0000	182.6697	182.6697	0.0323	0.0000	183.3473
2017	1.0937	10.9941	6.8260	0.0147	0.0582	0.5126	0.5708	0.0157	0.4840	0.4997	0.0000	1,334.8703	1,334.8703	0.3163	0.0000	1,341.5135
2018	0.1562	1.5500	0.9521	2.4600e-003	7.3300e-003	0.0658	0.0732	1.9700e-003	0.0620	0.0640	0.0000	220.4579	220.4579	0.0568	0.0000	221.6511
Total	1.3941	13.9611	8.6813	0.0192	0.0899	0.6460	0.7359	0.0259	0.6110	0.6369	0.0000	1,737.9979	1,737.9979	0.4054	0.0000	1,746.5119

	ROG	NOx	CO	SO2	Fugitive PM10	Exhaust PM10	PM10 Total	Fugitive PM2.5	Exhaust PM2.5	PM2.5 Total	Bio- CO2	NBio-CO2	Total CO2	CH4	N2O	CO2e
Percent Reduction	0.00	0.00	0.00	0.00	11.12	0.00	1.51	17.11	0.00	0.83	0.00	0.00	0.00	0.00	0.00	0.00

3.0 Construction Detail

Construction Phase

Phase Number	Phase Name	Phase Type	Start Date	End Date	Num Days Week	Num Days	Phase Description
1	Intake 1a - Site Prep	Site Preparation	9/12/2016	9/18/2016	5	5	
2	Intake 1b - Asphalt Removal	Demolition	9/19/2016	9/26/2016	5	6	
3	Intake 2a - Sheet Piling	Building Construction	9/27/2016	2/23/2017	5	108	
4	Intake 2b - Excavation	Grading	2/24/2017	6/3/2017	5	71	
5	Intake 3 - Building Construction	Building Construction	6/4/2017	8/25/2017	5	60	
6	Axial 1 - Paving	Paving	8/24/2017	9/7/2017	5	11	
7	Intake 4 - Demolition	Demolition	8/26/2017	12/14/2017	5	79	
8	Axial 2 - Pump Station Install	Building Construction	9/8/2017	11/2/2017	5	40	
9	Axial 3a - Trenching	Trenching	11/3/2017	11/30/2017	5	20	
10	Axial 3b - Paving	Paving	12/1/2017	12/28/2017	5	20	
11	Intake 5 - Backfill	Site Preparation	12/15/2017	1/25/2018	5	30	
12	Axial 4 - Building Construction	Building Construction	12/29/2017	1/25/2018	5	20	
13	Intake 6a - Grading	Grading	1/26/2018	2/1/2018	5	5	
14	Axial 5 - Architectural Coatings	Architectural Coating	1/26/2018	2/9/2018	5	11	
15	Intake 6b - Paving	Paving	2/2/2018	2/9/2018	5	6	

Acres of Grading (Site Preparation Phase): 0

Acres of Grading (Grading Phase): 0

Acres of Paving: 0

Residential Indoor: 0; Residential Outdoor: 0; Non-Residential Indoor: 450; Non-Residential Outdoor: 150 (Architectural Coating – sqft)

OffRoad Equipment

Phase Name	Offroad Equipment Type	Amount	Usage Hours	Horse Power	Load Factor
Intake 1a - Site Prep	Graders	0	8.00	174	0.41
Intake 1a - Site Prep	Scrapers	0	8.00	361	0.48
Intake 1a - Site Prep	Tractors/Loaders/Backhoes	0	7.00	97	0.37
Intake 1b - Asphalt Removal	Concrete/Industrial Saws	0	8.00	81	0.73
Intake 1b - Asphalt Removal	Rubber Tired Dozers	0	8.00	255	0.40
Intake 1b - Asphalt Removal	Tractors/Loaders/Backhoes	0	8.00	97	0.37
Intake 2a - Sheet Piling	Cranes	1	8.00	226	0.29
Intake 2a - Sheet Piling	Forklifts	0	7.00	89	0.20
Intake 2a - Sheet Piling	Generator Sets	0	8.00	84	0.74
Intake 2a - Sheet Piling	Tractors/Loaders/Backhoes	0	6.00	97	0.37
Intake 2a - Sheet Piling	Welders	0	8.00	46	0.45
Intake 2b - Excavation	Graders	0	8.00	174	0.41
Intake 2b - Excavation	Rubber Tired Dozers	0	8.00	255	0.40
Intake 2b - Excavation	Tractors/Loaders/Backhoes	1	8.00	97	0.37
Intake 3 - Building Construction	Cranes	2	8.00	226	0.29
Intake 3 - Building Construction	Forklifts	0	7.00	89	0.20
Intake 3 - Building Construction	Generator Sets	0	8.00	84	0.74
Intake 3 - Building Construction	Tractors/Loaders/Backhoes	0	6.00	97	0.37
Intake 3 - Building Construction	Welders	0	8.00	46	0.45
Axial 1 - Paving	Cement and Mortar Mixers	0	8.00	9	0.56
Axial 1 - Paving	Pavers	1	8.00	125	0.42
Axial 1 - Paving	Paving Equipment	0	8.00	130	0.36
Axial 1 - Paving	Rollers	1	8.00	80	0.38

Axial 1 - Paving	Tractors/Loaders/Backhoes	0	8.00	97	0.37
Intake 4 - Demolition	Concrete/Industrial Saws	1	8.00	81	0.73
Intake 4 - Demolition	Rubber Tired Dozers	0	8.00	255	0.40
Intake 4 - Demolition	Tractors/Loaders/Backhoes	0	8.00	97	0.37
Axial 2 - Pump Station Install	Cranes	2	8.00	226	0.29
Axial 2 - Pump Station Install	Forklifts	0	7.00	89	0.20
Axial 2 - Pump Station Install	Generator Sets	0	8.00	84	0.74
Axial 2 - Pump Station Install	Tractors/Loaders/Backhoes	0	6.00	97	0.37
Axial 2 - Pump Station Install	Welders	0	8.00	46	0.45
Axial 3b - Paving	Cement and Mortar Mixers	0	8.00	9	0.56
Axial 3b - Paving	Pavers	1	8.00	125	0.42
Axial 3b - Paving	Paving Equipment	0	8.00	130	0.36
Axial 3b - Paving	Rollers	1	8.00	80	0.38
Axial 3b - Paving	Tractors/Loaders/Backhoes	0	8.00	97	0.37
Intake 5 - Backfill	Graders	0	8.00	174	0.41
Intake 5 - Backfill	Scrapers	0	8.00	361	0.48
Intake 5 - Backfill	Tractors/Loaders/Backhoes	0	7.00	97	0.37
Axial 4 - Building Construction	Cranes	1	8.00	226	0.29
Axial 4 - Building Construction	Forklifts	0	7.00	89	0.20
Axial 4 - Building Construction	Generator Sets	0	8.00	84	0.74
Axial 4 - Building Construction	Tractors/Loaders/Backhoes	0	6.00	97	0.37
Axial 4 - Building Construction	Welders	0	8.00	46	0.45
Intake 6a - Grading	Graders	1	8.00	174	0.41
Intake 6a - Grading	Rubber Tired Dozers	0	8.00	255	0.40
Intake 6a - Grading	Tractors/Loaders/Backhoes	0	7.00	97	0.37
Axial 5 - Architectural Coatings	Air Compressors	2	8.00	78	0.48
Intake 6b - Paving	Cement and Mortar Mixers	0	8.00	9	0.56
Intake 6b - Paving	Pavers	1	8.00	125	0.42
Intake 6b - Paving	Paving Equipment	0	8.00	130	0.36
Intake 6b - Paving	Rollers	1	8.00	80	0.38

Intake 6b - Paving	Tractors/Loaders/Backhoes	0	8.00	97	0.37
Intake 1a - Site Prep	Rubber Tired Loaders	1	8.00	199	0.36
Intake 1a - Site Prep	Rubber Tired Dozers	1	8.00	255	0.40
Intake 1b - Asphalt Removal	Excavators	1	8.00	162	0.38
Intake 1b - Asphalt Removal	Off-Highway Trucks	2	8.00	300	0.38
Intake 2a - Sheet Piling	Bore/Drill Rigs	2	8.00	205	0.50
Intake 2a - Sheet Piling	Pumps	3	8.00	84	0.74
Intake 2b - Excavation	Cranes	1	8.00	226	0.29
Intake 2b - Excavation	Rubber Tired Loaders	1	8.00	199	0.36
Intake 2b - Excavation	Pumps	3	8.00	84	0.74
Intake 2b - Excavation	Off-Highway Trucks	2	8.00	300	0.38
Intake 2b - Excavation	Excavators	1	8.00	300	0.38
Intake 3 - Building Construction	Excavators	1	8.00	162	0.38
Intake 3 - Building Construction	Aerial Lifts	2	8.00	62	0.31
Intake 3 - Building Construction	Off-Highway Trucks	9	8.00	167	0.38
Intake 3 - Building Construction	Pumps	3	8.00	84	0.74
Intake 4 - Demolition	Off-Highway Trucks	1	8.00	200	0.38
Intake 4 - Demolition	Off-Highway Trucks	9	8.00	400	0.38
Intake 4 - Demolition	Cranes	1	8.00	226	0.29
Intake 4 - Demolition	Pumps	3	8.00	84	0.74
Axial 2 - Pump Station Install	Aerial Lifts	2	8.00	62	0.31
Axial 2 - Pump Station Install	Pumps	3	8.00	84	0.74
Axial 3a - Trenching	Excavators	1	8.00	300	0.38
Intake 5 - Backfill	Off-Highway Trucks	3	8.00	400	0.38
Intake 5 - Backfill	Cement and Mortar Mixers	1	8.00	300	0.56
Intake 5 - Backfill	Excavators	1	8.00	162	0.38
Intake 5 - Backfill	Bore/Drill Rigs	1	8.00	205	0.50
Intake 5 - Backfill	Rubber Tired Loaders	2	8.00	199	0.36
Intake 5 - Backfill	Rollers	1	8.00	80	0.38
Intake 5 - Backfill	Pumps	3	8.00	84	0.74

Axial 4 - Building Construction	Off-Highway Trucks	9	8.00	400	0.38
Axial 4 - Building Construction	Pumps	3	8.00	84	0.74
Intake 6a - Grading	Dumpers/Tenders	3	8.00	16	0.38
Axial 5 - Architectural Coatings	Aerial Lifts	2	8.00	62	0.31

Trips and VMT

Phase Name	Offroad Equipment Count	Worker Trip Number	Vendor Trip Number	Hauling Trip Number	Worker Trip Length	Vendor Trip Length	Hauling Trip Length	Worker Vehicle Class	Vendor Vehicle Class	Hauling Vehicle Class
Intake 1a - Site Prep	2	14.00	4.00	25.00	10.80	7.30	20.00	LD_Mix	HDT_Mix	HHDT
Intake 1b - Asphalt Removal	3	14.00	4.00	25.00	10.80	7.30	20.00	LD_Mix	HDT_Mix	HHDT
Intake 2a - Sheet Piling	6	28.00	20.00	606.00	10.80	7.30	20.00	LD_Mix	HDT_Mix	HHDT
Intake 2b - Excavation	9	28.00	20.00	606.00	10.80	7.30	20.00	LD_Mix	HDT_Mix	HHDT
Intake 3 - Building Construction	17	26.00	14.00	114.00	10.80	7.30	20.00	LD_Mix	HDT_Mix	HHDT
Axial 1 - Paving	2	12.00	18.00	0.00	10.80	7.30	20.00	LD_Mix	HDT_Mix	HHDT
Intake 4 - Demolition	15	22.00	4.00	22.00	10.80	7.30	20.00	LD_Mix	HDT_Mix	HHDT
Axial 2 - Pump Station Install	7	16.00	20.00	0.00	10.80	7.30	20.00	LD_Mix	HDT_Mix	HHDT
Axial 3a - Trenching	1	3.00	0.00	0.00	10.80	7.30	20.00	LD_Mix	HDT_Mix	HHDT
Axial 3b - Paving	2	14.00	16.00	0.00	10.80	7.30	20.00	LD_Mix	HDT_Mix	HHDT
Intake 5 - Backfill	12	26.00	4.00	0.00	10.80	7.30	20.00	LD_Mix	HDT_Mix	HHDT
Axial 4 - Building Construction	13	26.00	20.00	0.00	10.80	7.30	20.00	LD_Mix	HDT_Mix	HHDT
Intake 6a - Grading	4	14.00	14.00	0.00	10.80	7.30	20.00	LD_Mix	HDT_Mix	HHDT
Axial 5 - Architectural Coatings	4	8.00	8.00	0.00	10.80	7.30	20.00	LD_Mix	HDT_Mix	HHDT
Intake 6b - Paving	2	14.00	14.00	0.00	10.80	7.30	20.00	LD_Mix	HDT_Mix	HHDT

3.1 Mitigation Measures Construction

Water Exposed Area

Clean Paved Roads

3.2 Intake 1a - Site Prep - 2016

Unmitigated Construction On-Site

	ROG	NOx	CO	SO2	Fugitive PM10	Exhaust PM10	PM10 Total	Fugitive PM2.5	Exhaust PM2.5	PM2.5 Total	Bio- CO2	NBio- CO2	Total CO2	CH4	N2O	CO2e
Category	tons/yr										MT/yr					
Fugitive Dust					0.0151	0.0000	0.0151	8.2900e-003	0.0000	8.2900e-003	0.0000	0.0000	0.0000	0.0000	0.0000	0.0000
Off-Road	4.3100e-003	0.0505	0.0305	4.0000e-005	2.1500e-003	2.1500e-003		1.9800e-003	1.9800e-003		0.0000	3.5202	3.5202	1.0600e-003	0.0000	3.5425
Total	4.3100e-003	0.0505	0.0305	4.0000e-005	0.0151	2.1500e-003	0.0173	8.2900e-003	1.9800e-003	0.0103	0.0000	3.5202	3.5202	1.0600e-003	0.0000	3.5425

Unmitigated Construction Off-Site

	ROG	NOx	CO	SO2	Fugitive PM10	Exhaust PM10	PM10 Total	Fugitive PM2.5	Exhaust PM2.5	PM2.5 Total	Bio- CO2	NBio- CO2	Total CO2	CH4	N2O	CO2e
Category	tons/yr										MT/yr					
Hauling	2.6000e-004	3.6300e-003	2.9900e-003	1.0000e-005	2.1000e-004	5.0000e-005	2.6000e-004	6.0000e-005	4.0000e-005	1.0000e-004	0.0000	0.8538	0.8538	1.0000e-005	0.0000	0.8539
Vendor	1.1000e-004	9.8000e-004	1.3700e-003	0.0000	7.0000e-005	1.0000e-005	8.0000e-005	2.0000e-005	1.0000e-005	3.0000e-005	0.0000	0.2158	0.2158	0.0000	0.0000	0.2158
Worker	1.2000e-004	1.6000e-004	1.5100e-003	0.0000	2.8000e-004	0.0000	2.8000e-004	7.0000e-005	0.0000	8.0000e-005	0.0000	0.2616	0.2616	1.0000e-005	0.0000	0.2619
Total	4.9000e-004	4.7700e-003	5.8700e-003	1.0000e-005	5.6000e-004	6.0000e-005	6.2000e-004	1.5000e-004	5.0000e-005	2.1000e-004	0.0000	1.3311	1.3311	2.0000e-005	0.0000	1.3316

Mitigated Construction On-Site

	ROG	NOx	CO	SO2	Fugitive PM10	Exhaust PM10	PM10 Total	Fugitive PM2.5	Exhaust PM2.5	PM2.5 Total	Bio- CO2	NBio- CO2	Total CO2	CH4	N2O	CO2e
Category	tons/yr										MT/yr					

Fugitive Dust					5.9100e-003	0.0000	5.9100e-003	3.2300e-003	0.0000	3.2300e-003	0.0000	0.0000	0.0000	0.0000	0.0000	0.0000
Off-Road	4.3100e-003	0.0505	0.0305	4.0000e-005		2.1500e-003	2.1500e-003		1.9800e-003	1.9800e-003	0.0000	3.5202	3.5202	1.0600e-003	0.0000	3.5425
Total	4.3100e-003	0.0505	0.0305	4.0000e-005	5.9100e-003	2.1500e-003	8.0600e-003	3.2300e-003	1.9800e-003	5.2100e-003	0.0000	3.5202	3.5202	1.0600e-003	0.0000	3.5425

Mitigated Construction Off-Site

	ROG	NOx	CO	SO2	Fugitive PM10	Exhaust PM10	PM10 Total	Fugitive PM2.5	Exhaust PM2.5	PM2.5 Total	Bio- CO2	NBio- CO2	Total CO2	CH4	N2O	CO2e
Category	tons/yr										MT/yr					
Hauling	2.6000e-004	3.6300e-003	2.9900e-003	1.0000e-005	2.1000e-004	5.0000e-005	2.6000e-004	6.0000e-005	4.0000e-005	1.0000e-004	0.0000	0.8538	0.8538	1.0000e-005	0.0000	0.8539
Vendor	1.1000e-004	9.8000e-004	1.3700e-003	0.0000	7.0000e-005	1.0000e-005	8.0000e-005	2.0000e-005	1.0000e-005	3.0000e-005	0.0000	0.2158	0.2158	0.0000	0.0000	0.2158
Worker	1.2000e-004	1.6000e-004	1.5100e-003	0.0000	2.8000e-004	0.0000	2.8000e-004	7.0000e-005	0.0000	8.0000e-005	0.0000	0.2616	0.2616	1.0000e-005	0.0000	0.2619
Total	4.9000e-004	4.7700e-003	5.8700e-003	1.0000e-005	5.6000e-004	6.0000e-005	6.2000e-004	1.5000e-004	5.0000e-005	2.1000e-004	0.0000	1.3311	1.3311	2.0000e-005	0.0000	1.3316

3.3 Intake 1b - Asphalt Removal - 2016

Unmitigated Construction On-Site

	ROG	NOx	CO	SO2	Fugitive PM10	Exhaust PM10	PM10 Total	Fugitive PM2.5	Exhaust PM2.5	PM2.5 Total	Bio- CO2	NBio- CO2	Total CO2	CH4	N2O	CO2e
Category	tons/yr										MT/yr					
Fugitive Dust					1.0000e-003	0.0000	1.0000e-003	1.5000e-004	0.0000	1.5000e-004	0.0000	0.0000	0.0000	0.0000	0.0000	0.0000
Off-Road	5.4300e-003	0.0624	0.0332	8.0000e-005		2.5100e-003	2.5100e-003		2.3100e-003	2.3100e-003	0.0000	7.1119	7.1119	2.1500e-003	0.0000	7.1570
Total	5.4300e-003	0.0624	0.0332	8.0000e-005	1.0000e-003	2.5100e-003	3.5100e-003	1.5000e-004	2.3100e-003	2.4600e-003	0.0000	7.1119	7.1119	2.1500e-003	0.0000	7.1570

Unmitigated Construction Off-Site

	ROG	NOx	CO	SO2	Fugitive PM10	Exhaust PM10	PM10 Total	Fugitive PM2.5	Exhaust PM2.5	PM2.5 Total	Bio- CO2	NBio- CO2	Total CO2	CH4	N2O	CO2e
Category	tons/yr										MT/yr					
Hauling	2.6000e-004	3.6300e-003	2.9900e-003	1.0000e-005	2.1000e-004	5.0000e-005	2.6000e-004	6.0000e-005	4.0000e-005	1.0000e-004	0.0000	0.8538	0.8538	1.0000e-005	0.0000	0.8539
Vendor	1.4000e-004	1.1700e-003	1.6400e-003	0.0000	8.0000e-005	2.0000e-005	1.0000e-004	2.0000e-005	2.0000e-005	4.0000e-005	0.0000	0.2589	0.2589	0.0000	0.0000	0.2589
Worker	1.4000e-004	1.9000e-004	1.8100e-003	0.0000	3.4000e-004	0.0000	3.4000e-004	9.0000e-005	0.0000	9.0000e-005	0.0000	0.3139	0.3139	2.0000e-005	0.0000	0.3142
Total	5.4000e-004	4.9900e-003	6.4400e-003	1.0000e-005	6.3000e-004	7.0000e-005	7.0000e-004	1.7000e-004	6.0000e-005	2.3000e-004	0.0000	1.4266	1.4266	3.0000e-005	0.0000	1.4271

Mitigated Construction On-Site

	ROG	NOx	CO	SO2	Fugitive PM10	Exhaust PM10	PM10 Total	Fugitive PM2.5	Exhaust PM2.5	PM2.5 Total	Bio- CO2	NBio- CO2	Total CO2	CH4	N2O	CO2e
Category	tons/yr										MT/yr					
Fugitive Dust					3.9000e-004	0.0000	3.9000e-004	6.0000e-005	0.0000	6.0000e-005	0.0000	0.0000	0.0000	0.0000	0.0000	0.0000
Off-Road	5.4300e-003	0.0624	0.0332	8.0000e-005		2.5100e-003	2.5100e-003		2.3100e-003	2.3100e-003	0.0000	7.1119	7.1119	2.1500e-003	0.0000	7.1570
Total	5.4300e-003	0.0624	0.0332	8.0000e-005	3.9000e-004	2.5100e-003	2.9000e-003	6.0000e-005	2.3100e-003	2.3700e-003	0.0000	7.1119	7.1119	2.1500e-003	0.0000	7.1570

Mitigated Construction Off-Site

	ROG	NOx	CO	SO2	Fugitive PM10	Exhaust PM10	PM10 Total	Fugitive PM2.5	Exhaust PM2.5	PM2.5 Total	Bio- CO2	NBio- CO2	Total CO2	CH4	N2O	CO2e
--	-----	-----	----	-----	---------------	--------------	------------	----------------	---------------	-------------	----------	-----------	-----------	-----	-----	------

Category	tons/yr										MT/yr					
	Hauling	2.6000e-004	3.6300e-003	2.9900e-003	1.0000e-005	2.1000e-004	5.0000e-005	2.6000e-004	6.0000e-005	4.0000e-005	1.0000e-004	0.0000	0.8538	0.8538	1.0000e-005	0.0000
Vendor	1.4000e-004	1.1700e-003	1.6400e-003	0.0000	8.0000e-005	2.0000e-005	1.0000e-004	2.0000e-005	2.0000e-005	4.0000e-005	0.0000	0.2589	0.2589	0.0000	0.0000	0.2589
Worker	1.4000e-004	1.9000e-004	1.8100e-003	0.0000	3.4000e-004	0.0000	3.4000e-004	9.0000e-005	0.0000	9.0000e-005	0.0000	0.3139	0.3139	2.0000e-005	0.0000	0.3142
Total	5.4000e-004	4.9900e-003	6.4400e-003	1.0000e-005	6.3000e-004	7.0000e-005	7.0000e-004	1.7000e-004	6.0000e-005	2.3000e-004	0.0000	1.4266	1.4266	3.0000e-005	0.0000	1.4271

3.4 Intake 2a - Sheet Piling - 2016

Unmitigated Construction On-Site

	ROG	NOx	CO	SO2	Fugitive PM10	Exhaust PM10	PM10 Total	Fugitive PM2.5	Exhaust PM2.5	PM2.5 Total	Bio- CO2	NBio- CO2	Total CO2	CH4	N2O	CO2e
Category	tons/yr										MT/yr					
Off-Road	0.1182	1.1663	0.6448	1.4800e-003		0.0609	0.0609		0.0590	0.0590	0.0000	133.9518	133.9518	0.0284	0.0000	134.5486
Total	0.1182	1.1663	0.6448	1.4800e-003		0.0609	0.0609		0.0590	0.0590	0.0000	133.9518	133.9518	0.0284	0.0000	134.5486

Unmitigated Construction Off-Site

	ROG	NOx	CO	SO2	Fugitive PM10	Exhaust PM10	PM10 Total	Fugitive PM2.5	Exhaust PM2.5	PM2.5 Total	Bio- CO2	NBio- CO2	Total CO2	CH4	N2O	CO2e
Category	tons/yr										MT/yr					
Hauling	4.0500e-003	0.0562	0.0463	1.4000e-004	4.7100e-003	7.4000e-004	5.4500e-003	1.2500e-003	6.8000e-004	1.9300e-003	0.0000	13.2227	13.2227	9.0000e-005	0.0000	13.2247
Vendor	7.8500e-003	0.0674	0.0944	1.6000e-004	4.4900e-003	9.9000e-004	5.4800e-003	1.2800e-003	9.1000e-004	2.2000e-003	0.0000	14.8865	14.8865	1.2000e-004	0.0000	14.8890
Worker	3.3100e-003	4.3800e-003	0.0417	1.0000e-004	7.7500e-003	6.0000e-005	7.8100e-003	2.0600e-003	5.0000e-005	2.1100e-003	0.0000	7.2190	7.2190	3.8000e-004	0.0000	7.2270

Total	0.0152	0.1280	0.1825	4.0000e-004	0.0170	1.7900e-003	0.0187	4.5900e-003	1.6400e-003	6.2400e-003	0.0000	35.3283	35.3283	5.9000e-004	0.0000	35.3407
--------------	---------------	---------------	---------------	--------------------	---------------	--------------------	---------------	--------------------	--------------------	--------------------	---------------	----------------	----------------	--------------------	---------------	----------------

Mitigated Construction On-Site

	ROG	NOx	CO	SO2	Fugitive PM10	Exhaust PM10	PM10 Total	Fugitive PM2.5	Exhaust PM2.5	PM2.5 Total	Bio- CO2	NBio- CO2	Total CO2	CH4	N2O	CO2e
Category	tons/yr										MT/yr					
Off-Road	0.1182	1.1663	0.6448	1.4800e-003		0.0609	0.0609		0.0590	0.0590	0.0000	133.9516	133.9516	0.0284	0.0000	134.5485
Total	0.1182	1.1663	0.6448	1.4800e-003		0.0609	0.0609		0.0590	0.0590	0.0000	133.9516	133.9516	0.0284	0.0000	134.5485

Mitigated Construction Off-Site

	ROG	NOx	CO	SO2	Fugitive PM10	Exhaust PM10	PM10 Total	Fugitive PM2.5	Exhaust PM2.5	PM2.5 Total	Bio- CO2	NBio- CO2	Total CO2	CH4	N2O	CO2e
Category	tons/yr										MT/yr					
Hauling	4.0500e-003	0.0562	0.0463	1.4000e-004	4.7100e-003	7.4000e-004	5.4500e-003	1.2500e-003	6.8000e-004	1.9300e-003	0.0000	13.2227	13.2227	9.0000e-005	0.0000	13.2247
Vendor	7.8500e-003	0.0674	0.0944	1.6000e-004	4.4900e-003	9.9000e-004	5.4800e-003	1.2800e-003	9.1000e-004	2.2000e-003	0.0000	14.8865	14.8865	1.2000e-004	0.0000	14.8890
Worker	3.3100e-003	4.3800e-003	0.0417	1.0000e-004	7.7500e-003	6.0000e-005	7.8100e-003	2.0600e-003	5.0000e-005	2.1100e-003	0.0000	7.2190	7.2190	3.8000e-004	0.0000	7.2270
Total	0.0152	0.1280	0.1825	4.0000e-004	0.0170	1.7900e-003	0.0187	4.5900e-003	1.6400e-003	6.2400e-003	0.0000	35.3283	35.3283	5.9000e-004	0.0000	35.3407

3.4 Intake 2a - Sheet Piling - 2017

Unmitigated Construction On-Site

	ROG	NOx	CO	SO2	Fugitive PM10	Exhaust PM10	PM10 Total	Fugitive PM2.5	Exhaust PM2.5	PM2.5 Total	Bio- CO2	NBio- CO2	Total CO2	CH4	N2O	CO2e
Category	tons/yr										MT/yr					
Off-Road	0.0600	0.5938	0.3560	8.4000e-004		0.0302	0.0302		0.0293	0.0293	0.0000	75.0391	75.0391	0.0157	0.0000	75.3691
Total	0.0600	0.5938	0.3560	8.4000e-004		0.0302	0.0302		0.0293	0.0293	0.0000	75.0391	75.0391	0.0157	0.0000	75.3691

Unmitigated Construction Off-Site

	ROG	NOx	CO	SO2	Fugitive PM10	Exhaust PM10	PM10 Total	Fugitive PM2.5	Exhaust PM2.5	PM2.5 Total	Bio- CO2	NBio- CO2	Total CO2	CH4	N2O	CO2e
Category	tons/yr										MT/yr					
Hauling	2.1400e-003	0.0283	0.0251	8.0000e-005	4.3600e-003	3.7000e-004	4.7200e-003	1.1200e-003	3.4000e-004	1.4600e-003	0.0000	7.3464	7.3464	5.0000e-005	0.0000	7.3475
Vendor	4.0600e-003	0.0341	0.0504	9.0000e-005	2.5400e-003	4.9000e-004	3.0200e-003	7.3000e-004	4.5000e-004	1.1700e-003	0.0000	8.2719	8.2719	6.0000e-005	0.0000	8.2732
Worker	1.7000e-003	2.2500e-003	0.0213	5.0000e-005	4.3800e-003	3.0000e-005	4.4100e-003	1.1600e-003	3.0000e-005	1.1900e-003	0.0000	3.9227	3.9227	2.0000e-004	0.0000	3.9269
Total	7.9000e-003	0.0646	0.0968	2.2000e-004	0.0113	8.9000e-004	0.0122	3.0100e-003	8.2000e-004	3.8200e-003	0.0000	19.5410	19.5410	3.1000e-004	0.0000	19.5476

Mitigated Construction On-Site

	ROG	NOx	CO	SO2	Fugitive PM10	Exhaust PM10	PM10 Total	Fugitive PM2.5	Exhaust PM2.5	PM2.5 Total	Bio- CO2	NBio- CO2	Total CO2	CH4	N2O	CO2e
Category	tons/yr										MT/yr					

Off-Road	0.0600	0.5938	0.3560	8.4000e-004		0.0302	0.0302		0.0293	0.0293	0.0000	75.0391	75.0391	0.0157	0.0000	75.3690
Total	0.0600	0.5938	0.3560	8.4000e-004		0.0302	0.0302		0.0293	0.0293	0.0000	75.0391	75.0391	0.0157	0.0000	75.3690

Mitigated Construction Off-Site

	ROG	NOx	CO	SO2	Fugitive PM10	Exhaust PM10	PM10 Total	Fugitive PM2.5	Exhaust PM2.5	PM2.5 Total	Bio- CO2	NBio- CO2	Total CO2	CH4	N2O	CO2e
Category	tons/yr										MT/yr					
Hauling	2.1400e-003	0.0283	0.0251	8.0000e-005	4.3600e-003	3.7000e-004	4.7200e-003	1.1200e-003	3.4000e-004	1.4600e-003	0.0000	7.3464	7.3464	5.0000e-005	0.0000	7.3475
Vendor	4.0600e-003	0.0341	0.0504	9.0000e-005	2.5400e-003	4.9000e-004	3.0200e-003	7.3000e-004	4.5000e-004	1.1700e-003	0.0000	8.2719	8.2719	6.0000e-005	0.0000	8.2732
Worker	1.7000e-003	2.2500e-003	0.0213	5.0000e-005	4.3800e-003	3.0000e-005	4.4100e-003	1.1600e-003	3.0000e-005	1.1900e-003	0.0000	3.9227	3.9227	2.0000e-004	0.0000	3.9269
Total	7.9000e-003	0.0646	0.0968	2.2000e-004	0.0113	8.9000e-004	0.0122	3.0100e-003	8.2000e-004	3.8200e-003	0.0000	19.5410	19.5410	3.1000e-004	0.0000	19.5476

3.5 Intake 2b - Excavation - 2017

Unmitigated Construction On-Site

	ROG	NOx	CO	SO2	Fugitive PM10	Exhaust PM10	PM10 Total	Fugitive PM2.5	Exhaust PM2.5	PM2.5 Total	Bio- CO2	NBio- CO2	Total CO2	CH4	N2O	CO2e
Category	tons/yr										MT/yr					
Fugitive Dust					1.2100e-003	0.0000	1.2100e-003	1.6000e-004	0.0000	1.6000e-004	0.0000	0.0000	0.0000	0.0000	0.0000	0.0000
Off-Road	0.1757	1.7825	0.9909	2.2800e-003		0.0864	0.0864		0.0822	0.0822	0.0000	206.7874	206.7874	0.0501	0.0000	207.8396
Total	0.1757	1.7825	0.9909	2.2800e-003	1.2100e-003	0.0864	0.0876	1.6000e-004	0.0822	0.0823	0.0000	206.7874	206.7874	0.0501	0.0000	207.8396

Unmitigated Construction Off-Site

	ROG	NOx	CO	SO2	Fugitive PM10	Exhaust PM10	PM10 Total	Fugitive PM2.5	Exhaust PM2.5	PM2.5 Total	Bio- CO2	NBio- CO2	Total CO2	CH4	N2O	CO2e
Category	tons/yr										MT/yr					
Hauling	5.9300e-003	0.0785	0.0694	2.3000e-004	5.1700e-003	1.0200e-003	6.1900e-003	1.4200e-003	9.4000e-004	2.3600e-003	0.0000	20.3440	20.3440	1.4000e-004	0.0000	20.3469
Vendor	7.3900e-003	0.0620	0.0918	1.7000e-004	4.6200e-003	8.9000e-004	5.5100e-003	1.3200e-003	8.2000e-004	2.1400e-003	0.0000	15.0591	15.0591	1.1000e-004	0.0000	15.0615
Worker	3.0900e-003	4.0900e-003	0.0387	1.0000e-004	7.9700e-003	6.0000e-005	8.0300e-003	2.1200e-003	5.0000e-005	2.1700e-003	0.0000	7.1413	7.1413	3.6000e-004	0.0000	7.1489
Total	0.0164	0.1446	0.2000	5.0000e-004	0.0178	1.9700e-003	0.0197	4.8600e-003	1.8100e-003	6.6700e-003	0.0000	42.5443	42.5443	6.1000e-004	0.0000	42.5573

Mitigated Construction On-Site

	ROG	NOx	CO	SO2	Fugitive PM10	Exhaust PM10	PM10 Total	Fugitive PM2.5	Exhaust PM2.5	PM2.5 Total	Bio- CO2	NBio- CO2	Total CO2	CH4	N2O	CO2e
Category	tons/yr										MT/yr					
Fugitive Dust					4.7000e-004	0.0000	4.7000e-004	6.0000e-005	0.0000	6.0000e-005	0.0000	0.0000	0.0000	0.0000	0.0000	0.0000
Off-Road	0.1757	1.7825	0.9909	2.2800e-003		0.0864	0.0864		0.0822	0.0822	0.0000	206.7872	206.7872	0.0501	0.0000	207.8394
Total	0.1757	1.7825	0.9909	2.2800e-003	4.7000e-004	0.0864	0.0869	6.0000e-005	0.0822	0.0822	0.0000	206.7872	206.7872	0.0501	0.0000	207.8394

Mitigated Construction Off-Site

	ROG	NOx	CO	SO2	Fugitive PM10	Exhaust PM10	PM10 Total	Fugitive PM2.5	Exhaust PM2.5	PM2.5 Total	Bio- CO2	NBio- CO2	Total CO2	CH4	N2O	CO2e
--	-----	-----	----	-----	---------------	--------------	------------	----------------	---------------	-------------	----------	-----------	-----------	-----	-----	------

Category	tons/yr										MT/yr					
	Hauling	5.9300e-003	0.0785	0.0694	2.3000e-004	5.1700e-003	1.0200e-003	6.1900e-003	1.4200e-003	9.4000e-004	2.3600e-003	0.0000	20.3440	20.3440	1.4000e-004	0.0000
Vendor	7.3900e-003	0.0620	0.0918	1.7000e-004	4.6200e-003	8.9000e-004	5.5100e-003	1.3200e-003	8.2000e-004	2.1400e-003	0.0000	15.0591	15.0591	1.1000e-004	0.0000	15.0615
Worker	3.0900e-003	4.0900e-003	0.0387	1.0000e-004	7.9700e-003	6.0000e-005	8.0300e-003	2.1200e-003	5.0000e-005	2.1700e-003	0.0000	7.1413	7.1413	3.6000e-004	0.0000	7.1489
Total	0.0164	0.1446	0.2000	5.0000e-004	0.0178	1.9700e-003	0.0197	4.8600e-003	1.8100e-003	6.6700e-003	0.0000	42.5443	42.5443	6.1000e-004	0.0000	42.5573

3.6 Intake 3 - Building Construction - 2017

Unmitigated Construction On-Site

	ROG	NOx	CO	SO2	Fugitive PM10	Exhaust PM10	PM10 Total	Fugitive PM2.5	Exhaust PM2.5	PM2.5 Total	Bio- CO2	NBio- CO2	Total CO2	CH4	N2O	CO2e
Category	tons/yr										MT/yr					
Off-Road	0.2406	2.3250	1.7214	2.6600e-003		0.1274	0.1274		0.1195	0.1195	0.0000	242.8704	242.8704	0.0632	0.0000	244.1979
Total	0.2406	2.3250	1.7214	2.6600e-003		0.1274	0.1274		0.1195	0.1195	0.0000	242.8704	242.8704	0.0632	0.0000	244.1979

Unmitigated Construction Off-Site

	ROG	NOx	CO	SO2	Fugitive PM10	Exhaust PM10	PM10 Total	Fugitive PM2.5	Exhaust PM2.5	PM2.5 Total	Bio- CO2	NBio- CO2	Total CO2	CH4	N2O	CO2e
Category	tons/yr										MT/yr					
Hauling	1.1200e-003	0.0148	0.0131	4.0000e-005	9.7000e-004	1.9000e-004	1.1600e-003	2.7000e-004	1.8000e-004	4.4000e-004	0.0000	3.8271	3.8271	3.0000e-005	0.0000	3.8276
Vendor	4.3700e-003	0.0367	0.0543	1.0000e-004	2.7300e-003	5.2000e-004	3.2600e-003	7.8000e-004	4.8000e-004	1.2600e-003	0.0000	8.9082	8.9082	7.0000e-005	0.0000	8.9096
Worker	2.4200e-003	3.2100e-003	0.0304	8.0000e-005	6.2500e-003	5.0000e-005	6.3000e-003	1.6600e-003	4.0000e-005	1.7100e-003	0.0000	5.6038	5.6038	2.8000e-004	0.0000	5.6098

Total	7.9100e-003	0.0547	0.0977	2.2000e-004	9.9500e-003	7.6000e-004	0.0107	2.7100e-003	7.0000e-004	3.4100e-003	0.0000	18.3391	18.3391	3.8000e-004	0.0000	18.3470
--------------	--------------------	---------------	---------------	--------------------	--------------------	--------------------	---------------	--------------------	--------------------	--------------------	---------------	----------------	----------------	--------------------	---------------	----------------

Mitigated Construction On-Site

	ROG	NOx	CO	SO2	Fugitive PM10	Exhaust PM10	PM10 Total	Fugitive PM2.5	Exhaust PM2.5	PM2.5 Total	Bio- CO2	NBio- CO2	Total CO2	CH4	N2O	CO2e
Category	tons/yr										MT/yr					
Off-Road	0.2406	2.3250	1.7214	2.6600e-003		0.1274	0.1274		0.1195	0.1195	0.0000	242.8701	242.8701	0.0632	0.0000	244.1976
Total	0.2406	2.3250	1.7214	2.6600e-003		0.1274	0.1274		0.1195	0.1195	0.0000	242.8701	242.8701	0.0632	0.0000	244.1976

Mitigated Construction Off-Site

	ROG	NOx	CO	SO2	Fugitive PM10	Exhaust PM10	PM10 Total	Fugitive PM2.5	Exhaust PM2.5	PM2.5 Total	Bio- CO2	NBio- CO2	Total CO2	CH4	N2O	CO2e
Category	tons/yr										MT/yr					
Hauling	1.1200e-003	0.0148	0.0131	4.0000e-005	9.7000e-004	1.9000e-004	1.1600e-003	2.7000e-004	1.8000e-004	4.4000e-004	0.0000	3.8271	3.8271	3.0000e-005	0.0000	3.8276
Vendor	4.3700e-003	0.0367	0.0543	1.0000e-004	2.7300e-003	5.2000e-004	3.2600e-003	7.8000e-004	4.8000e-004	1.2600e-003	0.0000	8.9082	8.9082	7.0000e-005	0.0000	8.9096
Worker	2.4200e-003	3.2100e-003	0.0304	8.0000e-005	6.2500e-003	5.0000e-005	6.3000e-003	1.6600e-003	4.0000e-005	1.7100e-003	0.0000	5.6038	5.6038	2.8000e-004	0.0000	5.6098
Total	7.9100e-003	0.0547	0.0977	2.2000e-004	9.9500e-003	7.6000e-004	0.0107	2.7100e-003	7.0000e-004	3.4100e-003	0.0000	18.3391	18.3391	3.8000e-004	0.0000	18.3470

3.7 Axial 1 - Paving - 2017

Unmitigated Construction On-Site

	ROG	NOx	CO	SO2	Fugitive PM10	Exhaust PM10	PM10 Total	Fugitive PM2.5	Exhaust PM2.5	PM2.5 Total	Bio- CO2	NBio- CO2	Total CO2	CH4	N2O	CO2e
Category	tons/yr										MT/yr					
Off-Road	3.6900e-003	0.0381	0.0266	4.0000e-005		2.2500e-003	2.2500e-003		2.0700e-003	2.0700e-003	0.0000	3.6432	3.6432	1.1200e-003	0.0000	3.6667
Paving	0.0000					0.0000	0.0000		0.0000	0.0000	0.0000	0.0000	0.0000	0.0000	0.0000	0.0000
Total	3.6900e-003	0.0381	0.0266	4.0000e-005		2.2500e-003	2.2500e-003		2.0700e-003	2.0700e-003	0.0000	3.6432	3.6432	1.1200e-003	0.0000	3.6667

Unmitigated Construction Off-Site

	ROG	NOx	CO	SO2	Fugitive PM10	Exhaust PM10	PM10 Total	Fugitive PM2.5	Exhaust PM2.5	PM2.5 Total	Bio- CO2	NBio- CO2	Total CO2	CH4	N2O	CO2e
Category	tons/yr										MT/yr					
Hauling	0.0000	0.0000	0.0000	0.0000	0.0000	0.0000	0.0000	0.0000	0.0000	0.0000	0.0000	0.0000	0.0000	0.0000	0.0000	0.0000
Vendor	1.0300e-003	8.6500e-003	0.0128	2.0000e-005	6.4000e-004	1.2000e-004	7.7000e-004	1.8000e-004	1.1000e-004	3.0000e-004	0.0000	2.0998	2.0998	2.0000e-005	0.0000	2.1001
Worker	2.1000e-004	2.7000e-004	2.5700e-003	1.0000e-005	5.3000e-004	0.0000	5.3000e-004	1.4000e-004	0.0000	1.4000e-004	0.0000	0.4742	0.4742	2.0000e-005	0.0000	0.4747
Total	1.2400e-003	8.9200e-003	0.0154	3.0000e-005	1.1700e-003	1.2000e-004	1.3000e-003	3.2000e-004	1.1000e-004	4.4000e-004	0.0000	2.5740	2.5740	4.0000e-005	0.0000	2.5748

Mitigated Construction On-Site

	ROG	NOx	CO	SO2	Fugitive PM10	Exhaust PM10	PM10 Total	Fugitive PM2.5	Exhaust PM2.5	PM2.5 Total	Bio- CO2	NBio- CO2	Total CO2	CH4	N2O	CO2e
Category	tons/yr										MT/yr					

Off-Road	3.6900e-003	0.0381	0.0266	4.0000e-005		2.2500e-003	2.2500e-003		2.0700e-003	2.0700e-003	0.0000	3.6432	3.6432	1.1200e-003	0.0000	3.6667
Paving	0.0000					0.0000	0.0000		0.0000	0.0000	0.0000	0.0000	0.0000	0.0000	0.0000	0.0000
Total	3.6900e-003	0.0381	0.0266	4.0000e-005		2.2500e-003	2.2500e-003		2.0700e-003	2.0700e-003	0.0000	3.6432	3.6432	1.1200e-003	0.0000	3.6667

Mitigated Construction Off-Site

	ROG	NOx	CO	SO2	Fugitive PM10	Exhaust PM10	PM10 Total	Fugitive PM2.5	Exhaust PM2.5	PM2.5 Total	Bio- CO2	NBio- CO2	Total CO2	CH4	N2O	CO2e
Category	tons/yr										MT/yr					
Hauling	0.0000	0.0000	0.0000	0.0000	0.0000	0.0000	0.0000	0.0000	0.0000	0.0000	0.0000	0.0000	0.0000	0.0000	0.0000	0.0000
Vendor	1.0300e-003	8.6500e-003	0.0128	2.0000e-005	6.4000e-004	1.2000e-004	7.7000e-004	1.8000e-004	1.1000e-004	3.0000e-004	0.0000	2.0998	2.0998	2.0000e-005	0.0000	2.1001
Worker	2.1000e-004	2.7000e-004	2.5700e-003	1.0000e-005	5.3000e-004	0.0000	5.3000e-004	1.4000e-004	0.0000	1.4000e-004	0.0000	0.4742	0.4742	2.0000e-005	0.0000	0.4747
Total	1.2400e-003	8.9200e-003	0.0154	3.0000e-005	1.1700e-003	1.2000e-004	1.3000e-003	3.2000e-004	1.1000e-004	4.4000e-004	0.0000	2.5740	2.5740	4.0000e-005	0.0000	2.5748

3.8 Intake 4 - Demolition - 2017

Unmitigated Construction On-Site

	ROG	NOx	CO	SO2	Fugitive PM10	Exhaust PM10	PM10 Total	Fugitive PM2.5	Exhaust PM2.5	PM2.5 Total	Bio- CO2	NBio- CO2	Total CO2	CH4	N2O	CO2e
Category	tons/yr										MT/yr					
Fugitive Dust					7.8000e-004	0.0000	7.8000e-004	1.2000e-004	0.0000	1.2000e-004	0.0000	0.0000	0.0000	0.0000	0.0000	0.0000
Off-Road	0.4531	4.7533	2.4775	6.2000e-003		0.2033	0.2033		0.1910	0.1910	0.0000	568.3463	568.3463	0.1548	0.0000	571.5961
Total	0.4531	4.7533	2.4775	6.2000e-003	7.8000e-004	0.2033	0.2041	1.2000e-004	0.1910	0.1911	0.0000	568.3463	568.3463	0.1548	0.0000	571.5961

Unmitigated Construction Off-Site

	ROG	NOx	CO	SO2	Fugitive PM10	Exhaust PM10	PM10 Total	Fugitive PM2.5	Exhaust PM2.5	PM2.5 Total	Bio- CO2	NBio- CO2	Total CO2	CH4	N2O	CO2e
Category	tons/yr										MT/yr					
Hauling	2.2000e-004	2.8500e-003	2.5200e-003	1.0000e-005	1.9000e-004	4.0000e-005	2.2000e-004	5.0000e-005	3.0000e-005	9.0000e-005	0.0000	0.7386	0.7386	1.0000e-005	0.0000	0.7387
Vendor	1.6500e-003	0.0138	0.0204	4.0000e-005	1.0300e-003	2.0000e-004	1.2300e-003	2.9000e-004	1.8000e-004	4.8000e-004	0.0000	3.3512	3.3512	3.0000e-005	0.0000	3.3517
Worker	2.7000e-003	3.5800e-003	0.0338	9.0000e-005	6.9700e-003	5.0000e-005	7.0200e-003	1.8500e-003	5.0000e-005	1.9000e-003	0.0000	6.2432	6.2432	3.2000e-004	0.0000	6.2499
Total	4.5700e-003	0.0202	0.0568	1.4000e-004	8.1900e-003	2.9000e-004	8.4700e-003	2.1900e-003	2.6000e-004	2.4700e-003	0.0000	10.3330	10.3330	3.6000e-004	0.0000	10.3403

Mitigated Construction On-Site

	ROG	NOx	CO	SO2	Fugitive PM10	Exhaust PM10	PM10 Total	Fugitive PM2.5	Exhaust PM2.5	PM2.5 Total	Bio- CO2	NBio- CO2	Total CO2	CH4	N2O	CO2e
Category	tons/yr										MT/yr					
Fugitive Dust					3.0000e-004	0.0000	3.0000e-004	5.0000e-005	0.0000	5.0000e-005	0.0000	0.0000	0.0000	0.0000	0.0000	0.0000
Off-Road	0.4530	4.7533	2.4775	6.2000e-003		0.2033	0.2033		0.1910	0.1910	0.0000	568.3456	568.3456	0.1548	0.0000	571.5955
Total	0.4530	4.7533	2.4775	6.2000e-003	3.0000e-004	0.2033	0.2036	5.0000e-005	0.1910	0.1911	0.0000	568.3456	568.3456	0.1548	0.0000	571.5955

Mitigated Construction Off-Site

	ROG	NOx	CO	SO2	Fugitive PM10	Exhaust PM10	PM10 Total	Fugitive PM2.5	Exhaust PM2.5	PM2.5 Total	Bio- CO2	NBio- CO2	Total CO2	CH4	N2O	CO2e
--	-----	-----	----	-----	---------------	--------------	------------	----------------	---------------	-------------	----------	-----------	-----------	-----	-----	------

Category	tons/yr										MT/yr					
	Hauling	2.2000e-004	2.8500e-003	2.5200e-003	1.0000e-005	1.9000e-004	4.0000e-005	2.2000e-004	5.0000e-005	3.0000e-005	9.0000e-005	0.0000	0.7386	0.7386	1.0000e-005	0.0000
Vendor	1.6500e-003	0.0138	0.0204	4.0000e-005	1.0300e-003	2.0000e-004	1.2300e-003	2.9000e-004	1.8000e-004	4.8000e-004	0.0000	3.3512	3.3512	3.0000e-005	0.0000	3.3517
Worker	2.7000e-003	3.5800e-003	0.0338	9.0000e-005	6.9700e-003	5.0000e-005	7.0200e-003	1.8500e-003	5.0000e-005	1.9000e-003	0.0000	6.2432	6.2432	3.2000e-004	0.0000	6.2499
Total	4.5700e-003	0.0202	0.0568	1.4000e-004	8.1900e-003	2.9000e-004	8.4700e-003	2.1900e-003	2.6000e-004	2.4700e-003	0.0000	10.3330	10.3330	3.6000e-004	0.0000	10.3403

3.9 Axial 2 - Pump Station Install - 2017

Unmitigated Construction On-Site

	ROG	NOx	CO	SO2	Fugitive PM10	Exhaust PM10	PM10 Total	Fugitive PM2.5	Exhaust PM2.5	PM2.5 Total	Bio- CO2	NBio- CO2	Total CO2	CH4	N2O	CO2e
Category	tons/yr										MT/yr					
Off-Road	0.0638	0.6115	0.3831	6.9000e-004		0.0337	0.0337		0.0325	0.0325	0.0000	60.9533	60.9533	0.0112	0.0000	61.1887
Total	0.0638	0.6115	0.3831	6.9000e-004		0.0337	0.0337		0.0325	0.0325	0.0000	60.9533	60.9533	0.0112	0.0000	61.1887

Unmitigated Construction Off-Site

	ROG	NOx	CO	SO2	Fugitive PM10	Exhaust PM10	PM10 Total	Fugitive PM2.5	Exhaust PM2.5	PM2.5 Total	Bio- CO2	NBio- CO2	Total CO2	CH4	N2O	CO2e
Category	tons/yr										MT/yr					
Hauling	0.0000	0.0000	0.0000	0.0000	0.0000	0.0000	0.0000	0.0000	0.0000	0.0000	0.0000	0.0000	0.0000	0.0000	0.0000	0.0000
Vendor	4.1600e-003	0.0349	0.0517	9.0000e-005	2.6000e-003	5.0000e-004	3.1000e-003	7.4000e-004	4.6000e-004	1.2000e-003	0.0000	8.4840	8.4840	6.0000e-005	0.0000	8.4853
Worker	9.9000e-004	1.3200e-003	0.0125	3.0000e-005	2.5700e-003	2.0000e-005	2.5900e-003	6.8000e-004	2.0000e-005	7.0000e-004	0.0000	2.2990	2.2990	1.2000e-004	0.0000	2.3015

Total	5.1500e-003	0.0363	0.0642	1.2000e-004	5.1700e-003	5.2000e-004	5.6900e-003	1.4200e-003	4.8000e-004	1.9000e-003	0.0000	10.7830	10.7830	1.8000e-004	0.0000	10.7868
--------------	--------------------	---------------	---------------	--------------------	--------------------	--------------------	--------------------	--------------------	--------------------	--------------------	---------------	----------------	----------------	--------------------	---------------	----------------

Mitigated Construction On-Site

	ROG	NOx	CO	SO2	Fugitive PM10	Exhaust PM10	PM10 Total	Fugitive PM2.5	Exhaust PM2.5	PM2.5 Total	Bio- CO2	NBio- CO2	Total CO2	CH4	N2O	CO2e
Category	tons/yr										MT/yr					
Off-Road	0.0638	0.6115	0.3831	6.9000e-004		0.0337	0.0337		0.0325	0.0325	0.0000	60.9533	60.9533	0.0112	0.0000	61.1887
Total	0.0638	0.6115	0.3831	6.9000e-004		0.0337	0.0337		0.0325	0.0325	0.0000	60.9533	60.9533	0.0112	0.0000	61.1887

Mitigated Construction Off-Site

	ROG	NOx	CO	SO2	Fugitive PM10	Exhaust PM10	PM10 Total	Fugitive PM2.5	Exhaust PM2.5	PM2.5 Total	Bio- CO2	NBio- CO2	Total CO2	CH4	N2O	CO2e
Category	tons/yr										MT/yr					
Hauling	0.0000	0.0000	0.0000	0.0000	0.0000	0.0000	0.0000	0.0000	0.0000	0.0000	0.0000	0.0000	0.0000	0.0000	0.0000	0.0000
Vendor	4.1600e-003	0.0349	0.0517	9.0000e-005	2.6000e-003	5.0000e-004	3.1000e-003	7.4000e-004	4.6000e-004	1.2000e-003	0.0000	8.4840	8.4840	6.0000e-005	0.0000	8.4853
Worker	9.9000e-004	1.3200e-003	0.0125	3.0000e-005	2.5700e-003	2.0000e-005	2.5900e-003	6.8000e-004	2.0000e-005	7.0000e-004	0.0000	2.2990	2.2990	1.2000e-004	0.0000	2.3015
Total	5.1500e-003	0.0363	0.0642	1.2000e-004	5.1700e-003	5.2000e-004	5.6900e-003	1.4200e-003	4.8000e-004	1.9000e-003	0.0000	10.7830	10.7830	1.8000e-004	0.0000	10.7868

3.10 Axial 3a - Trenching - 2017

Unmitigated Construction On-Site

	ROG	NOx	CO	SO2	Fugitive PM10	Exhaust PM10	PM10 Total	Fugitive PM2.5	Exhaust PM2.5	PM2.5 Total	Bio- CO2	NBio- CO2	Total CO2	CH4	N2O	CO2e
Category	tons/yr										MT/yr					
Off-Road	4.0400e-003	0.0507	0.0242	1.0000e-004		1.6400e-003	1.6400e-003		1.5100e-003	1.5100e-003	0.0000	9.1071	9.1071	2.7900e-003	0.0000	9.1657
Total	4.0400e-003	0.0507	0.0242	1.0000e-004		1.6400e-003	1.6400e-003		1.5100e-003	1.5100e-003	0.0000	9.1071	9.1071	2.7900e-003	0.0000	9.1657

Unmitigated Construction Off-Site

	ROG	NOx	CO	SO2	Fugitive PM10	Exhaust PM10	PM10 Total	Fugitive PM2.5	Exhaust PM2.5	PM2.5 Total	Bio- CO2	NBio- CO2	Total CO2	CH4	N2O	CO2e
Category	tons/yr										MT/yr					
Hauling	0.0000	0.0000	0.0000	0.0000	0.0000	0.0000	0.0000	0.0000	0.0000	0.0000	0.0000	0.0000	0.0000	0.0000	0.0000	0.0000
Vendor	0.0000	0.0000	0.0000	0.0000	0.0000	0.0000	0.0000	0.0000	0.0000	0.0000	0.0000	0.0000	0.0000	0.0000	0.0000	0.0000
Worker	9.0000e-005	1.2000e-004	1.1700e-003	0.0000	2.4000e-004	0.0000	2.4000e-004	6.0000e-005	0.0000	7.0000e-005	0.0000	0.2155	0.2155	1.0000e-005	0.0000	0.2158
Total	9.0000e-005	1.2000e-004	1.1700e-003	0.0000	2.4000e-004	0.0000	2.4000e-004	6.0000e-005	0.0000	7.0000e-005	0.0000	0.2155	0.2155	1.0000e-005	0.0000	0.2158

Mitigated Construction On-Site

	ROG	NOx	CO	SO2	Fugitive PM10	Exhaust PM10	PM10 Total	Fugitive PM2.5	Exhaust PM2.5	PM2.5 Total	Bio- CO2	NBio- CO2	Total CO2	CH4	N2O	CO2e
Category	tons/yr										MT/yr					

Off-Road	4.0400e-003	0.0507	0.0242	1.0000e-004		1.6400e-003	1.6400e-003		1.5100e-003	1.5100e-003	0.0000	9.1071	9.1071	2.7900e-003	0.0000	9.1657
Total	4.0400e-003	0.0507	0.0242	1.0000e-004		1.6400e-003	1.6400e-003		1.5100e-003	1.5100e-003	0.0000	9.1071	9.1071	2.7900e-003	0.0000	9.1657

Mitigated Construction Off-Site

	ROG	NOx	CO	SO2	Fugitive PM10	Exhaust PM10	PM10 Total	Fugitive PM2.5	Exhaust PM2.5	PM2.5 Total	Bio- CO2	NBio- CO2	Total CO2	CH4	N2O	CO2e
Category	tons/yr										MT/yr					
Hauling	0.0000	0.0000	0.0000	0.0000	0.0000	0.0000	0.0000	0.0000	0.0000	0.0000	0.0000	0.0000	0.0000	0.0000	0.0000	0.0000
Vendor	0.0000	0.0000	0.0000	0.0000	0.0000	0.0000	0.0000	0.0000	0.0000	0.0000	0.0000	0.0000	0.0000	0.0000	0.0000	0.0000
Worker	9.0000e-005	1.2000e-004	1.1700e-003	0.0000	2.4000e-004	0.0000	2.4000e-004	6.0000e-005	0.0000	7.0000e-005	0.0000	0.2155	0.2155	1.0000e-005	0.0000	0.2158
Total	9.0000e-005	1.2000e-004	1.1700e-003	0.0000	2.4000e-004	0.0000	2.4000e-004	6.0000e-005	0.0000	7.0000e-005	0.0000	0.2155	0.2155	1.0000e-005	0.0000	0.2158

3.11 Axial 3b - Paving - 2017

Unmitigated Construction On-Site

	ROG	NOx	CO	SO2	Fugitive PM10	Exhaust PM10	PM10 Total	Fugitive PM2.5	Exhaust PM2.5	PM2.5 Total	Bio- CO2	NBio- CO2	Total CO2	CH4	N2O	CO2e
Category	tons/yr										MT/yr					
Off-Road	6.7100e-003	0.0693	0.0483	7.0000e-005		4.0900e-003	4.0900e-003		3.7600e-003	3.7600e-003	0.0000	6.6241	6.6241	2.0300e-003	0.0000	6.6667
Paving	0.0000					0.0000	0.0000		0.0000	0.0000	0.0000	0.0000	0.0000	0.0000	0.0000	0.0000
Total	6.7100e-003	0.0693	0.0483	7.0000e-005		4.0900e-003	4.0900e-003		3.7600e-003	3.7600e-003	0.0000	6.6241	6.6241	2.0300e-003	0.0000	6.6667

Unmitigated Construction Off-Site

	ROG	NOx	CO	SO2	Fugitive PM10	Exhaust PM10	PM10 Total	Fugitive PM2.5	Exhaust PM2.5	PM2.5 Total	Bio- CO2	NBio- CO2	Total CO2	CH4	N2O	CO2e
Category	tons/yr										MT/yr					
Hauling	0.0000	0.0000	0.0000	0.0000	0.0000	0.0000	0.0000	0.0000	0.0000	0.0000	0.0000	0.0000	0.0000	0.0000	0.0000	0.0000
Vendor	1.6700e-003	0.0140	0.0207	4.0000e-005	1.0400e-003	2.0000e-004	1.2400e-003	3.0000e-004	1.8000e-004	4.8000e-004	0.0000	3.3936	3.3936	3.0000e-005	0.0000	3.3941
Worker	4.4000e-004	5.8000e-004	5.4500e-003	1.0000e-005	1.1200e-003	1.0000e-005	1.1300e-003	3.0000e-004	1.0000e-005	3.1000e-004	0.0000	1.0058	1.0058	5.0000e-005	0.0000	1.0069
Total	2.1100e-003	0.0146	0.0261	5.0000e-005	2.1600e-003	2.1000e-004	2.3700e-003	6.0000e-004	1.9000e-004	7.9000e-004	0.0000	4.3994	4.3994	8.0000e-005	0.0000	4.4010

Mitigated Construction On-Site

	ROG	NOx	CO	SO2	Fugitive PM10	Exhaust PM10	PM10 Total	Fugitive PM2.5	Exhaust PM2.5	PM2.5 Total	Bio- CO2	NBio- CO2	Total CO2	CH4	N2O	CO2e
Category	tons/yr										MT/yr					
Off-Road	6.7100e-003	0.0693	0.0483	7.0000e-005		4.0900e-003	4.0900e-003		3.7600e-003	3.7600e-003	0.0000	6.6241	6.6241	2.0300e-003	0.0000	6.6667
Paving	0.0000					0.0000	0.0000		0.0000	0.0000	0.0000	0.0000	0.0000	0.0000	0.0000	0.0000
Total	6.7100e-003	0.0693	0.0483	7.0000e-005		4.0900e-003	4.0900e-003		3.7600e-003	3.7600e-003	0.0000	6.6241	6.6241	2.0300e-003	0.0000	6.6667

Mitigated Construction Off-Site

	ROG	NOx	CO	SO2	Fugitive PM10	Exhaust PM10	PM10 Total	Fugitive PM2.5	Exhaust PM2.5	PM2.5 Total	Bio- CO2	NBio- CO2	Total CO2	CH4	N2O	CO2e
--	-----	-----	----	-----	---------------	--------------	------------	----------------	---------------	-------------	----------	-----------	-----------	-----	-----	------

Category	tons/yr										MT/yr					
	Hauling	0.0000	0.0000	0.0000	0.0000	0.0000	0.0000	0.0000	0.0000	0.0000	0.0000	0.0000	0.0000	0.0000	0.0000	0.0000
Vendor	1.6700e-003	0.0140	0.0207	4.0000e-005	1.0400e-003	2.0000e-004	1.2400e-003	3.0000e-004	1.8000e-004	4.8000e-004	0.0000	3.3936	3.3936	3.0000e-005	0.0000	3.3941
Worker	4.4000e-004	5.8000e-004	5.4500e-003	1.0000e-005	1.1200e-003	1.0000e-005	1.1300e-003	3.0000e-004	1.0000e-005	3.1000e-004	0.0000	1.0058	1.0058	5.0000e-005	0.0000	1.0069
Total	2.1100e-003	0.0146	0.0261	5.0000e-005	2.1600e-003	2.1000e-004	2.3700e-003	6.0000e-004	1.9000e-004	7.9000e-004	0.0000	4.3994	4.3994	8.0000e-005	0.0000	4.4010

3.12 Intake 5 - Backfill - 2017

Unmitigated Construction On-Site

Category	ROG	NOx	CO	SO2	Fugitive PM10	Exhaust PM10	PM10 Total	Fugitive PM2.5	Exhaust PM2.5	PM2.5 Total	Bio- CO2	NBio- CO2	Total CO2	CH4	N2O	CO2e
	tons/yr										MT/yr					
Fugitive Dust					0.0000	0.0000	0.0000	0.0000	0.0000	0.0000	0.0000	0.0000	0.0000	0.0000	0.0000	0.0000
Off-Road	0.0350	0.3674	0.2015	4.9000e-004		0.0165	0.0165		0.0156	0.0156	0.0000	44.3474	44.3474	0.0115	0.0000	44.5896
Total	0.0350	0.3674	0.2015	4.9000e-004	0.0000	0.0165	0.0165	0.0000	0.0156	0.0156	0.0000	44.3474	44.3474	0.0115	0.0000	44.5896

Unmitigated Construction Off-Site

Category	ROG	NOx	CO	SO2	Fugitive PM10	Exhaust PM10	PM10 Total	Fugitive PM2.5	Exhaust PM2.5	PM2.5 Total	Bio- CO2	NBio- CO2	Total CO2	CH4	N2O	CO2e
	tons/yr										MT/yr					
Hauling	0.0000	0.0000	0.0000	0.0000	0.0000	0.0000	0.0000	0.0000	0.0000	0.0000	0.0000	0.0000	0.0000	0.0000	0.0000	0.0000
Vendor	2.3000e-004	1.9200e-003	2.8500e-003	1.0000e-005	1.4000e-004	3.0000e-005	1.7000e-004	4.0000e-005	3.0000e-005	7.0000e-005	0.0000	0.4666	0.4666	0.0000	0.0000	0.4667
Worker	4.4000e-004	5.9000e-004	5.5700e-003	1.0000e-005	1.1500e-003	1.0000e-005	1.1600e-003	3.0000e-004	1.0000e-005	3.1000e-004	0.0000	1.0274	1.0274	5.0000e-005	0.0000	1.0285

Total	6.7000e-004	2.5100e-003	8.4200e-003	2.0000e-005	1.2900e-003	4.0000e-005	1.3300e-003	3.4000e-004	4.0000e-005	3.8000e-004	0.0000	1.4940	1.4940	5.0000e-005	0.0000	1.4952
--------------	--------------------	--------------------	--------------------	--------------------	--------------------	--------------------	--------------------	--------------------	--------------------	--------------------	---------------	---------------	---------------	--------------------	---------------	---------------

Mitigated Construction On-Site

	ROG	NOx	CO	SO2	Fugitive PM10	Exhaust PM10	PM10 Total	Fugitive PM2.5	Exhaust PM2.5	PM2.5 Total	Bio- CO2	NBio- CO2	Total CO2	CH4	N2O	CO2e
Category	tons/yr										MT/yr					
Fugitive Dust					0.0000	0.0000	0.0000	0.0000	0.0000	0.0000	0.0000	0.0000	0.0000	0.0000	0.0000	0.0000
Off-Road	0.0350	0.3674	0.2015	4.9000e-004		0.0165	0.0165		0.0156	0.0156	0.0000	44.3473	44.3473	0.0115	0.0000	44.5895
Total	0.0350	0.3674	0.2015	4.9000e-004	0.0000	0.0165	0.0165	0.0000	0.0156	0.0156	0.0000	44.3473	44.3473	0.0115	0.0000	44.5895

Mitigated Construction Off-Site

	ROG	NOx	CO	SO2	Fugitive PM10	Exhaust PM10	PM10 Total	Fugitive PM2.5	Exhaust PM2.5	PM2.5 Total	Bio- CO2	NBio- CO2	Total CO2	CH4	N2O	CO2e
Category	tons/yr										MT/yr					
Hauling	0.0000	0.0000	0.0000	0.0000	0.0000	0.0000	0.0000	0.0000	0.0000	0.0000	0.0000	0.0000	0.0000	0.0000	0.0000	0.0000
Vendor	2.3000e-004	1.9200e-003	2.8500e-003	1.0000e-005	1.4000e-004	3.0000e-005	1.7000e-004	4.0000e-005	3.0000e-005	7.0000e-005	0.0000	0.4666	0.4666	0.0000	0.0000	0.4667
Worker	4.4000e-004	5.9000e-004	5.5700e-003	1.0000e-005	1.1500e-003	1.0000e-005	1.1600e-003	3.0000e-004	1.0000e-005	3.1000e-004	0.0000	1.0274	1.0274	5.0000e-005	0.0000	1.0285
Total	6.7000e-004	2.5100e-003	8.4200e-003	2.0000e-005	1.2900e-003	4.0000e-005	1.3300e-003	3.4000e-004	4.0000e-005	3.8000e-004	0.0000	1.4940	1.4940	5.0000e-005	0.0000	1.4952

3.12 Intake 5 - Backfill - 2018

Unmitigated Construction On-Site

	ROG	NOx	CO	SO2	Fugitive PM10	Exhaust PM10	PM10 Total	Fugitive PM2.5	Exhaust PM2.5	PM2.5 Total	Bio- CO2	NBio- CO2	Total CO2	CH4	N2O	CO2e
Category	tons/yr										MT/yr					
Fugitive Dust					0.0000	0.0000	0.0000	0.0000	0.0000	0.0000	0.0000	0.0000	0.0000	0.0000	0.0000	0.0000
Off-Road	0.0532	0.5468	0.3294	8.4000e-004		0.0240	0.0240		0.0228	0.0228	0.0000	75.6114	75.6114	0.0197	0.0000	76.0260
Total	0.0532	0.5468	0.3294	8.4000e-004	0.0000	0.0240	0.0240	0.0000	0.0228	0.0228	0.0000	75.6114	75.6114	0.0197	0.0000	76.0260

Unmitigated Construction Off-Site

	ROG	NOx	CO	SO2	Fugitive PM10	Exhaust PM10	PM10 Total	Fugitive PM2.5	Exhaust PM2.5	PM2.5 Total	Bio- CO2	NBio- CO2	Total CO2	CH4	N2O	CO2e
Category	tons/yr										MT/yr					
Hauling	0.0000	0.0000	0.0000	0.0000	0.0000	0.0000	0.0000	0.0000	0.0000	0.0000	0.0000	0.0000	0.0000	0.0000	0.0000	0.0000
Vendor	3.7000e-004	3.0000e-003	4.7000e-003	1.0000e-005	2.5000e-004	4.0000e-005	2.9000e-004	7.0000e-005	4.0000e-005	1.1000e-004	0.0000	0.7921	0.7921	1.0000e-005	0.0000	0.7923
Worker	7.0000e-004	9.3000e-004	8.7000e-003	2.0000e-005	1.9800e-003	1.0000e-005	2.0000e-003	5.3000e-004	1.0000e-005	5.4000e-004	0.0000	1.7079	1.7079	8.0000e-005	0.0000	1.7097
Total	1.0700e-003	3.9300e-003	0.0134	3.0000e-005	2.2300e-003	5.0000e-005	2.2900e-003	6.0000e-004	5.0000e-005	6.5000e-004	0.0000	2.5000	2.5000	9.0000e-005	0.0000	2.5019

Mitigated Construction On-Site

	ROG	NOx	CO	SO2	Fugitive PM10	Exhaust PM10	PM10 Total	Fugitive PM2.5	Exhaust PM2.5	PM2.5 Total	Bio- CO2	NBio- CO2	Total CO2	CH4	N2O	CO2e
Category	tons/yr										MT/yr					

Fugitive Dust					0.0000	0.0000	0.0000	0.0000	0.0000	0.0000	0.0000	0.0000	0.0000	0.0000	0.0000	0.0000
Off-Road	0.0532	0.5468	0.3294	8.4000e-004		0.0240	0.0240		0.0228	0.0228	0.0000	75.6113	75.6113	0.0197	0.0000	76.0259
Total	0.0532	0.5468	0.3294	8.4000e-004	0.0000	0.0240	0.0240	0.0000	0.0228	0.0228	0.0000	75.6113	75.6113	0.0197	0.0000	76.0259

Mitigated Construction Off-Site

	ROG	NOx	CO	SO2	Fugitive PM10	Exhaust PM10	PM10 Total	Fugitive PM2.5	Exhaust PM2.5	PM2.5 Total	Bio- CO2	NBio- CO2	Total CO2	CH4	N2O	CO2e
Category	tons/yr										MT/yr					
Hauling	0.0000	0.0000	0.0000	0.0000	0.0000	0.0000	0.0000	0.0000	0.0000	0.0000	0.0000	0.0000	0.0000	0.0000	0.0000	0.0000
Vendor	3.7000e-004	3.0000e-003	4.7000e-003	1.0000e-005	2.5000e-004	4.0000e-005	2.9000e-004	7.0000e-005	4.0000e-005	1.1000e-004	0.0000	0.7921	0.7921	1.0000e-005	0.0000	0.7923
Worker	7.0000e-004	9.3000e-004	8.7000e-003	2.0000e-005	1.9800e-003	1.0000e-005	2.0000e-003	5.3000e-004	1.0000e-005	5.4000e-004	0.0000	1.7079	1.7079	8.0000e-005	0.0000	1.7097
Total	1.0700e-003	3.9300e-003	0.0134	3.0000e-005	2.2300e-003	5.0000e-005	2.2900e-003	6.0000e-004	5.0000e-005	6.5000e-004	0.0000	2.5000	2.5000	9.0000e-005	0.0000	2.5019

3.13 Axial 4 - Building Construction - 2017

Unmitigated Construction On-Site

	ROG	NOx	CO	SO2	Fugitive PM10	Exhaust PM10	PM10 Total	Fugitive PM2.5	Exhaust PM2.5	PM2.5 Total	Bio- CO2	NBio- CO2	Total CO2	CH4	N2O	CO2e
Category	tons/yr										MT/yr					
Off-Road	5.1700e-003	0.0551	0.0283	7.0000e-005		2.2900e-003	2.2900e-003		2.1500e-003	2.1500e-003	0.0000	6.6248	6.6248	1.8400e-003	0.0000	6.6635
Total	5.1700e-003	0.0551	0.0283	7.0000e-005		2.2900e-003	2.2900e-003		2.1500e-003	2.1500e-003	0.0000	6.6248	6.6248	1.8400e-003	0.0000	6.6635

Unmitigated Construction Off-Site

	ROG	NOx	CO	SO2	Fugitive PM10	Exhaust PM10	PM10 Total	Fugitive PM2.5	Exhaust PM2.5	PM2.5 Total	Bio- CO2	NBio- CO2	Total CO2	CH4	N2O	CO2e
Category	tons/yr										MT/yr					
Hauling	0.0000	0.0000	0.0000	0.0000	0.0000	0.0000	0.0000	0.0000	0.0000	0.0000	0.0000	0.0000	0.0000	0.0000	0.0000	0.0000
Vendor	1.0000e-004	8.7000e-004	1.2900e-003	0.0000	7.0000e-005	1.0000e-005	8.0000e-005	2.0000e-005	1.0000e-005	3.0000e-005	0.0000	0.2121	0.2121	0.0000	0.0000	0.2121
Worker	4.0000e-005	5.0000e-005	5.1000e-004	0.0000	1.0000e-004	0.0000	1.1000e-004	3.0000e-005	0.0000	3.0000e-005	0.0000	0.0934	0.0934	0.0000	0.0000	0.0935
Total	1.4000e-004	9.2000e-004	1.8000e-003	0.0000	1.7000e-004	1.0000e-005	1.9000e-004	5.0000e-005	1.0000e-005	6.0000e-005	0.0000	0.3055	0.3055	0.0000	0.0000	0.3056

Mitigated Construction On-Site

	ROG	NOx	CO	SO2	Fugitive PM10	Exhaust PM10	PM10 Total	Fugitive PM2.5	Exhaust PM2.5	PM2.5 Total	Bio- CO2	NBio- CO2	Total CO2	CH4	N2O	CO2e
Category	tons/yr										MT/yr					
Off-Road	5.1700e-003	0.0551	0.0283	7.0000e-005		2.2900e-003	2.2900e-003		2.1500e-003	2.1500e-003	0.0000	6.6248	6.6248	1.8400e-003	0.0000	6.6635
Total	5.1700e-003	0.0551	0.0283	7.0000e-005		2.2900e-003	2.2900e-003		2.1500e-003	2.1500e-003	0.0000	6.6248	6.6248	1.8400e-003	0.0000	6.6635

Mitigated Construction Off-Site

	ROG	NOx	CO	SO2	Fugitive PM10	Exhaust PM10	PM10 Total	Fugitive PM2.5	Exhaust PM2.5	PM2.5 Total	Bio- CO2	NBio- CO2	Total CO2	CH4	N2O	CO2e
--	-----	-----	----	-----	---------------	--------------	------------	----------------	---------------	-------------	----------	-----------	-----------	-----	-----	------

Category	tons/yr										MT/yr					
	Hauling	0.0000	0.0000	0.0000	0.0000	0.0000	0.0000	0.0000	0.0000	0.0000	0.0000	0.0000	0.0000	0.0000	0.0000	0.0000
Vendor	1.0000e-004	8.7000e-004	1.2900e-003	0.0000	7.0000e-005	1.0000e-005	8.0000e-005	2.0000e-005	1.0000e-005	3.0000e-005	0.0000	0.2121	0.2121	0.0000	0.0000	0.2121
Worker	4.0000e-005	5.0000e-005	5.1000e-004	0.0000	1.0000e-004	0.0000	1.1000e-004	3.0000e-005	0.0000	3.0000e-005	0.0000	0.0934	0.0934	0.0000	0.0000	0.0935
Total	1.4000e-004	9.2000e-004	1.8000e-003	0.0000	1.7000e-004	1.0000e-005	1.9000e-004	5.0000e-005	1.0000e-005	6.0000e-005	0.0000	0.3055	0.3055	0.0000	0.0000	0.3056

3.13 Axial 4 - Building Construction - 2018

Unmitigated Construction On-Site

	ROG	NOx	CO	SO2	Fugitive PM10	Exhaust PM10	PM10 Total	Fugitive PM2.5	Exhaust PM2.5	PM2.5 Total	Bio- CO2	NBio- CO2	Total CO2	CH4	N2O	CO2e
Category	tons/yr										MT/yr					
Off-Road	0.0866	0.8942	0.4911	1.3700e-003		0.0366	0.0366		0.0343	0.0343	0.0000	124.1346	124.1346	0.0349	0.0000	124.8664
Total	0.0866	0.8942	0.4911	1.3700e-003		0.0366	0.0366		0.0343	0.0343	0.0000	124.1346	124.1346	0.0349	0.0000	124.8664

Unmitigated Construction Off-Site

	ROG	NOx	CO	SO2	Fugitive PM10	Exhaust PM10	PM10 Total	Fugitive PM2.5	Exhaust PM2.5	PM2.5 Total	Bio- CO2	NBio- CO2	Total CO2	CH4	N2O	CO2e
Category	tons/yr										MT/yr					
Hauling	0.0000	0.0000	0.0000	0.0000	0.0000	0.0000	0.0000	0.0000	0.0000	0.0000	0.0000	0.0000	0.0000	0.0000	0.0000	0.0000
Vendor	1.8600e-003	0.0150	0.0235	4.0000e-005	1.2400e-003	2.2000e-004	1.4600e-003	3.5000e-004	2.0000e-004	5.6000e-004	0.0000	3.9607	3.9607	3.0000e-005	0.0000	3.9613
Worker	7.0000e-004	9.3000e-004	8.7000e-003	2.0000e-005	1.9800e-003	1.0000e-005	2.0000e-003	5.3000e-004	1.0000e-005	5.4000e-004	0.0000	1.7079	1.7079	8.0000e-005	0.0000	1.7097

Total	2.5600e-003	0.0159	0.0322	6.0000e-005	3.2200e-003	2.3000e-004	3.4600e-003	8.8000e-004	2.1000e-004	1.1000e-003	0.0000	5.6686	5.6686	1.1000e-004	0.0000	5.6710
--------------	--------------------	---------------	---------------	--------------------	--------------------	--------------------	--------------------	--------------------	--------------------	--------------------	---------------	---------------	---------------	--------------------	---------------	---------------

Mitigated Construction On-Site

	ROG	NOx	CO	SO2	Fugitive PM10	Exhaust PM10	PM10 Total	Fugitive PM2.5	Exhaust PM2.5	PM2.5 Total	Bio- CO2	NBio- CO2	Total CO2	CH4	N2O	CO2e
Category	tons/yr										MT/yr					
Off-Road	0.0866	0.8942	0.4911	1.3700e-003		0.0366	0.0366		0.0343	0.0343	0.0000	124.1344	124.1344	0.0349	0.0000	124.8663
Total	0.0866	0.8942	0.4911	1.3700e-003		0.0366	0.0366		0.0343	0.0343	0.0000	124.1344	124.1344	0.0349	0.0000	124.8663

Mitigated Construction Off-Site

	ROG	NOx	CO	SO2	Fugitive PM10	Exhaust PM10	PM10 Total	Fugitive PM2.5	Exhaust PM2.5	PM2.5 Total	Bio- CO2	NBio- CO2	Total CO2	CH4	N2O	CO2e
Category	tons/yr										MT/yr					
Hauling	0.0000	0.0000	0.0000	0.0000	0.0000	0.0000	0.0000	0.0000	0.0000	0.0000	0.0000	0.0000	0.0000	0.0000	0.0000	0.0000
Vendor	1.8600e-003	0.0150	0.0235	4.0000e-005	1.2400e-003	2.2000e-004	1.4600e-003	3.5000e-004	2.0000e-004	5.6000e-004	0.0000	3.9607	3.9607	3.0000e-005	0.0000	3.9613
Worker	7.0000e-004	9.3000e-004	8.7000e-003	2.0000e-005	1.9800e-003	1.0000e-005	2.0000e-003	5.3000e-004	1.0000e-005	5.4000e-004	0.0000	1.7079	1.7079	8.0000e-005	0.0000	1.7097
Total	2.5600e-003	0.0159	0.0322	6.0000e-005	3.2200e-003	2.3000e-004	3.4600e-003	8.8000e-004	2.1000e-004	1.1000e-003	0.0000	5.6686	5.6686	1.1000e-004	0.0000	5.6710

3.14 Intake 6a - Grading - 2018

Unmitigated Construction On-Site

	ROG	NOx	CO	SO2	Fugitive PM10	Exhaust PM10	PM10 Total	Fugitive PM2.5	Exhaust PM2.5	PM2.5 Total	Bio- CO2	NBio- CO2	Total CO2	CH4	N2O	CO2e
Category	tons/yr										MT/yr					
Fugitive Dust					3.3000e-004	0.0000	3.3000e-004	4.0000e-005	0.0000	4.0000e-005	0.0000	0.0000	0.0000	0.0000	0.0000	0.0000
Off-Road	2.6300e-003	0.0243	0.0136	2.0000e-005		1.3000e-003	1.3000e-003		1.2100e-003	1.2100e-003	0.0000	1.8340	1.8340	4.9000e-004	0.0000	1.8442
Total	2.6300e-003	0.0243	0.0136	2.0000e-005	3.3000e-004	1.3000e-003	1.6300e-003	4.0000e-005	1.2100e-003	1.2500e-003	0.0000	1.8340	1.8340	4.9000e-004	0.0000	1.8442

Unmitigated Construction Off-Site

	ROG	NOx	CO	SO2	Fugitive PM10	Exhaust PM10	PM10 Total	Fugitive PM2.5	Exhaust PM2.5	PM2.5 Total	Bio- CO2	NBio- CO2	Total CO2	CH4	N2O	CO2e
Category	tons/yr										MT/yr					
Hauling	0.0000	0.0000	0.0000	0.0000	0.0000	0.0000	0.0000	0.0000	0.0000	0.0000	0.0000	0.0000	0.0000	0.0000	0.0000	0.0000
Vendor	3.4000e-004	2.7600e-003	4.3300e-003	1.0000e-005	2.3000e-004	4.0000e-005	2.7000e-004	7.0000e-005	4.0000e-005	1.0000e-004	0.0000	0.7296	0.7296	1.0000e-005	0.0000	0.7297
Worker	1.0000e-004	1.3000e-004	1.2300e-003	0.0000	2.8000e-004	0.0000	2.8000e-004	7.0000e-005	0.0000	8.0000e-005	0.0000	0.2420	0.2420	1.0000e-005	0.0000	0.2423
Total	4.4000e-004	2.8900e-003	5.5600e-003	1.0000e-005	5.1000e-004	4.0000e-005	5.5000e-004	1.4000e-004	4.0000e-005	1.8000e-004	0.0000	0.9716	0.9716	2.0000e-005	0.0000	0.9720

Mitigated Construction On-Site

	ROG	NOx	CO	SO2	Fugitive PM10	Exhaust PM10	PM10 Total	Fugitive PM2.5	Exhaust PM2.5	PM2.5 Total	Bio- CO2	NBio- CO2	Total CO2	CH4	N2O	CO2e
Category	tons/yr										MT/yr					

Fugitive Dust					1.3000e-004	0.0000	1.3000e-004	1.0000e-005	0.0000	1.0000e-005	0.0000	0.0000	0.0000	0.0000	0.0000	0.0000
Off-Road	2.6300e-003	0.0243	0.0136	2.0000e-005		1.3000e-003	1.3000e-003		1.2100e-003	1.2100e-003	0.0000	1.8339	1.8339	4.9000e-004	0.0000	1.8442
Total	2.6300e-003	0.0243	0.0136	2.0000e-005	1.3000e-004	1.3000e-003	1.4300e-003	1.0000e-005	1.2100e-003	1.2200e-003	0.0000	1.8339	1.8339	4.9000e-004	0.0000	1.8442

Mitigated Construction Off-Site

	ROG	NOx	CO	SO2	Fugitive PM10	Exhaust PM10	PM10 Total	Fugitive PM2.5	Exhaust PM2.5	PM2.5 Total	Bio- CO2	NBio- CO2	Total CO2	CH4	N2O	CO2e
Category	tons/yr										MT/yr					
Hauling	0.0000	0.0000	0.0000	0.0000	0.0000	0.0000	0.0000	0.0000	0.0000	0.0000	0.0000	0.0000	0.0000	0.0000	0.0000	0.0000
Vendor	3.4000e-004	2.7600e-003	4.3300e-003	1.0000e-005	2.3000e-004	4.0000e-005	2.7000e-004	7.0000e-005	4.0000e-005	1.0000e-004	0.0000	0.7296	0.7296	1.0000e-005	0.0000	0.7297
Worker	1.0000e-004	1.3000e-004	1.2300e-003	0.0000	2.8000e-004	0.0000	2.8000e-004	7.0000e-005	0.0000	8.0000e-005	0.0000	0.2420	0.2420	1.0000e-005	0.0000	0.2423
Total	4.4000e-004	2.8900e-003	5.5600e-003	1.0000e-005	5.1000e-004	4.0000e-005	5.5000e-004	1.4000e-004	4.0000e-005	1.8000e-004	0.0000	0.9716	0.9716	2.0000e-005	0.0000	0.9720

3.15 Axial 5 - Architectural Coatings - 2018

Unmitigated Construction On-Site

	ROG	NOx	CO	SO2	Fugitive PM10	Exhaust PM10	PM10 Total	Fugitive PM2.5	Exhaust PM2.5	PM2.5 Total	Bio- CO2	NBio- CO2	Total CO2	CH4	N2O	CO2e
Category	tons/yr										MT/yr					
Archit. Coating	2.0900e-003					0.0000	0.0000		0.0000	0.0000	0.0000	0.0000	0.0000	0.0000	0.0000	0.0000
Off-Road	4.8300e-003	0.0371	0.0389	6.0000e-005		2.4200e-003	2.4200e-003		2.4000e-003	2.4000e-003	0.0000	5.3943	5.3943	8.7000e-004	0.0000	5.4125
Total	6.9200e-003	0.0371	0.0389	6.0000e-005		2.4200e-003	2.4200e-003		2.4000e-003	2.4000e-003	0.0000	5.3943	5.3943	8.7000e-004	0.0000	5.4125

Unmitigated Construction Off-Site

	ROG	NOx	CO	SO2	Fugitive PM10	Exhaust PM10	PM10 Total	Fugitive PM2.5	Exhaust PM2.5	PM2.5 Total	Bio- CO2	NBio- CO2	Total CO2	CH4	N2O	CO2e
Category	tons/yr										MT/yr					
Hauling	0.0000	0.0000	0.0000	0.0000	0.0000	0.0000	0.0000	0.0000	0.0000	0.0000	0.0000	0.0000	0.0000	0.0000	0.0000	0.0000
Vendor	4.3000e-004	3.4700e-003	5.4400e-003	1.0000e-005	2.9000e-004	5.0000e-005	3.4000e-004	8.0000e-005	5.0000e-005	1.3000e-004	0.0000	0.9172	0.9172	1.0000e-005	0.0000	0.9174
Worker	1.2000e-004	1.7000e-004	1.5500e-003	0.0000	3.5000e-004	0.0000	3.6000e-004	9.0000e-005	0.0000	1.0000e-004	0.0000	0.3042	0.3042	1.0000e-005	0.0000	0.3046
Total	5.5000e-004	3.6400e-003	6.9900e-003	1.0000e-005	6.4000e-004	5.0000e-005	7.0000e-004	1.7000e-004	5.0000e-005	2.3000e-004	0.0000	1.2215	1.2215	2.0000e-005	0.0000	1.2219

Mitigated Construction On-Site

	ROG	NOx	CO	SO2	Fugitive PM10	Exhaust PM10	PM10 Total	Fugitive PM2.5	Exhaust PM2.5	PM2.5 Total	Bio- CO2	NBio- CO2	Total CO2	CH4	N2O	CO2e
Category	tons/yr										MT/yr					
Archit. Coating	2.0900e-003					0.0000	0.0000		0.0000	0.0000	0.0000	0.0000	0.0000	0.0000	0.0000	0.0000
Off-Road	4.8300e-003	0.0371	0.0389	6.0000e-005		2.4200e-003	2.4200e-003		2.4000e-003	2.4000e-003	0.0000	5.3943	5.3943	8.7000e-004	0.0000	5.4125
Total	6.9200e-003	0.0371	0.0389	6.0000e-005		2.4200e-003	2.4200e-003		2.4000e-003	2.4000e-003	0.0000	5.3943	5.3943	8.7000e-004	0.0000	5.4125

Mitigated Construction Off-Site

	ROG	NOx	CO	SO2	Fugitive PM10	Exhaust PM10	PM10 Total	Fugitive PM2.5	Exhaust PM2.5	PM2.5 Total	Bio- CO2	NBio- CO2	Total CO2	CH4	N2O	CO2e
--	-----	-----	----	-----	---------------	--------------	------------	----------------	---------------	-------------	----------	-----------	-----------	-----	-----	------

Category	tons/yr										MT/yr					
	Hauling	0.0000	0.0000	0.0000	0.0000	0.0000	0.0000	0.0000	0.0000	0.0000	0.0000	0.0000	0.0000	0.0000	0.0000	0.0000
Vendor	4.3000e-004	3.4700e-003	5.4400e-003	1.0000e-005	2.9000e-004	5.0000e-005	3.4000e-004	8.0000e-005	5.0000e-005	1.3000e-004	0.0000	0.9172	0.9172	1.0000e-005	0.0000	0.9174
Worker	1.2000e-004	1.7000e-004	1.5500e-003	0.0000	3.5000e-004	0.0000	3.6000e-004	9.0000e-005	0.0000	1.0000e-004	0.0000	0.3042	0.3042	1.0000e-005	0.0000	0.3046
Total	5.5000e-004	3.6400e-003	6.9900e-003	1.0000e-005	6.4000e-004	5.0000e-005	7.0000e-004	1.7000e-004	5.0000e-005	2.3000e-004	0.0000	1.2215	1.2215	2.0000e-005	0.0000	1.2219

3.16 Intake 6b - Paving - 2018

Unmitigated Construction On-Site

Category	ROG	NOx	CO	SO2	Fugitive PM10	Exhaust PM10	PM10 Total	Fugitive PM2.5	Exhaust PM2.5	PM2.5 Total	Bio- CO2	NBio- CO2	Total CO2	CH4	N2O	CO2e
	tons/yr										MT/yr					
Off-Road	1.7100e-003	0.0179	0.0143	2.0000e-005		1.0200e-003	1.0200e-003		9.4000e-004	9.4000e-004	0.0000	1.9564	1.9564	6.1000e-004	0.0000	1.9692
Paving	0.0000					0.0000	0.0000		0.0000	0.0000	0.0000	0.0000	0.0000	0.0000	0.0000	0.0000
Total	1.7100e-003	0.0179	0.0143	2.0000e-005		1.0200e-003	1.0200e-003		9.4000e-004	9.4000e-004	0.0000	1.9564	1.9564	6.1000e-004	0.0000	1.9692

Unmitigated Construction Off-Site

Category	ROG	NOx	CO	SO2	Fugitive PM10	Exhaust PM10	PM10 Total	Fugitive PM2.5	Exhaust PM2.5	PM2.5 Total	Bio- CO2	NBio- CO2	Total CO2	CH4	N2O	CO2e
	tons/yr										MT/yr					
Hauling	0.0000	0.0000	0.0000	0.0000	0.0000	0.0000	0.0000	0.0000	0.0000	0.0000	0.0000	0.0000	0.0000	0.0000	0.0000	0.0000
Vendor	4.1000e-004	3.3100e-003	5.1900e-003	1.0000e-005	2.7000e-004	5.0000e-005	3.2000e-004	8.0000e-005	4.0000e-005	1.2000e-004	0.0000	0.8755	0.8755	1.0000e-005	0.0000	0.8757
Worker	1.2000e-004	1.6000e-004	1.4800e-003	0.0000	3.4000e-004	0.0000	3.4000e-004	9.0000e-005	0.0000	9.0000e-005	0.0000	0.2904	0.2904	1.0000e-005	0.0000	0.2907

Total	5.3000e-004	3.4700e-003	6.6700e-003	1.0000e-005	6.1000e-004	5.0000e-005	6.6000e-004	1.7000e-004	4.0000e-005	2.1000e-004	0.0000	1.1659	1.1659	2.0000e-005	0.0000	1.1664
--------------	--------------------	--------------------	--------------------	--------------------	--------------------	--------------------	--------------------	--------------------	--------------------	--------------------	---------------	---------------	---------------	--------------------	---------------	---------------

Mitigated Construction On-Site

	ROG	NOx	CO	SO2	Fugitive PM10	Exhaust PM10	PM10 Total	Fugitive PM2.5	Exhaust PM2.5	PM2.5 Total	Bio- CO2	NBio- CO2	Total CO2	CH4	N2O	CO2e
Category	tons/yr										MT/yr					
Off-Road	1.7100e-003	0.0179	0.0143	2.0000e-005		1.0200e-003	1.0200e-003		9.4000e-004	9.4000e-004	0.0000	1.9564	1.9564	6.1000e-004	0.0000	1.9692
Paving	0.0000					0.0000	0.0000		0.0000	0.0000	0.0000	0.0000	0.0000	0.0000	0.0000	0.0000
Total	1.7100e-003	0.0179	0.0143	2.0000e-005		1.0200e-003	1.0200e-003		9.4000e-004	9.4000e-004	0.0000	1.9564	1.9564	6.1000e-004	0.0000	1.9692

Mitigated Construction Off-Site

	ROG	NOx	CO	SO2	Fugitive PM10	Exhaust PM10	PM10 Total	Fugitive PM2.5	Exhaust PM2.5	PM2.5 Total	Bio- CO2	NBio- CO2	Total CO2	CH4	N2O	CO2e
Category	tons/yr										MT/yr					
Hauling	0.0000	0.0000	0.0000	0.0000	0.0000	0.0000	0.0000	0.0000	0.0000	0.0000	0.0000	0.0000	0.0000	0.0000	0.0000	0.0000
Vendor	4.1000e-004	3.3100e-003	5.1900e-003	1.0000e-005	2.7000e-004	5.0000e-005	3.2000e-004	8.0000e-005	4.0000e-005	1.2000e-004	0.0000	0.8755	0.8755	1.0000e-005	0.0000	0.8757
Worker	1.2000e-004	1.6000e-004	1.4800e-003	0.0000	3.4000e-004	0.0000	3.4000e-004	9.0000e-005	0.0000	9.0000e-005	0.0000	0.2904	0.2904	1.0000e-005	0.0000	0.2907
Total	5.3000e-004	3.4700e-003	6.6700e-003	1.0000e-005	6.1000e-004	5.0000e-005	6.6000e-004	1.7000e-004	4.0000e-005	2.1000e-004	0.0000	1.1659	1.1659	2.0000e-005	0.0000	1.1664

Carlsbad Desal Plant Intake Modifications San Diego County, Summer

1.0 Project Characteristics

1.1 Land Usage

Land Uses	Size	Metric	Lot Acreage	Floor Surface Area	Population
User Defined Industrial	1.00	User Defined Unit	2.00	300.00	0

1.2 Other Project Characteristics

Urbanization	Urban	Wind Speed (m/s)	2.6	Precipitation Freq (Days)	40
Climate Zone	13			Operational Year	2018
Utility Company	San Diego Gas & Electric				
CO2 Intensity (lb/MWhr)	720.49	CH4 Intensity (lb/MWhr)	0.029	N2O Intensity (lb/MWhr)	0.006

1.3 User Entered Comments & Non-Default Data

Construction Phase - construction schedule per applicant

Off-road Equipment - Off-road Equipment - 9 off HW trucks = concrete and pump trucks

Off-road Equipment - all off-road equipment provided by project applicant

Grading - grading acreages per applicant

Demolition - demolition quantities per applicant

Trips and VMT - trips per applicant

Architectural coatings per SDACPD Rule 67.0.1

Construction Off-road Equipment Mitigation - water 3x per day

Table Name	Column Name	Default Value	New Value
tblArchitecturalCoating	EF_Nonresidential_Exterior	250.00	150.00

tblArchitecturalCoating	EF_Nonresidential_Interior	250.00	150.00
tblArchitecturalCoating	EF_Residential_Exterior	250.00	150.00
tblArchitecturalCoating	EF_Residential_Interior	250.00	150.00
tblConstructionPhase	NumDays	10.00	11.00
tblConstructionPhase	NumDays	200.00	20.00
tblConstructionPhase	NumDays	200.00	108.00
tblConstructionPhase	NumDays	200.00	60.00
tblConstructionPhase	NumDays	200.00	40.00
tblConstructionPhase	NumDays	20.00	6.00
tblConstructionPhase	NumDays	20.00	79.00
tblConstructionPhase	NumDays	4.00	5.00
tblConstructionPhase	NumDays	4.00	71.00
tblConstructionPhase	NumDays	10.00	20.00
tblConstructionPhase	NumDays	10.00	6.00
tblConstructionPhase	NumDays	10.00	11.00
tblConstructionPhase	NumDays	2.00	5.00
tblConstructionPhase	NumDays	2.00	30.00
tblConstructionPhase	PhaseEndDate	2/16/2018	2/9/2018
tblConstructionPhase	PhaseEndDate	2/22/2018	1/25/2018
tblConstructionPhase	PhaseEndDate	2/8/2018	11/2/2017
tblConstructionPhase	PhaseEndDate	12/27/2017	12/14/2017
tblConstructionPhase	PhaseEndDate	6/2/2017	6/3/2017
tblConstructionPhase	PhaseEndDate	2/19/2018	2/9/2018
tblConstructionPhase	PhaseEndDate	9/11/2017	9/7/2017
tblConstructionPhase	PhaseEndDate	9/16/2016	9/18/2016
tblConstructionPhase	PhaseEndDate	2/8/2018	1/25/2018
tblConstructionPhase	PhaseStartDate	2/2/2018	1/26/2018
tblConstructionPhase	PhaseStartDate	1/26/2018	12/29/2017
tblConstructionPhase	PhaseStartDate	12/15/2017	9/8/2017
tblConstructionPhase	PhaseStartDate	9/8/2017	8/26/2017

tblConstructionPhase	PhaseStartDate	2/10/2018	2/2/2018
tblConstructionPhase	PhaseStartDate	8/26/2017	8/24/2017
tblConstructionPhase	PhaseStartDate	12/29/2017	12/15/2017
tblGrading	AcresOfGrading	2.50	0.62
tblGrading	AcresOfGrading	0.00	1.00
tblGrading	AcresOfGrading	0.00	0.16
tblGrading	MaterialExported	0.00	9,700.00
tblGrading	MaterialImported	0.00	27.00
tblLandUse	LandUseSquareFeet	0.00	300.00
tblLandUse	LotAcreage	0.00	2.00
tblOffRoadEquipment	HorsePower	400.00	300.00
tblOffRoadEquipment	HorsePower	400.00	300.00
tblOffRoadEquipment	HorsePower	162.00	300.00
tblOffRoadEquipment	HorsePower	400.00	167.00
tblOffRoadEquipment	HorsePower	400.00	200.00
tblOffRoadEquipment	HorsePower	162.00	300.00
tblOffRoadEquipment	HorsePower	9.00	300.00
tblOffRoadEquipment	LoadFactor	0.36	0.36
tblOffRoadEquipment	LoadFactor	0.40	0.40
tblOffRoadEquipment	LoadFactor	0.38	0.38
tblOffRoadEquipment	LoadFactor	0.38	0.38
tblOffRoadEquipment	LoadFactor	0.50	0.50
tblOffRoadEquipment	LoadFactor	0.29	0.29
tblOffRoadEquipment	LoadFactor	0.36	0.36
tblOffRoadEquipment	LoadFactor	0.38	0.38
tblOffRoadEquipment	LoadFactor	0.38	0.38
tblOffRoadEquipment	LoadFactor	0.38	0.38
tblOffRoadEquipment	LoadFactor	0.31	0.31
tblOffRoadEquipment	LoadFactor	0.38	0.38
tblOffRoadEquipment	LoadFactor	0.38	0.38

tblOffRoadEquipment	LoadFactor	0.38	0.38
tblOffRoadEquipment	LoadFactor	0.29	0.29
tblOffRoadEquipment	LoadFactor	0.31	0.31
tblOffRoadEquipment	LoadFactor	0.38	0.38
tblOffRoadEquipment	LoadFactor	0.38	0.38
tblOffRoadEquipment	LoadFactor	0.38	0.38
tblOffRoadEquipment	LoadFactor	0.50	0.50
tblOffRoadEquipment	LoadFactor	0.36	0.36
tblOffRoadEquipment	LoadFactor	0.38	0.38
tblOffRoadEquipment	LoadFactor	0.38	0.38
tblOffRoadEquipment	LoadFactor	0.31	0.31
tblOffRoadEquipment	OffRoadEquipmentType		Rubber Tired Loaders
tblOffRoadEquipment	OffRoadEquipmentType		Rubber Tired Dozers
tblOffRoadEquipment	OffRoadEquipmentType		Excavators
tblOffRoadEquipment	OffRoadEquipmentType		Off-Highway Trucks
tblOffRoadEquipment	OffRoadEquipmentType		Bore/Drill Rigs
tblOffRoadEquipment	OffRoadEquipmentType		Pumps
tblOffRoadEquipment	OffRoadEquipmentType		Cranes
tblOffRoadEquipment	OffRoadEquipmentType		Rubber Tired Loaders
tblOffRoadEquipment	OffRoadEquipmentType		Pumps
tblOffRoadEquipment	OffRoadEquipmentType		Off-Highway Trucks
tblOffRoadEquipment	OffRoadEquipmentType		Excavators
tblOffRoadEquipment	OffRoadEquipmentType		Excavators
tblOffRoadEquipment	OffRoadEquipmentType		Aerial Lifts
tblOffRoadEquipment	OffRoadEquipmentType		Off-Highway Trucks
tblOffRoadEquipment	OffRoadEquipmentType		Pumps
tblOffRoadEquipment	OffRoadEquipmentType		Off-Highway Trucks
tblOffRoadEquipment	OffRoadEquipmentType		Off-Highway Trucks
tblOffRoadEquipment	OffRoadEquipmentType		Cranes
tblOffRoadEquipment	OffRoadEquipmentType		Pumps

tblOffRoadEquipment	OffRoadEquipmentType		Aerial Lifts
tblOffRoadEquipment	OffRoadEquipmentType		Pumps
tblOffRoadEquipment	OffRoadEquipmentType		Excavators
tblOffRoadEquipment	OffRoadEquipmentType		Off-Highway Trucks
tblOffRoadEquipment	OffRoadEquipmentType		Cement and Mortar Mixers
tblOffRoadEquipment	OffRoadEquipmentType		Excavators
tblOffRoadEquipment	OffRoadEquipmentType		Bore/Drill Rigs
tblOffRoadEquipment	OffRoadEquipmentType		Rubber Tired Loaders
tblOffRoadEquipment	OffRoadEquipmentType		Rollers
tblOffRoadEquipment	OffRoadEquipmentType		Pumps
tblOffRoadEquipment	OffRoadEquipmentType		Off-Highway Trucks
tblOffRoadEquipment	OffRoadEquipmentType		Pumps
tblOffRoadEquipment	OffRoadEquipmentType		Dumpers/Tenders
tblOffRoadEquipment	OffRoadEquipmentType		Aerial Lifts
tblOffRoadEquipment	OffRoadEquipmentUnitAmount	1.00	2.00
tblOffRoadEquipment	OffRoadEquipmentUnitAmount	1.00	0.00
tblOffRoadEquipment	OffRoadEquipmentUnitAmount	1.00	0.00
tblOffRoadEquipment	OffRoadEquipmentUnitAmount	1.00	0.00
tblOffRoadEquipment	OffRoadEquipmentUnitAmount	1.00	0.00
tblOffRoadEquipment	OffRoadEquipmentUnitAmount	1.00	2.00
tblOffRoadEquipment	OffRoadEquipmentUnitAmount	1.00	2.00
tblOffRoadEquipment	OffRoadEquipmentUnitAmount	2.00	0.00
tblOffRoadEquipment	OffRoadEquipmentUnitAmount	2.00	0.00
tblOffRoadEquipment	OffRoadEquipmentUnitAmount	2.00	0.00
tblOffRoadEquipment	OffRoadEquipmentUnitAmount	2.00	0.00
tblOffRoadEquipment	OffRoadEquipmentUnitAmount	1.00	0.00
tblOffRoadEquipment	OffRoadEquipmentUnitAmount	1.00	0.00
tblOffRoadEquipment	OffRoadEquipmentUnitAmount	1.00	0.00
tblOffRoadEquipment	OffRoadEquipmentUnitAmount	1.00	0.00
tblOffRoadEquipment	OffRoadEquipmentUnitAmount	1.00	0.00

tblOffRoadEquipment	OffRoadEquipmentUnitAmount	3.00	0.00
tblOffRoadEquipment	UsageHours	6.00	8.00
tblOffRoadEquipment	UsageHours	7.00	8.00
tblProjectCharacteristics	OperationalYear	2014	2018
tblTripsAndVMT	HaulingTripNumber	3.00	25.00
tblTripsAndVMT	HaulingTripNumber	9.00	25.00
tblTripsAndVMT	HaulingTripNumber	0.00	606.00
tblTripsAndVMT	HaulingTripNumber	1,213.00	606.00
tblTripsAndVMT	HaulingTripNumber	0.00	114.00
tblTripsAndVMT	HaulingTripNumber	7.00	22.00
tblTripsAndVMT	VendorTripNumber	0.00	4.00
tblTripsAndVMT	VendorTripNumber	0.00	16.00
tblTripsAndVMT	VendorTripNumber	0.00	4.00
tblTripsAndVMT	VendorTripNumber	0.00	20.00
tblTripsAndVMT	VendorTripNumber	0.00	14.00
tblTripsAndVMT	VendorTripNumber	0.00	8.00
tblTripsAndVMT	VendorTripNumber	0.00	14.00
tblTripsAndVMT	VendorTripNumber	0.00	4.00
tblTripsAndVMT	VendorTripNumber	0.00	20.00
tblTripsAndVMT	VendorTripNumber	0.00	20.00
tblTripsAndVMT	VendorTripNumber	0.00	14.00
tblTripsAndVMT	VendorTripNumber	0.00	18.00
tblTripsAndVMT	VendorTripNumber	0.00	4.00
tblTripsAndVMT	VendorTripNumber	0.00	20.00
tblTripsAndVMT	WorkerTripNumber	5.00	14.00
tblTripsAndVMT	WorkerTripNumber	5.00	14.00
tblTripsAndVMT	WorkerTripNumber	30.00	26.00
tblTripsAndVMT	WorkerTripNumber	0.00	26.00
tblTripsAndVMT	WorkerTripNumber	10.00	14.00
tblTripsAndVMT	WorkerTripNumber	0.00	8.00

tblTripsAndVMT	WorkerTripNumber	5.00	14.00
tblTripsAndVMT	WorkerTripNumber	8.00	14.00
tblTripsAndVMT	WorkerTripNumber	0.00	28.00
tblTripsAndVMT	WorkerTripNumber	23.00	28.00
tblTripsAndVMT	WorkerTripNumber	0.00	26.00
tblTripsAndVMT	WorkerTripNumber	5.00	12.00
tblTripsAndVMT	WorkerTripNumber	38.00	22.00
tblTripsAndVMT	WorkerTripNumber	0.00	16.00

2.0 Emissions Summary

2.1 Overall Construction (Maximum Daily Emission)

Unmitigated Construction

	ROG	NOx	CO	SO2	Fugitive PM10	Exhaust PM10	PM10 Total	Fugitive PM2.5	Exhaust PM2.5	PM2.5 Total	Bio- CO2	NBio- CO2	Total CO2	CH4	N2O	CO2e
Year	lb/day										lb/day					
2016	3.8424	37.3874	23.2886	0.0548	6.2855	1.8175	7.1705	3.3759	1.7576	4.1902	0.0000	5,423.1628	5,423.1628	0.9270	0.0000	5,442.6289
2017	17.0831	179.2743	97.8669	0.2438	0.5918	7.6158	8.2023	0.1588	7.1575	7.3163	0.0000	24,490.4529	24,490.4529	6.4004	0.0000	24,624.8604
2018	15.0754	153.6921	90.6727	0.2438	0.5865	6.4141	7.0005	0.1588	6.0336	6.1923	0.0000	24,148.2721	24,148.2721	6.3580	0.0000	24,281.7903
Total	36.0009	370.3538	211.8282	0.5424	7.4637	15.8473	22.3733	3.6935	14.9486	17.6988	0.0000	54,061.8878	54,061.8878	13.6853	0.0000	54,349.2796

Mitigated Construction

	ROG	NOx	CO	SO2	Fugitive PM10	Exhaust PM10	PM10 Total	Fugitive PM2.5	Exhaust PM2.5	PM2.5 Total	Bio- CO2	NBio- CO2	Total CO2	CH4	N2O	CO2e
--	-----	-----	----	-----	---------------	--------------	------------	----------------	---------------	-------------	----------	-----------	-----------	-----	-----	------

Year	lb/day										lb/day					
2016	3.8424	37.3874	23.2886	0.0548	2.5908	1.8175	3.4759	1.3544	1.7576	2.1687	0.0000	5,423.1628	5,423.1628	0.9270	0.0000	5,442.6289
2017	17.0831	179.2743	97.8669	0.2438	0.5918	7.6158	8.2023	0.1588	7.1575	7.3163	0.0000	24,490.4529	24,490.4529	6.4004	0.0000	24,624.8604
2018	15.0754	153.6921	90.6727	0.2438	0.5865	6.4141	7.0005	0.1588	6.0336	6.1923	0.0000	24,148.2721	24,148.2721	6.3580	0.0000	24,281.7903
Total	36.0009	370.3538	211.8282	0.5424	3.7691	15.8473	18.6787	1.6719	14.9486	15.6773	0.0000	54,061.8878	54,061.8878	13.6853	0.0000	54,349.2796

	ROG	NOx	CO	SO2	Fugitive PM10	Exhaust PM10	PM10 Total	Fugitive PM2.5	Exhaust PM2.5	PM2.5 Total	Bio- CO2	NBio-CO2	Total CO2	CH4	N2O	CO2e
Percent Reduction	0.00	0.00	0.00	0.00	49.50	0.00	16.51	54.73	0.00	11.42	0.00	0.00	0.00	0.00	0.00	0.00

3.0 Construction Detail

Construction Phase

Phase Number	Phase Name	Phase Type	Start Date	End Date	Num Days Week	Num Days	Phase Description
1	Intake 1a - Site Prep	Site Preparation	9/12/2016	9/18/2016	5	5	
2	Intake 1b - Asphalt Removal	Demolition	9/19/2016	9/26/2016	5	6	
3	Intake 2a - Sheet Piling	Building Construction	9/27/2016	2/23/2017	5	108	
4	Intake 2b - Excavation	Grading	2/24/2017	6/3/2017	5	71	
5	Intake 3 - Building Construction	Building Construction	6/4/2017	8/25/2017	5	60	
6	Axial 1 - Paving	Paving	8/24/2017	9/7/2017	5	11	
7	Intake 4 - Demolition	Demolition	8/26/2017	12/14/2017	5	79	
8	Axial 2 - Pump Station Install	Building Construction	9/8/2017	11/2/2017	5	40	
9	Axial 3a - Trenching	Trenching	11/3/2017	11/30/2017	5	20	
10	Axial 3b - Paving	Paving	12/1/2017	12/28/2017	5	20	
11	Intake 5 - Backfill	Site Preparation	12/15/2017	1/25/2018	5	30	
12	Axial 4 - Building Construction	Building Construction	12/29/2017	1/25/2018	5	20	
13	Intake 6a - Grading	Grading	1/26/2018	2/1/2018	5	5	

14	Axial 5 - Architectural Coatings	Architectural Coating	1/26/2018	2/9/2018	5	11
15	Intake 6b - Paving	Paving	2/2/2018	2/9/2018	5	6

Acres of Grading (Site Preparation Phase): 0

Acres of Grading (Grading Phase): 0

Acres of Paving: 0

Residential Indoor: 0; Residential Outdoor: 0; Non-Residential Indoor: 450; Non-Residential Outdoor: 150 (Architectural Coating – sqft)

OffRoad Equipment

Phase Name	Offroad Equipment Type	Amount	Usage Hours	Horse Power	Load Factor
Intake 2a - Sheet Piling	Cranes	1	8.00	226	0.29
Intake 2b - Excavation	Tractors/Loaders/Backhoes	1	8.00	97	0.37
Intake 3 - Building Construction	Cranes	2	8.00	226	0.29
Axial 1 - Paving	Pavers	1	8.00	125	0.42
Axial 1 - Paving	Rollers	1	8.00	80	0.38
Intake 4 - Demolition	Concrete/Industrial Saws	1	8.00	81	0.73
Axial 2 - Pump Station Install	Cranes	2	8.00	226	0.29
Axial 3b - Paving	Pavers	1	8.00	125	0.42
Axial 3b - Paving	Rollers	1	8.00	80	0.38
Axial 4 - Building Construction	Cranes	1	8.00	226	0.29
Intake 6a - Grading	Graders	1	8.00	174	0.41
Axial 5 - Architectural Coatings	Air Compressors	2	8.00	78	0.48
Intake 6b - Paving	Pavers	1	8.00	125	0.42
Intake 6b - Paving	Rollers	1	8.00	80	0.38
Intake 1a - Site Prep	Rubber Tired Loaders	1	8.00	199	0.36
Intake 1a - Site Prep	Rubber Tired Dozers	1	8.00	255	0.40
Intake 1b - Asphalt Removal	Excavators	1	8.00	162	0.38
Intake 1b - Asphalt Removal	Off-Highway Trucks	2	8.00	300	0.38
Intake 2a - Sheet Piling	Bore/Drill Rigs	2	8.00	205	0.50
Intake 2a - Sheet Piling	Pumps	3	8.00	84	0.74

Intake 2b - Excavation	Cranes	1	8.00	226	0.29
Intake 2b - Excavation	Rubber Tired Loaders	1	8.00	199	0.36
Intake 2b - Excavation	Pumps	3	8.00	84	0.74
Intake 2b - Excavation	Off-Highway Trucks	2	8.00	300	0.38
Intake 2b - Excavation	Excavators	1	8.00	300	0.38
Intake 3 - Building Construction	Excavators	1	8.00	162	0.38
Intake 3 - Building Construction	Aerial Lifts	2	8.00	62	0.31
Intake 3 - Building Construction	Off-Highway Trucks	9	8.00	167	0.38
Intake 3 - Building Construction	Pumps	3	8.00	84	0.74
Intake 4 - Demolition	Off-Highway Trucks	1	8.00	200	0.38
Intake 4 - Demolition	Off-Highway Trucks	9	8.00	400	0.38
Intake 4 - Demolition	Cranes	1	8.00	226	0.29
Intake 4 - Demolition	Pumps	3	8.00	84	0.74
Axial 2 - Pump Station Install	Aerial Lifts	2	8.00	62	0.31
Axial 2 - Pump Station Install	Pumps	3	8.00	84	0.74
Axial 3a - Trenching	Excavators	1	8.00	300	0.38
Intake 5 - Backfill	Off-Highway Trucks	3	8.00	400	0.38
Intake 5 - Backfill	Cement and Mortar Mixers	1	8.00	300	0.56
Intake 5 - Backfill	Excavators	1	8.00	162	0.38
Intake 5 - Backfill	Bore/Drill Rigs	1	8.00	205	0.50
Intake 5 - Backfill	Rubber Tired Loaders	2	8.00	199	0.36
Intake 5 - Backfill	Rollers	1	8.00	80	0.38
Intake 5 - Backfill	Pumps	3	8.00	84	0.74
Axial 4 - Building Construction	Off-Highway Trucks	9	8.00	400	0.38
Axial 4 - Building Construction	Pumps	3	8.00	84	0.74
Intake 6a - Grading	Dumpers/Tenders	3	8.00	16	0.38
Axial 5 - Architectural Coatings	Aerial Lifts	2	8.00	62	0.31

Trips and VMT

Phase Name	Offroad Equipment Count	Worker Trip Number	Vendor Trip Number	Hauling Trip Number	Worker Trip Length	Vendor Trip Length	Hauling Trip Length	Worker Vehicle Class	Vendor Vehicle Class	Hauling Vehicle Class
Intake 1a - Site Prep	2	14.00	4.00	25.00	10.80	7.30	20.00	LD_Mix	HDT_Mix	HHDT
Intake 1b - Asphalt Removal	3	14.00	4.00	25.00	10.80	7.30	20.00	LD_Mix	HDT_Mix	HHDT
Intake 2a - Sheet Piling	6	28.00	20.00	606.00	10.80	7.30	20.00	LD_Mix	HDT_Mix	HHDT
Intake 2b - Excavation	9	28.00	20.00	606.00	10.80	7.30	20.00	LD_Mix	HDT_Mix	HHDT
Intake 3 - Building Construction	17	26.00	14.00	114.00	10.80	7.30	20.00	LD_Mix	HDT_Mix	HHDT
Axial 1 - Paving	2	12.00	18.00	0.00	10.80	7.30	20.00	LD_Mix	HDT_Mix	HHDT
Intake 4 - Demolition	15	22.00	4.00	22.00	10.80	7.30	20.00	LD_Mix	HDT_Mix	HHDT
Axial 2 - Pump Station Install	7	16.00	20.00	0.00	10.80	7.30	20.00	LD_Mix	HDT_Mix	HHDT
Axial 3a - Trenching	1	3.00	0.00	0.00	10.80	7.30	20.00	LD_Mix	HDT_Mix	HHDT
Axial 3b - Paving	2	14.00	16.00	0.00	10.80	7.30	20.00	LD_Mix	HDT_Mix	HHDT
Intake 5 - Backfill	12	26.00	4.00	0.00	10.80	7.30	20.00	LD_Mix	HDT_Mix	HHDT
Axial 4 - Building Construction	13	26.00	20.00	0.00	10.80	7.30	20.00	LD_Mix	HDT_Mix	HHDT
Intake 6a - Grading	4	14.00	14.00	0.00	10.80	7.30	20.00	LD_Mix	HDT_Mix	HHDT
Axial 5 - Architectural Coatings	4	8.00	8.00	0.00	10.80	7.30	20.00	LD_Mix	HDT_Mix	HHDT
Intake 6b - Paving	2	14.00	14.00	0.00	10.80	7.30	20.00	LD_Mix	HDT_Mix	HHDT

3.1 Mitigation Measures Construction

Water Exposed Area

3.2 Intake 1a - Site Prep - 2016

Unmitigated Construction On-Site

	ROG	NOx	CO	SO2	Fugitive PM10	Exhaust PM10	PM10 Total	Fugitive PM2.5	Exhaust PM2.5	PM2.5 Total	Bio- CO2	NBio- CO2	Total CO2	CH4	N2O	CO2e
Category	lb/day										lb/day					
Fugitive Dust					6.0568	0.0000	6.0568	3.3140	0.0000	3.3140			0.0000			0.0000
Off-Road	1.7231	20.2030	12.2057	0.0149		0.8593	0.8593		0.7906	0.7906		1,552.1374	1,552.1374	0.4682		1,561.9692

Total	1.7231	20.2030	12.2057	0.0149	6.0568	0.8593	6.9161	3.3140	0.7906	4.1046		1,552.1374	1,552.1374	0.4682		1,561.9692
--------------	---------------	----------------	----------------	---------------	---------------	---------------	---------------	---------------	---------------	---------------	--	-------------------	-------------------	---------------	--	-------------------

Unmitigated Construction Off-Site

	ROG	NOx	CO	SO2	Fugitive PM10	Exhaust PM10	PM10 Total	Fugitive PM2.5	Exhaust PM2.5	PM2.5 Total	Bio- CO2	NBio- CO2	Total CO2	CH4	N2O	CO2e
Category	lb/day										lb/day					
Hauling	0.0980	1.4012	1.0002	3.7400e-003	0.0871	0.0191	0.1063	0.0239	0.0176	0.0415		376.8387	376.8387	2.6800e-003		376.8950
Vendor	0.0417	0.3791	0.4450	9.5000e-004	0.0266	5.7300e-003	0.0323	7.5700e-003	5.2700e-003	0.0129		95.4354	95.4354	7.4000e-004		95.4509
Worker	0.0489	0.0574	0.6263	1.4600e-003	0.1150	8.6000e-004	0.1159	0.0305	7.9000e-004	0.0313		121.5945	121.5945	6.0900e-003		121.7224
Total	0.1887	1.8377	2.0715	6.1500e-003	0.2287	0.0257	0.2544	0.0619	0.0237	0.0856		593.8685	593.8685	9.5100e-003		594.0683

Mitigated Construction On-Site

	ROG	NOx	CO	SO2	Fugitive PM10	Exhaust PM10	PM10 Total	Fugitive PM2.5	Exhaust PM2.5	PM2.5 Total	Bio- CO2	NBio- CO2	Total CO2	CH4	N2O	CO2e
Category	lb/day										lb/day					
Fugitive Dust					2.3621	0.0000	2.3621	1.2925	0.0000	1.2925			0.0000			0.0000
Off-Road	1.7231	20.2030	12.2057	0.0149		0.8593	0.8593		0.7906	0.7906	0.0000	1,552.1374	1,552.1374	0.4682		1,561.9692
Total	1.7231	20.2030	12.2057	0.0149	2.3621	0.8593	3.2215	1.2925	0.7906	2.0831	0.0000	1,552.1374	1,552.1374	0.4682		1,561.9692

Mitigated Construction Off-Site

	ROG	NOx	CO	SO2	Fugitive PM10	Exhaust PM10	PM10 Total	Fugitive PM2.5	Exhaust PM2.5	PM2.5 Total	Bio- CO2	NBio- CO2	Total CO2	CH4	N2O	CO2e
Category	lb/day										lb/day					
Hauling	0.0980	1.4012	1.0002	3.7400e-003	0.0871	0.0191	0.1063	0.0239	0.0176	0.0415		376.8387	376.8387	2.6800e-003		376.8950
Vendor	0.0417	0.3791	0.4450	9.5000e-004	0.0266	5.7300e-003	0.0323	7.5700e-003	5.2700e-003	0.0129		95.4354	95.4354	7.4000e-004		95.4509
Worker	0.0489	0.0574	0.6263	1.4600e-003	0.1150	8.6000e-004	0.1159	0.0305	7.9000e-004	0.0313		121.5945	121.5945	6.0900e-003		121.7224
Total	0.1887	1.8377	2.0715	6.1500e-003	0.2287	0.0257	0.2544	0.0619	0.0237	0.0856		593.8685	593.8685	9.5100e-003		594.0683

3.3 Intake 1b - Asphalt Removal - 2016

Unmitigated Construction On-Site

	ROG	NOx	CO	SO2	Fugitive PM10	Exhaust PM10	PM10 Total	Fugitive PM2.5	Exhaust PM2.5	PM2.5 Total	Bio- CO2	NBio- CO2	Total CO2	CH4	N2O	CO2e
Category	lb/day										lb/day					
Fugitive Dust					0.3322	0.0000	0.3322	0.0503	0.0000	0.0503			0.0000			0.0000
Off-Road	1.8101	20.8123	11.0644	0.0252		0.8363	0.8363		0.7694	0.7694		2,613.1858	2,613.1858	0.7882		2,629.7386
Total	1.8101	20.8123	11.0644	0.0252	0.3322	0.8363	1.1685	0.0503	0.7694	0.8197		2,613.1858	2,613.1858	0.7882		2,629.7386

Unmitigated Construction Off-Site

	ROG	NOx	CO	SO2	Fugitive PM10	Exhaust PM10	PM10 Total	Fugitive PM2.5	Exhaust PM2.5	PM2.5 Total	Bio- CO2	NBio- CO2	Total CO2	CH4	N2O	CO2e
Category	lb/day										lb/day					

Hauling	0.0817	1.1676	0.8335	3.1200e-003	0.0726	0.0160	0.0886	0.0199	0.0147	0.0346		314.0322	314.0322	2.2300e-003		314.0792
Vendor	0.0417	0.3791	0.4450	9.5000e-004	0.0266	5.7300e-003	0.0323	7.5700e-003	5.2700e-003	0.0129		95.4354	95.4354	7.4000e-004		95.4509
Worker	0.0489	0.0574	0.6263	1.4600e-003	0.1150	8.6000e-004	0.1159	0.0305	7.9000e-004	0.0313		121.5945	121.5945	6.0900e-003		121.7224
Total	0.1723	1.6042	1.9048	5.5300e-003	0.2142	0.0225	0.2367	0.0580	0.0207	0.0787		531.0621	531.0621	9.0600e-003		531.2524

Mitigated Construction On-Site

	ROG	NOx	CO	SO2	Fugitive PM10	Exhaust PM10	PM10 Total	Fugitive PM2.5	Exhaust PM2.5	PM2.5 Total	Bio- CO2	NBio- CO2	Total CO2	CH4	N2O	CO2e
Category	lb/day										lb/day					
Fugitive Dust					0.1296	0.0000	0.1296	0.0196	0.0000	0.0196			0.0000			0.0000
Off-Road	1.8101	20.8123	11.0644	0.0252		0.8363	0.8363		0.7694	0.7694	0.0000	2,613.1858	2,613.1858	0.7882		2,629.7386
Total	1.8101	20.8123	11.0644	0.0252	0.1296	0.8363	0.9659	0.0196	0.7694	0.7890	0.0000	2,613.1858	2,613.1858	0.7882		2,629.7386

Mitigated Construction Off-Site

	ROG	NOx	CO	SO2	Fugitive PM10	Exhaust PM10	PM10 Total	Fugitive PM2.5	Exhaust PM2.5	PM2.5 Total	Bio- CO2	NBio- CO2	Total CO2	CH4	N2O	CO2e
Category	lb/day										lb/day					
Hauling	0.0817	1.1676	0.8335	3.1200e-003	0.0726	0.0160	0.0886	0.0199	0.0147	0.0346		314.0322	314.0322	2.2300e-003		314.0792
Vendor	0.0417	0.3791	0.4450	9.5000e-004	0.0266	5.7300e-003	0.0323	7.5700e-003	5.2700e-003	0.0129		95.4354	95.4354	7.4000e-004		95.4509
Worker	0.0489	0.0574	0.6263	1.4600e-003	0.1150	8.6000e-004	0.1159	0.0305	7.9000e-004	0.0313		121.5945	121.5945	6.0900e-003		121.7224
Total	0.1723	1.6042	1.9048	5.5300e-003	0.2142	0.0225	0.2367	0.0580	0.0207	0.0787		531.0621	531.0621	9.0600e-003		531.2524

3.4 Intake 2a - Sheet Piling - 2016

Unmitigated Construction On-Site

	ROG	NOx	CO	SO2	Fugitive PM10	Exhaust PM10	PM10 Total	Fugitive PM2.5	Exhaust PM2.5	PM2.5 Total	Bio- CO2	NBio- CO2	Total CO2	CH4	N2O	CO2e
Category	lb/day										lb/day					
Off-Road	3.4259	33.8047	18.6887	0.0430		1.7656	1.7656		1.7099	1.7099		4,279.9002	4,279.9002	0.9081		4,298.9698
Total	3.4259	33.8047	18.6887	0.0430		1.7656	1.7656		1.7099	1.7099		4,279.9002	4,279.9002	0.9081		4,298.9698

Unmitigated Construction Off-Site

	ROG	NOx	CO	SO2	Fugitive PM10	Exhaust PM10	PM10 Total	Fugitive PM2.5	Exhaust PM2.5	PM2.5 Total	Bio- CO2	NBio- CO2	Total CO2	CH4	N2O	CO2e
Category	lb/day										lb/day					
Hauling	0.1100	1.5724	1.1225	4.2000e-003	0.1397	0.0215	0.1612	0.0371	0.0198	0.0568		422.8967	422.8967	3.0100e-003		422.9599
Vendor	0.2086	1.8955	2.2248	4.7600e-003	0.1328	0.0287	0.1614	0.0379	0.0264	0.0642		477.1769	477.1769	3.6900e-003		477.2543
Worker	0.0979	0.1149	1.2527	2.9100e-003	0.2300	1.7300e-003	0.2317	0.0610	1.5900e-003	0.0626		243.1890	243.1890	0.0122		243.4448
Total	0.4165	3.5827	4.6000	0.0119	0.5025	0.0519	0.5543	0.1359	0.0477	0.1837		1,143.2626	1,143.2626	0.0189		1,143.6591

Mitigated Construction On-Site

	ROG	NOx	CO	SO2	Fugitive PM10	Exhaust PM10	PM10 Total	Fugitive PM2.5	Exhaust PM2.5	PM2.5 Total	Bio- CO2	NBio- CO2	Total CO2	CH4	N2O	CO2e
Category	lb/day										lb/day					
Off-Road	3.4259	33.8047	18.6887	0.0430		1.7656	1.7656		1.7099	1.7099	0.0000	4,279.9002	4,279.9002	0.9081		4,298.9698
Total	3.4259	33.8047	18.6887	0.0430		1.7656	1.7656		1.7099	1.7099	0.0000	4,279.9002	4,279.9002	0.9081		4,298.9698

Mitigated Construction Off-Site

	ROG	NOx	CO	SO2	Fugitive PM10	Exhaust PM10	PM10 Total	Fugitive PM2.5	Exhaust PM2.5	PM2.5 Total	Bio- CO2	NBio- CO2	Total CO2	CH4	N2O	CO2e
Category	lb/day										lb/day					
Hauling	0.1100	1.5724	1.1225	4.2000e-003	0.1397	0.0215	0.1612	0.0371	0.0198	0.0568		422.8967	422.8967	3.0100e-003		422.9599
Vendor	0.2086	1.8955	2.2248	4.7600e-003	0.1328	0.0287	0.1614	0.0379	0.0264	0.0642		477.1769	477.1769	3.6900e-003		477.2543
Worker	0.0979	0.1149	1.2527	2.9100e-003	0.2300	1.7300e-003	0.2317	0.0610	1.5900e-003	0.0626		243.1890	243.1890	0.0122		243.4448
Total	0.4165	3.5827	4.6000	0.0119	0.5025	0.0519	0.5543	0.1359	0.0477	0.1837		1,143.2626	1,143.2626	0.0189		1,143.6591

3.4 Intake 2a - Sheet Piling - 2017

Unmitigated Construction On-Site

	ROG	NOx	CO	SO2	Fugitive PM10	Exhaust PM10	PM10 Total	Fugitive PM2.5	Exhaust PM2.5	PM2.5 Total	Bio- CO2	NBio- CO2	Total CO2	CH4	N2O	CO2e
Category	lb/day										lb/day					
Off-Road	3.0742	30.4518	18.2559	0.0430		1.5503	1.5503		1.5018	1.5018		4,241.8711	4,241.8711	0.8882		4,260.5227

Total	3.0742	30.4518	18.2559	0.0430		1.5503	1.5503		1.5018	1.5018		4,241.8711	4,241.8711	0.8882		4,260.5227
--------------	---------------	----------------	----------------	---------------	--	---------------	---------------	--	---------------	---------------	--	-------------------	-------------------	---------------	--	-------------------

Unmitigated Construction Off-Site

	ROG	NOx	CO	SO2	Fugitive PM10	Exhaust PM10	PM10 Total	Fugitive PM2.5	Exhaust PM2.5	PM2.5 Total	Bio- CO2	NBio- CO2	Total CO2	CH4	N2O	CO2e
Category	lb/day										lb/day					
Hauling	0.1030	1.4021	1.0705	4.1900e-003	0.2290	0.0189	0.2479	0.0590	0.0174	0.0764		415.6945	415.6945	2.8800e-003		415.7550
Vendor	0.1912	1.6950	2.0883	4.7500e-003	0.1328	0.0249	0.1576	0.0379	0.0229	0.0608		469.1158	469.1158	3.4900e-003		469.1890
Worker	0.0890	0.1044	1.1330	2.9100e-003	0.2300	1.6700e-003	0.2317	0.0610	1.5400e-003	0.0626		233.8049	233.8049	0.0113		234.0416
Total	0.3832	3.2015	4.2917	0.0119	0.5918	0.0454	0.6372	0.1579	0.0418	0.1997		1,118.6152	1,118.6152	0.0176		1,118.9856

Mitigated Construction On-Site

	ROG	NOx	CO	SO2	Fugitive PM10	Exhaust PM10	PM10 Total	Fugitive PM2.5	Exhaust PM2.5	PM2.5 Total	Bio- CO2	NBio- CO2	Total CO2	CH4	N2O	CO2e
Category	lb/day										lb/day					
Off-Road	3.0742	30.4518	18.2559	0.0430		1.5503	1.5503		1.5018	1.5018	0.0000	4,241.8711	4,241.8711	0.8882		4,260.5227
Total	3.0742	30.4518	18.2559	0.0430		1.5503	1.5503		1.5018	1.5018	0.0000	4,241.8711	4,241.8711	0.8882		4,260.5227

Mitigated Construction Off-Site

	ROG	NOx	CO	SO2	Fugitive PM10	Exhaust PM10	PM10 Total	Fugitive PM2.5	Exhaust PM2.5	PM2.5 Total	Bio- CO2	NBio- CO2	Total CO2	CH4	N2O	CO2e
Category	lb/day										lb/day					
Hauling	0.1030	1.4021	1.0705	4.1900e-003	0.2290	0.0189	0.2479	0.0590	0.0174	0.0764		415.6945	415.6945	2.8800e-003		415.7550
Vendor	0.1912	1.6950	2.0883	4.7500e-003	0.1328	0.0249	0.1576	0.0379	0.0229	0.0608		469.1158	469.1158	3.4900e-003		469.1890
Worker	0.0890	0.1044	1.1330	2.9100e-003	0.2300	1.6700e-003	0.2317	0.0610	1.5400e-003	0.0626		233.8049	233.8049	0.0113		234.0416
Total	0.3832	3.2015	4.2917	0.0119	0.5918	0.0454	0.6372	0.1579	0.0418	0.1997		1,118.6152	1,118.6152	0.0176		1,118.9856

3.5 Intake 2b - Excavation - 2017

Unmitigated Construction On-Site

	ROG	NOx	CO	SO2	Fugitive PM10	Exhaust PM10	PM10 Total	Fugitive PM2.5	Exhaust PM2.5	PM2.5 Total	Bio- CO2	NBio- CO2	Total CO2	CH4	N2O	CO2e
Category	lb/day										lb/day					
Fugitive Dust					0.0341	0.0000	0.0341	4.5200e-003	0.0000	4.5200e-003			0.0000			0.0000
Off-Road	4.9478	50.2120	27.9116	0.0643		2.4334	2.4334		2.3143	2.3143		6,420.9609	6,420.9609	1.5558		6,453.6335
Total	4.9478	50.2120	27.9116	0.0643	0.0341	2.4334	2.4676	4.5200e-003	2.3143	2.3188		6,420.9609	6,420.9609	1.5558		6,453.6335

Unmitigated Construction Off-Site

	ROG	NOx	CO	SO2	Fugitive PM10	Exhaust PM10	PM10 Total	Fugitive PM2.5	Exhaust PM2.5	PM2.5 Total	Bio- CO2	NBio- CO2	Total CO2	CH4	N2O	CO2e
Category	lb/day										lb/day					

Hauling	0.1567	2.1328	1.6283	6.3700e-003	0.1487	0.0287	0.1775	0.0407	0.0264	0.0671		632.3241	632.3241	4.3800e-003		632.4160
Vendor	0.1912	1.6950	2.0883	4.7500e-003	0.1328	0.0249	0.1576	0.0379	0.0229	0.0608		469.1158	469.1158	3.4900e-003		469.1890
Worker	0.0890	0.1044	1.1330	2.9100e-003	0.2300	1.6700e-003	0.2317	0.0610	1.5400e-003	0.0626		233.8049	233.8049	0.0113		234.0416
Total	0.4369	3.9322	4.8496	0.0140	0.5115	0.0553	0.5668	0.1396	0.0508	0.1905		1,335.2447	1,335.2447	0.0191		1,335.6466

Mitigated Construction On-Site

	ROG	NOx	CO	SO2	Fugitive PM10	Exhaust PM10	PM10 Total	Fugitive PM2.5	Exhaust PM2.5	PM2.5 Total	Bio- CO2	NBio- CO2	Total CO2	CH4	N2O	CO2e
Category	lb/day										lb/day					
Fugitive Dust					0.0133	0.0000	0.0133	1.7600e-003	0.0000	1.7600e-003			0.0000			0.0000
Off-Road	4.9478	50.2120	27.9116	0.0643		2.4334	2.4334		2.3143	2.3143	0.0000	6,420.9609	6,420.9609	1.5558		6,453.6335
Total	4.9478	50.2120	27.9116	0.0643	0.0133	2.4334	2.4467	1.7600e-003	2.3143	2.3160	0.0000	6,420.9609	6,420.9609	1.5558		6,453.6335

Mitigated Construction Off-Site

	ROG	NOx	CO	SO2	Fugitive PM10	Exhaust PM10	PM10 Total	Fugitive PM2.5	Exhaust PM2.5	PM2.5 Total	Bio- CO2	NBio- CO2	Total CO2	CH4	N2O	CO2e
Category	lb/day										lb/day					
Hauling	0.1567	2.1328	1.6283	6.3700e-003	0.1487	0.0287	0.1775	0.0407	0.0264	0.0671		632.3241	632.3241	4.3800e-003		632.4160
Vendor	0.1912	1.6950	2.0883	4.7500e-003	0.1328	0.0249	0.1576	0.0379	0.0229	0.0608		469.1158	469.1158	3.4900e-003		469.1890
Worker	0.0890	0.1044	1.1330	2.9100e-003	0.2300	1.6700e-003	0.2317	0.0610	1.5400e-003	0.0626		233.8049	233.8049	0.0113		234.0416
Total	0.4369	3.9322	4.8496	0.0140	0.5115	0.0553	0.5668	0.1396	0.0508	0.1905		1,335.2447	1,335.2447	0.0191		1,335.6466

3.6 Intake 3 - Building Construction - 2017

Unmitigated Construction On-Site

	ROG	NOx	CO	SO2	Fugitive PM10	Exhaust PM10	PM10 Total	Fugitive PM2.5	Exhaust PM2.5	PM2.5 Total	Bio- CO2	NBio- CO2	Total CO2	CH4	N2O	CO2e
Category	lb/day										lb/day					
Off-Road	8.0195	77.5010	57.3801	0.0887		4.2475	4.2475		3.9832	3.9832		8,923.9578	8,923.9578	2.3228		8,972.7356
Total	8.0195	77.5010	57.3801	0.0887		4.2475	4.2475		3.9832	3.9832		8,923.9578	8,923.9578	2.3228		8,972.7356

Unmitigated Construction Off-Site

	ROG	NOx	CO	SO2	Fugitive PM10	Exhaust PM10	PM10 Total	Fugitive PM2.5	Exhaust PM2.5	PM2.5 Total	Bio- CO2	NBio- CO2	Total CO2	CH4	N2O	CO2e
Category	lb/day										lb/day					
Hauling	0.0349	0.4748	0.3625	1.4200e-003	0.0331	6.3900e-003	0.0395	9.0700e-003	5.8800e-003	0.0150		140.7599	140.7599	9.7000e-004		140.7804
Vendor	0.1339	1.1865	1.4618	3.3300e-003	0.0929	0.0174	0.1103	0.0265	0.0160	0.0425		328.3810	328.3810	2.4400e-003		328.4323
Worker	0.0826	0.0969	1.0521	2.7100e-003	0.2136	1.5500e-003	0.2151	0.0567	1.4300e-003	0.0581		217.1045	217.1045	0.0105		217.3244
Total	0.2514	1.7582	2.8763	7.4600e-003	0.3396	0.0254	0.3650	0.0922	0.0233	0.1156		686.2455	686.2455	0.0139		686.5370

Mitigated Construction On-Site

	ROG	NOx	CO	SO2	Fugitive PM10	Exhaust PM10	PM10 Total	Fugitive PM2.5	Exhaust PM2.5	PM2.5 Total	Bio- CO2	NBio- CO2	Total CO2	CH4	N2O	CO2e
Category	lb/day										lb/day					
Off-Road	8.0195	77.5010	57.3801	0.0887		4.2475	4.2475		3.9832	3.9832	0.0000	8,923.9578	8,923.9578	2.3228		8,972.7356
Total	8.0195	77.5010	57.3801	0.0887		4.2475	4.2475		3.9832	3.9832	0.0000	8,923.9578	8,923.9578	2.3228		8,972.7356

Mitigated Construction Off-Site

	ROG	NOx	CO	SO2	Fugitive PM10	Exhaust PM10	PM10 Total	Fugitive PM2.5	Exhaust PM2.5	PM2.5 Total	Bio- CO2	NBio- CO2	Total CO2	CH4	N2O	CO2e
Category	lb/day										lb/day					
Hauling	0.0349	0.4748	0.3625	1.4200e-003	0.0331	6.3900e-003	0.0395	9.0700e-003	5.8800e-003	0.0150		140.7599	140.7599	9.7000e-004		140.7804
Vendor	0.1339	1.1865	1.4618	3.3300e-003	0.0929	0.0174	0.1103	0.0265	0.0160	0.0425		328.3810	328.3810	2.4400e-003		328.4323
Worker	0.0826	0.0969	1.0521	2.7100e-003	0.2136	1.5500e-003	0.2151	0.0567	1.4300e-003	0.0581		217.1045	217.1045	0.0105		217.3244
Total	0.2514	1.7582	2.8763	7.4600e-003	0.3396	0.0254	0.3650	0.0922	0.0233	0.1156		686.2455	686.2455	0.0139		686.5370

3.7 Axial 1 - Paving - 2017

Unmitigated Construction On-Site

	ROG	NOx	CO	SO2	Fugitive PM10	Exhaust PM10	PM10 Total	Fugitive PM2.5	Exhaust PM2.5	PM2.5 Total	Bio- CO2	NBio- CO2	Total CO2	CH4	N2O	CO2e
Category	lb/day										lb/day					
Off-Road	0.6710	6.9321	4.8269	7.1400e-003		0.4086	0.4086		0.3759	0.3759		730.1781	730.1781	0.2237		734.8764

Paving	0.0000					0.0000	0.0000		0.0000	0.0000			0.0000			0.0000
Total	0.6710	6.9321	4.8269	7.1400e-003		0.4086	0.4086		0.3759	0.3759		730.1781	730.1781	0.2237		734.8764

Unmitigated Construction Off-Site

	ROG	NOx	CO	SO2	Fugitive PM10	Exhaust PM10	PM10 Total	Fugitive PM2.5	Exhaust PM2.5	PM2.5 Total	Bio- CO2	NBio- CO2	Total CO2	CH4	N2O	CO2e
Category	lb/day										lb/day					
Hauling	0.0000	0.0000	0.0000	0.0000	0.0000	0.0000	0.0000	0.0000	0.0000	0.0000		0.0000	0.0000	0.0000		0.0000
Vendor	0.1721	1.5255	1.8794	4.2800e-003	0.1195	0.0224	0.1419	0.0341	0.0206	0.0547		422.2042	422.2042	3.1400e-003		422.2701
Worker	0.0381	0.0447	0.4856	1.2500e-003	0.0986	7.2000e-004	0.0993	0.0262	6.6000e-004	0.0268		100.2021	100.2021	4.8300e-003		100.3036
Total	0.2102	1.5702	2.3650	5.5300e-003	0.2181	0.0231	0.2412	0.0602	0.0213	0.0815		522.4063	522.4063	7.9700e-003		522.5736

Mitigated Construction On-Site

	ROG	NOx	CO	SO2	Fugitive PM10	Exhaust PM10	PM10 Total	Fugitive PM2.5	Exhaust PM2.5	PM2.5 Total	Bio- CO2	NBio- CO2	Total CO2	CH4	N2O	CO2e
Category	lb/day										lb/day					
Off-Road	0.6710	6.9321	4.8269	7.1400e-003		0.4086	0.4086		0.3759	0.3759	0.0000	730.1781	730.1781	0.2237		734.8764
Paving	0.0000					0.0000	0.0000		0.0000	0.0000			0.0000			0.0000
Total	0.6710	6.9321	4.8269	7.1400e-003		0.4086	0.4086		0.3759	0.3759	0.0000	730.1781	730.1781	0.2237		734.8764

Mitigated Construction Off-Site

	ROG	NOx	CO	SO2	Fugitive PM10	Exhaust PM10	PM10 Total	Fugitive PM2.5	Exhaust PM2.5	PM2.5 Total	Bio- CO2	NBio- CO2	Total CO2	CH4	N2O	CO2e
Category	lb/day										lb/day					
Hauling	0.0000	0.0000	0.0000	0.0000	0.0000	0.0000	0.0000	0.0000	0.0000	0.0000		0.0000	0.0000	0.0000		0.0000
Vendor	0.1721	1.5255	1.8794	4.2800e-003	0.1195	0.0224	0.1419	0.0341	0.0206	0.0547		422.2042	422.2042	3.1400e-003		422.2701
Worker	0.0381	0.0447	0.4856	1.2500e-003	0.0986	7.2000e-004	0.0993	0.0262	6.6000e-004	0.0268		100.2021	100.2021	4.8300e-003		100.3036
Total	0.2102	1.5702	2.3650	5.5300e-003	0.2181	0.0231	0.2412	0.0602	0.0213	0.0815		522.4063	522.4063	7.9700e-003		522.5736

3.8 Intake 4 - Demolition - 2017

Unmitigated Construction On-Site

	ROG	NOx	CO	SO2	Fugitive PM10	Exhaust PM10	PM10 Total	Fugitive PM2.5	Exhaust PM2.5	PM2.5 Total	Bio- CO2	NBio- CO2	Total CO2	CH4	N2O	CO2e
Category	lb/day										lb/day					
Fugitive Dust					0.0198	0.0000	0.0198	2.9900e-003	0.0000	2.9900e-003			0.0000			0.0000
Off-Road	11.4695	120.3359	62.7225	0.1570		5.1476	5.1476		4.8358	4.8358		15,860.6209	15,860.6209	4.3187		15,951.3133
Total	11.4695	120.3359	62.7225	0.1570	0.0198	5.1476	5.1673	2.9900e-003	4.8358	4.8388		15,860.6209	15,860.6209	4.3187		15,951.3133

Unmitigated Construction Off-Site

	ROG	NOx	CO	SO2	Fugitive PM10	Exhaust PM10	PM10 Total	Fugitive PM2.5	Exhaust PM2.5	PM2.5 Total	Bio- CO2	NBio- CO2	Total CO2	CH4	N2O	CO2e
Category	lb/day										lb/day					

Hauling	5.1100e-003	0.0696	0.0531	2.1000e-004	4.8500e-003	9.4000e-004	5.7900e-003	1.3300e-003	8.6000e-004	2.1900e-003		20.6310	20.6310	1.4000e-004		20.6340
Vendor	0.0383	0.3390	0.4177	9.5000e-004	0.0266	4.9800e-003	0.0315	7.5800e-003	4.5800e-003	0.0122		93.8232	93.8232	7.0000e-004		93.8378
Worker	0.0699	0.0820	0.8902	2.2900e-003	0.1807	1.3100e-003	0.1820	0.0479	1.2100e-003	0.0492		183.7038	183.7038	8.8600e-003		183.8899
Total	0.1133	0.4906	1.3610	3.4500e-003	0.2121	7.2300e-003	0.2194	0.0569	6.6500e-003	0.0635		298.1580	298.1580	9.7000e-003		298.3617

Mitigated Construction On-Site

	ROG	NOx	CO	SO2	Fugitive PM10	Exhaust PM10	PM10 Total	Fugitive PM2.5	Exhaust PM2.5	PM2.5 Total	Bio- CO2	NBio- CO2	Total CO2	CH4	N2O	CO2e	
Category	lb/day										lb/day						
Fugitive Dust					7.7000e-003	0.0000	7.7000e-003	1.1700e-003	0.0000	1.1700e-003			0.0000				0.0000
Off-Road	11.4695	120.3359	62.7225	0.1570		5.1476	5.1476		4.8358	4.8358	0.0000	15,860.6209	15,860.6209	4.3187			15,951.3133
Total	11.4695	120.3359	62.7225	0.1570	7.7000e-003	5.1476	5.1553	1.1700e-003	4.8358	4.8370	0.0000	15,860.6209	15,860.6209	4.3187			15,951.3133

Mitigated Construction Off-Site

	ROG	NOx	CO	SO2	Fugitive PM10	Exhaust PM10	PM10 Total	Fugitive PM2.5	Exhaust PM2.5	PM2.5 Total	Bio- CO2	NBio- CO2	Total CO2	CH4	N2O	CO2e
Category	lb/day										lb/day					
Hauling	5.1100e-003	0.0696	0.0531	2.1000e-004	4.8500e-003	9.4000e-004	5.7900e-003	1.3300e-003	8.6000e-004	2.1900e-003		20.6310	20.6310	1.4000e-004		20.6340
Vendor	0.0383	0.3390	0.4177	9.5000e-004	0.0266	4.9800e-003	0.0315	7.5800e-003	4.5800e-003	0.0122		93.8232	93.8232	7.0000e-004		93.8378
Worker	0.0699	0.0820	0.8902	2.2900e-003	0.1807	1.3100e-003	0.1820	0.0479	1.2100e-003	0.0492		183.7038	183.7038	8.8600e-003		183.8899
Total	0.1133	0.4906	1.3610	3.4500e-003	0.2121	7.2300e-003	0.2194	0.0569	6.6500e-003	0.0635		298.1580	298.1580	9.7000e-003		298.3617

3.9 Axial 2 - Pump Station Install - 2017

Unmitigated Construction On-Site

	ROG	NOx	CO	SO2	Fugitive PM10	Exhaust PM10	PM10 Total	Fugitive PM2.5	Exhaust PM2.5	PM2.5 Total	Bio- CO2	NBio- CO2	Total CO2	CH4	N2O	CO2e
Category	lb/day										lb/day					
Off-Road	3.1879	30.5757	19.1538	0.0343		1.6861	1.6861		1.6267	1.6267		3,359.4772	3,359.4772	0.6178		3,372.4511
Total	3.1879	30.5757	19.1538	0.0343		1.6861	1.6861		1.6267	1.6267		3,359.4772	3,359.4772	0.6178		3,372.4511

Unmitigated Construction Off-Site

	ROG	NOx	CO	SO2	Fugitive PM10	Exhaust PM10	PM10 Total	Fugitive PM2.5	Exhaust PM2.5	PM2.5 Total	Bio- CO2	NBio- CO2	Total CO2	CH4	N2O	CO2e
Category	lb/day										lb/day					
Hauling	0.0000	0.0000	0.0000	0.0000	0.0000	0.0000	0.0000	0.0000	0.0000	0.0000		0.0000	0.0000	0.0000		0.0000
Vendor	0.1912	1.6950	2.0883	4.7500e-003	0.1328	0.0249	0.1576	0.0379	0.0229	0.0608		469.1158	469.1158	3.4900e-003		469.1890
Worker	0.0508	0.0597	0.6474	1.6700e-003	0.1314	9.6000e-004	0.1324	0.0349	8.8000e-004	0.0357		133.6028	133.6028	6.4400e-003		133.7381
Total	0.2421	1.7547	2.7357	6.4200e-003	0.2642	0.0258	0.2900	0.0727	0.0238	0.0965		602.7186	602.7186	9.9300e-003		602.9270

Mitigated Construction On-Site

	ROG	NOx	CO	SO2	Fugitive PM10	Exhaust PM10	PM10 Total	Fugitive PM2.5	Exhaust PM2.5	PM2.5 Total	Bio- CO2	NBio- CO2	Total CO2	CH4	N2O	CO2e
Category	lb/day										lb/day					
Off-Road	3.1879	30.5757	19.1538	0.0343		1.6861	1.6861		1.6267	1.6267	0.0000	3,359.4772	3,359.4772	0.6178		3,372.4511
Total	3.1879	30.5757	19.1538	0.0343		1.6861	1.6861		1.6267	1.6267	0.0000	3,359.4772	3,359.4772	0.6178		3,372.4511

Mitigated Construction Off-Site

	ROG	NOx	CO	SO2	Fugitive PM10	Exhaust PM10	PM10 Total	Fugitive PM2.5	Exhaust PM2.5	PM2.5 Total	Bio- CO2	NBio- CO2	Total CO2	CH4	N2O	CO2e
Category	lb/day										lb/day					
Hauling	0.0000	0.0000	0.0000	0.0000	0.0000	0.0000	0.0000	0.0000	0.0000	0.0000		0.0000	0.0000	0.0000		0.0000
Vendor	0.1912	1.6950	2.0883	4.7500e-003	0.1328	0.0249	0.1576	0.0379	0.0229	0.0608		469.1158	469.1158	3.4900e-003		469.1890
Worker	0.0508	0.0597	0.6474	1.6700e-003	0.1314	9.6000e-004	0.1324	0.0349	8.8000e-004	0.0357		133.6028	133.6028	6.4400e-003		133.7381
Total	0.2421	1.7547	2.7357	6.4200e-003	0.2642	0.0258	0.2900	0.0727	0.0238	0.0965		602.7186	602.7186	9.9300e-003		602.9270

3.10 Axial 3a - Trenching - 2017

Unmitigated Construction On-Site

	ROG	NOx	CO	SO2	Fugitive PM10	Exhaust PM10	PM10 Total	Fugitive PM2.5	Exhaust PM2.5	PM2.5 Total	Bio- CO2	NBio- CO2	Total CO2	CH4	N2O	CO2e
Category	lb/day										lb/day					
Off-Road	0.4038	5.0661	2.4218	9.8300e-003		0.1638	0.1638		0.1507	0.1507		1,003.8880	1,003.8880	0.3076		1,010.3474

Total	0.4038	5.0661	2.4218	9.8300e-003		0.1638	0.1638		0.1507	0.1507		1,003.8880	1,003.8880	0.3076		1,010.3474
--------------	---------------	---------------	---------------	--------------------	--	---------------	---------------	--	---------------	---------------	--	-------------------	-------------------	---------------	--	-------------------

Unmitigated Construction Off-Site

	ROG	NOx	CO	SO2	Fugitive PM10	Exhaust PM10	PM10 Total	Fugitive PM2.5	Exhaust PM2.5	PM2.5 Total	Bio- CO2	NBio- CO2	Total CO2	CH4	N2O	CO2e
Category	lb/day										lb/day					
Hauling	0.0000	0.0000	0.0000	0.0000	0.0000	0.0000	0.0000	0.0000	0.0000	0.0000		0.0000	0.0000	0.0000		0.0000
Vendor	0.0000	0.0000	0.0000	0.0000	0.0000	0.0000	0.0000	0.0000	0.0000	0.0000		0.0000	0.0000	0.0000		0.0000
Worker	9.5300e-003	0.0112	0.1214	3.1000e-004	0.0246	1.8000e-004	0.0248	6.5400e-003	1.7000e-004	6.7000e-003		25.0505	25.0505	1.2100e-003		25.0759
Total	9.5300e-003	0.0112	0.1214	3.1000e-004	0.0246	1.8000e-004	0.0248	6.5400e-003	1.7000e-004	6.7000e-003		25.0505	25.0505	1.2100e-003		25.0759

Mitigated Construction On-Site

	ROG	NOx	CO	SO2	Fugitive PM10	Exhaust PM10	PM10 Total	Fugitive PM2.5	Exhaust PM2.5	PM2.5 Total	Bio- CO2	NBio- CO2	Total CO2	CH4	N2O	CO2e
Category	lb/day										lb/day					
Off-Road	0.4038	5.0661	2.4218	9.8300e-003		0.1638	0.1638		0.1507	0.1507	0.0000	1,003.8880	1,003.8880	0.3076		1,010.3474
Total	0.4038	5.0661	2.4218	9.8300e-003		0.1638	0.1638		0.1507	0.1507	0.0000	1,003.8880	1,003.8880	0.3076		1,010.3474

Mitigated Construction Off-Site

	ROG	NOx	CO	SO2	Fugitive PM10	Exhaust PM10	PM10 Total	Fugitive PM2.5	Exhaust PM2.5	PM2.5 Total	Bio- CO2	NBio- CO2	Total CO2	CH4	N2O	CO2e
Category	lb/day										lb/day					
Hauling	0.0000	0.0000	0.0000	0.0000	0.0000	0.0000	0.0000	0.0000	0.0000	0.0000		0.0000	0.0000	0.0000		0.0000
Vendor	0.0000	0.0000	0.0000	0.0000	0.0000	0.0000	0.0000	0.0000	0.0000	0.0000		0.0000	0.0000	0.0000		0.0000
Worker	9.5300e-003	0.0112	0.1214	3.1000e-004	0.0246	1.8000e-004	0.0248	6.5400e-003	1.7000e-004	6.7000e-003		25.0505	25.0505	1.2100e-003		25.0759
Total	9.5300e-003	0.0112	0.1214	3.1000e-004	0.0246	1.8000e-004	0.0248	6.5400e-003	1.7000e-004	6.7000e-003		25.0505	25.0505	1.2100e-003		25.0759

3.11 Axial 3b - Paving - 2017

Unmitigated Construction On-Site

	ROG	NOx	CO	SO2	Fugitive PM10	Exhaust PM10	PM10 Total	Fugitive PM2.5	Exhaust PM2.5	PM2.5 Total	Bio- CO2	NBio- CO2	Total CO2	CH4	N2O	CO2e
Category	lb/day										lb/day					
Off-Road	0.6710	6.9321	4.8269	7.1400e-003		0.4086	0.4086		0.3759	0.3759		730.1781	730.1781	0.2237		734.8764
Paving	0.0000					0.0000	0.0000		0.0000	0.0000			0.0000			0.0000
Total	0.6710	6.9321	4.8269	7.1400e-003		0.4086	0.4086		0.3759	0.3759		730.1781	730.1781	0.2237		734.8764

Unmitigated Construction Off-Site

	ROG	NOx	CO	SO2	Fugitive PM10	Exhaust PM10	PM10 Total	Fugitive PM2.5	Exhaust PM2.5	PM2.5 Total	Bio- CO2	NBio- CO2	Total CO2	CH4	N2O	CO2e
Category	lb/day										lb/day					

Hauling	0.0000	0.0000	0.0000	0.0000	0.0000	0.0000	0.0000	0.0000	0.0000	0.0000	0.0000	0.0000	0.0000	0.0000	0.0000	0.0000
Vendor	0.1530	1.3560	1.6706	3.8000e-003	0.1062	0.0199	0.1261	0.0303	0.0183	0.0486		375.2926	375.2926	2.7900e-003		375.3512
Worker	0.0445	0.0522	0.5665	1.4600e-003	0.1150	8.4000e-004	0.1158	0.0305	7.7000e-004	0.0313		116.9024	116.9024	5.6400e-003		117.0208
Total	0.1975	1.4082	2.2371	5.2600e-003	0.2212	0.0207	0.2420	0.0608	0.0191	0.0799		492.1951	492.1951	8.4300e-003		492.3720

Mitigated Construction On-Site

	ROG	NOx	CO	SO2	Fugitive PM10	Exhaust PM10	PM10 Total	Fugitive PM2.5	Exhaust PM2.5	PM2.5 Total	Bio- CO2	NBio- CO2	Total CO2	CH4	N2O	CO2e
Category	lb/day										lb/day					
Off-Road	0.6710	6.9321	4.8269	7.1400e-003		0.4086	0.4086		0.3759	0.3759	0.0000	730.1781	730.1781	0.2237		734.8764
Paving	0.0000					0.0000	0.0000		0.0000	0.0000			0.0000			0.0000
Total	0.6710	6.9321	4.8269	7.1400e-003		0.4086	0.4086		0.3759	0.3759	0.0000	730.1781	730.1781	0.2237		734.8764

Mitigated Construction Off-Site

	ROG	NOx	CO	SO2	Fugitive PM10	Exhaust PM10	PM10 Total	Fugitive PM2.5	Exhaust PM2.5	PM2.5 Total	Bio- CO2	NBio- CO2	Total CO2	CH4	N2O	CO2e
Category	lb/day										lb/day					
Hauling	0.0000	0.0000	0.0000	0.0000	0.0000	0.0000	0.0000	0.0000	0.0000	0.0000		0.0000	0.0000	0.0000		0.0000
Vendor	0.1530	1.3560	1.6706	3.8000e-003	0.1062	0.0199	0.1261	0.0303	0.0183	0.0486		375.2926	375.2926	2.7900e-003		375.3512
Worker	0.0445	0.0522	0.5665	1.4600e-003	0.1150	8.4000e-004	0.1158	0.0305	7.7000e-004	0.0313		116.9024	116.9024	5.6400e-003		117.0208
Total	0.1975	1.4082	2.2371	5.2600e-003	0.2212	0.0207	0.2420	0.0608	0.0191	0.0799		492.1951	492.1951	8.4300e-003		492.3720

3.12 Intake 5 - Backfill - 2017

Unmitigated Construction On-Site

	ROG	NOx	CO	SO2	Fugitive PM10	Exhaust PM10	PM10 Total	Fugitive PM2.5	Exhaust PM2.5	PM2.5 Total	Bio- CO2	NBio- CO2	Total CO2	CH4	N2O	CO2e
Category	lb/day										lb/day					
Fugitive Dust					0.0000	0.0000	0.0000	0.0000	0.0000	0.0000			0.0000			0.0000
Off-Road	6.3575	66.8053	36.6266	0.0884		2.9938	2.9938		2.8299	2.8299		8,888.1093	8,888.1093	2.3118		8,936.6564
Total	6.3575	66.8053	36.6266	0.0884	0.0000	2.9938	2.9938	0.0000	2.8299	2.8299		8,888.1093	8,888.1093	2.3118		8,936.6564

Unmitigated Construction Off-Site

	ROG	NOx	CO	SO2	Fugitive PM10	Exhaust PM10	PM10 Total	Fugitive PM2.5	Exhaust PM2.5	PM2.5 Total	Bio- CO2	NBio- CO2	Total CO2	CH4	N2O	CO2e
Category	lb/day										lb/day					
Hauling	0.0000	0.0000	0.0000	0.0000	0.0000	0.0000	0.0000	0.0000	0.0000	0.0000		0.0000	0.0000	0.0000		0.0000
Vendor	0.0383	0.3390	0.4177	9.5000e-004	0.0266	4.9800e-003	0.0315	7.5800e-003	4.5800e-003	0.0122		93.8232	93.8232	7.0000e-004		93.8378
Worker	0.0826	0.0969	1.0521	2.7100e-003	0.2136	1.5500e-003	0.2151	0.0567	1.4300e-003	0.0581		217.1045	217.1045	0.0105		217.3244
Total	0.1209	0.4359	1.4697	3.6600e-003	0.2401	6.5300e-003	0.2467	0.0642	6.0100e-003	0.0702		310.9277	310.9277	0.0112		311.1622

Mitigated Construction On-Site

	ROG	NOx	CO	SO2	Fugitive PM10	Exhaust PM10	PM10 Total	Fugitive PM2.5	Exhaust PM2.5	PM2.5 Total	Bio- CO2	NBio- CO2	Total CO2	CH4	N2O	CO2e
Category	lb/day										lb/day					
Fugitive Dust					0.0000	0.0000	0.0000	0.0000	0.0000	0.0000			0.0000			0.0000
Off-Road	6.3575	66.8053	36.6266	0.0884		2.9938	2.9938		2.8299	2.8299	0.0000	8,888.1093	8,888.1093	2.3118		8,936.6564
Total	6.3575	66.8053	36.6266	0.0884	0.0000	2.9938	2.9938	0.0000	2.8299	2.8299	0.0000	8,888.1093	8,888.1093	2.3118		8,936.6564

Mitigated Construction Off-Site

	ROG	NOx	CO	SO2	Fugitive PM10	Exhaust PM10	PM10 Total	Fugitive PM2.5	Exhaust PM2.5	PM2.5 Total	Bio- CO2	NBio- CO2	Total CO2	CH4	N2O	CO2e
Category	lb/day										lb/day					
Hauling	0.0000	0.0000	0.0000	0.0000	0.0000	0.0000	0.0000	0.0000	0.0000	0.0000		0.0000	0.0000	0.0000		0.0000
Vendor	0.0383	0.3390	0.4177	9.5000e-004	0.0266	4.9800e-003	0.0315	7.5800e-003	4.5800e-003	0.0122		93.8232	93.8232	7.0000e-004		93.8378
Worker	0.0826	0.0969	1.0521	2.7100e-003	0.2136	1.5500e-003	0.2151	0.0567	1.4300e-003	0.0581		217.1045	217.1045	0.0105		217.3244
Total	0.1209	0.4359	1.4697	3.6600e-003	0.2401	6.5300e-003	0.2467	0.0642	6.0100e-003	0.0702		310.9277	310.9277	0.0112		311.1622

3.12 Intake 5 - Backfill - 2018

Unmitigated Construction On-Site

	ROG	NOx	CO	SO2	Fugitive PM10	Exhaust PM10	PM10 Total	Fugitive PM2.5	Exhaust PM2.5	PM2.5 Total	Bio- CO2	NBio- CO2	Total CO2	CH4	N2O	CO2e
Category	lb/day										lb/day					
Fugitive Dust					0.0000	0.0000	0.0000	0.0000	0.0000	0.0000			0.0000			0.0000

Off-Road	5.5954	57.5554	34.6767	0.0884		2.5309	2.5309		2.3948	2.3948		8,773.3983	8,773.3983	2.2908		8,821.5057
Total	5.5954	57.5554	34.6767	0.0884	0.0000	2.5309	2.5309	0.0000	2.3948	2.3948		8,773.3983	8,773.3983	2.2908		8,821.5057

Unmitigated Construction Off-Site

	ROG	NOx	CO	SO2	Fugitive PM10	Exhaust PM10	PM10 Total	Fugitive PM2.5	Exhaust PM2.5	PM2.5 Total	Bio- CO2	NBio- CO2	Total CO2	CH4	N2O	CO2e
Category	lb/day										lb/day					
Hauling	0.0000	0.0000	0.0000	0.0000	0.0000	0.0000	0.0000	0.0000	0.0000	0.0000		0.0000	0.0000	0.0000		0.0000
Vendor	0.0360	0.3062	0.3980	9.5000e-004	0.0266	4.6200e-003	0.0312	7.5700e-003	4.2500e-003	0.0118		92.2121	92.2121	6.8000e-004		92.2264
Worker	0.0753	0.0885	0.9550	2.7100e-003	0.2136	1.5200e-003	0.2151	0.0567	1.4100e-003	0.0581		208.9610	208.9610	9.7400e-003		209.1655
Total	0.1113	0.3947	1.3530	3.6600e-003	0.2401	6.1400e-003	0.2463	0.0642	5.6600e-003	0.0699		301.1731	301.1731	0.0104		301.3919

Mitigated Construction On-Site

	ROG	NOx	CO	SO2	Fugitive PM10	Exhaust PM10	PM10 Total	Fugitive PM2.5	Exhaust PM2.5	PM2.5 Total	Bio- CO2	NBio- CO2	Total CO2	CH4	N2O	CO2e
Category	lb/day										lb/day					
Fugitive Dust					0.0000	0.0000	0.0000	0.0000	0.0000	0.0000			0.0000			0.0000
Off-Road	5.5954	57.5554	34.6767	0.0884		2.5309	2.5309		2.3948	2.3948	0.0000	8,773.3983	8,773.3983	2.2908		8,821.5057
Total	5.5954	57.5554	34.6767	0.0884	0.0000	2.5309	2.5309	0.0000	2.3948	2.3948	0.0000	8,773.3983	8,773.3983	2.2908		8,821.5057

Mitigated Construction Off-Site

	ROG	NOx	CO	SO2	Fugitive PM10	Exhaust PM10	PM10 Total	Fugitive PM2.5	Exhaust PM2.5	PM2.5 Total	Bio- CO2	NBio- CO2	Total CO2	CH4	N2O	CO2e
Category	lb/day										lb/day					
Hauling	0.0000	0.0000	0.0000	0.0000	0.0000	0.0000	0.0000	0.0000	0.0000	0.0000		0.0000	0.0000	0.0000		0.0000
Vendor	0.0360	0.3062	0.3980	9.5000e-004	0.0266	4.6200e-003	0.0312	7.5700e-003	4.2500e-003	0.0118		92.2121	92.2121	6.8000e-004		92.2264
Worker	0.0753	0.0885	0.9550	2.7100e-003	0.2136	1.5200e-003	0.2151	0.0567	1.4100e-003	0.0581		208.9610	208.9610	9.7400e-003		209.1655
Total	0.1113	0.3947	1.3530	3.6600e-003	0.2401	6.1400e-003	0.2463	0.0642	5.6600e-003	0.0699		301.1731	301.1731	0.0104		301.3919

3.13 Axial 4 - Building Construction - 2017

Unmitigated Construction On-Site

	ROG	NOx	CO	SO2	Fugitive PM10	Exhaust PM10	PM10 Total	Fugitive PM2.5	Exhaust PM2.5	PM2.5 Total	Bio- CO2	NBio- CO2	Total CO2	CH4	N2O	CO2e
Category	lb/day										lb/day					
Off-Road	10.3309	110.2412	56.6302	0.1443		4.5890	4.5890		4.2974	4.2974		14,605.1956	14,605.1956	4.0635		14,690.5285
Total	10.3309	110.2412	56.6302	0.1443		4.5890	4.5890		4.2974	4.2974		14,605.1956	14,605.1956	4.0635		14,690.5285

Unmitigated Construction Off-Site

	ROG	NOx	CO	SO2	Fugitive PM10	Exhaust PM10	PM10 Total	Fugitive PM2.5	Exhaust PM2.5	PM2.5 Total	Bio- CO2	NBio- CO2	Total CO2	CH4	N2O	CO2e
Category	lb/day										lb/day					

Hauling	0.0000	0.0000	0.0000	0.0000	0.0000	0.0000	0.0000	0.0000	0.0000	0.0000	0.0000	0.0000	0.0000	0.0000	0.0000	0.0000
Vendor	0.1912	1.6950	2.0883	4.7500e-003	0.1328	0.0249	0.1576	0.0379	0.0229	0.0608		469.1158	469.1158	3.4900e-003		469.1890
Worker	0.0826	0.0969	1.0521	2.7100e-003	0.2136	1.5500e-003	0.2151	0.0567	1.4300e-003	0.0581		217.1045	217.1045	0.0105		217.3244
Total	0.2739	1.7919	3.1403	7.4600e-003	0.3463	0.0264	0.3728	0.0945	0.0243	0.1188		686.2203	686.2203	0.0140		686.5133

Mitigated Construction On-Site

	ROG	NOx	CO	SO2	Fugitive PM10	Exhaust PM10	PM10 Total	Fugitive PM2.5	Exhaust PM2.5	PM2.5 Total	Bio- CO2	NBio- CO2	Total CO2	CH4	N2O	CO2e
Category	lb/day										lb/day					
Off-Road	10.3309	110.2412	56.6302	0.1443		4.5890	4.5890		4.2974	4.2974	0.0000	14,605.1956	14,605.1956	4.0635		14,690.5285
Total	10.3309	110.2412	56.6302	0.1443		4.5890	4.5890		4.2974	4.2974	0.0000	14,605.1956	14,605.1956	4.0635		14,690.5285

Mitigated Construction Off-Site

	ROG	NOx	CO	SO2	Fugitive PM10	Exhaust PM10	PM10 Total	Fugitive PM2.5	Exhaust PM2.5	PM2.5 Total	Bio- CO2	NBio- CO2	Total CO2	CH4	N2O	CO2e
Category	lb/day										lb/day					
Hauling	0.0000	0.0000	0.0000	0.0000	0.0000	0.0000	0.0000	0.0000	0.0000	0.0000		0.0000	0.0000	0.0000		0.0000
Vendor	0.1912	1.6950	2.0883	4.7500e-003	0.1328	0.0249	0.1576	0.0379	0.0229	0.0608		469.1158	469.1158	3.4900e-003		469.1890
Worker	0.0826	0.0969	1.0521	2.7100e-003	0.2136	1.5500e-003	0.2151	0.0567	1.4300e-003	0.0581		217.1045	217.1045	0.0105		217.3244
Total	0.2739	1.7919	3.1403	7.4600e-003	0.3463	0.0264	0.3728	0.0945	0.0243	0.1188		686.2203	686.2203	0.0140		686.5133

3.13 Axial 4 - Building Construction - 2018

Unmitigated Construction On-Site

	ROG	NOx	CO	SO2	Fugitive PM10	Exhaust PM10	PM10 Total	Fugitive PM2.5	Exhaust PM2.5	PM2.5 Total	Bio- CO2	NBio- CO2	Total CO2	CH4	N2O	CO2e
Category	lb/day										lb/day					
Off-Road	9.1134	94.1226	51.6981	0.1443		3.8524	3.8524		3.6105	3.6105		14,403.6794	14,403.6794	4.0436		14,488.5952
Total	9.1134	94.1226	51.6981	0.1443		3.8524	3.8524		3.6105	3.6105		14,403.6794	14,403.6794	4.0436		14,488.5952

Unmitigated Construction Off-Site

	ROG	NOx	CO	SO2	Fugitive PM10	Exhaust PM10	PM10 Total	Fugitive PM2.5	Exhaust PM2.5	PM2.5 Total	Bio- CO2	NBio- CO2	Total CO2	CH4	N2O	CO2e
Category	lb/day										lb/day					
Hauling	0.0000	0.0000	0.0000	0.0000	0.0000	0.0000	0.0000	0.0000	0.0000	0.0000		0.0000	0.0000	0.0000		0.0000
Vendor	0.1800	1.5311	1.9899	4.7400e-003	0.1327	0.0231	0.1558	0.0379	0.0213	0.0591		461.0603	461.0603	3.4200e-003		461.1320
Worker	0.0753	0.0885	0.9550	2.7100e-003	0.2136	1.5200e-003	0.2151	0.0567	1.4100e-003	0.0581		208.9610	208.9610	9.7400e-003		209.1655
Total	0.2553	1.6195	2.9449	7.4500e-003	0.3463	0.0246	0.3710	0.0945	0.0227	0.1172		670.0213	670.0213	0.0132		670.2975

Mitigated Construction On-Site

	ROG	NOx	CO	SO2	Fugitive PM10	Exhaust PM10	PM10 Total	Fugitive PM2.5	Exhaust PM2.5	PM2.5 Total	Bio- CO2	NBio- CO2	Total CO2	CH4	N2O	CO2e
Category	lb/day										lb/day					
Off-Road	9.1134	94.1226	51.6981	0.1443		3.8524	3.8524		3.6105	3.6105	0.0000	14,403.6794	14,403.6794	4.0436		14,488.5952
Total	9.1134	94.1226	51.6981	0.1443		3.8524	3.8524		3.6105	3.6105	0.0000	14,403.6794	14,403.6794	4.0436		14,488.5952

Mitigated Construction Off-Site

	ROG	NOx	CO	SO2	Fugitive PM10	Exhaust PM10	PM10 Total	Fugitive PM2.5	Exhaust PM2.5	PM2.5 Total	Bio- CO2	NBio- CO2	Total CO2	CH4	N2O	CO2e
Category	lb/day										lb/day					
Hauling	0.0000	0.0000	0.0000	0.0000	0.0000	0.0000	0.0000	0.0000	0.0000	0.0000		0.0000	0.0000	0.0000		0.0000
Vendor	0.1800	1.5311	1.9899	4.7400e-003	0.1327	0.0231	0.1558	0.0379	0.0213	0.0591		461.0603	461.0603	3.4200e-003		461.1320
Worker	0.0753	0.0885	0.9550	2.7100e-003	0.2136	1.5200e-003	0.2151	0.0567	1.4100e-003	0.0581		208.9610	208.9610	9.7400e-003		209.1655
Total	0.2553	1.6195	2.9449	7.4500e-003	0.3463	0.0246	0.3710	0.0945	0.0227	0.1172		670.0213	670.0213	0.0132		670.2975

3.14 Intake 6a - Grading - 2018

Unmitigated Construction On-Site

	ROG	NOx	CO	SO2	Fugitive PM10	Exhaust PM10	PM10 Total	Fugitive PM2.5	Exhaust PM2.5	PM2.5 Total	Bio- CO2	NBio- CO2	Total CO2	CH4	N2O	CO2e
Category	lb/day										lb/day					
Fugitive Dust					0.1315	0.0000	0.1315	0.0142	0.0000	0.0142			0.0000			0.0000

Off-Road	1.0528	9.7095	5.4199	8.4600e-003		0.5215	0.5215		0.4842	0.4842		808.6313	808.6313	0.2145		813.1347
Total	1.0528	9.7095	5.4199	8.4600e-003	0.1315	0.5215	0.6530	0.0142	0.4842	0.4984		808.6313	808.6313	0.2145		813.1347

Unmitigated Construction Off-Site

	ROG	NOx	CO	SO2	Fugitive PM10	Exhaust PM10	PM10 Total	Fugitive PM2.5	Exhaust PM2.5	PM2.5 Total	Bio- CO2	NBio- CO2	Total CO2	CH4	N2O	CO2e
Category	lb/day										lb/day					
Hauling	0.0000	0.0000	0.0000	0.0000	0.0000	0.0000	0.0000	0.0000	0.0000	0.0000		0.0000	0.0000	0.0000		0.0000
Vendor	0.1260	1.0717	1.3930	3.3200e-003	0.0929	0.0162	0.1091	0.0265	0.0149	0.0414		322.7422	322.7422	2.3900e-003		322.7924
Worker	0.0406	0.0476	0.5142	1.4600e-003	0.1150	8.2000e-004	0.1158	0.0305	7.6000e-004	0.0313		112.5175	112.5175	5.2400e-003		112.6276
Total	0.1666	1.1194	1.9072	4.7800e-003	0.2079	0.0170	0.2249	0.0570	0.0156	0.0726		435.2597	435.2597	7.6300e-003		435.4200

Mitigated Construction On-Site

	ROG	NOx	CO	SO2	Fugitive PM10	Exhaust PM10	PM10 Total	Fugitive PM2.5	Exhaust PM2.5	PM2.5 Total	Bio- CO2	NBio- CO2	Total CO2	CH4	N2O	CO2e
Category	lb/day										lb/day					
Fugitive Dust					0.0513	0.0000	0.0513	5.5400e-003	0.0000	5.5400e-003			0.0000			0.0000
Off-Road	1.0528	9.7095	5.4199	8.4600e-003		0.5215	0.5215		0.4842	0.4842	0.0000	808.6313	808.6313	0.2145		813.1347
Total	1.0528	9.7095	5.4199	8.4600e-003	0.0513	0.5215	0.5728	5.5400e-003	0.4842	0.4897	0.0000	808.6313	808.6313	0.2145		813.1347

Mitigated Construction Off-Site

	ROG	NOx	CO	SO2	Fugitive PM10	Exhaust PM10	PM10 Total	Fugitive PM2.5	Exhaust PM2.5	PM2.5 Total	Bio- CO2	NBio- CO2	Total CO2	CH4	N2O	CO2e
Category	lb/day										lb/day					
Hauling	0.0000	0.0000	0.0000	0.0000	0.0000	0.0000	0.0000	0.0000	0.0000	0.0000		0.0000	0.0000	0.0000		0.0000
Vendor	0.1260	1.0717	1.3930	3.3200e-003	0.0929	0.0162	0.1091	0.0265	0.0149	0.0414		322.7422	322.7422	2.3900e-003		322.7924
Worker	0.0406	0.0476	0.5142	1.4600e-003	0.1150	8.2000e-004	0.1158	0.0305	7.6000e-004	0.0313		112.5175	112.5175	5.2400e-003		112.6276
Total	0.1666	1.1194	1.9072	4.7800e-003	0.2079	0.0170	0.2249	0.0570	0.0156	0.0726		435.2597	435.2597	7.6300e-003		435.4200

3.15 Axial 5 - Architectural Coatings - 2018

Unmitigated Construction On-Site

	ROG	NOx	CO	SO2	Fugitive PM10	Exhaust PM10	PM10 Total	Fugitive PM2.5	Exhaust PM2.5	PM2.5 Total	Bio- CO2	NBio- CO2	Total CO2	CH4	N2O	CO2e
Category	lb/day										lb/day					
Archit. Coating	0.3792					0.0000	0.0000		0.0000	0.0000			0.0000			0.0000
Off-Road	0.8785	6.7396	7.0791	0.0112		0.4399	0.4399		0.4369	0.4369		1,081.1233	1,081.1233	0.1742		1,084.7822
Total	1.2578	6.7396	7.0791	0.0112		0.4399	0.4399		0.4369	0.4369		1,081.1233	1,081.1233	0.1742		1,084.7822

Unmitigated Construction Off-Site

	ROG	NOx	CO	SO2	Fugitive PM10	Exhaust PM10	PM10 Total	Fugitive PM2.5	Exhaust PM2.5	PM2.5 Total	Bio- CO2	NBio- CO2	Total CO2	CH4	N2O	CO2e
Category	lb/day										lb/day					

Hauling	0.0000	0.0000	0.0000	0.0000	0.0000	0.0000	0.0000	0.0000	0.0000	0.0000	0.0000	0.0000	0.0000	0.0000	0.0000	0.0000
Vendor	0.0720	0.6124	0.7960	1.9000e-003	0.0531	9.2400e-003	0.0623	0.0152	8.5000e-003	0.0237		184.4241	184.4241	1.3700e-003		184.4528
Worker	0.0232	0.0272	0.2938	8.3000e-004	0.0657	4.7000e-004	0.0662	0.0174	4.3000e-004	0.0179		64.2957	64.2957	3.0000e-003		64.3586
Total	0.0952	0.6396	1.0898	2.7300e-003	0.1188	9.7100e-003	0.1285	0.0326	8.9300e-003	0.0415		248.7198	248.7198	4.3700e-003		248.8114

Mitigated Construction On-Site

	ROG	NOx	CO	SO2	Fugitive PM10	Exhaust PM10	PM10 Total	Fugitive PM2.5	Exhaust PM2.5	PM2.5 Total	Bio- CO2	NBio- CO2	Total CO2	CH4	N2O	CO2e
Category	lb/day										lb/day					
Archit. Coating	0.3792					0.0000	0.0000		0.0000	0.0000			0.0000			0.0000
Off-Road	0.8785	6.7396	7.0791	0.0112		0.4399	0.4399		0.4369	0.4369	0.0000	1,081.1233	1,081.1233	0.1742		1,084.7822
Total	1.2578	6.7396	7.0791	0.0112		0.4399	0.4399		0.4369	0.4369	0.0000	1,081.1233	1,081.1233	0.1742		1,084.7822

Mitigated Construction Off-Site

	ROG	NOx	CO	SO2	Fugitive PM10	Exhaust PM10	PM10 Total	Fugitive PM2.5	Exhaust PM2.5	PM2.5 Total	Bio- CO2	NBio- CO2	Total CO2	CH4	N2O	CO2e
Category	lb/day										lb/day					
Hauling	0.0000	0.0000	0.0000	0.0000	0.0000	0.0000	0.0000	0.0000	0.0000	0.0000		0.0000	0.0000	0.0000		0.0000
Vendor	0.0720	0.6124	0.7960	1.9000e-003	0.0531	9.2400e-003	0.0623	0.0152	8.5000e-003	0.0237		184.4241	184.4241	1.3700e-003		184.4528
Worker	0.0232	0.0272	0.2938	8.3000e-004	0.0657	4.7000e-004	0.0662	0.0174	4.3000e-004	0.0179		64.2957	64.2957	3.0000e-003		64.3586
Total	0.0952	0.6396	1.0898	2.7300e-003	0.1188	9.7100e-003	0.1285	0.0326	8.9300e-003	0.0415		248.7198	248.7198	4.3700e-003		248.8114

3.16 Intake 6b - Paving - 2018

Unmitigated Construction On-Site

	ROG	NOx	CO	SO2	Fugitive PM10	Exhaust PM10	PM10 Total	Fugitive PM2.5	Exhaust PM2.5	PM2.5 Total	Bio- CO2	NBio- CO2	Total CO2	CH4	N2O	CO2e
Category	lb/day										lb/day					
Off-Road	0.5715	5.9631	4.7495	7.1400e-003		0.3411	0.3411		0.3138	0.3138		718.8418	718.8418	0.2238		723.5413
Paving	0.0000					0.0000	0.0000		0.0000	0.0000			0.0000			0.0000
Total	0.5715	5.9631	4.7495	7.1400e-003		0.3411	0.3411		0.3138	0.3138		718.8418	718.8418	0.2238		723.5413

Unmitigated Construction Off-Site

	ROG	NOx	CO	SO2	Fugitive PM10	Exhaust PM10	PM10 Total	Fugitive PM2.5	Exhaust PM2.5	PM2.5 Total	Bio- CO2	NBio- CO2	Total CO2	CH4	N2O	CO2e
Category	lb/day										lb/day					
Hauling	0.0000	0.0000	0.0000	0.0000	0.0000	0.0000	0.0000	0.0000	0.0000	0.0000		0.0000	0.0000	0.0000		0.0000
Vendor	0.1260	1.0717	1.3930	3.3200e-003	0.0929	0.0162	0.1091	0.0265	0.0149	0.0414		322.7422	322.7422	2.3900e-003		322.7924
Worker	0.0406	0.0476	0.5142	1.4600e-003	0.1150	8.2000e-004	0.1158	0.0305	7.6000e-004	0.0313		112.5175	112.5175	5.2400e-003		112.6276
Total	0.1666	1.1194	1.9072	4.7800e-003	0.2079	0.0170	0.2249	0.0570	0.0156	0.0726		435.2597	435.2597	7.6300e-003		435.4200

Mitigated Construction On-Site

	ROG	NOx	CO	SO2	Fugitive PM10	Exhaust PM10	PM10 Total	Fugitive PM2.5	Exhaust PM2.5	PM2.5 Total	Bio- CO2	NBio- CO2	Total CO2	CH4	N2O	CO2e
Category	lb/day										lb/day					
Off-Road	0.5715	5.9631	4.7495	7.1400e-003		0.3411	0.3411		0.3138	0.3138	0.0000	718.8418	718.8418	0.2238		723.5413
Paving	0.0000					0.0000	0.0000		0.0000	0.0000			0.0000			0.0000
Total	0.5715	5.9631	4.7495	7.1400e-003		0.3411	0.3411		0.3138	0.3138	0.0000	718.8418	718.8418	0.2238		723.5413

Mitigated Construction Off-Site

	ROG	NOx	CO	SO2	Fugitive PM10	Exhaust PM10	PM10 Total	Fugitive PM2.5	Exhaust PM2.5	PM2.5 Total	Bio- CO2	NBio- CO2	Total CO2	CH4	N2O	CO2e
Category	lb/day										lb/day					
Hauling	0.0000	0.0000	0.0000	0.0000	0.0000	0.0000	0.0000	0.0000	0.0000	0.0000		0.0000	0.0000	0.0000		0.0000
Vendor	0.1260	1.0717	1.3930	3.3200e-003	0.0929	0.0162	0.1091	0.0265	0.0149	0.0414		322.7422	322.7422	2.3900e-003		322.7924
Worker	0.0406	0.0476	0.5142	1.4600e-003	0.1150	8.2000e-004	0.1158	0.0305	7.6000e-004	0.0313		112.5175	112.5175	5.2400e-003		112.6276
Total	0.1666	1.1194	1.9072	4.7800e-003	0.2079	0.0170	0.2249	0.0570	0.0156	0.0726		435.2597	435.2597	7.6300e-003		435.4200

Carlsbad Desal Plant Intake Modifications San Diego County, Winter

1.0 Project Characteristics

1.1 Land Usage

Land Uses	Size	Metric	Lot Acreage	Floor Surface Area	Population
User Defined Industrial	1.00	User Defined Unit	2.00	300.00	0

1.2 Other Project Characteristics

Urbanization	Urban	Wind Speed (m/s)	2.6	Precipitation Freq (Days)	40
Climate Zone	13			Operational Year	2018
Utility Company	San Diego Gas & Electric				
CO2 Intensity (lb/MWhr)	720.49	CH4 Intensity (lb/MWhr)	0.029	N2O Intensity (lb/MWhr)	0.006

1.3 User Entered Comments & Non-Default Data

Construction Phase - construction schedule per applicant

Off-road Equipment - Off-road Equipment - 9 off HW trucks = concrete and pump trucks

Off-road Equipment - all off-road equipment provided by project applicant

Grading - grading acreages per applicant

Demolition - demolition quantities per applicant

Trips and VMT - trips per applicant

Architectural coatings per SDACPD Rule 67.0.1

Construction Off-road Equipment Mitigation - water 3x per day

Table Name	Column Name	Default Value	New Value
tblArchitecturalCoating	EF_Nonresidential_Exterior	250.00	150.00
tblArchitecturalCoating	EF_Nonresidential_Interior	250.00	150.00

tblArchitecturalCoating	EF_Residential_Exterior	250.00	150.00
tblArchitecturalCoating	EF_Residential_Interior	250.00	150.00
tblConstructionPhase	NumDays	10.00	11.00
tblConstructionPhase	NumDays	200.00	20.00
tblConstructionPhase	NumDays	200.00	108.00
tblConstructionPhase	NumDays	200.00	60.00
tblConstructionPhase	NumDays	200.00	40.00
tblConstructionPhase	NumDays	20.00	6.00
tblConstructionPhase	NumDays	20.00	79.00
tblConstructionPhase	NumDays	4.00	5.00
tblConstructionPhase	NumDays	4.00	71.00
tblConstructionPhase	NumDays	10.00	20.00
tblConstructionPhase	NumDays	10.00	6.00
tblConstructionPhase	NumDays	10.00	11.00
tblConstructionPhase	NumDays	2.00	5.00
tblConstructionPhase	NumDays	2.00	30.00
tblConstructionPhase	PhaseEndDate	2/16/2018	2/9/2018
tblConstructionPhase	PhaseEndDate	2/22/2018	1/25/2018
tblConstructionPhase	PhaseEndDate	2/8/2018	11/2/2017
tblConstructionPhase	PhaseEndDate	12/27/2017	12/14/2017
tblConstructionPhase	PhaseEndDate	6/2/2017	6/3/2017
tblConstructionPhase	PhaseEndDate	2/19/2018	2/9/2018
tblConstructionPhase	PhaseEndDate	9/11/2017	9/7/2017
tblConstructionPhase	PhaseEndDate	9/16/2016	9/18/2016
tblConstructionPhase	PhaseEndDate	2/8/2018	1/25/2018
tblConstructionPhase	PhaseStartDate	2/2/2018	1/26/2018
tblConstructionPhase	PhaseStartDate	1/26/2018	12/29/2017
tblConstructionPhase	PhaseStartDate	12/15/2017	9/8/2017
tblConstructionPhase	PhaseStartDate	9/8/2017	8/26/2017
tblConstructionPhase	PhaseStartDate	2/10/2018	2/2/2018

tblConstructionPhase	PhaseStartDate	8/26/2017	8/24/2017
tblConstructionPhase	PhaseStartDate	12/29/2017	12/15/2017
tblGrading	AcresOfGrading	2.50	0.62
tblGrading	AcresOfGrading	0.00	1.00
tblGrading	AcresOfGrading	0.00	0.16
tblGrading	MaterialExported	0.00	9,700.00
tblGrading	MaterialImported	0.00	27.00
tblLandUse	LandUseSquareFeet	0.00	300.00
tblLandUse	LotAcreage	0.00	2.00
tblOffRoadEquipment	HorsePower	400.00	300.00
tblOffRoadEquipment	HorsePower	400.00	300.00
tblOffRoadEquipment	HorsePower	162.00	300.00
tblOffRoadEquipment	HorsePower	400.00	167.00
tblOffRoadEquipment	HorsePower	400.00	200.00
tblOffRoadEquipment	HorsePower	162.00	300.00
tblOffRoadEquipment	HorsePower	9.00	300.00
tblOffRoadEquipment	LoadFactor	0.36	0.36
tblOffRoadEquipment	LoadFactor	0.40	0.40
tblOffRoadEquipment	LoadFactor	0.38	0.38
tblOffRoadEquipment	LoadFactor	0.38	0.38
tblOffRoadEquipment	LoadFactor	0.50	0.50
tblOffRoadEquipment	LoadFactor	0.29	0.29
tblOffRoadEquipment	LoadFactor	0.36	0.36
tblOffRoadEquipment	LoadFactor	0.38	0.38
tblOffRoadEquipment	LoadFactor	0.38	0.38
tblOffRoadEquipment	LoadFactor	0.38	0.38
tblOffRoadEquipment	LoadFactor	0.31	0.31
tblOffRoadEquipment	LoadFactor	0.38	0.38
tblOffRoadEquipment	LoadFactor	0.38	0.38
tblOffRoadEquipment	LoadFactor	0.38	0.38

tblOffRoadEquipment	LoadFactor	0.29	0.29
tblOffRoadEquipment	LoadFactor	0.31	0.31
tblOffRoadEquipment	LoadFactor	0.38	0.38
tblOffRoadEquipment	LoadFactor	0.38	0.38
tblOffRoadEquipment	LoadFactor	0.38	0.38
tblOffRoadEquipment	LoadFactor	0.50	0.50
tblOffRoadEquipment	LoadFactor	0.36	0.36
tblOffRoadEquipment	LoadFactor	0.38	0.38
tblOffRoadEquipment	LoadFactor	0.38	0.38
tblOffRoadEquipment	LoadFactor	0.31	0.31
tblOffRoadEquipment	OffRoadEquipmentType		Rubber Tired Loaders
tblOffRoadEquipment	OffRoadEquipmentType		Rubber Tired Dozers
tblOffRoadEquipment	OffRoadEquipmentType		Excavators
tblOffRoadEquipment	OffRoadEquipmentType		Off-Highway Trucks
tblOffRoadEquipment	OffRoadEquipmentType		Bore/Drill Rigs
tblOffRoadEquipment	OffRoadEquipmentType		Pumps
tblOffRoadEquipment	OffRoadEquipmentType		Cranes
tblOffRoadEquipment	OffRoadEquipmentType		Rubber Tired Loaders
tblOffRoadEquipment	OffRoadEquipmentType		Pumps
tblOffRoadEquipment	OffRoadEquipmentType		Off-Highway Trucks
tblOffRoadEquipment	OffRoadEquipmentType		Excavators
tblOffRoadEquipment	OffRoadEquipmentType		Excavators
tblOffRoadEquipment	OffRoadEquipmentType		Aerial Lifts
tblOffRoadEquipment	OffRoadEquipmentType		Off-Highway Trucks
tblOffRoadEquipment	OffRoadEquipmentType		Pumps
tblOffRoadEquipment	OffRoadEquipmentType		Off-Highway Trucks
tblOffRoadEquipment	OffRoadEquipmentType		Off-Highway Trucks
tblOffRoadEquipment	OffRoadEquipmentType		Cranes
tblOffRoadEquipment	OffRoadEquipmentType		Pumps
tblOffRoadEquipment	OffRoadEquipmentType		Aerial Lifts

tblOffRoadEquipment	UsageHours	6.00	8.00
tblOffRoadEquipment	UsageHours	7.00	8.00
tblProjectCharacteristics	OperationalYear	2014	2018
tblTripsAndVMT	HaulingTripNumber	3.00	25.00
tblTripsAndVMT	HaulingTripNumber	9.00	25.00
tblTripsAndVMT	HaulingTripNumber	0.00	606.00
tblTripsAndVMT	HaulingTripNumber	1,213.00	606.00
tblTripsAndVMT	HaulingTripNumber	0.00	114.00
tblTripsAndVMT	HaulingTripNumber	7.00	22.00
tblTripsAndVMT	VendorTripNumber	0.00	4.00
tblTripsAndVMT	VendorTripNumber	0.00	16.00
tblTripsAndVMT	VendorTripNumber	0.00	4.00
tblTripsAndVMT	VendorTripNumber	0.00	20.00
tblTripsAndVMT	VendorTripNumber	0.00	14.00
tblTripsAndVMT	VendorTripNumber	0.00	8.00
tblTripsAndVMT	VendorTripNumber	0.00	14.00
tblTripsAndVMT	VendorTripNumber	0.00	4.00
tblTripsAndVMT	VendorTripNumber	0.00	20.00
tblTripsAndVMT	VendorTripNumber	0.00	20.00
tblTripsAndVMT	VendorTripNumber	0.00	14.00
tblTripsAndVMT	VendorTripNumber	0.00	18.00
tblTripsAndVMT	VendorTripNumber	0.00	4.00
tblTripsAndVMT	VendorTripNumber	0.00	20.00
tblTripsAndVMT	WorkerTripNumber	5.00	14.00
tblTripsAndVMT	WorkerTripNumber	5.00	14.00
tblTripsAndVMT	WorkerTripNumber	30.00	26.00
tblTripsAndVMT	WorkerTripNumber	0.00	26.00
tblTripsAndVMT	WorkerTripNumber	10.00	14.00
tblTripsAndVMT	WorkerTripNumber	0.00	8.00
tblTripsAndVMT	WorkerTripNumber	5.00	14.00

tblTripsAndVMT	WorkerTripNumber	8.00	14.00
tblTripsAndVMT	WorkerTripNumber	0.00	28.00
tblTripsAndVMT	WorkerTripNumber	23.00	28.00
tblTripsAndVMT	WorkerTripNumber	0.00	26.00
tblTripsAndVMT	WorkerTripNumber	5.00	12.00
tblTripsAndVMT	WorkerTripNumber	38.00	22.00
tblTripsAndVMT	WorkerTripNumber	0.00	16.00

2.0 Emissions Summary

2.1 Overall Construction (Maximum Daily Emission)

Unmitigated Construction

	ROG	NOx	CO	SO2	Fugitive PM10	Exhaust PM10	PM10 Total	Fugitive PM2.5	Exhaust PM2.5	PM2.5 Total	Bio- CO2	NBio- CO2	Total CO2	CH4	N2O	CO2e
Year	lb/day										lb/day					
2016	3.8934	37.4981	24.3499	0.0546	6.2855	1.8178	7.1707	3.3759	1.7579	4.1903	0.0000	5,403.7116	5,403.7116	0.9271	0.0000	5,423.1804
2017	17.1276	179.3461	98.6941	0.2434	0.5918	7.6161	8.2026	0.1588	7.1578	7.3166	0.0000	24,459.6712	24,459.6712	6.4005	0.0000	24,594.0811
2018	15.1156	153.7563	91.4701	0.2434	0.5865	6.4143	7.0008	0.1588	6.0338	6.1926	0.0000	24,118.5264	24,118.5264	6.3581	0.0000	24,252.0470
Total	36.1366	370.6005	214.5142	0.5415	7.4637	15.8482	22.3740	3.6935	14.9495	17.6994	0.0000	53,981.9091	53,981.9091	13.6857	0.0000	54,269.3085

Mitigated Construction

	ROG	NOx	CO	SO2	Fugitive PM10	Exhaust PM10	PM10 Total	Fugitive PM2.5	Exhaust PM2.5	PM2.5 Total	Bio- CO2	NBio- CO2	Total CO2	CH4	N2O	CO2e
Year	lb/day										lb/day					

2016	3.8934	37.4981	24.3499	0.0546	2.5908	1.8178	3.4760	1.3544	1.7579	2.1688	0.0000	5,403.7116	5,403.7116	0.9271	0.0000	5,423.1804
2017	17.1276	179.3461	98.6941	0.2434	0.5918	7.6161	8.2026	0.1588	7.1578	7.3166	0.0000	24,459.6712	24,459.6712	6.4005	0.0000	24,594.0811
2018	15.1156	153.7563	91.4701	0.2434	0.5865	6.4143	7.0008	0.1588	6.0338	6.1926	0.0000	24,118.5264	24,118.5264	6.3581	0.0000	24,252.0470
Total	36.1366	370.6005	214.5142	0.5415	3.7691	15.8482	18.6794	1.6719	14.9495	15.6779	0.0000	53,981.9091	53,981.9091	13.6857	0.0000	54,269.3085

	ROG	NOx	CO	SO2	Fugitive PM10	Exhaust PM10	PM10 Total	Fugitive PM2.5	Exhaust PM2.5	PM2.5 Total	Bio- CO2	NBio-CO2	Total CO2	CH4	N2O	CO2e
Percent Reduction	0.00	0.00	0.00	0.00	49.50	0.00	16.51	54.73	0.00	11.42	0.00	0.00	0.00	0.00	0.00	0.00

3.0 Construction Detail

Construction Phase

Phase Number	Phase Name	Phase Type	Start Date	End Date	Num Days Week	Num Days	Phase Description
1	Intake 1a - Site Prep	Site Preparation	9/12/2016	9/18/2016	5	5	
2	Intake 1b - Asphalt Removal	Demolition	9/19/2016	9/26/2016	5	6	
3	Intake 2a - Sheet Piling	Building Construction	9/27/2016	2/23/2017	5	108	
4	Intake 2b - Excavation	Grading	2/24/2017	6/3/2017	5	71	
5	Intake 3 - Building Construction	Building Construction	6/4/2017	8/25/2017	5	60	
6	Axial 1 - Paving	Paving	8/24/2017	9/7/2017	5	11	
7	Intake 4 - Demolition	Demolition	8/26/2017	12/14/2017	5	79	
8	Axial 2 - Pump Station Install	Building Construction	9/8/2017	11/2/2017	5	40	
9	Axial 3a - Trenching	Trenching	11/3/2017	11/30/2017	5	20	
10	Axial 3b - Paving	Paving	12/1/2017	12/28/2017	5	20	
11	Intake 5 - Backfill	Site Preparation	12/15/2017	1/25/2018	5	30	
12	Axial 4 - Building Construction	Building Construction	12/29/2017	1/25/2018	5	20	
13	Intake 6a - Grading	Grading	1/26/2018	2/1/2018	5	5	
14	Axial 5 - Architectural Coatings	Architectural Coating	1/26/2018	2/9/2018	5	11	
15	Intake 6b - Paving	Paving	2/2/2018	2/9/2018	5	6	

Acres of Grading (Site Preparation Phase): 0

Acres of Grading (Grading Phase): 0

Acres of Paving: 0

Residential Indoor: 0; Residential Outdoor: 0; Non-Residential Indoor: 450; Non-Residential Outdoor: 150 (Architectural Coating – sqft)

OffRoad Equipment

Phase Name	Offroad Equipment Type	Amount	Usage Hours	Horse Power	Load Factor
Intake 2a - Sheet Piling	Cranes	1	8.00	226	0.29
Intake 2b - Excavation	Tractors/Loaders/Backhoes	1	8.00	97	0.37
Intake 3 - Building Construction	Cranes	2	8.00	226	0.29
Axial 1 - Paving	Pavers	1	8.00	125	0.42
Axial 1 - Paving	Rollers	1	8.00	80	0.38
Intake 4 - Demolition	Concrete/Industrial Saws	1	8.00	81	0.73
Axial 2 - Pump Station Install	Cranes	2	8.00	226	0.29
Axial 3b - Paving	Pavers	1	8.00	125	0.42
Axial 3b - Paving	Rollers	1	8.00	80	0.38
Axial 4 - Building Construction	Cranes	1	8.00	226	0.29
Intake 6a - Grading	Graders	1	8.00	174	0.41
Axial 5 - Architectural Coatings	Air Compressors	2	8.00	78	0.48
Intake 6b - Paving	Pavers	1	8.00	125	0.42
Intake 6b - Paving	Rollers	1	8.00	80	0.38
Intake 1a - Site Prep	Rubber Tired Loaders	1	8.00	199	0.36
Intake 1a - Site Prep	Rubber Tired Dozers	1	8.00	255	0.40
Intake 1b - Asphalt Removal	Excavators	1	8.00	162	0.38
Intake 1b - Asphalt Removal	Off-Highway Trucks	2	8.00	300	0.38
Intake 2a - Sheet Piling	Bore/Drill Rigs	2	8.00	205	0.50
Intake 2a - Sheet Piling	Pumps	3	8.00	84	0.74
Intake 2b - Excavation	Cranes	1	8.00	226	0.29
Intake 2b - Excavation	Rubber Tired Loaders	1	8.00	199	0.36

Intake 2b - Excavation	Pumps	3	8.00	84	0.74
Intake 2b - Excavation	Off-Highway Trucks	2	8.00	300	0.38
Intake 2b - Excavation	Excavators	1	8.00	300	0.38
Intake 3 - Building Construction	Excavators	1	8.00	162	0.38
Intake 3 - Building Construction	Aerial Lifts	2	8.00	62	0.31
Intake 3 - Building Construction	Off-Highway Trucks	9	8.00	167	0.38
Intake 3 - Building Construction	Pumps	3	8.00	84	0.74
Intake 4 - Demolition	Off-Highway Trucks	1	8.00	200	0.38
Intake 4 - Demolition	Off-Highway Trucks	9	8.00	400	0.38
Intake 4 - Demolition	Cranes	1	8.00	226	0.29
Intake 4 - Demolition	Pumps	3	8.00	84	0.74
Axial 2 - Pump Station Install	Aerial Lifts	2	8.00	62	0.31
Axial 2 - Pump Station Install	Pumps	3	8.00	84	0.74
Axial 3a - Trenching	Excavators	1	8.00	300	0.38
Intake 5 - Backfill	Off-Highway Trucks	3	8.00	400	0.38
Intake 5 - Backfill	Cement and Mortar Mixers	1	8.00	300	0.56
Intake 5 - Backfill	Excavators	1	8.00	162	0.38
Intake 5 - Backfill	Bore/Drill Rigs	1	8.00	205	0.50
Intake 5 - Backfill	Rubber Tired Loaders	2	8.00	199	0.36
Intake 5 - Backfill	Rollers	1	8.00	80	0.38
Intake 5 - Backfill	Pumps	3	8.00	84	0.74
Axial 4 - Building Construction	Off-Highway Trucks	9	8.00	400	0.38
Axial 4 - Building Construction	Pumps	3	8.00	84	0.74
Intake 6a - Grading	Dumpers/Tenders	3	8.00	16	0.38
Axial 5 - Architectural Coatings	Aerial Lifts	2	8.00	62	0.31

Trips and VMT

Phase Name	Offroad Equipment Count	Worker Trip Number	Vendor Trip Number	Hauling Trip Number	Worker Trip Length	Vendor Trip Length	Hauling Trip Length	Worker Vehicle Class	Vendor Vehicle Class	Hauling Vehicle Class
Intake 1a - Site Prep	2	14.00	4.00	25.00	10.80	7.30	20.00	LD_Mix	HDT_Mix	HHDT

Intake 1b - Asphalt Removal	3	14.00	4.00	25.00	10.80	7.30	20.00	LD_Mix	HDT_Mix	HHDT
Intake 2a - Sheet Piling	6	28.00	20.00	606.00	10.80	7.30	20.00	LD_Mix	HDT_Mix	HHDT
Intake 2b - Excavation	9	28.00	20.00	606.00	10.80	7.30	20.00	LD_Mix	HDT_Mix	HHDT
Intake 3 - Building Construction	17	26.00	14.00	114.00	10.80	7.30	20.00	LD_Mix	HDT_Mix	HHDT
Axial 1 - Paving	2	12.00	18.00	0.00	10.80	7.30	20.00	LD_Mix	HDT_Mix	HHDT
Intake 4 - Demolition	15	22.00	4.00	22.00	10.80	7.30	20.00	LD_Mix	HDT_Mix	HHDT
Axial 2 - Pump Station Install	7	16.00	20.00	0.00	10.80	7.30	20.00	LD_Mix	HDT_Mix	HHDT
Axial 3a - Trenching	1	3.00	0.00	0.00	10.80	7.30	20.00	LD_Mix	HDT_Mix	HHDT
Axial 3b - Paving	2	14.00	16.00	0.00	10.80	7.30	20.00	LD_Mix	HDT_Mix	HHDT
Intake 5 - Backfill	12	26.00	4.00	0.00	10.80	7.30	20.00	LD_Mix	HDT_Mix	HHDT
Axial 4 - Building Construction	13	26.00	20.00	0.00	10.80	7.30	20.00	LD_Mix	HDT_Mix	HHDT
Intake 6a - Grading	4	14.00	14.00	0.00	10.80	7.30	20.00	LD_Mix	HDT_Mix	HHDT
Axial 5 - Architectural Coatings	4	8.00	8.00	0.00	10.80	7.30	20.00	LD_Mix	HDT_Mix	HHDT
Intake 6b - Paving	2	14.00	14.00	0.00	10.80	7.30	20.00	LD_Mix	HDT_Mix	HHDT

3.1 Mitigation Measures Construction

Water Exposed Area

3.2 Intake 1a - Site Prep - 2016

Unmitigated Construction On-Site

	ROG	NOx	CO	SO2	Fugitive PM10	Exhaust PM10	PM10 Total	Fugitive PM2.5	Exhaust PM2.5	PM2.5 Total	Bio- CO2	NBio- CO2	Total CO2	CH4	N2O	CO2e
Category	lb/day										lb/day					
Fugitive Dust					6.0568	0.0000	6.0568	3.3140	0.0000	3.3140			0.0000			0.0000
Off-Road	1.7231	20.2030	12.2057	0.0149		0.8593	0.8593		0.7906	0.7906		1,552.1374	1,552.1374	0.4682		1,561.9692
Total	1.7231	20.2030	12.2057	0.0149	6.0568	0.8593	6.9161	3.3140	0.7906	4.1046		1,552.1374	1,552.1374	0.4682		1,561.9692

Unmitigated Construction Off-Site

	ROG	NOx	CO	SO2	Fugitive PM10	Exhaust PM10	PM10 Total	Fugitive PM2.5	Exhaust PM2.5	PM2.5 Total	Bio- CO2	NBio- CO2	Total CO2	CH4	N2O	CO2e
Category	lb/day										lb/day					
Hauling	0.1091	1.4464	1.2922	3.7400e-003	0.0871	0.0192	0.1063	0.0239	0.0177	0.0415		375.9549	375.9549	2.7200e-003		376.0119
Vendor	0.0483	0.3883	0.5989	9.5000e-004	0.0266	5.7900e-003	0.0323	7.5700e-003	5.3300e-003	0.0129		94.7037	94.7037	7.6000e-004		94.7196
Worker	0.0519	0.0644	0.6085	1.3700e-003	0.1150	8.6000e-004	0.1159	0.0305	7.9000e-004	0.0313		114.1940	114.1940	6.0900e-003		114.3219
Total	0.2092	1.8991	2.4995	6.0600e-003	0.2287	0.0259	0.2545	0.0619	0.0238	0.0857		584.8526	584.8526	9.5700e-003		585.0534

Mitigated Construction On-Site

	ROG	NOx	CO	SO2	Fugitive PM10	Exhaust PM10	PM10 Total	Fugitive PM2.5	Exhaust PM2.5	PM2.5 Total	Bio- CO2	NBio- CO2	Total CO2	CH4	N2O	CO2e
Category	lb/day										lb/day					
Fugitive Dust					2.3621	0.0000	2.3621	1.2925	0.0000	1.2925			0.0000			0.0000
Off-Road	1.7231	20.2030	12.2057	0.0149		0.8593	0.8593		0.7906	0.7906	0.0000	1,552.1374	1,552.1374	0.4682		1,561.9692
Total	1.7231	20.2030	12.2057	0.0149	2.3621	0.8593	3.2215	1.2925	0.7906	2.0831	0.0000	1,552.1374	1,552.1374	0.4682		1,561.9692

Mitigated Construction Off-Site

	ROG	NOx	CO	SO2	Fugitive PM10	Exhaust PM10	PM10 Total	Fugitive PM2.5	Exhaust PM2.5	PM2.5 Total	Bio- CO2	NBio- CO2	Total CO2	CH4	N2O	CO2e
--	-----	-----	----	-----	---------------	--------------	------------	----------------	---------------	-------------	----------	-----------	-----------	-----	-----	------

Category	lb/day										lb/day					
Hauling	0.1091	1.4464	1.2922	3.7400e-003	0.0871	0.0192	0.1063	0.0239	0.0177	0.0415		375.9549	375.9549	2.7200e-003		376.0119
Vendor	0.0483	0.3883	0.5989	9.5000e-004	0.0266	5.7900e-003	0.0323	7.5700e-003	5.3300e-003	0.0129		94.7037	94.7037	7.6000e-004		94.7196
Worker	0.0519	0.0644	0.6085	1.3700e-003	0.1150	8.6000e-004	0.1159	0.0305	7.9000e-004	0.0313		114.1940	114.1940	6.0900e-003		114.3219
Total	0.2092	1.8991	2.4995	6.0600e-003	0.2287	0.0259	0.2545	0.0619	0.0238	0.0857		584.8526	584.8526	9.5700e-003		585.0534

3.3 Intake 1b - Asphalt Removal - 2016

Unmitigated Construction On-Site

	ROG	NOx	CO	SO2	Fugitive PM10	Exhaust PM10	PM10 Total	Fugitive PM2.5	Exhaust PM2.5	PM2.5 Total	Bio- CO2	NBio- CO2	Total CO2	CH4	N2O	CO2e
Category	lb/day										lb/day					
Fugitive Dust					0.3322	0.0000	0.3322	0.0503	0.0000	0.0503			0.0000			0.0000
Off-Road	1.8101	20.8123	11.0644	0.0252		0.8363	0.8363		0.7694	0.7694		2,613.1858	2,613.1858	0.7882		2,629.7386
Total	1.8101	20.8123	11.0644	0.0252	0.3322	0.8363	1.1685	0.0503	0.7694	0.8197		2,613.1858	2,613.1858	0.7882		2,629.7386

Unmitigated Construction Off-Site

	ROG	NOx	CO	SO2	Fugitive PM10	Exhaust PM10	PM10 Total	Fugitive PM2.5	Exhaust PM2.5	PM2.5 Total	Bio- CO2	NBio- CO2	Total CO2	CH4	N2O	CO2e
Category	lb/day										lb/day					
Hauling	0.0909	1.2053	1.0768	3.1100e-003	0.0726	0.0160	0.0886	0.0199	0.0147	0.0346		313.2957	313.2957	2.2600e-003		313.3433
Vendor	0.0483	0.3883	0.5989	9.5000e-004	0.0266	5.7900e-003	0.0323	7.5700e-003	5.3300e-003	0.0129		94.7037	94.7037	7.6000e-004		94.7196
Worker	0.0519	0.0644	0.6085	1.3700e-003	0.1150	8.6000e-004	0.1159	0.0305	7.9000e-004	0.0313		114.1940	114.1940	6.0900e-003		114.3219

Total	0.1911	1.6580	2.2841	5.4300e-003	0.2142	0.0227	0.2368	0.0580	0.0208	0.0788		522.1934	522.1934	9.1100e-003		522.3848
--------------	---------------	---------------	---------------	--------------------	---------------	---------------	---------------	---------------	---------------	---------------	--	-----------------	-----------------	--------------------	--	-----------------

Mitigated Construction On-Site

	ROG	NOx	CO	SO2	Fugitive PM10	Exhaust PM10	PM10 Total	Fugitive PM2.5	Exhaust PM2.5	PM2.5 Total	Bio- CO2	NBio- CO2	Total CO2	CH4	N2O	CO2e
Category	lb/day										lb/day					
Fugitive Dust					0.1296	0.0000	0.1296	0.0196	0.0000	0.0196			0.0000			0.0000
Off-Road	1.8101	20.8123	11.0644	0.0252		0.8363	0.8363		0.7694	0.7694	0.0000	2,613.1858	2,613.1858	0.7882		2,629.7386
Total	1.8101	20.8123	11.0644	0.0252	0.1296	0.8363	0.9659	0.0196	0.7694	0.7890	0.0000	2,613.1858	2,613.1858	0.7882		2,629.7386

Mitigated Construction Off-Site

	ROG	NOx	CO	SO2	Fugitive PM10	Exhaust PM10	PM10 Total	Fugitive PM2.5	Exhaust PM2.5	PM2.5 Total	Bio- CO2	NBio- CO2	Total CO2	CH4	N2O	CO2e
Category	lb/day										lb/day					
Hauling	0.0909	1.2053	1.0768	3.1100e-003	0.0726	0.0160	0.0886	0.0199	0.0147	0.0346		313.2957	313.2957	2.2600e-003		313.3433
Vendor	0.0483	0.3883	0.5989	9.5000e-004	0.0266	5.7900e-003	0.0323	7.5700e-003	5.3300e-003	0.0129		94.7037	94.7037	7.6000e-004		94.7196
Worker	0.0519	0.0644	0.6085	1.3700e-003	0.1150	8.6000e-004	0.1159	0.0305	7.9000e-004	0.0313		114.1940	114.1940	6.0900e-003		114.3219
Total	0.1911	1.6580	2.2841	5.4300e-003	0.2142	0.0227	0.2368	0.0580	0.0208	0.0788		522.1934	522.1934	9.1100e-003		522.3848

3.4 Intake 2a - Sheet Piling - 2016

Unmitigated Construction On-Site

	ROG	NOx	CO	SO2	Fugitive PM10	Exhaust PM10	PM10 Total	Fugitive PM2.5	Exhaust PM2.5	PM2.5 Total	Bio- CO2	NBio- CO2	Total CO2	CH4	N2O	CO2e
Category	lb/day										lb/day					
Off-Road	3.4259	33.8047	18.6887	0.0430		1.7656	1.7656		1.7099	1.7099		4,279.9002	4,279.9002	0.9081		4,298.9698
Total	3.4259	33.8047	18.6887	0.0430		1.7656	1.7656		1.7099	1.7099		4,279.9002	4,279.9002	0.9081		4,298.9698

Unmitigated Construction Off-Site

	ROG	NOx	CO	SO2	Fugitive PM10	Exhaust PM10	PM10 Total	Fugitive PM2.5	Exhaust PM2.5	PM2.5 Total	Bio- CO2	NBio- CO2	Total CO2	CH4	N2O	CO2e
Category	lb/day										lb/day					
Hauling	0.1224	1.6232	1.4501	4.1900e-003	0.1397	0.0215	0.1612	0.0371	0.0198	0.0569		421.9049	421.9049	3.0500e-003		421.9689
Vendor	0.2414	1.9414	2.9942	4.7400e-003	0.1328	0.0290	0.1617	0.0379	0.0266	0.0645		473.5184	473.5184	3.7800e-003		473.5978
Worker	0.1038	0.1289	1.2170	2.7400e-003	0.2300	1.7300e-003	0.2317	0.0610	1.5900e-003	0.0626		228.3880	228.3880	0.0122		228.6439
Total	0.4675	3.6934	5.6613	0.0117	0.5025	0.0522	0.5547	0.1359	0.0480	0.1840		1,123.8113	1,123.8113	0.0190		1,124.2106

Mitigated Construction On-Site

	ROG	NOx	CO	SO2	Fugitive PM10	Exhaust PM10	PM10 Total	Fugitive PM2.5	Exhaust PM2.5	PM2.5 Total	Bio- CO2	NBio- CO2	Total CO2	CH4	N2O	CO2e
Category	lb/day										lb/day					

Off-Road	3.4259	33.8047	18.6887	0.0430		1.7656	1.7656		1.7099	1.7099	0.0000	4,279.9002	4,279.9002	0.9081		4,298.9698
Total	3.4259	33.8047	18.6887	0.0430		1.7656	1.7656		1.7099	1.7099	0.0000	4,279.9002	4,279.9002	0.9081		4,298.9698

Mitigated Construction Off-Site

	ROG	NOx	CO	SO2	Fugitive PM10	Exhaust PM10	PM10 Total	Fugitive PM2.5	Exhaust PM2.5	PM2.5 Total	Bio- CO2	NBio- CO2	Total CO2	CH4	N2O	CO2e
Category	lb/day										lb/day					
Hauling	0.1224	1.6232	1.4501	4.1900e-003	0.1397	0.0215	0.1612	0.0371	0.0198	0.0569		421.9049	421.9049	3.0500e-003		421.9689
Vendor	0.2414	1.9414	2.9942	4.7400e-003	0.1328	0.0290	0.1617	0.0379	0.0266	0.0645		473.5184	473.5184	3.7800e-003		473.5978
Worker	0.1038	0.1289	1.2170	2.7400e-003	0.2300	1.7300e-003	0.2317	0.0610	1.5900e-003	0.0626		228.3880	228.3880	0.0122		228.6439
Total	0.4675	3.6934	5.6613	0.0117	0.5025	0.0522	0.5547	0.1359	0.0480	0.1840		1,123.8113	1,123.8113	0.0190		1,124.2106

3.4 Intake 2a - Sheet Piling - 2017

Unmitigated Construction On-Site

	ROG	NOx	CO	SO2	Fugitive PM10	Exhaust PM10	PM10 Total	Fugitive PM2.5	Exhaust PM2.5	PM2.5 Total	Bio- CO2	NBio- CO2	Total CO2	CH4	N2O	CO2e
Category	lb/day										lb/day					
Off-Road	3.0742	30.4518	18.2559	0.0430		1.5503	1.5503		1.5018	1.5018		4,241.8711	4,241.8711	0.8882		4,260.5227
Total	3.0742	30.4518	18.2559	0.0430		1.5503	1.5503		1.5018	1.5018		4,241.8711	4,241.8711	0.8882		4,260.5227

Unmitigated Construction Off-Site

	ROG	NOx	CO	SO2	Fugitive PM10	Exhaust PM10	PM10 Total	Fugitive PM2.5	Exhaust PM2.5	PM2.5 Total	Bio- CO2	NBio- CO2	Total CO2	CH4	N2O	CO2e
Category	lb/day										lb/day					
Hauling	0.1143	1.4473	1.3914	4.1800e-003	0.2290	0.0189	0.2480	0.0590	0.0174	0.0764		414.7182	414.7182	2.9200e-003		414.7795
Vendor	0.2205	1.7351	2.8360	4.7300e-003	0.1328	0.0251	0.1579	0.0379	0.0231	0.0610		465.5077	465.5077	3.5800e-003		465.5829
Worker	0.0940	0.1171	1.0953	2.7400e-003	0.2300	1.6700e-003	0.2317	0.0610	1.5400e-003	0.0626		219.5615	219.5615	0.0113		219.7982
Total	0.4288	3.2996	5.3226	0.0117	0.5918	0.0457	0.6375	0.1579	0.0421	0.1999		1,099.7874	1,099.7874	0.0178		1,100.1606

Mitigated Construction On-Site

	ROG	NOx	CO	SO2	Fugitive PM10	Exhaust PM10	PM10 Total	Fugitive PM2.5	Exhaust PM2.5	PM2.5 Total	Bio- CO2	NBio- CO2	Total CO2	CH4	N2O	CO2e
Category	lb/day										lb/day					
Off-Road	3.0742	30.4518	18.2559	0.0430		1.5503	1.5503		1.5018	1.5018	0.0000	4,241.8711	4,241.8711	0.8882		4,260.5227
Total	3.0742	30.4518	18.2559	0.0430		1.5503	1.5503		1.5018	1.5018	0.0000	4,241.8711	4,241.8711	0.8882		4,260.5227

Mitigated Construction Off-Site

	ROG	NOx	CO	SO2	Fugitive PM10	Exhaust PM10	PM10 Total	Fugitive PM2.5	Exhaust PM2.5	PM2.5 Total	Bio- CO2	NBio- CO2	Total CO2	CH4	N2O	CO2e
--	-----	-----	----	-----	---------------	--------------	------------	----------------	---------------	-------------	----------	-----------	-----------	-----	-----	------

Category	lb/day										lb/day					
Hauling	0.1143	1.4473	1.3914	4.1800e-003	0.2290	0.0189	0.2480	0.0590	0.0174	0.0764		414.7182	414.7182	2.9200e-003		414.7795
Vendor	0.2205	1.7351	2.8360	4.7300e-003	0.1328	0.0251	0.1579	0.0379	0.0231	0.0610		465.5077	465.5077	3.5800e-003		465.5829
Worker	0.0940	0.1171	1.0953	2.7400e-003	0.2300	1.6700e-003	0.2317	0.0610	1.5400e-003	0.0626		219.5615	219.5615	0.0113		219.7982
Total	0.4288	3.2996	5.3226	0.0117	0.5918	0.0457	0.6375	0.1579	0.0421	0.1999		1,099.7874	1,099.7874	0.0178		1,100.1606

3.5 Intake 2b - Excavation - 2017

Unmitigated Construction On-Site

	ROG	NOx	CO	SO2	Fugitive PM10	Exhaust PM10	PM10 Total	Fugitive PM2.5	Exhaust PM2.5	PM2.5 Total	Bio- CO2	NBio- CO2	Total CO2	CH4	N2O	CO2e
Category	lb/day										lb/day					
Fugitive Dust					0.0341	0.0000	0.0341	4.5200e-003	0.0000	4.5200e-003			0.0000			0.0000
Off-Road	4.9478	50.2120	27.9116	0.0643		2.4334	2.4334		2.3143	2.3143		6,420.9609	6,420.9609	1.5558		6,453.6335
Total	4.9478	50.2120	27.9116	0.0643	0.0341	2.4334	2.4676	4.5200e-003	2.3143	2.3188		6,420.9609	6,420.9609	1.5558		6,453.6335

Unmitigated Construction Off-Site

	ROG	NOx	CO	SO2	Fugitive PM10	Exhaust PM10	PM10 Total	Fugitive PM2.5	Exhaust PM2.5	PM2.5 Total	Bio- CO2	NBio- CO2	Total CO2	CH4	N2O	CO2e
Category	lb/day										lb/day					
Hauling	0.1738	2.2015	2.1164	6.3700e-003	0.1487	0.0288	0.1775	0.0407	0.0265	0.0672		630.8389	630.8389	4.4400e-003		630.9321
Vendor	0.2205	1.7351	2.8360	4.7300e-003	0.1328	0.0251	0.1579	0.0379	0.0231	0.0610		465.5077	465.5077	3.5800e-003		465.5829
Worker	0.0940	0.1171	1.0953	2.7400e-003	0.2300	1.6700e-003	0.2317	0.0610	1.5400e-003	0.0626		219.5615	219.5615	0.0113		219.7982

Total	0.4884	4.0538	6.0477	0.0138	0.5115	0.0556	0.5671	0.1396	0.0511	0.1908		1,315.9081	1,315.9081	0.0193		1,316.3132
--------------	---------------	---------------	---------------	---------------	---------------	---------------	---------------	---------------	---------------	---------------	--	-------------------	-------------------	---------------	--	-------------------

Mitigated Construction On-Site

	ROG	NOx	CO	SO2	Fugitive PM10	Exhaust PM10	PM10 Total	Fugitive PM2.5	Exhaust PM2.5	PM2.5 Total	Bio- CO2	NBio- CO2	Total CO2	CH4	N2O	CO2e
Category	lb/day										lb/day					
Fugitive Dust					0.0133	0.0000	0.0133	1.7600e-003	0.0000	1.7600e-003			0.0000			0.0000
Off-Road	4.9478	50.2120	27.9116	0.0643		2.4334	2.4334		2.3143	2.3143	0.0000	6,420.9609	6,420.9609	1.5558		6,453.6335
Total	4.9478	50.2120	27.9116	0.0643	0.0133	2.4334	2.4467	1.7600e-003	2.3143	2.3160	0.0000	6,420.9609	6,420.9609	1.5558		6,453.6335

Mitigated Construction Off-Site

	ROG	NOx	CO	SO2	Fugitive PM10	Exhaust PM10	PM10 Total	Fugitive PM2.5	Exhaust PM2.5	PM2.5 Total	Bio- CO2	NBio- CO2	Total CO2	CH4	N2O	CO2e
Category	lb/day										lb/day					
Hauling	0.1738	2.2015	2.1164	6.3700e-003	0.1487	0.0288	0.1775	0.0407	0.0265	0.0672		630.8389	630.8389	4.4400e-003		630.9321
Vendor	0.2205	1.7351	2.8360	4.7300e-003	0.1328	0.0251	0.1579	0.0379	0.0231	0.0610		465.5077	465.5077	3.5800e-003		465.5829
Worker	0.0940	0.1171	1.0953	2.7400e-003	0.2300	1.6700e-003	0.2317	0.0610	1.5400e-003	0.0626		219.5615	219.5615	0.0113		219.7982
Total	0.4884	4.0538	6.0477	0.0138	0.5115	0.0556	0.5671	0.1396	0.0511	0.1908		1,315.9081	1,315.9081	0.0193		1,316.3132

3.6 Intake 3 - Building Construction - 2017

Unmitigated Construction On-Site

	ROG	NOx	CO	SO2	Fugitive PM10	Exhaust PM10	PM10 Total	Fugitive PM2.5	Exhaust PM2.5	PM2.5 Total	Bio- CO2	NBio- CO2	Total CO2	CH4	N2O	CO2e
Category	lb/day										lb/day					
Off-Road	8.0195	77.5010	57.3801	0.0887		4.2475	4.2475		3.9832	3.9832		8,923.9578	8,923.9578	2.3228		8,972.7356
Total	8.0195	77.5010	57.3801	0.0887		4.2475	4.2475		3.9832	3.9832		8,923.9578	8,923.9578	2.3228		8,972.7356

Unmitigated Construction Off-Site

	ROG	NOx	CO	SO2	Fugitive PM10	Exhaust PM10	PM10 Total	Fugitive PM2.5	Exhaust PM2.5	PM2.5 Total	Bio- CO2	NBio- CO2	Total CO2	CH4	N2O	CO2e
Category	lb/day										lb/day					
Hauling	0.0387	0.4901	0.4711	1.4200e-003	0.0331	6.4100e-003	0.0395	9.0700e-003	5.9000e-003	0.0150		140.4293	140.4293	9.9000e-004		140.4501
Vendor	0.1544	1.2146	1.9852	3.3100e-003	0.0929	0.0176	0.1105	0.0265	0.0162	0.0427		325.8554	325.8554	2.5100e-003		325.9080
Worker	0.0873	0.1088	1.0170	2.5400e-003	0.2136	1.5500e-003	0.2151	0.0567	1.4300e-003	0.0581		203.8785	203.8785	0.0105		204.0984
Total	0.2804	1.8134	3.4734	7.2700e-003	0.3396	0.0256	0.3652	0.0922	0.0235	0.1157		670.1633	670.1633	0.0140		670.4565

Mitigated Construction On-Site

	ROG	NOx	CO	SO2	Fugitive PM10	Exhaust PM10	PM10 Total	Fugitive PM2.5	Exhaust PM2.5	PM2.5 Total	Bio- CO2	NBio- CO2	Total CO2	CH4	N2O	CO2e
Category	lb/day										lb/day					

Off-Road	8.0195	77.5010	57.3801	0.0887		4.2475	4.2475		3.9832	3.9832	0.0000	8,923.9578	8,923.9578	2.3228		8,972.7356
Total	8.0195	77.5010	57.3801	0.0887		4.2475	4.2475		3.9832	3.9832	0.0000	8,923.9578	8,923.9578	2.3228		8,972.7356

Mitigated Construction Off-Site

	ROG	NOx	CO	SO2	Fugitive PM10	Exhaust PM10	PM10 Total	Fugitive PM2.5	Exhaust PM2.5	PM2.5 Total	Bio- CO2	NBio- CO2	Total CO2	CH4	N2O	CO2e
Category	lb/day										lb/day					
Hauling	0.0387	0.4901	0.4711	1.4200e-003	0.0331	6.4100e-003	0.0395	9.0700e-003	5.9000e-003	0.0150		140.4293	140.4293	9.9000e-004		140.4501
Vendor	0.1544	1.2146	1.9852	3.3100e-003	0.0929	0.0176	0.1105	0.0265	0.0162	0.0427		325.8554	325.8554	2.5100e-003		325.9080
Worker	0.0873	0.1088	1.0170	2.5400e-003	0.2136	1.5500e-003	0.2151	0.0567	1.4300e-003	0.0581		203.8785	203.8785	0.0105		204.0984
Total	0.2804	1.8134	3.4734	7.2700e-003	0.3396	0.0256	0.3652	0.0922	0.0235	0.1157		670.1633	670.1633	0.0140		670.4565

3.7 Axial 1 - Paving - 2017

Unmitigated Construction On-Site

	ROG	NOx	CO	SO2	Fugitive PM10	Exhaust PM10	PM10 Total	Fugitive PM2.5	Exhaust PM2.5	PM2.5 Total	Bio- CO2	NBio- CO2	Total CO2	CH4	N2O	CO2e
Category	lb/day										lb/day					
Off-Road	0.6710	6.9321	4.8269	7.1400e-003		0.4086	0.4086		0.3759	0.3759		730.1781	730.1781	0.2237		734.8764
Paving	0.0000					0.0000	0.0000		0.0000	0.0000			0.0000			0.0000
Total	0.6710	6.9321	4.8269	7.1400e-003		0.4086	0.4086		0.3759	0.3759		730.1781	730.1781	0.2237		734.8764

Unmitigated Construction Off-Site

	ROG	NOx	CO	SO2	Fugitive PM10	Exhaust PM10	PM10 Total	Fugitive PM2.5	Exhaust PM2.5	PM2.5 Total	Bio- CO2	NBio- CO2	Total CO2	CH4	N2O	CO2e
Category	lb/day										lb/day					
Hauling	0.0000	0.0000	0.0000	0.0000	0.0000	0.0000	0.0000	0.0000	0.0000	0.0000		0.0000	0.0000	0.0000		0.0000
Vendor	0.1985	1.5616	2.5524	4.2500e-003	0.1195	0.0226	0.1421	0.0341	0.0208	0.0549		418.9570	418.9570	3.2200e-003		419.0246
Worker	0.0403	0.0502	0.4694	1.1700e-003	0.0986	7.2000e-004	0.0993	0.0262	6.6000e-004	0.0268		94.0978	94.0978	4.8300e-003		94.1992
Total	0.2388	1.6118	3.0218	5.4200e-003	0.2181	0.0233	0.2414	0.0602	0.0215	0.0817		513.0547	513.0547	8.0500e-003		513.2239

Mitigated Construction On-Site

	ROG	NOx	CO	SO2	Fugitive PM10	Exhaust PM10	PM10 Total	Fugitive PM2.5	Exhaust PM2.5	PM2.5 Total	Bio- CO2	NBio- CO2	Total CO2	CH4	N2O	CO2e
Category	lb/day										lb/day					
Off-Road	0.6710	6.9321	4.8269	7.1400e-003		0.4086	0.4086		0.3759	0.3759	0.0000	730.1781	730.1781	0.2237		734.8764
Paving	0.0000					0.0000	0.0000		0.0000	0.0000			0.0000			0.0000
Total	0.6710	6.9321	4.8269	7.1400e-003		0.4086	0.4086		0.3759	0.3759	0.0000	730.1781	730.1781	0.2237		734.8764

Mitigated Construction Off-Site

	ROG	NOx	CO	SO2	Fugitive PM10	Exhaust PM10	PM10 Total	Fugitive PM2.5	Exhaust PM2.5	PM2.5 Total	Bio- CO2	NBio- CO2	Total CO2	CH4	N2O	CO2e
--	-----	-----	----	-----	---------------	--------------	------------	----------------	---------------	-------------	----------	-----------	-----------	-----	-----	------

Category	lb/day										lb/day				
Hauling	0.0000	0.0000	0.0000	0.0000	0.0000	0.0000	0.0000	0.0000	0.0000	0.0000	0.0000	0.0000	0.0000	0.0000	0.0000
Vendor	0.1985	1.5616	2.5524	4.2500e-003	0.1195	0.0226	0.1421	0.0341	0.0208	0.0549	418.9570	418.9570	3.2200e-003	419.0246	
Worker	0.0403	0.0502	0.4694	1.1700e-003	0.0986	7.2000e-004	0.0993	0.0262	6.6000e-004	0.0268	94.0978	94.0978	4.8300e-003	94.1992	
Total	0.2388	1.6118	3.0218	5.4200e-003	0.2181	0.0233	0.2414	0.0602	0.0215	0.0817	513.0547	513.0547	8.0500e-003	513.2239	

3.8 Intake 4 - Demolition - 2017

Unmitigated Construction On-Site

	ROG	NOx	CO	SO2	Fugitive PM10	Exhaust PM10	PM10 Total	Fugitive PM2.5	Exhaust PM2.5	PM2.5 Total	Bio- CO2	NBio- CO2	Total CO2	CH4	N2O	CO2e
Category	lb/day										lb/day					
Fugitive Dust					0.0198	0.0000	0.0198	2.9900e-003	0.0000	2.9900e-003			0.0000			0.0000
Off-Road	11.4695	120.3359	62.7225	0.1570		5.1476	5.1476		4.8358	4.8358		15,860.6209	15,860.6209	4.3187		15,951.3133
Total	11.4695	120.3359	62.7225	0.1570	0.0198	5.1476	5.1673	2.9900e-003	4.8358	4.8388		15,860.6209	15,860.6209	4.3187		15,951.3133

Unmitigated Construction Off-Site

	ROG	NOx	CO	SO2	Fugitive PM10	Exhaust PM10	PM10 Total	Fugitive PM2.5	Exhaust PM2.5	PM2.5 Total	Bio- CO2	NBio- CO2	Total CO2	CH4	N2O	CO2e
Category	lb/day										lb/day					
Hauling	5.6700e-003	0.0718	0.0691	2.1000e-004	4.8500e-003	9.4000e-004	5.7900e-003	1.3300e-003	8.6000e-004	2.1900e-003		20.5826	20.5826	1.4000e-004		20.5856
Vendor	0.0441	0.3470	0.5672	9.5000e-004	0.0266	5.0300e-003	0.0316	7.5800e-003	4.6200e-003	0.0122		93.1016	93.1016	7.2000e-004		93.1166
Worker	0.0739	0.0920	0.8606	2.1500e-003	0.1807	1.3100e-003	0.1820	0.0479	1.2100e-003	0.0492		172.5126	172.5126	8.8600e-003		172.6986

Total	0.1236	0.5109	1.4968	3.3100e-003	0.2121	7.2800e-003	0.2194	0.0569	6.6900e-003	0.0635		286.1967	286.1967	9.7200e-003		286.4008
--------------	---------------	---------------	---------------	--------------------	---------------	--------------------	---------------	---------------	--------------------	---------------	--	-----------------	-----------------	--------------------	--	-----------------

Mitigated Construction On-Site

	ROG	NOx	CO	SO2	Fugitive PM10	Exhaust PM10	PM10 Total	Fugitive PM2.5	Exhaust PM2.5	PM2.5 Total	Bio- CO2	NBio- CO2	Total CO2	CH4	N2O	CO2e	
Category	lb/day										lb/day						
Fugitive Dust					7.7000e-003	0.0000	7.7000e-003	1.1700e-003	0.0000	1.1700e-003			0.0000				0.0000
Off-Road	11.4695	120.3359	62.7225	0.1570		5.1476	5.1476		4.8358	4.8358	0.0000	15,860.6209	15,860.6209	4.3187			15,951.3133
Total	11.4695	120.3359	62.7225	0.1570	7.7000e-003	5.1476	5.1553	1.1700e-003	4.8358	4.8370	0.0000	15,860.6209	15,860.6209	4.3187			15,951.3133

Mitigated Construction Off-Site

	ROG	NOx	CO	SO2	Fugitive PM10	Exhaust PM10	PM10 Total	Fugitive PM2.5	Exhaust PM2.5	PM2.5 Total	Bio- CO2	NBio- CO2	Total CO2	CH4	N2O	CO2e	
Category	lb/day										lb/day						
Hauling	5.6700e-003	0.0718	0.0691	2.1000e-004	4.8500e-003	9.4000e-004	5.7900e-003	1.3300e-003	8.6000e-004	2.1900e-003		20.5826	20.5826	1.4000e-004			20.5856
Vendor	0.0441	0.3470	0.5672	9.5000e-004	0.0266	5.0300e-003	0.0316	7.5800e-003	4.6200e-003	0.0122		93.1016	93.1016	7.2000e-004			93.1166
Worker	0.0739	0.0920	0.8606	2.1500e-003	0.1807	1.3100e-003	0.1820	0.0479	1.2100e-003	0.0492		172.5126	172.5126	8.8600e-003			172.6986
Total	0.1236	0.5109	1.4968	3.3100e-003	0.2121	7.2800e-003	0.2194	0.0569	6.6900e-003	0.0635		286.1967	286.1967	9.7200e-003			286.4008

3.9 Axial 2 - Pump Station Install - 2017

Unmitigated Construction On-Site

	ROG	NOx	CO	SO2	Fugitive PM10	Exhaust PM10	PM10 Total	Fugitive PM2.5	Exhaust PM2.5	PM2.5 Total	Bio- CO2	NBio- CO2	Total CO2	CH4	N2O	CO2e
Category	lb/day										lb/day					
Off-Road	3.1879	30.5757	19.1538	0.0343		1.6861	1.6861		1.6267	1.6267		3,359.4772	3,359.4772	0.6178		3,372.4511
Total	3.1879	30.5757	19.1538	0.0343		1.6861	1.6861		1.6267	1.6267		3,359.4772	3,359.4772	0.6178		3,372.4511

Unmitigated Construction Off-Site

	ROG	NOx	CO	SO2	Fugitive PM10	Exhaust PM10	PM10 Total	Fugitive PM2.5	Exhaust PM2.5	PM2.5 Total	Bio- CO2	NBio- CO2	Total CO2	CH4	N2O	CO2e
Category	lb/day										lb/day					
Hauling	0.0000	0.0000	0.0000	0.0000	0.0000	0.0000	0.0000	0.0000	0.0000	0.0000		0.0000	0.0000	0.0000		0.0000
Vendor	0.2205	1.7351	2.8360	4.7300e-003	0.1328	0.0251	0.1579	0.0379	0.0231	0.0610		465.5077	465.5077	3.5800e-003		465.5829
Worker	0.0537	0.0669	0.6259	1.5600e-003	0.1314	9.6000e-004	0.1324	0.0349	8.8000e-004	0.0357		125.4637	125.4637	6.4400e-003		125.5990
Total	0.2743	1.8021	3.4619	6.2900e-003	0.2642	0.0261	0.2903	0.0727	0.0240	0.0967		590.9714	590.9714	0.0100		591.1819

Mitigated Construction On-Site

	ROG	NOx	CO	SO2	Fugitive PM10	Exhaust PM10	PM10 Total	Fugitive PM2.5	Exhaust PM2.5	PM2.5 Total	Bio- CO2	NBio- CO2	Total CO2	CH4	N2O	CO2e
Category	lb/day										lb/day					

Off-Road	3.1879	30.5757	19.1538	0.0343		1.6861	1.6861		1.6267	1.6267	0.0000	3,359.4772	3,359.4772	0.6178		3,372.4511
Total	3.1879	30.5757	19.1538	0.0343		1.6861	1.6861		1.6267	1.6267	0.0000	3,359.4772	3,359.4772	0.6178		3,372.4511

Mitigated Construction Off-Site

	ROG	NOx	CO	SO2	Fugitive PM10	Exhaust PM10	PM10 Total	Fugitive PM2.5	Exhaust PM2.5	PM2.5 Total	Bio- CO2	NBio- CO2	Total CO2	CH4	N2O	CO2e
Category	lb/day										lb/day					
Hauling	0.0000	0.0000	0.0000	0.0000	0.0000	0.0000	0.0000	0.0000	0.0000	0.0000		0.0000	0.0000	0.0000		0.0000
Vendor	0.2205	1.7351	2.8360	4.7300e-003	0.1328	0.0251	0.1579	0.0379	0.0231	0.0610		465.5077	465.5077	3.5800e-003		465.5829
Worker	0.0537	0.0669	0.6259	1.5600e-003	0.1314	9.6000e-004	0.1324	0.0349	8.8000e-004	0.0357		125.4637	125.4637	6.4400e-003		125.5990
Total	0.2743	1.8021	3.4619	6.2900e-003	0.2642	0.0261	0.2903	0.0727	0.0240	0.0967		590.9714	590.9714	0.0100		591.1819

3.10 Axial 3a - Trenching - 2017

Unmitigated Construction On-Site

	ROG	NOx	CO	SO2	Fugitive PM10	Exhaust PM10	PM10 Total	Fugitive PM2.5	Exhaust PM2.5	PM2.5 Total	Bio- CO2	NBio- CO2	Total CO2	CH4	N2O	CO2e
Category	lb/day										lb/day					
Off-Road	0.4038	5.0661	2.4218	9.8300e-003		0.1638	0.1638		0.1507	0.1507		1,003.8880	1,003.8880	0.3076		1,010.3474
Total	0.4038	5.0661	2.4218	9.8300e-003		0.1638	0.1638		0.1507	0.1507		1,003.8880	1,003.8880	0.3076		1,010.3474

Unmitigated Construction Off-Site

	ROG	NOx	CO	SO2	Fugitive PM10	Exhaust PM10	PM10 Total	Fugitive PM2.5	Exhaust PM2.5	PM2.5 Total	Bio- CO2	NBio- CO2	Total CO2	CH4	N2O	CO2e	
Category	lb/day										lb/day						
Hauling	0.0000	0.0000	0.0000	0.0000	0.0000	0.0000	0.0000	0.0000	0.0000	0.0000		0.0000	0.0000	0.0000			0.0000
Vendor	0.0000	0.0000	0.0000	0.0000	0.0000	0.0000	0.0000	0.0000	0.0000	0.0000		0.0000	0.0000	0.0000			0.0000
Worker	0.0101	0.0126	0.1174	2.9000e-004	0.0246	1.8000e-004	0.0248	6.5400e-003	1.7000e-004	6.7000e-003		23.5244	23.5244	1.2100e-003			23.5498
Total	0.0101	0.0126	0.1174	2.9000e-004	0.0246	1.8000e-004	0.0248	6.5400e-003	1.7000e-004	6.7000e-003		23.5244	23.5244	1.2100e-003			23.5498

Mitigated Construction On-Site

	ROG	NOx	CO	SO2	Fugitive PM10	Exhaust PM10	PM10 Total	Fugitive PM2.5	Exhaust PM2.5	PM2.5 Total	Bio- CO2	NBio- CO2	Total CO2	CH4	N2O	CO2e	
Category	lb/day										lb/day						
Off-Road	0.4038	5.0661	2.4218	9.8300e-003		0.1638	0.1638		0.1507	0.1507	0.0000	1,003.8880	1,003.8880	0.3076			1,010.3474
Total	0.4038	5.0661	2.4218	9.8300e-003		0.1638	0.1638		0.1507	0.1507	0.0000	1,003.8880	1,003.8880	0.3076			1,010.3474

Mitigated Construction Off-Site

	ROG	NOx	CO	SO2	Fugitive PM10	Exhaust PM10	PM10 Total	Fugitive PM2.5	Exhaust PM2.5	PM2.5 Total	Bio- CO2	NBio- CO2	Total CO2	CH4	N2O	CO2e
--	-----	-----	----	-----	---------------	--------------	------------	----------------	---------------	-------------	----------	-----------	-----------	-----	-----	------

Category	lb/day										lb/day					
Hauling	0.0000	0.0000	0.0000	0.0000	0.0000	0.0000	0.0000	0.0000	0.0000	0.0000	0.0000	0.0000	0.0000	0.0000	0.0000	0.0000
Vendor	0.0000	0.0000	0.0000	0.0000	0.0000	0.0000	0.0000	0.0000	0.0000	0.0000	0.0000	0.0000	0.0000	0.0000	0.0000	0.0000
Worker	0.0101	0.0126	0.1174	2.9000e-004	0.0246	1.8000e-004	0.0248	6.5400e-003	1.7000e-004	6.7000e-003		23.5244	23.5244	1.2100e-003		23.5498
Total	0.0101	0.0126	0.1174	2.9000e-004	0.0246	1.8000e-004	0.0248	6.5400e-003	1.7000e-004	6.7000e-003		23.5244	23.5244	1.2100e-003		23.5498

3.11 Axial 3b - Paving - 2017

Unmitigated Construction On-Site

	ROG	NOx	CO	SO2	Fugitive PM10	Exhaust PM10	PM10 Total	Fugitive PM2.5	Exhaust PM2.5	PM2.5 Total	Bio- CO2	NBio- CO2	Total CO2	CH4	N2O	CO2e
Category	lb/day										lb/day					
Off-Road	0.6710	6.9321	4.8269	7.1400e-003		0.4086	0.4086		0.3759	0.3759		730.1781	730.1781	0.2237		734.8764
Paving	0.0000					0.0000	0.0000		0.0000	0.0000			0.0000			0.0000
Total	0.6710	6.9321	4.8269	7.1400e-003		0.4086	0.4086		0.3759	0.3759		730.1781	730.1781	0.2237		734.8764

Unmitigated Construction Off-Site

	ROG	NOx	CO	SO2	Fugitive PM10	Exhaust PM10	PM10 Total	Fugitive PM2.5	Exhaust PM2.5	PM2.5 Total	Bio- CO2	NBio- CO2	Total CO2	CH4	N2O	CO2e
Category	lb/day										lb/day					
Hauling	0.0000	0.0000	0.0000	0.0000	0.0000	0.0000	0.0000	0.0000	0.0000	0.0000		0.0000	0.0000	0.0000		0.0000
Vendor	0.1764	1.3881	2.2688	3.7800e-003	0.1062	0.0201	0.1263	0.0303	0.0185	0.0488		372.4062	372.4062	2.8600e-003		372.4663
Worker	0.0470	0.0586	0.5476	1.3700e-003	0.1150	8.4000e-004	0.1158	0.0305	7.7000e-004	0.0313		109.7807	109.7807	5.6400e-003		109.8991

Total	0.2234	1.4467	2.8165	5.1500e-003	0.2212	0.0210	0.2422	0.0608	0.0193	0.0801		482.1869	482.1869	8.5000e-003		482.3654
--------------	---------------	---------------	---------------	--------------------	---------------	---------------	---------------	---------------	---------------	---------------	--	-----------------	-----------------	--------------------	--	-----------------

Mitigated Construction On-Site

	ROG	NOx	CO	SO2	Fugitive PM10	Exhaust PM10	PM10 Total	Fugitive PM2.5	Exhaust PM2.5	PM2.5 Total	Bio- CO2	NBio- CO2	Total CO2	CH4	N2O	CO2e
Category	lb/day										lb/day					
Off-Road	0.6710	6.9321	4.8269	7.1400e-003		0.4086	0.4086		0.3759	0.3759	0.0000	730.1781	730.1781	0.2237		734.8764
Paving	0.0000					0.0000	0.0000		0.0000	0.0000			0.0000			0.0000
Total	0.6710	6.9321	4.8269	7.1400e-003		0.4086	0.4086		0.3759	0.3759	0.0000	730.1781	730.1781	0.2237		734.8764

Mitigated Construction Off-Site

	ROG	NOx	CO	SO2	Fugitive PM10	Exhaust PM10	PM10 Total	Fugitive PM2.5	Exhaust PM2.5	PM2.5 Total	Bio- CO2	NBio- CO2	Total CO2	CH4	N2O	CO2e
Category	lb/day										lb/day					
Hauling	0.0000	0.0000	0.0000	0.0000	0.0000	0.0000	0.0000	0.0000	0.0000	0.0000		0.0000	0.0000	0.0000		0.0000
Vendor	0.1764	1.3881	2.2688	3.7800e-003	0.1062	0.0201	0.1263	0.0303	0.0185	0.0488		372.4062	372.4062	2.8600e-003		372.4663
Worker	0.0470	0.0586	0.5476	1.3700e-003	0.1150	8.4000e-004	0.1158	0.0305	7.7000e-004	0.0313		109.7807	109.7807	5.6400e-003		109.8991
Total	0.2234	1.4467	2.8165	5.1500e-003	0.2212	0.0210	0.2422	0.0608	0.0193	0.0801		482.1869	482.1869	8.5000e-003		482.3654

3.12 Intake 5 - Backfill - 2017

Unmitigated Construction On-Site

	ROG	NOx	CO	SO2	Fugitive PM10	Exhaust PM10	PM10 Total	Fugitive PM2.5	Exhaust PM2.5	PM2.5 Total	Bio- CO2	NBio- CO2	Total CO2	CH4	N2O	CO2e
Category	lb/day										lb/day					
Fugitive Dust					0.0000	0.0000	0.0000	0.0000	0.0000	0.0000			0.0000			0.0000
Off-Road	6.3575	66.8053	36.6266	0.0884		2.9938	2.9938		2.8299	2.8299		8,888.1093	8,888.1093	2.3118		8,936.6564
Total	6.3575	66.8053	36.6266	0.0884	0.0000	2.9938	2.9938	0.0000	2.8299	2.8299		8,888.1093	8,888.1093	2.3118		8,936.6564

Unmitigated Construction Off-Site

	ROG	NOx	CO	SO2	Fugitive PM10	Exhaust PM10	PM10 Total	Fugitive PM2.5	Exhaust PM2.5	PM2.5 Total	Bio- CO2	NBio- CO2	Total CO2	CH4	N2O	CO2e
Category	lb/day										lb/day					
Hauling	0.0000	0.0000	0.0000	0.0000	0.0000	0.0000	0.0000	0.0000	0.0000	0.0000		0.0000	0.0000	0.0000		0.0000
Vendor	0.0441	0.3470	0.5672	9.5000e-004	0.0266	5.0300e-003	0.0316	7.5800e-003	4.6200e-003	0.0122		93.1016	93.1016	7.2000e-004		93.1166
Worker	0.0873	0.1088	1.0170	2.5400e-003	0.2136	1.5500e-003	0.2151	0.0567	1.4300e-003	0.0581		203.8785	203.8785	0.0105		204.0984
Total	0.1314	0.4558	1.5842	3.4900e-003	0.2401	6.5800e-003	0.2467	0.0642	6.0500e-003	0.0703		296.9801	296.9801	0.0112		297.2149

Mitigated Construction On-Site

	ROG	NOx	CO	SO2	Fugitive PM10	Exhaust PM10	PM10 Total	Fugitive PM2.5	Exhaust PM2.5	PM2.5 Total	Bio- CO2	NBio- CO2	Total CO2	CH4	N2O	CO2e
Category	lb/day										lb/day					

Fugitive Dust					0.0000	0.0000	0.0000	0.0000	0.0000	0.0000			0.0000			0.0000
Off-Road	6.3575	66.8053	36.6266	0.0884		2.9938	2.9938		2.8299	2.8299	0.0000	8,888.1093	8,888.1093	2.3118		8,936.6564
Total	6.3575	66.8053	36.6266	0.0884	0.0000	2.9938	2.9938	0.0000	2.8299	2.8299	0.0000	8,888.1093	8,888.1093	2.3118		8,936.6564

Mitigated Construction Off-Site

	ROG	NOx	CO	SO2	Fugitive PM10	Exhaust PM10	PM10 Total	Fugitive PM2.5	Exhaust PM2.5	PM2.5 Total	Bio- CO2	NBio- CO2	Total CO2	CH4	N2O	CO2e
Category	lb/day										lb/day					
Hauling	0.0000	0.0000	0.0000	0.0000	0.0000	0.0000	0.0000	0.0000	0.0000	0.0000		0.0000	0.0000	0.0000		0.0000
Vendor	0.0441	0.3470	0.5672	9.5000e-004	0.0266	5.0300e-003	0.0316	7.5800e-003	4.6200e-003	0.0122		93.1016	93.1016	7.2000e-004		93.1166
Worker	0.0873	0.1088	1.0170	2.5400e-003	0.2136	1.5500e-003	0.2151	0.0567	1.4300e-003	0.0581		203.8785	203.8785	0.0105		204.0984
Total	0.1314	0.4558	1.5842	3.4900e-003	0.2401	6.5800e-003	0.2467	0.0642	6.0500e-003	0.0703		296.9801	296.9801	0.0112		297.2149

3.12 Intake 5 - Backfill - 2018

Unmitigated Construction On-Site

	ROG	NOx	CO	SO2	Fugitive PM10	Exhaust PM10	PM10 Total	Fugitive PM2.5	Exhaust PM2.5	PM2.5 Total	Bio- CO2	NBio- CO2	Total CO2	CH4	N2O	CO2e
Category	lb/day										lb/day					
Fugitive Dust					0.0000	0.0000	0.0000	0.0000	0.0000	0.0000			0.0000			0.0000
Off-Road	5.5954	57.5554	34.6767	0.0884		2.5309	2.5309		2.3948	2.3948		8,773.3983	8,773.3983	2.2908		8,821.5057
Total	5.5954	57.5554	34.6767	0.0884	0.0000	2.5309	2.5309	0.0000	2.3948	2.3948		8,773.3983	8,773.3983	2.2908		8,821.5057

Unmitigated Construction Off-Site

	ROG	NOx	CO	SO2	Fugitive PM10	Exhaust PM10	PM10 Total	Fugitive PM2.5	Exhaust PM2.5	PM2.5 Total	Bio- CO2	NBio- CO2	Total CO2	CH4	N2O	CO2e	
Category	lb/day										lb/day						
Hauling	0.0000	0.0000	0.0000	0.0000	0.0000	0.0000	0.0000	0.0000	0.0000	0.0000		0.0000	0.0000	0.0000			0.0000
Vendor	0.0414	0.3133	0.5431	9.4000e-004	0.0266	4.6700e-003	0.0312	7.5700e-003	4.2900e-003	0.0119		91.5011	91.5011	7.0000e-004			91.5159
Worker	0.0793	0.0993	0.9185	2.5400e-003	0.2136	1.5200e-003	0.2151	0.0567	1.4100e-003	0.0581		196.2209	196.2209	9.7400e-003			196.4254
Total	0.1207	0.4126	1.4616	3.4800e-003	0.2401	6.1900e-003	0.2463	0.0642	5.7000e-003	0.0699		287.7221	287.7221	0.0104			287.9413

Mitigated Construction On-Site

	ROG	NOx	CO	SO2	Fugitive PM10	Exhaust PM10	PM10 Total	Fugitive PM2.5	Exhaust PM2.5	PM2.5 Total	Bio- CO2	NBio- CO2	Total CO2	CH4	N2O	CO2e	
Category	lb/day										lb/day						
Fugitive Dust					0.0000	0.0000	0.0000	0.0000	0.0000	0.0000			0.0000			0.0000	
Off-Road	5.5954	57.5554	34.6767	0.0884		2.5309	2.5309		2.3948	2.3948	0.0000	8,773.3983	8,773.3983	2.2908			8,821.5057
Total	5.5954	57.5554	34.6767	0.0884	0.0000	2.5309	2.5309	0.0000	2.3948	2.3948	0.0000	8,773.3983	8,773.3983	2.2908			8,821.5057

Mitigated Construction Off-Site

	ROG	NOx	CO	SO2	Fugitive PM10	Exhaust PM10	PM10 Total	Fugitive PM2.5	Exhaust PM2.5	PM2.5 Total	Bio- CO2	NBio- CO2	Total CO2	CH4	N2O	CO2e
--	-----	-----	----	-----	---------------	--------------	------------	----------------	---------------	-------------	----------	-----------	-----------	-----	-----	------

Category	lb/day										lb/day					
Hauling	0.0000	0.0000	0.0000	0.0000	0.0000	0.0000	0.0000	0.0000	0.0000	0.0000	0.0000	0.0000	0.0000	0.0000	0.0000	0.0000
Vendor	0.0414	0.3133	0.5431	9.4000e-004	0.0266	4.6700e-003	0.0312	7.5700e-003	4.2900e-003	0.0119		91.5011	91.5011	7.0000e-004		91.5159
Worker	0.0793	0.0993	0.9185	2.5400e-003	0.2136	1.5200e-003	0.2151	0.0567	1.4100e-003	0.0581		196.2209	196.2209	9.7400e-003		196.4254
Total	0.1207	0.4126	1.4616	3.4800e-003	0.2401	6.1900e-003	0.2463	0.0642	5.7000e-003	0.0699		287.7221	287.7221	0.0104		287.9413

3.13 Axial 4 - Building Construction - 2017

Unmitigated Construction On-Site

	ROG	NOx	CO	SO2	Fugitive PM10	Exhaust PM10	PM10 Total	Fugitive PM2.5	Exhaust PM2.5	PM2.5 Total	Bio- CO2	NBio- CO2	Total CO2	CH4	N2O	CO2e
Category	lb/day										lb/day					
Off-Road	10.3309	110.2412	56.6302	0.1443		4.5890	4.5890		4.2974	4.2974		14,605.1956	14,605.1956	4.0635		14,690.5285
Total	10.3309	110.2412	56.6302	0.1443		4.5890	4.5890		4.2974	4.2974		14,605.1956	14,605.1956	4.0635		14,690.5285

Unmitigated Construction Off-Site

	ROG	NOx	CO	SO2	Fugitive PM10	Exhaust PM10	PM10 Total	Fugitive PM2.5	Exhaust PM2.5	PM2.5 Total	Bio- CO2	NBio- CO2	Total CO2	CH4	N2O	CO2e
Category	lb/day										lb/day					
Hauling	0.0000	0.0000	0.0000	0.0000	0.0000	0.0000	0.0000	0.0000	0.0000	0.0000		0.0000	0.0000	0.0000		0.0000
Vendor	0.2205	1.7351	2.8360	4.7300e-003	0.1328	0.0251	0.1579	0.0379	0.0231	0.0610		465.5077	465.5077	3.5800e-003		465.5829
Worker	0.0873	0.1088	1.0170	2.5400e-003	0.2136	1.5500e-003	0.2151	0.0567	1.4300e-003	0.0581		203.8785	203.8785	0.0105		204.0984

Total	0.3078	1.8439	3.8531	7.2700e-003	0.3463	0.0267	0.3730	0.0945	0.0245	0.1191		669.3863	669.3863	0.0141		669.6813
--------------	---------------	---------------	---------------	--------------------	---------------	---------------	---------------	---------------	---------------	---------------	--	-----------------	-----------------	---------------	--	-----------------

Mitigated Construction On-Site

	ROG	NOx	CO	SO2	Fugitive PM10	Exhaust PM10	PM10 Total	Fugitive PM2.5	Exhaust PM2.5	PM2.5 Total	Bio- CO2	NBio- CO2	Total CO2	CH4	N2O	CO2e
Category	lb/day										lb/day					
Off-Road	10.3309	110.2412	56.6302	0.1443		4.5890	4.5890		4.2974	4.2974	0.0000	14,605.1956	14,605.1956	4.0635		14,690.5285
Total	10.3309	110.2412	56.6302	0.1443		4.5890	4.5890		4.2974	4.2974	0.0000	14,605.1956	14,605.1956	4.0635		14,690.5285

Mitigated Construction Off-Site

	ROG	NOx	CO	SO2	Fugitive PM10	Exhaust PM10	PM10 Total	Fugitive PM2.5	Exhaust PM2.5	PM2.5 Total	Bio- CO2	NBio- CO2	Total CO2	CH4	N2O	CO2e
Category	lb/day										lb/day					
Hauling	0.0000	0.0000	0.0000	0.0000	0.0000	0.0000	0.0000	0.0000	0.0000	0.0000		0.0000	0.0000	0.0000		0.0000
Vendor	0.2205	1.7351	2.8360	4.7300e-003	0.1328	0.0251	0.1579	0.0379	0.0231	0.0610		465.5077	465.5077	3.5800e-003		465.5829
Worker	0.0873	0.1088	1.0170	2.5400e-003	0.2136	1.5500e-003	0.2151	0.0567	1.4300e-003	0.0581		203.8785	203.8785	0.0105		204.0984
Total	0.3078	1.8439	3.8531	7.2700e-003	0.3463	0.0267	0.3730	0.0945	0.0245	0.1191		669.3863	669.3863	0.0141		669.6813

3.13 Axial 4 - Building Construction - 2018

Unmitigated Construction On-Site

	ROG	NOx	CO	SO2	Fugitive PM10	Exhaust PM10	PM10 Total	Fugitive PM2.5	Exhaust PM2.5	PM2.5 Total	Bio- CO2	NBio- CO2	Total CO2	CH4	N2O	CO2e
Category	lb/day										lb/day					
Off-Road	9.1134	94.1226	51.6981	0.1443		3.8524	3.8524		3.6105	3.6105		14,403.6794	14,403.6794	4.0436		14,488.5952
Total	9.1134	94.1226	51.6981	0.1443		3.8524	3.8524		3.6105	3.6105		14,403.6794	14,403.6794	4.0436		14,488.5952

Unmitigated Construction Off-Site

	ROG	NOx	CO	SO2	Fugitive PM10	Exhaust PM10	PM10 Total	Fugitive PM2.5	Exhaust PM2.5	PM2.5 Total	Bio- CO2	NBio- CO2	Total CO2	CH4	N2O	CO2e
Category	lb/day										lb/day					
Hauling	0.0000	0.0000	0.0000	0.0000	0.0000	0.0000	0.0000	0.0000	0.0000	0.0000		0.0000	0.0000	0.0000		0.0000
Vendor	0.2068	1.5666	2.7153	4.7200e-003	0.1327	0.0233	0.1561	0.0379	0.0215	0.0593		457.5056	457.5056	3.5100e-003		457.5794
Worker	0.0793	0.0993	0.9185	2.5400e-003	0.2136	1.5200e-003	0.2151	0.0567	1.4100e-003	0.0581		196.2209	196.2209	9.7400e-003		196.4254
Total	0.2861	1.6658	3.6338	7.2600e-003	0.3463	0.0249	0.3712	0.0945	0.0229	0.1174		653.7266	653.7266	0.0133		654.0048

Mitigated Construction On-Site

	ROG	NOx	CO	SO2	Fugitive PM10	Exhaust PM10	PM10 Total	Fugitive PM2.5	Exhaust PM2.5	PM2.5 Total	Bio- CO2	NBio- CO2	Total CO2	CH4	N2O	CO2e
Category	lb/day										lb/day					

Off-Road	9.1134	94.1226	51.6981	0.1443		3.8524	3.8524		3.6105	3.6105	0.0000	14,403.6794	14,403.6794	4.0436		14,488.5952
Total	9.1134	94.1226	51.6981	0.1443		3.8524	3.8524		3.6105	3.6105	0.0000	14,403.6794	14,403.6794	4.0436		14,488.5952

Mitigated Construction Off-Site

	ROG	NOx	CO	SO2	Fugitive PM10	Exhaust PM10	PM10 Total	Fugitive PM2.5	Exhaust PM2.5	PM2.5 Total	Bio- CO2	NBio- CO2	Total CO2	CH4	N2O	CO2e
Category	lb/day										lb/day					
Hauling	0.0000	0.0000	0.0000	0.0000	0.0000	0.0000	0.0000	0.0000	0.0000	0.0000		0.0000	0.0000	0.0000		0.0000
Vendor	0.2068	1.5666	2.7153	4.7200e-003	0.1327	0.0233	0.1561	0.0379	0.0215	0.0593		457.5056	457.5056	3.5100e-003		457.5794
Worker	0.0793	0.0993	0.9185	2.5400e-003	0.2136	1.5200e-003	0.2151	0.0567	1.4100e-003	0.0581		196.2209	196.2209	9.7400e-003		196.4254
Total	0.2861	1.6658	3.6338	7.2600e-003	0.3463	0.0249	0.3712	0.0945	0.0229	0.1174		653.7266	653.7266	0.0133		654.0048

3.14 Intake 6a - Grading - 2018

Unmitigated Construction On-Site

	ROG	NOx	CO	SO2	Fugitive PM10	Exhaust PM10	PM10 Total	Fugitive PM2.5	Exhaust PM2.5	PM2.5 Total	Bio- CO2	NBio- CO2	Total CO2	CH4	N2O	CO2e
Category	lb/day										lb/day					
Fugitive Dust					0.1315	0.0000	0.1315	0.0142	0.0000	0.0142			0.0000			0.0000
Off-Road	1.0528	9.7095	5.4199	8.4600e-003		0.5215	0.5215		0.4842	0.4842		808.6313	808.6313	0.2145		813.1347
Total	1.0528	9.7095	5.4199	8.4600e-003	0.1315	0.5215	0.6530	0.0142	0.4842	0.4984		808.6313	808.6313	0.2145		813.1347

Unmitigated Construction Off-Site

	ROG	NOx	CO	SO2	Fugitive PM10	Exhaust PM10	PM10 Total	Fugitive PM2.5	Exhaust PM2.5	PM2.5 Total	Bio- CO2	NBio- CO2	Total CO2	CH4	N2O	CO2e
Category	lb/day										lb/day					
Hauling	0.0000	0.0000	0.0000	0.0000	0.0000	0.0000	0.0000	0.0000	0.0000	0.0000		0.0000	0.0000	0.0000		0.0000
Vendor	0.1447	1.0966	1.9007	3.3000e-003	0.0929	0.0163	0.1093	0.0265	0.0150	0.0415		320.2540	320.2540	2.4600e-003		320.3056
Worker	0.0427	0.0534	0.4946	1.3700e-003	0.1150	8.2000e-004	0.1158	0.0305	7.6000e-004	0.0313		105.6574	105.6574	5.2400e-003		105.7675
Total	0.1875	1.1500	2.3953	4.6700e-003	0.2079	0.0172	0.2251	0.0570	0.0158	0.0728		425.9114	425.9114	7.7000e-003		426.0731

Mitigated Construction On-Site

	ROG	NOx	CO	SO2	Fugitive PM10	Exhaust PM10	PM10 Total	Fugitive PM2.5	Exhaust PM2.5	PM2.5 Total	Bio- CO2	NBio- CO2	Total CO2	CH4	N2O	CO2e
Category	lb/day										lb/day					
Fugitive Dust					0.0513	0.0000	0.0513	5.5400e-003	0.0000	5.5400e-003			0.0000			0.0000
Off-Road	1.0528	9.7095	5.4199	8.4600e-003		0.5215	0.5215		0.4842	0.4842	0.0000	808.6313	808.6313	0.2145		813.1347
Total	1.0528	9.7095	5.4199	8.4600e-003	0.0513	0.5215	0.5728	5.5400e-003	0.4842	0.4897	0.0000	808.6313	808.6313	0.2145		813.1347

Mitigated Construction Off-Site

	ROG	NOx	CO	SO2	Fugitive PM10	Exhaust PM10	PM10 Total	Fugitive PM2.5	Exhaust PM2.5	PM2.5 Total	Bio- CO2	NBio- CO2	Total CO2	CH4	N2O	CO2e
--	-----	-----	----	-----	---------------	--------------	------------	----------------	---------------	-------------	----------	-----------	-----------	-----	-----	------

Category	lb/day										lb/day					
Hauling	0.0000	0.0000	0.0000	0.0000	0.0000	0.0000	0.0000	0.0000	0.0000	0.0000	0.0000	0.0000	0.0000	0.0000	0.0000	0.0000
Vendor	0.1447	1.0966	1.9007	3.3000e-003	0.0929	0.0163	0.1093	0.0265	0.0150	0.0415	320.2540	320.2540	2.4600e-003		320.3056	
Worker	0.0427	0.0534	0.4946	1.3700e-003	0.1150	8.2000e-004	0.1158	0.0305	7.6000e-004	0.0313	105.6574	105.6574	5.2400e-003		105.7675	
Total	0.1875	1.1500	2.3953	4.6700e-003	0.2079	0.0172	0.2251	0.0570	0.0158	0.0728	425.9114	425.9114	7.7000e-003		426.0731	

3.15 Axial 5 - Architectural Coatings - 2018

Unmitigated Construction On-Site

	ROG	NOx	CO	SO2	Fugitive PM10	Exhaust PM10	PM10 Total	Fugitive PM2.5	Exhaust PM2.5	PM2.5 Total	Bio- CO2	NBio- CO2	Total CO2	CH4	N2O	CO2e
Category	lb/day										lb/day					
Archit. Coating	0.3792					0.0000	0.0000		0.0000	0.0000			0.0000			0.0000
Off-Road	0.8785	6.7396	7.0791	0.0112		0.4399	0.4399		0.4369	0.4369		1,081.1233	1,081.1233	0.1742		1,084.7822
Total	1.2578	6.7396	7.0791	0.0112		0.4399	0.4399		0.4369	0.4369		1,081.1233	1,081.1233	0.1742		1,084.7822

Unmitigated Construction Off-Site

	ROG	NOx	CO	SO2	Fugitive PM10	Exhaust PM10	PM10 Total	Fugitive PM2.5	Exhaust PM2.5	PM2.5 Total	Bio- CO2	NBio- CO2	Total CO2	CH4	N2O	CO2e
Category	lb/day										lb/day					
Hauling	0.0000	0.0000	0.0000	0.0000	0.0000	0.0000	0.0000	0.0000	0.0000	0.0000		0.0000	0.0000	0.0000		0.0000
Vendor	0.0827	0.6266	1.0861	1.8900e-003	0.0531	9.3300e-003	0.0624	0.0152	8.5900e-003	0.0237		183.0023	183.0023	1.4100e-003		183.0318
Worker	0.0244	0.0305	0.2826	7.8000e-004	0.0657	4.7000e-004	0.0662	0.0174	4.3000e-004	0.0179		60.3757	60.3757	3.0000e-003		60.4386

Total	0.1071	0.6572	1.3687	2.6700e-003	0.1188	9.8000e-003	0.1286	0.0326	9.0200e-003	0.0416		243.3779	243.3779	4.4100e-003		243.4704
--------------	---------------	---------------	---------------	--------------------	---------------	--------------------	---------------	---------------	--------------------	---------------	--	-----------------	-----------------	--------------------	--	-----------------

Mitigated Construction On-Site

	ROG	NOx	CO	SO2	Fugitive PM10	Exhaust PM10	PM10 Total	Fugitive PM2.5	Exhaust PM2.5	PM2.5 Total	Bio- CO2	NBio- CO2	Total CO2	CH4	N2O	CO2e	
Category	lb/day										lb/day						
Archit. Coating	0.3792					0.0000	0.0000		0.0000	0.0000			0.0000				0.0000
Off-Road	0.8785	6.7396	7.0791	0.0112		0.4399	0.4399		0.4369	0.4369	0.0000	1,081.1233	1,081.1233	0.1742			1,084.7822
Total	1.2578	6.7396	7.0791	0.0112		0.4399	0.4399		0.4369	0.4369	0.0000	1,081.1233	1,081.1233	0.1742			1,084.7822

Mitigated Construction Off-Site

	ROG	NOx	CO	SO2	Fugitive PM10	Exhaust PM10	PM10 Total	Fugitive PM2.5	Exhaust PM2.5	PM2.5 Total	Bio- CO2	NBio- CO2	Total CO2	CH4	N2O	CO2e	
Category	lb/day										lb/day						
Hauling	0.0000	0.0000	0.0000	0.0000	0.0000	0.0000	0.0000	0.0000	0.0000	0.0000		0.0000	0.0000	0.0000			0.0000
Vendor	0.0827	0.6266	1.0861	1.8900e-003	0.0531	9.3300e-003	0.0624	0.0152	8.5900e-003	0.0237		183.0023	183.0023	1.4100e-003			183.0318
Worker	0.0244	0.0305	0.2826	7.8000e-004	0.0657	4.7000e-004	0.0662	0.0174	4.3000e-004	0.0179		60.3757	60.3757	3.0000e-003			60.4386
Total	0.1071	0.6572	1.3687	2.6700e-003	0.1188	9.8000e-003	0.1286	0.0326	9.0200e-003	0.0416		243.3779	243.3779	4.4100e-003			243.4704

3.16 Intake 6b - Paving - 2018

Unmitigated Construction On-Site

	ROG	NOx	CO	SO2	Fugitive PM10	Exhaust PM10	PM10 Total	Fugitive PM2.5	Exhaust PM2.5	PM2.5 Total	Bio- CO2	NBio- CO2	Total CO2	CH4	N2O	CO2e	
Category	lb/day										lb/day						
Off-Road	0.5715	5.9631	4.7495	7.1400e-003		0.3411	0.3411		0.3138	0.3138			718.8418	718.8418	0.2238		723.5413
Paving	0.0000					0.0000	0.0000		0.0000	0.0000			0.0000				0.0000
Total	0.5715	5.9631	4.7495	7.1400e-003		0.3411	0.3411		0.3138	0.3138			718.8418	718.8418	0.2238		723.5413

Unmitigated Construction Off-Site

	ROG	NOx	CO	SO2	Fugitive PM10	Exhaust PM10	PM10 Total	Fugitive PM2.5	Exhaust PM2.5	PM2.5 Total	Bio- CO2	NBio- CO2	Total CO2	CH4	N2O	CO2e	
Category	lb/day										lb/day						
Hauling	0.0000	0.0000	0.0000	0.0000	0.0000	0.0000	0.0000	0.0000	0.0000	0.0000		0.0000	0.0000	0.0000		0.0000	
Vendor	0.1447	1.0966	1.9007	3.3000e-003	0.0929	0.0163	0.1093	0.0265	0.0150	0.0415			320.2540	320.2540	2.4600e-003		320.3056
Worker	0.0427	0.0534	0.4946	1.3700e-003	0.1150	8.2000e-004	0.1158	0.0305	7.6000e-004	0.0313			105.6574	105.6574	5.2400e-003		105.7675
Total	0.1875	1.1500	2.3953	4.6700e-003	0.2079	0.0172	0.2251	0.0570	0.0158	0.0728			425.9114	425.9114	7.7000e-003		426.0731

Mitigated Construction On-Site

	ROG	NOx	CO	SO2	Fugitive PM10	Exhaust PM10	PM10 Total	Fugitive PM2.5	Exhaust PM2.5	PM2.5 Total	Bio- CO2	NBio- CO2	Total CO2	CH4	N2O	CO2e
Category	lb/day										lb/day					

Off-Road	0.5715	5.9631	4.7495	7.1400e-003		0.3411	0.3411		0.3138	0.3138	0.0000	718.8418	718.8418	0.2238		723.5413
Paving	0.0000					0.0000	0.0000		0.0000	0.0000			0.0000			0.0000
Total	0.5715	5.9631	4.7495	7.1400e-003		0.3411	0.3411		0.3138	0.3138	0.0000	718.8418	718.8418	0.2238		723.5413

Mitigated Construction Off-Site

	ROG	NOx	CO	SO2	Fugitive PM10	Exhaust PM10	PM10 Total	Fugitive PM2.5	Exhaust PM2.5	PM2.5 Total	Bio- CO2	NBio- CO2	Total CO2	CH4	N2O	CO2e
Category	lb/day										lb/day					
Hauling	0.0000	0.0000	0.0000	0.0000	0.0000	0.0000	0.0000	0.0000	0.0000	0.0000		0.0000	0.0000	0.0000		0.0000
Vendor	0.1447	1.0966	1.9007	3.3000e-003	0.0929	0.0163	0.1093	0.0265	0.0150	0.0415		320.2540	320.2540	2.4600e-003		320.3056
Worker	0.0427	0.0534	0.4946	1.3700e-003	0.1150	8.2000e-004	0.1158	0.0305	7.6000e-004	0.0313		105.6574	105.6574	5.2400e-003		105.7675
Total	0.1875	1.1500	2.3953	4.6700e-003	0.2079	0.0172	0.2251	0.0570	0.0158	0.0728		425.9114	425.9114	7.7000e-003		426.0731

ATTACHMENT B
Estimated Operational Emissions

Estimated Annual Source	Energy Consumption Rate MWh	Annualized Energy Consumption	Metric tons CO2/year*
Original 2006 EIR	36	315,798	89,687
50 MGD of Production Capacity	33.5 to 35.9	293,460 to 314,484	83,343 to 89,313
Additional 10 MGD of Capacity (20% increase)	6.7 to 7.2	58,692 to 62,897	16,669 to 17,863
New Screen Motors	0.4	3,504	995
Increased Pumping	1.3	11,388	3,234
Revised EIR	41.9 to 44.8	367,044 to 392,273	104,240 to 111,405

*Using SDG&E's 2014 Emissions Factor.

APPENDIX S-C

Energy Minimization and Greenhouse Gas Reduction Plan

CARLSBAD SEAWATER DESALINATION PROJECT

ENERGY MINIMIZATION AND GREENHOUSE GAS REDUCTION PLAN

DECEMBER 10, 2008

Staff Note:

Key elements of this Plan include:

- *Poseidon's indirect GHG emissions will be calculated using California Air Resources Board (CARB) or California Climate Action Registry (CCAR) methodologies.*
- *Poseidon will be credited with emission offsets that may result from reductions in State Water Project imports.*
- *The offset projects, except for Renewable Energy Credits (RECs), that Poseidon implements pursuant to this Plan will be purchased through/from CARB, CCAR, or any California Air Pollution Control District (APCD) or Air Quality Management District (AQMD). Poseidon may also request that the Executive Director approve projects that may be available from other entities.*

Table of Contents

INTRODUCTION 4

 1. Project Overview 5

 2. CCC Draft Emissions Template..... 5

 3. Overview of the Project’s GHG Reduction Strategy 6

PART I. IDENTIFICATION OF THE AMOUNT OF GHG EMITTED 7

 A. Electricity Use by the Project..... 8

 B. SDG&E’s Emission Factor 8

PART II: ON-SITE AND PROJECT-RELATED REDUCTION OF GHG EMISSIONS 9

 A. Increased Energy Efficiency 9

 B. GHG Emission Reduction by Green Building Design..... 12

 C. On-Site Solar Power Generation 13

 D. Recovery of CO₂ 13

 E. Avoided Emissions from Reducing Energy Needs for Water Reclamation..... 15

 F. Avoided Emissions from Displaced Imported Water 16

 G. Avoided Emissions through Coastal Wetlands 18

PART III: IDENTIFICATION OF MITIGATION OPTIONS TO OFFSET ANY REMAINING
 GHG EMISSIONS..... 19

 A. Annual “True-Up” Process 20

 B. Carbon Offsets Projects and Credits 21

 C. Annual Report 23

 D. Contingencies..... 24

 E. Examples of Offset Projects 25

 F. Potential Offset Projects Funded by Poseidon..... 26

 G. Sequestration through Reforestation..... 27

 H. Renewable Energy Partnerships..... 27

 I. Implementation Schedule 28

 J. The Project’s Annual Net-Zero Carbon Emission Balance..... 29

List of Tables

Table 1 – Identification of Gross Indirect CO₂ Emissions from Purchase of Electricity for Project
 Operations 9

Table 2 – Comparison of Baseline and High-Efficiency Power Budget for 50 MGD Water
 Production Capacity 11

Table 3 – State Water Project Supply Energy Use 17

Table 4 – On-site and Project-Related Reduction of GHG Emissions 19

Table 5 – Potential Renewable Energy Partnerships 28

Table 6 – Implementation Schedule for the Plan..... 29

Table 7 – Assessment, Reduction and Mitigation of GHG Emissions 30

List of Figures

Figure 1 – Carlsbad Seawater Desalination Facility 5

Figure 2 – Energy Recovery System for the Carlsbad Seawater Desalination Plant..... 10

Figure 3 – Tampa Bay Desalination Plant Pelton Wheel Energy Recovery System..... 11

CARLSBAD SEAWATER DESALINATION PROJECT

ENERGY MINIMIZATION AND GREENHOUSE GAS REDUCTION PLAN

DECEMBER 10, 2008

INTRODUCTION

In October 2007, Poseidon Resources (Poseidon) offered as part of its Carlsbad Desalination Project (Project) a commitment to account for and bring to zero the net indirect Greenhouse Gas (GHG) emissions from the Project. Poseidon followed its unprecedented commitment with the development of a Climate Action Plan (CAP), Poseidon's roadmap to achieving its commitment over the 30-year life of the Project. Based on protocols adopted by the California Climate Action Registry (CCAR), the CAP was reviewed by the California Coastal Commission (CCC), the California State Lands Commission (CSLC), the California Air Resources Board (CARB) and, at the request of a Coastal Commissioner, the South Coast Air Quality Management District (SCAQMD).

On November 15, 2007, the CCC approved the Project subject to the condition, among others, that the CCC approve the CAP at a subsequent hearing. Specifically, Special Condition 10 states that "prior to issuance of the permit, the Permittee shall submit to the Commission a Revised Energy Minimization and Greenhouse Gas Reduction Plan (the Plan) that addresses comments submitted by the staffs of the Coastal Commission, State Lands Commission and the California Air Resources Board. The permit shall not be issued until the Commission has approved a Revised Energy Minimization and Greenhouse Gas Reduction Plan after a public hearing." Since the Special Condition was adopted, Poseidon has reviewed comments from the November 15 hearing as well as CCC staff's draft findings, and continued to work with the CCC, CSLC and CARB to refine the CAP and ensure a complete understanding of the process it sets forth to meet Poseidon's commitments.

On May 2, 2008, Poseidon met with representatives of the CCC, CSLC and various agencies in the San Diego region to further discuss details of the Plan and its implementation. The purpose of this document is to present Poseidon's revised Plan in response to the additional comments received, the May 2 meeting, and the draft CCC Template.

1. PROJECT OVERVIEW

The 50 million gallon per day (MGD) Project (Figure 1) is co-located with the Encina generation station, which currently uses seawater for once-through cooling. The Project is developed as a public-private partnership between Poseidon and nine local utilities and municipalities.

In 2006, California legislation introduced the AB 32 Global Warming Solutions Act that aims to reduce the GHG emissions of the state to 1990 levels by year 2020. While it is unlikely that the

legislation or its implementing regulations will apply to the Project because the Project only emits significant GHGs indirectly through electricity use,¹ Poseidon applauds the objectives of AB 32 and is committed to helping California maintain its leadership role in addressing the causes of Climate Change. As a result, Poseidon has committed to offset the net indirect GHG emissions associated with the Project's operations. Poseidon's offer has been incorporated into the Project's permit through Special Condition 10, adopted by the California Coastal Commission and agreed to by Poseidon. According to Special Condition 10 and CCC staff direction, Poseidon is required to submit a plan for Commission review and approval showing how the Project will minimize its electricity use and reduce indirect GHG emissions resulting from net increases in electricity use over existing conditions.



Figure 1 - Carlsbad Seawater Desalination Project

2. CCC DRAFT EMISSIONS TEMPLATE

The draft CCC Template establishes “a protocol for how to assess, reduce, and mitigate the GHG emissions of applicants,” and calls for the organization of relevant information into the following three sections:

¹ AB 32's implementing regulations are currently being drafted and will subsequently be released for public comment. AB 32's regulations, when promulgated, will likely target direct emitters of GHGs, including SDG&E (the source of the Project's electricity), rather than indirect emitters such as the Project. In any case, Poseidon will modify its Plan to conform with these regulations to the extent that they are applicable to the Project.

1. Identification of the amount of indirect GHGs due to the Project's electricity use,
2. On-Site and Project related measures planned to reduce emissions, and
3. Off-site mitigation options to offset remaining emissions.

After a brief explanation of Poseidon's overall strategy for eliminating the Project's net indirect GHG emissions, this document then organizes the Plan into the CCC's three general categories.

3. OVERVIEW OF THE PROJECT'S GHG REDUCTION STRATEGY

Since offsetting net indirect GHG emissions is an ongoing process dependent on dynamic information, Poseidon's Plan for the assessment, reduction and mitigation of GHG emissions establishes a protocol for identifying, securing, monitoring and updating measures to eliminate the Project's net carbon footprint. Once the Project is operational and all measures to reduce energy use at the site have been taken, the protocol involves the following steps, completed each year:

1. Determine the energy consumed by the Project for the previous year using substation(s) electric meter(s) readings from San Diego Gas & Electric's (SDG&E) or any other entity from which the Project obtains all or part of its electricity at any time in the future.
2. Determine SDG&E emission factor for delivered electricity from its most recently published CCAR Annual Emissions Report. Reports are issued annually and are accessible on the CCAR's website. Emission factors will be obtained from CARB if and when SDG&E's certified emission factor for delivered electricity is publicly available through CARB's anticipated GHG Inventory program. If at any time in the future the Project obtains all or part of its electricity from an entity other than SDG&E, the appropriate CCAR or CARB emission factor for that entity shall be used. While current emissions reports only report CO₂, future reports are expected to include the five additional GHGs (methane, nitrous oxide, hydrofluorocarbons, perfluorocarbons, and sulphur hexafluoride). To the extent that these additional GHGs are included in future reports, they will be converted to carbon equivalents for the Project and offset under the Plan.
3. Calculate the Project's gross indirect GHG emissions resulting from Project operations by multiplying its electricity use by the emission factor.
4. Calculate the Project's net indirect GHG emissions by subtracting emissions avoided as a result of the Project (Avoided Emissions) and any existing offset projects and/or Renewable Energy Credits (RECs). Each year's amount of net indirect GHG emissions will be determined using CARB or CCAR emissions factors for SDG&E and the State Water Project.
5. If necessary, implement carbon offset projects and purchase carbon offsets or RECs to zero-out the Project's net indirect GHG emissions; Subject to the provisions of Sections III.C, E and F below: (i) Offset projects, except for RECs, implemented pursuant to this Plan will be purchased through/from CARB, CCAR, or a California APCD or AQMD

and (ii) Poseidon may propose purchasing other offset projects, subject to Executive Director or Commission approval, in the event that sufficient offsets are not available from CCAR/CARB/California APCD or AQMD at a price that is reasonably equivalent to the price for offsets in the broader domestic market.

Energy efficiency measures and on-site use of renewable resources will be given the highest priority. In addition, through its annual program to offset net carbon emissions for that year, Poseidon will commit the first \$1 million spent on this program to fund the revegetation of areas in the San Diego region impacted by wildfires that occurred in the fall of 2007, as discussed in detail in Part III below.² Poseidon will implement this element of the Plan using CARB or CCAR Forest Project Protocols or the upcoming CARB/CCAR Urban Forest Project Protocol, depending on the type of project Poseidon selects.

The following are elements of the Plan organized in accordance with the draft CCC template.

PART I. IDENTIFICATION OF THE AMOUNT OF GHG EMITTED

The Project will produce fresh drinking water using reverse osmosis membrane separation. The treatment processes used at the Plant do not generate GHGs. The desalination process does not involve heating and vaporization of the source seawater and thus does not create emissions of water vapor, carbon dioxide, methane, nitrous oxide, hydrofluorocarbons (HFCs), perfluorocarbons (PFCs), or sulfur hexafluoride (SF6). Reverse osmosis membranes do not reject the carbon dioxide, which is naturally dissolved in the source seawater, and this carbon dioxide is retained in dissolved form in the fresh drinking water created by desalination.

The modest number of fleet vehicles used by plant personnel will create a small amount of GHG emissions, but since these emissions make up less than 5% of the Project's carbon footprint, these emissions are considered *de minimis* and are not required to be reported (CCAR General Reporting Protocol of March 2007 (Chapter 5)). The Project will not store or use fossil fuels on site, and will not self-generate electricity that emits GHGs. As a result, Project operations will not create significant direct sources of GHG emissions. There are no direct fugitive emissions from the plant.

The Project's sole significant source of GHG emissions will be indirect emissions resulting from purchased electricity. All of the electricity supply for the desalination plant operations will be provided by SDG&E. Therefore, the complete accounting of significant GHG emissions for the Project will consist entirely of indirect emissions resulting from electricity purchased from SDG&E.³

² The California Coastal Commission conditioned the Project's Coastal Development Permit on Poseidon committing the first \$1 million spent on this program to the revegetation of areas impacted by wildfires in the San Diego region.

³ Typically, GHG emissions from construction of a project are not included in the on-going reporting of GHGs from operations. In fact, GHGs from construction are not typically accounted for in a GHG inventory at all.

Currently, about 65% of the electricity supplied by SDG&E is generated from fossil fuels.⁴ As a result, until SDG&E switches to 100% “green” power supply sources, the Project operations will be indirectly linked to the generation of GHGs.

The total net indirect GHG emissions of the Project from the stationary combustion of fossil fuels to generate electricity is dependent on three key factors: (1) how much electricity is used by the Project; (2) sources of energy (fossil fuels, wind, sunlight, etc.) used to generate the electricity supplied to the plant, and (3) the Avoided Emissions, i.e., the amount of energy saved or emissions avoided as a direct result of the Project’s operations. These factors will vary over time.

A. ELECTRICITY USE BY THE PROJECT

The Project will operate continuously, 24 hours a day for 365 days per year, to produce an average annual drinking water flow of 50 million gallons per day (MGD). The total baseline power use for this plant is projected to be 31.3 average megawatts (aMW), or 4.9 MWh per acre-foot (AF) of drinking water. The power use incorporates both production of fresh drinking water, as well as conveyance and delivery of the water to the distribution systems of the public water agencies that have contracted to purchase water from the Project. The total annual electricity consumption for the Project Baseline Design is 274,400 MWh/yr.

B. SDG&E’S EMISSION FACTOR

The Project will purchase all of its electricity from SDG&E.⁵ Accordingly, the appropriate emission factor to use for the Project’s indirect GHG emissions from its electricity use is SDG&E’s independently verified and published emission factor for the electricity purchased and consumed during the previous year. The certified emission factor for delivered electricity in 2006 is set forth in the utility’s Annual Emissions Report published by CCAR in April 2008. In the published Emissions Report, the current certified emission factor for SDG&E’s 2006 delivered electricity is 780.79 lbs of CO₂ per delivered MWh of electricity.

Circumstances will change over the life of the Project. SDG&E’s emission factors are updated annually and the amount of energy consumed by the Project may change.⁶ As a result, it will be necessary to recalculate the net indirect GHG emissions of the Project on an annual basis using the actual SDG&E emission factor reported to the CCAR (or CARB). Until the mandatory reporting of emission factors under AB 32 is available, the emission factors for SDG&E registered with CCAR are the best available for purposes of planning and permitting this Project.

⁴ SDG&E Power Content Label, September 2007.

⁵ If at any time in the future the Project obtains all or part of its electricity from an entity other than SDG&E, the appropriate CCAR emission factor for that entity shall be used.

⁶ SDG&E Annual Emissions Reports to CCAR have changed each year. For years, 2004, 2005, and 2006 the emissions factors have been 614, 546 and 781 lbs. of CO₂/MWh, respectively.

Statewide initiatives to expand the use of renewable sources of electricity are expected to decrease the emission factors of all California power suppliers in the future. For example, approximately 6% of SDG&E’s retail electricity is currently generated from renewable resources (solar, wind, geothermal, and biomass).⁷ In their most-recent Long-term Energy Resource Plan, SDG&E has committed to increase energy from renewable sources by 1% each year, reaching 20% by year 2017. These and other reductions are expected to further reduce the Project’s net indirect GHG emissions over time.

Table 1 summarizes the Project’s estimated gross indirect CO₂ emissions from purchased electricity for Project operations, based on the most current information.

Table 1 – Identification of Gross Indirect CO₂ Emissions from Purchase of Electricity for Project Operations

Source	Total Annual Power Use (MWh/year)	Total Annual Emissions (metric tons CO₂/year)
Project Baseline Design	274,400	97,165

PART II: ON-SITE AND PROJECT-RELATED REDUCTION OF GHG EMISSIONS

To determine the Project’s indirect GHG emissions, on-site and project-related reductions in emissions must also be considered. These are carbon emission reductions that result from measures that reduce energy requirements (increased energy efficiency, potential onsite solar, recovery of CO₂ and green building design), as well as Project-related emissions that will be avoided (Avoided Emissions) as a direct result of the Project and its various components (coastal wetlands restoration, reduced energy use from water reclamation, and replacing Customers’ SWP water with water from the Project). The total of each year’s indirect GHG emissions,—be determined using CARB- or CCAR-approved emissions factors for SDG&E and the State Water Project.

A. INCREASED ENERGY EFFICIENCY

Poseidon has committed to implement certain measures to reduce the Project’s energy requirements and GHG emissions, and will continuously explore new technologies and processes to further reduce and offset the carbon footprint of the Project, such as the use of carbon dioxide from the ambient air for water treatment. These measures are set forth below.

⁷ SDG&E Power Content Label, September 2007.

The Project’s high-energy efficiency design incorporates state-of-the-art features minimizing plant energy consumption. One such feature is the use of a state-of-the-art pressure exchanger based energy recovery system that allows recovery and reuse of 33.9% of the energy associated with the reverse osmosis (RO) process. A significant portion of the energy applied in the RO process is retained in the concentrated stream. This energy bearing stream (shown with red arrows on Figure 2) is applied to the back side of pistons of cylindrical isobaric chambers, also known as “pressure exchangers” (shown as yellow cylinders on Figure 2). These energy exchangers recover and reuse approximately 45% of the energy used by the RO process.⁸

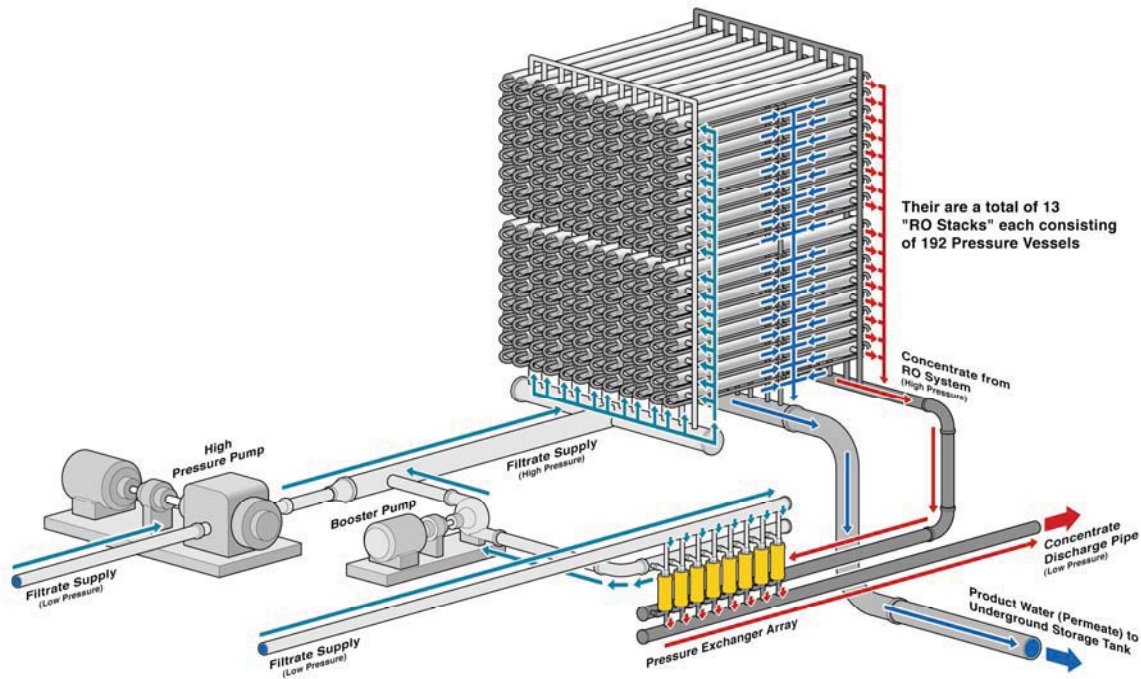

Figure 2 – Energy Recovery System for the Carlsbad Seawater Desalination Plant

Currently there are no full-scale seawater desalination plants in the US using the proposed state-of-the-art pressure exchanger energy recovery technology included in the “High Efficiency Design” (Table 2). All existing seawater desalination projects in the US, including the 25 MGD Tampa Bay seawater desalination plant, which began commercial operation on January 25, 2008, are using standard energy recovery equipment — i.e., Pelton wheels (see Figure 2). Therefore, the Pelton wheel energy recovery system is included in the “Baseline Design” in Table 2.

The pressure exchanger technology that Poseidon proposes to use for the Project is a national technology. The manufacturer of the pressure exchangers referenced in Table 2 of the Project

⁸ The “45% percent energy recovery and reuse” refers to the gross energy recovery potential, while the “33.9% energy recovery and reuse” refers to the actual energy savings associated with the energy recovery system. The difference between gross and actual energy savings is due to mechanical inefficiencies of the recovery system and associated friction losses. Thus, for purposes of calculating the overall energy savings, Table 2 correctly reflects 33.9% savings associated with the pressure exchanger.

Power Budget is Energy Recovery, Inc., a US company located in San Leandro, California (www.energyrecovery.com).

A pilot-scale seawater desalination plant using the pressure exchanger technology proposed by Poseidon and supplied by Energy Recovery, Inc. has been in operation at the US Navy's Seawater Desalination Testing Facility in Port Hueneme, California since 2005. The overall capacity of this desalination plant is 50,000 to 80,000 gallons per day. The pilot testing work at this facility has been conducted by the Affordable Desalination Collaboration (ADC), which is a California non-profit organization composed of a group of leading companies and agencies in the desalination industry (www.affordabledesal.com). A portion of the funding for the operation of this facility is provided by the California Department of Water Resources (DWR) through the state's Proposition 50 Program. The DWR provides independent oversight of this project and reviews project results. In addition, representatives of the California Energy Commission and the California Department of Public Health are on the Board of Directors of the ADC.

The proposed pressure exchanger technology (i.e., the same pressure exchanger employed at the ADC seawater desalination plant) was independently tested at Poseidon's Carlsbad seawater desalination demonstration plant. More than one year of testing has confirmed the validity of the conclusions of the ADC for the site-specific conditions of the Project. The test results from the Carlsbad seawater desalination demonstration plant were used to calculate the energy efficiency of the pressure exchangers included in Table 2. Poseidon's technology evaluation work at the Carlsbad seawater desalination demonstration plant was independently reviewed and recognized by the American Academy of Environmental Engineers and by the International Water Association, who awarded Poseidon their 2006 Grand Prize in the field of Applied Research.

Table 2 - Comparison of Baseline and High-Efficiency Power Budget for 50 MGD Water Production Capacity

Unit	Baseline Design - Power Use			High Efficiency Design - Power Use			Additional Costs for Premium Efficiency Equipment (US\$2008)
	(Hp)	Equipment Efficiency	Equipment Type	(Hp)	Equipment Efficiency	Equipment Type	
Key Treatment Process Pumps							
Power Plant Intake Pumps (Stand-Alone Operation)	3,750	70%	High Efficiency Motors - No VFDs	3,750	70%	High Efficiency Motors - No VFDs	None
Seawater Intake Pumps	2,100	70%	High Efficiency Motors - No VFDs	1,838	80%	Premium Efficiency Motors - VFDs	US\$0.7 MM
Reverse Osmosis Pumps	30,100	82%	Premium Efficiency Motors - No VFDs	30,100	82%	Premium Efficiency Motors - No VFDs	None
Energy Recovery System - Power Reduction	(7,550)	-25.1%	Pelton Wheels	(10,200)	-33.9%	Pressure Exchangers	US\$5.0 MM
Product Water Transfer Pumps	10,680	70%	High Efficiency Motors - No VFDs	9,350	80%	Premium Efficiency Motors & VFDs	US\$3.4 MM
Pretreatment Filter Service Equipment							
Microscreen Pumps	150	65%	High Efficiency Motors - No VFDs	150	65%	High Efficiency Motors - No VFDs	None
Ultrafiltration Vacuum Pumps	780	70%	High Efficiency Motors - No VFDs	680	80%	Premium Efficiency Motors - with VFDs	US\$0.3 MM
Filter Backwash Blowers	400	70%	High Efficiency Motors - No VFDs	400	70%	High Efficiency Motors - No VFDs	None
Backwash Pumps	160	70%	High Efficiency Motors - No VFDs	160	70%	High Efficiency Motors - No VFDs	None
Backwash Equalization Basin Blowers	80	70%	High Efficiency Motors - No VFDs	80	70%	High Efficiency Motors - No VFDs	None
UF and RO Membrane Cleaning Systems							
Membrane Cleaning Pumps	30	70%	High Efficiency Motors - No VFDs	30	70%	High Efficiency Motors - No VFDs	None
Scavenger Tank Mixing System	50	70%	High Efficiency Motors - No VFDs	50	70%	High Efficiency Motors - No VFDs	None
Flush Pumps	150	70%	High Efficiency Motors - No VFDs	150	70%	High Efficiency Motors - No VFDs	None
Cleaning Chemicals System	15	70%	High Efficiency Motors - No VFDs	15	70%	High Efficiency Motors - No VFDs	None
Sewer System Transfer Pumps	15	65%	High Efficiency Motors - No VFDs	15	65%	High Efficiency Motors - No VFDs	None
Chemical Feed Equipment							
Polymer Feed System	15	65%	High Efficiency Motors - No VFDs	15	65%	High Efficiency Motors - No VFDs	None
Ammonia Feed System	30	65%	High Efficiency Motors - No VFDs	30	65%	High Efficiency Motors - No VFDs	None
Lime Feed System	200	65%	High Efficiency Motors - No VFDs	200	65%	High Efficiency Motors - No VFDs	None
Carbon Dioxide Feed System	30	65%	High Efficiency Motors - No VFDs	30	65%	High Efficiency Motors - No VFDs	None
Sodium Hypochlorite Feed System	40	65%	High Efficiency Motors - No VFDs	40	65%	High Efficiency Motors - No VFDs	None
Other Chemical Feed Systems	10	65%	High Efficiency Motors - No VFDs	10	65%	High Efficiency Motors - No VFDs	None
Service Facilities							
HVAC	260	80%	High Efficiency Equipment	250	80%	High Efficiency Equipment	None
Lightning	120	80%	High Efficiency Equipment	120	80%	High Efficiency Equipment	None
Controls and Automation	40	80%	High Efficiency Equipment	40	80%	High Efficiency Equipment	None
Air Compressors	100	80%	High Efficiency Equipment	100	80%	High Efficiency Equipment	None
Other Miscellaneous Power Uses	250	80%	High Efficiency Equipment	250	80%	High Efficiency Equipment	None
TOTAL DESALINATION PLANT POWER USE	42,005			37,653			



Figure 3 - Tampa Bay Desalination Plant Pelton Wheel Energy Recovery System

Table 2 presents a detailed breakdown of the projected power use of the Project under a Baseline Design and High-Energy Efficiency Design. As indicated in this table, the Baseline Design includes high efficiency motors for all pumps, except the largest reverse osmosis feed pumps, and a Pelton wheel energy recovery system, which is the most widely used “standard” energy recovery system today. The total desalination power use under the Baseline Design is 31.3 aMW, which corresponds to a unit power use of 15.02 kWh/kgal⁹ (4,898 kWh/AF).¹⁰

In addition to the state of the art-pressure exchanger system described above, the High-Energy Efficiency Design incorporates premium efficiency motors and variable frequency drives (VFDs) on desalination plant pumps that have motors of 500 horsepower or more. The total desalination plant energy use under the High-Energy Efficiency Design is 28.1 aMW, which corresponds to unit power use of 13.488 kWh/kgal¹¹ (4,397kWh/AF).¹²

The main energy savings result from the use of pressure exchangers instead of Pelton wheels for energy recovery. The pressure exchangers are projected to yield 2,650 hp (2.0 aMW)¹³ of power savings, which is 6.3 % reduction of the total power use of 31.3 aMW. Converted into unit power savings, the energy reduction of 2.0 aMW corresponds to 0.95 kWh/kgal¹⁴ (310 kWh/AF)¹⁵. The installation of premium-efficiency motors and VFDs on large pumps would result in additional 1.2 aMW (4%) of power savings.

The power savings of 0.95 kWh/kgal associated with the use of pressure exchangers instead of Pelton wheels for energy recovery are substantiated by information from several full-scale desalination plants which have recently replaced their existing Pelton wheel energy recovery systems with pressure exchangers in order to take advantage of the energy savings offered by this technology. Poseidon’s submission of this Plan to the Commission included documentation entitled “Energy Recovery in Caribbean Seawater”, which contains energy data for a seawater desalination plant in Mazarron, Spain where a Pelton wheel system was replaced with PX pressure exchangers. As indicated on Table 2 of Attachment 1, the replacement resulted in energy reduction from 3.05 kWh/m³ to 2.37 kWh/m³ (i.e., 0.68 kWh/m³ or 2.57 kWh/kgal). The total actual energy reduction resulting from the use of state-of-the-art desalination and energy recovery technologies and design will be verified by direct readings of the total electricity

⁹ 31.3 MWh x 1,000 kW/MW/Average Fresh Water Production Rate of 2083 kg/h.

¹⁰ 15.02 kWh/kgal x 326 kgal/AF.

¹¹ 28.1 MWh x 1,000kW/MW/2083 kgal/h.

¹² 13.488 KWh/kgal x 326 kgal/AF.

¹³ 2650 HP x 0.746 kw/HP

¹⁴ 2.0 x 1000 kw/MW/2083kgal/HR

¹⁵ 0.95 kwh/kgal x 326 kgal/AF

consumed by the desalination plant at the Project's substation(s) electric meter(s) and documented as soon as the Project is fully operational.

B. GHG EMISSION REDUCTION BY GREEN BUILDING DESIGN

The Project will be located on a site currently occupied by an oil storage tank no longer used by the power plant. This tank and its content will be removed and the site will be reused to construct the Project. Because the facility is an industrial facility, LEED-level certification will not be feasible; but to the extent reasonably practicable, building design will follow the principles of the Leadership in Energy and Environmental Design (LEED) program. LEED is a program of the United States Green Building Council, developed to promote construction of sustainable buildings that reduce the overall impact of building construction and functions on the environment by: (1) sustainable site selection and development, including re-use of existing industrial infrastructure locations; (2) energy efficiency; (3) materials selection; (4) indoor environmental quality, and (5) water savings.

The potential energy savings associated with the implementation of the green building design as compared to that for a standard building design are in a range of 300 MWh/yr to 500 MWh/yr. The potential carbon footprint reduction associated with this design is between 106 and 177 tons of CO₂ per year. The energy savings associated with incorporating green building design features into the desalination plant structures (i.e., natural lighting, high performance fluorescent lamps, high-efficiency HVAC and compressors, etc.) are based on the assumption that such features will reduce the total energy consumption of the plant service facilities by 6 to 10 %. As indicated in Table 2, the plant service facilities (HVAC, lighting, controls and automation, air compressors and other miscellaneous power uses) are projected to have power use of 760 hp (250 hp + 120 hp + 40 hp + 100 hp + 250 hp = 760 hp) when standard equipment is used. The total annual energy demand for these facilities is calculated as follows; 760 hp x 0.746 kW/hp x 0.001 kW/MW x 24 hrs x 365 days = 4,967 MWh/yr. If use of green building design features result in 6 % of energy savings, the total annual power use reduction of the service facilities is calculated at 0.06 x 4,967 MWh/yr = 298.02 MWh/yr (rounded to 300 MWh/yr). Similarly, energy savings of 10 % due to green building type equipment would yield 0.1 x 4,967 MWh/yr = 496.7 MWh/yr (rounded to 500 MWh/yr) of savings. The total actual energy reduction resulting from the use of the green building design will be verified by direct readings of the total electricity consumed by the desalination plant at the Project's substation(s) electric meter(s) and documented as soon as the Project is fully operational.

C. ON-SITE SOLAR POWER GENERATION

Poseidon is exploring the installation of rooftop photovoltaic (PV) system for solar power generation as one element of its green building design. Brummitt Energy Associates of San Diego completed a feasibility study in March 2007 of a photovoltaic system at the Carlsbad Desalination Plant. If the solar installation described by Brummitt is implemented, the main desalination plant building would accommodate solar panels on a roof surface of approximately 50,000 square feet, with the potential to generate approximately 777 MWh/yr of electricity. If installed, the electricity produced by the onsite PV system would be used by the Project and therefore would reduce the Project's electrical demand on SDG&E. The corresponding reduction of the Project's indirect emissions would be 275 tons of CO₂ per year. Poseidon is

exploring other solar proposals and will update this information as it becomes available. Ultimately, the electricity and corresponding GHG savings of any on-site solar installation will be documented in the Project's annual electricity usage information. Poseidon will use commercially reasonable efforts to implement an on-site solar power project if it is reasonably expected to provide a return on the capital investment over the life of the Project.

If Poseidon proceeds with an onsite PV system, the total actual energy reductions resulting from the use of on-site solar power generation will be verified by direct readings of the total electricity consumed by the desalination plant at the Project's substation(s) electric meter(s) and documented once the system is fully operational.

D. RECOVERY OF CO₂

Approximately 2,100 tons of CO₂ per year are planned to be used at the Project for post-treatment of the product water (permeate) produced by the reverse osmosis (RO) system. Carbon dioxide in a gaseous form will be added to the RO permeate in combination with calcium hydroxide or calcium carbonate in order to form soluble calcium bicarbonate which adds hardness and alkalinity to the drinking water for distribution system corrosion protection. In this post-treatment process of RO permeate stabilization, gaseous carbon dioxide is sequestered in soluble form as calcium bicarbonate. Because the pH of the drinking water distributed for potable use is in a range (8.3 to 8.5) at which CO₂ is in a soluble bicarbonate form, the carbon dioxide introduced in the RO permeate would remain permanently sequestered. During the treatment process the calcium carbonate (calcite CaCO₃) reacts with the carbon dioxide injected in the water and forms completely soluble calcium bicarbonate as follows:¹⁶

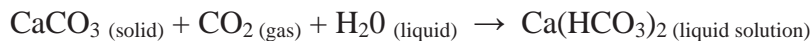

¹⁶ This chemical reaction and information presented on Figure 4 are well known from basic chemistry of water. See American Water Works Association (AWWA) (2007) Manual of Water Supply Practices, M46, Reverse Osmosis and Nanofiltration, Second Edition; <http://www.chem1.com/CO/hardwater.html>; <http://www.cof.edu/etelmodules/waterg3lWOassess3b.html>. Once the desalinated drinking water is delivered to individual households, only a small portion of this water will be ingested directly or with food. Most of the delivered water will be used for other purposes – personal hygiene, irrigation, etc. The calcium bicarbonate ingested by humans will be dissociated into calcium and bicarbonate ions. The bicarbonate ions will be removed by the human body through the urine (<http://www.chemistry.wustl.edu/~courses/genchem/Tutorials/IBuffers/carbonic.htm>). Since the CO₂ is sequestered into the bicarbonate ion, human consumption of the desalinated water will not result in release of CO₂. The bicarbonate in the urine will be conveyed along with the other sanitary sewerage to the wastewater treatment plant. Since the bicarbonate is dissolved, it will not be significantly impacted by the wastewater treatment process and ultimately will be discharged to the ocean with the wastewater treatment plant effluent. The ocean water pH is in a range of 7.8 to 8.3, which would be adequate to maintain the originally sequestered CO₂ in a soluble form – see Figure 4 above. Other household uses of drinking water, such as personal hygiene, do not involve change in drinking water pH as demonstrated by the fact that pH of domestic wastewater does not differ significantly from that of the drinking water. A portion of the household drinking water would likely be used for irrigation. A significant amount of the calcium bicarbonate in the irrigation water would be absorbed and sequestered in the plant roots (<http://www.Dubmedcentral.nih.gov/paerender.fcgi?artid=540973&paeindex=1>). The remaining portion of calcium bicarbonate would be adsorbed in the soils and/or would enter the underlying groundwater aquifer.

At the typical pH range of drinking water (pH of 8.3 to 8.5) the carbon dioxide will remain in the drinking water in soluble form (see Figure 4) and the entire amount (100 %) of the injected carbon dioxide will be completely dissolved.

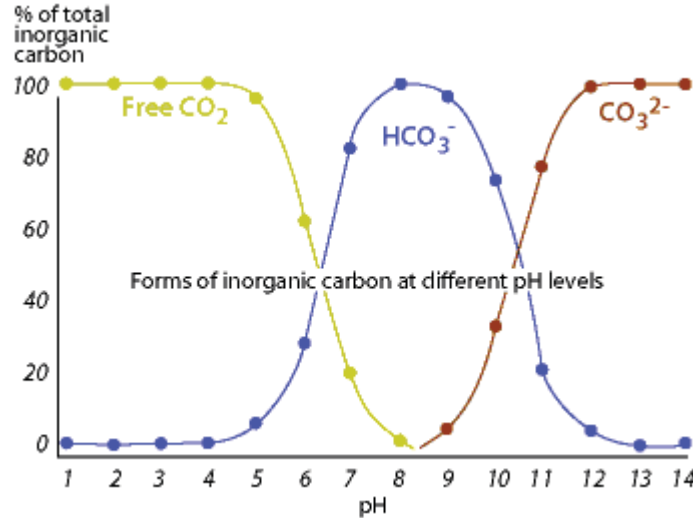

Figure 4 -- Relationship between free carbon and pH

(Source: <http://www.cotf.edu/ete/modules/waterq3/WQassess3b.html>)

A small quantity of carbon dioxide used in the desalination plant post-treatment process is sequestered directly from the air when the pH of the source seawater is adjusted by addition of sulfuric acid in order to prevent RO membrane scaling. A larger amount of CO₂ would be delivered to the Project site by commercial supplier for addition to the permeate. Depending on the supplier, carbon dioxide is of one of two origins: (1) a CO₂ Generating Plant or (2) a CO₂ Recovery Plant. CO₂ generating plants use various fossil fuels (natural gas, kerosene, diesel oil, etc.) to produce this gas by fuel combustion. CO₂ recovery plants produce carbon dioxide by recovering it from the waste streams of other industrial production facilities which emit CO₂ rich gasses: breweries, commercial alcohol (i.e., ethanol) plants, hydrogen and ammonia plants, etc. Typically, if these gases are not collected via CO₂ recovery plant and used in other facilities, such as the desalination plant, they are emitted to the atmosphere and therefore, constitute a GHG release.

To the extent that it is reasonably available, Poseidon intends to acquire the carbon dioxide from a recovery operation. Use of recovered CO₂ at the Project would sequester 2,100 tons of CO₂ per year in the Project product water. The total annual use of carbon dioxide (i.e., 2,100 tons/CO₂ per year) in the water treatment process was determined based on the daily carbon dioxide consumption presented in Table 4.6-2 of Section 4.6 “Hazards and Hazardous Materials” of the certified Carlsbad desalination project Environmental Impact Report (EIR). The daily consumption of CO₂ in this table is 12,540 lbs of CO₂/day. The annual consumption is calculated as 12,540 lbs/day x 365 days /2,200 lbs/ton = 2,080.5 lbs of CO₂/yr (which was rounded to 2,100 lbs/yr). The daily amount of carbon dioxide in Table 4.6-2 of the EIR was calculated based on the dosage needed to provide adequate hardness (concentration of calcium

bicarbonate) in the seawater to protect the water distribution system from corrosion. This amount was determined based on pilot testing of distribution system piping and household plumbing at the Carlsbad seawater desalination demonstration project. The testing was completed using the same type of calcium carbonate chips as those planned to be used in the full-scale operations. Every load of carbon dioxide delivered to the desalination plant site will be accompanied by a certificate that states the quantity, quality and origin of the carbon dioxide and indicates that this carbon dioxide was recovered as a site product from an industrial application of known type of production (i.e., brewery, ethanol plant, etc.), and that it was purified to meet the requirements associated with its use in drinking water applications (i.e., the chemical is NSF approved). The plant operations manager will receive and archive the certificates for verification purposes. At the end of the year, the operations manager will provide copies of all certificates of delivered carbon dioxide to the independent third party reviewer (currently the California Center for Sustainable Energy) responsible for verification of facility compliance with the Energy Minimization and Greenhouse Gas Reduction Plan.

As noted, verification would be provided through certificates of origin received from suppliers of CO₂ delivered to the Project site indicating the actual amount of CO₂ delivered to the site, date of delivery, origin of the CO₂, and the purity of this gas. Poseidon will place conditions in its purchase agreements with CO₂ vendors that require transfer of CO₂ credits to Poseidon and otherwise ensure that the CO₂ is not accounted for through any other carbon reduction program so as to avoid “double counting” of associated carbon credits.

E. AVOIDED EMISSIONS FROM REDUCING ENERGY NEEDS FOR WATER RECLAMATION

The Project will result in Avoided Emissions because it will cause a change in operations by the Carlsbad Municipal Water District (CMWD), which owns and operates a water reclamation facility that includes micro-filtration (MF) and RO treatment for 25% of its water supply. The purpose of the MF/RO system is to reduce the salinity of the recycled water to below 1,000 mg/L so it will be suitable for irrigation. The elevated salinity of the recycled water is due in part to the salinity of the City’s drinking water supply.

The Project will effectively eliminate this problem by lowering the salinity in the source water of the communities upstream of the water recycling facility, thereby eliminating the need for operation of the MFIRO portion of the water recycling process. Implementation of the Project will significantly reduce or possibly eliminate the need to operate the MFIRO system, leading to Avoided Emissions from the lower electricity use by CMWD. This will reduce the carbon footprint of the Carlsbad Water Reclamation Facility as follows: 1,950 MWh/yr x 780.79 lbs of CO₂/MWh = 1,522,541 lbs of CO₂/yr (690 tons of CO₂/yr).

The total actual energy reduction that would result from the higher quality water use upstream of the water recycling facility will be verified annually by CMWD, using actual billing and performance data. This will be accomplished through a comparison of the pre-Project energy use attributable to the RO/MF portion of the water recycling process to the post-Project energy use.

F. AVOIDED EMISSIONS FROM DISPLACED IMPORTED WATER

Another source of Avoided Emissions will result from the Project’s introduction of a new, local source of water into the San Diego area; water that will displace imported water now delivered to Customers from the State Water Project (SWP) – a system with its own significant energy load and related carbon emissions.

One of the primary reasons for the development of the Project is to replace imported water with a locally produced alternative drought-proof source of water supply. Currently, San Diego County imports approximately 90% of its water from two sources – the SWP and the Colorado River. These imported water delivery systems consist of a complex system of intakes, dams, reservoirs, aqueducts and pump stations, and water treatment facilities.

The proposed Project will supply 56,000 acre-feet of water per year to the San Diego region. The Project will provide direct, one-to-one replacement of imported water to meet the requirements of the participating water agencies, thus eliminating the need to pump 56,000 acre feet of water into the region.¹⁷

The 2003 multi-state Colorado River quantitative settlement agreement forced Metropolitan Water District of Southern California (MWD) to reduce its pumping from the Colorado River by 53% – from 1.20 MAFY to 0.56 MAFY. As a result, MWD now operates its imported water delivery system to base load its Colorado River allotment and draw from the SWP only as needed to serve demand that cannot be met by the lower cost water available from the Colorado River Aqueduct. Consequently, the proposed Project will reduce the Customers demand on the SWP.

The total amount of electricity needed to provide treated water to Poseidon’s public agency partners via the SWP facilities is shown in Table 1. The net power requirement to pump an acre-foot of water through the East Branch of the SWP is 3,248 KWh (source: DWR). Approximately 2% of the SWP water pumped to Southern California is lost to evaporation from Department of Water Resources’ reservoirs located south of the Tehachapi Mountains (source: DWR). The evaporation loss results in a net increase of 68.3 KWh per acre-foot of SWP water actually delivered to Southern California homes and businesses. Finally, prior to use, the SWP water must be treated to meet Safe Drinking Water Act requirements. The San Diego County Water Authority (SDCWA) entered into a service contract with CH2M Hill Constructors, Inc., to operate its Twin Oaks Water Treatment Plant with a guaranteed electricity consumption of 100 KWh/AF of water treated (source: SDCWA). The electricity required to deliver an acre-foot of treated water to the SDCWA is shown in Table 3.

Table 3 – State Water Project Supply Energy Use

Energy Demand	KWh/AF	Source
Pumping Through East Branch	3248	DWR
Evaporation Loss	68	DWR

¹⁷ See Poseidon Resources Corporation *Letter to Paul Thayer Re: Desalination Project’s Impact on Imported Water Use*, November 8, 2007, including attachments from nine water agencies (Attached as Appendix E).

Twin Oaks Water Treatment Plant	100	SDCWA
Total	3416	

The reduction of demand for imported water is critical to Southern California’s water supply reliability, so much so that MWD not only supports the Project, but has also committed \$14 million annually to reduce the cost to Poseidon’s customers. Under MWD’s program, \$250 will be paid to water agencies for every acre-foot of desalinated water purchased from the Carlsbad facility, *so long as the desalinated water offsets an equivalent amount of imported water*. MWD has established “Seawater Desalination Policy Principles and Administrative Guidelines” that require recordkeeping, annual data submittals, and MWD audit rights to ensure that MWD water is offset.¹⁸

The benefits of a reduction in demand on MWD’s system are reflected in, among other things, the energy savings resulting from the pumping of water that – but for the Project – would have to continue. For every acre-foot of SWP water that is replaced by water from the proposed Project, 3.4 MWh of electricity use to deliver water to Customers is avoided, along with associated carbon emissions. And since the Project requires 4.4 MWh of electricity to produce one acre-foot of water, the net electricity required to deliver water from the Project to Customers is 1.0 MWh/AF.

Because the Project will avoid the use of 56,000 AFY of imported water to Customers, once in operation, the Project will also avoid 190,641 MWh/yr of electricity consumption otherwise required to deliver that water to Customers, as well as the GHG emissions associated with pumping, treatment and distribution of this imported water. At 780.79 lbs CO₂per MWh,¹⁹ the total expected Avoided Emissions as a result of the Project is 67,506 metric tonsCO₂/yr. Each year, Poseidon will be credited with Avoided Emissions based on the most recent SWP emission factors and the amount of water Poseidon produces.

G. AVOIDED EMISSIONS THROUGH COASTAL WETLANDS

The Project also includes the restoration and enhancement of marine wetlands. The restoration project will be in the proximity of the Project. These wetlands will be set-aside and preserved for the life of the Project. Once the wetlands are restored, they will act as a carbon “sink” or carbon sequestration project trapping CO₂.

Tidal wetlands are very productive habitats that remove significant amounts of carbon from the atmosphere, a large portion of which is stored in the wetland soils. While freshwater wetlands also sequester CO₂, they are often a measurable source of methane emissions. Coastal wetlands

¹⁸ MWD’s program is documented in a June 22, 2007 letter from its General Manager to Peter Douglas, Executive Director of the California Coastal Commission, as well as various contracts with relevant water agencies.

¹⁹ Since the SWP does not have a published Annual Emissions Report with the CCAR, Poseidon used the certified emission factor for SDG&E system. Poseidon believes this a conservative estimate and will update its calculations when more accurate data is available.

and salt marshes, however, release negligible amounts of greenhouse gases and therefore, their carbon sequestration capacity is not measurably reduced by methane production.

Based on a detailed study completed in a coastal lagoon in Southern California, the average annual rate of carbon sequestration in coastal wetland soils is estimated at 0.033 kg of C/m².yr (a 5,000-year average, Brevick E.C. and Homburg J.A., 2004).²⁰ In tidal ecosystems, sediment accumulation rates (via suspended sediment supply, tidal water flooding, etc.) exert a major control on carbon sequestration rates. Soil carbon sequestration rates determined recently in the Tijuana Estuary on the Mexico/USA border were determined to be 0.343 kg of C/m².yr (Cahoon et. al 1996).²¹ (4 = Cahoon, D.R., J.C. Lynch, and A. Powell, Marsh vertical accretion rates in a Southern California estuary, U.S.A., Estuar. Coast. Shelf Sci., 43, 19-32, 1996).

Given that the total area of the proposed wetland project is 37 acres, the carbon sequestration potential of the wetlands is between 4.9 and 51 tons of C/m².yr. These numbers are calculated as follows: Sequestration Rate (.033 kg of C/m².yr and 0.343 kg of C/m².yr) x Area (37 acres = 149,732.5 m²) x Weight conversion (1000 kg C = 1 metric ton of C) = tons of C sequestered/m².yr (as given above). To get from this unit the standard greenhouse gas unit of tons of CO₂ (not C) of sequestered per year, the conversion factor is 3.664. Therefore, the emissions avoided from the wetlands are estimated to be between 18 and 188 tons of CO₂ per year.

In order to verify the actual soil carbon sequestration rate of the proposed wetland ecosystem, site-specific measurements will need to be made. Protocols for wetlands are currently being developed for inclusion within the Clean Development Mechanism of the Kyoto Protocol, and Poseidon will use these protocols until CCAR makes its own wetland protocol available.

Table 4 summarizes the expected on-site and project-related reductions of GHG Emissions.

Table 4 – Expected On-site and Project-Related Reduction of GHG Emissions

Source	Total Annual Reductions in Power Use (MWh/year saved)	Total Annual Emissions Avoided (metric tons CO₂/ year avoided)
Reduction due to High-Efficiency Design	(28,244)	(10,001)
Green Building Design	(300 to 500)	(106 to 177)
On-site Solar Power Generation	(0 to 777)	(0 to 275)
Recovery of CO₂	(N/A)	(2,100)
Reducing Energy Needs for Water Recycling	(1,950)	(690)
Reducing Water Importation	(190,641)	(67,506)
Sequestration in Coastal Wetlands	(N/A)	(18 to 188)
Subtotal On-site Reduction Measures	(N/A)	(80,421 to 80,937)

²⁰ [www.slc.ca.gov/Reports/Carlsbad Desalination Plant Response/Attachment 4.pdf](http://www.slc.ca.gov/Reports/Carlsbad%20Desalination%20Plant%20Response/Attachment%204.pdf)

²¹ [www.sfbayjv.org/Jtools/climate/CarbonWtlandsSummarv 07 Trulio.odf](http://www.sfbayjv.org/Jtools/climate/CarbonWtlandsSummarv%2007%20Trulio.odf)

PART III: IDENTIFICATION OF MITIGATION OPTIONS TO OFFSET ANY REMAINING GHG EMISSIONS

Offsite reductions of GHG emissions that are not inherently part of the Project include actions taken by Poseidon to participate in local, regional, state, national or international offset projects that result in the cost-effective reduction of GHG emissions equal to the indirect Project emissions Poseidon is not able to reduce through other measures.²² One such offset project – the expenditure of one million dollars to reforest areas burned out by fires in the San Diego region in the fall of 2007 – has been identified by the CCC as the first priority among these measures. Poseidon will implement this project using the CARB- or CCAR-approved Forest Project Protocol or the upcoming CARB/CCAR Urban Forest Project Protocol, depending on the type of project Poseidon selects. Subject to the provisions of Sections III.C, E and F below, other carbon offset projects except for RECs will be purchased by Poseidon through/from CCAR, California APCDs / AQMDs, CARB or other providers of offsets approved by the Executive Director or Commission (collectively, “Third Party Providers”).²³ The exact nature and cost of the offset projects and RECs will not be known until they are acquired by Poseidon. Offsets or RECs will also be used as the swing mitigation option to “true-up” changes over time to the Project’s net indirect GHG emissions, as discussed below.

A. ANNUAL “TRUE-UP” PROCESS

Since the quantity of offsets required will vary from year-to-year, the goal of the annual “True Up” process is to enable Poseidon to meet the subject year’s need for metric tons of offsets by purchasing or banking offsets in the short-term, while allowing Poseidon to make long-term purchases and bank offsets to decrease market exposure and administrative costs. To complete the True-Up process, the third party independent reviewer selected, currently the California Center for Sustainable Energy (CCSE), will obtain the latest SDG&E emission factor from the annual web-based CARB or CCAR Emissions Report within 60 days of the end of each calendar year, or the date of publication of the CARB or CCAR Emissions Report on the relevant CARB or CCAR web site, whichever is later. Within 120 days of the end of the prior calendar year or publication of the emission factor (whichever is later), CCSE, with assistance from Poseidon as needed, will gather electricity usage data, relevant data regarding Avoided Emissions, and then calculate the necessary metric tons of offsets required for the subject year. The subject year’s emissions will be calculated using actual billing data and the emissions factor for the relevant annual period. The subject year’s calculated metric tons of net emissions will be compared to

²² This Plan requires Poseidon to join CCAR’s Climate Action Reserve, so that it may implement some of this Plan through the Reserve.

²³ Part 4, Section 38562(d)(1)&(2) states that CARB regulations covering GHG emission reductions from regulated “sources” must ensure that such reductions are “real, permanent, quantifiable, verifiable, . . . enforceable [and additional]”. While the Project is not a “source” under AB 32 and the criteria are not currently defined under implementing regulations, Third Party Providers will evaluate potential offset projects against equivalent criteria using their own protocols that employ the same criteria.

the amount of metric tons of offsets previously acquired by Poseidon to determine if Poseidon has a positive or negative balance of net GHG emissions for the subject year, and all of this information will be included in the Annual GHG Report to be submitted to the Commission each year as discussed below. If there is a positive balance of net GHG emissions, Poseidon will purchase offsets to eliminate the positive balance, and provide the Commission with documentation substantiating that purchase, within 120 days of the date the positive balance is identified in the Annual GHG Report. If there is a negative balance of GHG emissions, the surplus offsets may be carried forward into subsequent years or sold by Poseidon on the open market.

Prior to the commencement of Project operations, Poseidon will be required to purchase offsets sufficient to cover estimated net (indirect) GHG emissions for at least the first year of operation (subject to Commission staff concurrence), or to cover a longer period of time at Poseidon's option, based on the most recently published SDG&E emission factor from CARB or CCAR and estimated electricity usage data for the first year of the Project period for which offsets are initially purchased. Poseidon will have the option to purchase offsets for any longer period of time up to and including the entire 30-year life of the Project, subject to Poseidon's above-stated obligation to address any positive balance in net GHG emissions that may subsequently arise. Beginning with the Sixth Annual Report, Poseidon can maintain a negative balance of net GHG emissions over a rolling five-year period. Poseidon will purchase enough GHG reductions measures that conform to the Plan such that it will not incur a positive net GHG emissions balance over any rolling five-year period.

B. CARBON OFFSETS PROJECTS AND CREDITS

Subject to the provisions of Sections III.C, E and F below, Poseidon will purchase carbon offset projects, except for RECs, through/from CARB, CCAR, or California APCDs / AQMDs. An offset is created when a specific action is taken that reduces, avoids or sequesters greenhouse gas (GHG) emissions in exchange for a payment from an entity mitigating its GHG emissions. Examples of offset projects include, but are not limited to: increasing energy efficiency in buildings or industries, reducing transportation emissions, generating electricity from renewable resources such as solar or wind, modifying industrial processes so that they emit fewer GHGs, installing cogeneration, and reforestation or preserving forests.

One type of offset project is Renewable Energy Credits (RECs), also known as Green Tags, Renewable Energy Certificates or Tradable Renewable Certificates. Each REC represents proof that 1 MW of electricity was generated from renewable energy (wind, solar, or geothermal). For GHG offsetting purposes, purchasing an REC is the equivalent of purchasing 1 MW of electricity from a renewable energy source, effectively offsetting the GHGs otherwise associated with the production of that electricity. RECs may be sold separately from the electricity.

Except as specified below, offset projects that Poseidon implements pursuant to this Plan will be those approved by CARB, CCAR, or any California APCD / AQMD as conforming to AB 32 requirements. Poseidon is committed to acquiring cost-effective offsets that meet rigorous standards, as detailed in this Plan. By requiring adherence to the principles, practices and performance standards described here, the Plan is designed to assure that selected offset projects

will mitigate GHG emissions as effectively as on-site or direct GHG reductions. Adherence will ensure that the offset projects acquired by Poseidon are real, permanent, quantifiable, verifiable, enforceable, and additional, consistent with the principles of AB 32.

C. OFFSET ACQUISITION AND VERIFICATION

Poseidon shall acquire offsets through/from CCAR, CARB or California APCD/AQMD-approved projects. Acquisition of RECs are not limited to purchase from CCAR, CARB, or a California APCD/AQMD.

If sufficient offsets are not available from CCAR, CARB or a California APCD/AQMD at a price that is reasonably equivalent to the price for offsets in the broader domestic market, Poseidon may submit a written request to the Executive Director requesting that an additional offset provider, including without limitation any existing member of the Offset Quality Initiative, which includes CCAR, The Climate Trust, Environmental Resources Trust and The Climate Group/Voluntary Carbon Standard, be designated as a Third Party Provider from/through whom Poseidon may purchase offsets under the Plan.²⁶ In deciding whether or not to approve Poseidon's request, the Executive Director shall consider whether or not the proposed Third Party Provider is an independent and non-affiliated entity that adheres to substantially similar principles and evaluation criteria for high quality offsets as CCAR, CARB, a California APCD/AQMD or any Third Party Provider previously approved by the Executive Director or the Commission. The Executive Director shall determine whether or not to approve Poseidon's request to designate a Third Party Provider within 60 days. Any dispute between Poseidon and Commission Staff regarding the approval or denial of the requested entity may be brought by Poseidon to the CCC for hearing and resolution at the next available hearing date.

Poseidon's Annual GHG Report, discussed in Section III.D below, shall include an accounting summary and documentation from CCAR, CARB, a California APCD/AQMD and Third Party Providers, as applicable, which verifies that offsets obtained by Poseidon have been verified by CCAR, CARB, a California APCD/AQMD or a Third Party Provider.

D. ANNUAL REPORT

Poseidon will provide an Annual GHG Report that will describe and account for Poseidon's annual and cumulative balance of verified net GHG emissions reductions. The Annual GHG Report will include analysis and validation from CCSE of: (1) the annual GHG emission calculations for the Project, (2) the positive or negative balance in Poseidon's net GHG emissions, (3) the acquisition of offsets and/or RECs in accordance with this Plan, and (4) any other information related to Poseidon's effects to mitigate GHG emissions resulting from the Project's electricity usage. Each year, CCSE will obtain the new emission factor from CCAR or CARB and prepare and submit Poseidon's Annual GHG Report within 180 days of the date of publication of CCAR/CARB emissions reports. The Annual GHG Report shall be submitted to the CCC and the CSLC, with a copy to Poseidon. In the event that the Annual GHG Report

²⁶ The fee charged to Poseidon by the Commission for any request to approve additional offset providers pursuant to Section III.C., or to otherwise make the Plan workable by facilitating Poseidon's purchase of offsets/RECs to zero out the Project's net indirect GHG emissions, shall not exceed \$5,000.00.

indicates that Poseidon has a positive balance of net GHG emissions for a particular year, Poseidon shall purchase offsets, and provide the Commission with documentation substantiating that purchase, within 120 days of the submission of an Annual GHG Report to the Commission. If an approved Annual GHG Report demonstrates that Poseidon possesses a negative balance of net GHG emissions, Poseidon will be free to carry those surplus offsets forward into subsequent years or sell them on the open market. Beginning with the Sixth Annual Report, Poseidon can maintain a negative balance of net GHG emissions over any rolling five-year period. Poseidon will purchase enough GHG reductions measures that conform to the Plan such that it will not incur a positive net GHG emissions balance over any rolling five-year period.

Before commencing Project operations, Poseidon shall submit its first Annual GHG Report for Commission staff review and approval, which will evidence sufficient offsets to zero out the Project's estimated net indirect GHG emissions for the first year. All subsequent reports will cover one calendar year.

E. CONTINGENCY IF NO GHG REDUCTION PROJECTS ARE REASONABLY AVAILABLE

At any time during implementation of this Plan, Poseidon may seek a determination from the Executive Director that (i) offset projects in an amount necessary to mitigate the Project's net indirect GHG emissions are not reasonably available; (ii) the "market price" for carbon offsets or RECs is not reasonably discernable; (iii) the market for offsets/RECs is suffering from significant market disruptions or instability; or (iv) the market price has escalated to a level that renders the purchase of offsets/RECs economically infeasible to the Project. Any request submitted by Poseidon shall be considered and a determination made by the Executive Director within 60 days. A denial of any such request may be appealed by Poseidon to the Commission for hearing and resolution at the next available meeting date. If Poseidon's request for such a determination is approved by the Executive Director, Poseidon may, in lieu of funding offset projects or additional offset projects, deposit money into an escrow account (to be approved by the Executive Director) to be used to fund GHG offset programs as they become available, with Poseidon to pay into the fund in an amount equal to \$10.00 per metric ton for each ton Poseidon has not previously offset, adjusted for inflation from 2008.²⁷ The period of time the escrow account contingency may be utilized under this Section shall be determined by the Executive Director or the Commission at the time Poseidon's request to use the contingency is approved, based on circumstances as they exist at the time of the request. Within 180 days of the Executive Director's determination pursuant to this Section, Poseidon will be required to submit a plan for Executive Director approval that identifies one or more entities who will utilize monies deposited into the escrow account to implement carbon offset projects.

F. CONTINGENCY IF NEW GHG REDUCTION REGULATORY PROGRAM IS CREATED

If, at any time during the life of the Project the SDAPCD, South Coast Air Quality Management District (SCAQMD), or any other California APCD/AQMD or the California Air Resources Board (CARB) initiates a carbon tax or carbon offset program that would allow Poseidon to purchase carbon offsets or payment of fees to compensate for GHG emissions, Poseidon may, at

²⁷ \$10.00 per metric ton is a conservative figure, as offset credits were trading at \$4.90 per metric ton on the Chicago Climate Exchange as of market close on July 2, 2008.

its option, elect to pay into such a program in order to fulfill all or part of its obligations under the Plan to offset net indirect GHG emissions caused by the Project. By receiving certification from the relevant receiving entity that Poseidon has satisfied its obligations under the applicable regulatory program, Poseidon will be deemed to have satisfied its obligation under the Plan to offset net indirect GHG emissions for the part of the offset obligations under the Plan for which such certification is made. Subject to the approval of the relevant receiving entity, Poseidon may carry over any surplus offsets acquired pursuant to the Plan for credit in the new regulatory program.

G. EXAMPLES OF OFFSET PROJECTS

Offset projects typically fall within the seven major strategies for mitigating carbon emissions set forth below. A similar range and type of offset projects should be expected from a purchase by Poseidon, although it is difficult to anticipate the outcome of Poseidon's offset acquisitions at present.

1. **Energy Efficiency** (Project sizes range from: 191,000 metric tons to 392,000 metric tons; life of projects range from: 5 years to 15 years)
 - Steam Plant Energy Efficiency Upgrade
 - Paper Manufacturer Efficiency Upgrade
 - Building Energy Efficiency Upgrades

2. **Renewable Energy** (Project sizes range from: 24,000 metric tons to 135,000 metric tons; life of projects range from: 10 years to 15 years)
 - Small Scale Rural Wind Development
 - Innovative Wind Financing
 - Other renewable resource projects could come from Solar PV, landfill gas, digester gas, wind, small hydro, and geothermal projects

3. **Fuel Replacement** (Project size is: 59,000 metric tons; life of project is: 15 years)
 - Fuels for Schools Boiler Conversion Program

4. **Cogeneration** (Project size is: 339,000 metric tons; life of project is: 20 years)
 - University Combined Heat & Power

5. **Material Substitution** (Project size is: 250,000 metric tons; life of project is: 5 years)
 - Cool Climate Concrete

6. **Transportation Efficiency** (Project sizes range from: 90,000 metric tons to 172,000 metric tons; life of projects range from: 5 years to 15 years)
 - Truck Stop Electrification
 - Traffic Signals Optimization

7. **Sequestration** (Project sizes range from: 59,000 metric tons to 263,000 metric tons; life of projects range from: 50 years to 100 years)
 - Deschutes Riparian Reforestation
 - Ecuadorian Rainforest Restoration

- Preservation of a Native Northwest Forest

H. POTENTIAL OFFSET PROJECTS FUNDED BY POSEIDON

Participants at the May 2, 2008 CCC Workshop proposed several potential projects that were suggested to be wholly or partially funded by Poseidon. Proposers were not prepared at that time to provide details for these projects other than generally describing the project concept. As a result, it is not yet possible to evaluate them for consistency with the applicable criteria for valid GHG reduction projects. The projects include the following:

- Reforestation Projects in the San Diego area ravaged by the 2007 fires
- Urban Forestry projects
- Estuary sequestration project
- Wetlands projects
- Fleet Fuel Efficiency Increase & Replacement project
- Accelerated Fleet Hybrid Deployment
- Large-Scale Solar PV project on a covered reservoir
- Mini-Hydro from installing pressure reducing Pelton wheels
- Solar Water Heating for a new city recreation swimming pool
- Lawn Mower Exchange Program (gas exchanged for electric mowers)
- Truck Fleet Conversion (especially older trucks from Mexico)
- School Bus Conversions
- White Tag projects or Energy Efficiency projects

Subject to the provisions of Sections III.C, E and F above, Poseidon will purchase these or other potential offset projects, except for RECs, through/from CARB, CCAR, or any California APCD / AQMD.

I. SEQUESTRATION THROUGH REFORESTATION

The CCC identified as a carbon offset project the reforestation of areas in the San Diego Region impacted by the wildfires that occurred during the fall of 2007. Specifically, at the CCC's request, Poseidon has agreed to invest the initial \$1.0 million it spends on offset projects in reforestation activities in the San Diego Region. Poseidon commits to using either the CARB/CCAR Forest Project Protocols or the upcoming CARB/CCAR Urban Forest Project Protocol depending on the type of project Poseidon selects.

J. RENEWABLE ENERGY PARTNERSHIPS

Poseidon is exploring the possibility of participating in renewable energy projects with its water agency partners. Subject to the provisions of Sections III.C, E and F above, any offset projects implemented pursuant to this Plan, except for RECs, will be purchased through/from CARB, CCAR, or any California APCD / AQMD. Table 5 presents a summary of some of the project opportunities and associated GHG offsets that are under consideration.

Table 5 – Potential Renewable Energy Partnerships

Desalination Project Public Partner / Location	Green Power Project Description	Annual Capacity of Green Energy Projected to be Generated by the Project (MWh/yr)
City of Encinitas	95 KW Solar Panel System Installed on City Hall Roof	160
Valley Center Municipal Water District	1,000 KW Solar Panel System	1,680
Rainbow Municipal Water District	250 KW Solar Panel System	420
Olivenhain Municipal Water District / Carlsbad Municipal Water District / City of Oceanside	Various solar and hydroelectric generation opportunities	To Be Determined
Santa Fe Irrigation District	Hydropower generation facility at R.E. Badger Filtration Plant	To Be Determined
	Total Renewable Power Generation Capacity (MWh/yr)	2,260

K. IMPLEMENTATION SCHEDULE

An illustrative schedule setting forth timing for implementation of Poseidon’s Plan elements, assuming regulatory approval is achieved in August 2008, is set forth in the following Implementation Schedule.

Table 6 – Implementation Schedule for the Plan

Measure	Process	Timing
Regulatory Approval		August 2008
Submit First Annual GHG Report	First Annual Report*, submitted to Commission staff for review and approval, shall be include enough detailed emissions reductions measures to achieve a projected zero net GHG emissions balance.	Before operations commence.
Offset and REC Purchases Sufficient to Zero Out Estimated net indirect GHG emissions for first year of	Subject to the provisions of Sections III.C, E and F above, offset projects or credits, except for RECs, will be	Before operations commence.

operations.	implemented through CCAR, CARB or any California APCDs / AQMDs.	
Annual True-Up Process, and all Subsequent Annual GHG Reports	Poseidon will submit its Annual GHG Report to Commission staff for review and approval. Once approved, Poseidon will purchase additional offsets as necessary to maintain a zero net GHG emissions balance, or bank or sell surplus offsets. Poseidon can demonstrate compliance over a rolling 5-year period in the Sixth Annual Report.	Each year, Poseidon will obtain the new emission factor from CARB or CCAR, and prepare and submit Poseidon's Annual GHG Report within 180 days of the date of publication of CCAR/CARB emissions reports. If the report shows a positive net GHG emissions balance, Poseidon is required to purchase offsets, and submit proof of such purchase to Commission Staff, within 120 days from the date of the Annual GHG Report.

* First Annual GHG Report will use projected electricity consumption. All subsequent Annual GHG Reports will use the previous year's electricity consumption data.

L. THE PROJECT'S ANNUAL NET-ZERO CARBON EMISSION BALANCE

Table 7 presents a summary of the assessment, reduction and mitigation of GHG Emission for the proposed Project. As Shown in the table, up to 83% of the GHG Emissions associated with the proposed Project could be reduced by on-site reduction measures, and the remainder would be mitigated by off-site mitigation projects and purchase of offsets or RECs. It should be noted that on-site GHG reduction activities are expected to increase over the useful life (i.e., in the next 30 years) of the Project because of the following key reasons:

- SDG&E is planning to increase significantly the percentage of green power sources in its electricity supply portfolio, which in turn will reduce its emission factor and the Project's net indirect GHG emissions.
- Advances in seawater desalination technology are expected to yield further energy savings and net indirect GHG Emission reductions. Over the last 20 years, there has been a 50% reduction in the energy required for seawater desalination.

Table 7 – Expected Assessment, Reduction and Mitigation of GHG Emissions

Part I: Identification of GHG Amount Emitted		
Source	Total Annual Power Use (MWh/year)	Total Annual Emissions (metric tons CO₂/year)
Project Baseline Design	274,400	97,165

Part 2: On-site and Project-Related Reduction of GHG Emissions		
Reduction due to High-Efficiency Design	(28,244)	(10,001)
Green Building Design	(300 to 500)	(106 to 177)
On-site Solar Power Generation	(0 to 777)	(0 to 275)
Recovery of CO2	(NA)	(2,100)
Reducing Energy Needs for Water Recycling	(1,950)	(690)
Reduced Water Importation	(190,641)	(67,506)
Sequestration in Coastal Wetlands	(NA)	(18 to 188)
Subtotal On-site Reduction Measures	(NA)	(80,421 to 80,937)
Net GHG Emissions		16,422 to 16,228
Part 3: Additional Off-site Reductions of GHG Emissions		
Sequestration Through Reforestation	(NA)	(245)
Potential Renewable Energy Partnerships	(0 to 2,260)	(0 to 800)
Subtotal Off-site Measures	(NA)	(245-1,045)
Offset and REC Purchases	(NA)	(16,499 to 15, 067)
Net GHG Emissions		0

