

EXHIBIT 7.III

TECHNICAL GUIDANCE DOCUMENT FOR THE PREPARATION OF CONCEPTUAL/PRELIMINARY AND/OR PROJECT WATER QUALITY MANAGEMENT PLANS (WQMPs)

May 19, 2011

TABLE OF CONTENTS

SECTION 1. INTRODUCTION 1-1

 1.1. Role of Technical Guidance Document in Project Planning 1-1

 1.2. Stormwater Management Best Management Practices 1-1

 1.3. Organization of the Technical Guidance Document..... 1-4

SECTION 2. TECHNICAL GUIDANCE FOR PREPARING PROJECT WQMPS 2-1

 2.1. Discretionary Permits and Water Quality Conditions..... 2-1

 2.2. Project Description..... 2-2

 2.2.1. Project Land Uses..... 2-3

 2.2.2. Expected Stormwater Pollutants..... 2-4

 2.2.3. Hydrologic Conditions of Concern 2-8

 2.2.4. Post Development Drainage Characteristics..... 2-9

 2.2.5. Property Ownership/Management 2-10

 2.2.6. Water Quality Credits..... 2-10

 2.3. Site Description 2-10

 2.3.1. Physical Setting..... 2-10

 2.3.2. Site Characteristics 2-10

 2.3.3. Watershed Description..... 2-17

 2.4. Best Management Practices (BMPs) 2-25

 2.4.1. Project Performance Criteria 2-26

 2.4.2. Site Design and Drainage Plan..... 2-27

 2.4.3. Project Conformance Analysis 2-39

 2.4.4. Alternative Compliance Plan 2-44

 2.5. Inspection/Maintenance Responsibility for BMPs 2-45

 2.6. Site Plan and Drainage Plan 2-45

 2.6.1. Site Plan and Drainage Plan Sheet Set 2-45

 2.6.2. Electronic Data Submittal. 2-45

 2.7. Incorporating USEPA Green Streets Guidance to the MEP 2-45

 2.7.1. Site Assessment Considerations for Applicable Green Streets Projects 2-45

 2.7.2. BMP Selection and Site Design for Applicable Green Streets Projects 2-46

 2.7.3. BMP Sizing for Applicable Green Streets Projects 2-48

 2.7.4. Alternative Compliance Options for Applicable Green Streets Projects..... 2-49

SECTION 3. SITE DESIGN PRINCIPLES AND TECHNIQUES..... 3-1

 3.1. Introduction 3-1

 3.2. Site Planning and Layout..... 3-1

 3.2.1. Minimize Impervious Area..... 3-1

 3.2.2. Maximize Natural Infiltration Capacity 3-2

 3.2.3. Preserve Existing Drainage Patterns and Time of Concentration..... 3-3

 3.2.4. Disconnect Impervious Areas 3-4

 3.3. Vegetative Protection, Selection Revegetation, and Soil Stockpiling 3-6

 3.3.1. Protect Existing Vegetation and Sensitive Areas..... 3-6

3.3.2.	Revegetate Disturbed Areas	3-6
3.3.3.	Soil Stockpiling and Site Generated Organics.....	3-7
3.3.4.	Firescaping	3-8
3.3.5.	Xeriscape Landscaping.....	3-9
3.4.	Slopes and Channel Buffers	3-10
3.5.	Techniques to Minimize Land Disturbance	3-11
3.6.	LID BMPs at Scales from Single Parcels to Watershed.....	3-12
3.7.	Integrated Water Resource Management Practices.....	3-13
SECTION 4.	LID AND TREATMENT CONTROL BMP DESIGN	4-1
4.1.	Introduction	4-1
4.2.	Hydrologic Source Controls	4-3
4.3.	Infiltration BMPs	4-3
4.4.	Harvest and Use BMPs.....	4-3
4.5.	Evapotranspiration BMPs	4-4
4.6.	Biotreatment BMPs	4-4
4.7.	Treatment Control BMPs	4-5
4.8.	Pretreatment/Gross Solids Removal BMPs	4-5
4.9.	BMP Performance Summaries.....	4-5
SECTION 5.	HYDROMODIFICATION CONTROL DESIGN	5-1
5.1.	Introduction	5-1
5.2.	Hydromodification Control Concepts	5-1
5.3.	System Design to Address HCOCs in North Orange County.....	5-2
5.3.1.	Determine Whether HCOCs Exist	5-2
5.3.2.	Evaluate Additional On-site and Off-site Controls.....	5-4
5.3.3.	Site Specific Evaluation of In-stream Control Options	5-4
5.3.4.	Provide Peak Design for Peak Matching	5-5
5.4.	System Design to Address HCOCs in South Orange County	5-5
5.5.	Hydromodification Control BMPs	5-5
5.5.1.	On-Site / Distributed Controls	5-5
5.5.2.	Detention/Retention Basins	5-6
5.5.3.	In-Stream Controls.....	5-6
SECTION 6.	SOURCE CONTROL MEASURES.....	6-1
6.1.	Introduction	6-1
6.2.	Non-Structural Measures.....	6-1
6.3.	Structural Measures	6-4
6.4.	Municipal Non-Structural Source Control Measures	6-10
SECTION 7.	OPERATION AND MAINTENANCE PLANNING	7-1
7.1.	How to Develop Maintenance Agreements	7-1
7.2.	How to Develop BMP Maintenance Activities	7-2

APPENDICES

- [I. Summary of BMP Sizing Requirements for North Orange County](#)
- [II. Summary of BMP Sizing Requirements for South Orange County](#)
- [III. Hydrologic Calculations and Sizing Methods for LID and Treatment Control BMPs](#)
- [IV. Approved Methods for Quantifying Hydrologic Conditions of Concern \(North Orange County\)](#)
- [V. Approved Methods for Quantifying Hydrologic Conditions of Concern \(South Orange County\)](#)
- [VI. Approved Methods for Calculating Alternative Compliance Obligations](#)
- [VII. Infiltration Rate Evaluation Protocol and Factor of Safety Recommendations](#)
- [VIII. Groundwater-Related Infiltration Feasibility Criteria](#)
- [IX. Technical Basis for Green Roof Design Criteria](#)
- [X. Harvest and Use Demand Calculations and Feasibility Screening](#)
- [XI. Criteria for Designing BMPs to Achieve Maximum Feasible Retention and Biotreatment](#)
- [XII. Biotreatment Selection, Design, and Maintenance Criteria](#)
- [XIII. Technical Basis for Incremental Threshold Benefit Criterion](#)
- [XIV. BMP Fact Sheets](#)
- [XV. Worksheets](#)
- [XVI. Watershed Exhibits](#)
- [XVII. Supporting Information Relative to Sanitary Sewer Inflow and Infiltration](#)

TABLES

Table 2.1: Anticipated and Potential Pollutants Generated by Land Use Type.....2-7
Table 2.2: Summary of the Approved 2006 and Tentative 2010 303(d) Listed Water Bodies and Associated Pollutants of Concern for North Orange County2-18
Table 2.3: Summary of the Approved 2006 and Tentative 2010 303(d) Listed Water Bodies and Associated Pollutants of Concern for South Orange County2-19
Table 2.4: Summary of the Status of TMDLs for Waterbodies in Regions 8 and 92-20
Table 2.5: Recommended Scale of Analyses for Project WQMP Preparation2-26
Table 2.6: Approximate Space Requirements for Structural BMPs2-28
Table 2.7: Infiltration BMP Feasibility Worksheet.....2-34
Table 2.8: Potential BMPs for Applicable Green Streets Projects2-47
Table 4.1. Categories of LID BMPs and Treatment Control BMPs.....4-2
Table 4.2 Relative Treatment Performance Ratings of Biotreatment BMPs.....4-7
Table 4.3 Relative Treatment Performance Ratings of Treatment Control BMPs.....4-10
Table 4.4 Pollutants Address by Unit Operations and Processes.....4-11

FIGURES

Figure 1.1: General Hierarchy of LID BMPs.....1-3
Figure 2.1: LID BMP Selection Flow Chart.....2-30
Figure 5.1. North Orange County Hydromodification Design Process5-3

ACRONYMS

BMP - Best Management Practice
CEQA - California Environmental Quality Act
CMF - Cartridge Media Filtration
CWA - Federal Clean Water Act
DAMP - Drainage Area Management Plan
DCIA - Directly Connected Impervious Area
DEDB - Dry Extended Detention Basin
ESA - Environmentally Sensitive Area
ET - Evapotranspiration
HCOC - Hydrologic Condition Of Concern
HMP - Hydromodification Management Plan
HSC - Hydrologic Source Control
EIATA - Effective Irrigated Area to Tributary Area
IWRMP - Integrated Water Resources Management Plan
LID - Low Impact Development
LIP - Local Implementation Plan
MEP - Maximum Extent Practicable
MS4 - Municipal Separate Storm Sewer System
NOC - North Orange County (Region 8- SARWQCB Jurisdictional Area)
NPDES - National Pollutant Discharge Elimination System
NTS - Natural Treatment Systems
OCWD - Orange County Water District
POC - Pollutant Of Concern
RWQCB - Regional Water Quality Control Board
SARWQCB - Santa Ana Regional Water Quality Control Board
SDRWQCB - San Diego Regional Water Quality Control Board
SOC - South Orange County (Region 9 -SDRWQCB Jurisdictional Area)
SQDF - Stormwater Quality Design Flow
SQDV - Stormwater Quality Design Volume
SSMP - Standard Stormwater Mitigation Plan
TGD - Technical Guidance Document
TMDL - Total Maximum Daily Load
TUTIA - Toilet Users To Impervious Area
WIHMP - Watershed Infiltration and Hydromodification Master Plan
WMA - Watershed Management Area
WQ - Water Quality
WQDF - Water Quality Design Flow
WQDV - Water Quality Design Volume
WQMP - Water Quality Management Plan

GLOSSARY OF KEY TERMS

Agronomic Demand – the amount of irrigation required to meet plant water needs, accounting for inefficiencies in irrigation.

Alternative Compliance Program – encompasses the elements used to satisfied remaining performance criteria after on-site LID BMPs have been implemented to the maximum feasible level (and in the North Orange County permit area, after both on-site and sub-regional/regional LID BMPs have been implemented to the maximum feasible level).

Assessment of Susceptibility (to Hydrologic Conditions of Concern) – an assessment of the receiving water(s) of a project to determine whether downstream water courses, water bodies, and/or stormwater conveyance infrastructure would potentially be impacted by changes in hydrologic regime.

Average Annual Capture Efficiency (a.k.a. capture efficiency) – the estimated percent of long term average annual runoff volume that is managed/controlled by a BMP. Target capture efficiency serves as one element of the performance criteria for LID and treatment control BMPs.

Biotreatment BMP – a class of LID BMPs, biotreatment BMPs are vegetated treat-and-release BMPs that also promote infiltration and/or ET.

Biotreatment Volume – the volume of storage in biotreatment BMPs, measured from the overflow elevation of the BMP outlet, which would be treated and discharged as the BMP drains; this volume includes surface storage and pore storage but does not include the volume that would be retained in the BMP and discharged to infiltration, ET, or uses.

Bypass – runoff that is routed around a BMP or passes through the BMP with minimal treatment. Bypass generally occurs when the inflow volume or flowrate has exceeded the BMP capacity.

Capture Efficiency (a.k.a. average annual capture efficiency) – the estimated percent of long term average annual runoff volume that is captured by a BMP (i.e., does not bypass). Target capture efficiency serves as one element of the performance criteria for LID and treatment control BMPs.

Capture Efficiency Method – a BMP sizing method based on capturing the average annual stormwater runoff volume from a project as determined with continuous flow modeling.

Conceptual Project WQMP – a Project WQMP prepared at the planning phase of projects subject to discretionary approval; intended to describe, at the earliest possibly phase in the development process, the BMPs that will be implemented and maintained throughout the project (functionally equivalent to a Preliminary Project WQMP; nomenclature varies by local jurisdiction).

Design Capture Storm Depth – the 85th percentile, 24-hr storm depth.

Design Capture Volume (DCV)– the volume of storm water runoff resulting from the design capture storm depth.

Design Criteria – requirements that serve as the basis for designing a BMP to meet performance criteria. Design criteria may encompass BMP sizing and other characteristics of BMP design.

Drainage Area Management Plan (DAMP) – The specific water pollutant control elements of the Orange County Stormwater Program are documented in the Drainage Area Management Plan (DAMP), which is the Permittees’ primary policy, planning and implementation document for municipal NPDES Stormwater Permit compliance.

Drawdown – the act of discharging water from a BMP. Drawdown provides storage volume for subsequent storm events.

Drawdown Rate – the rate at which water discharges from a BMP, making storage volume available for subsequent storm events.

Drawdown Time – the time it takes to a BMP from brim full. Drawdown time may need to be calculated separately for the retention volume of the BMP and the biotreatment volume of the BMP in order to support design calculations if both types of volume exist. These separate measures are referred to as the “retention drawdown time” and “biotreatment drawdown time”.

Environmentally Sensitive Area - areas such as those designated in the Ocean Plan as Areas of Special Biological Significance or waterbodies listed on the CWA Section 303(d) list of impaired waters (See full definition in **Section 2.3.3.4**).

Evapotranspiration (ET) - the loss of water to the atmosphere by the combined processes of evaporation (from water, soil and plant surfaces) and transpiration (from plant tissues). As used in this TGD, ET refers to one or both of these processes.

Evapotranspiration BMP (aka ET BMP) – a class of retention BMPs that discharges stored volume predominantly to ET; some infiltration may occur. ET includes both evaporation and transpiration, and ET BMPs may incorporate one or more of these processes.

Final Project WQMP – a Project WQMP submitted at the ministerial approval phase prior to final approval of a grading or building permit; expected to reflect the detail available at the time of project ministerial-level approval.

Harvest and Use – The process of capturing rainwater or stormwater runoff, storing it, and making it available for subsequent use. This process is performed by Harvest and Use BMPs.

Harvest and Use BMP (aka Rainwater Harvesting BMP) – a class of retention BMPs that captures rainwater or stormwater runoff and stores it for subsequent use.

Hydrocollapse - a sudden collapse of granular soils cause by a rise in groundwater dissolving or deteriorating the inter-granular contacts between the sand particles

Hydrologic Condition of Concern (HCOC) – a combination of upland hydrologic conditions and stream biological and physical conditions that presents a condition of concern for physical and/or biological degradation of a stream.

Hydrologic Source Control (HSC) - a class of LID BMPs integrated with site design that retain stormwater runoff and reduce the volume (and potentially rate) of stormwater discharge to the downstream system. HSCs are differentiated from retention and biotreatment classes of LID BMPs by their higher level of integration with a site. They are not sized according to engineering design criteria, and they do not typically result in a distinct facility. Consequently, they are usually regarded as site design practices, as opposed to structural treatment control BMPs. An example includes routing roof runoff into adjacent landscaped areas.

Hydromodification – Changes in runoff and sediment yield caused by land use modifications.

Hydromodification Control – Management techniques which reduce the potential for hydromodification impact.

Hydromodification Impact – The physical response of stream channels to changes in runoff and sediment yield caused by land use modifications

Infiltration BMP – a class of retention BMPs that discharges stored volume predominantly to deeper percolation/infiltration; some evapotranspiration may also occur.

In-stream Control – Modification of a receiving channel as a technique for managing hydromodification impacts. The modifications are usually done for the purposes of allowing the channel to accept changes in hydrology while minimizing impacts to beneficial uses.

Irrigation Area Ratio – a ratio describing the agronomic irrigation demand for harvested stormwater as a fraction of the tributary area to the stormwater storage device.

Irrigation Efficiency – the ratio of plant irrigation needs met to the amount of irrigation water applied. A value of 0.75 implies that 1 inch of irrigation water must be applied to satisfy 0.75 inches of plant water needs.

LID BMP – a BMP that provides retention or biotreatment as part of an LID strategy – these may include HSCs, retention, and biotreatment BMPs.

LID Site Design – The component of LID that relates to the way in which a site is laid out to achieve strategic stormwater management and resource management objectives. Site design practices work synergistically with LID BMPs, treatment control, and hydromodification control strategies. Example practices include minimizing impervious areas and locating pervious areas such that impervious areas can drain to pervious areas.

Liquefaction – a seismically-induced geological hazard that can result in damage to structures as a result in reduction in bulk volume of saturated granular soils.

Local Implementation Plan (LIP) – The Local Implementation Plan (LIP) describes how the DAMP is being implemented by individual permittees under the MS4 Permit.. The DAMP provides a foundation for the description and detail of how the Orange County Stormwater Permittees commonly implement model programs designed to prevent pollutants from entering receiving waters to the maximum extent practicable (MEP). The LIP is designed to supplement the DAMP and each city and the County have developed a comprehensive LIP that is specific to their jurisdiction.

On-site LID Practices – LID practices that are implemented within the project boundary.

Opportunity Criteria – characteristics of a drainage area that provide opportunity for a certain type of BMP. Opportunity criteria are tabulated for each BMP type and are intended to be used in the BMP Prioritization process.

Other Pollutants of Concern – A pollutant which is expected to be generated by the project's land uses for which there is no 303(d) listing or TMDL in place for any receiving water of the project.

Performance Criteria – specific measurable or verifiable requirements against which the performance of a system is compared to assess conformance with the requirements of the [Model WQMP](#). There are three separate types of performance criteria: 1) LID, 2) treatment control, and 3) hydromodification control. These performance criteria are evaluated individually although they can be interrelated. It is possible to meet one and not meet the others. This is synonymous with “performance standard” as used by other guidance documents, but only “performance criteria” is used in this document.

Preliminary Project WQMP – a Project WQMP prepared at the planning phase of projects subject to discretionary approval; intended to describe, at the earliest possible phase in the development process, the BMPs that will be implemented and maintained throughout the

project (functionally equivalent to a Conceptual Project WQMP; nomenclature varies by local jurisdiction).

Primary Pollutant of Concern - A pollutant which is expected to be generated by the project's land uses for which there is a 303(d) listing or TMDL in place for any receiving water of the project.

Priority Project - a new development or redevelopment project meeting the thresholds described in Section 1.2 of the [Model WQMP](#).

Project Water Quality Management Plan (Project WQMP) - a project submittal that describes the Best Management Practices (BMPs) that will be implemented and maintained throughout the life of a project. This term is used in this TGD to describe Conceptual/Preliminary and Final Project WQMPs.

Retention BMP - a class of LID BMPs including infiltration BMPs, evapotranspiration BMPs, and harvest and use BMPs whose design does not allow the discharge of stormwater runoff to the storm drainage system or surface water up to the DCV ; these BMPs either infiltration, evapotranspire, or allow for use of the retention volume.

Retention Volume - the volume of storage in retention and biotreatment BMPs, measured from the overflow elevation of the BMP, which would be retained and discharged to infiltration, ET, or uses as the BMP drains. All storage volume is retention volume in retention BMPs.

Site Design - a stormwater management strategy that emphasizes conservation and use of existing site features to reduce the amount of runoff and pollutant loading that is generated from a project site. Site design practices compliment LID BMPs, treatment control, and hydromodification control strategies. Example practices include clustering development, minimizing impervious areas, and locating pervious areas such that impervious areas can drain to pervious areas.

Sizing Criteria - specific design criteria related to BMP size that serve as a basis for meeting performance criteria.

Source Control - a class of preventative measures intended to prevent the introduction of pollutants into stormwater.

Standard Stormwater Mitigation Plan (SSMP) - see Project WQMP

Susceptibility - a channel's lack of ability to resist physical response due to hydromodification

Treatment - the DCV is considered to have been subject to treatment or is considered treated when pollutant concentrations or loads have been reduced. Volume that is lost in a BMP via infiltration and ET is considered to meet treatment criteria, however the term "treated discharge" this is intended to refer to treated water discharged back to the storm drain system or surface waters.

Treatment Control BMP - a structure designed to treat pollutants in stormwater runoff and release the treated runoff to surface waters or a storm drain system , but is not a biotreatment BMP. Examples include sand filters and cartridge media filters.

2-year, 24-hour Event - a 24-hour storm event expected to be equaled or exceeded, on average, every 2 years. As defined for Orange County by the Orange County Hydrology Manual.

Water Quality Credit System - the system by which certain project types are granted reduction in the criteria for determining treatment control and/or offsite mitigation requirements for alternative program requirements.

Watershed-based Plan - refers to a RWQCB Executive Officer-approved Watershed Master Plan (WMP), Hydromodification Management Plan (HMP), or other RWQCB Executive Officer-approved watershed-based plan developed with consideration for water quality, hydrologic, fluvial, water supply, and/or habitat, consistent with the LID and hydromodification principles and criteria described in the North County and/or South County permit. Watershed-based plans may include specific guidance and support for applying LID feasibility criteria, but may not substantively alter LID performance criteria. Approved WMPs and HMPs may substantively alter hydromodification performance criteria.

Watershed Management Area (WMA) - Watershed Management Areas (WMAs) are used in the countywide Water Quality Strategic Plan as the structure for water resource management. The eleven watersheds in Orange County are grouped by similar characteristics into three Watershed Management Areas: North, Central, and South County.

SECTION 1. INTRODUCTION

1.1. Role of Technical Guidance Document in Project Planning

This Technical Guidance Document (TGD) has been developed by the County of Orange in cooperation with the incorporated Cities of Orange County to aid agency staff and project proponents with addressing post-construction urban runoff and stormwater pollution from new development and significant redevelopment projects in the County of Orange.

Within the Santa Ana Regional Water Quality Control Board (Santa Ana Regional Board) jurisdiction, the Fourth Term MS4 Permit ([Order R8-2009-0030](#)) (“North County Permit”) has been adopted with specific requirements for new development and significant redevelopment stormwater control. Within the San Diego Regional Water Quality Control Board (San Diego Regional Board) jurisdiction, the Fourth Term MS4 Permit Order ([R9-2009-0002](#)) (“South County Permit”) has been adopted with similar but somewhat differing requirements for new development and significant redevelopment stormwater control.

A [Model Water Quality Management Plan \(WQMP\) \(DAMP Exhibit 7.II-2\)](#) has been prepared to explain the requirements and types of analyses that are required in preparing a Conceptual/Preliminary or Project WQMP in compliance with the North County and South County Permits. A companion Project WQMP Template has also been prepared. The [Model WQMP](#) and the Project WQMP Template provide the framework for developing a Conceptual/Preliminary or Project WQMP in compliance with the MS4 Permits within Orange County. These documents describe the applicability of these requirements. The purpose of this TGD is to serve as a technical resource companion to the [Model WQMP](#) and the Project WQMP Template. Whereas the [Model WQMP](#) and Project WQMP Template are intended to answer “what, why, and when” for Project WQMP preparation, this TGD is intended to provide guidance on “how” to complete the Conceptual/Preliminary or Project WQMP.

1.2. Stormwater Management Best Management Practices

Low impact development (LID) is a stormwater management strategy that emphasizes conservation and use of existing site features integrated with distributed stormwater controls that are designed to more closely mimic natural hydrologic patterns of undeveloped sites than traditional stormwater management controls. LID includes both site design and structural measures, as described below. Components of LID are considered to be “preventative” in that they prevent or reduce runoff from occurring by reducing the elements of development that produce runoff. These are referred to in this TGD as “LID Site Design Practices” or simply “Site Design Practices.” Other elements of LID are considered to be “mitigative” in that they are used to manage runoff that is generated. These are referred to in this TGD as “LID best management practices (BMPs).” Hydrologic source controls (HSCs) are a group of LID practices, such as dispersing rooftop runoff through adjacent landscaping, for which this TGD provides a method of quantitatively estimating benefits. Therefore, these practices are considered separately from other site design practices described in this TGD.

Hydromodification control includes measures to minimize the potential for hydromodification impacts to streams as a result of land changes. Hydromodification is the physical response of stream channels to changes in catchment runoff and sediment yield caused by land use.

Control methods include site design, hydrologic controls, and in-stream controls

In this TGD, treatment controls are structural BMPs, not including LID BMPs, which are used to remove pollutants from stormwater, such as sand filters and cartridge media filters. Treatment controls may be located on the project site or regionally. LID BMPs are considered to satisfy treatment control requirements as well as LID requirements.

Depending upon the project size and characteristics, the Conceptual/Preliminary and/or Project WQMP may include combinations of the following types of BMPs:

- **LID Site Design Practices:** components of an overall LID strategy that relate to the way in which a site is laid out to achieve stormwater management and resource management objectives. Site design practices work synergistically with LID BMPs, treatment control, and hydromodification control strategies. Example practices include minimizing impervious areas and locating pervious areas such that impervious areas can drain to pervious areas.
- **Hydrologic source controls (HSCs):** can be considered to be a hybrid between site design practices and LID BMPs. HSCs are distinguished from site design BMPs in that they do not reduce the tributary area or reduce the imperviousness of a drainage area; rather they reduce the runoff volume that would result from a drainage area with a given imperviousness compared to what would result if HSCs were not used. HSCs are differentiated from LID BMPs in that they tend to be more highly integrated with site designs and tend to have less defined design and operation. For example, it may not be possible to precisely describe the storage volume and drawdown rate of a pervious area receiving drainage from downspout disconnects; however these systems can be very effective at reducing runoff.
- **On-site, Sub-regional, or Regional LID BMPs:** structural measures that provide retention or biotreatment of stormwater as part of an LID strategy – these may be located either on-site or off-site as dictated by LID performance criteria. Examples include infiltration BMPs, bioinfiltration systems (engineered landscaped areas that promote infiltration but include underdrains), harvest and use systems, green roofs, biofiltration systems (e.g., bioretention with underdrains, vegetated swales) and regional constructed wetland treatment systems.
- **Hydromodification Control BMPs:** on-site, regional, or in-stream measures used as part of an overall strategy to reduce the potential for hydromodification impact. Example hydromodification control BMPs include infiltration and detention basins, bioinfiltration facilities, underground detention vaults, and instream grade controls. HSCs and LID BMP provide volume reduction and/or peak flow benefits, therefore also serve or contribute to hydromodification control.

- **Treatment Control BMPs:** structural measures designed to remove pollutants of concern from stormwater, but which do not meet criteria to be categorized as LID BMPs, such as media filters.
- **Source Control BMPs:** non-structural and structural practices intended to prevent or reduce the introduction of pollutants into stormwater. This category include pollutant source controls for the purpose of the TGD and does not include HSCs, described above.

LID BMPs are required to be incorporated into a Project WQMPs according to the general hierarchy described in the MS4 Permits. This hierarchy is described in [Figure 1.1](#).

Figure 1.1: General Hierarchy of LID BMPs

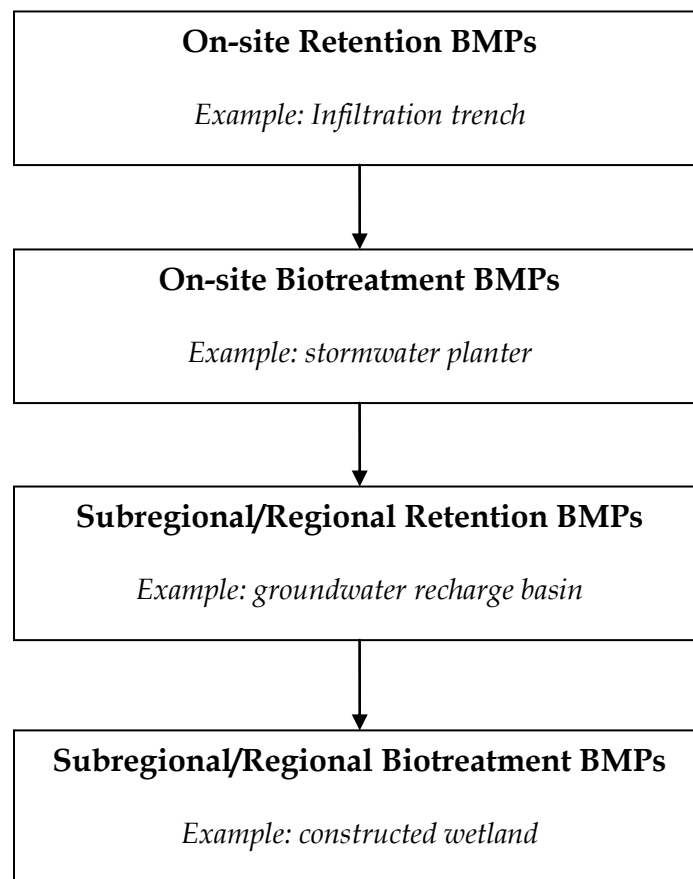

A principal role of the [Model WQMP](#) and this TGD is to describe the processes and criteria to ensure that this hierarchy is incorporated into project WQMPs to the maximum extent practicable (MEP)¹.

1.3. Organization of the Technical Guidance Document

The TGD is divided into seven sections and 16 appendices, as follows:

- [Section 1](#) provides an introduction to the purpose of the document and its role in project planning.
- [Section 2](#) contains guidance on how to prepare Conceptual/Preliminary and/or Project WQMPs as directed by the [Model WQMP](#) and in the same order as outlined in the Project WQMP Template.
- [Section 3](#) provides guidance for site design principles and practices, including site planning and layout, vegetative protection, revegetation, slopes and channel buffers, techniques to minimize land disturbance, LID BMPs at scales from single parcels to watershed, and integrated water resource management practices. This section supports Project WQMP Template Section IV.2.
- [Section 4](#) provides BMP design guidance for infiltration BMPs, harvest and use BMPs, evapotranspiration BMPs, biotreatment BMPs, treatment control BMPs, and pretreatment/gross solids removal BMPs. This section supports Project WQMP Template Section IV.3.
- [Section 5](#) provides guidance for design approaches for hydromodification control BMPs, including, on-site / distributed controls, regional controls, and in-stream controls. This section also supports Project WQMP Template Section IV.3.
- [Section 6](#) provides guidance for the type, functionality, and selection of Source Control Measures, both structural and non-structural. This section also supports Project WQMP Template Section IV.3.
- [Section 7](#) provides general considerations and information on operation and maintenance planning, maintenance plans, and agreements. This section supports Project WQMP Template Section V.
- [Appendix I](#) summarizes the BMP sizing requirements for the North Orange County permit area.
- [Appendix II](#) summarizes the BMP sizing requirements for the South Orange County permit area.

¹ MEP is not defined in the Clean Water Act; it refers to management practices, control techniques, and system, design and engineering methods for the control of pollutants taking into account considerations of synergistic, additive, and competing factors, including, but not limited to, gravity of the problem, technical feasibility, fiscal feasibility, public health risks, societal concerns, and social benefits. [North Orange County Permit]

- [Appendix III](#) provides hydrologic calculations and sizing methods for LID and treatment control BMPs.
- [Appendix IV](#) provides approved methods for quantifying hydrologic conditions of concern in the North Orange County permit area.
- [Appendix V](#) provides approved methods for meeting the Interim Hydromodification Control Standard in the South Orange County permit area.
- [Appendix VI](#) provides approved methods for calculating the alternative compliance volume.
- [Appendix VII](#) provides guidance for evaluating infiltration rates and determining safety factors for infiltration feasibility screening and design.
- [Appendix VIII](#) summarizes groundwater-related infiltration feasibility criteria.
- [Appendix IX](#) provides the technical basis for green roof design criteria.
- [Appendix X](#) summarizes harvest and use demand calculations and feasibility screening.
- [Appendix XI](#) provides criteria for designing LID BMPs to achieve maximum feasible retention and biotreatment.
- [Appendix XII](#) provides a discussion of biotreatment selection, design, and maintenance criteria.
- [Appendix XIII](#) describes and supports the incremental threshold benefit criterion.
- [Appendix XIV](#) provides concise fact sheets for 25 LID and treatment control BMPs with references to more extensive design guidance.
- [Appendix XV](#) provides links to worksheets that are referenced throughout the TGD.
- [Appendix XVI](#) contains watershed exhibits, including a rainfall zone map, infiltration feasibility constraint maps, and groundwater protection area maps.

SECTION 2. TECHNICAL GUIDANCE FOR PREPARING PROJECT WQMPs

TGD Section 2 provides guidance for how to fill in the Project WQMP Template and is organized to mirror the respective sections of the WQMP Template. The requirements for the Project WQMP preparation process are described in Section 2.0 of the [Model WQMP](#).

2.1. Discretionary Permits and Water Quality Conditions

Section I of the Project WQMP should list the discretionary permit(s) applicable to the project and provide the site address or lot and tract/parcel map number describing the property.

List, verbatim, any Water Quality Conditions, including the condition requiring preparation of WQMP, if applicable. Water Quality Conditions may be included as mitigation measures in California Environmental Quality Act (CEQA) documents for the project. For example, a Mitigation Monitoring and Report Program (MMRP) adopted in a certified Environmental Impact Statement (EIR) may include Project Design Features (PDFs), Standard Conditions (SCs), and Mitigation Measures (MMs) related to water quality protection.

A Conceptual/Preliminary WQMP may have been prepared for the project in the preliminary planning stages, for example, as a technical appendix in an EIR. If so, the Conceptual/Preliminary WQMP must be used as a source of information for the Project WQMP, if applicable. The Section I of the Project WQMP should discuss whether there are any substantial differences compared to the Conceptual/Preliminary WQMP and the significance of these revisions.

Describe the Conceptual/Preliminary WQMP BMP plan in Section I of the Project WQMP, if applicable. If regional stormwater management facilities are identified in the Conceptual/Preliminary WQMP that will serve the project, but are located offsite, list and describe those regional facilities, including any sizing assumptions that may relate to the project. If the Conceptual/Preliminary WQMP included stormwater management site design, source control, low impact design, treatment control, or hydromodification control commitments or performance standards that are specific to the project, then list those in Section 1 of the Project WQMP.

Watershed-based plans may also contain special conditions that must be considered in Project WQMP development. The following watershed-based plans should be reviewed for requirements that may affect the selection of best management practices (BMPs) for the project:

Watershed Infiltration and Hydromodification Management Plans (WIHMP). WIHMPs will be prepared for the Coyote Creek-San Gabriel River by May 2011 and for the Anaheim Bay-Huntington Harbor, Santa Ana River, and Newport Bay-Newport Coast watersheds by May 2012. The WIHMPs will address the HCOCs on a watershed and sub-watershed basis; include maps to identify areas and structures that are susceptible to hydromodification impacts, including downstream erosion, impacts on physical structures, and impacts on riparian and

aquatic habitats; include maps to identify areas where stormwater and urban runoff infiltration is possible and appropriate given sub-surface conditions and other factors such as downgradient habitats; and may specify hydromodification management standards for each sub-watershed.

Total Maximum Daily Load (TMDL) Implementation Plans. A TMDL sets a limit for the total amount of a particular pollutant that can be discharged to a waterbody, such that the pollutant loads from all sources will not impair the designated beneficial uses of the waterbody. A TMDL is developed when a waterbody has been identified as impaired. Section 303(d) of the federal Clean Water Act requires states to establish a listing of all impaired waterbodies and to rank those waterbodies according to priority for TMDL development. This list, called the 303(d) List, is updated every two years and is developed by the Regional and State Water Quality Control Boards and approved by EPA.

The following TMDLs have been established or are being developed for Orange County waterbodies. To find out more about each TMDL or to see the most recent list of TMDLs in Orange County, see the Orange County Watersheds Program webpage at www.ocwatershed.com/TMDL:

- Aliso Creek Indicator Bacteria
- Coyote Creek Metals (copper, lead, zinc)
- Dana Point Harbor - Baby Beach Indicator Bacteria
- San Diego Creek/Newport Bay (Sediment, Nutrient, Toxics, Fecal Coliform²)
- San Juan Creek Indicator Bacteria
- South County Coastal Areas Indicator Bacteria

If a watershed-based plan contains specific stormwater management standards that are applicable to the project, list those specific standards in Section 1 of the Conceptual/Preliminary or Project WQMP. A watershed-based plan may contain standards more stringent than one or both permits.

2.2. Project Description

This section provides guidance for WQMP Template Section II. This section of the Conceptual/Preliminary or Project WQMP should provide the information listed below. The level of detail provided should be general in nature for Conceptual/ Preliminary WQMPs and more specific for Project WQMPs. The purpose of this information is to help determine the applicable Source Control BMPs, pollutants of concern, HCOCs, and long term maintenance responsibilities for the project. This information will be used in conjunction with the

² The Fecal Coliform TMDL applies only to Newport Bay.

information in WQMP Template Section III, Site Description, to establish the performance criteria and to select the BMP plan for the project, in accordance with WQMP Template Section IV.

2.2.1. Project Land Uses

Provide the following information:

- For the entire parcel, list and describe the proposed land uses, the area of each land use, and the estimated imperviousness for each land use.
- List and show on a figure where facilities will be located and what activities will be conducted:
 - List what kinds of materials and products will be used (if known), how and where materials will be received and stored (if applicable), and what kinds of wastes will be generated (if any).
 - Describe all paved areas, including the type of parking areas.
 - Describe all landscaped areas and open space areas (if any).
- For commercial and industrial projects:
 - Provide the Standard Industrial Classification (SIC) Code which best describes the facilities operations.
 - Describe the type of use (or uses) for each building or tenant space (if known).
 - If the project includes food preparation, cooking, and eating areas, specify the location and type of area.
 - Describe delivery areas and loading docks (specify location, design, if below grade, and types of materials expected to be transferred).
 - Describe outdoor materials storage areas (describe and depict location(s), specify type(s) of materials expected to be stored).
 - Describe activities that will be routinely conducted outdoors.
 - Describe any activities associated with equipment or vehicle maintenance and repair, including washing or cleaning.
 - Indicate the number of service bays or number of fueling islands/fuel pumps, if applicable.
- For residential projects:
 - For a single dwelling unit, describe the unit and project site.
 - For a tract, list the range of lot and home sizes.
 - Describe all community facilities such as laundry, car wash, swimming pools, jacuzzi, parks, open spaces, tot lots, etc.

2.2.2. Expected Stormwater Pollutants

Urban runoff from a developed site and stormwater pollution associated with the runoff has the potential to contribute pollutants to the municipal storm drain system and ultimately to the tributary receiving waters. Pollutants that are commonly associated with urban development include suspended solids/sediment, nutrients, metals, microbial pathogens, oil and grease, toxic organic compounds, and trash and debris. The pollutants of concern for a specific project are based upon the pollutants identified by regulatory agencies as impairing receiving waters (described below), and pollutants that are anticipated or potentially could be generated by the project based on the proposed land uses. Section 2.3.4 of the [Model WQMP](#) describes the regulatory criteria for determining the expected stormwater pollutants from a Priority Project.

2.2.2.1. Pollutant Categories

Pollutants of concern can be grouped into the following seven general categories:

- ***Suspended Solids/Sediment:*** consist of soils or other surficial materials that are eroded and then transported or deposited by wind, water, or gravity. Excessive sedimentation can increase turbidity, clog fish gills, reduce spawning habitat, lower young aquatic organisms survival rates, smother bottom dwelling organisms, and suppress aquatic vegetation growth. Sediments in runoff also transport other pollutants that adhere to them, including trace metals, polycyclic aromatic hydrocarbons (PAHs), polychlorinated biphenyls (PCBs), and phosphorus. The largest source of suspended solids / sediment is typically erosion from disturbed soils.
- ***Nutrients:*** includes the macro-nutrients nitrogen and phosphorus. They commonly exist in the form of mineral salts dissolved or suspended in water and as particulate organic matter transported by stormwater. Excessive discharge of nutrients to water bodies and streams can cause eutrophication, including excessive aquatic algae and plant growth, loss of dissolved oxygen, release of toxins in sediment, and significant swings in hydrogen ion concentration (pH). Primary sources of nutrients in urban runoff are fertilizers, trash and debris, and eroded soils. Urban areas with improperly managed landscapes can be substantial sources.
- ***Metals:*** includes certain metals that can be toxic to aquatic life if concentrations become high enough to stress natural processes. Metals of concern include cadmium, chromium, copper, lead, mercury, and zinc. Lead and chromium have been used as corrosion inhibitors in primer coatings and are also raw material components in non-metal products such as fuels, adhesives, paints, and other coatings. Copper and zinc are typically associated with building materials, including galvanized metal and ornamental copper, and automotive products, including tires and brake pads. Humans can be impacted from contaminated groundwater resources, and bioaccumulation of metals in fish and shellfish. Environmental concerns regarding the potential for release of metals to the environment have already led to restricted metal usage in certain applications, for

example lead additives in gasoline. The primary source of metals in urban stormwater is typically commercially available metal products and automobiles.

- **Microbial Pathogens (Bacteria and Viruses):** include bacteria and viruses, which are ubiquitous microorganisms that thrive under a range of environmental conditions. Water containing excessive pathogenic bacteria and viruses can create a harmful environment for humans and aquatic life. The source of pathogenic bacteria and viruses is typically the transport of animal or human fecal wastes from the watershed, but pathogenic organisms do occur in the natural environment.
- **Oil and Grease :** are characterized as high-molecular weight organic compounds. Elevated oil and grease content can decrease the aesthetic value of the water body, as well as the water quality. Introduction of these pollutants to water bodies may occur due to the wide uses and applications of some of these products in municipal, residential, commercial, industrial, and construction areas. Primary sources of oil and grease are petroleum hydrocarbon products, motor products from leaking vehicles, esters, oils, fats, waxes, and high molecular-weight fatty acids.
- **Toxic Organic Compounds:** include organic compounds (pesticides, solvents, hydrocarbons) which at toxic concentrations constitute a hazard to humans and aquatic organisms. Stormwater coming into contact with organic compounds can transport excessive levels organics to receiving waters. Dirt, grease, and grime retained in cleaning fluid or rinse water may also adsorb levels of organic compounds that are harmful or hazardous to aquatic life. Sources of organic compounds include landscape maintenance areas, vehicle maintenance areas, waste handling areas, and potentially most other urban areas.
- **Trash and Debris -** includes trash, such as paper, plastic, and various waste materials, that can typically be found throughout the urban landscape, and debris which includes waste products of natural origin which are not naturally discharged to water bodies such as landscaping waste, woody debris, etc. The presence of trash and debris may have a significant impact on the recreational value of a water body and upon the health of aquatic habitat.

2.2.2.2. Expected Pollutants Based on Project Land Use Activities

This section describes how to determine expected pollutants based on project land use activities and accompanies Section 2.3.4 of the [Model WQMP](#). Pollutants in stormwater runoff are typically related to land use activities, which means that the project's site uses provide some indication of the pollutants that may be present in runoff from the project site. Pollutants that are expected to be generated or have a potential to be generated from a project based on the project's land use activities must be identified using [Table 2.1](#), as applicable. The identification of expected pollutants must always be based on the land use activities proposed. In addition, site-specific conditions must also be considered for potential pollutant sources, such as legacy pesticides or nutrients in site soils as a result of past agricultural practices or hazardous materials in site soils from industrial uses. Hazardous materials that have been remediated and

do not pose a current or future threat to stormwater quality are not considered a pollutant of concern.

Municipal projects should determine expected pollutants based on the pollutant generating activities associated with the project using Table 5.5 in [Section 5 of the Orange County DAMP \(www.ocwatersheds.com/Documents/2003_DAMP_Section_5_Municipal_Activities.pdf\)](http://www.ocwatersheds.com/Documents/2003_DAMP_Section_5_Municipal_Activities.pdf).

Table 2.1: Anticipated and Potential Pollutants Generated by Land Use Type

Priority Project Categories and/or Project Features	General Pollutant Categories							
	Suspended Solid/Sediments	Nutrients	Heavy Metals	Pathogens (Bacteria/Virus)	Pesticides	Oil & Grease	Toxic Organic Compounds	Trash & Debris
Detached Residential Development	E	E	N	E	E	E	N	E
Attached Residential Development	E	E	N	E	E	E ⁽²⁾	N	E
Commercial/ Industrial Development	E ⁽¹⁾	E ⁽¹⁾	E ⁽⁵⁾	E ⁽³⁾	E ⁽¹⁾	E	E	E
Automotive Repair Shops	N	N	E	N	N	E	E	E
Restaurants	E ⁽¹⁾⁽²⁾	E ⁽¹⁾	E ⁽²⁾	E	E ⁽¹⁾	E	N	E
Hillside Development >5,000 ft ²	E	E	N	E	E	E	N	E
Parking Lots	E	E ⁽¹⁾	E	E ⁽⁴⁾	E ⁽¹⁾	E	E	E
Streets, Highways, & Freeways	E	E ⁽¹⁾	E	E ⁽⁴⁾	E ⁽¹⁾	E	E	E
Retail Gasoline Outlets	N	N	E	N	N	E	E	E

E = expected to be of concern
 N = not expected to be of concern

- (1) Expected pollutant if landscaping exists on-site, otherwise not expected.
- (2) Expected pollutant if the project includes uncovered parking areas, otherwise not expected.
- (3) Expected pollutant if land use involves food or animal waste products, otherwise not expected.
- (4) Bacterial indicators are routinely detected in pavement runoff.
- (5) Expected if outdoor storage or metal roofs, otherwise not expected.

2.2.3. Hydrologic Conditions of Concern

As specified in Section 2.3.3 of the [Model WQMP](#), projects must identify and mitigate any HCOCs. A HCOC is a combination of upland hydrologic conditions and stream biological and physical conditions that presents a condition of concern for physical and/or biological degradation of streams.

2.2.3.1. Determining HCOCs in North Orange County

In the North Orange County permit area, HCOCs are considered to exist if any streams located downstream from the project are determined to be potentially susceptible to hydromodification impacts and either of the following conditions exists:

- Post-development runoff volume for the 2-yr, 24-hr storm exceeds the pre-development³ runoff volume for the 2-yr, 24-hr storm by more than 5 percent

OR

- Time of concentration of post-development runoff for the 2-yr, 24-hr storm event exceeds the time of concentration of the pre-development condition for the 2-yr, 24-hr storm event by more than 5 percent⁴.

Calculation methods for determination of HCOCs in the North Orange County permit area are provided in [Appendix IV](#). If these conditions do not exist or streams are not potentially susceptible to hydromodification impacts, an HCOC does not exist and hydromodification does not need to be considered further.

Stream susceptibility must be determined using the regional stream susceptibility maps that are provided in [Appendix XVI](#), watershed-specific maps contained in a WIHMP, and/or site specific engineering analysis using the method described in **Section 2.3.3** below.

³ In North Orange County (Order R8-2009-0030), predevelopment is defined as the existing conditions immediately prior to Project WQMP submittal.

⁴ The North County Permit (Order R8-2009-0030), as adopted, provides the option of reducing Tc to less than the existing condition Tc (within 5 percent) as part of the primary and preferred option for mitigating HCOCs. However, a longer Tc is generally associated with natural conditions than urban conditions, and a longer Tc nearly universally results in lower concern for hydromodification impacts. In addition, it is not physically possible for a project to implement BMPs consistent with LID provisions of the permit without substantially increasing the Tc of the site. The use of retention BMPs results in water not discharged under design conditions, while the use of biotreatment BMPs general results in water not immediately discharged. Therefore, it would not generally be possible to mitigate HCOCs using the primary option for compliance described above while complying with LID requirements. This TGD therefore interprets this provision such that increases in Tc would be acceptable and reduction in Tc of more than 5 percent would not be acceptable. This interpretation is consistent with the overall goal of the permit to protect receiving waters from stormwater impacts to the maximum extent practicable.

2.2.3.2. Determining HCOCs in South Orange County

Interim Criteria

HCOCs are not considered to exist if the downstream conveyance network is not susceptible to hydromodification impacts. Streams susceptibility must be determined using the watershed-specific maps contained in the South Orange County HMP (to be developed by December 2011) and/or with site specific engineering analysis using the method described in **Section 2.3.3** below.

If the project has a HCOC, the Project WQMP should describe the project's receiving waters and document the method used to determine whether the downstream receiving waters are susceptible to HCOCs.

- If regional susceptibility maps are used to establish susceptibility, the Project WQMP should include an exhibit showing the location of the project on the regional susceptibility maps.
- If determination of susceptibility is based on a site-specific investigation, the Project WQMP should summarize the findings of the site-specific investigation.

[Appendix V](#) describes the approved hydrologic methods for identifying and mitigating HCOCs in the South Orange County permit area

2.2.4. Post Development Drainage Characteristics

The Project WQMP should generally describe the proposed drainage for the site, including the following:

- Will the site connect to a storm drain system or discharge directly into a receiving water body?
- If the site will connect to a storm drain system, name the locations for the connection(s).
- Name the direct receiving water body for the project site and list each subsequent water body until reaching the ocean. If the project will connect to the storm drain, determine where the storm drain system discharges into a receiving water body. For assistance in mapping the receiving water bodies, see the maps provided in [Appendix XVI](#).

The purpose of this section of the Project WQMP is to establish the immediate fate of water leaving the project site and to identify the site constraints relative to the general drainage patterns of the site and the off-site drainage connections. It is not the intent of this section to describe the drainage and BMP plan in detail. A more detailed description of the drainage and BMP plan should be provided in Section IV of the Project WQMP.

2.2.5. Property Ownership/Management

Describe the ownership of all portions of the project and site. State whether any infrastructure will transfer to public agencies (City, County, Caltrans, etc.). State if a homeowners or property owners association will be formed that will be responsible for the long term maintenance of the project's stormwater facilities.

2.2.6. Water Quality Credits

Water quality credits and their intended applicability and role in WQMP preparation are discussed in Section 3.1 of the [Model WQMP](#). Water quality credits are intended to reduce the remaining unmet obligations for LID and treatment control after the maximum feasible level of control has been provided. As such, a Project could qualify for water quality credits but not need to claim these credits if the required BMP sizing can be feasibly provided without these credits.

The applicability of water quality credits is generally based on Project characteristics, therefore the Project characteristics that qualify the Project for water quality credits should be described in this section of the WQMP Template, as applicable. If a Project qualifies for water quality credits, but does not claim these credits, it is optional for the WQMP to describe the qualifying project features. Calculation methods for applying water quality credits are described in [Appendix VI](#).

2.3. **Site Description**

This section provides the guidance for WQMP Template Section III. The purpose of this section of the Conceptual/Preliminary or Project WQMP is to describe the project site conditions that will inform the selection and design of BMPs through an analysis of the physical conditions and limitations of the site and its receiving waters.

2.3.1. Physical Setting

If the project is not located on an already developed site, then identify the planned community and planning area for the project, if applicable. If the project is located on an already developed site, then identify the location using the site address.

2.3.2. Site Characteristics

Assessing a site's potential for implementation of LID, treatment control, and hydromodification control BMPs requires the review of existing information and may include the collection of site-specific measurements. Available information regarding site characteristics such as impervious cover, slope, soil type, geotechnical conditions, and local groundwater conditions should be discussed in this section of the WQMP Template. In addition, soil and infiltration testing may be necessary to determine if stormwater infiltration is feasible and to

determine the appropriate design infiltration rates for infiltration-based BMPs. Impervious cover is the most important characteristic to determine the presence of HCOCs for the North Orange County permit area and is always required to be documented in this section of the Project WQMP. For redevelopment projects, the percentage of impervious cover added as a fraction of the existing impervious cover left in place is critical for determining the portions of the project that must comply with LID, hydromodification control, and treatment control requirements (See Section 1.2 of the [Model WQMP](#) for project applicability).

Section 2.3 of the [Model WQMP](#) describes mandatory site assessment requirements applicable to specific project types. The following subsections are intended to provide recommendations for meeting these requirements. The specific recommendations contained in this section are not intended to prevent the consideration of site-specific factors or substitute for the need to exercise sound engineering judgment. In addition, the recommendations made in this section are intended to be applied to the extent that they are necessary to meet minimum site-assessment requirements. These recommendations are not intended to imply that each of these analyses must be conducted for every Project if an equally reliable source of information is available in place of any of these analyses or if the analysis outcome is obvious and can be documented based on simpler analysis methods. For example, if groundwater is known to be very deep based on regional surveys or other available information, it is not necessary to conduct an evaluation of the exact water table or the potential for groundwater mounding.

2.3.2.1. Topography

The site's topography should be assessed to evaluate surface drainage, topographic high and low points, and to identify the presence of steep slopes that qualify as hillside locations, all of which have an impact on what type of LID and treatment control BMPs will be most beneficial for a given project site. Stormwater infiltration is more effective on level or gently sloping sites. Flows applied to slopes steeper than 15% may runoff as surface flows, rather than soak into the ground. On hillsides, infiltrated runoff may daylight a short distance down slope, which could cause slope instability depending on the soil or geologic conditions. See the [Geotechnical Considerations](#) section below.

Topographic assessment and mapping should also document existing condition impervious area, drainage patterns, the interface of site topography with adjacent parcels/right of ways (i.e., manufactured slopes), and any other topographic features of interest to site layout and/or stormwater management.

2.3.2.2. Soil Type and Geology

The site's soil types and geologic conditions should be determined to evaluate the site's ability to infiltrate stormwater and to identify suitable and unsuitable locations for siting infiltration-based BMPs. The Orange County Soil Survey (NRCS, CA678, 1978) identifies soils as

Hydrologic Soil Groups (HSG) A, B, C and D [for further information, see <http://soils.usda.gov/>]. These soil groups are mapped in [Appendix XVI](#).

- Group A soils are typically sands, loamy sands, or sandy loams. Group A soils have low runoff potential and high infiltration rates even when thoroughly wetted. They consist chiefly of deep and well to excessively drained sands or gravels and have a high rate of water transmission.
- Group B soils are typically silt loams or loams. They have a moderate infiltration rate when thoroughly wetted and consist chiefly of moderately deep to deep and moderately well to well drained soils with moderately fine to moderately coarse texture.
- Group C soils are typically sandy clay loams. They have low infiltration rates when thoroughly wetted, consist chiefly of soils with a layer that impedes downward movement of water, and/or have moderately fine to fine soil structure.
- Group D soils are typically clay loams, silty clay loams, sandy clays, silty clays, or clays. They have very low infiltration rates when thoroughly wetted and consist chiefly of clay soils with high swelling potential, permanent high water table, claypan or clay layer at or near the surface, and/or shallow soils over nearly impervious material.

Soils in Group A and B tend to have higher potential for infiltration based on likely infiltration rates and distance to a limiting horizon. Soils in Group C and D are less likely to have sufficient infiltration rate and distance to a limiting horizon to support stormwater infiltration.

Early identification of soil types throughout the project footprint can reduce the number of test pit investigations and infiltration tests by narrowing potential test sites to locations that are most amenable to infiltration. Guidance for conducting test pit investigations and infiltration tests is provided in [Appendix VII](#).

In addition, available geologic or geotechnical reports on local geology should be reviewed to identify relevant features such as depth to bedrock, rock type, lithology, faults, and hydrostratigraphic or confining units. These geologic investigations may also identify shallow water tables and past groundwater or soil contamination issues that are important for BMP design (see below). Geologic investigations may provide an assessment of whether soil infiltration properties are likely to be uniform or variable across the project site.

2.3.2.3. Groundwater Considerations

Site groundwater conditions should be considered prior to LID BMP and treatment control BMP siting, selection, sizing, and design.

Groundwater Levels

The depth to seasonal high groundwater table (normal high depth during the wet season) beneath the project may preclude infiltration. Depth to seasonal high groundwater level should be estimated as the average of the annual minima (i.e., the shallowest recorded measurements in each water year, defined as October 1 through September 30) for all years on record. If

groundwater level data are not available or not considered to be representative, seasonal high groundwater depth can be determined by redoximorphic analytical methods combined with temporary groundwater monitoring for November 1 through April 1 at the proposed project site. [Appendix VIII](#) provides guidance for determining the depth to seasonally high groundwater table and the potential magnitude of groundwater mounding that could occur below infiltration BMPs.

Groundwater and Soil Contamination

In areas with known groundwater and soil pollution, infiltration may need to be avoided if it could contribute to the movement or dispersion of soil or groundwater contamination or adversely affect ongoing clean-up efforts. Mobilization of groundwater contaminants may also be of concern where contamination from natural sources is prevalent (e.g., marine sediments, selenium rich groundwater, to the extent that data is available). If infiltration is under consideration in areas where soil or groundwater pollutant mobilization is a concern, a site-specific analysis must be conducted where soil or groundwater pollutant mobilization is a concern to determine where infiltration-based BMPs can be used without adverse impacts.. It is possible that a certain amount of stormwater infiltration would not be detrimental, or could be beneficial. See [Appendix VIII](#) for specific guidance on assessing groundwater and soil contamination to ensure that project drainage plans are protective of groundwater quality.

Infiltration activities should be coordinated with the applicable groundwater management agency, such as the Orange County Water District, to ensure groundwater quality is protected. It is recommended that coordination be initiated as early as possible during the Preliminary/Conceptual WQMP development process, as part of the CEQA process (preferred) or otherwise. See [Appendix VIII](#) for specific guidance.

Protection of Groundwater Quality

Research conducted on the effects on groundwater from stormwater infiltration by Pitt et al. (1994) indicate that the potential for contamination due to infiltration is dependent on a number of factors including the local hydrogeology and the chemical characteristics of the pollutants of concern. Chemical characteristics that influence the potential for groundwater impacts include high mobility (low absorption potential), high solubility fractions, and abundance of pollutants in urban runoff. As a class of constituents, trace metals tend to adsorb onto soil particles and are filtered out by the soils. This has been confirmed by extensive data collected beneath stormwater detention/retention ponds in Fresno (conducted as part of the Nationwide Urban Runoff Program (Brown & Caldwell, 1984)) that showed that trace metals tended to be adsorbed in the upper few feet in the bottom sediments. Bacteria are also filtered out by soils. More mobile and soluble pollutants, such as chloride and nitrate, have a greater potential for impacting groundwater.

[Appendix VIII](#) provides criteria for infiltration related to protection of groundwater quality, including:

- Minimum separation groundwater, including guidance for calculating mounding potential,

- Categorization of infiltration BMPs by relative risk of groundwater contamination,
- Pollutant sources in the tributary watershed and pretreatment requirements,
- Setbacks from known plumes and contaminated sites,
- Guidelines for review by applicable groundwater management agencies.

Infiltration BMP Fact Sheets ([Appendix XIV](#)) identify BMPs that are potentially categorized as Class V Injection Wells, and may have additional permitting requirements.

Groundwater Recharge

Infiltration of stormwater can provide the benefit of recharging groundwater. As feasible, infiltration BMPs should be located in areas where infiltration would be most beneficial for groundwater recharge. The site characterization should attempt to identify areas where infiltration would have the greatest benefit for groundwater recharge. Generally a greater fraction of infiltrated water reaches groundwater in cases where there is a relatively direct hydrogeologic connection between the surface and an aquifer.

Groundwater/Surface Water Interactions

Groundwater discharge to surface water is generally a primary source of dry weather base flows in perennial stream systems. Intermittent and ephemeral systems are often characterized by groundwater discharge during portions of the year and streams losing flow to groundwater during other portions of the year. These systems may be sensitive to minor changes in groundwater levels which could result from increased infiltration compared to the existing condition. In such systems, increases in groundwater levels could potentially increase the duration of dry weather base flows in intermittent and ephemeral drainages. These changes may have significant impacts on riparian habitat and geomorphology. If intermittent or ephemeral drainages are located adjacent to and down-gradient of the project, the application of infiltration BMPs would could potentially impact these drainages, which would result in a finding of infeasibility for infiltration. The Conceptual/Preliminary or Project WQMP should provide analyses to support this finding.

2.3.2.4. Geotechnical Considerations

Infiltration of stormwater can cause geotechnical issues, including: (1) settlement through collapsible soil, (2) expansive soil movement, (3) slope instability, and (4) an increased liquefaction hazard. Stormwater infiltration temporarily raises the groundwater level near the infiltration facility, such that the potential geotechnical conditions are likely to be of greatest significance near the area of infiltration and diminish with distance. If infiltration BMPs are considered, a geotechnical investigation should be performed for the infiltration facility to identify potential geotechnical issues and geological hazards that may result from infiltration and identify potential mitigation measures.

Increased water pressure in soil pores reduces soil strength. Decreased soil strength can make foundations more susceptible to settlement and slopes more susceptible to failure. In general,

infiltration-based BMPs must be set back from building foundations or steep slopes. Recommendations for each site should be determined by a licensed geotechnical engineer based on soils boring data, drainage patterns, and the current requirements for stormwater treatment. Implementing the geotechnical engineer's requirements is essential to prevent damage from increased subsurface water pressure to surrounding properties, public infrastructure, sloped banks, and even mudslides.

Collapsible Soil

Typically, collapsible soil is observed in sediments that are loosely deposited, separated by coatings or particles of clay or carbonate, and subject to saturation. Infiltration of stormwater may result in a temporary rise in the groundwater elevation. This rise in groundwater could change the soil structure by dissolving or deteriorating the intergranular contacts between the sand particles, resulting in a sudden collapse, referred to as hydrocollapse. This collapse phenomenon generally occurs during the first saturation episode after deposition of the soil, and repeated cycles of saturation are not likely to result in additional collapse. If infiltration is considered, it is important to evaluate the potential for hydrocollapse during the geotechnical investigation. The magnitude of hydrocollapse is proportional to the thickness of the soil column where infiltration is occurring; in most instances, the magnitude of hydrocollapse will be small. Regardless, if infiltration BMPs are considered, the geotechnical engineer should evaluate the potential effects of hydrocollapse and, if necessary, specify mitigation and monitoring measures.

Expansive Soil

Expansive soil is generally defined as soil or rock material that has a potential for shrinking or swelling under changing moisture conditions. Expansive soils contain clay minerals that expand in volume when water is introduced and shrink when the water is removed or the material is dried. When expansive soil is present near the ground surface, a rise in groundwater from infiltration activities can introduce moisture and cause these soils to swell. Conversely, as the groundwater surface falls after infiltration, these soils will shrink in response to the loss of moisture in the soil structure. The effects of expansive soil movement (swelling and shrinking) will be greatest on near surface structures such as shallow foundations, roadways, and concrete walks. Basements or below-grade parking structures can also be affected as additional loads are applied to the basement walls from the large swelling pressures generated by soil expansion. If infiltration BMPs are considered, the geotechnical investigation should identify if expandable materials are present near the proposed infiltration facility, and if they are, evaluate if the infiltration will result in wetting of these materials and any potential mitigation measures.

Slopes

Slopes near infiltration facilities can be affected by the temporary rise in groundwater. The presence of a water surface near a slope can substantially reduce the stability of the slope from a dry condition. If infiltration BMPs are considered near a slope, groundwater mounding analysis

should be performed to evaluate the rise in groundwater around the facility. If the computed rise in groundwater approaches nearby slopes, then a separate slope stability evaluation should be performed to evaluate the implications of the temporary groundwater surface. The geotechnical and groundwater mounding evaluations should identify the duration of the elevated groundwater and assign factors of safety consistent with the duration (e.g., temporary or long-term conditions).

Liquefaction

Soil liquefaction is a phenomenon in which saturated granular materials experience a reduction in bulk volume and a loss of bearing capacity induced by seismic motion. Soil liquefaction can also result in instabilities and lateral spreading in embankments and areas of sloping ground.

Saturation of the subsurface soils above the existing groundwater table may occur as a result of stormwater infiltration. If infiltration BMPs are considered, the potential for liquefaction should be assessed. If this assessment shows that potential for liquefaction exists, appropriate geotechnical analyses should be conducted to determine the level of stormwater infiltration that can be safely tolerated.

2.3.2.5. Off-Site Drainage

Locations and sources of off-site run-on onto the site should be identified in the Conceptual/Preliminary or Project WQMP. Off-site drainage should be considered when determining appropriate BMPs for the site so that the drainage can be managed. Concentrated flows from offsite drainage may cause extensive erosion if not properly conveyed through or around the project site or otherwise managed. Vegetated swales or storm drains may be used to intercept, divert, and convey off-site drainage through or around a site, without treatment, to prevent comingling of drainage and flooding or erosion that might otherwise occur. Unless it is the goal of the project to provide treatment of off-site flows, these flows should be diverted around the project BMPs and should not be comingled with untreated water from the project site. Stormwater management requirements described in the Section 2.4 of the [Model WQMP](#) apply to off-site drainage if it is comingled with project runoff.

2.3.2.6. Existing Utilities

Existing subsurface utilities will limit the possible locations of certain BMPs and may constrain site design. If infiltration BMPs are considered, the potential impacts of stormwater infiltration on subsurface utilities should be evaluated to establish necessary setbacks from these utilities or if the utilities need to be relocated.

2.3.3. Watershed Description

2.3.3.1. Identifying Water Quality Impairments and TMDLs

The presence of impairments and TMDLs has an important role identification of pollutants of concern and therefore selection of BMPs for the project. Therefore, it is important to identify impairment and TMDLs as part of Section III of the Project WQMP.

When designated beneficial uses of a particular receiving water body are being compromised by water quality for a specific or multiple pollutants, Section 303(d) of the CWA requires identifying and listing that water body as “impaired”. **Table 2.2** lists the impaired waterbodies within the North Orange County permit area that are included on the 2006 and tentative 2010 303(d) lists and **Table 2.3** lists the impaired waterbodies within the South Orange County permit area that are included on the 2006 and tentative 2010 303(d) list. Note, at the time of publishing, the 2010 303(d) lists had been approved by the State Water Resources Control Board, but had not been approved by USEPA Region 9. Edits may still occur before the 2010 303(d) list is finalized. Project proponents should consult the most recent EPA-approved 303(d) list to identify whether the project’s proximate and downstream receiving water bodies are listed as impaired. The WQMP should document the 303(d) list that was consulted. The most recent EPA-approved 303(d) list is located on the State Water Resources Control Board website⁵

Table 2.4 lists TMDLs that have been adopted and are being implemented in the Orange County Watersheds as of May 2010.

⁵ http://www.swrcb.ca.gov/water_issues/programs/#wqassessment

Table 2.2: Summary of the Approved 2006 and Tentative 2010 303(d) Listed Water Bodies and Associated Pollutants of Concern for North Orange County

Region	Water Body	Pollutant																		
		Bacteria Indicators/ Pathogens		Metals		Nutrients		Pesticides		Toxicity		Trash		Salinity/ TDS/ Chlorides		Turbidity		Other Organics		
		2006 List	2010 List	2006 List	2010 List	2006 List	2010 List	2006 List	2010 List	2006 List	2010 List	2006 List	2010 List	2006 List	2010 List	2006 List	2010 List	2006 List	2010 List	
Region 8 Santa Ana	Anaheim Bay			X	X			X	X	X	X							X	X	
	Bolsa Chica Channel			X	X															
	Buck Gully Creek	X	X																	
	Huntington Beach State Park	X																X	X	
	Huntington Harbor	X	X	X	X			X	X	X	X							X	X	
	Los Trancos Creek (Crystal Cove Creek)	X	X																	
	Newport Bay, Lower			X		X		X		X	X							X	X	
	Newport Bay, Upper (Ecological Reserve)			X		X		X		X	X						X	X	X	
	San Diego Creek, Reach 1	X	X	X		X		X												
	San Diego Creek, Reach 2			X																
	Seal Beach	X	X																X	X
	<i>Silverado Creek</i>	X	X											X	X					

Note at the time of publication, the 2010 303(d) lists had been approved by the State Water Resources Control Board, but had not been approved by USEPA Region 9. Modifications may be made prior to approval by EPA. Project proponents should consult the most recent 303(d) list located on the State Water Resources Control Board website⁶.

⁶ http://www.swrcb.ca.gov/water_issues/programs/#wqassessment

Table 2.3: Summary of the Approved 2006 and Tentative 2010 303(d) Listed Water Bodies and Associated Pollutants of Concern for South Orange County

Region	Water Body	Pollutant																		
		Bacteria Indicators/ Pathogens		Metals		Nutrients		Pesticides		Toxicity		Trash		Salinity/ TDS/ Chlorides		Turbidity		Other Organics		
		2006 List	2010 List	2006 List	2010 List	2006 List	2010 List	2006 List	2010 List	2006 List	2010 List	2006 List	2010 List	2006 List	2010 List	2006 List	2010 List	2006 List	2010 List	
Region 9 San Diego	Aliso Creek (Mouth)	X	X																	
	Aliso Creek (20 Miles)	X				X	X			X	X									
	Dana Point Harbor	X	X		X						X									
	Pacific Ocean Shoreline, Aliso Beach HSA	X																		
	Pacific Ocean Shoreline, Dana Point HSA	X																		
	Pacific Ocean Shoreline, Laguna Beach HSAs	X																		
	Pacific Ocean Shoreline, Lower San Juan HSA	X	X																	
	Pacific Ocean Shoreline, San Clemente HA at San Clemente City Beach, North Beach	X	X																	
	Pacific Ocean Shoreline, Other San Clemente and San Joaquin Hills HAs	X																		
	Pacific Ocean Shoreline, San Mateo Canyon HAs		X																	
	Prima Deshecha Creek				X	X	X										X	X		
	San Juan Creek	X			X		X	X				X								
	Segunda Deshecha Creek					X	X					X					X	X		

Note a the time of publication, the 2010 303(d) lists had been approved by the State Water Resources Control Board, but had not been approved by USEPA Region 9. Modifications may be made prior to approval by EPA. Project proponents should consult the most recent 303(d) list located on the State Water Resources Control Board website⁷.

⁷ http://www.swrcb.ca.gov/water_issues/programs/#wqassessment

Table 2.4: Summary of the Status of TMDLs for Waterbodies in Regions 8 and 9

Region	Water Body	Pollutant				
		Bacteria Indicators/ Pathogens	Metals	Nutrients	Pesticides	Turbidity/ Siltation
Region 8 Santa Ana	Newport Bay, Lower	Implementation Phase	Technical TMDLs	Implementation Phase	Technical TMDLs	Implementation Phase
	Newport Bay, Upper (Ecological Reserve)	Implementation Phase	Technical TMDLs	Implementation Phase	Technical TMDLs	Implementation Phase
	San Diego Creek, Reach 1		Technical TMDLs	Implementation Phase	Technical TMDLs and Implementation Phase	Implementation Phase
	San Diego Creek, Reach 2		Technical TMDLs	Implementation Phase		Implementation Phase
Region 9 San Diego	Aliso Creek (20 Miles) Pacific Ocean Shoreline, Laguna Beach HSAs	Implementation Phase				
	Dana Point Harbor Pacific Ocean Shoreline HSAs	Implementation Phase or In Progress				
	Pacific Ocean Shoreline, San Clemente HA	In Progress				
	San Juan Creek (mouth)	Implementation Phase				

2.3.3.2. Selecting the Pollutants of Concern for the Project

Compare the list of pollutants for which the receiving waters are impaired or for which TMDLs have been adopted with the pollutants anticipated to be generated by the land uses included in the project (as identified in [Table 2.1](#))

Primary Pollutants of Concern are any pollutants anticipated to be generated by the project using [Table 2.1](#) that have also been identified as causing impairment of project receiving waters ([Table 2.2](#) or [Table 2.3](#)) or for which a TMDLs is in place ([Table 2.4](#)). Other pollutants of concern are those pollutants anticipated to be generated by the project using [Table 2.1](#) that have not been identified as causing impairment in the project's receiving waters.

Further information on pollutants of concern may also be available from the environmental impact assessment for the project (e.g., project-specific pollutant evaluations in CEQA EIRs). Watershed planning documents should also be reviewed for identification of specific implementation requirements that address pollutants of concern.

Guidance on selecting LID and treatment control BMPs to address pollutants of concern is provided in [Section 2.4.2.5](#).

2.3.3.3. Method for Determining Stream Susceptibility

Definitions of susceptibility are similar in the North and South Orange County permit areas:

- In the North Orange County permit area, downstream channels are considered not susceptible to hydromodification, and therefore do not have the potential for a HCOC, if all downstream conveyance channels that will receive runoff from the project are engineered, hardened, and regularly maintained to ensure design flow capacity, and no sensitive habitat areas will be affected. The maps of such conveyance channels provided in [Appendix XVI](#) may be used to determine susceptibility in the North Orange County permit area. These maps may be updated in the WIHMPs. The most current map should be used for this determination. The proponent should check for updates to these maps on the www.ocwatersheds.com website.
- In the South Orange County permit area, downstream channels are considered not susceptible to hydromodification, and therefore projects do not have a potential HCOC, if (1) the project discharges stormwater runoff into underground storm drains discharging directly to bays or the ocean, or (2) storm water runoff conveyance channels whose bed and bank are concrete lined all the way from the point of discharge to ocean waters, enclosed bays, estuaries, or water storage reservoirs and lakes. Hydromodification susceptibility maps will be prepared as part of the HMP development in the South Orange County permit area. In the interim until the HMP is developed, the guidance for assessing stream susceptibility provided in this section shall be followed to determine whether a channel is susceptible.

In the North Orange County permit area, determination of susceptibility is only required for projects which have a HCOC; projects which do not have a HCOC as a result of proposed development are not required to assess susceptibility.

Where regional maps are inconclusive, it must be assumed that the project's receiving waters are susceptible to hydromodification impacts unless a downstream assessment is completed by a licensed geomorphic professional.

A downstream assessment of susceptibility may be conducted by a licensed geomorphic professional for any project. This assessment should consider:

- The inherent potential for a stream channel to undergo excessive downcutting or widening in response to hydromodification caused by land use changes is related to a number of factors, including the nature of the bed and bank materials, channel geometry and slope, sediment supply, and flow regime. Potential impacts on channel stability must include considerations of the following, as applicable:
 - **Bed and bank materials.** Sand bedded streams have lower critical shear stresses and are more readily transported by increased flows, whereas channel materials that are larger, such as gravels and cobbles, and more cohesive, such as clays, are more resistant.
 - **Channel geometry and slope.** The magnitude of applied shear stress on the channel boundary for a given flow is dependent on both cross section geometry and longitudinal slope. The width to depth ratio of the channel will influence how shear stresses increase with increasing flows (e.g. with other factors such as slope and bottom and side slope materials the same, deep, narrow channels will experience higher shear stresses for a given flow than a more shallow, wider channel of similar cross-sectional area). Incised channels may also have banks which are close to or above the critical height for stability (a function of bank angle and degree of cohesion, in addition to height).
 - **Sediment supply.** Sediment-starved or "hungry" water can lead to channel degradation and instability. Land development can cause a reduction in the amount of sediment delivered to a stream system by trapping sediment in detention facilities and/or removing sediment supply by mass grading, compaction, landscaping, and paving. In the tectonically active region of Southern California, many streams are naturally transport-limited, meaning the rate that sediment is supplied to the stream network is greater than the in-stream sediment transport capacity. If the sediment supply is reduced to a level less than the transport capacity, then the stream becomes supply-limited and susceptible to excess in-stream erosion due to sediment supply reductions.
 - **Flow regime.** Reduced infiltration and interception storage capacity associated with impervious surfaces and soil compaction result in increased magnitude and frequency of surface runoff. Furthermore, ephemeral/intermittent streams in

Southern California appear to be highly sensitive to changes in total basin impervious cover, more-so than perennial streams (SCCWRP, 2005⁸). Ephemeral/intermittent streams are also considered more susceptible to vegetation type changes (and resulting habitat impacts) due to dry weather flows even if these flows are not great enough to cause excess erosion.

- Physical structures may be severely impacted by channel morphological changes and instability, resulting in potential loss of infrastructure, property damage, creation of unsafe conditions for residents and motorists, and water quality impacts through leaks or spills of toxic or oxygen demanding materials. Infrastructure can in turn cause changes in sediment transport processes within stream channels, and therefore these data will also inform the assessment of susceptibility to excess erosion. Existing infrastructure may also provide some opportunities to control hydromodification impacts. For example, by retrofitting the existing outlet structure of a detention basin to mimic the pre-development flow regime or through routing runoff into a reclaimed water supply system (assuming water supply standards have been adequately addressed) such as Rattlesnake or Sand Canyon Reservoirs. Potential impacts to physical structures must consider the following, as applicable:
 - Utility networks (e.g., sewer lines, gas lines, etc.)
 - Road crossings (culverts and bridges)
 - Storm Drains
 - Constructed channel network
 - In-stream drop structures / grade control
 - Dams and other basins

- Currently, most quantitative design standards for hydromodification management focus primarily on controlling excess erosion. While prevention of excess erosion is considered a necessary prerequisite for a healthy stream ecosystem, it may not be a sufficient condition, as riparian habitats and aquatic biota can be impacted by other aspects of hydromodification including changes in flow regime and water quality. Therefore, a channel considered to be fairly resistant to excess erosion may still be highly susceptible to habitat and biota impacts. Potential impacts to riparian and aquatic habitat should consider:
 - Longitudinal connectivity of the stream system (i.e., to allow for migration of fauna)
 - Lateral connectivity of the stream channel to its floodplain
 - Existing riparian corridors

⁸ Southern California Coastal Water Research Project (SCCWRP). 2005. Effect of Increases in Peak Flows and Imperviousness on the Morphology of southern California Streams. Technical Report 450.

- Perennial and ephemeral channels
- Channels where groundwater discharges either seasonally or year-round
- Impaired waterbodies
- Existing and proposed treatment BMPs
- Channel reaches planned for enhancement or restoration
- Water quality monitoring and bioassessment sampling locations and data
- Existing vegetation types, special habitat, locations of threatened or endangered species, and barriers restricting movement

2.3.3.4. Determining Environmentally Sensitive Areas and Areas of Special Biological Concern

To assist developers in determining the presence of ESAs such as areas designated in the Ocean Plan as Areas of Special Biological Significance (ASBS) or waterbodies listed on the CWA Section 303(d) list of impaired waters, The County of Orange has prepared watershed maps that identify each ESA within Orange County (see OC Watersheds website:

<http://www.ocwatersheds.com/ESA.aspx>).

A Priority Project may potentially impact a water body considered to be an ESA if this project is:

- Within or adjacent to, or
- Discharge pollutants directly to an ESA

For the purposes of these procedures, the following terms are defined:

- *Adjacent* -located within 200 feet of the listed water body
- *Discharging directly to* -discharge from a drainage system that is composed entirely of flows from the subject facility or activity, i.e., discharge from an urban area that comingles with downstream flows prior to an ESA is not subject to this requirement.

An ESA exists if any of the following designations have been applied to the water body of concern:

- Clean Water Act 303(d) listed impaired water body based on [most recent approved 303\(d\) list](#).
- Areas designated as Areas of Special Biological Significance by the SWRCB in the Water Quality Control Plan for Ocean Waters of California (California Ocean Plan)
- Water bodies designated with the RARE beneficial use by the SWRCB in the Water Quality Control Plans for the Santa Ana River and San Diego Basins (Region 8 and Region 9 Basin Plans)
- Water bodies located within areas designated under the California Department of Fish and Game's Natural Community Conservation Planning (NCCP) Program as preserves or equivalent in subregional plans (<http://www.dfg.ca.gov/nccp/status.htm>)
- Areas designated as Critical Aquatic Resources in the Orange County Drainage Area Management Plan (DAMP)

- Any other equivalent ESAs that contain water bodies that have been identified by the local jurisdiction to be of local concern.

The maps available at the OC Watersheds website (<http://www.ocwatersheds.com/ESA.aspx>) may be used to assist in the identification and classification Priority Projects in order to determine if they potentially impact an ESA.

2.4. Best Management Practices (BMPs)

This section provides the guidance for WQMP Template Section IV. The purpose of this section of the Conceptual/Preliminary or Project WQMP is to establish the project performance criteria, to describe the site design and drainage plan, to document the conformance of the project with the performance criteria, and to describe the alternative compliance plan (if applicable).

This section of this TGD describes how the regulatory requirements contained in Section 2.4 of the [Model WQMP](#) should be applied to develop a site design and drainage plan, and how to demonstrate that this plan conforms to project performance criteria. This section provides guidance for three general steps:

1. Identify and document performance criteria applicable to the project (**Section 2.4.1**),
2. Develop a site design and drainage plan that meets project performance criteria (**Section 2.4.2**)
3. Demonstrate that the site design and drainage plan meets performance criteria (**Section 2.4.3**)

Regulatory requirements are contained in Section 2.4 of the [Model WQMP](#) and are incorporated into this guidance by reference. Specific criteria and calculations supporting these steps are contained in [Appendices to this TGD](#).

The scale at which analyses are conducted and calculations are performed is important to ensure that valid conclusions are reached. **Table 2.5** outlines the scale at which specific steps in the WQMP preparation process should be conducted.

Table 2.5: Recommended Scale of Analyses for Project WQMP Preparation

Step in Project WQMP Development	Scale of Analysis ^{1,2}
Determine applicable performance criteria (LID, treatment control, and hydromodification control)	Project/Regional
LID Infeasibility Screening	Group of similar, contiguous drainage areas <i>OR</i> individual drainage areas
LID BMP prioritization	Group of similar, contiguous drainage areas <i>OR</i> individual drainage areas
Calculate required BMP volumes or flowrates	Individual drainage areas
Evaluate maximum feasible LID BMP implementation	Individual drainage areas
Calculate remaining requirements not met by on-site LID BMPs	Individual drainage areas, combined to Project totals
Evaluate regional and subregional BMPs	Project
Identify acceptable treatment control BMPs to address POCs	Individual drainage areas
Alternative LID and/or WQ compliance	Project
Evaluate hydromodification performance criteria	Project, divided by receiving water

¹ Note that small projects may consist of one drainage area.

² Projects draining to multiple receiving waters shall conduct assessment for each distinct receiving water, as applicable.

2.4.1. Project Performance Criteria

This section describes how project performance criteria should be determined and summarized for inclusion in WQMP Template Section IV. Providing a summary of performance criteria in the Project WQMP provides context for the Site Design and Drainage Plan and the Project Conformance Analysis.

The checklist contained in Section IV of the WQMP template is the recommended means of summarizing performance criteria. Performance criteria for LID, treatment control, and hydromodification control BMPs and their applicability are contained in Section 2.4 of the [Model WQMP](#).

2.4.2. Site Design and Drainage Plan

This section describes a process for developing a functional drainage plan that works with the site constraints and for selecting BMPs based on BMP priority, site conditions/constraints, and pollutants of concern.

2.4.2.1. Incorporating Site Design Practices

LID requires an integrated approach to site design and stormwater management. Traditional approaches to stormwater management planning are not likely to be effective. The use of site planning techniques presented in this section will help generate a more hydrologically functional site, help to maximize the effectiveness of LID BMPs, and integrate stormwater management throughout the site.

2.4.2.2. Conceptual Drainage Planning

Conceptual drainage plans are key tools in site planning. A conceptual drainage plan shows the rough delineations of the major drainage areas on the project, typically defined by the points of discharge from the site. Small projects may have only one drainage area.

The following concepts should be considered during the early site planning stages:

- LID BMPs should be considered as early as possible in the site planning process. Hydrology should be an organizing principle that is integrated into the initial site assessment planning phases. Where flexibility exists, conceptual drainage plans should attempt to route water to areas suitable for retention BMPs.
- A multidisciplinary approach is recommended that includes planners, engineers, landscape architects, and architects at the initial phases of the project.
- Individual LID BMPs may be distributed throughout the project site as feasible and may influence the configuration of roads, buildings and other infrastructure.
- Flood control should be considered early in the design stages. Even sites with LID BMPs will still have runoff that occurs during large storm events, but LID facilities can have flood control benefits. It may be possible to simultaneously address flood control requirements through an integrated water resources management approach (see [Section 3.7](#))

Perhaps the most important aspect of site planning is allowing sufficient space for LID BMPs in areas that can physically accept runoff. Simple rules of thumb are presented in

[Table 2.6](#) to help allow sufficient space in preliminary design.

Table 2.6: Approximate Space Requirements for Structural BMPs

BMP Selected	Percent of Tributary Impervious Area Required	
	Well Drained Soils	Moderately Drained Soils
LID Infiltration	2 to 5	5 to 10
LID Harvest and Reuse	1-2 percent of tributary area (cistern 8 feet tall, indoor or outdoor)	

Site design principles presented in [Section 3](#) should be employed at this phase in the Project WQMP preparation process.

Refer to the Bay Area Stormwater Management Agencies Association (BASMAA) [Start at the Source](#) manual for more guidance on LID site design practices.

Divide Site into Drainage Management Areas or Similar

Dividing the project site into DMAs is a common step in the preparation of stormwater management plans, and provides a framework for feasibility screening, BMP prioritization, and stormwater management system configuration. The use of DMAs is strongly encouraged, but is not mandatory. Similar strategies for laying out the conceptual drainage plan for the site may be used in the Project WQMP preparation process.

DMAs are defined based on the proposed drainage patterns of the site and the BMPs to which they drain. At this phase of the Project WQMP preparation process, BMPs may not have been selected. In this case, DMAs would be delineated based on site drainage patterns and possible BMP locations identified in the site planning process.

A DMA may drain to a single BMP or to a group of similar BMPs distributed throughout the DMA. For example, a drainage management area may be defined as 10 acres of mixed urban land uses draining to an infiltration basin near the lower end of the project site, or a DMA may be defined as a 2 acre parking lot with several bioretention areas distributed throughout with similar design standards. DMAs should not overlap and should be approximately homogenous with respect to BMP opportunities and feasibility constraints.

Calculate Design Capture Volume for Drainage Areas

The design capture volume (DCV) should be established for each drainage area and documented in the Project WQMP. [Appendix III](#) provides instructions for calculating DCV.

2.4.2.3. Evaluating and Selecting BMPs

This section describes a process for developing a comprehensive LID, treatment control, and hydromodification control plan for typical projects.

Select LID BMPs

Figure 2.1 outlines the LID BMP selection process. The first step in the process is to consider HSCs, such as downspout disconnects and other controls described in **Section 4.2**, based on opportunities in the project layout. HSCs can be a cost-effective part of a meeting LID requirements, but are not required to be used if LID requirements can be met in other ways. Some HSCs are also effective at removing pollutants. HSCs that effectively remove pollutants are allowed to have their captured storm water volume count towards the DCV, consequently reducing the size of downstream BMPs. Where claimed, the contribution of HSCs is quantified in terms of inches of the design capture storm depth and the percentage of average annual runoff volume that is reduced. This is deducted from sizing criteria for downstream BMPs as described in [Appendix III](#).

If the volume of runoff retained by HSCs in a DMA is greater than or equal to the design capture storm depth for the DMA, the DMA is considered to be “self-retaining” and no additional BMPs are required to treat discharges from the drainage area to meet LID or treatment control requirements.

If the retained storm water volume of HSCs are accounted for in downstream BMP sizing, then supporting calculations shall be prepared as described in [Appendix III](#). These calculations must be submitted using Worksheet A (see [Appendix XV](#)) or an equivalent format.

The next steps are to select and size either infiltration BMPs or harvest and use BMPs, if feasible, for the remaining runoff from DMAs that are not self-retaining. If it is feasible to use either of these types of LID BMPs to fully retain the DCV from the DMA, then no additional BMPs are required to treat discharges from the drainage area to meet LID requirements. Feasibility criteria are contained in **Section 2.4.2.4** and sizing approaches to manage the entire DCV are described in [Appendix I](#), [Appendix II](#), and [Appendix III](#).

If it is not feasible to fully retain the runoff using either infiltration BMPs or rainwater harvesting, then LID BMPs must be selected to retain the remaining DCV to the maximum extent feasible. Feasibility criteria are contained in **Section 2.4.2.4**. For guidance on designing LID BMPs to retain the maximum feasible portion of the DCV, see [Appendix XI](#).

If it is infeasible to fully retain the DCV on the project site, then biotreatment BMPs must be selected and sized for the remaining DCV, if feasible. Biotreatment BMPs must be selected to address the pollutants of concern and must be designed to achieve the maximum feasible infiltration and ET. [Guidance on selecting biotreatment BMPs to address the pollutants of concern](#) is provided in **Section 2.4.2**. For guidance on designing Biotreatment BMPs to achieve the maximum feasible infiltration and ET, see [Appendix XI](#).

If it is infeasible to fully retain or biotreat the DCV on the project site, then see **Section 2.4.4** below for guidance on Alternative Compliance.

Figure 2.1: LID BMP Selection Flow Chart

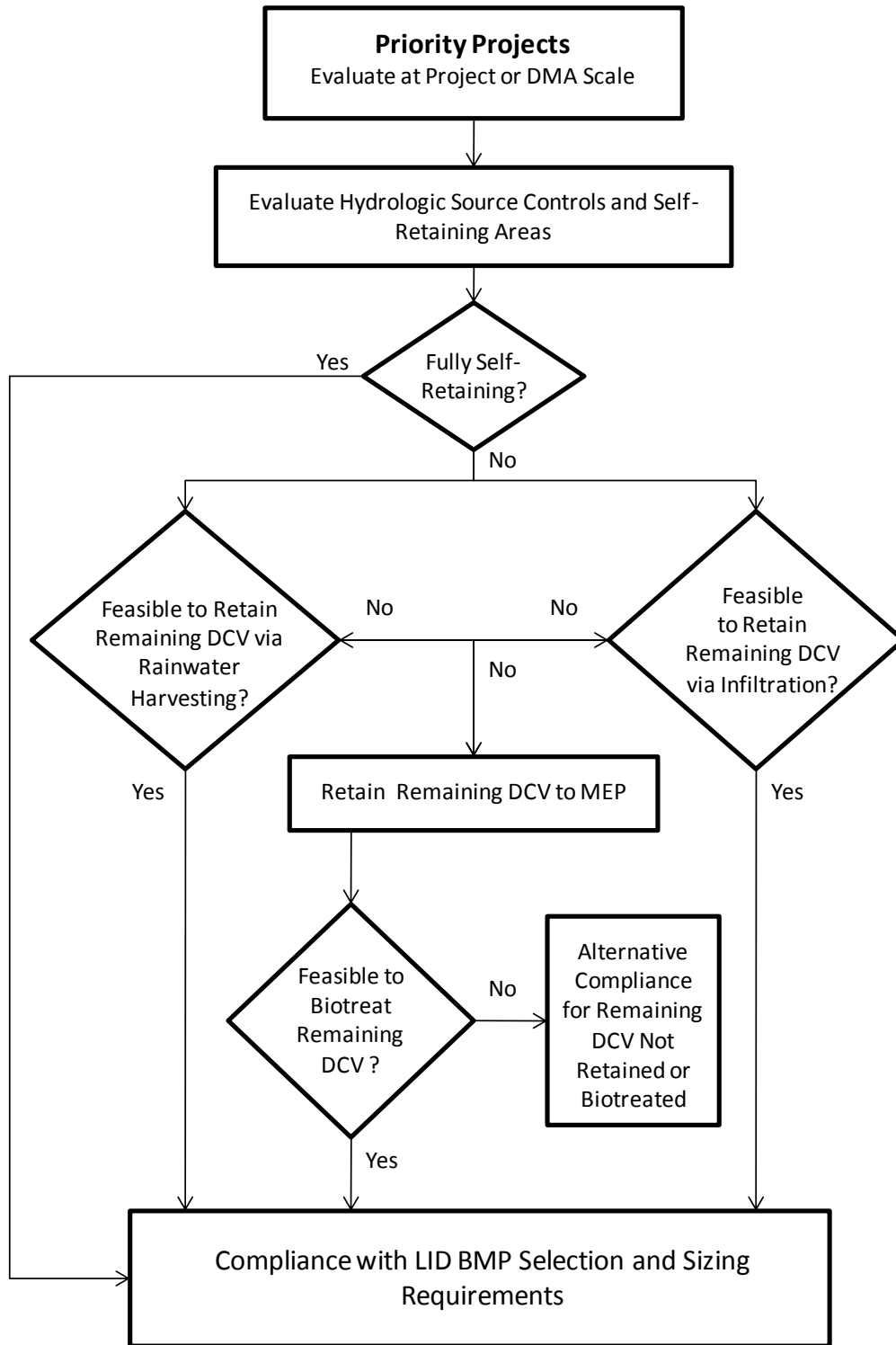

2.4.2.4. LID Infeasibility Criteria

Narrative infeasibility criteria are described in Section 2.4.2 of the [Model WQMP](#).

Conceptually, the infeasibility criteria contained in this TGD are intended to:

- Prevent significant risks to human health and environmental degradation as a result of compliance activities; and
- Describe circumstances under which regional and watershed-based strategies may be selected when they are consistent with the MEP standard considering such factors as technical feasibility, fiscal feasibility, societal concerns, and social benefits; and
- Define performance criteria to ensure that compliance does not result in undue fiscal or societal burdens, including such considerations as:
 - Cost-effectiveness of on-site stormwater management versus off-site stormwater management, including capital costs and maintenance cost and considerations, and
 - Incremental cost-benefit of additional BMPs in stormwater management systems, including capital costs and maintenance costs and considerations.

LID BMP infeasibility criteria are listed below. More specific guidance on determining infiltration infeasibility related to groundwater protection is provided in [Appendix VIII](#). More specific guidance on determining the feasibility of rainwater harvesting is provided in [Appendix X](#).

Infiltration Infeasibility

Stormwater infiltration is infeasible if any of the following conditions apply:

- Seasonally high groundwater or mounded groundwater is less than 5 feet below the designed bottom of the infiltration facility. (See [Appendix VIII](#) for specific guidance.)
- Seasonally high groundwater or mounded groundwater is less than 10 feet below the designed bottom of the infiltration facility and significant treatment is not provided in the BMP before groundwater injection (e.g., infiltration basins, infiltration trenches, dry wells, subsurface vaults, and similar BMPs) and the receiving aquifer supports beneficial uses. (See [Appendix VIII](#) for specific guidance.)
- The infiltration facility is less than 100 feet horizontally from a water supply well, non-potable well, drain field, or spring. (See [Appendix VIII](#) for specific guidance.)
- The BMP tributary area contains high risk land use activities which would result in significant risks to drinking water quality and groundwater quality that cannot be reasonably and technically mitigated through methods such as isolation of sources and/or pre-treatment of runoff to address pollutants of concern prior to infiltration. (See [Appendix VIII](#) for specific guidance)

- For brownfield sites or adjacent sites, where stormwater infiltration would result in a significant risk of mobilizing or moving contamination that cannot be reasonably and technically avoided, as documented by a site-specific or available watershed study. The documenting study shall have sufficient resolution to positively identify areas of the property where unremediated contamination is located and where stormwater infiltration should be restricted to prevent pollutant mobilization. (See [Appendix VIII](#) for specific guidance.)
- Where a groundwater pollutant plume (man-made or natural) is under the site or in close proximity and there is substantial evidence that stormwater infiltration would cause or contributing to plume movement that cannot be reasonably and technically avoided, as documented by a site-specific study or available watershed study. The documenting study shall have sufficient resolution to positively identify areas where stormwater infiltration should be restricted. (See [Appendix VIII](#) for specific guidance))
- Where there is substantial evidence that stormwater infiltration would result in significantly increased risks of geotechnical hazards, such as liquefaction or landslides, that cannot be reasonably and technically mitigated to an acceptable level, as documented in a geotechnical report prepared by the geotechnical expert for the project. Stormwater infiltration in a given location is deemed to result in a significant risk to geotechnical hazards if any of the following conditions apply:
 - The location is less than 50 feet away from slopes steeper than 15 percent
 - The location is less than eight feet from building foundations or an alternative setback established by the geotechnical expert for the project.
 - A study prepared by a geotechnical professional or an available watershed study determines that stormwater infiltration would result in significantly increased risks of geotechnical hazards on or adjacent to the project site that cannot be reasonably and technical mitigated. The documenting study shall have sufficient resolution to positively identify locations on a project site where stormwater infiltration should be restricted.
- Where infiltration of runoff from the project would violate downstream water rights. While it is not anticipated that infiltration of runoff would violate water rights in Orange County, water law in California is complex, and this TGD does not exclude the possibility that a rightful water rights claim could restrict infiltration of stormwater. The [South County Permit](#) contemplates the potential for stormwater management activities to violate water rights at F.3.d.(6)(d).
- Further geotechnical investigations, including infiltration testing, are not required to confirm that a project overlies HSG D soils per regional maps ([Appendix XVI](#)) if available data confirms the presence of soil characteristics which support characterizing the underlying soils as D soils (see [Appendix VII](#)). All priority projects must use all available geotechnical information in order to confirm the presence of HSG D soils. If there is no additional available data, other than regional maps, and the project is not a

“small project” according to Table VII.2. of [Appendix VII](#), then further geotechnical investigation will be required according to [Appendix VII](#). Small projects will not be required to perform further geotechnical investigations even if there is no other available geotechnical information, but these situations are expected to be rare cases. Individual jurisdictions will track these situations and report them in the Annual Progress Report in order to evaluate the effectiveness of the thresholds in Table VII.2([Appendix VII](#)).

- If the *measured infiltration rate* after accounting for soil amendments is less than 0.3 inches per hour in the vicinity of proposed BMPs. Infiltration must be measured using the methods described in [Appendix VII](#), which includes protocols that account for the effect of soil amendments. Soil amendments would not be expected to increase the effective infiltration rate of a soil if the limiting horizon for infiltration lies below the amended zone (in this case, it would increase storage, but not infiltration rate). Soil amendments would be expected to effectively increase infiltration rates if the limiting horizon for infiltration occurs near the proposed bottom of the infiltration basin and the entire depth of this layer can be amended. This criterion shall be evaluated using a factor of safety of 2.0 on testing results.
- If there is substantial evidence that an increase in infiltration over predeveloped conditions would cause impairments to downstream beneficial uses, such as change of seasonality of ephemeral washes or increased discharge of contaminated groundwater to surface waters. The level of allowable increase in infiltration must be documented in a site-specific study or watershed plan, and it must be demonstrated that stand-alone infiltration BMPs would exceed the allowable level of increase in infiltration or what level could be infiltrated as a partial consideration.
- If there is substantial evidence that infiltration from the project would result in increase in inflow and infiltration (I&I) to the sanitary sewer that cannot be sufficiently mitigated, and it is beyond the reasonable scope of the project to rehabilitate the sanitary sewer to mitigate for I&I. It is anticipated that maps will be made available to identify areas of the sanitary sewer system where high I&I has been observed, however these maps shall be used for reference purposes only. See [Appendix XVII](#) for a general countrywide map of areas susceptible to high I&I. This map should be used for reference purposes, as more up-to-date maps should be available through the local sewer agency. The most up-to-date maps must be used when they become available. Infiltration activities that have the potential to contribute to a significant increase in I&I should be coordinated with the local sewer agency to ensure project drainage plans are protective of sewer hydraulic capacity. See [Appendix XVII](#) for screening criteria to identify projects that should consult with the local sewerage agency. It is recommended that coordination be initiated as early as possible during the Preliminary/Conceptual WQMP development process as part of the CEQA process (preferred) or otherwise.

In the event that any of these conditions apply, infiltration BMPs are not required to be implemented. Infiltration feasibility screening shall be documented using [Table 2.7](#).

Table 2.7: Infiltration BMP Feasibility Worksheet

	Infeasibility Criteria	Yes	No
1	<p>Would Infiltration BMPs pose significant risk for groundwater related concerns? Refer to Appendix VIII (Worksheet I) for guidance on groundwater-related infiltration feasibility criteria.</p>		
<p>Provide basis:</p> <p>Summarize findings of studies provide reference to studies, calculations, maps, data sources, etc. Provide narrative discussion of study/data source applicability.</p>			
2	<p>Would Infiltration BMPs pose significant risk of increasing risk of geotechnical hazards that cannot be mitigated to an acceptable level? (Yes if the answer to any of the following questions is yes, as established by a geotechnical expert):</p> <ul style="list-style-type: none"> • The BMP can only be located less than 50 feet away from slopes steeper than 15 percent • The BMP can only be located less than eight feet from building foundations or an alternative setback. • A study prepared by a geotechnical professional or an available watershed study substantiates that stormwater infiltration would potentially result in significantly increased risks of geotechnical hazards that cannot be mitigated to an acceptable level. 		
<p>Provide basis:</p> <p>Summarize findings of studies provide reference to studies, calculations, maps, data sources, etc. Provide narrative discussion of study/data source applicability.</p>			
3	<p>Would infiltration of the DCV from drainage area violate downstream water rights?</p>		
<p>Provide basis:</p> <p>Summarize findings of studies provide reference to studies, calculations, maps, data sources, etc. Provide narrative discussion of study/data source applicability.</p>			

Table 2.7: Infiltration BMP Feasibility Worksheet (continued)

	<i>Partial Infeasibility Criteria</i>	Yes	No
4	Is proposed infiltration facility located on HSG D soils or the site geotechnical investigation identifies presence of soil characteristics which support categorization as D soils?		
Provide basis:			
Summarize findings of studies provide reference to studies, calculations, maps, data sources, etc. Provide narrative discussion of study/data source applicability.			
5	Is measured infiltration rate below proposed facility less than 0.3 inches per hour? This calculation shall be based on the methods described in Appendix VII .		
Provide basis:			
Summarize findings of studies provide reference to studies, calculations, maps, data sources, etc. Provide narrative discussion of study/data source applicability.			
6	Would reduction of over predeveloped conditions cause impairments to downstream beneficial uses, such as change of seasonality of ephemeral washes or increased discharge of contaminated groundwater to surface waters?		
Provide citation to applicable study and summarize findings relative to the amount of infiltration that is permissible:			
Summarize findings of studies provide reference to studies, calculations, maps, data sources, etc. Provide narrative discussion of study/data source applicability.			
7	Would an increase in infiltration over predeveloped conditions cause impairments to downstream beneficial uses, such as change of seasonality of ephemeral washes or increased discharge of contaminated groundwater to surface waters?		
Provide citation to applicable study and summarize findings relative to the amount of infiltration that is permissible:			
Summarize findings of studies provide reference to studies, calculations, maps, data sources, etc. Provide narrative discussion of study/data source applicability.			

Table 2.7: Infiltration BMP Feasibility Worksheet (continued)

Infiltration Screening Results (check box corresponding to result):		
8	<p>Is there substantial evidence that infiltration from the project would result in a significant increase in I&I to the sanitary sewer that cannot be sufficiently mitigated? (See Appendix XVII)</p> <p>Provide narrative discussion and supporting evidence:</p> <p>Summarize findings of studies provide reference to studies, calculations, maps, data sources, etc. Provide narrative discussion of study/data source applicability.</p>	
9	<p>If any answer from row 1-3 is yes: infiltration of any volume is not feasible within the DMA or equivalent.</p> <p>Provide basis:</p> <p>Summarize findings of infeasibility screening</p>	
10	<p>If any answer from row 4-7 is yes, infiltration is permissible but is not presumed to be feasible for the entire DCV. Criteria for designing biotreatment BMPs to achieve the maximum feasible infiltration and ET shall apply.</p> <p>Provide basis:</p> <p>Summarize findings of infeasibility screening</p>	
11	<p>If all answers to rows 1 through 11 are no, infiltration of the full DCV is potentially feasible, BMPs must be designed to infiltrate the full DCV to the maximum extent practicable.</p>	

Harvest and Use Infeasibility

Harvest and use infeasibility criteria include:

- If inadequate demand exists for the use of the harvested rainwater. See [Appendix X](#) for guidance on determining harvested water demand and applicable feasibility thresholds.
- If the use of harvested water for the type of demand on the project violates codes or ordinances most applicable to stormwater harvesting in effect at the time of project application and a waiver of these codes and/or ordinances cannot be obtained. It is noted that codes and ordinances most applicable to stormwater harvesting may change

with time, and this TGD does not intend to restrict harvest and use BMPs to the codes and ordinances in effect at its date of publication.

- If harvest and use of runoff would violate downstream water rights. While it is not anticipated that harvest and use of runoff would violate water rights in Orange County, water law in California is complex, and this TGD does not exclude the possibility that a rightful water rights claim could restrict harvest and use of stormwater. The [South County Permit](#) contemplates the potential for stormwater management activities to violate water rights at F.3.d.(6)(d). Water rights could potentially be violated by reduction in infiltrated volume or reduction of surface runoff.

If harvest and use BMPs are used, they shall comply with Orange County Sanitation District Wastewater Discharge Regulations, where applicable. The Orange County Department of Health and Orange County Health Care Agency should be involved in this process, as applicable, at the discretion of project engineer and plan reviewer, to ensure that harvest and use systems do not pose a significant risk to human health. Considerations relative to harvest and use systems and public health are anticipated to be project-specific, and specific guidance is not provided in this TGD at this time.

Designing BMPs to Achieve Maximum Feasible Evapotranspiration

ET is a significant volume reduction process in HSCs, infiltration BMPs exposed to atmosphere, and biotreatment BMPs. BMPs must be designed to achieve the maximum feasible ET, where required to demonstrate that the maximum amount of water has been retained on-site. This should be done as follows:

- Per [Appendix XI](#), if a project cannot be designed to infiltrate and/or harvest and use the full DCV, the following criteria must be met before evaluating biotreatment BMPs:
 - All applicable HSCs, such as downspout disconnects and other HSCs described in [Section 4.2](#), must be considered (ET is a principal process in all HSCs)
 - The project must demonstrate that at least minimum site design practices for available open space have been met (ET is strongly a function of available ET area)
- Biotreatment BMPs, if needed to address remaining unmet volume, must be designed to achieve the maximum feasible infiltration and ET per criteria contained in [Appendix XI](#) and [Appendix XII](#).

Conformance with these criteria is presumed to result in a suite of BMPs that achieves the maximum feasible ET under conditions where it is necessary to provide the maximum feasible ET to meet LID performance criteria.

Incorporation of Feasibility Findings from Watershed-Based Plans into BMP Selection

The scope of watershed-based planning efforts, such as WHIMPs, may include the assessment of watershed-scale water quality, groundwater recharge, hydromodification, and habitat

considerations to determine the feasibility of on-site LID versus subregional/regional LID approaches. Section 2.4.2.2 of the [Model WQMP](#) describes the conditions under which a watershed-based plan could contain an embedded assessment of feasibility and describe preferred approaches for the project. Section 2.4.2.2 of the [Model WQMP](#) also describes the applicability of watershed-based plans to the selection of BMPs for a project.

2.4.2.5. Selecting Biotreatment and Treatment Control BMPs to Address Pollutants of Concern

BMPs must be selected to address pollutants of concern. Retention BMPs are assumed to address all pollutants of concern. In cases where biotreatment and/or treatment controls are used, these BMPs must be selected to address pollutants of concern based on the following stepwise method:

1. Identify pollutants of concern and primary pollutants of concern based on methods described in **Section 2.3.3**.
2. Based on the BMP performance information provided in **Section 4.9**, select a BMP that provides medium or high effectiveness for all pollutants of concern.
3. If a single BMP does not provide medium or high effectiveness for all pollutants of concern, select a BMP that provides medium or high effectiveness for all primary pollutants of concern.
4. If a single BMP does not provide medium or high effectiveness for all primary pollutants of concern, select multiple BMPs for use in a treatment train that collectively provides medium or high effectiveness for all primary pollutants of concern.

2.4.2.6. Meet Remaining Hydromodification Control Requirements through Additional On-site or Off-site Controls

In many cases, LID BMPs provide full or partial compliance with hydromodification requirements. All retention BMPs provide volume reduction to fully or partially satisfy the volume matching criteria applicable to projects in the NOC permit area. In addition, both retention and biotreatment BMPs can provide flow control benefits to fully or partially satisfy hydromodification requirements applicable in the NOC and SOC permit areas.

In general, once the LID BMPs have been selected and sized, the BMP plan can be assessed for compliance with the hydromodification control requirements. Remaining hydromodification control requirements are determined and calculated as described in **Section 5.3** and [Appendix IV](#), respectively (North Orange County) and **Section 5.4** and [Appendix V](#) (South Orange County). This general approach is intended to organize the process in a linear way, however it is not intended to imply that LID requirements must be considered before hydromodification in all cases. In many cases, it is necessary to select BMPs for LID and hydromodification control should be done concurrently.

The recommended project planning approach for addressing hydromodification requirements depends on the relative magnitude of hydromodification requirements compared to LID

requirements; if the volume of water that needs to be reduced to address hydromodification requirements is greater than the treatment volume for LID requirements, then hydromodification controls may satisfy both requirements and vice versa. Relative magnitudes are a function of the applicable Permit, the susceptibility of receiving waters, and the existing condition of the project. [Appendices I](#) (NOC) and [Appendix II](#) (SOC) provide guidance for integrated BMP sizing strategies where cases LID and hydromodification requirements control the BMP design process.

2.4.3. Project Conformance Analysis

The purpose of this section is to provide technical guidance for how a typical project would demonstrate conformance with project performance criteria.

2.4.3.1. Minimum Requirements for Conformance Analysis

Conceptual/Preliminary and Project WQMPs shall demonstrate conformance with all applicable standards. The WQMP shall list the performance criteria that are applicable to the project, the design requirements that result from these standards, where applicable, and the project design features that are proposed to address these design requirements. A comparison between the design requirements and the proposed project design features is the basis for demonstrating conformance.

The Project WQMP must document conformance with all standards that are applicable to the project on an individual standard basis and at the scale that the standard applies (e.g., project-based, or drainage area-based). The following sections provide guidance for how to demonstrate that the project conforms with each standard.

2.4.3.2. Source Controls

Source controls requirements pertain the structural and non-structural source controls that are intended to minimize the introduction of pollutants in to stormwater runoff. The project WQMP must demonstrate that all applicable pollutant source controls are used. Project conformance with pollutant source control requirements should be demonstrated by identifying the source controls that are applicable to the project and by using the checklist provided in the Section IV of the WQMP Template, or equivalent, to document the Project commitment to utilize these source controls. Where a source control is not applicable, this should be noted with a brief rationale. Conformance with source control obligations must be demonstrated at the project or planning area scale.

[Section 6](#) of this TGD provides a description of source control measures to assist in determining whether source controls are applicable based on project land uses and land use activities. [Section 6.2](#) and [Section 6.3](#) are applicable primarily to private development projects, while [Section 6.4](#) is applicable primarily to municipal projects.

2.4.3.3. Hydrologic Source Controls

There are no numeric standards requiring the use of HSCs. Therefore, for projects that fully conform to LID sizing requirements and fully address HCOCs, the use of HSCs is optional.

However, if a projects cannot feasibility meet LID sizing requirements or cannot fully address HCOCs, all applicable HSCs must be considered as part of demonstrating that the BMP system has been designed to retain the maximum feasible portion of the DCV. Under these cases, the Project WQMP must demonstrate conformance with the requirement to select and use all applicable HSCs. This conformance analysis generally must take the following form, or equivalent methods of documenting that the requirements of the Model WQMP are met:

- Conformance should be demonstrated for each drainage area within the project
- Using the checklist of HSCs contained in Section IV of the WQMP Template, or equivalent, note all HSCs that have been provided for the drainage area.
- For HSCs that have not been provided, provide rationale for why they are not applicable or mutually exclusive with another more effective BMP.
- Using Worksheet A in [Appendix XV](#), the effect of HSCs should be accounted in tabulating overall system performance. The use of HSCs results in smaller design volumes for downstream BMPs. [Appendix III](#) provides guidance accounting for the benefits of HSCs.

2.4.3.4. LID BMPs (Retention and Biotreatment)

LID BMPs must be selected based on a hierarchy of controls and sized to capture the maximum feasible portion of the DCV using with the higher priority type control (e.g., retention), before attempting to address the remaining volume with the next lower priority control (biotreatment).

Therefore, to demonstrate conformance with performance criteria for LID BMPs, the Project WQMP must demonstrate that BMPs have been selected according to the hierarchy of controls, and have been designed to achieve the maximum feasible retention of the DCV before biotreatment can be used (see Figure 2.1). When biotreatment is used after retention has been used to the MEP, it must be demonstrated that the maximum feasible retention plus biotreatment has been achieved before considering an alternative compliance program. In all cases where biotreatment is used as part of compliance with LID criteria, biotreatment BMPs shall be designed to achieve the maximum feasible level of infiltration and ET and achieve the minimum feasible discharge to the MS4 by meeting the criteria contained in [Appendix XI.3](#) and [Appendix XII](#). Satisfaction of these criteria shall be documented in the Project WQMP.

Demonstrating conformance with LID BMP selection and sizing requirements can follow a large number of different paths. The following general scenarios will encompass many projects. Guidance is provided for documenting conformance for these general scenarios.

Scenario 1: The project is able to feasibly retain the DCV. The Project WQMP should demonstrate conformance with the Model WQMP in the following stepwise manner:

1. ***Demonstrate conformance at the drainage area scale.*** Conformance should be demonstrated for each drainage area within the project.
2. ***Demonstrate that the selected BMPs are retention-based LID BMPs.*** Using the checklist of Infiltration and Harvest and Use BMPs contained in Section IV of the WQMP Template, or equivalent, identify the LID BMP(s) that have been selected for the drainage area.
3. ***Demonstrate the selected BMPs are feasible.*** Document the feasibility of the selected BMPs by comparing to [infeasibility screening factors](#) to site conditions and providing supporting information, as applicable. This screening should be documented using [Table 2.7](#), or equivalent.
4. ***Demonstrate that the selected BMPs retain the DCV for each drainage area.*** Calculate and document the required BMP sizes to retain the DCV based on guidance provided in [Appendices I](#) (NOC), [Appendix II](#) (SOC), and [Appendix III](#), by reference from the applicable BMP Fact Sheet(s) ([Appendix XIV](#)). Using tabular summaries and reference to the Drainage Map (WQMP Template Section VI) demonstrate that the provided retention volume in the BMPs in the drainage area meets or exceeds the required DCV.

Project WQMP must include the necessary content to document these items by providing a completed checklist, worksheets, tables, and narrative discussion, and other relevant forms of documentation.

Scenario 2: The project cannot feasibly retain the full DCV, but biotreatment BMPs can be used to treat all or a portion of the remaining volume. The Project WQMP should demonstrate conformance with the Model WQMP in the following stepwise manner:

1. ***Demonstrate conformance at the drainage area scale.*** Conformance should be demonstrated for each drainage area within the project.
2. ***Demonstrate that the selected retention BMP are LID BMPs.*** Using the checklist of Infiltration and Harvest and Use BMPs contained in Section IV of the WQMP Template, or equivalent, identify the LID BMP(s) that have been selected and provided for the drainage area.
3. ***Demonstrate that the selected retention BMPs are the most likely to be feasible.*** Provide a narrative description of why the selected BMPs were chosen and why they are the most likely to be technically feasible for the drainage area. For BMPs that were not selected, indicate why.
4. ***Demonstrate the selected BMPs are feasible.*** Document the feasibility of the selected BMPs by comparing to [infeasibility screening factors](#) and providing supporting information, as applicable. This screening must be documented in [Table 2.7](#), or equivalent.
5. ***Demonstrate that retention BMPs have been provided to the MEP.*** Based on comparison to the criteria for designing BMPs to achieve the maximum feasible retention volume ([Appendix XI](#)), demonstrate that the sizing provided for retention BMPs meets minimum criteria contained in [Appendix XI](#).
6. ***Demonstrate that the selected BMPs retain plus biotreat the DCV from the drainage area.*** Using the BMP sizing guidance provided in [Appendices I](#) (NOC), [Appendix II](#) (SOC), and [Appendix III](#), by reference from the applicable BMP Fact Sheet(s)

([Appendix XIV](#)), calculate the remaining volume to be biotreated. Using tabular summaries and reference to the Drainage Map (WQMP Template Section VI) demonstrate that the provided retention and biotreatment volumes meet or exceeds the required retention and biotreatment volumes.

Project WQMP must included the necessary content to document these items by providing a completed checklists, worksheets, tables, and narrative discussion, and other relevant forms of documentation.

Scenario 3: The project cannot feasibly retain the full DCV and cannot feasibly biotreat the remaining volume. The Project WQMP should demonstrate conformance with the Model WQMP in the following stepwise manner:

1. *Demonstrate conformance at the drainage area scale.* Infeasibility of on-site retention should be demonstrated for each drainage area within the project.
2. *Demonstrate that the selected retention BMP are LID BMPs.* Using the checklist of Infiltration and Harvest and Use BMPs contained in Section IV of the WQMP Template, or equivalent, identify the LID BMP(s) that have been selected and provided for the drainage area.
3. *Demonstrate that the selected retention BMPs are the most likely to be feasible.* Provide a narrative description of why the selected BMPs were chosen and why they are the most likely to be technically feasible for the drainage area. For BMPs that were not selected, indicate why.
4. *Demonstrate the selected BMPs are feasible.* Document the feasibility of the selected BMPs by comparing to [infeasibility screening factors](#) and providing supporting information, as applicable. This screening must be documented using [Table 2.7](#), or equivalent.
5. *Demonstrate that retention plus biotreatment has been provided to the MEP.* Based on comparison to the criteria for designing BMPs to achieve the maximum feasible retention plus biotreatment of the DCV ([Appendix XI](#)), demonstrate that the sizing provided for retention and biotreatment BMPs meets minimum criteria. Use tabular summaries and reference to the Drainage Map (WQMP Template Section VI) demonstrate that the provided retention and biotreatment volumes meet or exceeds the maximum feasible volume pursuant to the criteria in [Appendix XI](#).
6. *Report the remaining unmet volume to be addressed by alternative compliance.* This should be calculated as the difference between the DCV and the provided volume.

Project WQMP must included the necessary content to document these items by providing a completed checklists, worksheets, tables, and narrative discussion, and other relevant forms of documentation.

Scenario 4: The project cannot feasibly retain the entire DCV because there are not any feasible retention BMPs. The Project WQMP should demonstrate conformance with the Model WQMP in the following stepwise manner:

1. *Demonstrate conformance at the drainage area scale.* Conformance should be demonstrated for each drainage area within the project.

2. ***Demonstrate that no retention BMP are feasible.*** Using the checklist of Infiltration and Harvest and Use BMPs contained in Section IV of the WQMP Template, or equivalent, identify why each of the BMPs is not feasible for the entire DCV. Document the infeasibility of fully retaining the DCV by comparing site and project characteristics to [infeasibility screening factors](#) and providing supporting information, as applicable. This screening should be documenting in [Table 2.7](#), or equivalent.
3. ***Demonstrate the selected biotreatment BMPs capture the entire DCV from the drainage area.*** Using the BMP sizing guidance provided in [Appendices I](#) (NOC), [Appendix II](#) (SOC), and [Appendix III](#), by reference from the applicable BMP Fact Sheet(s) ([Appendix XIV](#)), calculate the sizing requirements for biotreatment BMPs. Using tabular summaries and reference to the Drainage Map (WQMP Template Section VI) demonstrate that the provided biotreatment volume meets or exceeds the required biotreatment volume.
4. ***Demonstrate that biotreatment BMPs are designed to achieve the maximum feasible infiltration and ET.*** Demonstrate via narrative discussion and comparison to criteria contained in [Appendix XI](#) and [Appendix XII](#), that the biotreatment BMPs have been designed with design elements that will achieve the maximum feasible infiltration and ET. If incidental infiltration would cause a significant documented hazard, then demonstrate why biotreatment BMPs restrict infiltration by comparing site and project characteristics to [infeasibility screening factors](#).

Project WQMP must included the necessary content to document these items by providing a completed checklists, worksheets, tables, and narrative discussion, and other relevant forms of documentation.

2.4.3.5. Documenting Partial Retention and Biotreatment to the MEP

In cases where retention BMPs are technically feasible but are constrained by site conditions such that it is only feasible to retain a portion of the DCV, it is necessary to demonstrate that the partial level of retention and/or biotreatment is consistent with the MEP standard. [Appendix XI](#) provides minimum criteria that must be met to demonstrate that BMPs have been designed to achieve the maximum feasible retention or retention plus biotreatment of the DCV. Conformance should be demonstrated based on a comparison of the BMP design parameters and drainage area characteristics to the minimum criteria contained in [Appendix XI](#).

2.4.3.6. Demonstrating Primary Conformance using Regional BMP Systems

Regional systems meeting specific criteria can be used as a primary path for compliance with LID and treatment control criteria for projects that participate in these projects. Section 2.4.2.2 of the [Model WQMP](#) describes the applicability of watershed-based plans to the selection of BMPs for a project. To demonstrate conformance with LID and treatment control criteria via this pathway, the Project WQMP should cite and/or attach the applicable watershed-based planning documentation to the Project WQMP that documents that the criteria described in Section 2.4.2.2 of the [Model WQMP](#) are met.

2.4.3.7. Determining Remaining Treatment Control Sizing Requirements.

If retention and biotreatment BMPs are provided to fully capture the DCV, then conformance with treatment controls sizing requirements is inherently achieved. It is sufficient to note this equivalency in the Project WQMP as the means to demonstrate conformance.

In cases where an unmet volume remains following the application of retention and biotreatment BMPs, treatment control BMPs must be used to address pollutants of concern for the remaining unmet volume. The conformance analysis for treatment control BMPs should include:

- *Demonstrate that treatment control BMPs address pollutants of concern.* Documentation that BMPs have been selected to address the pollutants of concern per instructions contained in **Section 2.4.2.5**.
- *Demonstrate that treatment controls address the remaining volume.* First, calculate the remaining unmet volume. The approved methods contained in [Appendix VI](#) should be used, with documentation provided in the form of tables and worksheets. Compare the unmet volume with the provided volume or flowrate of treatment control BMPs. [Appendix VI](#) describes the methodology for converting remaining volume to remaining flowrate as necessary. Demonstrate that the treatment control BMPs meet or exceed treatment for the unmet volume or flowrate.

2.4.3.8. Demonstrating Conformance with Hydromodification Control Criteria

Hydromodification control criteria are expressed in terms of hydrologic conditions that must be met do demonstrate that HCOCs do not exist. Therefore the Project WQMP conformance analysis for hydromodification must demonstrate that these conditions are addressed. The Project WQMP must demonstrate that HCOCs do not exist through an evaluation of receiving channel susceptibility and/or hydrologic calculations in comparison to permit definitions of HCOCs. This demonstration will depend on receiving water susceptibility, site characteristics, project characteristics, and permit region.

[Section 5](#) and [Appendix I](#) (NOC) and [Appendix II](#) (SOC) provide references for sizing and design of hydromodification controls to address HCOCs. [Appendix IV](#) (NOC) and [Appendix V](#) (SOC) describe the approved hydrologic calculation methods for quantifying HCOCs.

2.4.4. Alternative Compliance Plan

Alternative compliance plan requirements are described in Section 3.0 of the [Model WQMP](#). Guidance on technical calculations for determining alternative compliance requirements are provided in [Appendix VI](#).

This Section IV of the Project WQMP should include all applicable alternative compliance-related calculations, as applicable.

2.5. Inspection/Maintenance Responsibility for BMPs

Requirements for inspection and maintenance of the selected BMPs are provided in Section 4.0 of the [Model WQMP](#). Specific guidance for operations and maintenance planning are contained in [Section 7](#) of this TGD.

2.6. Site Plan and Drainage Plan

2.6.1. Site Plan and Drainage Plan Sheet Set

Attach the following figures to the Project WQMP:

- 1) Project location map that shows and identifies the immediate downstream receiving water(s) of the project and any 303(d) listed or TMDL water bodies further downstream.
- 2) Project site plan that identifies land uses / activities.
- 3) Project site plan that identifies infiltration infeasibility criteria (if applicable), including surficial soil properties, depth to groundwater, and geotechnical hazards.
- 4) Drainage plan that delineates each drainage management area, shows all stormwater management infrastructure and storm drains, and identifies the selected BMP type(s).
- 5) BMP details for all structural BMPs (only applicable for Project WQMPs and Conceptual/Preliminary BMPs where the level of design detail warrants the inclusion of BMP details).

2.6.2. Electronic Data Submittal.

This section is reserved for future guidance.

2.7. Incorporating USEPA Green Streets Guidance to the MEP

This section provides guidance for preparation of a Project WQMP that incorporates USEPA [Managing Wet Weather with Green Infrastructure: Green Streets](#) in a manner consistent with the MEP standard. This section is applicable only as described in Section 2.4.2.1 of the [Model WQMP](#); applicable projects are referred to in this section as “applicable Green Streets projects.” A copy of the USEPA Green Streets Guidance is included as Appendix B of the [Model WQMP](#).

2.7.1. Site Assessment Considerations for Applicable Green Streets Projects

Site assessment for applicable Green Streets projects includes many of the same considerations as described in [Section 2.3.2](#). In addition to those elements described in [Section 2.3.2](#), specific elements which should be given special consideration in the site assessment process for applicable Green Streets include:

- **Ownership of land adjacent to right of ways.** The opportunity to provide stormwater treatment may depend on the ownership of land adjacent to the right-of-way. Acquisition of additional right-of-way and/or access easements may be more feasible if land bordering the project is owned by relatively few land owners.

- **Location of existing utilities.** The location of existing storm drainage utilities can influence the opportunities for Green Streets infrastructure. For example, stormwater planters can be designed to overflow along the curb-line to an existing storm drain inlet, thereby avoiding the infrastructure costs associated with an additional inlet. The location of other utilities will influence the ability plumb BMPs to storm drains, therefore, may limit the allowable placement of BMPs to only those areas where a clear pathway to the storm drain exists.
- **Grade differential between road surface and storm drain system.** Some BMPs require more head from inlet to outlet than others; therefore, allowable head drop may be an important consideration in BMP selection. Storm drain elevations may be constrained by a variety of factors in a roadway project (utility crossings, outfall elevations, etc.) that cannot be overcome and may override stormwater management considerations.
- **Longitudinal slope.** The suite of LID BMPs which may be installed on steeper road sections is more limited. Specifically, permeable pavement and swales are more suitable for gentle grades. Other BMPs may be more readily terraced to be used on steeper slopes.
- **Potential access opportunities.** A significant concern with installation of BMPs in major right of ways is the ability to safely access the BMPs for maintenance considering traffic hazards. The site assessment should identify vehicle travel lanes and areas of specific safety hazards for maintenance crews and subsequent steps of the Project WQMP preparation process should attempt avoid placing BMPs in these areas.

Infiltration may be considered for applicable Green Streets projects provided that **infeasibility screening criteria** are observed, with specific attention to protection of groundwater quality as discussed in [Appendix VIII](#) and the structural integrity of adjacent road bed.

POCs and HCOCs should be determined as described in [Sections 2.2](#) and [2.3](#), respectively.

2.7.2. BMP Selection and Site Design for Applicable Green Streets Projects

The fundamental tenants of the approach described by the USEPA Green Streets guidance include:

- Selecting LID BMPs to the opportunities of the site and to attempt to address pollutants of concern and HCOCs,
- Developing innovative stormwater management configurations integrating “green” with “grey” infrastructure,
- Sizing BMPs opportunistically to provide stormwater pollution reduction to the MEP, accounting for the many competing considerations in right of ways.

Applicable Green Streets projects should apply the following LID site design measures to the MEP and as specified in the local permitting agency's codes:

- Minimize street width to the appropriate minimum width for maintaining traffic flow and public safety.
- Add tree canopy by planting or preserving trees/shrubs.

- Use porous pavement or pavers for low traffic roadways, on-street parking, shoulders or sidewalks.
- Integrate traffic calming measures in the form of bioretention curb extensions.

Applicable Green Streets projects should select BMPs consistent with the Green Streets guidance. [Table 2.8](#) provides an inventory of LID BMPs which may be appropriate for applicable Green Streets projects. The performance criteria for applicable Green Streets projects do not require retention BMPs to be considered to the MEP before considering biotreatment and treatment control BMPs. A formal process of BMP prioritization and selection is not required for applicable Green Streets projects, however [infiltration infeasibility criteria](#) still apply; only feasible BMPs may be selected.

BMPs should be prioritized based on a comparison of drainage area characteristics to the opportunity criteria listed in [Table 2.8](#). The USEPA Green Streets guidance describes how some of these BMPs may be used in combination to achieve optimal benefits in runoff reduction and water quality improvement. Specific examples and applications for residential streets, commercial streets, arterials streets, and alleys are provided in the USEPA guidance.

The drainage patterns of the project should be developed so that drainage can be routed to areas with BMP opportunities before entering storm drains. For example, if a median strip is present, a reverse crown should be considered, where allowed, so that stormwater can drain to a median swale. Likewise, standard peak-flow curb inlets should be located downstream of areas with potential for stormwater planters so that water can first flow into the planter, and then overflow to the downstream inlet if capacity of the planter is exceeded. It is more difficult to apply green infrastructure after water has entered the storm drain.

Conceptual drainage plans for redevelopment projects should identify tributary areas outside of the project site generates runoff that comingles with on-site runoff. The project is not required to treat off-site runoff; however treatment of comingled off-site runoff may be used to off-set the inability to treat areas within the project for which significant constraints prevent the ability to provide treatment.

Table 2.8: Potential BMPs for Applicable Green Streets Projects

BMP Type	Opportunity Criteria for Applicable Green Streets Projects
Street Trees, Canopy Interception	<ul style="list-style-type: none"> • Access roads, residential streets, local roads and minor arterials • Drainage infrastructure, sea walls/break waters • Effective for projects with any slope • Trees may be prohibited along high speed roads for safety reasons or must be setback behind the clear zone or protected with guard rails and barriers
Stormwater Curb Extensions / Stormwater Planters	<ul style="list-style-type: none"> • Access roads, residential streets, and local roads with parallel or angle parking and sidewalks • Can be designed to overflow back to curblines and to standard inlets • Shape is not important and can be integrated wherever unused space exists • Can be installed on relatively steep grades with terracing
Bioretention Areas	<ul style="list-style-type: none"> • Low density residential streets without sidewalks • Requires more space than curb extensions/ planters, most feasibly implemented in combination with minimized road widths

Table 2.8: Potential BMPs for Applicable Green Streets Projects

BMP Type	Opportunity Criteria for Applicable Green Streets Projects
Permeable Pavement	<ul style="list-style-type: none"> • Parking and sidewalk areas of residential streets, and local roads • Should not receive significant run-on from major roads • Should not be subject to heavy truck/ equipment traffic • Light vehicle access roads
Permeable Friction Course Overlays	<ul style="list-style-type: none"> • High speed roadways unsuitable for full depth permeable pavement • Suitable for parking lots and all roadway types
Vegetated Swales (compost amended were possible)	<ul style="list-style-type: none"> • Roadways with low to moderate slope • Residential streets with minimal driveway access • Minor to major arterials with medians or mandatory sidewalk set- • Access roads • Swales running parallel to storm drain can have intermittent discharge points to reduce required flow capacity
Filter strips (amended road shoulder)	<ul style="list-style-type: none"> • Access roads • Major roadways with excess ROW • Not practicable in most ROWs because of excessive width requirements
Proprietary Biotreatment	<ul style="list-style-type: none"> • Constrained ROWs • Typically have small footprint to tributary area ratio • Simple install and maintenance • Can be installed on roadways of any slope • Can be designed to overflow back to curb line and to standard inlet
Infiltration Trench	<ul style="list-style-type: none"> • Constrained ROWs • Can require small footprint where soils are suitable • Low to moderate traffic roadways • Infiltration trenches are not suitable for high traffic roadways • Requires robust pretreatment
Cartridge Media Filters	<ul style="list-style-type: none"> • Highly constrained ROW with little available surface area • Installed in underground vaults, manholes, or catch basins • Require minimum available head loss • Simple installation and maintenance
WSDOT Media Filter Drains	<ul style="list-style-type: none"> • See : http://www.ecy.wa.gov/programs/wq/stormwater/newtech/use_designations/091022EcologyEmbankmentGULD.pdf

2.7.3. BMP Sizing for Applicable Green Streets Projects

The following steps are used to size BMPs for applicable Green Streets projects:

1. Delineate drainage areas tributary to BMP locations and compute imperviousness.
2. Look up the recommended sizing method for the BMP selected in each drainage area and using the respective BMP Fact Sheets ([Appendix XIV](#)) calculate target sizing criteria.
3. Design BMPs per the guidance provided in the BMP Fact Sheets ([Appendix XIV](#)).
4. Attempt to provide the calculated sizing criteria for the selected BMPs.
5. If sizing criteria cannot be achieved, document the constraints that override the application of BMPs, and provide the largest portion of the sizing criteria that can be reasonably provided given constraints.

If BMPs cannot be sized to provide the calculated volume for the tributary area, it is still essential to design the BMP inlet, energy dissipation, and overflow capacity for the full tributary area to ensure that flooding and scour is avoided. It is strongly recommended that BMPs which are designed to less than their target design volume be designed to bypass peak flows.

2.7.4. Alternative Compliance Options for Applicable Green Streets Projects

Applicable Green Streets projects are not required to meet alternative compliance options if stormwater management controls described in this section, or equivalent, are installed in a manner consistent with the MEP standard.

Alternative compliance programs should be considered for applicable Green Streets projects if on-site green infrastructure approaches cannot practicably treat the design volume. The primary alternative compliance option for applicable Green Streets projects is the completion of off-site mitigation projects. The proponent would implement a project to reduce stormwater pollution for other portions of roadway or similar land uses to the project in the same hydrologic unit, ideally as close to the project as possible and discharging to the same outfall.

SECTION 3. SITE DESIGN PRINCIPLES AND TECHNIQUES

3.1. Introduction

This section focuses on LID site design practices; LID BMPs are discussed in [Section 4](#).

The primary objective of site design principles and techniques is to reduce the hydrologic and water quality impacts associated with land development. The benefits derived from this approach include:

- Reduced size of downstream BMPs and conveyance systems;
- Reduced pollutant loading; and
- Reduced hydromodification impacts to receiving streams.

Site Design Principles and Techniques include the following design features and considerations:

- Site planning and layout;
- Vegetative protection, revegetation, and maintenance;
- Slopes and channel buffers;
- Techniques to minimize land disturbance;
- LID BMPs at scales from single parcels to watershed; and
- Integrated Water Resource Management Practices.

Detailed descriptions for each of these Site Design Principles and Techniques are presented in the following sections.

3.2. Site Planning and Layout

3.2.1. Minimize Impervious Area

One of the principal causes of the environmental impacts of development is the creation of impervious surfaces. Impervious cover can be minimized through identification of the smallest possible land area that can be practically impacted or disturbed during site development. Below is a partial list of techniques that can reduce the amount of impervious area that will be created as part of a project. It is important to note that local land use ordinances and building codes may dictate minimum requirements for road widths, building setbacks and accessibility requirements which may not be overridden. However, in certain situations, it may be possible to modify local codes and ordinances or for a project proponent to obtain a waiver to promote less impervious area, such as allowing narrower road widths, sidewalks on one side of the street, shared driveways, reciprocal parking, and reduced building set-backs. Some strategies for minimizing impervious surfaces may serve multiple functions by supporting other local planning objectives such as providing traffic-calming measures and promoting walkable and healthy communities.

3.2.1.1. Limit Overall Coverage of Paving and Roofs

This can be accomplished by designing compact, taller structures, narrower and shorter streets and sidewalks, smaller parking lots (fewer stalls, smaller stalls, and more efficient drive lanes), and indoor or underground parking. Examine site layout and circulation patterns and identify areas where landscaping can be substituted for pavement.

3.2.1.2. Detain and Retain Runoff Throughout the Site

On flatter sites, it typically works best to intersperse landscaped areas and integrate small scale retention practices among the buildings and paving. On hillside sites, drainage from upper areas may be collected in conventional catch basins and piped to landscaped areas and BMPs in lower areas. Or use low retaining walls to create terraces that can accommodate BMPs.

3.2.1.3. Example Planning Phase Techniques

- Build vertically rather than horizontally - add floors to minimize building footprint.
- Cluster development to reduce requirements for roads and preserve green space.
- Minimize lot setbacks (which in turn minimize driveway lengths).
- Reduce road widths to minimum necessary for emergency vehicles.
- Utilize shared driveways.

3.2.1.4. Example Design Phase Techniques

- Install sidewalks on only one side of private roadways to the extent allowed by accessibility requirements.
- Use alternative materials such as permeable paving blocks or porous pavements on driveways, sidewalks, parking areas, etc. Practices should be selected such that they do not present health and safety hazards, such as tripping hazards.
- Create smaller parking spaces intended for compact cars.

3.2.1.5. Example Construction Phase Techniques

- Minimize unnecessary compaction where possible. The infiltrative capacity of soils can be greatly reduced when they are compacted, often to the point that they perform similarly to impervious surfaces. Where possible, remediate compacted soils.
- Minimize construction footprint.
- Preserve existing vegetation and trees as feasible.

3.2.2. Maximize Natural Infiltration Capacity

A key component of LID is taking advantage of a site's natural infiltration and storage capacity. This will limit the amount of runoff generated, and therefore the need for mitigation BMPs. A site soils/geology assessment will help to define areas with higher potential for infiltration and surface storage.

These areas are typically characterized by:

- Principally Hydrologic Soil Group A or B soils and in some cases Group C soils.
- Mild slopes or depressions.
- Historically undeveloped areas.

3.2.2.1. Example Planning Phase Techniques

- Avoid placing buildings or other impervious surfaces on highly permeable areas.
- Cluster buildings and other impervious areas onto the least permeable soils.

3.2.2.2. Example Design Phase Techniques

- Where paving of permeable soils cannot be avoided, loss of infiltration capacity can be minimized by using permeable paving materials.

3.2.2.3. Example Construction Phase Techniques

- Minimize construction footprint.
- Minimize incidental and unnecessary compaction where it is not necessary to meet the applicable grading code requirements.

3.2.3. Preserve Existing Drainage Patterns and Time of Concentration

Integrating existing drainage patterns into the site plan will help maintain a site's predevelopment hydrologic function. Preserving existing drainage paths and depressions will help maintain the time of concentration and infiltration rates of runoff, decreasing peak flows. The best way to define existing drainage patterns is to visit the site during a rain event and to directly observe runoff flowing over the site. If this is impossible, drainage patterns can be inferred from topographic data, though it should be noted that depression micro-storage features are often not accurately mapped in topographic surveys. Analysis of the existing site drainage patterns during the site assessment phase of the project can help to identify the best locations for buildings, roadways, and stormwater BMPs.

Where possible, add additional depression "micro" storage throughout the site's landscaping that mimics natural drainage patterns. Mild gradients can be used to extend the time of concentration, which reduces peak flows and increases the potential for additional infiltration. While risk of serious flooding must be minimized, the persistence of temporary "puddles" during storms is beneficial to infiltration. If a site is visited during dry weather, these areas can sometimes be identified by looking for surficial dried clay deposits.

Use drainage as a design element. Use depressed landscape areas, vegetated buffers, and bioretention areas as amenities and focal points within the site and landscape design. Bioretention areas can be almost any shape and should be located at low points. When

configured as swales, bioretention areas can detain and treat low runoff flows and also convey higher flows.

3.2.3.1. Example Planning Phase Techniques

- Avoid channelization of natural streams.
- Establish set-backs and buffer areas from natural streams.
- Where natural streams will be converted to engineered streams, provide sinuosity to increase the time of concentration.
- Develop an effective conceptual drainage plan.

3.2.3.2. Example Design Phase Techniques

- Avoid channelization of natural streams.
- When designing channels, use mild slopes and increase channel roughness to extend time of concentration.
- When possible, use pervious channel linings to maximize opportunity for infiltration.
- Use vegetated, un-hardened conveyance elements.
- Intersperse localized retention features throughout site.

3.2.3.3. Example Construction Phase Techniques

- Minimize construction footprint.

Micro-scale on-lot retention is a component of preserving existing drainage patterns and times of concentration. Micro-scale on-lot retention is a HSC for the purpose of this TGD. A BMP fact sheet for localized on-lot retention is found in [Appendix XIV](#). The fact sheet describes recommended design criteria and methods of quantifying the performance of this practice.

3.2.4. Disconnect Impervious Areas

Runoff from ‘connected’ impervious surfaces commonly flows directly to a paved surface (driveway, sidewalk, or to the curb line) and from there to the stormwater collection system with no opportunity for infiltration into the soil. For example, roofs and sidewalks commonly drain onto parking lots, and the runoff is conveyed by the curb and gutter to the nearest storm inlet. Runoff from numerous impervious drainage areas may converge, combining their volumes, peak runoff rates, and pollutant loads. Disconnecting impervious areas from conventional stormwater conveyance systems allows runoff to be collected and managed at the source or redirected onto pervious surfaces such as vegetated areas. This reduces the amount of directly connected impervious area (DCIA), and will reduce the peak discharge rate by increasing the time of concentration, maximize the opportunity for infiltration by reducing the velocity of flows and providing for greater contact time with the soil, and maximize the opportunity for ET during transport.

Disconnection practices may be applied in almost any location, but impervious surfaces must discharge into a suitable receiving area for the practices to be effective. Information gathered during the site assessment will help determine appropriate receiving areas. Typical receiving areas for disconnected impervious runoff include landscaped areas and/or LID BMPs (i.e., filter strips or bioretention). Runoff must not flow toward building foundations or be redirected onto adjacent private properties. Setbacks from buildings or other structures may be required to ensure soil stability. Consult with the project geotechnical engineer to identify areas where infiltration can be accommodated.

It is important to bear in mind that water flows down hill; therefore receiving areas must be located down gradient from runoff discharges. In a residential setting, this could mean that roof runoff discharges to either the front yard or the back yard, depending on the site configuration. As compared to conventional development, some potential techniques for redirecting flows to vegetated areas may require local design standards to be revisited or a waiver obtained.

3.2.4.1. Example Planning Phase Techniques

- Plan site layout and mass grading to allow for runoff from impervious surfaces to be directed into distributed permeable areas such as turf, recreational areas, medians, parking islands, planter boxes, etc.
- Use vegetated swales for stormwater conveyance instead of traditional concrete pipes.
- Avoid channelization of natural on-site streams.

3.2.4.2. Example Design Phase Techniques

- Provide permeable areas within medians and parkways that are designed to accept runoff from adjacent areas (i.e. via curb cuts).
- Construct roof downspouts to drain to pervious areas such as planter boxes or adjacent landscaping. This approach is further described in [Section 4](#).
- Use permeable paving materials such as paving blocks or porous pavements on driveways, sidewalks, parking areas, etc.

To minimize stormwater-related impacts, apply the following design principles to the layout of newly developed and redeveloped sites:

- Define the development envelope and protected areas, identifying areas that are most suitable for development and areas that should be left undisturbed.
- Set back development from creeks, wetlands, and riparian habitats.
- Preserve established trees as practicable (see [Section 3.3](#))

Impervious area disconnection is characterized as a HSC for the purpose of this TGD. BMP fact sheets for localized on-lot retention and impervious area dispersion are found [Appendix XIV](#). These fact sheets include recommended design criteria and methods of quantifying the benefits of impervious area disconnection.

3.3. Vegetative Protection, Selection Revegetation, and Soil Stockpiling

3.3.1. Protect Existing Vegetation and Sensitive Areas

A thorough site assessment will identify any areas containing dense vegetation or well-established trees. When planning the site, avoid disturbing these areas. Soils with thick, undisturbed vegetation have a much higher capacity to store and infiltrate runoff than do disturbed soils. Reestablishment of a mature vegetative community can take decades. Sensitive areas, such as wetlands, streams, floodplains, or intact forest, should also be avoided. Development in these areas is often restricted by federal, state and local laws.

Vegetative cover can also provide additional volume storage of rainfall by retaining water on the surfaces of leaves, branches, and trunks of trees during and after storm events. This capacity is rarely considered, but on sites with a dense tree canopy it can provide additional volume mitigation.

3.3.1.1. Example Planning Phase Techniques

- Establish set-backs and buffer zones surrounding sensitive areas.
- Incorporate established trees into site layout.

3.3.1.2. Example Design Phase Techniques

- Design site to deter human activity within sensitive areas (i.e. fences, signs, etc).

3.3.1.3. Example Construction Phase Techniques

- Provide and maintain highly visible flagging and/or fencing around sensitive areas or vegetation that is to be protected.

3.3.1.4. Example Occupancy Phase Techniques

- Establish use/access restrictions to sensitive areas.

3.3.2. Revegetate Disturbed Areas

Maximizing plant cover protects the soil and improves ability of the site to retain stormwater, minimize runoff, and help to prevent erosion. Plants have multiple impacts on downstream water quality. First, the presence of a plant canopy (plus associated leaf litter and other organic matter that accumulates below the plants) can intercept rainfall, which reduces the erosive potential of precipitation. The Street Trees/Canopy Cover Fact Sheet provided in [Appendix XIV](#) facilitates quantification of the retention benefits of canopy cover. With less eroded material going to receiving waters, turbidity, chemical pollution, and sedimentation are reduced. Second, a healthy plant and soil community can help to trap and remediate chemical pollutants and filter particulate matter as water percolates into the soil. This occurs through the

physical action of water movement through the soil, as well as through biological activity by plants and the soil microbial community that is supported by plants. Third, thick vegetative cover can maintain and even improve soil infiltration rates.

When selecting plants for re-vegetation, preference should be given to native vegetation, which is uniquely suited to the local soils and climate. However, consideration of the location of the plants in the landscape with regards to wildfire safety can sometimes make the use of native species unsuitable. The Orange County Fire Authority requires “fuel modification zones” adjacent to development and restricts species of plant that may be used in these zones.

Additional information can be found by contacting local Master Gardeners or seeking the advice of local plant nurseries, which will have specific knowledge of plants suitable for your particular application. The Las Pilitas Nursery in Santa Margarita has compiled a detailed database of California native plants which is accessible online at:

http://www.laspilitas.com/comhabit/california_communities.html. The website can be used to aid in determining the correct plant communities by searching by either ZIP code or town. In cases where use of native vegetation is impractical or impossible, use of non-natives adapted to similar climate regimes, such as the Mediterranean, may be appropriate. This strategy will maximize the successful establishment of plantings, and minimize the need for supplemental irrigation.

3.3.3. Soil Stockpiling and Site Generated Organics

The regeneration of disturbed topsoil can take years under optimal conditions, and sometimes can take many decades (Brady and Weil, 2002⁹). Proper stockpiling, storage, and reapplication of disturbed topsoil can greatly accelerate this process. Improper soil storage and restoration can significantly decrease the biological activity of the soil, decrease the successful establishment of plantings, and increase the ability of undesirable invasive species to dominate the disturbed landscape. Proper stockpiling generally includes protecting the stockpile to prevent excessive compaction and covering the stockpile to prevent significant erosion and leaching of nutrients.

Soil stockpiling and the use of in situ grubbed plant material and duff as mulch or soil amendments is encouraged. This will reduce the need for importation of top soil to improve soil quality, and will encourage reestablishment of soil flora and fauna after site disturbance. Successful soil stockpiling and reuse begins in the early stages of project planning.

The use of topsoil harvested from the local site can improve the productivity and rate of re-vegetation of a disturbed site. In addition to stockpiled soil, vegetative material grubbed from the site and free of invasive species can be tilled back into the soil to increase organic content.

⁹ The Nature and Properties of Soils, 13th Edition, Nyle C. Brady, Ray R. Weil, 2002.

Restoration of disturbed areas using native soils which have been properly stockpiled during the construction phase of the project is the preferred method of post construction soil restoration. Proper assessment of the site during the design phase of the project is critical to maintaining soil quality, both structural and biological, during the period the soil is stockpiled. Determination of the volume of soil to be stockpiled and designating an area large enough on site to accommodate the stockpiled soil should be considered early in project design.

Consideration must be given to maintenance of the flora and fauna present in the stockpiled soil in addition to its physical condition. Improper storage such as soil that is too wet or stockpiled too deeply, can render what were active biological soil communities sterile. This will severely impact the ability of the soil to support a healthy plant community. If necessary, a local soil scientist familiar with regional soils can provide testing services to evaluate soil condition prior to and after construction and recommend appropriate remediation steps to restore the soil's predevelopment ability to infiltrate stormwater runoff and support a healthy plant community.

Additional information about the impact of soil stockpiling can be found in the following document which was prepared for the District 11 office of the California Department of Transportation:

Restoration in the California Desert - <http://www.sci.sdsu.edu/SERG/techniques/topsoil.html>

3.3.4. Firescaping

Fire is a part of the ecosystems of Southern California. Over the years, wildfires have repeatedly destroyed homes and caused loss of life. In response to this natural phenomenon, extensive research has been done and, in the interest of public safety, guidelines have been codified into law. When considering any planting or re-vegetation plan, consideration must be given to minimizing the risks of fire with proper plant selection and maintenance. Keep in mind that all plants are flammable given the right conditions; selection and maintenance of plants to mitigate flammability go hand-in-hand. A plant with a low flammability rating which is allowed to accumulate dead wood or excessive levels of duff in and around the plant will elevate the risk of flammability significantly.

California law (Public Resources Code 4291) requires a minimum 100-foot space around homes on level ground to protect the structure and provide a safe area for firefighters. If a home is located on a slope, additional distance is required and plant spacing, selection, and design must be modified to maintain proper fire safety margins.

A four zone system has been developed to create a maximum buffer around structures located in high risk wildfire zones. Each zone has very specific landscaping and management requirements to minimize flammability of the landscape. The four zones are broken down as follows:

- Zone One - The garden or clean and green zone

- Zone Two – The greenbelt or reduced fuel zone
- Zone Three – The transition zone
- Zone Four – Native or Natural Zone / Open Space

The landscape plant selection and design for any bioretention or re-vegetation project should be compliant with the requirements of the specific zone in which it will be located. For assistance in determining the correct zone plant selection and spacing, contact your local fire department or insurance company for assistance.

3.3.5. Xeriscape Landscaping

As water use, the frequency of drought, and the impact of organic waste generated from landscape management increases in California, methods to deal with these problems have been developed. The concept of xeriscape was originally developed by the Denver Water Department in 1978. The word was coined by combining the Greek word xeros ("dry") with landscape. Since 1978, the xeriscape has become a widely-accepted alternative to traditional landscape design in dry areas.

Xeriscape landscaping is a landscape design and plant selection scheme that is used to minimize required resources and waste generated from a landscape. Defined as “quality landscaping that conserves water and protects the environment” the principles of xeriscape should be employed in any project that creates or restores the landscape. Consulting local resources, such as your local county extension agent, Master Gardeners, Landscape Architects, or local garden centers and nurseries, will help to select plant material suitable for a specific geographic location.

Xeriscape landscaping is based on seven principles:

- Soil analysis
- Planning and design
- Appropriate plant selection
- Practical turf areas
- Efficient irrigation
- Use of mulches
- Appropriate maintenance

Xeriscape landscaping has many benefits which include:

- Reduced water use
- Decreased energy use
- Reduced heating and cooling costs resulting from optimal placement of trees and plants
- Minimal runoff from both stormwater and irrigation resulting in reduction of sediment, fertilizer and pesticide transport
- Reduction in yard waste that would normally be landfilled

- Creation of habitat for wildlife
- Lower labor and maintenance costs
- Extended life of existing water resources infrastructure.

A xeriscape-type landscape can reduce outdoor water consumption by as much as 50 percent without sacrificing the quality and beauty of landscaped areas. It is also an environmentally sound landscape, requiring less fertilizer and fewer chemicals. Xeriscape-type landscape is low maintenance, saving time, effort and money.

Street trees/canopy cover are elements of vegetative protection, revegetation, and maintenance and are characterized as a HSC for the purpose of this TGD. A BMP fact sheet for street trees/canopy interception is found in [Appendix XIV](#). Fact sheets include recommended design criteria and methods of quantifying the benefits of street trees/canopy interception.

The selection and design of vegetative-based LID BMPs that are specifically sized to treat the DCV is discussed further in [Section 4](#).

3.4. Slopes and Channel Buffers

Project plans should include site design BMPs to decrease the potential for erosion of slopes and/or channels. The following design principles should be considered, and incorporated and implemented where determined applicable and feasible by the Permittee:

1. Convey runoff safely from the tops of slopes.
2. Avoid disturbing steep or unstable slopes.
3. Avoid disturbing natural channels.
4. Install permanent stabilization BMPs on disturbed slopes as quickly as possible.
5. Vegetate slopes with native or drought tolerant vegetation.
6. Control and treat flows in landscaping and/or other controls prior to reaching existing natural drainage systems, unless infiltration would cause geotechnical hazards.
7. If hydromodification control is not provided before discharge to the channel, install permanent stabilization BMPs in channel crossings as quickly as possible, and ensure that increases in runoff velocity and frequency caused by the project do not erode the channel.
8. Install energy dissipaters, such as riprap, at the outlets of new storm drains, culverts, conduits, or channels that enter unlined channels in accordance with applicable specifications to minimize erosion. Energy dissipaters should be installed in such a way as to minimize impacts to receiving waters.
9. Instead of discharging to steep reaches, consider collecting and conveying runoff to downgradient discharge points.
10. On-site conveyance channels should be lined, where appropriate, to reduce erosion caused by increased flow velocity due to increases in tributary impervious area. The first choice for linings should be grass or some other vegetative surface, since these materials not only reduce runoff velocities, but also provide water quality benefits from filtration

and infiltration. Irrigation demand of vegetated systems should be considered. If velocities in the channel are large enough to erode grass or other vegetative linings, rock, riprap, concrete soil cement or geo-grid stabilization may be substituted or used in combination with grass or other vegetation stabilization.

11. Other design principles which are comparable and equally effective.

These practices should be implemented, as feasible, consistent with local codes and ordinances. Projects involving an alteration to bed, bank, or channel of a Water of the US may require approval of regulatory agencies with jurisdiction over water bodies, (e.g., the U.S. Army Corps of Engineers, the Regional Boards and the California Department of Fish and Game).

3.5. Techniques to Minimize Land Disturbance

Minimizing the amount of site clearing and grading can dramatically reduce the overall hydrologic impacts of site development. This applies primarily to new construction but the principles can be adapted to retrofit and infill projects as well.

Soil compaction resulting from the movement of heavy construction equipment can reduce soil infiltration rates by 70-99% (Gregory et al, 2006)¹⁰. Even low levels of compaction caused by light construction equipment can significantly reduce infiltration rates. In addition, compaction can destroy the complex network of biota in the soil profile that support the soil's ability to capture and mitigate pollutants. Soil compaction severely limits the establishment of healthy root systems of plants that may be used to revegetate the area. For these reasons, it is very important to avoid unnecessary damage to soils during the construction process. The use of clearly defined protection areas will help to preserve the existing capacity of the site to store, treat and infiltrate stormwater runoff.

3.5.1.1. Example Planning Phase Techniques

- Many of the planning techniques identified in the above sections will help minimize the construction footprint.

3.5.1.2. Example Construction Phase Techniques

- Minimize the size of construction easements.
- Locate material storage areas and stockpiles within the development envelope.
- Limit ground disturbance outside of areas that require grading.
- Identify and clearly delineate access routes for the movement of heavy equipment.
- Establish and delineate vegetation and soil protection areas.

¹⁰ Gregory, J.H.; Dukes, M.D.; Jones, P.H.; and G.L. Miller, 2006. Effect of urban soil compaction on infiltration rate. *Journal of Soil and Water Conservation* 2006 61(3):117-124 Online at: <http://www.floridadep.org/water/wetlands/erp/rules/stormwater/docs/compaction.pdf>

Additional techniques for minimizing disturbance and protecting or restoring site conditions during construction phase include:

Establish Vegetation and Soil Protection Areas

Vegetative protection areas (e.g. stream, river, lake and other watercourse buffers, vegetation protection areas, existing trees) should be clearly delineated with highly visible fencing materials to prevent incursion of equipment or the stockpiling of materials during construction. Tree trunks should be sheathed during construction to prevent or minimize damage to the bark.

Use of Mulch and Load Distributing Matting

Mulch blankets can be used to protect soil from compaction during construction. The use of timbers or other types of load distributing materials can also be used to limit the effect of heavy equipment movement on the site.

Pre / Post Construction Soil and Plant Treatments

Consideration should be given to pre-construction treatment of the soil to mitigate the stresses on existing shrubs and trees. This can include soil aeration and specific fertilization protocols that would encourage plant vitality. A local restoration ecologist should be engaged well in advance of the start of construction to develop a plan based on specific site conditions since some of these practices are carried out prior to construction.

Inspection Guidelines and Procedures

Management of soil, water, and vegetation protection measures during the construction process will only be effective if it is carefully implemented and meticulously policed during all phases of construction. Significant damage can be done in a short timeframe, and the cost of damage remediation tends to be far greater than the cost of avoiding it. Areas intended for infiltration should be treated especially carefully. Avoid the use of heavy machinery or discharge of sediment-laden runoff in these areas. Heavy machinery will compact the soils and fine grained materials in sediment will reduce the soil's infiltration capability.

Techniques implemented on the construction site to minimize the construction footprint should be included in the project documentation. Contractors working on the project should review and agree to comply with them while working on the jobsite. Construction site inspections should include inspection of such protocols to ensure they are maintained throughout construction.

3.6. LID BMPs at Scales from Single Parcels to Watershed

While the above techniques and approaches are primarily aimed at project-specific planning and design efforts on individual parcels or sites, they are equally applicable when planning projects or activities on a larger scale. The application of LID site planning principles and practices on a watershed scale may be reflected in the promotion of high density development and infill, protection of drainage courses, land use planning with consideration for areas most

suitable for development, preservation of native vegetation, and the implementation of LID BMPs on a sub-regional or regional basis. Such approaches and opportunities are expected to be evaluated and identified in future watershed-scale plans that integrate water quality, hydrologic, fluvial, water supply, and habitat considerations. A discussion of the potential role of watershed-scale plans in BMP selection should be provided in Section 2.4.2.2 of the [Model WQMP](#). A project proponent is not precluded from organizing and implementing LID BMPs on a regional scale.

3.7. Integrated Water Resource Management Practices

Selection and incorporation of site design principles into new development and significant redevelopment projects, whether on-site or off-site can have significant multiple benefits on a subwatershed, watershed and county-wide basis. For example, Orange County Water District is supportive of regional/sub-regional infiltration BMPs as an approach to retaining more urban runoff in the groundwater basin. As another example, the San Diego Creek Natural Treatment System (NTS) Master Plan (www.irwd.com/environment/natural-treatment-system.html) includes, among other concepts, constructed wetlands integrated with flood control facilities. These types of facilities would provide retention and biotreatment as well as treatment of retrofit dry weather flows while maintaining the original flood control functionality of the basin. Wetland facilities also provide habitat for many bird species, including endangered species, can provide aesthetic benefits, and in some cases may also provide recreational benefits. Finally, LID and hydromodification control BMPs may provide significant flood control benefits, therefore the system design processes described in this TGD should be coordinated with flood control design (not covered by this TGD) to most efficiently support both functions.

SECTION 4. LID AND TREATMENT CONTROL BMP DESIGN

4.1. Introduction

LID BMPs are required in addition to site design measures and source controls to reduce pollutants in stormwater discharges. LID BMPs are engineered facilities that are designed to retain or biotreat runoff on the project site. HSCs can be considered to be a hybrid between site design and LID BMPs which are designed to manage stormwater runoff similar to LID BMPs, but are less rigorously designed and maintained than LID BMPs. Treatment control BMPs are required if it is not feasible to design LID BMPs for the full DCV. Treatment control BMPs are structural, engineered facilities that are designed to remove pollutants from stormwater runoff using treatment processes that do not incorporate significant biological methods. Both LID BMPs and treatment control BMPs can also partially or fully satisfy hydromodification performance criteria, depending on their design and functions.

The BMP designs described in the [BMP Fact Sheets \(Appendix XIV\)](#) and in the referenced design manuals shall constitute what are intended as LID and Treatment Control BMPs for the purpose of meeting stormwater management requirements. Other BMP types and variations on these designs may be approved at the discretion of the reviewing agency if documentation is provided demonstrating that the BMP is functionally equivalent to those described in this TGD or published design standards. Water quality monitoring data may be required by local jurisdictions to validate the performance of a proposed BMP type not described in this section.

BMPs are categorized as described in [Table 4.1](#).

This section provides an introduction to each category of BMP and provides links to fact sheets that contain recommended criteria for the design and implementation of these BMPs. Criteria specifically described in these fact sheets override guidance contained in referenced documents. Where criteria are not specified, the user should defer to best professional judgment based on the recommendations of the referenced guidance material or other published and generally accepted sources. When an outside source is used, the preparer must document the source in the project WQMP.

Table 4.1. Categories of LID BMPs and Treatment Control BMPs

HSCs ¹	Infiltration ¹	Harvest and Use	Evapotranspiration	Biotreatment ²	Treatment Control
<ul style="list-style-type: none"> ➤ Localized on-lot infiltration ➤ Impervious area dispersion (e.g. roof top disconnection) ➤ Street trees (canopy interception) ➤ Residential rain barrels (not actively managed) ➤ Green roofs/ brown roofs ➤ Blue roofs ➤ Impervious area reduction (permeable pavers, site design) 	<ul style="list-style-type: none"> ➤ Infiltration basins ➤ Infiltration trenches ➤ Bioretention without underdrains ➤ Bioinfiltration ➤ Drywells ➤ Permeable pavement ➤ Underground infiltration 	<p><i>Storage options:</i></p> <ul style="list-style-type: none"> ➤ Above-ground cisterns and basins ➤ Underground detention <p><i>Potential demand:</i></p> <ul style="list-style-type: none"> ➤ Irrigation ➤ Toilet flushing ➤ Vehicle/ equipment washing ➤ Evaporative cooling ➤ Industrial processes ➤ Dilution water ➤ Other non-potable uses 	<p><i>ET is a significant volume reduction process in:</i></p> <ul style="list-style-type: none"> ➤ All HSCs ➤ Surface-based infiltration BMPs ➤ Biotreatment BMPs² 	<ul style="list-style-type: none"> ➤ Bioretention with Underdrains ➤ Vegetated Swale ➤ Vegetated Filter Strip ➤ Wet Detention Basin ➤ Constructed Wetland ➤ Dry Extended Detention Basin ➤ Proprietary Biotreatment 	<ul style="list-style-type: none"> ➤ Sand Filters (media bed filters) ➤ Cartridge Media Filters
					Pretreatment
					<ul style="list-style-type: none"> ➤ Hydrodynamic Separators ➤ Catch Basin Inserts ➤ Biotreatment BMPs³

General note: Lists are not exhaustive; BMPs with similar unit processes may be approved at the discretion of local jurisdictions.

1 - Soil amendments are critical components of some HSCs and infiltration BMPs. Soil amendments may be used to improve infiltration capacity of low permeability soils where the limiting soil horizon lies within the depth that can be feasibly amended. Where the entire thickness of the limiting horizon cannot be amended, the use of soil amendments would increase storage volume but not increase effective infiltration rates.

2 - Biotreatment BMPs shall be designed and maintained per the criteria contained in [Appendix XII](#) and shall be designed to achieve the maximum feasible ET and infiltration per the criteria contained in [Appendix XI](#). BMPs not meeting these criteria shall be considered treatment control BMPs.

3 - Biotreatment BMPs may be used as pretreatment for other BMP categories. If biotreatment is used as pretreatment, the overflow from these facilities shall be considered biotreated.

4.2. Hydrologic Source Controls

HSCs can be considered to be a hybrid between site design practices and LID BMPs. HSCs are distinguished from site design BMPs in that they do not reduce the tributary area or reduce the imperviousness of a drainage area; rather they reduce the runoff volume that would result from a drainage area with a given imperviousness compared to what would result if HSCs were not used. HSCs are differentiated from LID BMPs in that they tend to be more highly integrated with site designs and tend to have less defined design and operation. For example, it may not be possible to precisely describe the storage volume and drawdown rate of a pervious area receiving drainage from downspout disconnects; however these systems can be very effective at reducing runoff.

[Appendix XIV.1](#) provides fact sheets for several types of HSCs.

- HSC-1: Localized On-Lot Infiltration
- HSC-2: Impervious Area Dispersion
- HSC-3: Street Trees
- HSC-4: Residential Rain Barrels
- HSC-5: Green Roof / Brown Roof
- HSC-6: Blue Roof

Permeable pavement (INF-6) is considered to be an HSC in cases where the permeable pavement it is designed to manage only rainfall that falls directly on the pavement and a small adjacent tributary area no more than 50 percent of the size of the permeable pavement footprint.

4.3. Infiltration BMPs

Infiltration BMPs are LID BMPs that capture, store and infiltrate stormwater runoff. These BMPs are engineered to store a specified volume of water and have no design surface discharge (underdrain or outlet structure) until this volume is exceeded. These types of BMPs may also lose some water to ET, but are characterized by having their most dominant volume losses due to infiltration. [Appendix XIV.2](#) provides fact sheets for several types of infiltration BMPs.

- INF-1: Infiltration
- INF-2: Infiltration Trench
- INF-3: Bioretention with no Underdrain
- INF-4: Bioinfiltration
- INF-5: Drywell
- INF-6: Permeable Pavement (concrete, asphalt, and pavers)
- INF-7: Underground Infiltration

4.4. Harvest and Use BMPs

Harvest and Use (aka Rainwater Harvesting) BMPs are LID BMPs that capture and store stormwater runoff for later use. These BMPs are engineered to store a specified volume of water and have no design surface discharge until this volume is exceeded. The utilization of captured water used should comply with codes and regulations and should not result in runoff to storm

drains or receiving waters. Potential uses of captured water may include irrigation demand, indoor non-potable demand, industrial process water demand, or other demands. [Appendix XIV.3](#) provides fact sheets for two types of harvest and use configurations.

- HU-1: Above-Ground Cisterns
- HU-2: Underground Detention

4.5. Evapotranspiration BMPs

ET is a significant volume reduction process in HSCs, surface-based infiltration BMPs, and biotreatment BMPs. Because ET is not the sole process in these BMPs, specific fact sheets have not been developed for ET-based BMPs. However the criteria contained in this TGD and Appendices ensure that BMP systems will achieve the maximum feasible ET, as necessary, to demonstrate that the maximum feasible retention has been provided on-site, as summarized below:

- If a project cannot be designed to infiltrate and/or harvest and use the full DCV, the following criteria must be met before evaluating biotreatment BMPs:
 - All applicable HSCs must be considered (ET is a principal process in all HSCs)
 - The project must demonstrate that at least minimum site design practices for available open space have been met (ET is strongly a function of available ET area)
- Biotreatment BMPs, if needed to address remaining unmet volume, must be designed to achieve the maximum feasible infiltration and ET per criteria contained in [Appendix XI](#) and [Appendix XII](#).

Therefore, HSC, Infiltration, and Biotreatment BMP fact sheets are applicable for ET as well.

4.6. Biotreatment BMPs

Biotreatment BMPs are a broad class of LID BMPs that reduce stormwater volume to the maximum extent practicable, treat stormwater using a suite of treatment mechanisms characteristic of biologically active systems, and discharge water to the downstream storm drain system or directly to receiving waters. Treatment mechanisms include media filtration (though biologically-active media), vegetative filtration (straining, sedimentation, interception, and stabilization of particles resulting from shallow flow through vegetation), general sorption processes (i.e., absorption, adsorption, ion-exchange, precipitation, surface complexation), biologically-mediated transformations, and other processes to address both suspended and dissolved constituents. Biotreatment BMPs include both flow-based and volume-based BMPs.

Conceptual criteria for biotreatment BMP selection, design, and maintenance [Appendix XII](#). These criteria are generally applicable to the design of biotreatment BMPs in Orange County and BMP-specific guidance is provided in the following fact sheets.

Note: Note: Biotreatment BMPs shall be designed to provide the maximum feasible infiltration and ET based on criteria contained in [Appendix XI](#).

[Appendix XIV.4](#) provides fact sheets for several types of biotreatment BMPs.

- BIO-1: Bioretention with Underdrains
- BIO-2: Vegetated Swale
- BIO-3: Vegetated Filter Strip
- BIO-4: Wet Detention Basin
- BIO-5: Constructed Wetland
- BIO-6: Dry Extended Detention Basin
- BIO-7: Proprietary Biotreatment

4.7. Treatment Control BMPs

Treatment control BMPs provide treatment mechanisms but do not sustain significant biological processes. In addition to the treatment control BMPs listed by this TGD, all biotreatment BMPs can be used to fulfill treatment control criteria.

[Appendix XIV.5](#) provides fact sheets for several types of treatment control BMPs as well as references to other guidance documents containing design criteria.

- TRT-1: Sand Filters
- TRT-2: Cartridge Media Filter

4.8. Pretreatment/Gross Solids Removal BMPs

Pretreatment and gross solids removal is a desirable first step in optimizing BMP selection for a variety of urban runoff situations. In most cases, implementation of pretreatment BMPs will improve the performance and reduce the maintenance associated with downstream BMPs. In fact, pretreatment may be necessary for some BMPs to perform as intended (i.e. trash and debris removal prior to sand filtration). In some cases, BMPs normally considered as a pretreatment BMP may be the only BMP measure feasible before runoff enters receiving waters. An example of this type of situation could be catch basin inserts within roadways adjacent to storm drain channels or waterways. [Appendix XIV.6](#) provides fact sheets for several types of pretreatment/gross solids removal BMPs as well as references to other guidance documents containing design criteria.

- PRE-1: Hydrodynamic Separation Device
- PRE-2: Catch Basin Insert Fact Sheet

4.9. BMP Performance Summaries

[Table 4.2](#) and [Table 4.3](#) provides rankings of relative performance of LID BMPs and Treatment Control BMPs, respectively, to support the [BMP selection criteria](#) described in [Section 2.4.2.5](#).

These tables are based on literature and recent analysis of BMP performance monitoring data. The performance ratings in this table are based on observed effluent quality, observed differences between influent and effluent quality (magnitude and significance), and assumed unit operations and processes (UOPs) provided by each BMP. In order for a BMP to achieve the level of performance anticipated by this table, the BMP must:

- Be designed to contemporary design standards based on the criteria contained in the BMP Fact Sheets ([Appendix XIV](#)), the guidance manuals referenced from these fact sheets, and [Appendix XII](#) (Conceptual Biotreatment Design, Operation and Maintenance Criteria).
- Include the assumed UOPs listed in this table. BMPs not found on this list may be acceptable on the basis of the UOPs they provide.

[Table 4.4](#) relates UOPs to the pollutant classes they address. [Table 4.4](#) provides the basis for assessments of expected performance described in [Table 4.2](#) and [Table 4.3](#) where monitoring data were not available or inconclusive.

Table 4.2 Relative Treatment Performance Ratings of Biotreatment BMPs

Unit Operations and Process	Assumed Principal Unit Operations and Processes Provided	Suspended solids / sediment/ turbidity	Nitrogen compounds	Phosphorus	Heavy metals	Microbial / viral pathogens	Oils and grease	Dissolved toxic organic compounds	Trash and debris
Bioretention system	<ul style="list-style-type: none"> • Particulate Settling • Size Exclusion • Inert Media Filtration • Sorption/Ion Exchange • Microbial Competition/Predation • Biological Uptake • Volume loss (via infiltration, ET) 	H	L	L	H	M	H	M	H
Bioretention system with internal water storage zone and nutrient sensitive media design	Bioretention UOPs, <u>plus</u> : <ul style="list-style-type: none"> • Microbially Mediated Transformations (if designed with internal water storage zone) 	H	M	M	H	M	H	M	H
Dry extended detention basin	<ul style="list-style-type: none"> • Particulate Settling • Size Exclusion • Floatable Capture • Vegetative Filtration (with low-flow channel) • Volume loss (via infiltration, ET) 	M	L	M	M	L	M	L	H
Dry extended detention basin with vegetated sand filter outlet structure	Dry extended detention basin UOPs, <u>plus</u> : <ul style="list-style-type: none"> • Inert Media Filtration 	H	L	M	M	M	M	L	H
Vegetated Swale	<ul style="list-style-type: none"> • Vegetative Filtration • Sorption/Ion Exchange • Volume loss (via infiltration, ET) 	M	L	L	M	L	M	M	M
Vegetated Filter Strip	<ul style="list-style-type: none"> • Vegetative Filtration • Sorption/Ion Exchange • Volume loss (via infiltration, ET) 	M	L	L	M	L	M	M	L

Table 4.2 Relative Treatment Performance Ratings of Biotreatment BMPs

Unit Operations and Process	Assumed Principal Unit Operations and Processes Provided	Suspended solids / sediment/ turbidity	Nitrogen compounds	Phosphorus	Heavy metals	Microbial / viral pathogens	Oils and grease	Dissolved toxic organic compounds	Trash and debris
Wet detention basins and constructed stormwater wetlands	<ul style="list-style-type: none"> • Particulate Settling • Size Exclusion • Floatable Capture • Sorption/Ion Exchange • Microbially Mediated Transformations • Microbial Competition/Predation • Biological Uptake • Solar Irradiation • Volume loss (via infiltration, ET) 	H	M	M	M	M	H	M	H
Proprietary Biotreatment and Treatment Control	<ul style="list-style-type: none"> • Varies by product. 	Expected performance should be based on evaluation of unit processes provided by BMP and available testing data. Testing data should be evaluated based primarily on the effluent quality achieved by the BMP and the ability of the BMP to provide statistically significant removal under average conditions. Percent removal alone should not be used to evaluate the performance of proprietary BMPs (See Wright Water Engineers and Geosyntec Consultants, 2007). The basis for determining the rating of proposed proprietary BMPs must be documented in the Project WQMP. Approval is based on the discretion of the reviewing agency. Product-specific rankings may be published in the Technical Guidance Document at a later date.							

Sources

Strecker, E.W., W.C Huber, J.P. Heaney, D. Bodine, J.J. Sansalone, M.M. Quigley, D. Pankani, M. Leisenring, and P. Thayumanavan, "Critical assessment of Stormwater Treatment and Control Selection Issues." Water Environment Research Federation, Report No. 02-SW-1. ISBN 1-84339-741-2. 290pp

International Stormwater Best Management Practices (BMP) Database Pollutant Category Summary: Bacteria.

<http://www.bmpdatabase.org/Docs/BMP%20Database%20Bacteria%20Paper%20Dec%202010.pdf>

International Stormwater Best Management Practices (BMP) Database Pollutant Category Summary: Nutrients.

<http://www.bmpdatabase.org/Docs/BMP%20Database%20Nutrients%20Paper%20December%202010%20Final.pdf>

International Stormwater Best Management Practices (BMP) Database Pollutant Category Summary: Sediment (Pre-publication).

Overview of Performance by BMP Category and Common Pollutant Type, International Stormwater Best Management Practices (BMP) Database [1998-2008]

<http://www.bmpdatabase.org/Docs/Performance%20Summary%20Cut%20Sheet%20June%202008.pdf>

Oil and grease, Organics, and Trash and Debris based on review of unit operations and processes; comprehensive dataset not generally available. BMP must include design elements to address pollutants of concern.

Wright Water Engineers and Geosyntec Consultants, 2007. *Frequently Asked Questions Fact Sheet for the International Stormwater BMP Database: Why does the International Stormwater BMP Database Project omit percent removal as a measure of BMP performance?* (as posted on www.bmpdatabase.org)

Table 4.3 Relative Treatment Performance Ratings of Treatment Control BMPs

Unit Operations and Process	Assumed Principal Unit Operations and Processes Provided	Suspended solids / sediment/ turbidity	Nitrogen compounds	Phosphorus	Heavy metals	Microbial / viral pathogens	Oils and grease	Dissolved toxic organic compounds	Trash and debris
Sand Filter (inert)	<ul style="list-style-type: none"> • Size Exclusion • Floatable Capture • Inert Media Filtration 	H	L	M	LM	M	H	L	H
Sand Filter (specialized Media)	Sand Filter UOPs, plus: <ul style="list-style-type: none"> • Sorption/Ion Exchange 	H	L	M	M/H	M	H	M	H
Cartridge Media Filter	<ul style="list-style-type: none"> • Size Exclusion • Floatable Capture • Inert Media Filtration • Sorption/Ion Exchange 	M	L	M	M	M	H	M	H
Hydrodynamic Separator	<ul style="list-style-type: none"> • Particulate Settling (coarse only) • Size Exclusion • Floatable Capture 	M	L	L	L	L	M	L	H
Catch Basin Insert	<ul style="list-style-type: none"> • Size Exclusion 	L	L	L	L	L	M	L	H

Sources

Strecker, E.W., W.C Huber, J.P. Heaney, D. Bodine, J.J. Sansalone, M.M. Quigley, D. Pankani, M. Leisenring, and P. Thayumanavan, “Critical assessment of Stormwater Treatment and Control Selection Issues.” Water Environment Research Federation, Report No. 02-SW-1. ISBN 1-84339-741-2. 290pp

International Stormwater Best Management Practices (BMP) Database Pollutant Category Summary: Bacteria.

<http://www.bmpdatabase.org/Docs/BMP%20Database%20Bacteria%20Paper%20Dec%202010.pdf>

International Stormwater Best Management Practices (BMP) Database Pollutant Category Summary: Nutrients.

<http://www.bmpdatabase.org/Docs/BMP%20Database%20Nutrients%20Paper%20December%202010%20Final.pdf>

International Stormwater Best Management Practices (BMP) Database Pollutant Category Summary: Sediment (Pre-publication).

Overview of Performance by BMP Category and Common Pollutant Type, International Stormwater Best Management Practices (BMP) Database [1998-2008]

<http://www.bmpdatabase.org/Docs/Performance%20Summary%20Cut%20Sheet%20June%202008.pdf>

Oil and grease, Organics, and Trash and Debris based on review of unit operations and processes; comprehensive dataset not generally available. BMP must include design elements to address pollutants of concern.

Table 4.4 Pollutants Address by Unit Operations and Processes

Unit Operations and Process	Suspended solids / sediment	Particulate-bound pollutants	Dissolved Fraction			Microbial / viral pathogens	Oils and grease	Toxic organic compounds	Trash and debris
			Nitrogen compounds	Phosphorus	Heavy metals				
Volume Loss (via Infiltration and ET)	X	X	X	X	X	X	X	X	
Particulate Settling (Density separation)	X	X							X
Size exclusion (trash racks, outlet structures. Media filtration)	X	X							X
Floatable Capture (Density separation -outlet structures designed to remove floatables)							X		X
Vegetative Filtration	X	X					X		X
Inert Media Filtration	X	X			X ¹	X	X		X
Sorption/Ion Exchange within media or soils				X	X		X	X	
Microbially Mediated Transformation (oxidation, reduction, or facultative processes)			X	X	X		X	X	
Microbial Competition/ Predation						X			
Biological Uptake			X	X	X	X	X	X	
Solar Irradiation						X		X	

1 - Inert media filters (i.e. sand) in fact have shown the ability to remove dissolved constituents either after they have been “seasoned” (i.e. organics have built up in the media) or they contain specialized inorganic media (e.g., iron coated sand) which can result in dissolved metals removals.

Principal Source

Strecker, E.W., W.C Huber, J.P. Heaney, D. Bodine, J.J. Sansalone, M.M. Quigley, D. Pankani, M. Leisenring, and P. Thayumanavan, “Critical assessment of Stormwater Treatment and Control Selection Issues.” Water Environment Research Federation, Report No. 02-SW-1. ISBN 1-84339-741-2. 290pp

SECTION 5. HYDROMODIFICATION CONTROL DESIGN

5.1. Introduction

This section describes methods of designing systems to address HCOCs. HCOCs are defined differently in the North and South Orange County permits and therefore different approaches are required for designing systems to address HCOCs. Hydromodification control refers to the methods used to address HCOCs and in the context of this TGD, the term hydromodification is interchangeable with HCOCs.

5.2. Hydromodification Control Concepts

The physical response of stream channels to changes in catchment runoff and sediment yield caused by land use modifications is referred to as hydromodification. Unless managed, hydromodification can cause channel erosion, migration, or sedimentation, as well as biologic impacts to streams. Such impacts may be associated with impairment of beneficial uses and degradation of stream condition.

Control approaches have evolved over time, with efforts first focused on managing peak flows and then on matching the peak, volume, and timing of an event hydrograph. The current understanding is that the long term frequency, magnitude, and durations of the range of sediment transporting flows needs to be managed. This can be accomplished through the use of structural BMPs designed to control the duration, frequency, and magnitude of the entire hydrograph from the project (i.e., flow duration control). In-stream measures, such as grade control structures, can also be used to prevent excess erosion due to increased flow durations. In-stream measures are desirable where stream channels are already degraded due to hydromodification caused by existing development.

There are various alternatives for siting hydromodification control measures, including on-site, regional, and in-stream (described later in this section); each of which has advantages and disadvantages. The choice of control measure siting will be strongly determined by site-specific considerations, including existing stream conditions, local development patterns, permitting requirements, and future growth plans.

Control measure sizing is also highly influenced by local characteristics including rainfall, climate, soils, topography, geology, and stream type. These factors determine the extent to which development changes the natural hydrologic processes and the potential for stream impacts. Therefore, hydromodification management requires a suite of strategies that are tailored to local circumstances and stream conditions.

Maintenance is key to sustaining the performance of hydromodification control measures and these concerns will factor into decisions on control measure siting and the implementation of easements or maintenance agreements between municipalities and property owners. Local jurisdictions may reject or require that a proposed hydromodification control measure be modified in order to ensure that control measures can be reasonably maintained.

5.3. System Design to Address HCOCs in North Orange County

This section describes an approach for developing a hydromodification control design to address HCOCs in the North Orange County permit area. This section is intended to be used following the LID and treatment control system design process. The LID and treatment control system design process requires on-site retention and biotreatment to the extent feasible, followed by consideration of off-site LID options and treatment controls.

Figure 5.1 illustrates the general approach for developing a hydromodification control design to address HCOCs in the North Orange County permit area.

5.3.1. Determine Whether HCOCs Exist

HCOCs in the North Orange County permit area can be mitigated by managing runoff such that the post-development runoff volume for the 2-year, 24-hr storm event ($V_{2\text{-yr, POST}}$) does not exceed that of the pre-development condition ($V_{2\text{-yr, PRE}}$) by more than 5%. This can be expressed as:

$$(V_{2\text{-yr, POST}} / V_{2\text{-yr, PRE}}) \leq 1.05$$

The post-development time of concentration (T_c) must also be managed such that:

$$(T_{C2\text{-yr, POST}} / T_{C2\text{-yr, PRE}}) \leq 1.05 \text{ (See **Footnote 4**)}$$

Site design, HSCs, LID BMPs, and treatment control BMPs will contribute to meeting hydromodification control requirements. The volume of runoff retained in LID BMPs serves to reduce $V_{2\text{-yr, POST}}$ and increase $T_{C2\text{-yr, POST}}$ compared to post-developed conditions without stormwater controls.

The LID and treatment control BMPs selected for the project should be evaluated using the hydrologic methods described in [Appendix IV](#) to evaluate the above criteria. In order to achieve their intended function, hydromodification control BMPs must be able to accept runoff from sequential storm events. Therefore, if BMPs draw down in greater than 48 hours, only the portion of the system volume that drains in 48 hours may be counted as retained for the purpose of hydromodification control volume matching calculations. This is a simplified method of accounting for the recovery rate of BMPs that could be refined as part of a project-specific hydrologic analysis.

If the results indicate that HCOCs do not exist, then hydromodification control requirements do not apply. The Project WQMP must document that HCOCs do not exist and provide all supporting calculations/documentation.

Figure 5.1. North Orange County Hydromodification Design Process

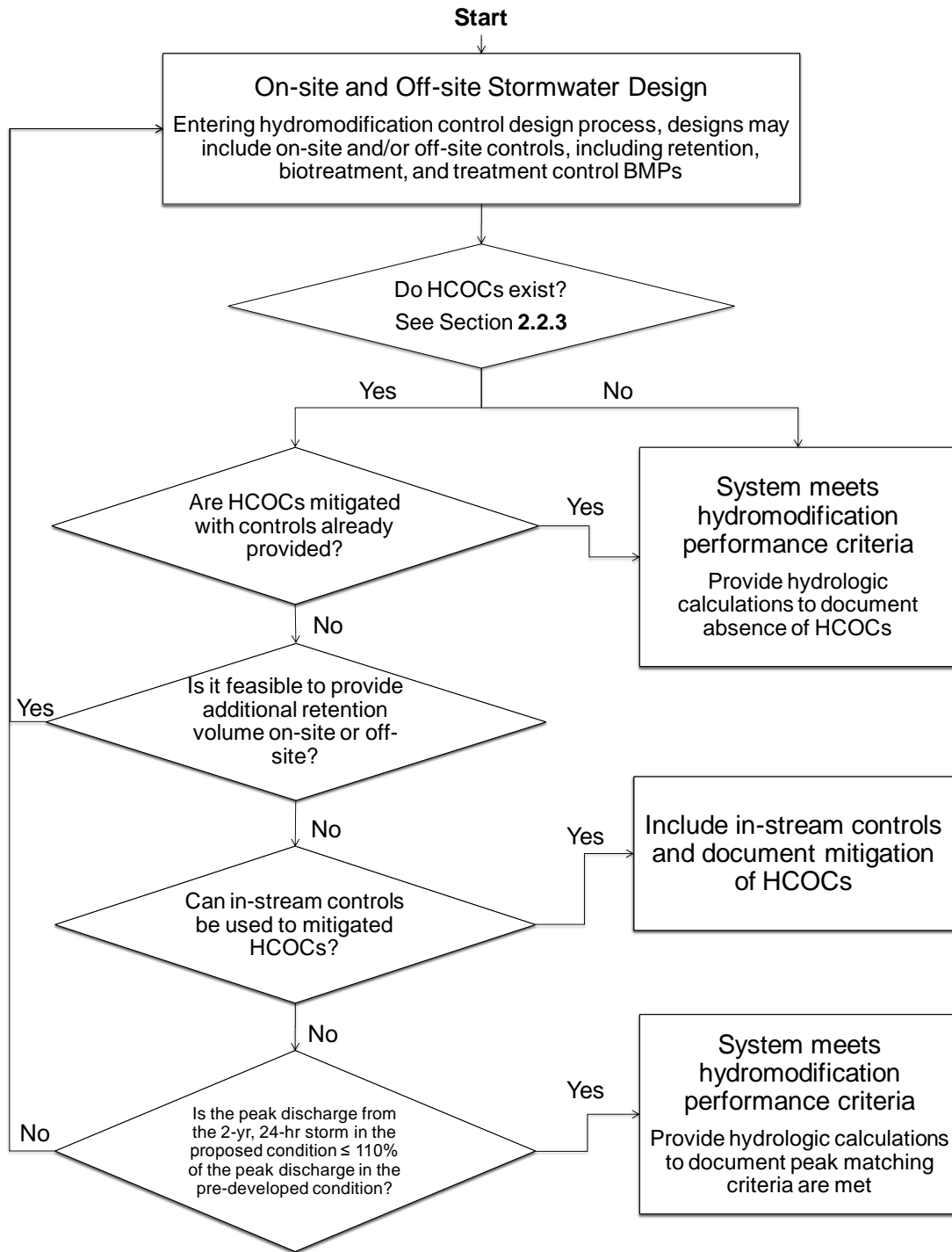

The compliance point for assessment of pre- and post-development runoff volume and time of concentration is located where runoff leaves the project site. However, the project proponent may use this same assessment technique for a point of compliance further downstream as part of a geomorphically-based project-specific evaluation of whether the project will adversely

impact downstream erosion, sedimentation, or stream habitat. For example, if a site is mapped as potentially having a HCOC, but the nearest susceptible channel segment is miles downstream, then the hydromodification impact due to developing the site may be that the project adds negligible amounts of flow to the tail ends of the receiving water's hydrograph and would not result in significant increase in peak flow or significant decrease time of concentration, rendering hydrologic impacts negligible. In this case, it would be appropriate to use a point of analysis located at the nearest susceptible channel for the geomorphically-based impact evaluation. An analysis of the cumulative impacts from other developments that may occur concurrently or in the future may be required for projects as part of the CEQA process.

The rigor of the hydrologic assessment documented in the Project WQMP should be commensurate to the magnitude of potential impacts. If the project would clearly not have significant impacts on the nearest susceptible channel, then a relatively simple hydrologic analysis may be sufficient to demonstrate that HCOCs do not exist.

If HCOCs still exist, then the project proceeds to the next step.

5.3.2. Evaluate Additional On-site and Off-site Controls

The Project WQMP should consider increasing the size of on-site and off-site controls to attempt to meet the volume- and time of concentration-matching criteria expressed in **Section 5.3.1**.

If additional volume can be provided, the project should return to the system design phase and modify designs to add this volume. If additional volume cannot be provided, then the project proceeds to the next step. One could also consider multiple objectives that include HCOCs at the outset of the overall design process to reduce the need for design iterations.

5.3.3. Site Specific Evaluation of In-stream Control Options

A site specific evaluation may be conducted to determine whether opportunity exists to mitigate potential impacts through in-stream controls. The site specific evaluation may find that in-stream controls can be feasibly implemented in combination with on-site and regional controls such that the project will not adversely impact downstream erosion, sedimentation, or stream habitat. If this finding is made, in-stream controls may be designed and included in the Project WQMP along with documentation demonstrating that the project and proposed system will not adversely impact downstream erosion, sedimentation, or stream habitat. This approach, including its effectiveness in addressing HCOCs and the environmental impacts of any in-stream controls must be analyzed by the local jurisdiction pursuant to CEQA and the necessary permits from regulatory agencies must be obtained. The use of instream controls is generally more applicable as part of a watershed-based plan than for a single development project.

5.3.4. Provide Peak Design for Peak Matching

Where the Project WQMP documents that the excess runoff volume from the 2-yr runoff event cannot feasibly be retained, the project must implement on-site or regional hydromodification controls to:

- Retain the excess volume from the 2-yr runoff event to the MEP.
- Reduce post-development runoff 2-yr peak flow rate to no greater than 110% of the pre-development runoff 2-yr peak flow rate.

Hydrologic calculations demonstrating satisfaction of peak matching criteria should be based on methods described in [Appendix IV](#). If the system as proposed cannot satisfy this criterion, the project must return to the system design phase and make the changes necessary such that this criterion is met.

5.4. System Design to Address HCOCs in South Orange County

A separate guidance document and BMP sizing tool has been prepared for implementation of the Interim Hydromodification Control Criteria in the South Orange County Permit: *Technical Guidance Document For The South Orange County Hydromodification Control BMP Sizing Tool* (provided in [Appendix V](#)). A Hydromodification Management Plan will be available for South Orange County in December 2011.

5.5. Hydromodification Control BMPs

5.5.1. On-Site / Distributed Controls

A variety of volume / flow management structural BMPs are available that utilize the following two basic principles:

- Detain runoff and release it in a controlled way that either mimics pre-development flow rates and durations or reduces flow rates and durations to account for a reduction in sediment supply.
- Manage excess runoff volumes through one or more of the following pathways: infiltration, ET, storage and use, discharge at a rate below the critical rate for adverse impact, or discharge downstream to a non-susceptible water body.

Distributed facilities are small scale facilities, typically treating runoff from less than ten acres. These types of facilities include, but are not limited to, bioretention areas, permeable pavement, green roofs, cisterns, vegetated swales, and filter strips. These types of facilities will also help to achieve the LID performance standard.

Design guidance for on-site controls LID BMPs and treatment control BMPs are provided in [Section 4](#).

5.5.2. Detention/Retention Basins

Detention/retention basins are stormwater management facilities that are designed to detain and infiltrate runoff from one or multiple projects or project areas. These basins are typically shallow with flat, vegetated bottoms. Detention/retention basins can be constructed by either excavating a depression or building a berm to create above ground storage, such that runoff can drain into the basin by gravity. Runoff is stored in the basin as well as in the pore spaces of the surface soils. Pretreatment BMPs such as swales, filter strips, and sedimentation forebays minimize fine sediment loading to the basins, thereby reducing maintenance frequencies.

Detention/retention basins for hydromodification management incorporate outlet structures designed for flow duration control. These basins can also be designed to support flood control and water quality treatment objectives in addition to hydromodification. If underlying soils are not suitable for infiltration, the basin may be designed for flow detention only, with alternative practices to manage increased volumes, such as storage and use, discharge at a rate below the critical rate for adverse impacts, or discharge to a non-susceptible water body.

Detention/retention basins should be designed to receive flows from developed areas only, for both design optimization as well as to avoid intercepting coarse sediments from open spaces that should ideally be passed through to the stream channel. Reduction in coarse sediment loads contributes to downstream channel instability.

5.5.3. In-Stream Controls

Hydromodification management can also be achieved by in-stream controls, including drop structures, bed and bank reinforcement, and grade control structures.

5.5.3.1. Drop Structures

Drop structures are designed to reduce the channel slope, thereby reducing the shear stresses generated by stream flows. These controls can be incorporated as natural appearing rock structures with a step-pool design which allows drop energy to be dissipated in the pools while providing a reduced longitudinal slope between structures.

5.5.3.2. Grade Control Structures

Grade control structures are designed to maintain the existing channel slope while allowing for minor amounts of local scour. These control measures are often buried and would entail a narrow trench across the width of the stream backfilled with concrete or similar material, as well as the creation of a “plunge pool” feature on the downstream side of the sill by placing boulders and vegetation. A grade control option provides a reduced footprint and impact compared to drop structures, which are designed to alter the channel slope.

5.5.3.3. Bed and Bank Reinforcement

Channel reinforcement serves to increase bed and bank resistance to stream flows. In addition to conventional techniques such as riprap and concrete, a number of vegetated approaches are increasingly utilized, including products such as vegetated reinforcement mats. This technology provides erosion control with an open-weave material that stabilizes bed and bank surfaces and allows for re-establishment of native plants, which serves to further increase channel stability.

SECTION 6. SOURCE CONTROL MEASURES

This section provides guidance on the selection and design of structural source control measures.

6.1. Introduction

Source Control BMPs reduce the potential for stormwater runoff and pollutants from coming into contact with one another. Source Control BMPs are defined as any administrative action, design of a structural facility, usage of alternative materials, and operation, maintenance, inspection, and compliance of an area to eliminate or reduce stormwater pollution. Each new development and significant redevelopment project is required to implement appropriate Source Control BMP(s) pursuant to Section 2.4.5 of the [Model WQMP](#).

Applicable Source Control BMPs (which includes subcategories of routine non-structural BMPs, routine structural BMPs and BMPs for individual categories/project features) are required to be incorporated into all new development and significant redevelopment projects regardless of their priority, including those identified in an applicable regional or watershed program, unless they do not apply due to the project characteristics. California Stormwater Quality Association (CASQA) BMP Fact Sheet numbers are included in parentheses where applicable.

6.2. Non-Structural Measures

N1 Education for Property Owners, Tenants and Occupants

For developments with no Property Owners Association (POA) or with POAs of less than fifty (50) dwelling units, practical information materials will be provided to the first residents/occupants/tenants on general housekeeping practices that contribute to the protection of stormwater quality. These materials will be initially developed and provided to first residents/occupants/tenants by the developer. Thereafter such materials will be available through the Permittees' education program. Different materials for residential, office commercial, retail commercial, vehicle-related commercial and industrial uses will be developed.

For developments with POA and residential projects of more than fifty (50) dwelling units, project conditions of approval will require that the POA periodically provide environmental awareness education materials, made available by the municipalities, to all of its members. Among other things, these materials will describe the use of chemicals (including household type) that should be limited to the property, with no discharge of wastes via hosing or other direct discharge to gutters, catch basins and storm drains. Educational materials available from the County of Orange can be downloaded here:

<http://www.ocwatersheds.com/PublicEd/resources/default.aspx>

N2 Activity Restrictions

If a POA is formed, conditions, covenants and restrictions (CCRs) must be prepared by the developer for the purpose of surface water quality protection. An example would be not allowing car washing outside of established community car wash areas in multi-unit complexes. Alternatively, use restrictions may be developed by a building operator through lease terms, etc. These restrictions must be included in the Project WQMP.

N3 (SC-73) Common Area Landscape Management

Identify on-going landscape maintenance requirements that are consistent with those in the County Water Conservation Resolution (or city equivalent) that include fertilizer and/or pesticide usage consistent with Management Guidelines for Use of Fertilizers (DAMP Section 5.5). Statements regarding the specific applicable guidelines must be included in the Project WQMP.

N4 BMP Maintenance

The Project WQMP shall identify responsibility for implementation of each non-structural BMP and scheduled cleaning and/or maintenance of all structural BMP facilities.

N5 Title 22 CCR Compliance

Compliance with Title 22 of the California Code of Regulations (CCR) and relevant sections of the California Health & Safety Code regarding hazardous waste management is enforced by County Environmental Health on behalf of the State. The Project WQMP must describe how the development will comply with the applicable hazardous waste management section(s) of Title 22.

N6 Local Water Quality Permit Compliance

The Permittees, under the Water Quality Ordinance, may issue permits to ensure clean stormwater discharges from fuel dispensing areas and other areas of concern to public properties.

N7 (SC-11) Spill Contingency Plan

A Spill Contingency Plan is prepared by building operator or occupants for use by specified types of building or suite occupancies. The Spill Contingency Plan describes how the occupants will prepare for and respond to spills of hazardous materials. Plans typically describe stockpiling of cleanup materials, notification of responsible agencies, disposal of cleanup materials, documentation, etc.

N8 Underground Storage Tank Compliance

Compliance with State regulations dealing with underground storage tanks, enforced by County Environmental Health on behalf of State.

N9 Hazardous Materials Disclosure Compliance

Compliance with Permittee ordinances typically enforced by respective fire protection agencies for the management of hazardous materials. The Orange County, health care agencies, and/or other appropriate agencies (i.e., Department of Toxics Substances Control) are typically responsible for enforcing hazardous materials and hazardous waste handling and disposal regulations.

N10 Uniform Fire Code Implementation

Compliance with Article 80 of the Uniform Fire Code enforced by fire protection agency.

N11 (SC-60) Common Area Litter Control

For industrial/commercial developments and for developments with POAs, the owner/POA should be required to implement trash management and litter control procedures in the common areas aimed at reducing pollution of drainage water. The owner/POA may contract with their landscape maintenance firms to provide this service during regularly scheduled maintenance, which should consist of litter patrol, emptying of trash receptacles in common areas, and noting trash disposal violations by tenants/homeowners or businesses and reporting the violations to the owner/POA for investigation.

N12 Employee Training

Education program (see N1) as it would apply to future employees of individual businesses. Developer either prepares manual(s) for initial purchasers of business site or for development that is constructed for an unspecified use makes commitment on behalf of POA or future business owner to prepare. An example would be training on the proper storage and use of fertilizers and pesticides, or training on the implementation of hazardous spill contingency plans.

N13 (SD-31) Housekeeping of Loading Docks

Loading docks typically found at large retail and warehouse-type commercial and industrial facilities should be kept in a clean and orderly condition through a regular program of sweeping and litter control and immediate cleanup of spills and broken containers. Cleanup procedures should minimize or eliminate the use of water if plumed to the storm sewer. If wash water is used, it must be disposed of in an approved manner and not discharged to the storm drain system. If there are no other alternatives, discharge of non-stormwater flow to the sanitary sewer must be at an acceptable discharge point such as a cleanout, oil/water separator, grease interceptor, or industrial sewer connection. All sewer discharges shall be in accordance with the Orange County Sanitation District's Wastewater Discharge Regulations and/or Washwater Disposal Guidelines.

N14 (SC-74) Common Area Catch Basin Inspection

For industrial/commercial developments and for developments with privately maintained drainage systems, the owner is required to have at least 80 percent of drainage facilities inspected, cleaned and maintained on an annual basis with 100 percent of the facilities included in a two-year period. Cleaning should take place in the late summer/early fall prior to the start of the rainy season. Drainage facilities include catch basins (storm drain inlets) detention basins, retention basins, sediment basins, open drainage channels and lift stations. Records should be kept to document the annual maintenance.

N15 (SC-43, SC-70) Street Sweeping Private Streets and Parking Lots

Streets and parking lots are required to be swept prior to the storm season, in late summer or early fall, prior to the start of the rainy season or equivalent as required by the governing jurisdiction.

N16 (SD-30, SC-20) Retail Gasoline Outlets

Retail gasoline outlets (RGOs) are required to follow the guidelines of this TGD and Model WQMP and non-structural source control operations and maintenance BMPs shown in the CASQA Structural Source Control Fact Sheet SD-30, and Non-structural Source Control Fact Sheet (SC-20).

Other Non-structural Measures for Public Agency Projects

As required by the Model WQMP other non-structural measures shall be implemented and included in the Project WQMP as applicable for new public agency Priority Projects as described in the Municipal Activity fact sheets <http://www.ocwatersheds.com/MunicipalActivities.aspx>. These include BMPs FF-1 through FF-13 for Fixed Facilities and DF-1 for Drainage Facilities. These are listed in **Section 6.4**, below.

6.3. Structural Measures

The following measures are applicable to all project types. CASQA BMP Fact Sheet numbers are included in parentheses where applicable; these fact sheets provide further detail on these BMPs.

S1 (SD-13) Provide Storm Drain System Stenciling and Signage

Storm drain stencils are highly visible source control messages, typically placed directly adjacent to storm drain inlets. The stencils contain a brief statement that prohibits the dumping of improper materials into the municipal storm drain system. Graphical icons, either illustrating anti-dumping symbols or images of receiving water fauna, are effective supplements to the anti-dumping message. Stencils and signs alert the public to the destination of pollutants discharged into stormwater. The following requirements should be included in the project design and shown on the project plans:

1. Provide stenciling or labeling of all storm drain inlets and catch basins, constructed or modified, within the project area with prohibitive language (such as: “NO DUMPING-DRAINS TO OCEAN”) and/or graphical icons to discourage illegal dumping.
2. Post signs and prohibitive language and/or graphical icons, which prohibit illegal dumping at public access points along channels and creeks within the project area.
3. Maintain legibility of stencils and signs.

See CASQA Stormwater Handbook BMP Fact Sheet SD-13 for additional information.

S2 (SD-34) Design Outdoor Hazardous Material Storage Areas to Reduce Pollutant Introduction

Improper storage of materials outdoors may increase the potential for toxic compounds, oil and grease, fuels, solvents, coolants, wastes, heavy metals, nutrients, suspended solids, and other pollutants to enter the municipal storm drain system. Where the plan of development includes outdoor areas for storage of hazardous materials that may contribute pollutants to the municipal storm drain system, or include transfer areas where incidental spills often occur, the following stormwater BMPs are required:

1. Hazardous materials with the potential to contaminate urban runoff shall either be: (1) placed in an enclosure such as, but not limited to, a cabinet, shed, or similar structure that prevents contact with storm water or spillage to the municipal storm drain system; or (2) protected by secondary containment structures (not double wall containers) such as berms, dikes, or curbs.
2. The storage area shall be paved and sufficiently impervious to contain leaks and spills.
3. The storage area shall have a roof or awning to minimize direct precipitation and collection of stormwater within the secondary containment area.
4. Any stormwater retained within the containment structure must not be discharged to the street or storm drain system.
5. Location(s) of installations of where these preventative measures will be employed must be included on the map or plans identifying BMPs.

See CASQA Stormwater Handbook Section 3.2.6 and BMP Fact Sheet SD-34 for additional information.

S3 (SD-32) Design Trash Enclosures to Reduce Pollutant Introduction

Design trash storage areas to reduce pollutant introduction. All trash container areas shall meet the following requirements (limited exclusion: detached residential homes):

1. Paved with an impervious surface, designed not to allow run-on from adjoining areas, designed to divert drainage from adjoining roofs and pavements diverted around the area, screened or walled to prevent off-site transport of trash; and
2. Provide solid roof or awning to prevent direct precipitation.

Connection of trash area drains to the municipal storm drain system is prohibited.

Potential conflicts with fire code and garbage hauling activities should be considered in implementing this source control.

See CASQA Stormwater Handbook Section 3.2.9 and BMP Fact Sheet SD-32 for additional information.

S4 (SD-12) Use Efficient Irrigation Systems and Landscape Design

Projects shall design the timing and application methods of irrigation water to minimize the runoff of excess irrigation water into the municipal storm drain system. (Limited exclusion: detached residential homes.) The following methods to reduce excessive irrigation runoff shall be considered, and incorporated on common areas of development and other areas where determined applicable and feasible by the Permittee:

1. Employing rain shutoff devices to prevent irrigation after precipitation.
2. Designing irrigation systems to each landscape area's specific water requirements.
3. Using flow reducers or shutoff valves triggered by a pressure drop to control water loss in the event of broken sprinkler heads or lines.
4. Implementing landscape plan consistent with County Water Conservation Resolution or city equivalent, which may include provision of water sensors, programmable irrigation times (for short cycles), etc.
5. The timing and application methods of irrigation water shall be designed to minimize the runoff of excess irrigation water into the municipal storm drain system.
6. Employing other comparable, equally effective, methods to reduce irrigation water runoff.
7. Group plants with similar water requirements in order to reduce excess irrigation runoff and promote surface filtration. Choose plants with low irrigation requirements (for example, native or drought tolerant species). Consider other design features, such as:
 - Use mulches (such as wood chips or shredded wood products) in planter areas without ground cover to minimize sediment in runoff.
 - Install appropriate plant materials for the location, in accordance with amount of sunlight and climate, and use native plant material where possible and/or as recommended by the landscape architect.
 - Leave a vegetative barrier along the property boundary and interior watercourses, to act as a pollutant filter, where appropriate and feasible.
 - Choose plants that minimize or eliminate the use of fertilizer or pesticides to sustain growth.

Irrigation practices shall comply with local and statewide ordinances related to irrigation efficiency.

S5 Protect Slopes and Channels

Projects shall protect slopes and channels as described in **Section 3.4** of this TGD.

S6 (SD-31) Loading Dock Areas

Loading /unloading dock areas shall include the following:

1. Cover loading dock areas, or design drainage to preclude run-on and runoff, unless the material loaded and unloaded at the docks does not have potential to contribute to stormwater pollution, and this use is ensured for the life of the facility.
2. Direct connections to the municipal storm drain system from below grade loading docks (truck wells) or similar structures are prohibited. Stormwater can be discharged through a permitted connection to the storm drain system with a treatment control BMP applicable to the use.
3. Other comparable and equally effective features that prevent unpermitted discharges to the municipal storm drain system.
4. Housekeeping of loading docks shall be consistent with N13.

See CASQA Stormwater Handbook Section 3.2.8 for additional information.

S7 (SD-31) Maintenance Bays

Maintenance bays shall include the following:

1. Repair/maintenance bays shall be indoors; or, designed to preclude urban run-on and runoff in an equally effective manner.
2. Design a repair/maintenance bay drainage system to capture all wash water, leaks and spills. Provide impermeable berms, drop inlets, trench catch basins, or overflow containment structures around repair bays to prevent spilled materials and wash-down waters from entering the storm drain system. Connect drains to a sump for collection and disposal. Direct connection of the repair/maintenance bays to the municipal storm drain system is prohibited. If there are no other alternatives, discharge of non-stormwater flow to the sanitary sewer may be considered only if allowed by the local sewerage agency through permitted connection.

Other features which are comparable and equally effective that prevent discharges to the municipal storm drain system without appropriate permits.

See CASQA Stormwater Handbook Fact Sheet SD-31 for additional information.

S8 (SD-33) Vehicle Wash Areas

Projects that include areas for washing /steam cleaning of vehicles shall use the following:

1. Self-contained or covered with a roof or overhang.
2. Equipped with a wash racks, and with the prior approval of the sewerage agency (Note: Discharge monitoring may be required by the sewerage agency).
3. Equipped with a clarifier or other pretreatment facility.

4. If there are no other alternatives, discharge of non-stormwater flow to the sanitary sewer may be considered only allowed by the local sewerage agency through permitted connection. Alternately, non-storm water discharges may require a separate NPDES permit in order to discharge to the MS4. Some local jurisdictions also have permitting systems in place for these situations.
5. Other features which are comparable and equally effective that prevent unpermitted discharges, to the municipal storm drain system.

See CASQA Stormwater Handbook Sections 3.2.7 and 3.2.10 and Fact Sheet SD-33 for additional information.

S9 (SD-36) Outdoor Processing Areas

Outdoor process equipment operations, such as rock grinding or crushing, painting or coating, grinding or sanding, degreasing or parts cleaning, landfills, waste piles, and wastewater and solid waste handling, treatment, and disposal, and other operations determined to be a potential threat to water quality by the Permittee shall adhere to the following requirements.

1. Cover or enclose areas that would be the sources of pollutants; or, slope the area toward a sump that will provide infiltration or evaporation with no discharge; or, if there are no other alternatives, discharge of non-stormwater flow to the sanitary sewer may be considered only allowed by the local sewerage agency through permitted connection.
2. Grade or berm area to prevent run-on from surrounding areas.
3. Installation of storm drains in areas of equipment repair is prohibited.
4. Other features which are comparable or equally effective that prevent unpermitted discharges to the municipal storm drain system.
5. Where wet material processing occurs (e.g. Electroplating), secondary containment structures (not double wall containers) shall be provided to hold spills resulting from accidents, leaking tanks or equipment, or any other unplanned releases (Note: If these are plumbed to the sanitary sewer, the structures and plumbing shall be in accordance with Section 7.II - 8, Attachment D, and with the prior approval of the sewerage agency). Design of secondary containment structures shall be consistent with "Design of Outdoor Material Storage Areas to Reduce Pollutant Introduction".

Some of these land uses (e.g. landfills, waste piles, wastewater and solid waste handling, treatment and disposal) may be subject to other permits including Phase I Industrial Permits that may require additional BMPs.

See CASQA Stormwater Handbook Section 3.2.5 for additional information.

S10 Equipment Wash Areas

Outdoor equipment/accessory washing and steam cleaning activities shall use the following:

1. Be self-contained or covered with a roof or overhang.

2. Design an equipment wash area drainage system to capture all wash water. Provide impermeable berms, drop inlets, trench catch basins, or overflow containment structures around equipment wash areas to prevent wash-down waters from entering the storm drain system. Connect drains to a sump for collection and disposal. Discharge from equipment wash areas to the municipal storm drain system is prohibited. If there are no other alternatives, discharge of non-stormwater flow to the sanitary sewer may be considered, but only when allowed by the local sewerage agency through a permitted connection.
3. Other comparable or equally effective features that prevent unpermitted discharges to the municipal storm drain system.

S11 (SD-30) Fueling Areas

Fuel dispensing areas shall contain the following:

1. At a minimum, the fuel dispensing area must extend 6.5 feet (2.0 meters) from the corner of each fuel dispenser, or the length at which the hose and nozzle assembly may be operated plus 1 foot (0.3 meter), whichever is less.
2. The fuel dispensing area shall be paved with Portland cement concrete (or equivalent smooth impervious surface). The use of asphalt concrete shall be prohibited.
3. The fuel dispensing area shall have an appropriate slope (2% - 4%) to prevent ponding, and must be separated from the rest of the site by a grade break that prevents run-on of stormwater.
4. An overhanging roof structure or canopy shall be provided. The cover's minimum dimensions must be equal to or greater than the area of the fuel dispensing area in the first item above. The cover must not drain onto the fuel dispensing area and the downspouts must be routed to prevent drainage across the fueling area. The fueling area shall drain to the project's Treatment Control BMP(s) prior to discharging to the municipal storm drain system.

See CASQA Stormwater Handbook Section 3.2.11 and BMP Fact Sheet SD-30 for additional information.

S12 (SD-10) Site Design and Landscape Planning (Hillside Landscaping)

Hillside areas that are disturbed by project development shall be landscaped with deep-rooted, drought tolerant plant species selected for erosion control, satisfactory to the local permitting authority.

S13 Wash Water Controls for Food Preparation Areas

Food establishments (per State Health & Safety Code 27520) shall have either contained areas or sinks, each with sanitary sewer connections for disposal of wash waters containing kitchen and food wastes. If located outside, the contained areas or sinks shall also be structurally covered to prevent entry of stormwater. Adequate signs shall be provided and appropriately placed stating the prohibition of discharging washwater to the storm drain system.

S14 Community Car Wash Racks

In complexes larger than 100 dwelling units where car washing is allowed, a designated car wash area that does not drain to a storm drain system shall be provided for common usage. Wash waters from this area may be directed to the sanitary sewer (with the prior approval of the sewerage agency); to an engineered infiltration system; or to an equally effective alternative. Pre-treatment may also be required.

6.4. Municipal Non-Structural Source Control Measures

The following measures are applicable to fixed facility municipal projects such as maintenance yards, schools, and libraries. Generally, these controls are more applicable to municipal projects than the fact sheets contained in **Section 6.2**, however other structural and nonstructural controls described in **Section 6.2** and **6.3** shall be used where applicable. The links below contain the most recent versions of the Fixed Facility fact sheets, which can also be found at <http://www.ocwatersheds.com/MunicipalActivities.aspx>.

- [FF-1, Bay/Harbor Activities](#)
- [FF-2, Building Maintenance and Repair](#)
- [FF-3 Equipment Maintenance and Repair](#)
- [FF-4, Fueling](#)
- [FF-5, Landscape Maintenance](#)
- [FF-6, Material Loading and Unloading](#)
- [FF-7, Material Storage, Handling, and Disposal](#)
- [FF-8, Minor Construction](#)
- [FF-9, Parking Lot Maintenance](#)
- [FF-10, Spill Prevention and Control](#)
- [FF-11, Vehicle and Equipment Cleaning](#)
- [FF-12, Vehicle and Equipment Storage](#)
- [FF-13, Waste Handling and Disposal](#)

SECTION 7. OPERATION AND MAINTENANCE PLANNING

The sustained performance of BMPs over time depends on ongoing and proper maintenance. In order for this to occur, detailed operation and maintenance plans are needed that include specific maintenance activities and frequencies for each type of BMP. In addition, these should include indicators for assessing when “as needed” maintenance activities are required.

Requirements for operations and maintenance (O&M) planning are described in Section 4.0 of the [Model WQMP](#). Maintenance agreements are one of the available tools described in this section.

This section provides guidance for the components of an effective maintenance agreement and provides references to published BMP maintenance guidelines.

7.1. How to Develop Maintenance Agreements

Maintenance agreements can be an effective tool for ensuring long-term maintenance of on-site BMPs. The most important aspect of creating these maintenance agreements is to clearly define the responsibilities of each party entering into the agreement. Basic language that should be incorporated into an agreement includes the following:

1. Performance of Routine Maintenance

Local governments often find it easier to have a property owner perform all maintenance according to the requirements of a Design Manual. Other communities require that property owners do aesthetic maintenance (i.e., mowing, vegetation removal) and implement Pollution Prevention Plans, but elect to perform structural maintenance and sediment removal themselves.

2. Maintenance Schedules

Maintenance requirements may vary, but usually governments require that all BMP owners perform at least an annual inspection and document that the maintenance and repairs are performed. An annual report must then be submitted to the government, who will to perform an inspection of the facility at a frequency specified in the Permit.

3. Inspection Requirements

Local governments may obligate themselves to perform an annual inspection of a BMP, or may choose to inspect when deemed necessary instead. Local governments may also wish to include language allowing maintenance requirements to be increased if deemed necessary to ensure proper functioning of the BMP.

4. Access to BMPs

The agreement should grant permission to a local government or its authorized agent to enter onto property to inspect BMPs and in response to emergencies (i.e., flooding, etc.). If

deficiencies are noted, the government should then provide a copy of the inspection report to the property owner and provide a timeline for repair of these deficiencies.

5. Failure to Maintain

In the maintenance agreement, the government should repeat the steps available for addressing a failure to maintain situation. Language allowing access to BMPs cited as not properly maintained is essential, along with the right to charge any costs for repairs back to the property owner. The government may wish to include deadlines for repayment of maintenance costs, and provide for liens against property up to the cost of the maintenance plus interest. The relationship between failure to maintain BMPs and potential nuisance issues (vectors, etc.) should be considered in the development of maintenance agreements.

6. Recording of the Maintenance Agreement

An important aspect to the recording of the maintenance agreement is that the agreement be recorded into local deed records. This helps ensure that the maintenance agreement is bound to the property in perpetuity.

Finally, some communities elect to include easement requirements into their maintenance agreements. While easement agreements are often secured through a separate legal agreement, recording public access easements for maintenance in a maintenance agreement reinforces a local government's right to enter and inspect a BMP. Examples of maintenance agreements include several available on the web at <http://www.stormwatercenter.net/>

7.2. How to Develop BMP Maintenance Activities

This section provides general guidance for the development of BMP maintenance activities. The following three factors should be considered:

- What maintenance activities are needed based on BMP design features and operation?
- How frequently should this maintenance be performed, and what conditions should trigger these activities?
- Who are responsible for these activities?

Detailed descriptions of BMP maintenance activities relevant to Southern California are provided in the Los Angeles County Stormwater BMP Operations and Maintenance Manual :

http://dpw.lacounty.gov/DES/design_manuals/StormwaterBMPDesignandMaintenance.pdf

The use of other references are allowed, however care should be taken in the use of published references to ensure that recommendations are appropriate for the Southern California climate.

TECHNICAL GUIDANCE DOCUMENT APPENDICES

TABLE OF CONTENTS

APPENDIX I. SUMMARY OF BMP SIZING REQUIREMENTS FOR NORTH ORANGE COUNTY I-1

- I.1. Introduction to Integrated Structural BMP Sizing Approach in North Orange County I-1
- I.2. Overview of Approach for LID BMP Sizing in North Orange County..... I-3
- I.3. Overview of Approach for Treatment Control BMP Sizing in North Orange County. I-5
- I.4. Overview of Approach for Addressing HCOCs in North Orange County I-5
- I.5. Role of HSCs in BMP Sizing I-7

APPENDIX II. SUMMARY OF BMP SIZING REQUIREMENTS FOR SOUTH ORANGE COUNTY II-1

- II.1. Introduction to Integrated Structural BMP Sizing Approach in South Orange County II-1
- II.2. Overview of Approach for LID BMP Sizing in South Orange County II-2
- II.3. Overview of Approach for Treatment Control BMP Sizing in South Orange County II-4
- II.4. Overview of Approach for Addressing HCOCs in South Orange County II-5
- II.5. Role of HSCs in BMP Sizing II-5
- II.6. Alternative Performance Criteria for Watershed-based Projects in South Orange County..... II-6

APPENDIX III. HYDROLOGIC CALCULATIONS AND SIZING METHODS FOR LID BMPS III-1

- III.1. Hydrologic Methods for Design Capture StormIII-1
- III.2. Exhibits and Nomographs Used for LID and WQDV/WQDF Design Volume CalculationsIII-8
- III.3. Approved Methods for Calculating the LID Design Capture VolumeIII-14
- III.4. Nomograph Methods for BMP Performance EstimationIII-26
- III.5. Sizing Approaches for Treatment Trains and Hybrid Systems.....III-35
- III.6. Technical Basis for Capture Efficiency-based Performance Criterion.....III-36

APPENDIX IV. APPROVED METHODS FOR QUANTIFYING HYDROLOGIC CONDITIONS OF CONCERN (NORTH ORANGE COUNTY)..... IV-1

- IV.1. Hydrologic Method for 2-year Runoff Volume and Peak..... IV-2
- IV.2. Hydrologic Method for Time of Concentration..... IV-3
- IV.3. Hydrologic Calculation Examples with WinTR-55..... IV-4

APPENDIX V. APPROVED METHODS FOR QUANTIFYING HYDROLOGIC CONDITIONS OF CONCERN (SOUTH ORANGE COUNTY)..... V-1

- V.1. Hydromodification Control Flow Duration Control Analysis V-1
- V.2. South Orange County Interim Hydromodification Sizing Tool..... V-2
- V.3. Guidelines for Project-Specific Flow Duration Analysis V-3

APPENDIX VI. APPROVED METHODS FOR CALCULATING ALTERNATIVE COMPLIANCE VOLUME FOR LID VI-1

- VI.1. Calculating Alternative Compliance Volume without Water Quality Credits VI-1
- VI.2. Applying Water Quality Credits to Adjust Alternative Compliance Volume VI-2
- VI.3. Stormwater Quality Design Volume/Flow Calculations for Sizing Treatment Control BMPs for Alternative Compliance VI-5

APPENDIX VII. INFILTRATION RATE EVALUATION PROTOCOL AND FACTOR OF SAFETY RECOMMENDATIONS..... VII-1

- VII.1. Introduction VII-1
- VII.2. Methods for Identifying Areas Potentially Feasible for Infiltration VII-4
- VII.3. Methods for Establishing Design Infiltration Rate VII-7
- VII.4. Considerations for Infiltration Rate Factor of Safety VII-30
- VII.5. References..... VII-36

APPENDIX VIII. GROUNDWATER-RELATED INFILTRATION FEASIBILITY CRITERIA VIII-1

- VIII.1. Intended Use..... VIII-1
- VIII.2. Depth to Groundwater and Mounding Potential..... VIII-1
- VIII.3. Groundwater Plumes VIII-5
- VIII.4. Requirements for BMP Selection by Tributary Land Use Activities..... VIII-7
- VIII.5. Well Head Protection and Septic Systems..... VIII-10
- VIII.6. Stormwater Runoff Pollutants..... VIII-10
- VIII.7. Consultation with Applicable Groundwater Management Agencies VIII-10
- VIII.8. Technical Requirements for Site Specific Study of Infiltration Impacts on Groundwater Quality..... VIII-11

APPENDIX IX. TECHNICAL BASIS FOR GREEN ROOF DESIGN CRITERIA IX-1

- IX.1. Functional Definition of “Self-Retaining” for Green roofs..... IX-1
- IX.2. Analysis Inputs..... IX-2
- IX.3. Analysis Methods..... IX-3
- IX.4. Results..... IX-3

APPENDIX X. HARVEST AND USE DEMAND CALCULATIONS AND FEASIBILITY SCREENING X-1

- X.1. Introduction X-1
- X.2. Harvested Water Demand Calculation..... X-1
- X.3. Planning Level Harvest and Use Feasibility Thresholds..... X-10

APPENDIX XI. CRITERIA FOR DESIGNING BMPs TO ACHIEVE MAXIMUM FEASIBLE RETENTION AND BIOTREATMENT XI-1

- XI.1. Purpose and Intended Use..... XI-1
- XI.2. Criteria for Designing Biotreatment BMPs to Achieve Maximum Feasible Infiltration and ET XI-1
- XI.3. Criteria for Designing BMPs to Achieve Maximum Feasible Retention of the Stormwater Design Volume XI-3

XI.4.	Criteria for Designing BMPs to Result in Maximum Feasible Retention plus Biotreatment of the Stormwater Design Volume	XI-4
XI.5.	Supporting Criteria for Designing BMPs to Achieve Maximum Feasible Retention and Biotreatment	XI-5
APPENDIX XII.	CONCEPTUAL BIOTREATMENT SELECTION, DESIGN, AND MAINTENANCE CRITERIA	XII-1
XII.1.	Definition of Biotreatment BMPs	XII-1
XII.2.	Biotreatment Selection to Address Pollutants of Concern	XII-2
XII.3.	Conceptual Biotreatment Design Requirements	XII-2
XII.4.	Conceptual Biotreatment Operation Requirements	XII-5
XII.5.	Conceptual Biotreatment Maintenance Requirements	XII-6
APPENDIX XIII.	THRESHOLD INCREMENTAL BENEFIT CRITERION	XIII-1
XIII.1.	Intended Application	XIII-1
XIII.2.	Regulatory Basis	XIII-2
XIII.3.	Comparison to Anticipated Performance of Alternative Scenario	XIII-3
APPENDIX XIV.	BMP FACT SHEETS	XIV-1
XIV.1.	Hydrologic Source Control Fact Sheets (HSC)	XIV-3
XIV.2.	Miscellaneous BMP Design Element Fact Sheets (MISC)	XIV-16
XIV.3.	Infiltration BMP Fact Sheets (INF)	XIV-21
XIV.4.	Harvest and Use BMP Fact Sheets (HU)	XIV-46
XIV.5.	Biotreatment BMP Fact Sheets (BIO)	XIV-51
XIV.6.	Treatment Control BMP Fact Sheets (TRT)	XIV-71
XIV.7.	Pretreatment/Gross Solids Removal BMP Fact Sheets (PRE)	XIV-76
APPENDIX XV.	WORKSHEETS	XV-1
APPENDIX XVI.	EXHIBITS	XVI-1
XVI.1.	Rainfall Zones Map	XVI-2
XVI.2.	Infiltration Feasibility Constraints Maps	XVI-3
XVI.3.	North Orange County Hydromodification Susceptibility Maps	XVI-4
APPENDIX XVII.	SUPPORTING INFORMATION RELATIVE TO SANITARY SEWER INFLOW AND INFILTRATION	XVII-1

TABLES

Table III.1:	Fraction of Average Long Term Runoff Reduced (Capture Efficiency) by HSCs	III-6
Table III.2:	SWMM Simulation Input Parameters	III-38
Table VI.1:	Table of Multipliers for Computing Remaining Design Storm Intensity	VI-6
Table VII.1:	Recommended Infiltration Investigation Methods	VII-2
Table VII.2:	Definition of Project Size Categories	VII-6
Table VII.3:	Suitability Assessment Related Considerations for Infiltration Facility Safety Factors	VII-31
Table VII.4:	Design Related Considerations for Infiltration Facility Safety Factors	VII-33

Table VIII.1: Recommendations/Requirements for BMP Selection to Minimize Groundwater Quality Impacts VIII-9

Table VIII.2: Definition of Project Size Categories VIII-12

Table IX.1: Green Roof Moisture Retention Depth Required for 40 Percent Volume Reduction, Los Angeles/Orange County IX-4

Table X.1: Toilet and Urinal Water Usage per Resident or Employee X-3

Table X.2: Monthly Reference ET Rates for Orange County (Inches)..... X-5

Table X.3: Species, Density, and Microclimate Factors from WUCOLs for High, Moderate, Low and Very Low Water Use Plant Palettes X-6

Table X.4: Planning Level Recommendations for Landscape Coefficient (KL) X-7

Table X.5: Modified EWUA Daily Average Irrigation Demand by Location and Landscape Coefficient X-7

Table X.6: Harvested Water Demand Thresholds for Minimum Partial Capture X-11

Table X.7: Minimum TUTIA for Minimum Partial Capture X-12

Table X.8: Minimum Irrigated Area for Potential Partial Capture Feasibility X-13

Table XI.1: Recommended Minimum Criteria for Site Design..... XI-6

Table XIII.1: Volume Reduction Summary of Biotreatment BMP Categories in the International Stormwater BMP Database XIII-4

Table XIV.1: Proprietary Hydrodynamic Device Manufacturer Websites XIV-77

Table XIV.2: Proprietary Catch Basin Insert Manufacturer Websites XIV-78

FIGURES

Figure III.1. Design Capture Rainfall Zones in Orange County III-10

Figure III.2. Capture Efficiency Nomograph for Constant Drawdown Systems in Orange County III-11

Figure III.3. Capture Efficiency Nomograph for Harvest and Use Systems with Irrigation Demand in Orange County III-12

Figure III.4. Capture Efficiency Nomograph for Off-line Flow-based Systems in Orange County III-13

Figure III.5 Graphical Operations Supporting Example III.6 III-19

Figure III.6 Graphical Operations Supporting Example III.7 III-23

Figure III.7 Graphical Operations Supporting Example III.8 III-28

Figure IV.1: WinTR-55 home screen..... IV-5

Figure IV.2: WinTR-55 Storm Data screen..... IV-6

Figure IV.3: WinTR-55 Land Use Details screen..... IV-7

Figure IV.4: WinTR-55 Time of Concentration Details screen..... IV-8

Figure IV.5: WinTR-55 Run Model screen..... IV-9

Figure IV.6: WinTR-55 Hydrograph Peak/Peak Timetable screen IV-10

Figure IV.7: WinTR-20 Printed Page File screen..... IV-11

Figure IV.8: WinTR-55 Proposed Condition Land Use Details screen..... IV-12

Figure IV.9: Existing and proposed hydrographs IV-14

Figure V.1. Example Flow Duration Chart..... V-2

Figure VI.1: Lookup Graph for Fraction of Design Capture Storm Depth Remaining..... VI-2

Figure VII.1. Photo of Single Ring Infiltrometer..... VII-11

Figure VII.2. Single Ring Infiltrometer Construction..... VII-12

Figure VII.3. Single Ring Infiltrometer Setup with Mariotte Tube VII-13

Figure VII.4. Sample Test Data Form for Single Ring Infiltrometer Test..... VII-14

Figure VII.5. Photo of Simple Double Ring Infiltrometer VII-16

Figure VII.6. Photo of Pre-fabricated Double Ring Infiltrometer..... VII-16

Figure VII.7. Mariotte Tube VII-17

Figure VII.8. Double Ring Infiltrometer Construction..... VII-18

Figure VII.9. Double Ring Setup with Mariotte Tubes VII-19

Figure VII.10. Double Ring Infiltrometer Set-up with Mariotte Tubes VII-19

Figure VII.11. Double Ring Infiltrometer Set-up for Test at Basin Surface Elevation..... VII-20

Figure VII.12. Sample Test Data Form for Double Ring Infiltrometer Test..... VII-21

Figure VII.13. Typical Well Permeameter Test Installation VII-22

Figure VII.14. Well Permeameter Test Equipment..... VII-23

Figure VII.15. Test Pit for Shallow Percolation Test..... VII-25

Figure VII.16. Test Pit for Deep Percolation Test..... VII-26

Figure VII.17. Photo of Percolation Test Pit. VII-27

Figure VII.18. Sample Test Data Form for Percolation Test..... VII-28

Figure VIII.1: Example Calculations of Maximum Mounding Height by Facility Configuration from USGS Calculator (Carlton, 2010) VIII-5

Figure VIII.2: North Orange County Groundwater Basin Protection Boundary and Plume Protection Boundaries (See Figure XVI.2f for high resolution exhibit) VIII-8

Figure IX.1: Green Roof Performance Relationships for Los Angeles and Orange County, Landscape Coefficient (K_L) = 0.5 (Low water use plant palette) IX-5

Figure IX.2: Green Roof Performance Relationships for Los Angeles and Orange County, Landscape Coefficient (K_L) = 0.75 (Moderate water use plant palette)..... IX-6

Figure X.1: Harvest and Use Sizing Nomograph X-8

Figure XIV.1: Schematic Diagram of Permeable Pavement without Underdrains..... XIV-40

Figure XVI.1: Orange County Rainfall Zones Map..... XVI-2

Figure XVI.2: Infiltration Feasibility Constraints Maps..... XVI-3

Figure XVI.3: North Orange County Hydromodification Susceptibility Maps..... XVI-4

EXAMPLES

Example III.1: Design Runoff Volume Calculation using Simple Runoff Coefficient Method..III-2

Example III.2: Back-computing Storm Depth from Runoff VolumeIII-3

Example III.3: Hydrologic Source Control Calculation Form (Worksheet A).....III-5

Example III.4: Accounting for HSCs in Hydrologic Calculations.....III-6

Example III.5: Computing DCV using Simple MethodIII-14

Example III.6: Computing Design Criteria to Achieve Target Capture Efficiency, Bioretention BMPIII-18

Example III.7: Sizing to Achieve Target Average Annual Capture Efficiency, Flow-based BMPsIII-22

Example III.8: Determining the Capture Efficiency of a Volume-based, Constant Drawdown BMP Based on Description of SystemIII-27

Example IV.1: Computing Volume and Peak Flowrate Using WinTR-55 IV-4

Example IV.2: Computing Time of Concentration using TR-55 Methods IV-12

Example VI.1: Calculating Remaining LID Volume for Alternative Compliance VI-1

Example VI.2: Calculating Water Quality Credits for Projects Reducing Imperviousness..... VI-3

Example VI.3: Applying Water Quality Credits to Reduce Alternative Compliance Volume . VI-4

Example VI.4: Computing the Required Design Flowrate to Mitigate Remaining Alternative Compliance Volume VI-6

Example VII.1: Percolation Rate Conversion Example VII-29

Example VIII.1: Application of USGS Groundwater Mounding Tool Using a Hypothetical Range of Infiltration Scenarios VIII-4

WORKSHEETS

Worksheet A: Hydrologic Source Control Calculation FormIII-7

Worksheet B: Simple Design Capture Volume Sizing MethodIII-16

Worksheet C: Capture Efficiency Method for Volume-Based, Constant Drawdown BMPs...III-20

Worksheet D: Capture Efficiency Method for Flow-Based BMPs.....III-24

Worksheet E: Determining Capture Efficiency of Volume Based, Constant Drawdown BMP based on Design VolumeIII-29

Worksheet F: Determining Capture Efficiency of a Flow-based BMP based on Treatment CapacityIII-33

Worksheet G: Alternative Compliance Volume Worksheet VI-7

Worksheet H: Factor of Safety and Design Infiltration Rate and Worksheet..... VII-35

Worksheet I: Summary of Groundwater-related Feasibility Criteria VIII-13

Worksheet J: Summary of Harvested Water Demand and Feasibility X-13

APPENDIX I. SUMMARY OF BMP SIZING REQUIREMENTS FOR NORTH ORANGE COUNTY

The purpose of this appendix is to provide a concise overview of the BMP sizing requirements for Priority Projects in the North Orange County Permit Area. This summary is not intended to supersede the regulatory requirements contained in Section 2.4 of the [Model WQMP](#) or establish new/additional performance criteria. Rather, this summary is intended to provide functional descriptions of how these requirements are anticipated to be applied in the majority of projects. This summary is organized as follows:

- [Introduction to Integrated Structural BMP Sizing Approach in North Orange County](#)
- [Overview of Approach for LID BMP Sizing in North Orange County](#)
- [Overview of Approach for Treatment Control BMP Sizing in North Orange County](#)
- [Overview of Approach for Addressing HCOCs in North Orange County](#)
- [Role of HSCs in BMP Sizing](#)

I.1. Introduction to Integrated Structural BMP Sizing Approach in North Orange County

Priority Projects in the North Orange County Permit Area are required to implement LID, treatment control, and hydromodification control BMPs to achieve numeric performance criteria described in Section 2.4 of the [Model WQMP](#). While Priority Projects must demonstrate compliance with LID, treatment control, and hydromodification control requirements separately, these provisions overlap significantly and some BMPs may fulfill or partially fulfill a portion of one or more of these requirements.

The relative role that the LID, treatment control, and hydromodification performance standards have on BMP sizing requirements depends on the existing condition of the site, the receiving water hydromodification susceptibility, and whether the project claims water quality credits. Depending on how these factors combine, different sizing standards will control the sizing of BMPs for the project. The term *stormwater design volume* is used to refer to the controlling sizing standard. This is not a precise term, as it varies from project to project depending on the controlling sizing standard.

Three distinct conditions relative to BMP sizing are anticipated to exist most commonly:

1. **HCOC-controlled.** This condition applies to projects that discharge to receiving waters susceptible to hydromodification and increase imperviousness such that the difference in runoff volume from the 2-year, 24-hour storm from pre- to post-project is greater than the runoff volume from the 85th percentile storm depth (i.e., the LID Design Capture

Volume, DCV) by at least 5 percent. In this case, the controlling *stormwater design volume* is the difference in the 2-year runoff volume (delta 2-year volume).

$$\text{Delta 2-yr volume} > \text{DCV} = \text{WQDV}$$

Design approach: design BMPs to retain the delta 2-yr volume. This will generally address all other applicable sizing criteria.

Alternate path: If full retention of the delta 2-yr volume is not feasible and a treated discharge is required, then select a biotreatment BMP to address pollutants of concern, and design it to treat the remaining DCV to the MEP. Design the biotreatment BMP with sufficient storage volume and hydraulic controls to match the peak flow from the 2-year storm to within 10 percent of the pre-project peak.

2. **DCV-controlled.** This condition applies to projects that do not have susceptible receiving waters, do not increase imperviousness, or increase imperviousness slightly such that the DCV is more than 95 percent of the delta 2-yr volume. In this case, the controlling *stormwater design volume* is the DCV.

$$\text{DCV} = \text{WQDV} > \text{Delta 2-yr volume}$$

Design approach: design BMPs to retain the DCV. This will generally address all other applicable sizing criteria.

Contingencies: If full retention is not possible, retain to the MEP, select a biotreatment BMP to address pollutants of concern, and design biotreatment for the remaining DCV to the MEP. Design the biotreatment BMP with sufficient volume and hydraulic controls to match the 2-year peak flow within 10 percent.

3. **Alternative Compliance.** This condition applies to projects that cannot feasibly retain or biotreat the entire DCV and choose to participate in an in-lieu/off-site program for LID. In this case, the water quality design volume or flowrate (WQDV or WQDF) would control the ultimate sizing of BMPs provided upstream of the receiving water.

$$\text{WQDV} > \text{DCV achieved on-site} > \text{Delta 2-yr volume achieved on-site}$$

Design approach: After demonstrating the infeasibility of retaining or biotreating the DCV, claim water quality credits as applicable to project. Size treatment control BMPs, as necessary, to treat the remaining WQDV or WQDF not already addressed with retention and biotreatment BMPs or offset by water quality credits. Claim LID credit for volume that is treated in treatment control BMPs with medium or high effectiveness for all primary pollutants of concern. If treatment control BMPs do not provide M or H effectiveness for all primary pollutants and/or the cost of treatment control BMPs greatly outweighs pollution control benefit; participate in alternative compliance program for remaining LID and treatment control obligation. Provide off-site or in-stream controls to address HCOCs, if present.

Note: this list of conditions is not exhaustive of all potential conditions that could be encountered. It is provided to illustrate the integration of different sizing criteria, and is anticipated to cover a large percentage of projects. Conformance with each sizing standard shall always be evaluated on a standard-by-standard basis.

I.2. Overview of Approach for LID BMP Sizing in North Orange County

This section describes three equivalent pathways a typical Priority Project would potentially follow to size LID BMPs for the DCV in the North Orange County permit area.

- 1) Design LID BMPs to retain on-site (infiltrate, harvest and use, or evapotranspire) 80 percent of the average annual stormwater runoff (i.e., 80 percent capture). The physical storage capacity of the BMP may be less than the DCV if, after considering routing effects (i.e., how quickly storage in the BMP becomes available; see **Appendix III.6**), the average annual capture percentage exceeds 80 percent. **Appendix III.3** and **III.4** provide simplified nomograph tools for calculating long term average annual capture efficiency.

OR

- 2) Participate in a regional facility that provides average annual volume reduction and pollutant load reduction equivalent or better to that which would be achieved by retaining 80 percent of the average annual stormwater from the Project on-site. Regional facilities must be approved by the Regional Board Executive Officer as part of a watershed or sub-watershed scale plan (as described in the Section 2.4.2.2 of the [Model WQMP](#)) and equivalency shall be demonstrated by hydrologic and pollutant removal benefits estimated by water quality modeling.

OR

- 3) Design LID BMPs to:
 - a. Retain (infiltrate, harvest and use, or evapotranspire) stormwater runoff on-site, as feasible up to the DCV,

AND

- b. Recover (i.e., draw down) the storage volume in less than or equal to 48 hours, if feasible. If not feasible, demonstrate based on feasibility criteria that storage cannot be recovered more quickly or provide additional storage volume beyond the DCV to offset longer drawdown time. *Note: Providing the DCV and drawing down this volume down in 48 hours achieves equivalent performance to 80 percent retention of average annual stormwater runoff. Other combinations of retention volume and drawdown can also be used to achieve 80 percent retention of average annual stormwater runoff if desired and feasible (See **Appendix III.3** and **III.4**).*

AND (if necessary)

- c. Biotreat the remaining DCV¹ on-site to the MEP, if any² (cumulative, retention plus biotreatment),

AND (if necessary)
- d. Retain or biotreat, the remaining DCV (cumulative, retention plus biotreatment) in a regional facility designed per LID principals³,

AND (if necessary)
- e. Claim water quality credits, if applicable, and fulfill alternative compliance obligations for runoff volume not retained or biotreated up to the target average annual capture efficiency of 80 percent (cumulative) or offset by water quality credits.

Infeasibility criteria for BMP selection are described in [TGD Section 2.4.2.4](#), and criteria for design BMPs to retain and biotreat stormwater to the MEP are contained in [Appendix XI](#). Conceptually, these criteria are intended to:

- Prevent significant risks to human health and environmental degradation as a result of compliance activities; and
- Describe circumstances under which regional and watershed-based strategies may be selected when they are consistent with the MEP standard considering such factors as technical feasibility, fiscal feasibility, societal concerns, and social benefits; and
- Define performance criteria to ensure that compliance does not result in undue fiscal or societal burdens, including such considerations as:
 - Cost-effectiveness of on-site stormwater management versus off-site stormwater management, including capital costs and maintenance cost and considerations, and
 - Incremental cost-benefit of additional BMPs in stormwater management systems, including capital costs and maintenance costs and considerations.

Functionally, these criteria provide the basis for moving from higher to lower levels of the LID BMP hierarchy outlined in Pathway 3, above.

¹ The remaining design capture volume refers the remaining volume required for the BMP system to collectively store the entire design capture volume, or the remaining volume required for the system to collectively retain plus biotreat 80 percent of average annual runoff volume.

² If remaining volume = 0 after any step, then subsequent steps are not necessary.

³ This option does not require Regional Board Executive Officer approval. This option is implemented after a project-specific finding of

² If remaining volume = 0 after any step, then subsequent steps are not necessary.

³ This option does not require Regional Board Executive Officer approval. This option is implemented after a project-specific finding of infeasibility of retaining or biotreating the entire DCV on the project site.

I.3. Overview of Approach for Treatment Control BMP Sizing in North Orange County

Where LID BMPs can be used to retain or biotreat the DCV, no additional volume of storm water is required to be treated. Therefore the use of LID BMPs to treat the DCV inherently fulfills treatment control requirements. In addition, if water quality credits are claimed by the project to offset remaining unmet portion of the DCV, these credits also serve to reduce the remaining WQDV for treatment control (See Section 3.1 of the [Model WQMP](#)).

Treatment control BMPs must be provided for the remaining “unmet” volume for a project if the following conditions are met:

- Water quality credits do not fully off-set the remaining DCV/WQDV, and
- The pollution control benefits of treatment control BMPs is not outweighed by their cost.

In these cases, sizing of treatment control BMP(s) shall be provided based on the unmet volume/flow as calculated in **Section VI.1**, minus the contribution of water quality credits as calculated in **Section VI.2**.

I.4. Overview of Approach for Addressing HCOCs in North Orange County

Hydrologic Conditions of Concerns (HCOCs) are considered to exist if any streams located downstream from the project are determined to be potentially susceptible to hydromodification impacts and either of the following conditions exists:

- Post-development runoff volume for the 2-yr, 24-hr storm exceeds that of the pre-development⁴ condition by more than 5 percent

OR

- Time of concentration of post-development runoff for the 2-yr, 24-hr storm event is greater ⁵ than the time of concentration of the pre-development condition by more than 5 percent.

⁴ In North Orange County (Order R8-2009-0030), predevelopment is defined as the existing conditions immediately prior to Project WQMP submittal.

⁵ The North County Permit (Order R8-2009-0030), as adopted, provides the option of reducing Tc to less than the existing condition Tc (within 5 percent) as part of the primary and preferred option for mitigating HCOCs. However, a longer Tc is generally associated with natural conditions than urban conditions, and a longer Tc nearly universally results in lower concern for hydromodification impacts. In addition, it is not physically possible for a project to implement BMPs consistent with LID provisions of the permit without substantially increasing the Tc of the site. The use of retention BMPs results in water not discharged under design conditions, while the use of biotreatment BMPs general results in water not immediately discharged. Therefore, it would not generally be possible to mitigate HCOCs using the primary option for compliance described above while complying with LID requirements. This TGD therefore interprets this provision such that increases in Tc would be acceptable and reduction in Tc of more than 5 percent would not be acceptable. This interpretation is consistent with the overall goal of the permit to protect receiving waters from stormwater impacts to the MEP.

If these conditions do not exist or streams are not potentially susceptible to hydromodification impacts, an HCOC does not exist and hydromodification does not need to be considered further.

Streams susceptibility should be determined as described in [TGD Section 2.3](#), which describes methods of determining susceptibility based on either mapping or site specific engineering analysis.

Priority Projects where there is an HCOC shall, as the first priority, implement on-site or regional hydromodification controls such that:

- Post-development runoff volume for the 2-yr, 24-hr storm event is no greater than 105 percent of that for the pre-development condition.

AND

- Time of concentration of post-development runoff for the 2-yr, 24-hr storm event is no greater than 105 percent of that for the pre-development condition (see [Footnote 5](#)).

A project may implement a combination of additional site design practices, LID controls, structural treatment controls, sub-regional/regional controls, and/or in-stream controls to meet the hydromodification performance criteria stated above. In this case, the Project WQMP should include a project-specific evaluation with the pre- and post-development runoff volume and time of concentration for the 2-yr, 24-hr storm event. The Project WQMP must consider site design practices and on-site controls prior to proposing in-stream controls. If in-stream controls are selected, the Project WQMP should include a project-specific evaluation to demonstrate that the project will not adversely impact beneficial uses or result in sustained degradation of water quality of the receiving waters.

Where the Project WQMP documents that the excess runoff volume from the 2-yr, 24-hr runoff event cannot feasibly be retained (infiltrated, harvested and used, or evapotranspired), the project shall:

- Retain the excess volume from the 2-yr, 24-hr runoff event in on-site or regional controls to the MEP,

AND

- Implement on-site or regional hydromodification controls such that the post-development runoff 2-yr, 24-hr peak flow rate is no greater than 110 percent of the pre-development runoff 2-yr, 24-hr peak flow rate.

The process of demonstrating that volume has been controlled to the MEP is the same as the process used to demonstrate that LID BMPs have been designed to retain and biotreat the maximum feasible amount of stormwater runoff (See [Appendix XI](#)).

Alternative performance criteria found within an RWQCB Executive Officer-approved Watershed Infiltration and Hydromodification Management Plan (WIHMP) may supersede these criteria for the area that the plan covers.

I.5. Role of HSCs in BMP Sizing

Hydrologic source controls (HSCs) can play an integral role in the sizing of LID and treatment control BMPs and addressing HCOCs. In the context of the TGD, HSCs are integrated and distributed micro-scale stormwater infiltration and evapotranspiration (ET) systems that are an integral part of LID site design. These systems are distinguished from LID BMPs because they are highly integrated with site designs, they are generally applied opportunistically, they are not governed by fixed sizing criteria, and they are less stringently engineered than the LID BMPs.

HSCs can impact BMP sizing in the following general ways:

- HSCs that retain the entire DCV can render portions of a project “self-retaining,” meaning that no further LID BMPs or treatment control BMPs are needed for their respective drainage areas.
- Green roofs are considered to be self-retaining HSCs when designed to meet the criteria contained in [Appendix IX](#).
- HSCs can also provide partial retention of the DCV, reducing the sizing requirements of downstream BMPs.
- For projects seeking to demonstrate that BMPs have been designed to retain the maximum feasible amount of the DCV, all feasible HSCs must be considered.

[Appendix III](#) provides calculation methods that allow projects to account for the benefits of HSCs when determining the amount of remaining requirements that must be met in downstream BMPs. BMP Fact Sheets contained in [Appendix XIV](#) provide design criteria for HSCs.

APPENDIX II. SUMMARY OF BMP SIZING REQUIREMENTS FOR SOUTH ORANGE COUNTY

The purpose of this appendix is to provide a concise overview of the BMP sizing requirements for Priority Projects in the South Orange County Permit Area. This summary is not intended to supersede the regulatory requirements contained in Section 2.4 of the [Model WQMP](#) or establish new/additional performance criteria. Rather, this summary is intended to provide functional descriptions of how these requirements are anticipated to be applied in the majority of projects. This summary is organized as follows:

- [Introduction to Integrated Structural BMP Sizing Approach in South Orange County](#)
- [Overview of Approach for LID BMP Sizing in South Orange County](#)
- [Overview of Approach for Treatment Control BMP Sizing in South Orange County](#)
- [Overview of Approach for Addressing HCOCs in South Orange County](#)
- [Role of HSCs in BMP Sizing](#)
- [Alternative Performance Criteria for Watershed-based Projects in South Orange County](#)

II.1. Introduction to Integrated Structural BMP Sizing Approach in South Orange County

Priority Projects in the South Orange County Permit Area are required to implement LID, treatment control, and hydromodification control BMPs to achieve numeric performance criteria described in Section 2.4 of the [Model WQMP](#). While Priority Projects must demonstrate compliance with LID, treatment control, and hydromodification control requirements separately, these provisions overlap significantly and some BMPs may fulfill or partially fulfill a portion of one or more of these requirements.

The relative role that the LID, treatment control, and hydromodification performance standards have on BMP sizing requirements depends principally on the susceptibility of receiving channels to hydromodification.

Three distinct conditions relative to BMP sizing are anticipated to exist most commonly:

4. **HCOC-controlled.** This condition applies to any priority project that discharges to receiving waters susceptible to hydromodification. In this case, the [interim hydromodification criteria](#) would control the stormwater design.

$$\textit{Interim HM Standard} > \text{DCV} = \text{WQDV}$$

Design approach: design BMPs to comply with the interim hydromodification standard. This will generally address all other applicable sizing criteria.

Alternate path: There is no alternative compliance option for inability to meet the interim hydromodification standard. However, flow control could potentially be provided off-site.

5. **DCV-controlled.** This condition applies to projects that do not have susceptible receiving waters. In this case, the controlling *stormwater design volume* is the DCV.

$DCV = WQDV$; HCOCs do not exist

Design approach: design BMPs to retain the DCV. This will generally address treatment control sizing criteria.

Contingencies: If full retention is not possible, retain to the MEP, select a biotreatment BMP to address pollutants of concern, and design biotreatment for the remaining DCV to the MEP.

6. **Alternative Compliance.** This condition applies to projects that cannot feasibly retain or biotreat the entire DCV and choose to participate in an in-lieu/off-site program for remaining LID requirements. In this case, the water quality design volume or flowrate (WQDV or WQDF) would control the ultimate sizing of on-site BMPs.

$WQDV > DCV$ achieved on-site

Design approach: After demonstrating the infeasibility of retaining or biotreating the DCV, size treatment control BMPs, as necessary, to treat the remaining WQDV or WQDF not already addressed with retention and biotreatment BMPs. Claim full or partial pollutant offset credit based on pollutant load reduction achieved in treatment control BMPs. Participate in alternative compliance program for remaining LID obligation. Alternative compliance requirements are contained in Section 3.0 of the [Model WQMP](#).

Note: this list of conditions is not exhaustive of all potential conditions that could be encountered. It is provided to illustrate the integration of different sizing criteria, and is anticipated to cover a large percentage of projects. Conformance with each sizing standard shall always be evaluated on a standard-by-standard basis.

II.2. Overview of Approach for LID BMP Sizing in South Orange County

This section describes three equivalent pathways a typical Priority Project would potentially follow to size LID BMPs for the DCV in the South Orange County permit area.

- 1) Design LID BMPs to retain on-site (infiltrate, harvest and use, or evapotranspire) 80 percent of the average annual stormwater runoff (i.e., 80 percent capture). The physical storage capacity of the BMP may be less than the DCV if, after considering routing

effects (i.e., the rate at which water is treated and storage volume is recovered), the average annual capture percentage exceeds 80 percent. **Appendix III.3** and **III.4** provide simplified nomograph tools for calculating long term average annual capture efficiency. In the South Orange County permit area, the pre-filter storage volume of the BMP may not be less than 75 percent of the DCV⁶.

OR

2) Design LID BMPs to:

- a. Retain (infiltrate, harvest and use, or evapotranspire) stormwater runoff on-site, as feasible up to the DCV,

AND

- b. Recover (i.e., draw down) the storage volume in less than or equal to 48 hours, if feasible. If not feasible, demonstrate based on feasibility criteria that storage cannot be recovered more quickly or provide additional storage volume beyond the DCV to offset longer drawdown time. *Note: Providing the DCV and drawing down this volume down in 48 hours achieves equivalent performance to 80 percent retention of average annual stormwater runoff. Other combinations of retention volume and drawdown can also be used to achieve 80 percent retention of average annual stormwater runoff if desired and feasible (See **Appendix III.3** and **III.4**).*

AND (if necessary)

- c. Biotreat the remaining DCV⁷ on-site to the MEP, if any⁸ (cumulative, retention plus biotreatment),
- d. Provided treatment controls for the remaining DCV, and fulfill alternative compliance obligations for runoff volume not retained or biotreated up to the target average annual capture efficiency of 80 percent (cumulative) or offset pollutant load reduction in treatment control BMPs.

Infeasibility criteria for BMP selection are described in [TGD Section 2.4.2.4](#), and criteria for design BMPs to retain and biotreat stormwater to the MEP are contained in [Appendix XI](#). Conceptually, these criteria are intended to:

⁶ The pre-filter volume is defined as the physical storage provided in the BMP, not count volume that is routed during the storm event. The physical volume of the BMP must be at least 75 percent of the DCV.

⁷ The remaining design capture volume refers the remaining volume required for the BMP system to collectively store the entire design capture volume, or the remaining volume required for the system to collectively retain plus biotreat 80 percent of average annual runoff volume.

⁸ If remaining volume = 0 after any step, then subsequent steps are not necessary.

- Prevent significant risks to human health and environmental degradation as a result of compliance activities; and
- Describe circumstances under which regional and watershed-based strategies may be selected when they are consistent with the MEP standard considering such factors as technical feasibility, fiscal feasibility, societal concerns, and social benefits; and
- Define performance criteria to ensure that compliance does not result in undue fiscal or societal burdens, including such considerations as:
 - Cost-effectiveness of on-site stormwater management versus off-site stormwater management, including capital costs and maintenance cost and considerations, and
 - Incremental cost-benefit of additional BMPs in stormwater management systems, including capital costs and maintenance costs and considerations.

Functionally, these criteria provide the basis for moving from higher to lower levels of the LID BMP hierarchy outlined in Pathway 3, above.

II.3. Overview of Approach for Treatment Control BMP Sizing in South Orange County

Where LID BMPs can be used to retain or biotreat the DCV, no additional volume of storm water is required to be treated. Therefore the use of LID BMPs to treat the DCV inherently fulfills treatment control requirements.

If LID performance criteria have not been met through retention and biotreatment, then treatment control BMPs should be provided to address the remaining treatment control performance criteria. Two potential cases could arise with respect to performance criteria of treatment control BMPs:

- 1) LID performance criteria can be partially, but not fully met with LID BMPs.
 - Sizing of treatment control BMP(s) would be based on the unmet volume to achieve cumulative 80 percent average annual capture efficiency as calculated in Section VI.1.
- 2) The project or a drainage area cannot feasibly incorporate any LID BMPs.
 - Sizing of treatment control BMP(s) would be based one of the following criteria:
 - Capture and infiltrate or treat 80 percent of average annual runoff volume,
OR
 - Capture and infiltrate or treat the runoff from the 24-hour, 85th percentile storm event, as determined from the County of Orange’s 85th Percentile Precipitation Isopluvial Map and draw down the stored volume in no more than 48 hours following the end of precipitation,
OR

- Treat the maximum flow rate of runoff produced by the 85th percentile hourly rainfall intensity, as determined from the local historical rainfall record, multiplied by a factor of two, or

OR

- The maximum flow rate of runoff produced from a rainfall intensity of 0.2 inch of rainfall per hour, for each hour of a storm event.

II.4. Overview of Approach for Addressing HCOCs in South Orange County

II.4.1. Interim Criteria

HCOCs are not considered to exist if the downstream conveyance network is not susceptible to hydromodification impacts. Streams susceptibility should be determined as described in [TGD Section 2.3](#), which requires methods of determining susceptibility based on either mapping or site specific engineering analysis.

For projects discharging to a downstream conveyance network that is susceptible to hydromodification impacts, an HCOC is assumed to exist, and projects shall as required by the [Model WQMP](#) mitigate this HCOC. An HCOC is considered to be mitigated when on-site or regional hydromodification controls are provided such that such that:

- For flow rates from 10 percent of the 2-year storm event to the 5-year storm event, the post-project flows do not exceed pre-development (naturally occurring) peak flows.
- For flow rates from the 5-year storm event to the 10-year storm event the post-project peak flows may exceed pre-development (naturally occurring) flows by up to 10 percent for a 1-year frequency interval.

II.4.2. Final Criteria

If a Hydromodification Management Plan (HMP) has been approved by the Regional Board and the project is located within a copermittee's jurisdiction that has incorporated the HMP into the LIP, then the project shall implement the criteria that have been incorporated into the HMP.

II.5. Role of HSCs in BMP Sizing

Hydrologic source controls (HSCs) can play an integral role in the sizing of LID and treatment control BMPs and addressing HCOCs. In the context of the TGD, HSCs are integrated and distributed micro-scale stormwater infiltration and ET systems that are an integral part of LID site design. These systems are distinguished from LID BMPs because they are highly integrated with site designs, they are generally applied opportunistically, they are not governed by fixed sizing criteria, and they are less stringently engineered than the LID BMPs.

HSCs can impact BMP sizing in the following general ways:

- HSCs that retain the entire DCV can render portions of a project “self-retaining,” meaning that no further LID BMPs or treatment control BMPs are needed for these areas.
- Green roofs are considered to be self-retaining HSCs when designed to meet the criteria contained in [Appendix IX](#).
- HSCs can also provide partial retention of the DCV, reducing the sizing requirements of downstream BMPs.
- For projects seeking to demonstrate that BMPs have been designed to retain the maximum feasible amount of the DCV, all feasible HSCs must be considered.

[Appendix III](#) provides calculation methods that allow projects to account for the benefits of HSCs when determining the amount of remaining requirements that must be met in downstream BMPs. BMP Fact Sheets contained in [Appendix XIV](#) provide design criteria for HSCs.

II.6. Alternative Performance Criteria for Watershed-based Projects in South Orange County

In the South Orange County permit area, development projects greater than 100 acres in total project size, or smaller than 100 acres in size yet part of a larger common plan of development that is over 100 acres, that have been prepared using watershed and/or sub-watershed-based water quality, hydrologic, and fluvial geomorphologic planning principles that implement regional LID BMPs in accordance with the sizing and location criteria of the South Orange County Permit and acceptable to the Regional Board, are deemed to satisfy the South County Permit’s requirements for new development and do not have to conduct an on-site feasibility analysis. Regional BMPs in such plans should clearly exhibit that they will not result in a net impact from pollutant loadings over and above the impact caused by capture and retention of the design storm with on-site LID BMPs.

APPENDIX III. HYDROLOGIC CALCULATIONS AND SIZING METHODS FOR LID BMPS

III.1. Hydrologic Methods for Design Capture Storm

This section describes the hydrologic methods that shall be used to compute the design runoff volume or flowrate resulting from a given precipitation depth or intensity and a given imperviousness fraction. These methods are applicable to the Design Capture Storm (85th percentile, 24-hour) as well as the water quality design storm and water quality design intensity. These methods are not applicable for hydrologic analysis of the 2-year design storm.

III.1.1. Simple Method Runoff Coefficient for Volume-Based BMP Sizing

This hydrologic method shall be used to calculate the runoff volume associated with LID and water quality design storms. The runoff volume shall be calculated as:

$$V = C \times d \times A \times 43560 \text{ sf/ac} \times 1/12 \text{ in/ft} \qquad \text{Equation III.1}$$

Where:

- V = runoff volume during the design storm event, cu-ft
- C = runoff coefficient = $(0.75 \times imp + 0.15)$
- imp = impervious fraction of drainage area (ranges from 0 to 1)
- d = storm depth (inches)
- A = tributary area (acres)

Note: the tributary area includes the portions of the drainage area within the project and any run-on from off-site areas that comingles with project runoff.

An example of this calculation is provided in [Example III.1](#). This method shall not be used for calculating the runoff volume from the 2-year design storm.

Example III.1: Design Runoff Volume Calculation using Simple Runoff Coefficient Method

Given:
<ul style="list-style-type: none"> • A drainage area consists of a 1 acre building roof surrounded by 0.25 acres of landscaping (80 percent composite imperviousness) • The design capture storm depth is 0.75 inches .
Required:
<ul style="list-style-type: none"> • Find the DCV
Result:
<ol style="list-style-type: none"> 1) From Equation I.1: $V = C \times d \times A \times 43560 \text{ sf/ac} \times 1/12 \text{ in/ft}$ 2) $C = (0.8 \times 0.75 + 0.15) = 0.75$ 3) $A = 1.25 \text{ ac}$ 4) $d = 0.75 \text{ inches}$ 5) $V = 0.75 \times 0.75 \text{ in} \times 1.25 \text{ ac} \times 43560 \text{ sf/ac} \times 1/12 \text{ in/ft} = \mathbf{2,550 \text{ cu-ft}}$

In some BMP sizing calculations, it is necessary to “back-calculate” the design storm depth based on the runoff volume and a description of the watershed. The design storm depth can be calculated by rearranging Equation 2.1 above:

$$d = V \times 12 \text{ in/ft} / [C \times A \times 43560 \text{ sf/ac}] \qquad \text{Equation III.2}$$

Any subtraction from the designs storm depth claimed in Section III.1.3 to account for HSCs should be added to the back-computed design storm depth after this calculation. Example III.2 illustrates how a given volume of stormwater would be translated to an equivalent storm depth.

Example III.2: Back-computing Storm Depth from Runoff Volume

Given:
<ul style="list-style-type: none"> • A drainage area consists of a 1 acre building roof surrounded by 0.25 acres of landscaping (80 percent composite imperviousness) • An LID BMP with 1,200 cu-ft of storage is provided.
Required:
<ul style="list-style-type: none"> • What is the equivalent design storm corresponding to this BMP volume?
Result:
<ol style="list-style-type: none"> 1) From Equation 2.2: $d = V \times 12 \text{ in/ft} / [C \times A \times 43560 \text{ sf/ac}]$ 2) $V = 1,200 \text{ cu-ft}$ (given) 3) $C = (0.8 \times 0.75 + 0.15) = 0.75$ 4) $A = 1.25 \text{ ac}$ 5) $d = 1,200 \text{ cu-ft} \times 12 \text{ in/ft} / [0.75 \times 1.25 \text{ ac} \times 43560 \text{ sf/ac}] = \mathbf{0.35 \text{ inches}}$

III.1.2. Simple Method Runoff Coefficient for Flow-based BMP Sizing

This hydrologic method shall be used to calculate the runoff flowrate associated with a water quality design storm intensity. Design flow calculations for flow-based BMPs should be calculated as:

$$Q = C \times i \times A \qquad \text{Equation III.3}$$

Where:

- Q = design flowrate, cfs
- C = runoff coefficient = $(0.75 \times imp + 0.15)$
- imp = impervious fraction of drainage area (ranges from 0 to 1)
- i = design intensity (inches)
- A = tributary area (acres)

Note: the tributary area includes the portions of the drainage area within the project and any run-on from off-site areas that comingles with project runoff.

III.1.3. Sizing and Accounting for Hydrologic Source Controls (HSCs)

The effects of HSCs are accounted for in hydrologic calculations as an adjustment to the storm depth used in the calculations described above. Adjustments to design storm depth are based on the type and magnitude of HSCs employed for the drainage area. This section provides guidance for both elements of this calculation.

III.1.3.1. Calculating the Effective Storage Depth of HSCs

[BMP Fact Sheets for HSCs \(XIV.1\)](#) include HSC-specific criteria for quantifying storm depth retained. There may be more than one HSC in a single drainage area, and the effect of the suite of HSCs over a drainage area should be combined and area weighted as follows.

$$d_{\text{HSC total}} = \sum d_{\text{HSC}_i} \times IA_i / IA_{\text{total}} \quad \text{Equation III.4}$$

Where:

$d_{\text{HSC total}}$ = combined effect of HSCs in drainage area, inches

d_{HSC_i} = effect of individual HSC_i per criteria in BMP Fact Sheets (Section [XIV.1](#)), inches

IA_i = impervious area tributary to individual HSC_i (for street trees this is the impervious area beneath a fully established perennial canopy); areas cannot be counted twice if more than one HSC captures runoff from the same impervious area (e.g., street trees covering a roof top that is disconnected).

IA_{total} = total impervious area in drainage area

[Example III.1](#) provides a template for calculation of the combined effective of HSCs in the drainage area (expressed in inches reduction of the design capture storm depth).

calculation is adjusted prior to the calculation. **Example III.4** illustrates the approach for accounting for HSCs in hydrologic calculations and the effect that HSCs can have on reducing the required volume of downstream BMPs.

Example III.4: Accounting for HSCs in Hydrologic Calculations

Given:
<ul style="list-style-type: none"> • A drainage area consists of a 2.1 acres with 1.3 acres of impervious surface (62% imperviousness) • The mix of HSCs shown in Example III.3 are used in the drainage area, resulting in an area-weighted average HSC effective retention depth of 0.14 inches • The unadjusted design storm depth at the project site is 0.85 inches.
Result:
1) The designer uses 0.85 inches – 0.14 inches = 0.71 inches in the calculation of runoff from the design storm depth
2) DCV (with HSCs) = $2.1 \text{ ac} \times 0.71 \text{ inches} \times (0.62 \times 0.75 + 0.15) \times 43560 \text{ sf/ac} \times 1/12 \text{ in/ft} = 3,330 \text{ cu-ft}$
3) DCV (without HSCs) = $2.1 \text{ ac} \times 0.85 \text{ inches} \times (0.62 \times 0.75 + 0.15) \times 43560 \text{ sf/ac} \times 1/12 \text{ in/ft} = 3,990 \text{ cu-ft}$

III.1.3.3. Computing the Fraction of Average Long Term Runoff Reduced by HSCs

Table III.1 provides fraction of average annual runoff volume reduced by HSCs based on the effective storage volume of HSCs computed per Section III.1.3.1.

Table III.1: Fraction of Average Long Term Runoff Reduced (Capture Efficiency) by HSCs

Cumulative HSC Adjustment to Design Capture Storm Depth (d_{hsc})	Capture Efficiency Achieved Lowland Regions (<1,000 ft)	Capture Efficiency Achieved Mountainous Regions (>1,000 ft)
<0.05	0	0%
0.05"	8%	7%
0.1"	20%	16%
0.2"	37%	31%
0.3"	48%	42%
0.4"	57%	50%
0.5"	64%	57%
0.6"	70%	63%
0.7"	75%	68%
0.8"	80%	72%
0.9"	80%	76%
1.0"	80%	80%

Worksheet A: Hydrologic Source Control Calculation Form

Drainage area ID _____				
Total drainage area _____ acres				
Total drainage area Impervious Area (IA_{total}) _____ acres				
HSC ID	HSC Type/ Description/ Reference BMP Fact Sheet	Effect of individual HSC _i per criteria in BMP Fact Sheets (XIV.1) $(d_{HSCi})^1$	Impervious Area Tributary to HSC _i (IA_i)	$d_i \times IA_i$
Box 1:		$\sum d_i \times IA_i =$		
Box 2:		$IA_{total} =$		
[Box 1]/[Box 2]:		$d_{HSC total} =$		
[Box 1]/[Box 2]:		<i>Percent Capture Provided by HSCs</i> (Table III.1)		

1 - For HSCs meeting criteria to be considered self-retaining, enter the DCV for the project.

III.1.4. General Guidelines for Use of Continuous Simulation Modeling

For projects with complex hydrologic conditions or for evaluation of complex BMP designs, an appropriate public domain continuous flow model [such as Storm Water Management Model (SWMM) or Hydrologic Engineering Center – Hydrologic Simulation Program – Fortran (HEC-HSPF)], may be used to develop and evaluate BMP designs. The model should be run using a local precipitation record and project-specific information about soils, slopes, and BMP designs. Inputs should be thoroughly documented and conform to standards of engineering practice.

The acceptability of models is at the discretion of the reviewing agency, therefore the applicant should inquire with the reviewing agency regarding model preference and input assumptions.

III.2. Exhibits and Nomographs Used for LID and WQDV/WQDF Design Volume Calculations

Figure III.1 depicts the Design Capture Storm Depth⁹ for Orange County. A higher resolution version of this figure is provided in **Appendix XVI**.

Figure III.2 presents a relationship between unit storage volume, drawdown time, and capture efficiency that is applicable across Orange County. The relationships are developed based on continuous simulation of hourly precipitation data per methods described in **Appendix III.6** and can be used in a variety of ways for design calculations as described in the following sections.

Figure III.3 presents a relationship between unit storage volume, unit demand (assuming drawdown rate varies with ET rate), and capture efficiency that is applicable across Orange County for systems with irrigation as their only demand. The relationships are developed based on continuous simulation of hourly precipitation data and daily ET data per methods described in **Appendix III.6** and can be used in a variety of ways for design calculations of harvest and use systems as described in the following sections. The effective irrigation area to tributary area ratio of the system (*EIATA*) is calculated as follows:

The EIATA ratio is calculated as follows:

$$EIATA = LA \times K_L / [IE \times \text{Tributary Impervious Area}]$$

Where:

⁹ The Design Capture Storm Depth is calculated as the 85th percentile, 24 hour precipitation depth, determined from historic precipitation records, excluding days with less than or equal to 0.1 inches of precipitation.

EIATA = Effective Irrigated Area to Tributary Area ratio (ac/ac)

LA = landscape area irrigated with harvested water, sq-ft

K_L = Area-weighted landscape coefficient (see guidance and references in **Appendix X.2.5.2**)

IE = irrigation efficiency (assume 0.90)

Figure III.4 presents a relationship between design intensity, catchment time of concentration, and capture efficiency for off-line, flow-based BMPs. The relationships are developed based on analysis of hourly and 5-minute precipitation data as described in per methods described in **Appendix III.6** and can be used in a variety of ways for design calculations as described in the following sections. It is applicable across Orange County.

Figure III.1. Design Capture Rainfall Zones in Orange County

See [Exhibit XVI.1](#)

Figure III.2. Capture Efficiency Nomograph for Constant Drawdown Systems in Orange County

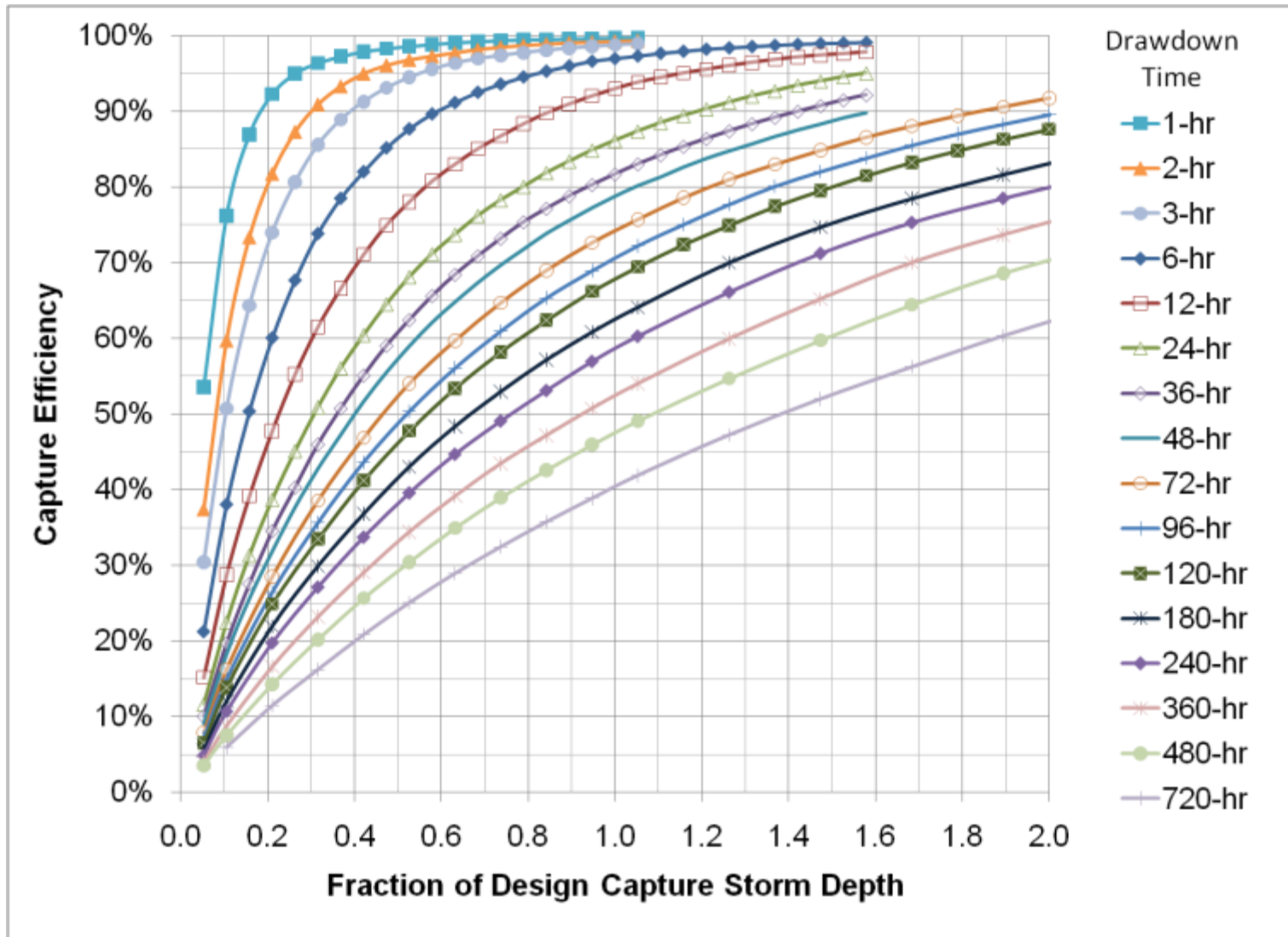

Figure III.3. Capture Efficiency Nomograph for Harvest and Use Systems with Irrigation Demand in Orange County

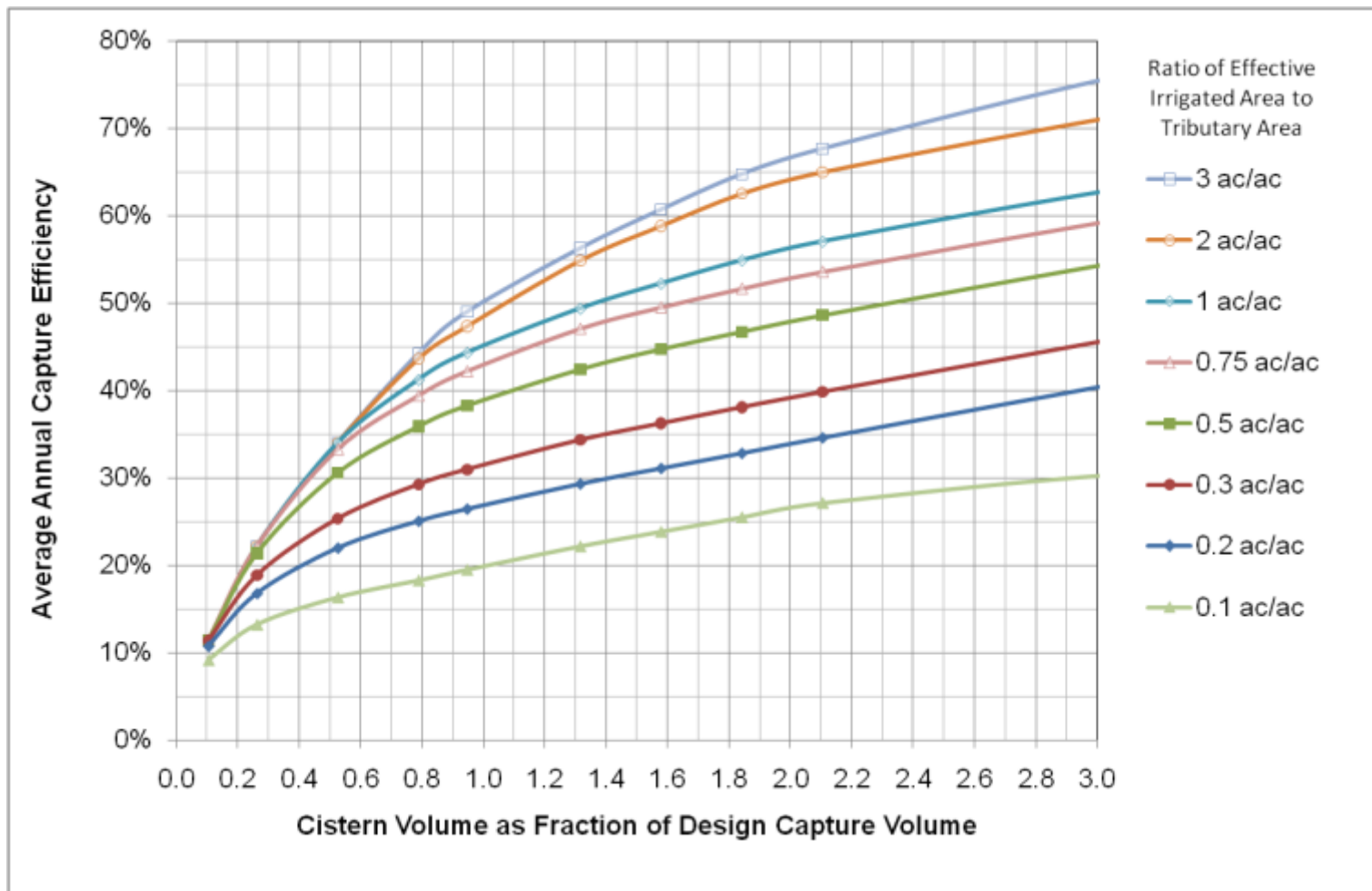
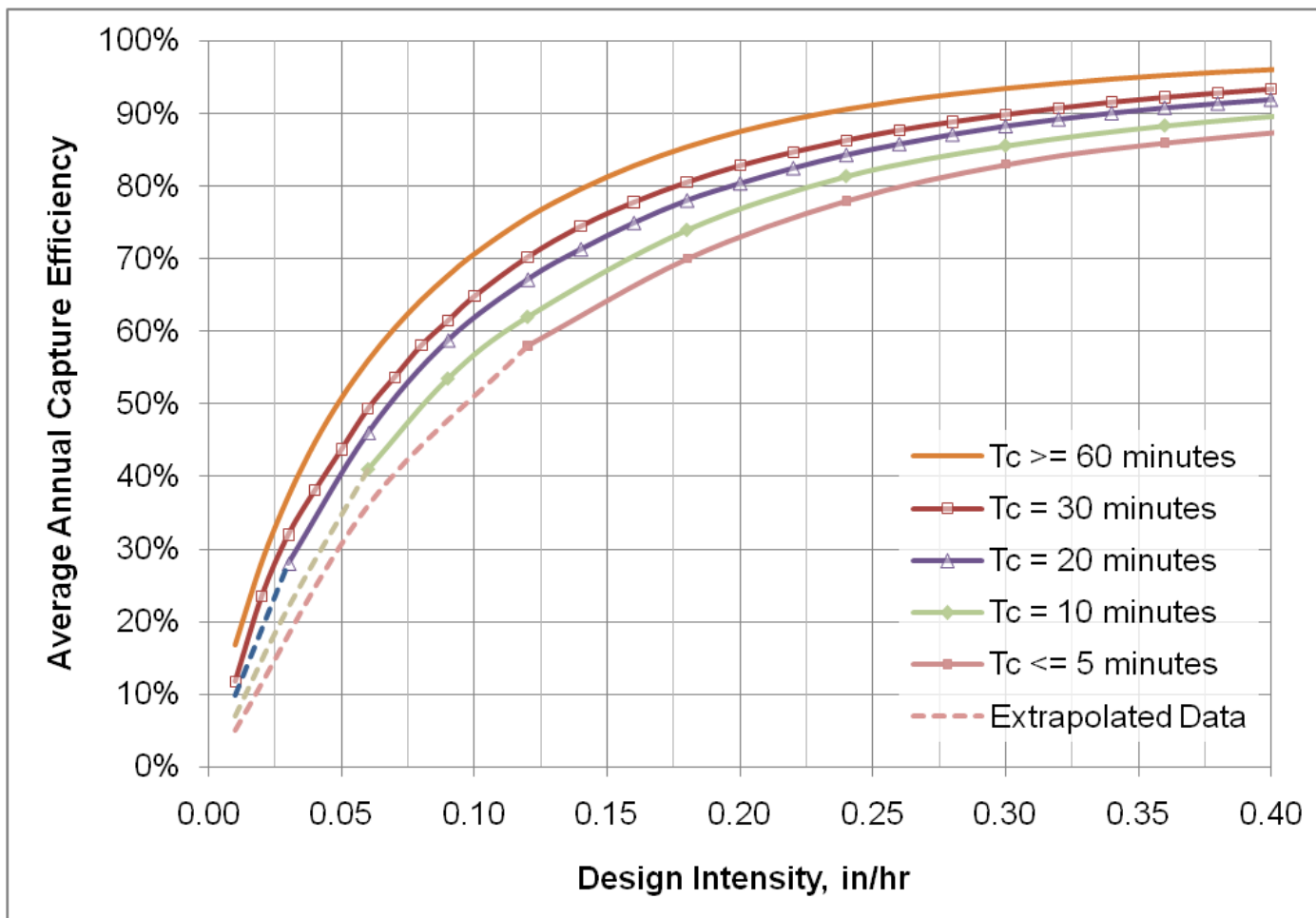

Figure III.4. Capture Efficiency Nomograph for Off-line Flow-based Systems in Orange County



III.3. Approved Methods for Calculating the LID Design Capture Volume

This section describes approved methods for calculating LID DCV.

III.3.1. Simple Design Capture Volume Sizing Method

This section describes the simplest method of sizing volume-based BMPs to manage the DCV. It may result in BMPs that achieve greater than 80 percent capture, therefore may be somewhat oversized to meet minimum performance criteria. This would result where the DCV can draw down in less than 48 hours. If the size of the BMP that results from this method is impracticable because it is oversized, the Capture Efficiency Method for Volume-Based, Constant Drawdown BMPs (**Appendix III.3.2**) is recommended.

Stepwise Instructions:

- 1) Look up the design capture storm depth from **Figure III.1**.
- 2) Compute the DCV using the approved hydrologic methods described in Sections **III.1** accounting for HSCs implemented upstream.
- 3) Design BMP(s) to ensure that the DCV is fully retained (i.e., no surface discharge during the design event) and the stored volume draws down in no longer than 48 hours.

Treatment control performance criteria are fully met where this method is used.

Example III.5: Computing DCV using Simple Method

Given:
<ul style="list-style-type: none"> • Redevelopment project, 85th percentile, 24-hr storm depth = 0.85 inches • Drainage Area = 1.5 acres • Imperviousness = 80% • Effective retention depth of HSCs (d_{HSC}) = 0.2 inches • Design infiltration rate = 0.5 in/hr
Required:
<ul style="list-style-type: none"> • Determine LID DCV by Simple Method and check that this volume can be drawn down in less than or equal to 48 hours
Solution:
<ol style="list-style-type: none"> 1) Design capture storm depth = 0.85 inches from Figure III.1. 2) Design capture storm depth, less HSCs = 0.85 inches – 0.2 inches = 0.65 inches 3) $DCV = 1.5 \text{ ac} \times (0.8 \times 0.75 + 0.15) \times (0.65 \text{ inches}) \times 43,560 \text{ sf/ac} \times 1/12 \text{ in/ft} = 2,650 \text{ cu-ft}$ 4) Design BMP to provide remaining DCV and ensure ≤ 48 hour drawdown.

Minimum area required = [DCV] / [maximum retention depth that can draw down in 48 hours]

Max retention depth that can be drawn down in 48 hrs = 48 hrs × 0.5 in/hr = 24 inches = 2 ft

Minimum area required = 2,650 cu-ft / 2-ft = 1,325 sq-ft = 2.0 percent of project site. At least this effective area should be provided for infiltration to ensure that water is completely drawn down in no greater than 48 hours.

- 5) Retention depth may be provided through surface storage plus pore storage depending on BMP type. See [BMP Fact Sheets](#) for BMP-specific guidance on computing drawdown based on system geometry.

Worksheet B: Simple Design Capture Volume Sizing Method

Step 1: Determine the design capture storm depth used for calculating volume			
1	Enter design capture storm depth from Figure III.1, d (inches)	$d=$	inches
2	Enter the effect of provided HSCs, d_{HSC} (inches) (Worksheet A)	$d_{HSC}=$	inches
3	Calculate the remainder of the design capture storm depth, $d_{remainder}$ (inches) (Line 1 - Line 2)	$d_{remainder}=$	inches
Step 2: Calculate the DCV			
1	Enter Project area tributary to BMP (s), A (acres)	$A=$	acres
2	Enter Project Imperviousness, imp (unitless)	$imp=$	
3	Calculate runoff coefficient, $C = (0.75 \times imp) + 0.15$	$C=$	
4	Calculate runoff volume, $V_{design} = (C \times d_{remainder} \times A \times 43560 \times (1/12))$	$V_{design}=$	cu-ft
Step 3: Design BMPs to ensure full retention of the DCV			
Step 3a: Determine design infiltration rate			
1	Enter measured infiltration rate, $K_{measured}$ (in/hr) (Appendix VII)	$K_{measured}=$	In/hr
2	Enter combined safety factor from Worksheet H, S_{final} (unitless)	$S_{final}=$	
3	Calculate design infiltration rate, $K_{design} = K_{measured} \times S_{final}$	$K_{design}=$	In/hr
Step 3b: Determine minimum BMP footprint			
4	Enter drawdown time, T (max 48 hours)	$T=$	Hours
5	Calculate max retention depth that can be drawn down within the drawdown time (feet), $D_{max} = K_{design} \times T \times (1/12)$	$D_{max}=$	feet
6	Calculate minimum area required for BMP (sq-ft), $A_{min} = V_{design} / d_{max}$	$A_{min}=$	sq-ft

III.3.2. Capture Efficiency Method for Volume-Based, Constant Drawdown BMPs

This section describes the recommended method of sizing volume-based BMPs to achieve the 80 percent capture performance criterion. This method has a number of potential applications in the Project WQMP preparation process, including:

- Use this method where a BMP can draw down in less than 48 hours and it is desired to demonstrate that 80 percent capture can be achieved using a BMP volume smaller than the DCV.
- Use this method to determine how much volume (greater than the DCV) must be provided to achieve 80 percent capture when the drawdown time of the BMP exceeds 48 hours.
- Use this method to determine how much volume should be provided to achieve 80 percent capture where upstream BMP(s) have achieved some capture, but have not achieved 80 percent capture.

By nature, this is an iterative process that requires some initial assumptions about BMP design parameters and subsequent confirmation that these assumptions are valid. For example sizing calculations depend on the assumed drawdown time, which depends on BMP depth, which may in turn need to be adjusted to provide the required volume within the allowable footprint. In general, the selection of reasonable BMP design parameters in the first iteration will result in minimal required additional iterations.

This method is only suitable for volumetric BMPs that have a drawdown rate can be approximated as constant throughout the year or over the wet season. For these BMPs, [Figure III.2](#) should be used with the instructions below. For flow-based BMPs, Section [III.4.3](#) should be used.

Stepwise Instructions:

1. Look up the 85th percentile, 24-hour storm depth for the project site from [Figure III.1](#).
2. Estimate the drawdown time of the proposed BMP. See the applicable BMP Fact Sheet for specific guidance on how to convert BMP geometry to estimated drawdown time. On [Figure III.2](#), locate where the line corresponding to the estimated drawdown time intersects with 80 percent capture. Pivot to the X axis and read the fraction of the DCV that needs to be provided in the BMP. This is referred to as X_1 .
3. Determine the capture efficiency achieved upstream of the BMP and trace a horizontal line on [Figure III.2](#) corresponding to this value. Upstream capture would result from HSCs or upstream LID BMPs.
4. Find where the line traced in (3) intersects with the drawdown time estimated in (2). Pivot and read down to the horizontal axis to yield the fraction of the DCV already provided by upstream HSCs and BMPs. This is referred to as X_2 .
5. Subtract X_2 from X_1 to determine the fraction of the design volume that must be provided to achieve 80 percent capture.

6. Multiply the result of (5) by the 85th percentile, 24-hour storm depth (1).
7. Compute runoff from the storm depth computed in (6) per guidance contained in Section III.1.1. This is the required BMP design volume.
8. Design the BMP to retain the required volume, and confirm that the drawdown time is no more than 25 percent greater than estimated in (2). If the computed drawdown time is greater than 125 percent of the estimated drawdown, then return to (2) and revise the initial drawdown time assumption.

See the respective BMP facts sheets for BMP-specific instructions for the calculation of volume and drawdown time.

Example III.6: Computing Design Criteria to Achieve Target Capture Efficiency, Bioretention BMP

Given:
<ul style="list-style-type: none"> • 85th percentile, 24-hr storm depth = 0.85 inches • Drainage Area = 1.5 acres • Imperviousness = 80% • Effect of provided HSCs (d_{HSC}) = 0.2 inches • Assume to priority BMP to be considered is bioretention without underdrains, 24-inch total retention depth (surface ponding + pore space) • Design infiltration rate = 0.25 in/hr
Required:
<ul style="list-style-type: none"> • Determine volume required to achieve 80 percent capture
Solution:
<ol style="list-style-type: none"> 1) 85th percentile, 24-hr storm depth = 0.85 inches (Figure III.1) 2) BMP has total retention depth of 24 inches with 0.25 in/hr. → 24 in / 0.25 in/hr = 96 hour total drawdown → From Figure III.5: $X_1 = 1.38$ 3) Capture efficiency achieved by 0.2 inches of HSCs = 31% (From Table III.1). 4) From Figure III.5: $X_2 = 0.26$ 5) Fraction of 85th percentile, 24-hour storm depth required ($X_1 - X_2$) = (1.38 - 0.26) = 1.12 6) Required design storm depth = 0.85 inches * (1.12) = 0.95 inches 7) Required storage volume = 1.5 ac × 0.95 inches × (0.8×0.75 + 0.15) × 43560 sf/ac × 1/12 in/ft = 3,880 cu-ft 8) Check that 96 hour drawdown can be achieved for this volume. If recomputed drawdown time is more than 25% higher than original assumption, repeat steps starting with Step 2.

Graphical operations supporting solution:

Figure III.5
Graphical Operations Supporting Example III.6

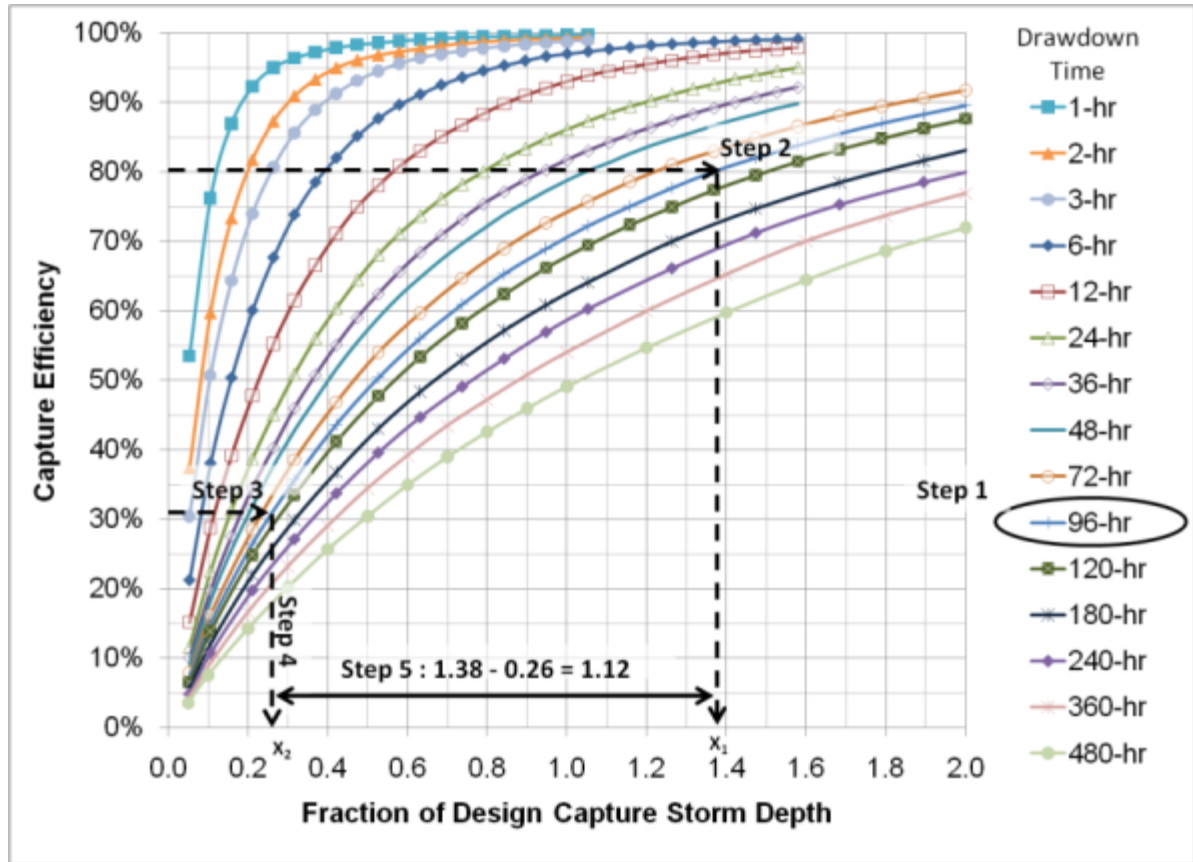

Worksheet C: Capture Efficiency Method for Volume-Based, Constant Drawdown BMPs

Step 1: Determine the design capture storm depth used for calculating volume			
1	Enter design capture storm depth from Figure III.1 , d (inches)	$d=$	inches
2	Enter calculated drawdown time of the proposed BMP based on equation provided in applicable BMP Fact Sheet, T (hours)	$T=$	hours
3	Using Figure III.2 , determine the "fraction of design capture storm depth" at which the BMP drawdown time (T) line achieves 80% capture efficiency, X_1	$X_1=$	
4	Enter the effect depth of provided HSCs upstream, d_{HSC} (inches) (Worksheet A)	$d_{HSC}=$	inches
5	Enter capture efficiency corresponding to d_{HSC} , Y_2 (Worksheet A)	$Y_2=$	%
6	Using Figure III.2 , determine the fraction of "design capture storm depth" at which the drawdown time (T) achieves the equivalent of the upstream capture efficiency(Y_2), X_2	$X_2=$	
7	Calculate the fraction of design volume that must be provided by BMP, $fraction = X_1 - X_2$	$fraction=$	
8	Calculate the resultant design capture storm depth (inches), $d_{fraction} = fraction \times d$	$d_{fraction}=$	inches
Step 2: Calculate the DCV			
1	Enter Project area tributary to BMP (s), A (acres)	$A=$	acres
2	Enter Project Imperviousness, imp (unitless)	$imp=$	
3	Calculate runoff coefficient, $C = (0.75 \times imp) + 0.15$	$C=$	
4	Calculate runoff volume, $V_{design} = (C \times d_{fraction} \times A \times 43560 \times (1/12))$	$V_{design}=$	cu-ft
Supporting Calculations			
Describe system:			
Provide drawdown time calculations per applicable BMP Fact Sheet:			

Worksheet C: Capture Efficiency Method for Volume-Based, Constant Drawdown BMPs

Graphical Operations

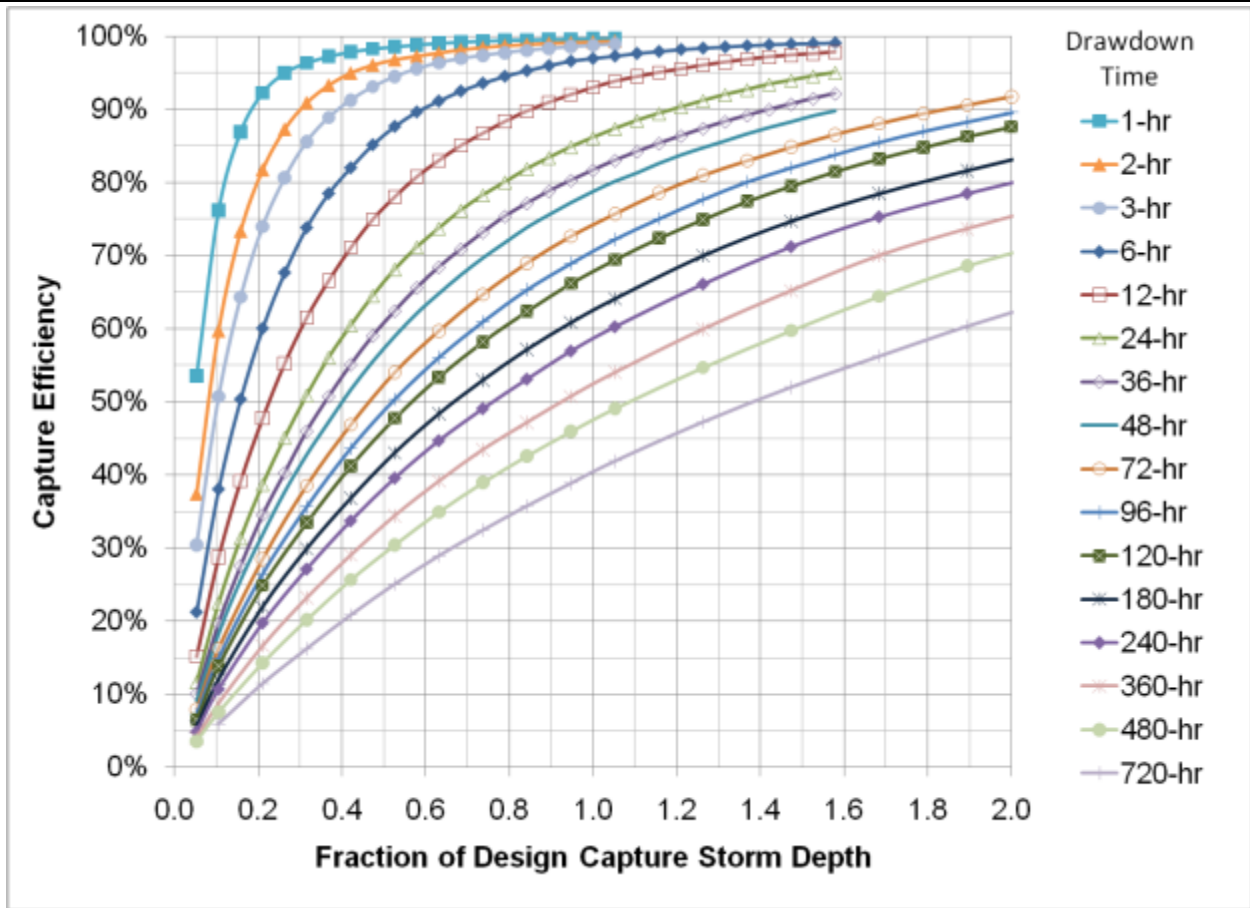

Provide supporting graphical operations. See Example III.6.

III.3.3. Capture Efficiency Method for Flow-based BMPs

This section describes the recommended method to compute the design flowrate for flow-based BMPs to achieve 80 percent average annual capture efficiency. This method allows accounting for the effects of HSCs and other BMPs upstream of the flow-based BMP. This method has a number of potential applications in the Project WQMP preparation process:

- Use this method to compute the design flowrate to achieve 80 percent capture when HSCs or other BMPs have been provided upstream that already manage a portion of the DCV.
- Use this method to add a flow-based component to a BMP that already has a retention component. This method results in the design flowrate for the flow-based component so that the BMP achieves a total of 80 percent capture between the volume-based and the flow-through component.

Stepwise Instructions:

- 1) Estimate the time of concentration (T_c) of the tributary area per Section IV.2.
- 2) Locate where the T_c line intersects with 80 percent capture on Figure III.4. Pivot and read to the horizontal axis to yield I_1 .
- 3) Determine the capture efficiency achieved upstream of the BMP and trace a horizontal line on Figure III.4 corresponding to this value. This will generally be the capture efficiency achieved by upstream HSCs (Section III.1.3.3), but may account for the effect of an upstream LID BMP as well if a treatment train is used.
- 4) Locate where the T_c line intersects with the line traced in (3). Pivot and read down to the horizontal axis to yield I_2 .
- 5) Subtract I_2 from I_1 to yield the design intensity required to yield 80 percent capture.
- 6) Compute runoff flowrate from the design intensity as specified in Section III.1.2. This is the required design flowrate for the BMP.
- 7) Design the BMP to treat the required design flowrate.

Example III.7: Sizing to Achieve Target Average Annual Capture Efficiency, Flow-based BMPs

Given:
<ul style="list-style-type: none"> • 85th percentile, 24-hr storm depth = 0.95 inches • Drainage Area = 3.5 acres • Imperviousness = 95% • Retention BMP provided upstream achieves 45 percent capture; does not fully meet requirements • Assume swale is added as a biotreatment BMP downstream of retention
Required:
<ul style="list-style-type: none"> • Determine swale design flowrate required to achieve 80 percent capture cumulatively

Solution:

- 1) $T_c = 10$ minutes (calculation would be per **Appendix IV.2**)
- 2) From **Figure III.6** $I_1 = 0.23$ in/hr
- 3) Capture efficiency achieved in upstream BMPs = 45 percent (given)
- 4) From **Figure III.6** $I_2 = 0.07$ in/hr
- 5) $I_1 - I_2 =$ design intensity = 0.16 in/hr
- 6) $Q_{LID} = [(0.95 \times 0.75 + 0.15) \times 0.16 \text{ in/hr} \times 3.5 \text{ ac}] = 0.48 \text{ cfs}$

Graphical operations supporting solution:

Figure III.6
Graphical Operations Supporting **Example III.7**

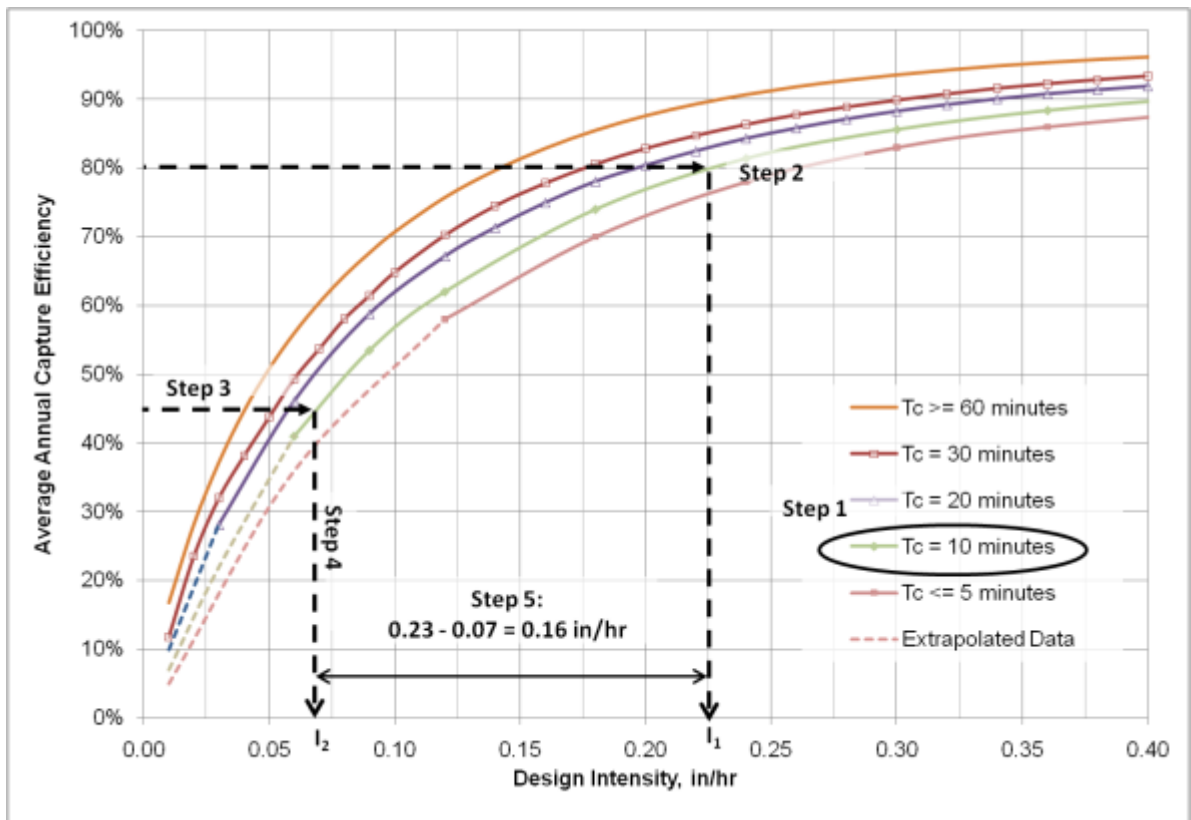

Worksheet D: Capture Efficiency Method for Flow-Based BMPs

Step 1: Determine the design capture storm depth used for calculating volume			
1	Enter the time of concentration, T_c (min) (See Appendix IV.2)	$T_c=$	
2	Using Figure III.4 , determine the design intensity at which the estimated time of concentration (T_c) achieves 80% capture efficiency, I_1	$I_1=$	in/hr
3	Enter the effect depth of provided HSCs upstream, d_{HSC} (inches) (Worksheet A)	$d_{HSC}=$	inches
4	Enter capture efficiency corresponding to d_{HSC} , Y_2 (Worksheet A)	$Y_2=$	%
5	Using Figure III.4 , determine the design intensity at which the time of concentration (T_c) achieves the upstream capture efficiency(Y_2), I_2	$I_2=$	
6	Determine the design intensity that must be provided by BMP, $I_{design}= I_1-I_2$	$I_{design}=$	
Step 2: Calculate the design flowrate			
1	Enter Project area tributary to BMP (s), A (acres)	$A=$	acres
2	Enter Project Imperviousness, imp (unitless)	$imp=$	
3	Calculate runoff coefficient, $C= (0.75 \times imp) + 0.15$	$C=$	
4	Calculate design flowrate, $Q_{design}= (C \times I_{design} \times A)$	$Q_{design}=$	cfs
Supporting Calculations			
Describe system:			
Provide time of concentration assumptions:			

Worksheet D: Capture Efficiency Method for Flow-Based BMPs

Graphical Operations

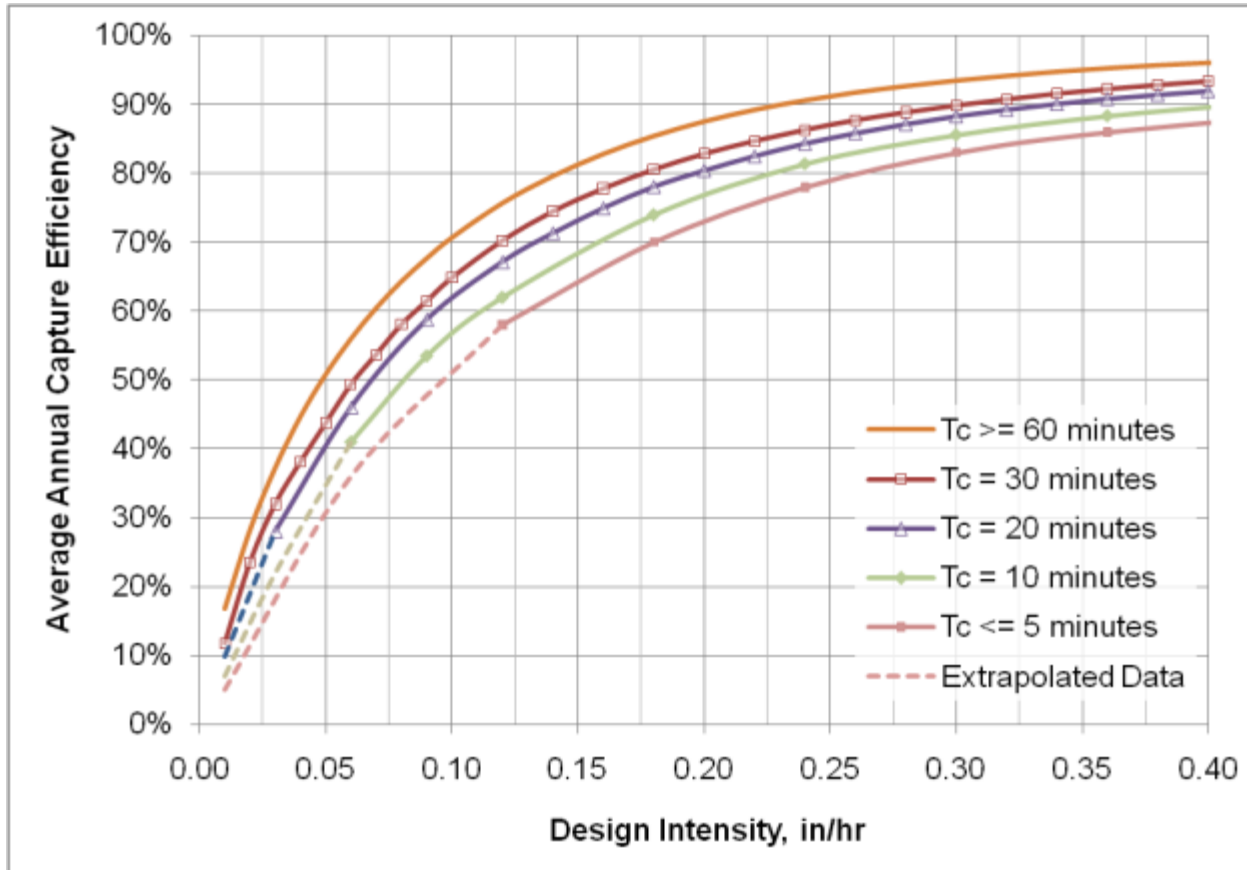

Provide supporting graphical operations. See Example III.7.

III.4. Nomograph Methods for BMP Performance Estimation

This section contains instructions for computing the performance of LID and treatment control BMPs based on the sizing and design of the system. These calculation methods are applicable where less than the full design volume is provided and it is necessary to quantify the level of control has been achieved (partial compliance) so that remaining design volume or flowrate can be calculated. The user enters these methods with a description of the system and the capture efficiency that has already been achieved by upstream BMPs. If it is desired to compute the the capture efficiency of a series of BMPs, the user starts with the upstream BMP and then repeats the steps for each sequential BMP provided.

III.4.1. Computing Capture Efficiency of Volume-based, Constant Drawdown BMP from Description of System Configuration

This section describes instructions for computing the capture efficiency for a given volume-based BMP configuration, considering the cumulative effects of upstream controls. This is applicable for BMPs that can be approximated to have a constant drawdown rate throughout the wet season and is applicable across Orange County.

Stepwise Instructions for Volume-based BMPs (without seasonally-varying use rate):

- 1) Determine the storage volume provided in the BMP, and use the equation presented in Section [III.1.1](#) to back-compute the effective design storm depth provided. Divide the provided storm depth by the design capture storm depth so that it is expressed as a fraction of the DCV. For example, if 0.6 inches of storage is provided and the design capture storm depth is 0.9 inches, then the provided volume would be expressed as $(0.6/0.9) = 0.67$ of the DCV.
- 2) Compute the drawdown time of the provided storage volume per guidance provided for respective BMPs in BMP Fact Sheets ([Appendix XIV](#)).
- 3) Determine the capture efficiency that has already been provided upstream. This will have already been computed in a previous iteration of this method if upstream BMPs are provided. Trace a horizontal line corresponding to this capture efficiency on [Figure III.2](#). Locate where this line intersects with the drawdown line (2). Pivot and read down to the horizontal axis. This is X_1 .
- 4) Add the result of (1) to the result of (3). This is X_2 .
- 5) Draw a vertical line at X_2 to intersect with the drawdown line.
- 6) Pivot and read to the vertical axis. This is the cumulative capture efficiency achieved by the BMP plus the upstream BMPs.

Example III.8: Determining the Capture Efficiency of a Volume-based, Constant Drawdown BMP Based on Description of System

Given:

- High Density Project in Rainfall Zone 4: 85th percentile, 24-hr storm depth = 0.95 inches
- Drainage Area = 3.5 acres
- Imperviousness = 95%
- HSCs: 0.2 inches total = 31 percent capture
- BMP Storage Volume Provided = 5,400 cu-ft with 72 hour drawdown

Required:

- Compute cumulative capture efficiency of the system described above

Solution:

- 1) Storage Volume Provided = 5,400 cu-ft (given).
 →Effective design storm depth, $d = 5,400 \text{ cu-ft} \times 12 \text{ in/ft} / [(0.95 \times 0.75 + 0.15) \times 3.5 \text{ ac} \times 43560 \text{ sf/ac}] = 0.49 \text{ inches}$ (See **Appendix III.1.1**)
 →Fraction of DCV = $0.49 \text{ inches} / 0.95 \text{ inches} = 0.52$
- 2) 72-hr constant drawdown (given)
- 3) 31 percent (0.2" of HSCs from **Table III.1**). From **Figure III.7**: $X_1 = 0.22$
- 4) $X_2 = 0.22 + 0.52 = 0.74$
- 5) $X_2 = 0.74$ (draw line up to 72 hour drawdown line)
- 6) From **Figure III.7**, the cumulative capture efficiency achieved by the combination of HSCs and the volumetric BMP is 65%.

Graphical operations supporting solution:

Figure III.7
Graphical Operations Supporting Example III.8

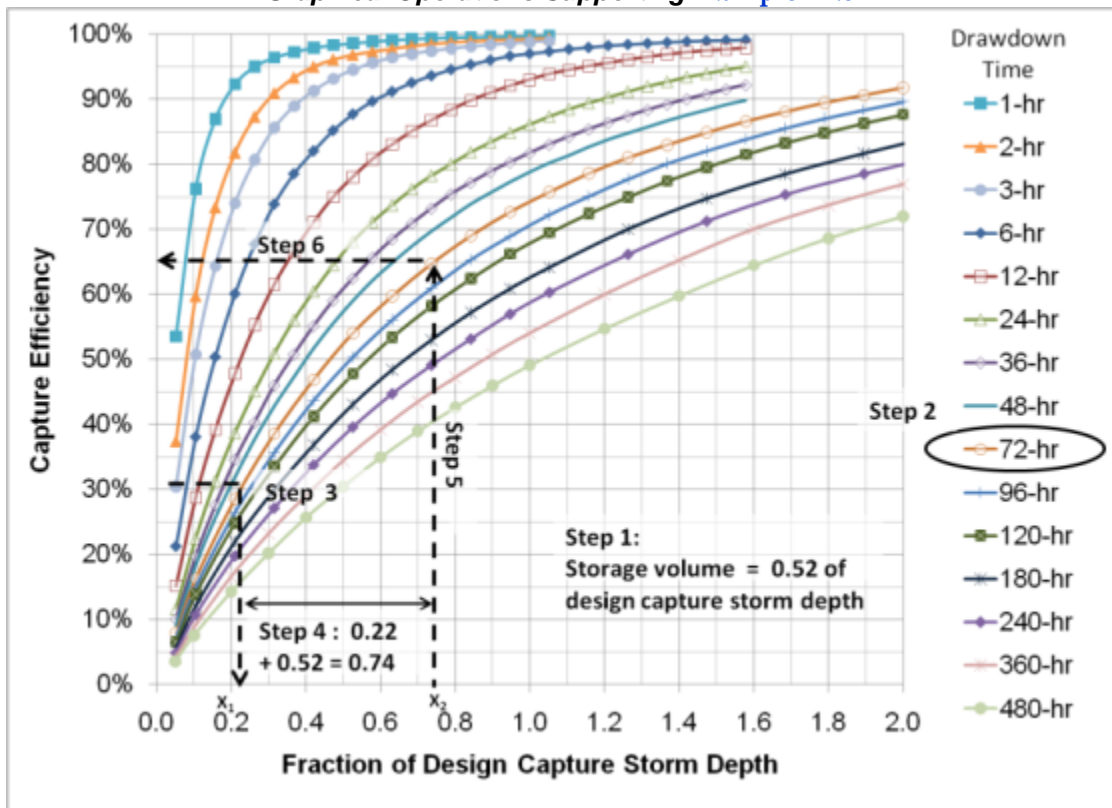

Worksheet E: Determining Capture Efficiency of Volume Based, Constant Drawdown BMP based on Design Volume

Step 1: Determine the design capture storm depth used for calculating volume			
1	Enter design capture storm depth from Figure III.1 , d (inches)	$d=$	inches
2	Enter the storage volume provided in the BMP, V (cu-ft)	$V=$	cu-ft
3	Enter Project area tributary to BMP (s), A (acres)	$A=$	acres
4	Enter Project Imperviousness, imp (unitless)	$imp=$	
5	Calculate runoff coefficient, $C= (0.75 \times imp) + 0.15$	$C=$	
6	Calculate the effective design storm depth provided (inches), $d_{provided}=(V \times 12)/(C \times A \times 43560)$	$d_{provided}=$	inches
7	Calculate the design storm depth as a fraction of the design capture depth, $X_{fraction} = d_{provided}/d$	$X_{fraction}=$	
Step 2: Calculate the capture efficiency of the BMP system			
1	Determine the drawdown time of the proposed BMP based on equations provided in the applicable BMP Fact Sheet, T (hours)	$T=$	hours
2	Enter the effect of provided HSCs upstream, d_{HSC} (inches) Worksheet A	$d_{HSC}=$	inches
3	Enter capture efficiency corresponding to d_{HSC} from Table 6.7 (regionally based), Y_1 Worksheet A	$Y_1=$	%
4	Using Figure III.2 , determine the fraction of "design capture storm depth" at which the drawdown time (T) achieves the upstream capture efficiency(Y_1), X_1	$X_1=$	
5	Determine the fraction of design capture storm depth corresponding to the cumulative capture efficiency, $X_2=X_1+X_{fraction}$	$X_2=$	
6	Using Figure III.2 , determine the capture efficiency corresponding to total fraction of design storm depth (X_2) for drawdown time (T), Y_2	$Y_2=$	%

Worksheet E: Determining Capture Efficiency of Volume Based, Constant Drawdown BMP based on Design Volume

Supporting Calculations

Describe system:

Provide drawdown calculations per equations in applicable BMP Fact Sheet:

Graphical Operations

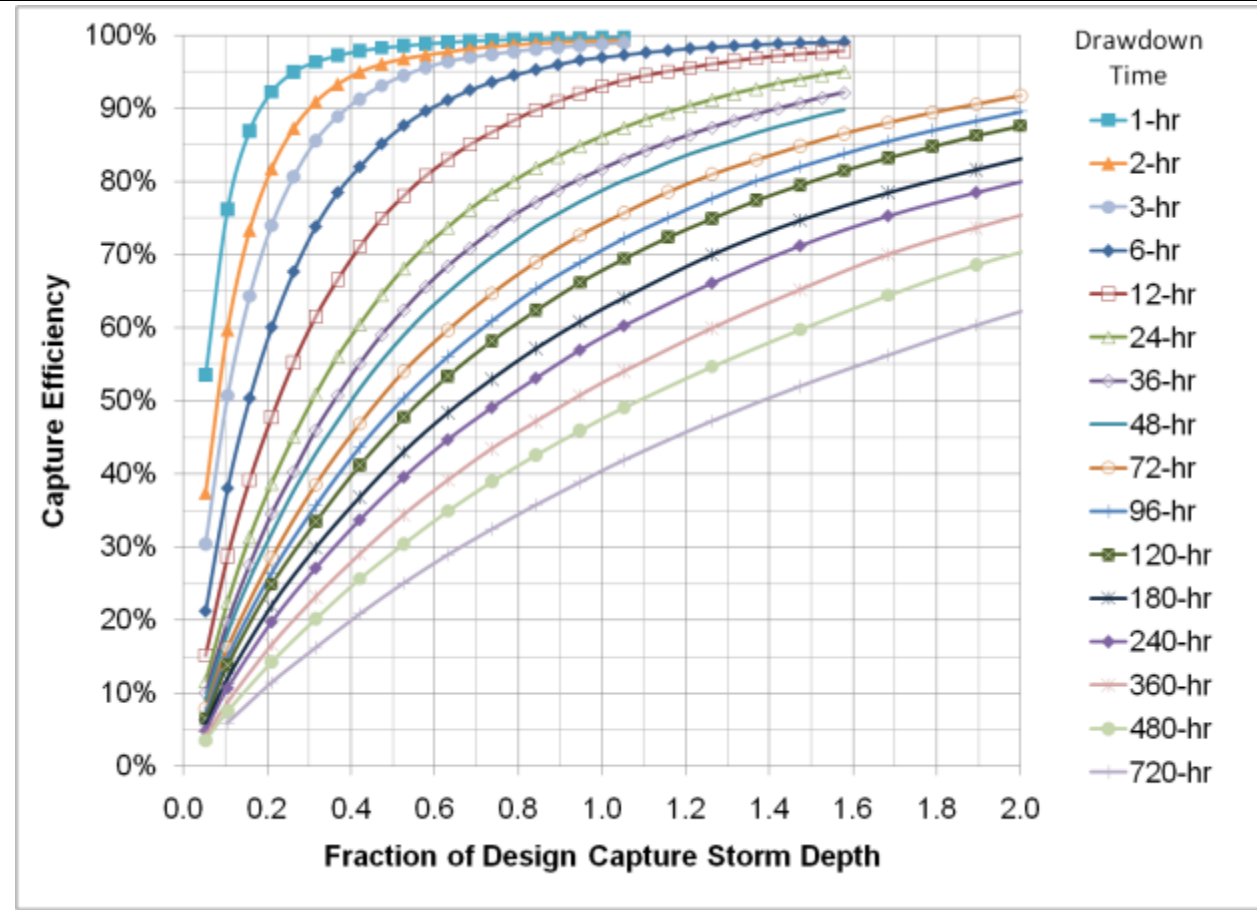

Use this graph to provide the supporting graphical operations. See [Example III.8](#).

III.4.2. Computing Average Annual Capture Efficiency of Harvest and Use BMPs with Seasonally-Varying Use Rate (Irrigation Demand) based on System Description

This section describes instructions for computing the capture efficiency for a given harvest and use BMP configuration with seasonally varying use rate (irrigation demand), considering the cumulative effects of upstream controls and is applicable across Orange County.

Stepwise Instructions for Harvest and Use BMP (with seasonally-varying irrigation demand):

- 1) Determine the storage volume provided in the BMP, and use the equation presented in **Appendix III.1.1** to back-compute the effective design storm depth provided. Divide the provided storm depth by the design capture storm depth so that it is expressed as a fraction of the DCV. For example, if 0.6 inches of storage is provided and the design capture storm depth is 0.9 inches, then the provided volume would be expressed as $(0.6/0.9) = 0.67$ of the DCV.
- 2) Estimate the effective irrigation area ratio of the system (EIATA):

$$EIATA = LA \times K_L / [IE \times \text{Tributary Impervious Area}]$$

Where:

EIATA = Effective Irrigated Area to Tributary Area ratio (ac/ac)

LA = landscape area irrigated with harvested water, sq-ft

K_L = Area-weighted landscape coefficient (see guidance and references in **Appendix X.2.5.2**)

IE = irrigation efficiency (assume 0.90)

- 3) Determine the capture efficiency that has already been provided upstream. This will have already been computed in a previous iteration of this method if upstream BMPs are provided. Trace a horizontal line corresponding to this capture efficiency on **Figure III.3**. Locate where this line intersects with the EIATA line (2). Pivot and read down to the horizontal axis. This is X_1 .
- 4) Add the result of (1) to the result of (3). This is X_2 .
- 5) Draw a vertical line at X_2 to intersect with the drawdown line.
- 6) Pivot and read to the vertical axis. This is the cumulative capture efficiency achieved by the BMP plus the upstream BMPs.

III.4.3. Computing Average Annual Capture Efficiency of Flow-based BMP Based on System Description

This section describes instructions for computing the capture efficiency for a given flow-based BMP configuration, considering the cumulative effects of upstream controls and is applicable across Orange County.

Stepwise Instructions for Flow-based BMPs:

- 1) Determine the design flowrate of the BMP, and use the equation presented in Section [III.1.1](#) to back-compute the effective design storm intensity provided.
- 2) Estimate the time of concentration (T_c) of the tributary area per Section [IV.2](#).
- 3) Determine the capture efficiency that has already been provided upstream. This will have already been computed in a previous iteration of this method if upstream BMPs are provided. Trace a horizontal line corresponding to this capture efficiency on [Figure III.4](#). Locate where this line intersects with the T_c line (2). Pivot and read down to the horizontal axis. This is I_1 .
- 4) Add the result of (1) to the result of (3). This is I_2 .
- 5) Draw a vertical line at I_2 to intersect with the T_c line.
- 6) Pivot and read to the vertical axis. This is the cumulative capture efficiency achieved by the BMP plus the upstream BMPs.

Worksheet F: Determining Capture Efficiency of a Flow-based BMP based on Treatment Capacity

Step 1: Determine the design intensity used for calculating design flowrate			
1	Determine the design flowrate of the BMP, Q (cfs)	Q=	cfs
2	Enter Project Imperviousness, <i>imp</i> (unitless)	imp=	
3	Calculate runoff coefficient, $C = (0.75 \times imp) + 0.15$	C=	
4	Back calculate the equivalent intensity of rainfall treated in the BMP (cfs), $i_{provided} = Q/C$	$i_{provided} =$	in/hr
Step 2: Calculate the capture efficiency of the flow-based BMP			
1	Enter the time of concentration, T_c (min) (Section IV.2)	$T_c =$	
2	Enter the effect of provided HSCs upstream, d_{HSC} (inches) Worksheet A	$d_{HSC} =$	inches
3	Enter the upstream capture efficiency corresponding to d_{HSC} from Table III.1 (regionally based), Y_1 Worksheet A	$Y_1 =$	%
4	Using Figure III.4 , determine the design intensity at which the time of concentration (T_c) achieves the upstream capture efficiency (Y_1), I_1	$I_1 =$	in/hr
5	Determine the cumulative design intensity that is provided by upstream and project BMPs, $I_2 = I_{provided} + I_1$	$I_2 =$	in/hr
6	Using Figure III.4 , determine the capture efficiency corresponding to the total intensity captured (I_2) for time of concentration (T_c) for upstream and Project BMPs, Y_2	$Y_2 =$	%
Supporting Calculations			
Describe system:			
Provide time of concentration assumptions:			

Worksheet F: Determining Capture Efficiency of a Flow-based BMP based on Treatment Capacity

Graphical Operations

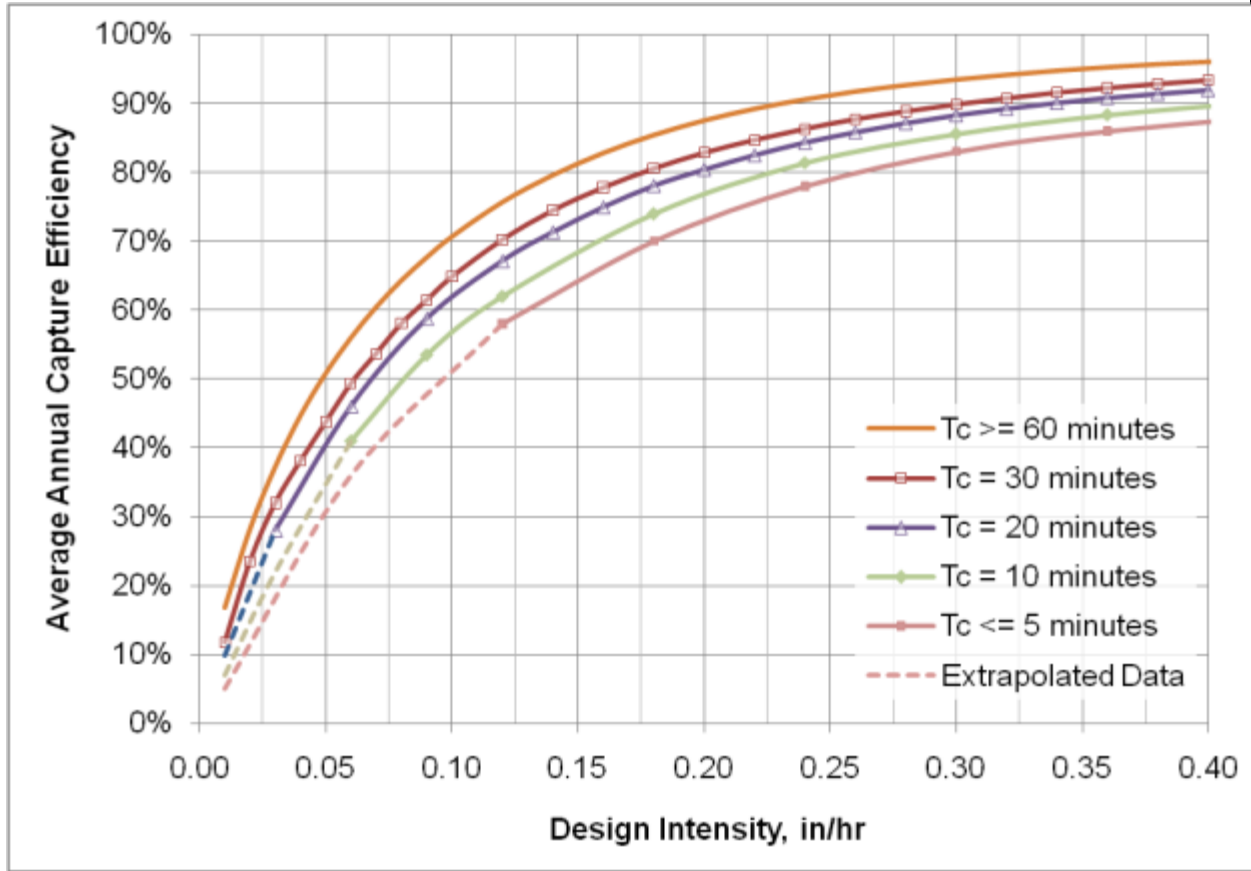

Provide supporting graphical operations.

III.5. Sizing Approaches for Treatment Trains and Hybrid Systems

BMP design to achieve maximum feasible retention and biotreatment for a given set of site constraints may consist of multiple parts (i.e., retention and biotreatment; volume-based and flow-based). For example, retention storage may be provided within the pores of amended soil in a bioretention area without underdrains, and the surface may function as a vegetated swale providing flow-based biotreatment. Or retention storage may be provided in a cistern which overflows to a planter box with underdrains to provide the remaining biotreatment volume.

The methods described in this Appendix can be used in combination to determine the incremental benefit of each component of the system. In most cases, the performance of the retention component would be estimated first using Section III.4 (depending on the BMP type), and then the biotreatment component would be sized using Section III.3.2 or III.3.3 to achieve the remaining capture up to 80 percent capture. This process would be used for the following examples:

- Retention volume provided in bioretention below underdrains, and biotreatment volume added above the underdrains.
- Retention storage provided within the pores of amended soil in a bioretention area without underdrains, and biotreatment provide in vegetated swale on surface of bioretention area.
- Retention storage provided in a cistern which overflows to a planter box with underdrains to provide the remaining biotreatment.
- Retention volume provided in an infiltration trench which overflows to a planter box with underdrains or vegetated swale to provide remaining biotreatment.
- Other similar configurations.

The exception to this process is when biotreatment is provided upstream of a retention BMP as pretreatment. In this case, there is not another opportunity to bio-treat water should it overflow from the retention BMP. Therefore the upstream BMP must treat the entire DCV (i.e., 80 percent capture of average annual runoff) before discharging to the retention BMP. Anything that overflows from the retention BMP would already be biotreated. This process would apply in the following example and similar examples:

- Pretreatment is provided in planter boxes with underdrains that discharge pre-treated water to an infiltration gallery. The planter boxes would be sized to capture 80 percent of average annual runoff and would not bypass untreated flow to the infiltration gallery. Overflow from the infiltration gallery would be considered biotreated provide that it is treated in the planter boxes before overflowing from the infiltration gallery. If overflow occurred prior to being treated in the planter box, the overflow would not be considered biotreated

III.6. Technical Basis for Capture Efficiency-based Performance Criterion

The purpose of this section is to provide the technical basis for the capture efficiency-based expression of the DCV used in throughout the Technical Guidance Document (TGD) and the calculation methods described in the sections above.

III.6.1. Introduction

Every stormwater BMP can be conceptualized as having a storage volume and a treatment rate, in various proportions. Both are important in the long-term performance of the BMP under a range of actual storm patterns, depths, and inter-event times. Long-term performance is measured by the operation of a BMP over the course of multiple years, and provides a more complete metric than the performance of a BMP during a single event, which does not take into account antecedent conditions, including multiple storms arriving in short timeframes. A BMP that draws down more quickly would be expected to capture a greater fraction of overall runoff (i.e. long-term runoff) than an identically sized BMP that draws down more slowly. This is because storage is made available more quickly, so subsequent storms are more likely to be captured by the BMP. In contrast a BMP with a long drawdown time would stay mostly full, after initial filling, during throughout periods of sequential storms. The volume in the BMP that draws down more quickly is more “valuable” in terms of long term performance than the volume in the one that draws down more slowly. In the case of flow-based BMPs, the storage volume is typically not substantial, however it is recognized that flow-based BMPs can achieve high long term capture efficiencies by treating stormwater essentially as it arrives. A method is needed to relate the long-term performance of BMPs to their design attributes so that a common grounds for comparison and “addition” of the benefit of different BMPs is possible.

The permit definition of the LID DCV does not specify a drawdown time, therefore the definition is not a complete indicator of a BMP's level of performance. An accompanying performance-based expression of the LID sizing standard is essential to ensure uniformity of performance across a broad range of BMPs and helps prevents LID BMP designs from being used that would not be effective.

III.6.2. Development of Capture Efficiency-based Performance Criterion

An evaluation of the relationships between BMP design parameters and expected long term capture efficiency has been conducted to address the needs identified above. Relationships have been developed through a simplified continuous simulation analysis of precipitation, runoff, and routing, that relate BMP design volume and storage recovery rate (i.e., drawdown time) to an estimated long term level of performance.

Based on these relationships, it has been demonstrated that a BMP sized for the runoff volume from the 85th percentile, 24-hour storm event (i.e., the DCV), which draws down in 48 hours is capable of managing approximately 80 percent of the average annual. There is long precedent

for the assumption that BMPs should draw down in approximately 48 hours, and there is also long precedent for 80 percent capture of average annual runoff as approximately the point at which larger BMPs provide decreasing capture efficiency benefit (also known as the “knee of the curve”) for BMP sizing. The characteristic shape of the plot of capture efficiency versus storage volume (Figure III.2) illustrates this concept.

As such, this equivalency (between the DCV drawing down in 48 hours and 80 percent capture) has been utilized to fill three needed roles in this TGD: 1) provide a common currency between volume-based BMPs with a wide range of drawdown rates, 2) provide a means of unifying the sizing of volume-based and flow-based BMPs to allow different types of BMPs to be added as part of a treatment train, and 3) allow flexibility in the design of BMPs while ensuring consistent performance.

III.6.3. Modeling Methodology

The USEPA Stormwater Management Model Version 5.0 (SWMM5.0) was used to simulate the long term average capture efficiency for a range of general BMP design configurations over 22 years of historic hourly precipitation records at the CIMIS Irvine weather station (#75). SWMM was selected for this analysis as it is a relatively simple, open source, continuous simulation model that has well-demonstrated capability for simulation of rainfall-runoff processes in urban environments and simulating transient storage mechanisms in BMPs. A relatively simple representation of BMPs was used to develop the general relationships that conceptualized all BMPs with a simple storage volume and treatment rate. While this representation does not account for the nuances of BMP designs, it is appropriate to develop programmatic sizing factors. Assumed SWMM input parameters are provided in Table III.2. Sensitivity analyses demonstrated that the only inputs with significant sensitivity within typical input ranges were the precipitation and ET inputs and the BMP configurations. These were selected to be representative of Orange County, and results are interpreted to allow scaling across the rainfall zones of the County.

Table III.2: SWMM Simulation Input Parameters

SWMM Parameters	Units	Values
Period of Simulation	years	22 yrs (10/01/1987 to 10/01/2009)
Wet time step	seconds	600
Wet/dry time step	seconds	600
Dry time step	seconds	14,400
Precipitation	inches	Hourly precipitation data from CIMIS Irvine Gage (#75) 279 inches total in period of record
Impervious Manning's n		0.012
Hypothetical drainage area	acres	1
Shape		Rectangular, 250 ft flow path length
Impervious fraction modeled		100%
Slope	ft/ft	0.05
Evaporation	inches	Daily ET data from CIMIS Irvine Gage (#75) 1092 inches reference ETo total in period of record
Depression storage, impervious	inches	0.02, based on Table 5-14 in SWMM manual (James and James, 2000)
Runoff coefficient used to convert precipitation depth to design volume	unitless	0.90
Design capture storm depth (85 th percentile, 24-hour depth) calculated from Irvine Gage	inches	0.95
BMP Storage Volume	cu-ft	Varied over continuous range as discrete multipliers on design capture storm depth. Volume at 1.0 x DCV = 0.95 inches x 0.9 x 43,560 sq-ft x (1 ft/12 inches) = 3,100 cu-ft
Drawdown Rate	cfs	Varied over continuous range to represent discrete drawdown times. $Q \text{ (cfs)} = V \text{ (cu-ft)} / \text{Drawdown time (s)}$ Drawdown rate @ 1.0 x DCV @ 48 hour drawdown time = 3,100 cu-ft / (48 hr x 3600 s/hr) = 0.018 cfs

III.6.4. Detailed Results and Findings

The resulting average annual capture efficiency (i.e., the fraction of average annual runoff that is captured and not immediately bypassed by the BMP) was extracted from model results for each model. The assumed impervious fraction of 100 percent is not important for this analysis because both runoff volume and modeled BMP volume have approximately linear dependency on impervious fraction.

Because this analysis was done at one location in the County, a method is needed to scale these results to different precipitation zones. Areas with larger design capture storm depths (85th percentile, 24-hour depth) should theoretically require larger BMPs for an identical configuration of tributary area and drawdown time. An analysis of several gages in Southern

California has shown that normalizing input scenarios as a fraction of the design capture storm depth allows reliable extrapolation of results throughout the region. These relationships are represented by the nomograph shown as Figure III.2. Functionally, what these relationships show is that for drawdown times larger than 48 hours, a design volume greater than the DCV is needed to achieve 80 percent capture, while for drawdown times less than 48 hours, a design volume less than the DCV can be used to achieve 80 percent capture.

An analogous analysis was conducted for systems with irrigation demand by normalizing input scenarios to fractions of the design capture storm depth and the effective irrigation area to tributary area ratio (EIATA). This analysis considered irrigation demand to be controlled by the area irrigated, landscape demand of this area (i.e., fraction of ETo required for plant use) and the daily ETo timeseries. It was assumed that irrigation would not occur following rainfall until the ET had either summed to a depth equivalent to the rainfall depth or had exceeded 0.25 inches (smaller of these two). Performance relationships are shown in Figure III.3.

III.6.5. Development of Flow-based BMP Capture Efficiency Nomographs

Flow-based BMPs do not have substantial storage volume; therefore function by treating runoff at the rate which it occurs. The concept of a uniform design intensity is commonly used for sizing criteria of flow-based BMPs. This design intensity is appropriately tied to the time of concentration (T_c) of the tributary area, where larger tributary areas should have a lower design intensity because greater attenuation of event peaks is provided in the watershed and the BMP sees lower peaks. While simplified, it can be conceptualized that the T_c of a watershed is the averaging period within which peaks should be averaged.

Because most urban watersheds have T_c much less than 1 hour, hourly precipitation data are not adequate to develop relationships between T_c and the required design intensity to manage a certain percentage of average annual runoff volume. Therefore, 10 years of 5-minute, 0.01" resolution precipitation data were obtained from the Automated Surface Observation System (ASOS) gage at Los Angeles International Airport and used for this analysis.

To represent different increments of T_c , different averaging periods were applied. The resulting intensities were then compared to a range of design intensities to determine the fraction of average annual runoff that intensity would be capable of addressing. It was assumed that if the measured intensity was less than the design intensity, that volume would be fully treated, and if the measured intensity was greater than the design intensity, the volume up to the design intensity would be treated. This implicitly assumes that BMPs are designed to be off-line and maintain their treatment processes even during peak flows.

Figure III.4 presents average annual capture efficiency results for a variety of design storm intensities and drainage area times of concentration.

III.6.6. Note on Using Nomographs to Combine BMPs in Series

The nomographs presented in Figure III.2, Figure III.3, Figure III.4 each show declining response of capture efficiency with design volume and intensity. For example, from Figure III.2, approximately 25% of the DCV is required to achieve the first 40 percent capture of average annual runoff volume, while the remaining 75 percent of the DCV is required to achieve the remaining 40 percent. As such, when combining BMPs in series, capture efficiencies are not directly additive. In order to add the combined effects of BMPs in series, the nomographs should be used by starting at the point on the chart corresponding to the capture efficiency already achieved in upstream BMPs, and moving to the right on the chart along the line corresponding to the drawdown time of the current BMP of interest. This ensures that the appropriate portion of the volume-capture response curve is used.

APPENDIX IV. APPROVED METHODS FOR QUANTIFYING HYDROLOGIC CONDITIONS OF CONCERN (NORTH ORANGE COUNTY)

Hydromodification design criteria for the North Orange County permit area are based on the 2-yr, 24-hr storm event runoff volume, time of concentration, and peak flowrate. Hydrologic analysis of the 2-year, 24-hour storm shall be conducted using the methods described in this section. These include:

- The methods described in the [Orange County Hydrology Manual](#) (OCEMA 1986).
- The methods described in [Technical Release 55 \(TR-55\): Urban Hydrology for Small Watersheds](#) (NRCS 1986). TR-55 has the capacity to model watersheds with drainage areas ranging from 0.01 acre (although results from catchments less than 1 acre should be carefully examined) to 25 square miles and time of concentrations ranging from 6 minutes to 10 hours (NRCS 2009).

Priority Projects have the option to either perform the hydrologic calculations using computer simulations or hand calculations. If the [Orange County Hydrology Manual](#) method is used, the Watershed Modeling System (WMS) software with the Orange County Rational Method interface or hand calculations should be used, consistent with the [Orange County Hydrology Manual](#). If the TR-55 method is used, then either the WinTR-55¹⁰ or HEC-HMS¹¹ programs are appropriate or hand calculations should be consistent with the [TR-55 manual](#) (NRCS, 1986).

Advantages of using computer simulations is that the runoff hydrograph can be produced with relative ease, which is ideal when simulating post-project drainage conditions which route runoff through detention BMPs. Routing a hydrograph through a BMP is more arduous and time consuming if calculated by hand.

An advantage of WMS with the Orange County Rational Method interface is that it is often used for generating design flows of less frequent design storm events (i.e., 10-year, 25-year, or 100-year) required of flood control analyses, so the same WMS model could be used for both the flood and hydromodification control analyses. It is important to note that WMS is not a

¹⁰ Free WinTR-55 software can be downloaded at:
http://www.wsi.nrcs.usda.gov/products/w2q/h&h/tools_models/wintr55.html

¹¹ Free HEC-HMS software can be downloaded at: <http://www.hec.usace.army.mil/software/hec-hms/download.html> Loss parameters shall be set to the SCS Curve Number method, transform parameters must be set to the SCS Unit Hydrograph method, and reach routing parameters must be set to the Muskingum-Cunge method.

continuous simulation hydrologic model, and thus cannot be used to meet the South Orange County permit area hydromodification control criteria.

IV.1. Hydrologic Method for 2-year Runoff Volume and Peak

IV.1.1. Storm Depth and Distribution

The 2-yr, 24-hour precipitation depths specified in the [Orange County Hydrology Manual](#) shall be used for hydrologic analysis of the 2-year, 24-hour storm.

- For drainage areas below 2,000 feet in elevation a 2.05 storm depth shall be used.
- For drainage areas above 2,000 feet in elevation a 3.81 storm depth shall be used.
- If the [Orange County Hydrology Manual](#) is updated over the life of this TGD, the updated 2-year, 24-hour storm depths contained in the updated *Manual* shall supersede these depths.

When using the TR-55 method to produce a hydrograph, the user shall select the Type I rainfall distribution. When using the [Orange County Hydrology Manual](#) method, rainfall distribution is imbedded in the WMS-Orange County interface and is provided in the [Orange County Hydrology Manual](#) in Section B.

IV.1.2. Runoff Volume

If calculations are performed by hand, the runoff volumes in the existing and proposed conditions shall be calculated using Section C of the [Orange County Hydrology Manual](#) or Chapter 2 of the [TR-55 manual](#), which have the same basic methodology. Where inconsistencies (e.g., selection of curve numbers) exist between the two documents, the [Orange County Hydrology Manual](#) shall take precedence. For projects less than 5 acres, the difference between runoff volumes in existing and proposed conditions may optionally be calculated using the simple runoff coefficient method (**Appendix III.1.1**). This method tends to under-predict runoff that would occur from pervious areas during a relatively large design storm (pervious runoff coefficient = 0.15) and is likely fairly accurate for runoff from impervious areas (impervious runoff coefficient = 0.90). Therefore, this method tends to result in a larger difference between existing and post-developed runoff coefficient than would be calculated using a more detailed hydrologic analysis and is therefore acceptable where the project proponent elects not to conduct a more detailed hydrologic analysis.

If runoff calculations are performed with modeling software, the runoff volume shall be taken as an output of the WMS-Orange County, WinTR-55, or HEC-HMS models. Input selection for these models shall be consistent with the recommendations found Section C of the [Orange County Hydrology Manual](#) or the [WinTR-55 Users Guide](#). Where inconsistencies (e.g., selection of curve numbers) exist between the two documents, the [Orange County Hydrology Manual](#) shall take precedence.

When evaluating the effect of retention BMPs on proposed condition runoff volume, volume reduction shall be calculated as the volume that is infiltrated, evapotranspired, or used (i.e., drawn down) over a period of 48 hours, starting at the BMP brim full capacity. Volume treated and discharged to surface water shall not be considered in this calculation. The volume reduction shall not be greater than the total retention volume in the BMP.

IV.1.3. Peak Runoff Flowrate

Peak runoff flowrate shall be calculated using one of the following methods depending on watershed size:

The Rational Method described in Section D of the [Orange County Hydrology Manual](#) shall be used for drainage areas less than 1 square mile (640 acres). For redevelopment projects less than 5 acres, the simplified runoff coefficient method described in **Appendix III.1.2** can be used to compute the runoff coefficient for rational method calculations.

The Unit Hydrograph Method described in Section E of the [Orange County Hydrology Manual](#) shall be used for drainage areas greater than or equal to 1 square mile.

Alternatively, peak flowrate shall be calculated using the Graphical Peak Discharge Method described in Chapter 4 of the [TR-55 manual](#) or the Tabular Hydrograph Method described in Chapter 5 of the same document. When evaluating the effect of BMPs on the proposed condition peak runoff flowrate, the effect of the BMP should be estimated using one of the aforementioned modeling programs because hand calculations are not ideal for the routing analyses required.

Example [IV.1](#) provides an example runoff volume and peak flow calculation for a simple project using WinTR-55. This example is not intended to be exhaustive of the methods that could be used to calculate runoff volume and peak flow.

IV.2. **Hydrologic Method for Time of Concentration**

Time of concentration (T_c) shall be calculated using one of the following approved methods:

If computing by hand, the methods described in Section D of the [Orange County Hydrology Manual](#) or the [TR-55 manual](#) shall be used. The Orange County method entails summing the initial time of concentration, based on a nomograph, with the subsequent time it takes to pass flow through downstream conveyances. The TR-55 method sums the travel times for sheet flow, shallow concentrated flow, and channel flow for a given flow path.

If using a modeling tool, the WinTR-55 model is the only tool that provides an acceptable model-calculated method of calculating T_c through its Time of Concentration Details window. The inputs provided to this window shall be per guidance contained in the [Orange County Hydrology Manual](#) or the [TR-55 manual](#) and shall be submitted with the Project WQMP documentation.

WMS-Orange County will help the user estimate the T_c of a subarea when using the GIS interface or it can be entered manually. HEC-HMS does not assist the user in estimating T_c and its transform input parameter is actually lag time, which is 0.6 times the T_c , according to an empirical relationship developed by the Natural Resource Conservation Service (NRCS). The use of these models must be supported by hand calculations of T_c per criteria above.

When evaluating the effect of storage and treatment BMPs on the proposed condition time of concentration, the BMP lag component of T_c shall be estimated as the time required for the BMP to be discharging to the downstream receiving water during the design storm simulation. This can be calculated by (1) determining the volume the BMP can receive before it begins to discharge, (2) plotting the post-developed runoff hydrograph for the 2-year, 24-hour storm event, and (3) by determining the time on the hydrograph at which the cumulate volume exceeds the volume calculated in step 1.

Example IV.1 provides an example time of concentration calculation for a simple project using the T_c window in WinTR-55. This example is not intended to be exhaustive of the methods that could be used to calculate T_c .

IV.3. Hydrologic Calculation Examples with WinTR-55

Example IV.1: Computing Volume and Peak Flowrate Using WinTR-55

Given:
<ul style="list-style-type: none"> • Project Elevation: 1,200 ft • Drainage Area = 2.0 acres • Hydrologic Soil Group = B • Existing Condition: 1.8 acres of herbaceous grassland in fair condition, with 0.2 acres of miscellaneous roads and structures; imperviousness = 11 percent • Existing flow path: 100 ft overland sheet flow @ 3% slope, 50 ft shallow concentrated flow @ 3% slope (unpaved), 300 ft ditch @ 0.5% slope • Proposed Condition: multi-family residential; imperviousness = 80 percent • Proposed flow path: 100 ft overland sheet flow @ 10% slope (roofs and driveways); 400 ft of stormdrain @ 0.5% slope
Required:
<ul style="list-style-type: none"> • Calculate runoff volume and peak flowrate in existing and proposed conditions • Compute BMP volume needed to reduce post-developed runoff volume to within 5% of existing condition runoff volume for the 2-year storm event.
Results:
<p>1) Existing Condition: Peak Flow Rate (cfs) = 0.28, Runoff Volume (cubic feet) = 1,249, Proposed Condition: Peak Flow Rate (cfs) = 2.01, Proposed Runoff Volume (cubic feet) = 9,039</p>

2) Required BMP Volume (cubic feet) = $(9,039 - (1,249 \times 1.05)) = 7,730$ cu-ft

Solution Steps:

1) Open WinTR-55 and complete the “Project Identification” fields (Figure IV.1).

Figure IV.1: WinTR-55 home screen

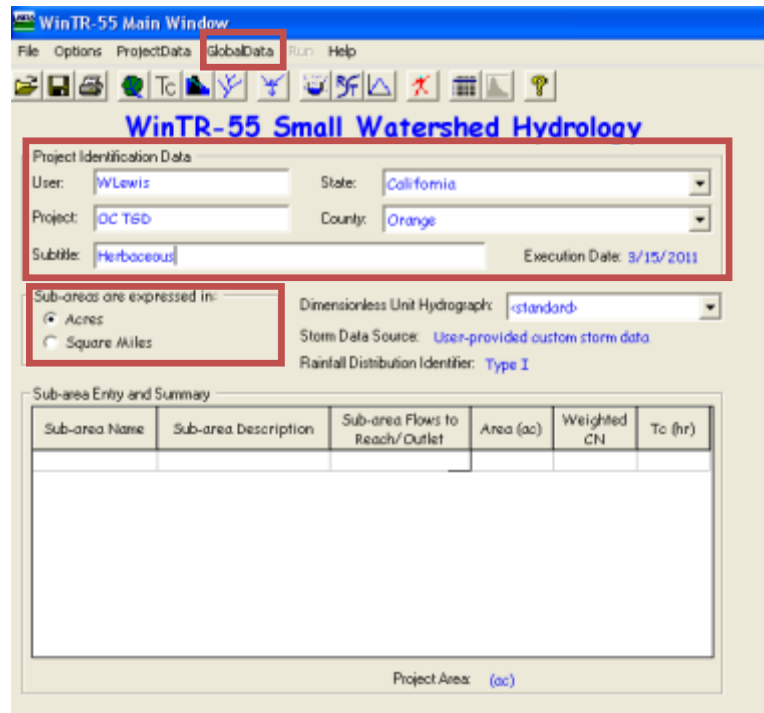

- 2) Under the "GlobalData" heading select "Storm Data" and select "Type 1" as the rainfall distribution type and enter 2.05" as the 2-year storm event (the project is below an elevation of 2,000 feet. The design storm would be 3.81" if the project was located above 2,000 feet.) (Figure IV.2). Accept these changes and save the project.

Figure IV.2: WinTR-55 Storm Data screen

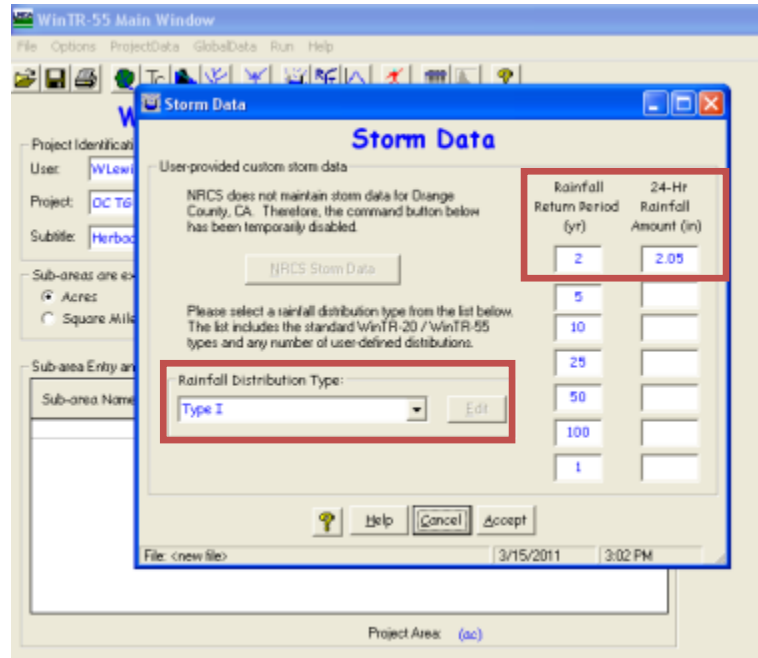

- From the home screen, select "Land Use Details" from the "ProjectData" heading, name the sub-area, and select the radio button for "Arid Rangeland" to begin setting up the existing condition. Enter 1.8 acres for "Herbaceous - Fair Condition" under Hydrologic Soil Group B before selecting the "Urban Area" radio button and entering 0.2 acres under "Paved parking lots, roofs, and driveways," again for Hydrologic Soil Group B (Figure IV.3). The program will calculate an area weighted curve number. Accept changes and return to the home screen.

Figure IV.3: WinTR-55 Land Use Details screen

Land Use Details

Sub-area Name: Area 5a Her

Land Use Categories: Urban Area Developing Urban Cultivated Agriculture Arid Rangeland

Cover Description	Condition	Area (Acres) for Hydrologic Soil Groups				
		A	B	C	D	
ARID AND SEMIARID RANGELANDS						
Herbaceous	Poor			88	87	83
	Fair		1.800	77	81	89
	Good			62	74	85
Oak - aspen	Poor			66	74	79
	Fair			48	57	63
	Good			38	47	46
Pinyon - juniper	Poor			75	85	89
	Fair			58	73	80
	Good			47	63	77
Sagebrush (w/ grass understory)	Poor			67	86	85
	Fair			57	63	70
	Good			35	47	55

Project Area (ac): 1.80 Summary Screen: Off Sub-Area Area (ac): 1.80 Weighted CN: 72

File: (new file) 3/15/2011 3:14 PM

- 4) Select "Outlet" under the "Sub-area Flows to Reach/Outlet" pull-down menu.
- 5) Under the "ProjectData" heading select "Time of Concentration Details" and enter lengths, slopes, and Manning's roughness coefficients (if necessary) for relevant flow types (Figure IV.4). Save the project.

Figure IV.4: WinTR-55 Time of Concentration Details screen

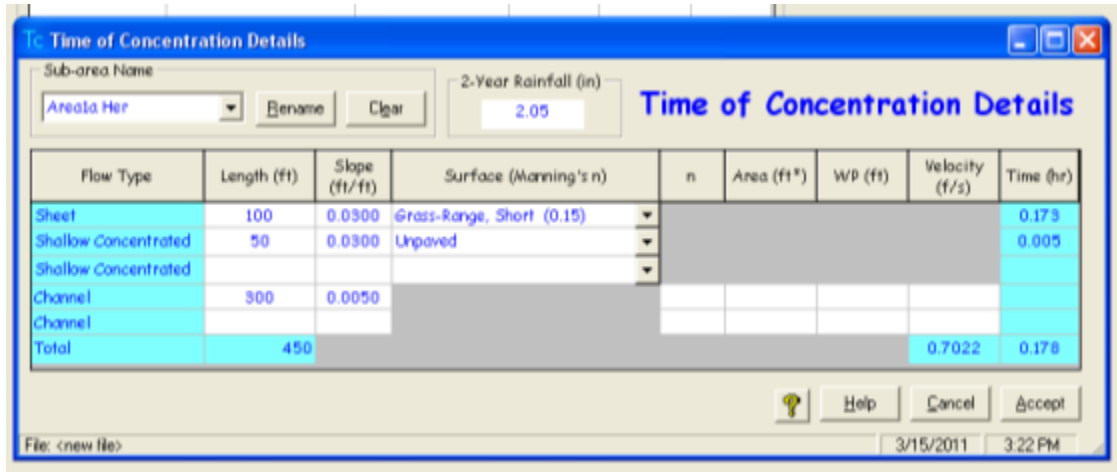

- 6) Select the “Run” heading and ensure that the 2 year storm box is checked. No other recurrence interval storm depths were entered and are therefore not an option (Figure IV.5).

Figure IV.5: WinTR-55 Run Model screen

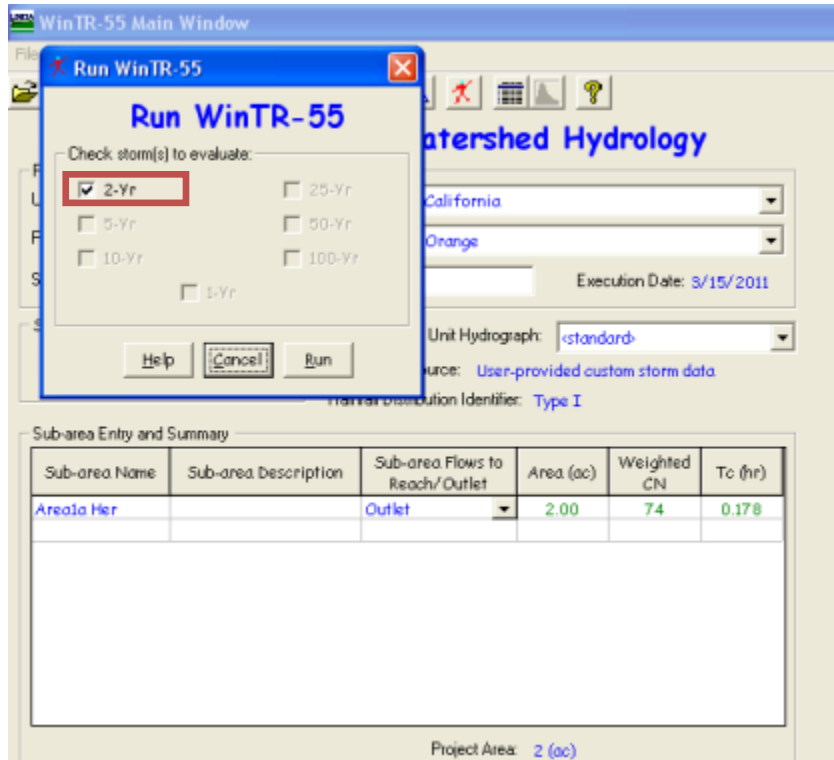

- 7) Peak discharge is provided in the “Hydrograph Peak/Peak Time Table” that appears following the completion of the model run. Record the “Peak Discharge (cfs)” (Figure IV.6).

Figure IV.6: WinTR-55 Hydrograph Peak/Peak Timetable screen

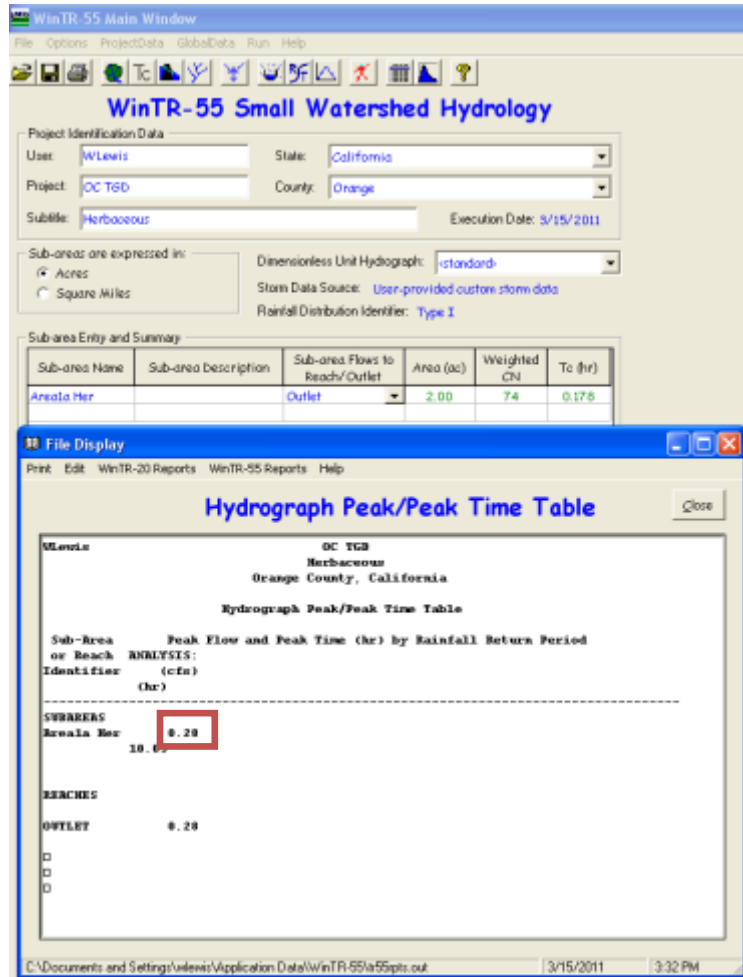

- 8) Within the “Hydrograph Peak/Peak Time Table” select the WinTR-20 pull-down menu and select “Printed Page File” to access the “WinTR-20 Printed Page File.”
- 9) Scroll down to the page titled TR20.out and record the “Runoff Amount (in).” Convert the rainfall runoff depth into acre feet (dividing by 12 inches/foot and multiplying by the total acreage). Record the total volume of runoff from the modeled area (Figure IV.7).

$$\text{Existing 2-yr Runoff volume} = 0.172 \text{ inches} \times 2 \text{ acres} \times 43,560 \text{ sq-ft/ac} \times 1\text{ft}/12\text{inches} = 1,249 \text{ cu-ft}$$

Figure IV.7: WinTR-20 Printed Page File screen

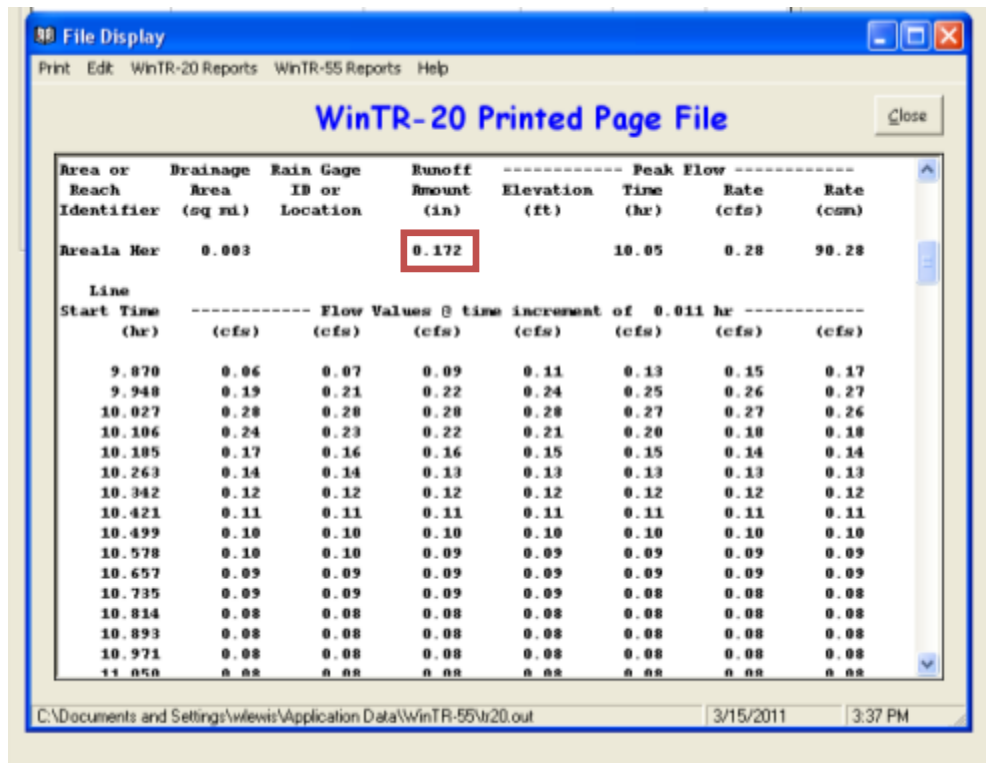

- 10) From the same “WinTR-20 Printed Page File” select the time and rate of runoff values for the duration reported and transfer these values into a plotting program (i.e. Microsoft Excel®) (Figure IV.7). Save Project, WinTR-20, and WinTR-55 outputs as records.
- 11) Initiate a second WinTR-55 Project and complete steps 1 through 11 for the proposed scenario. Selection of land uses for the proposed condition shall be limited to options under the headings of “Fully Developed Urban Areas (Veg Estab.)” and “Impervious Area” (Figure IV.8). Selected land uses should reflect the proposed percent impervious (i.e. 80% impervious would be represented by selecting 80% “Paved parking lots, roads, driveways” and 20% for the appropriate pervious condition by area).

Figure IV.8: WinTR-55 Proposed Condition Land Use Details screen

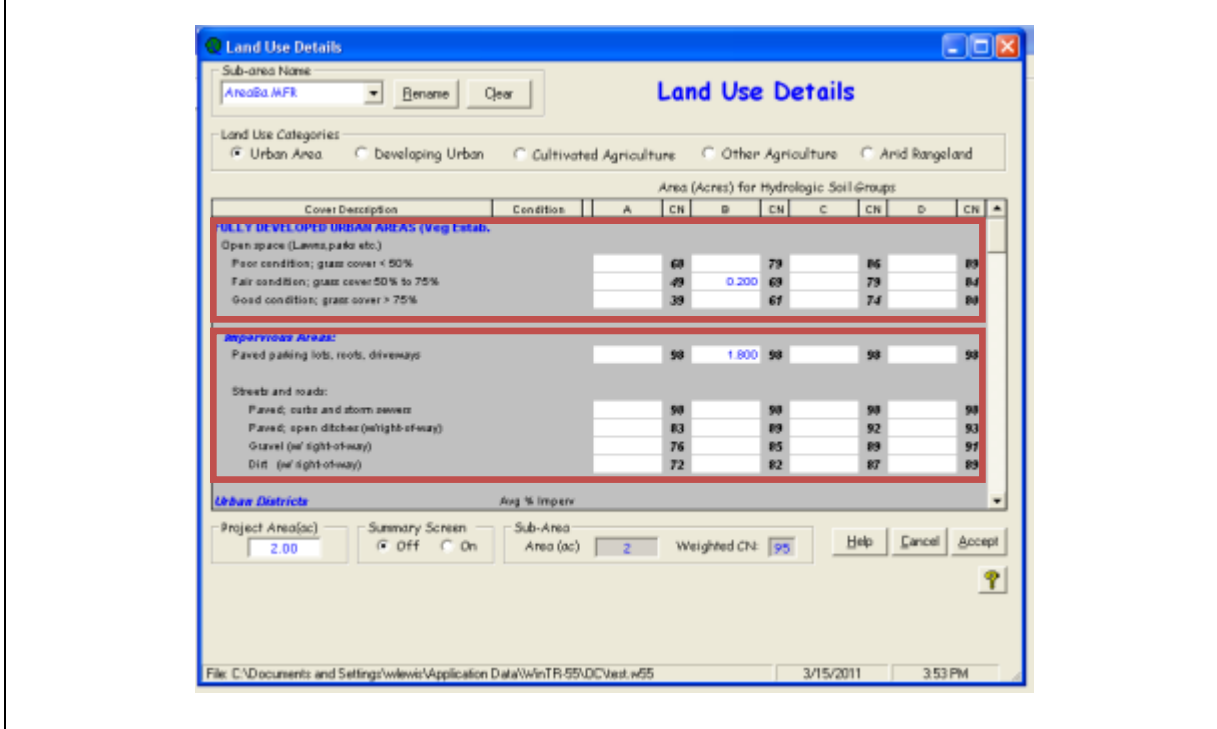

Example IV.2: Computing Time of Concentration using TR-55 Methods

Given:

- 1) Project Elevation: 1,200 ft
- 2) Drainage Area = 2.0 acres
- 3) Hydrologic Soil Group = B
- 4) Existing Condition: 1.8 acres of herbaceous grassland in fair condition, with 0.2 acres of miscellaneous roads and structures; imperviousness = 11 percent
- 5) Existing flow path: 100 ft overland sheet flow @ 3% slope, 50 ft shallow concentrated flow @ 3% slope (unpaved), 300 ft ditch @ 0.5% slope
- 6) Proposed Condition: multi-family residential; imperviousness = 80 percent
- 7) Proposed flow path: 100 ft overland sheet flow @ 10% slope (roofs and driveways); 400 ft of stormdrain @ 0.5% slope
- 8) Infiltration basin proposed for project with retention storage capacity of 7,730 cu-ft (See Example IV.1)

Required:

- a. Calculate T_c of existing condition
- b. Calculate T_c of proposed condition without BMPs

c. Calculate effective T_c of proposed condition with BMPs

Solution:

- 1) 0.178 hr
- 2) 0.013 hr (0.1 used by TR-55 as a minimum value)
- 3) 9.94 hr

Solution Steps:

- 1) See Example [IV.1](#) Steps 1 through 12 for direction in setting up existing and proposed WinTR-55 models, recording relevant information, and obtaining data to plot hydrographs.
- 2) Times of Concentration for existing conditions and proposed conditions without BMPs can be taken directly from the WinTR-55 T_c model screen.
- 3) The time of concentration of the proposed condition with BMPs can be estimated as difference between the point of the storm event where runoff begins and the point in the storm event at which the runoff volume exceeds the BMP volume and discharge would be expected to occur. The timeseries output from the TR-20 window can be plotted in a spreadsheet program. Based on this example, runoff begins 7.6 hours and the runoff volume exceeds the BMP volume (7,730 cu-ft) at 18.6 hours. Therefore the effective time of concentration with the BMP included is approximately 11 hours. This is clearly not a concern and more detailed assessment of T_c is not required.

Figure IV.9: Existing and proposed hydrographs

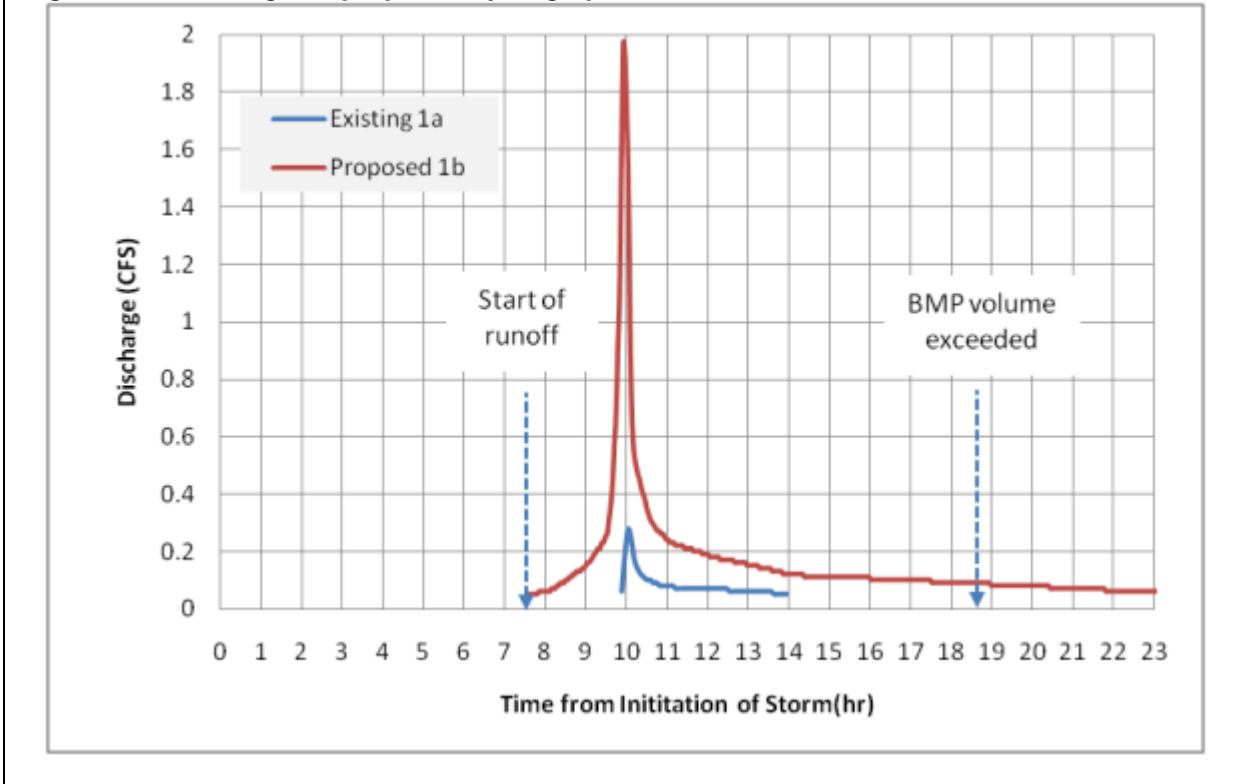

APPENDIX V. APPROVED METHODS FOR QUANTIFYING HYDROLOGIC CONDITIONS OF CONCERN (SOUTH ORANGE COUNTY)

If a HCOC exists, projects in the South Orange County permit area shall use an approved continuous simulation model such as EPA Stormwater Management Model (SWMM) or EPA Hydrologic Simulation Program – FORTRAN (HSPF), to evaluate compliance with the flow-duration-based performance criteria of the interim hydromodification standard. The following sections describe design references that have been prepared to streamline and guide these calculations.

The final hydromodification standard requires the preparation of a hydromodification management plan (HMP), which will prescribe the hydrologic analysis methods and performance criteria that will apply. When the SOC HMP is adopted, it will supersede the requirements of this section to the extent that it is applicable.

V.1. Hydromodification Control Flow Duration Control Analysis

The interim hydromodification standard in the South Orange County permit area focuses on controlling hydromodification by mimicking pre-development (naturally occurring) flow magnitudes and durations over a long period of record rather than for the discrete 2-year storm event. A flow duration curve is the primary means of demonstrating changes in flow magnitudes and durations over a continuous period of record. A flow-duration curve is a plot of discharge versus the duration of time the discharge is exceeded. It is developed through continuous simulation of project under the following conditions: pre-developed (natural), post-developed, and post-developed with controls. An example flow duration curve is show in [Figure V.1](#).

Figure V.1. Example Flow Duration Chart

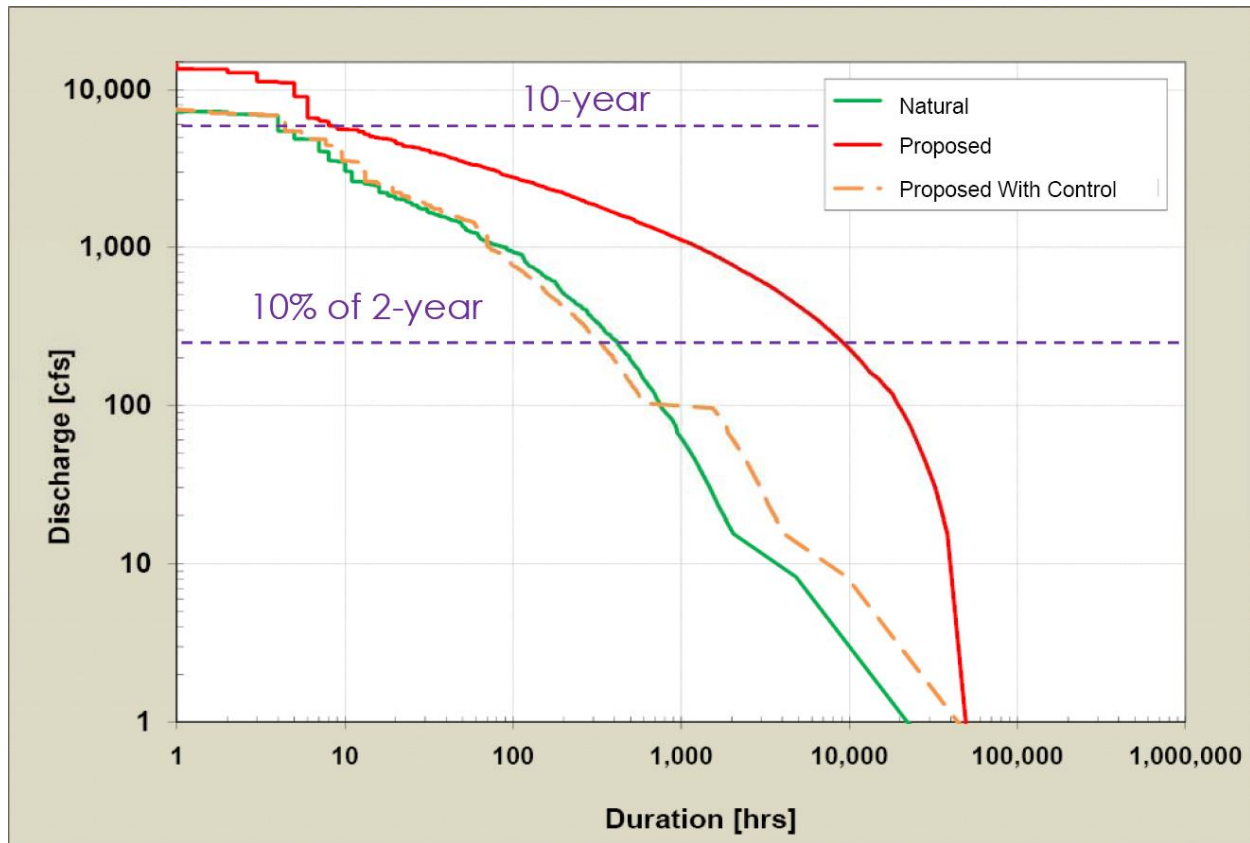

In order to mitigate HCOCs in the South Orange County permit area, flow rates and durations must be controlled between 10 percent of the 2-year storm event and the 10-year storm event, as indicated by purple dashed lines on [Figure V.1](#). This means that the post-development flow duration curve (red line in [Figure V.1](#)) needs to be lowered such that it is at or below the pre-development flow duration curve (green line) within the bounds of the purple dashed lines. In order to accomplish this, site design, volume reduction, and flow duration control BMPs can be used. This process must be based on continuous simulation of stormwater controls or through use of design charts developed from continuous simulation of stormwater controls.

V.2. South Orange County Interim Hydromodification Sizing Tool

Orange County Public Works has prepared the [South Orange County Interim Hydromodification Sizing Tool](#) to assist preparers with sizing of BMPs to comply with the SOC interim hydromodification sizing standard. This tool is based on nomographs for a range of BMPs developed through continuous simulation in EPA SWMM5.0. The sizing tool (Excel spreadsheet) and accompanying memorandum are available for download at: <http://www.ocplanning.net/WaterQuality.aspx>.

V.3. Guidelines for Project-Specific Flow Duration Analysis

This section describes the methods that shall be used by applicants wishing to perform a project-specific analysis for compliance with the SOC interim hydromodification standard instead of using the tool described in Section V.2. This section also provides documentation of the assumptions that were used to develop the interim sizing tool to provide a reference point for Project WQMP preparers and reviewers.

(Placeholder for work in progress)

APPENDIX VI. APPROVED METHODS FOR CALCULATING ALTERNATIVE COMPLIANCE VOLUME FOR LID

This appendix contains technical guidance for calculating the alternative compliance volume for projects that do not fully address LID performance standard through one of the primary pathways. This section is intended to be used as referenced from Section 2.4 of the [Model WQMP](#). For the purposes of developing an alternative compliance program, the remaining (“unmet”) portion of the DCV is also termed the *alternative compliance volume*. This volume is determined based on the difference between the target 80 capture efficiency and the capture efficiency achieved by the LID BMPs that are provided for the project before entering the alternative program. The alternative compliance volume is first calculated before the application of water quality credits, and then water quality credits are used to reduce this volume to the alternative compliance volume.

VI.1. Calculating Alternative Compliance Volume without Water Quality Credits

This section describes the method for calculating the alternative compliance volume prior to application of water quality credits.

1. Calculate the capture efficiency achieved upstream of the alternative compliance program. In the North Orange County permit area, this may include the effects of on-site LID BMPs and/or sub-regional/regional LID BMPs. In the South Orange County permit area, this will only include the effects of on-site LID BMPs. Methods of calculating capture efficiency are provided in Section [III.4](#).
2. Using [Figure VI.1](#), find the already-achieved capture efficiency on the horizontal axis and read upward to the line on the chart. Pivot 90 degrees and read to the vertical axis. This is the fraction of the design capture storm depth remaining to be met. Multiply this value by the design capture storm depth for the project (as determined from [Figure III.1](#)) to determine the remaining storm depth to be managed in the alternative compliance plan.
3. Compute the volume of runoff from the project for the storm depth calculated in (2), by using the hydrologic methods described in Section [III.1.1](#). This is the remaining volume to be managed (i.e., the *alternative compliance volume*), expressed in cubic feet.

Example VI.1: Calculating Remaining LID Volume for Alternative Compliance

Given:

- 85th percentile, 24-hr storm depth = 0.85 inches ([Figure III.1](#))

<ul style="list-style-type: none"> • Drainage Area = 1.5 acres • Imperviousness = 80% • Upstream LID BMPs achieve 60 percent average annual capture efficiency
Required:
<ul style="list-style-type: none"> • Compute remaining LID volume transferred to alternative program
Solution:
<ol style="list-style-type: none"> 1) Capture efficiency achieved = 60 percent (given) 2) From Figure VI.1, the unmet fraction of the design capture storm depth is 0.47. The unmet design storm depth = 0.47 × 0.85 inches (given) = 0.40 inches 3) $V_{\text{REMAIN}} = 1.5 \text{ ac} \times 0.40 \text{ inches} \times (0.8 \times 0.75 + 0.15) \times 43,560 \text{ sf/ac} \times 1/12 \text{ in/ft} = 1,630 \text{ cu-ft}$ 4) This is the volume that must be addressed through alternative compliance programs.

Figure VI.1: Lookup Graph for Fraction of Design Capture Storm Depth Remaining

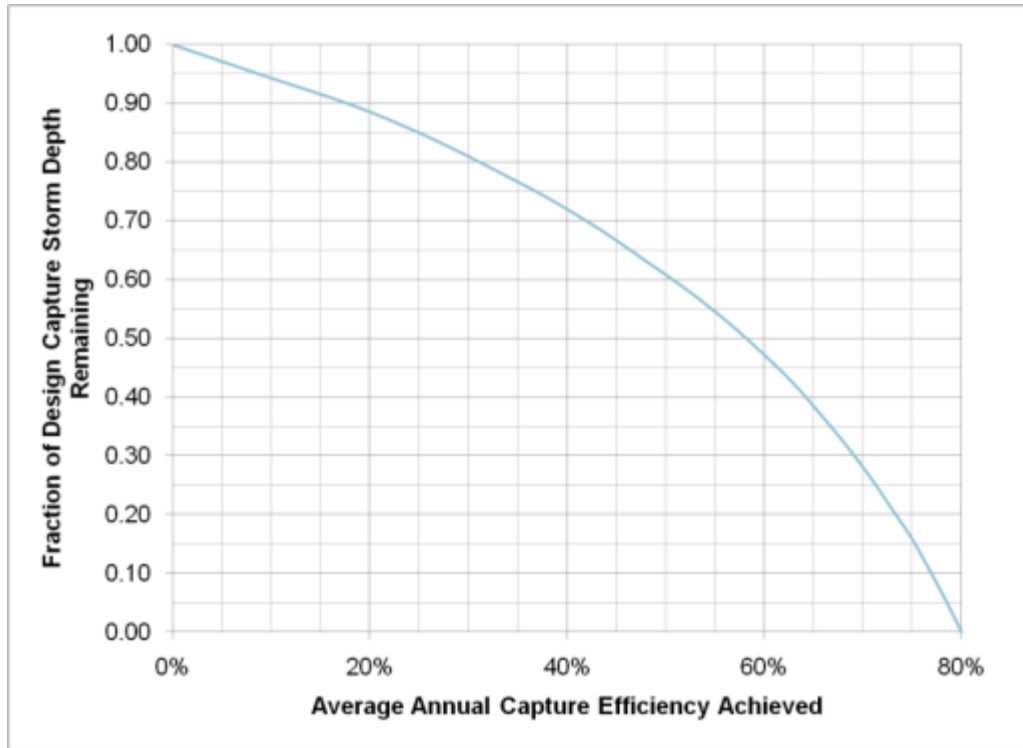

VI.2. Applying Water Quality Credits to Adjust Alternative Compliance Volume

Water quality credits may be applied to reduce the *alternative compliance volume*. Alternative compliance volume obligations are computed as described in Section [VI.1](#) and expressed in terms of a simple volume. Water quality credits are then computed based on the original DCV

for the project and may fully or partially off-set the remaining alternative compliance volume. The volume of alternative compliance obligations offset by Water Quality Credits shall be calculated in one of two ways, as described below. Eligibility of projects to claim water quality credits is described in Section 3.1 of the [Model WQMP](#).

VI.2.1. Method 1: Applying Water Quality Credits to Redevelopment Projects Reducing Overall Impervious Footprint

For redevelopment projects that reduce the overall impervious footprint of the project site compared to current use, the volumetric offset provided by water quality credits shall be calculated as follows:

1. Calculate an equivalent “existing” DCV for the site using the pre-project imperviousness, the design capture storm depth ([Figure III.1](#)) and the method described in Section [III.1.1](#))
2. Calculate the DCV for the site under the proposed development plan using the proposed project imperviousness, the design capture storm depth ([Figure III.1](#)) and the method described in Section [III.1.1](#))
3. The difference between the volumes calculated in (1) and (2) is equal to the Credit Volume, which may be applied to off-set the alternative compliance volume.

An example of this calculation is provided in [Example VI.2](#).

Example VI.2: Calculating Water Quality Credits for Projects Reducing Imperviousness

Given:
<ul style="list-style-type: none"> • 85th percentile, 24-hr storm depth = 0.85 inches (Figure III.1) • Drainage Area = 1.5 acres • Pre-project Imperviousness = 100% • Post-project Imperviousness = 70%
Required:
<ul style="list-style-type: none"> • Compute the water quality credit that could be claimed for reducing project imperviousness
Solution:
1) $DCV \text{ (pre-project)} = 1.5 \text{ ac} \times 0.85 \text{ inches} \times (1.0 \times 0.75 + 0.15) \times 43,560 \text{ sf/ac} \times 1/12 \text{ in/ft} = 4,170 \text{ cu-ft}$
2) $DCV \text{ (post-project)} = 1.5 \text{ ac} \times 0.85 \text{ inches} \times (0.7 \times 0.75 + 0.15) \times 43,560 \text{ sf/ac} \times 1/12 \text{ in/ft} = 3,120 \text{ cu-ft}$
3) $Credit \text{ volume} = DCV(\text{pre}) - DCV(\text{post}) = 4,170 \text{ cu-ft} - 3,120 \text{ cu-ft} = 1,050 \text{ cu-ft}$
4) This is the credit volume that can be applied to reduce “unmet” volume.

VI.2.2. Method 2: Applying Water Quality Credits to Projects Based on Project Type and Density

Water Quality Credits are expressed in terms of percentages of the original DCV (i.e., the runoff from the design capture storm depth in the proposed condition before applying any BMPs). This section is intended to be applicable for calculating the volume (cu-ft) corresponding to these credits. The applicability of credits is described in Section 3.1 of the [Model WQMP](#). The user is expected to enter this section with the total WQ credit percentage.

The volume credit would be calculated as the DCV of the proposed condition multiplied by WQ Credit percentage:

$$\text{Credit Volume} = \text{Original DCV} * \sum \text{Credit Percentages Claimed}$$

An example of this calculation is provided in [Example VI.3](#).

Example VI.3: Applying Water Quality Credits to Reduce Alternative Compliance Volume

<p>Given:</p> <ul style="list-style-type: none"> • 85th percentile, 24-hr storm depth = 0.85 inches (Figure III.1) • Drainage Area = 1.5 acres • Imperviousness = 80% • Alternative compliance volume before claiming water quality credits = 1,630 cu-ft • Total credit based on applicability described in Section 3.1 of the Model WQMP: 30 percent
<p>Required:</p> <ul style="list-style-type: none"> • Compute remaining unmet volume after applying water quality credits
<p>Solution:</p> <ol style="list-style-type: none"> 1) Add all applicable credits = 20% + 10% = 30% (per applicability described in Section 3.1 of the Model WQMP) 2) DCV (unmitigated) = 1.5 ac x 0.85 inches x (0.8x0.75 + 0.15) x 43,560 sf/ac x 1/12 in/ft = 3,470 cu-ft 3) Credit volume = total credit x original DCV = 30% x 3,470 cu-ft = 1,040 cu-ft 4) Remaining volume after credits = 1,630 cu-ft – 1,040 cu-ft = 590 cu-ft 5) This is the remaining volume that must be addressed through other forms of alternative compliance.

VI.3. Stormwater Quality Design Volume/Flow Calculations for Sizing Treatment Control BMPs for Alternative Compliance

The following sections describe how a specified alternative compliance volume (after adjusting for water quality credits) shall be translated to volume-based or flow-based sizing criteria for treatment control BMPs.

VI.3.1.1. Volume-based Treatment Control BMPs

Volume-based treatment control BMPs shall be sized such that they capture and treat the remaining alternative compliance volume.

For example, if as part of an alternative compliance plan, 10,000 cu-ft of remaining volume was designated to be treated by a treatment control BMP, the BMP would be sized with a design volume of 10,000 cu-ft..

VI.3.1.2. Flow-based Treatment Control BMPs

Because unmet volume is expressed in units of volume, this unmet volume must be translated to a flowrate for sizing of flow-based treatment control BMPs. This section describes the method by which an unmet runoff volume would be addressed by a flow-based treatment control BMP. The method requires that the drainage area to the proposed flow-based treatment control BMP be known.

- 1) For the catchment to which the flow-based BMP will be applied, convert the unmet volume to an unmet storm depth using the method of back-computing storm depth described in Section III.1.1 and Example III.2.
- 2) Divide the back-computed storm depth by the design capture storm depth to yield the unmet fraction of the design storm depth over the tributary area to the BMP. If this value is greater than 1.0, increase the area tributary to the flow-based BMP.
- 3) Estimate the time of concentration (T_c) of the catchment.
- 4) Use Table VI.1 to look up the multiplier based on the calculated T_c . Multiply the looked up value by the remaining fraction of the design capture storm depth (Step 2) to yield the design intensity.
- 5) Use the hydrologic method described in Section III.1.2 to compute the design flow.
- 6) This method can also be used in reverse if necessary.

Table VI.1: Table of Multipliers for Computing Remaining Design Storm Intensity

Time of Concentration, minutes	Multiplier to Convert Remaining Fraction of Design Capture Storm Depth to Design Intensity, in/hr
60	0.15
30	0.18
20	0.19
15	0.21
10	0.23
5	0.26

Example VI.4: Computing the Required Design Flowrate to Mitigate Remaining Alternative Compliance Volume

<p>Given:</p> <ul style="list-style-type: none"> 85th percentile, 24-hr storm depth = 0.85 inches (Figure III.1) Drainage area to proposed flow-based BMP = 1.5 acres Imperviousness of drainage area = 80% Time of concentration (T_c) of the drainage area = 15 minutes Remaining volume (designated to be managed with the proposed BMP) = 1,200 cu-ft
<p>Required:</p> <ul style="list-style-type: none"> Compute required design flowrate to mitigate the alternative compliance volume
<p>Solution:</p> <ol style="list-style-type: none"> Equivalent storm depth = $1,200 \text{ cu-ft} \times 12 \text{ in/ft} / [(0.75 \times 0.8 + 0.15) \times 1.5 \text{ ac} \times 43560 \text{ sf/ac}] = 0.29$ inches Fraction of design capture storm depth = $0.29 \text{ inches} / 0.85 \text{ inches} = 0.35 = 35\%$ of DCV From, Table VI.1 the multiplier for T_c of 15 minutes is 0.21 in/hr Design intensity equivalent to the remaining unmet volume = $0.21 \text{ in/hr} \times 0.35 = 0.074 \text{ in/hr}$ Design flow equivalent to the remaining alternative compliance volume = $(0.75 \times 0.8 + 0.15) \times 0.074 \text{ in/hr} \times 1.5 \text{ ac} = 0.083 \text{ cfs}$ This is the design flowrate that must be provided for the 1.5 acre tributary area to address 1,200 cu-ft of remaining volume.

Worksheet G: Alternative Compliance Volume Worksheet

Step 1: Determine the alternative compliance volume without water quality credits			
1	Determine the capture efficiency achieved in upstream BMPs using Appendix III , X_1 (%)	$X_1 =$	%
2	Enter design capture storm depth from Figure III.1 , d (inches)	$d =$	inches
3	Using Figure VI.1 , pivot from where X_1 intersects the curve to determine the fraction of design capture storm depth remaining to be met, Y_1	$Y_1 =$	
4	Calculate the design depth that must be managed in alternative compliance BMPs, $d_{alternative} = Y_1 \times d$	$d_{alternative} =$	inches
5	Compute the alternative compliance volume corresponding to $d_{alternative}$ using the hydrologic methods described in Section III.1.1 , ACV (cu-ft)	$ACV =$	cu-ft
Step 2: Determine Credit Volume			
Method 1: Determine Credit Volume based on Reducing Impervious Footprint			
1	Enter design capture storm depth from Figure III.1 , d (inches)	$d =$	inches
2	Using d , calculate the DCV using the pre-project imperviousness and the methods described in Appendix III , DCV_{pre} (cu-ft).	$DCV_{pre} =$	cu-ft
3	Using d , calculate the DCV using the proposed imperviousness and the methods described in Appendix III , DCV_{post} (cu-ft).	$DCV_{post} =$	cu-ft
4	Calculate the <i>Credit Volume</i> = $DCV_{pre} - DCV_{post}$ (cu-ft).	<i>Credit Volume</i> =	cu-ft
Method 2: Determine Credit Volume based on Project Type and Density			
1	Determine the sum of the Credit Percentages applicable to the Project, \sum <i>Credit Percentages</i> (%). (See Section 3.1 of the Model WQMP)	\sum <i>Credit Percentages</i> =	%
2	Enter design capture storm depth from Figure III.1 , d (inches)	$d =$	inches
3	Using d , calculate the DCV using the proposed imperviousness without BMPs and the methods described in Appendix III , $DCV_{post\ no\ BMP}$ (cu-ft).	$DCV_{post\ no\ BMP} =$	cu-ft
4	Calculate the <i>Credit Volume</i> = $DCV_{post\ no\ BMP} \times \sum$ <i>Credit Percentages</i>	<i>Credit Volume</i> =	cu-ft

Worksheet G: Alternative Compliance Volume Worksheet

Step 3: Determine the Alternative Compliance Volume after WQ Credits			
1	Enter design capture storm depth from Figure III.1 , <i>d</i> (inches)	d=	inches
2	Using <i>d</i> , calculate the DCV using the proposed imperviousness and the methods described in Appendix III , DCV_{post} (cu-ft).	$DCV_{post} =$	cu-ft
3	Calculate the alternative compliance volume, $ACV = DCV_{post} - Credit\ Volume$	ACV=	cu-ft

APPENDIX VII. INFILTRATION RATE EVALUATION PROTOCOL AND FACTOR OF SAFETY RECOMMENDATIONS

VII.1. Introduction

Soil characterization and infiltration testing is required in order to properly size and locate stormwater management facilities. The purpose of this appendix is to provide guidance for investigating infiltration at both the project planning and design phases, as well as provide requirements for applying a factor of safety to testing results.

VII.1.1. Two phases of assessment

The role of soil characterization and infiltration testing differs with the phase of project development as described below.

Site Assessment / Project Planning Phase: Soil characterization or infiltration testing may be conducted to determine if infiltration is a potentially feasible BMP and/or where on the site infiltration is potentially infeasible. The intent of this investigation is to identify if the project site, or a portion of the site, has soils that are clearly unsuitable for infiltration. For those sites or portions of the site where soils are unsuitable, infiltration BMPs can be eliminated from consideration. The intent of this testing is not to prove definitively that infiltration is feasible. Simpler methods may be used to determine infiltration potential at this phase. The observed infiltration rate is adjusted to account for the type of test and the uncertainty of the testing method and reported as the *measured infiltration rate* for the purpose of evaluating feasibility. These methods are not appropriate to determine the *design infiltration rate*.

Site Planning / Design Phase: Where infiltration BMPs are selected, infiltration testing must be conducted to determine the *design infiltration rate* of proposed facilities, except in limited cases where infiltration rate is presumed to be sufficient as identified in Section VII.1.2. The required size of the proposed facilities strongly depends on the design infiltration rate; therefore, testing may be required at the preliminary site design phase to facilitate site planning. However, infiltration testing must be conducted as close to the proposed facility as possible, therefore, conducting testing after preliminary site design also has merits. Use of more sophisticated methods at this phase allows better confidence in testing and therefore a lower factor of safety on observed infiltration rates (and therefore smaller facility designs). Factors of safety are discussed in VII.4.

Soil characterization and infiltration testing can be considered to fulfill two functions:

1. Determine where infiltration is potentially feasible and must be considered (if other limitations, such as depth to groundwater or contamination, do not restrict infiltration). This role is satisfied through simple infiltration tests, or use of maps and available data.
2. Determine the design infiltration rate for proposed facilities. This function is satisfied through more sophisticated investigation methods, conducted by a qualified professional.

Table VII.1 provides required methods of assessing infiltration rate for each purpose.

Table VII.1: Recommended Infiltration Investigation Methods

Methods for Identifying Areas Potentially Feasible for Infiltration	<ul style="list-style-type: none"> • Use of Regional Maps and “Available Data”¹ OR • Simple Open Pit Infiltration Test OR • Any of the testing methods used to establish design infiltration rate (below)
Methods for Establishing Design Infiltration Rate	<ul style="list-style-type: none"> • Open Pit Falling Head Procedure • Single Ring Infiltrometer Test • Double Ring Infiltrometer Test • Well Permeameter Method (USBR Procedure 7300-89) • Percolation Test Procedure (Riverside County Department of Environmental Health) • Other analysis methods at the discretion of the project engineer and approval of the reviewing agency

¹Available data is defined in Section **VII.2** below and does not require additional investigation.

VII.1.2. Waiver of Infiltration Testing Requirements

The infiltration testing requirements described in this appendix are not applicable for certain combinations of BMP type and general soil condition. In cases where available soils information indicates that the soils are clearly sufficient to support the level of infiltration required for proper function of the BMP and uncertainty in infiltration rate would not significantly influence the performance of the practice, it is not mandatory to conduct infiltration testing. Conditions under which infiltration testing requirements are waived include:

- **Impervious area dispersion** (See [HSC-2: Impervious Area Dispersion](#)): Testing requirements are waived for this BMP for all soil types. Soil amendments are required to use this practice where site soils are hydrologic soil group C or D.
- **Localized on-lot infiltration** (See [HSC-1: Localized On-Lot Infiltration](#)): Testing requirements are waived for this BMP for A, B, and C soil types if soil type and general drainage conditions are confirmed with site-specific information. This BMP is not suitable for D soils unless infiltration testing demonstrates that the ponded depth would drain within 24 hours.
- **Porous pavement designed to be self-retaining** (See [INF-6: Permeable Pavement \(concrete, asphalt, and pavers\)](#)): Testing requirements for this BMP are waived for A, B, and C soil types if soil type and general drainage conditions are confirmed with site-specific information. This waiver does not apply to porous pavement that accepts run-on from a tributary area larger than 50 percent of its area.
- **Bioinfiltration** (See [INF-4: Bioinfiltration Fact Sheet](#)). Based on the LID BMP hierarchy, this type of BMP may only be used if infiltration of the full DCV is not feasible; therefore exploratory infiltration rate assessment (Section [VII.2](#)) is required. However, testing to determine design infiltration rate (Section [VII.3](#)) is not required. See [Appendix XI](#) for instructions for sizing the infiltration component of a bioinfiltration BMP to achieve maximum feasible infiltration.

VII.1.3. A Note on “Infiltration Rate” vs. “Percolation Rate”

A common misunderstanding is that the “percolation rate” obtained from a percolation test is equivalent to the “infiltration rate” obtained from a single or double ring infiltrometer test. While the percolation rate is related to the infiltration rate, percolation rates tend to overestimate infiltration rates and can be off by a factor of ten or more because they incorporate both downward and horizontal fluxes of water, whereas infiltration only refers to a downward flux of water. When using borehole-type methods, the percolation rate obtained shall be converted to a reasonable estimate of the infiltration rate using the Porchet Method (aka Inverse Borehole Method) (See Example VII.1).

VII.1.4. Grading Plans

Many projects require a significant amount of grading prior to their construction. It is important to determine if the BMP will be placed in cut or fill since this may affect the performance of the BMP or even the soil. As such, preliminary site grading plans showing the proposed BMP locations are required along with section views through each BMP clearly identifying the extents of cut or fill. In addition, since it is imperative that any testing be performed at the proper elevations and locations, it is highly recommended that the preliminary site grading plans be provided to the engineer/geologist prior to any tests being performed.

VII.1.5. Cut Condition

Where the proposed infiltration BMP is to be located in a cut condition, the infiltration surface level at the bottom of the BMP might be far below the existing grade. For example, if the

infiltration surface of a proposed BMP is to be located at an elevation that is currently beneath 15 feet of cut, how can the proposed infiltration surface be tested?

In order to determine an infiltration rate where the proposed infiltration surface is in a cut condition, the following procedures may be used:

- 1) USBR 7300-89, "Procedure for Performing field Permeability Testing by the Well Permeameter Method" (Section VII.3.7 below). Note that this result must be converted to an infiltration rate.
- 2) The percolation test (Section VII.3.8 below). Note that this result must be converted to an infiltration rate.

VII.1.6. Fill Condition

If the bottom of a BMP (infiltration surface) is in a fill location, the infiltration surface may not exist prior to grading. How then can the infiltration rate be determined? For example, if a proposed infiltration BMP is to be located in 12 feet of fill, how could one reasonably establish an infiltration rate prior to the fill being placed?

Unfortunately, no reliable assumptions can be made about the in-situ properties of fill soil. As such, the bottom, or rather the infiltration surface of the BMP, must extend into natural soil. The natural soil shall be tested at the design elevation prior to the fill being placed.

For shallow fill depths, fill material can be selectively graded to provide reliable infiltration properties. However, in some cases, due to considerable fill depth, the extension of the BMP down to natural soil and selective grading of fill material may prove infeasible. In that case, because of the uncertainty of fill parameters as described above, an infiltration BMP may not be feasible.

VII.2. **Methods for Identifying Areas Potentially Feasible for Infiltration**

This section describes methods that shall be used, as applicable, to determine whether soils are potentially feasible for infiltration, and where potentially feasible soils exist. Soils would be considered potentially feasible for infiltration if the *measured infiltration rate* obtained from field-testing or obtained by applying professional judgment to available data taken within the Project vicinity is greater than 0.3 inches per hour. *Measured* rates shall account for uncertainty and bias in measurement methods by applying a factor of safety of 2.0 to testing results.

The *measured infiltration rate* calculated for the purpose of infiltration infeasibility screening ([TGD Section 2.4.2.4](#)) shall be based on a factor of safety of 2.0 applied to the rates obtained from the infiltration test results. No adjustments from this value are permitted. The factor of safety used to compute the *design infiltration rate* shall not be less than 2.0, but may be higher at

the discretion of the design engineer and acceptance of the plan reviewer, per the considerations described in Section [VII.4](#).

VII.2.1. Use of Regional Maps and “Available Data”

This section describes a method that satisfies the requirements for infiltration screening of small projects as defined by the TGD Infeasibility Screening Criteria ([TGD Section 2.4.2.4](#)). This method uses regionally mapped data coupled with all applicable data available through other site investigations to identify locations not potentially feasible for infiltration as a result of low infiltration rate or high groundwater table.

Via this method, areas of a project identified as having D soils or identified as having depth to first groundwater less than 5 feet are considered infeasible for infiltration if available data confirm these determinations.

Infiltration constraint maps are available in [Appendix XVI](#) and will be refined as part of the development of Watershed Hydromodification and Infiltration Management Plans. These maps identify constraints, including hydrologic soil group (A,B,C,D), and depth to first groundwater, which should be confirmed through review of available data.

“Available data” is defined as data collected by the project or otherwise available that provides information about infiltration rates and/or groundwater depths. Applicable data is expected to be available as part of nearly all projects subject to New Development and Significant Redevelopment stormwater management requirements in Orange County. Data sources may include:

- Geotechnical investigations
- Due diligence site investigations
- Other CEQA investigations
- Investigations performed on adjacent sites with applicability to the project site

For projects permitted to utilize this method, additional infiltration testing data is not required to be obtained, however, infiltration testing data which is already available from previous studies must be used.

For the purpose of this method, large projects and small projects are defined in Table VII.2. The distinction between large and small projects based the lower spatial variability expected on smaller projects and the lower project value. In these cases, the expense associated with infiltration testing of HSG D soils to attempt to identify localized exceptions to this mapped and supported determination is considered to be an unreasonable economic burden.

Table VII.2: Definition of Project Size Categories

	Residential	Commercial, Institutional	Industrial
Small Projects	Less than 10 acres and less than 30 DU	Less than 5 acres and less than 50,000 SF	Less than 2 acre and less than 20,000 SF
Large Projects	Greater than 10 acres or greater than 30 DU	Greater than 5 acres or greater than 50,000 SF	Greater than 2 acre or greater than 20,000 SF

VII.2.2. Simple Open Pit Infiltration Test

The Simple Open Pit Infiltration Test is a site-specific method which can be used to provide a preliminary screening value. This approach cannot be used to find a design infiltration rate. The intent of the Simple Open Pit Infiltration Test is to determine whether or not the local infiltration rate is potentially adequate for LID infiltration BMPs. This approach does not need to be conducted by a licensed professional.

1. The test should be at the proposed facility location or within the immediate vicinity.
2. Excavate a test hole to an elevation 2 feet deeper than the bottom of the infiltration system to account for soil amendment. If the depth of the proposed facility is not known at the time of testing, the excavation should be 6 feet deep. The test hole can be excavated with small excavation equipment or by hand using a shovel, auger, or post hole digger. The hole should be a minimum of 2 feet in diameter and should be sufficient to allow for observation of the water surface level in the bottom of the hole. Remove loose material, as much as possible from the bottom of the hole but avoid compaction of the bottom surface. If a layer hard enough to prevent further excavation is encountered during excavation, or if noticeable moisture/water is encountered in the soil, stop and measure this depth. Proceed with the test at this depth.
3. Fill the hole with water to a height of about 6 inches from the bottom of the hole, and record the exact time. Check the water level at regular intervals (every minute for fast-draining soils to every 10 minutes for slower-draining soils) for a minimum of 1 hour or until all of the water has infiltrated. Record the distance the water has dropped from a fixed reference point such as the top edge of the hole.
4. The infiltration rate is calculated by dividing the change in water elevation time (inches) by the duration of the test (hours).
5. Repeat this process two more times, for a total of three rounds of testing. These tests should be performed as close together as possible to accurately portray the soil's ability to infiltrate at different levels of saturation. The third test provides the best measure of the saturated infiltration rate.

6. For each test pit required, record all three testing results with the date, duration, drop in water height, and conversion into inches per hour.

VII.3. Methods for Establishing Design Infiltration Rate

Allowable methods of establishing design infiltration rate include:

- Open Pit Falling Head Procedure (Section [VII.3.4](#))
- Single Ring Infiltrometer Test (Section [VII.3.5](#))
- Double Ring Infiltrometer Test (Section [VII.3.6](#))
- Well Permeameter Method (USBR Procedure 7300-89) (Section [VII.3.7](#))
- Percolation Test Procedure (Riverside County Department of Environmental Health) (Section [VII.3.8](#))
- Other analysis methods at the discretion of the project engineer and approval of the reviewing agency

A qualified professional must exercise judgment in the selection of the infiltration test method. Where satisfactory data from adjacent areas is available that demonstrates infiltration testing is not necessary, the infiltration testing requirement may be waived. Waiver of site specific testing is subject to approval by the local approval authority. Recommendation for foregoing infiltration testing must be submitted in a report which includes supporting data and is stamped and signed by the project geotechnical engineer or project geologist.

VII.3.1. Testing Criteria

1. Testing must be conducted or overseen by a qualified professional, either a Professional Engineer (PE) or Registered Geologist (RG) licensed in the State of California.
2. The elevation of the test must correspond to the facility elevation, plus 2 feet to account for soil amendments under the infiltration system. If a confining layer, or soil with a greater percentage of fines, is observed during the subsurface investigation to be within 4 feet of the bottom of the planned infiltration system, the testing should be conducted within that confining layer. The boring log must be continued to a depth adequate to show separation between the bottom of the infiltration facility and the seasonal high groundwater level.
3. Tests must be performed in the immediate vicinity of the proposed facility. Exceptions can be made to the test location provided the qualified professional can support that the strata are consistent from the proposed facility to the test location.
4. Infiltration testing should not be conducted in engineered or undocumented fill.

VII.3.2. Minimum Number of Required Tests

- A total of two infiltration tests for every 10,000 square feet of lot area available for new or redevelopment (minimum 2 tests per priority project).

- An additional test for every 10,000 square feet of lot area available for new or redevelopment.
- At least one test for any potential street facility.
- One test for every 100 lineal feet of infiltration facility.
- In general no more than five valid tests are required per development, unless more tests would be valuable or necessary (at the discretion of the qualified professional assessing the site, as well as the reviewing agency).

Where multiple types of facilities are used, it is likely that multiple tests will be necessary, since different facility types may infiltrate at different depths and an infiltration test can test only a single soil stratum. It is highly recommended to conduct an infiltration test at each stratum used. Additional testing may be required at the discretion of the local approval authority.

VII.3.3. Factors of Safety

Long term monitoring has shown that the performance of working full-scale infiltration facilities may be far lower than the rate measured by small-scale testing. There are several reasons for this:

1. Over time, the surface of infiltration facilities can become plugged as sedimentary particles accumulate at the infiltration surface.
2. Post-grading compaction of the site can destroy soil structure and seriously impact the facility's performance.
3. Testing procedures in general are subject to errors which can skew the results.

The method for determination of the factor of safety described in Section [VII.4](#) includes, among other factors, a consideration of the testing methods used to measure infiltration rate. The open pit falling head test (see Section [VII.3.4](#)) is considered the most reliable infiltration testing method if constructed to the recommended dimensions.

VII.3.4. Open Pit Falling Head Procedure

The open pit falling head procedure is performed in an open excavation and therefore is a test of the combination of vertical and lateral infiltration. The tester and excavator should conduct all testing in accordance with OSHA regulations regarding open pit excavations.

1. Excavate a hole with bottom dimensions of at least 2 feet by 4 feet into the native soil to the elevation 2 feet below the proposed facility bottom to account for amendment of soils under infiltration areas. If a smooth excavation bucket is used, scratch the sides and bottom of the hole with a sharp pointed instrument, and remove the loose material from the bottom of the test hole. The bottom of the hole should not be compacted and should be as level as possible.
2. Fill the hole with clean water a minimum of 1 foot above the soil to be tested, and maintain this depth of water for at least 4 hours (or overnight if clay soils are present) to

presoak the native material. In sandy soils with little or no clay or silt, soaking is not necessary. If after filling the hole twice with 12 inches of water, the water seeps completely away in less than 10 minutes, the test can proceed immediately.

3. Determine how the water level will be accurately measured. The measurements should be made with reference to a fixed point. A lath placed in the test pit prior to filling or a sturdy beam across the top of the pit are convenient reference points.
4. After the pre-saturation period, refill the hole with water to 12 inches above the soil and record the time. For deep holes, it may be necessary to use remote sensing equipment to accurately measure changes in water level. Alternative water head heights may be used for testing provided the presaturation height is adjusted accordingly and the water head height used in infiltration testing is 50 percent or less than the water head height in the proposed stormwater system during the design storm event. Measure the water level to the nearest 0.01 foot ($\frac{1}{8}$ inch) at 10-minute intervals for a total period of 1 hour (or 20-minute intervals for 2 hours in slower soils) or until all of the water has drained. In faster draining soils (sands and gravels), it may be necessary to shorten the measurement interval in order to obtain a well-defined infiltration rate curve. Constant head tests may be substituted for falling head tests at the discretion of the professional overseeing the infiltration testing.
5. Repeat the test. Successive trials should be run until the percent change in measured infiltration rate between two successive trials is minimal (<10 percent). The trial should be discounted if the infiltration rate between successive trials increases. At least three trials must be conducted. After each trial, the water level is readjusted to the 12 inch level. Record results.
6. The average infiltration rate over the last trial should be used to calculate the unadjusted (pre-factor of safety) infiltration rate. The final rate must be reported in inches per hour.
7. Upon completion of the testing, the excavation must be backfilled.
8. For very rapidly draining soils, it may not be possible to maintain a water head above the bottom of the test pit. If the infiltration rate meets or exceeds the flow of water into the test pit, conduct the test in the following manner:
 - a) Approximate the area over which the water is infiltrating.
 - b) Using a water meter, bucket, or other device, measure the rate of water discharging into the test pit.
 - c) Calculate the infiltration rate by dividing the rate of discharge (cubic inches per hour) by the area over which it is infiltrating (square inches) and correcting to units of inches per hour.

VII.3.5. Single Ring Infiltrometer Test

Single ring infiltrometer tests using a large ring in diameter (40 inches or larger is optimal) have been shown to closely match full-scale facility performance ([Figure VII.1](#) to [Figure VII.3](#)). The cylindrical ring is driven approximately 12 inches into the soil. Water is ponded within the ring

above the soil surface. The upper surface of the ring is often covered to prevent evaporation. Using the constant head method, the volumetric rate of water added to the ring sufficient to maintain a constant head within the ring is measured. The test is complete and the tested infiltration rate, I_t , is determined after the flow rate has stabilized (ASTM D5126).

To help maintain a constant head, a variety of devices may be used. A hook gage, steel tape or rule, length of steel, or plastic rod pointed on one end can be used for measuring and controlling the depth of liquid (head) in the infiltrometer ring. If available, a graduated Mariotte tube or automatic flow control system may also be used. Care should be taken when driving the ring into the ground as there can be a poor connection between the ring wall and the soil. This poor connection can cause a leakage of water along the ring wall and an overestimation of the infiltration rate.

The volume of liquid used during each measured time interval may be converted into an incremental infiltration velocity (infiltration rate) using the following equation:

$$I_t = V/(A*t)$$

where:

I_t = tested infiltration rate, in/hr

V = volume of liquid used during time interval to maintain constant head in the ring, in³

A = internal area of ring, in²

t = time interval, hr.

Figure VII.1. Photo of Single Ring Infiltrometer



Figure VII.2. Single Ring Infiltrometer Construction

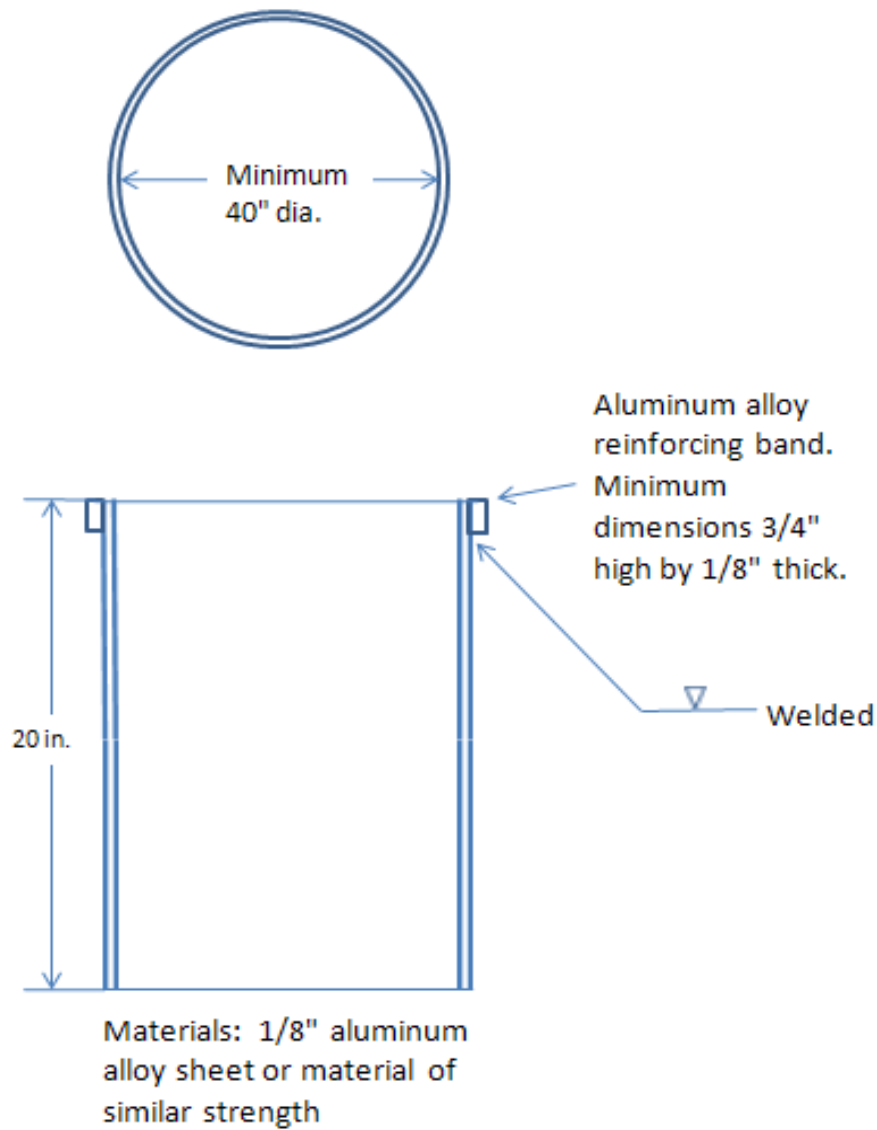

Figure VII.3. Single Ring Infiltrometer Setup with Mariotte Tube

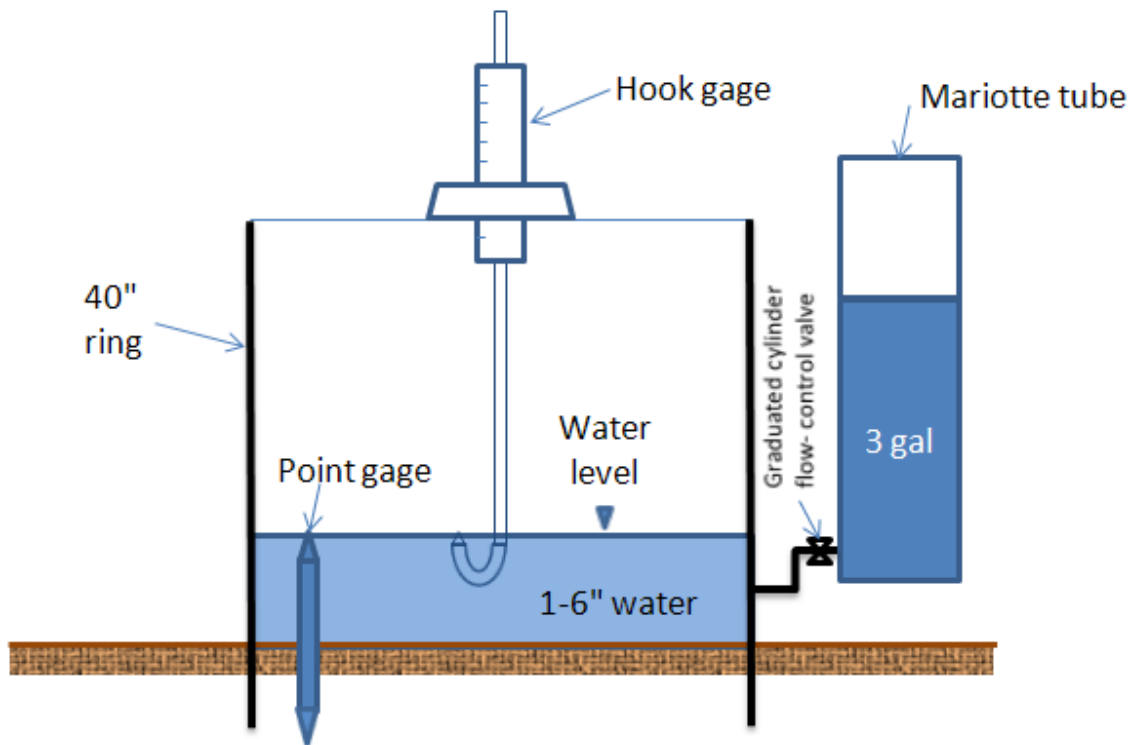

Figure VII.4. Sample Test Data Form for Single Ring Infiltrometer Test

SINGLE RING INFILTRMETER TEST DATA							
Project Name and Test Location:			Constants-		Ring Data		Liquid Containers
					Ring Area, A_r (in ²)	Depth of Liquid (in)	Reservoir Container Volume, V_r (in ³ /in)
Test By:		USCS Class:		Penetration of Ring into Soil (in.):			
Liquid Used:		pH:		Ground Temp (°F):		at Depth:	
Date of Test:		Depth to Water Table:					
Liquid Level Maintained by using: () Flow Valve () Float Valve () Mariotte Tube () Other:							
Additional Comments:							
Time interval	Time (hr:min)	Dt (min) & Total	Flow Readings		Liquid Temp (°F)	Infiltratn Rate, I^{**} (in/hr)	Remarks
			Elev., H (In)	ΔH (in) & Q_f^* (in ³)			
1 - Start							
End							
2 - Start							
End							
3 - Start							
End							
4 - Start							
End							
5 - Start							
End							
6 - Start							
End							
7 - Start							
End							
8 - Start							
End							
9 - Start							
End							
10 - Start							
End							
11 - Start							
End							
12 - Start							
End							
13 - Start							
End							
14 - Start							
End							
15 - Start							
End							

*Flow, $Q_f = \Delta H \times V_r$ **Infiltration Rate, $I = (Q_f/A_r)/$

VII.3.6. Double Ring Infiltrometer Test

The double ring infiltrometer test (ASTM D3385) is a well-recognized and documented technique for directly measuring the soil infiltration rate of a site (see [Figure VII.5](#) to [Figure VII.12](#)). Double ring infiltrometers were developed in response to the fact that smaller (less than 40 inch diameter) single ring infiltrometers tend to overestimate vertical infiltration rates. This has been attributed to the fact that the flow of water beneath the cylinder is not purely vertical and diverges laterally. Double ring infiltrometers minimize the error associated with the single-ring method because the water level in the outer ring forces vertical infiltration of water in the inner ring. Care should be taken when driving the rings into the ground as there can be a poor connection between the ring wall and the soil. This poor connection can cause a leakage of water along the ring wall and an overestimation of the infiltration rate. The double-ring infiltrometer test should be performed at an elevation 2 feet below the proposed elevation of the infiltration surface to account for the use of soil amendments below the infiltration system.

A typical double ring infiltrometer would consist of a 12 inch inner ring and a 24 inch outer ring. While there are two operational techniques used with the double-ring infiltrometer, the constant head method and the falling head method, ASTM D3385 mandates the use of the constant head method. With the constant head method, water is consistently added to both the outer and inner rings to maintain a constant level throughout the testing. The volume of water needed to maintain the fixed level of the inner ring is measured. To help maintain a constant head, a variety of devices may be used. A hook gage, steel tape or rule, or length of steel or plastic rod pointed on one end, can be used for measuring and controlling the depth of liquid (head) in the infiltrometer ring. If available, a graduated Mariotte tube or automatic flow control system may also be used.

The volume of liquid used during each measured time interval may be converted into an incremental infiltration velocity (infiltration rate) using the following equation:

$$I_t = V / (A * t)$$

where:

I_t = tested infiltration rate, in/hr

V = volume of liquid used during time interval to maintain constant head in the inner ring, in³

A = area of inner ring, in²

t = time interval, hr.

Figure VII.5. Photo of Simple Double Ring Infiltrometer

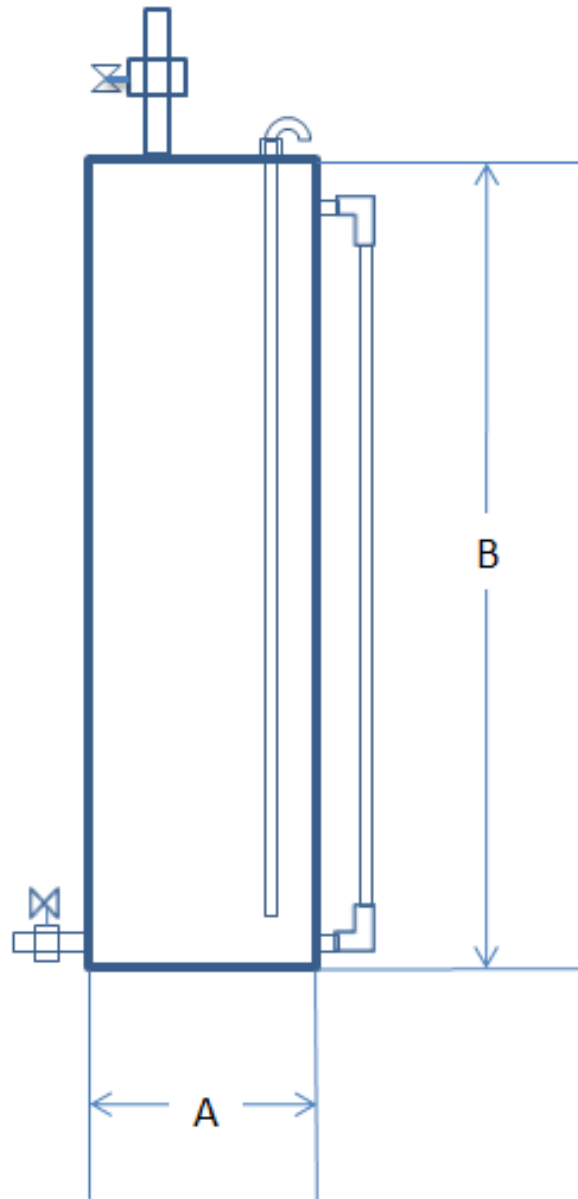

Figure VII.6. Photo of Pre-fabricated Double Ring Infiltrometer



(Photo courtesy of Turf-Tec International)

Figure VII.7. Mariotte Tube



Mariotte Tube
Useful Capacity

	1 gal	3 gal
A =	3 in.	6 in.
B =	18 in.	24 in.

Figure VII.8. Double Ring Infiltrometer Construction

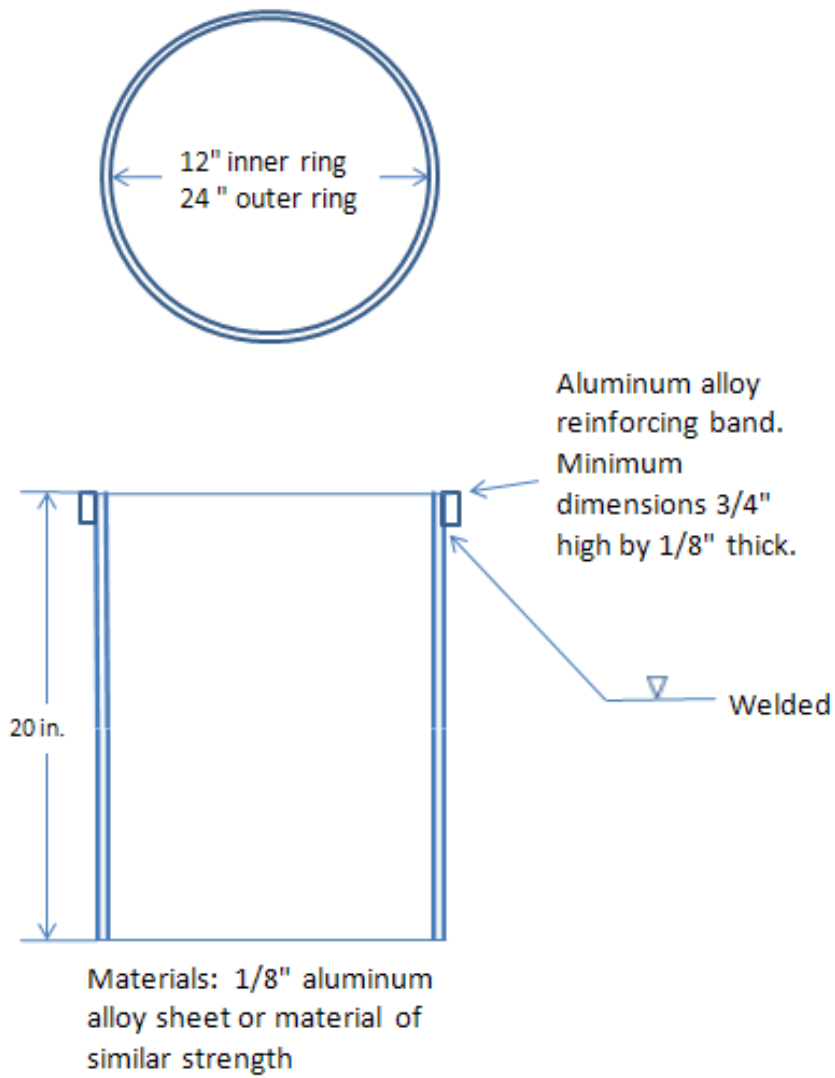

Figure VII.9. Double Ring Setup with Mariotte Tubes

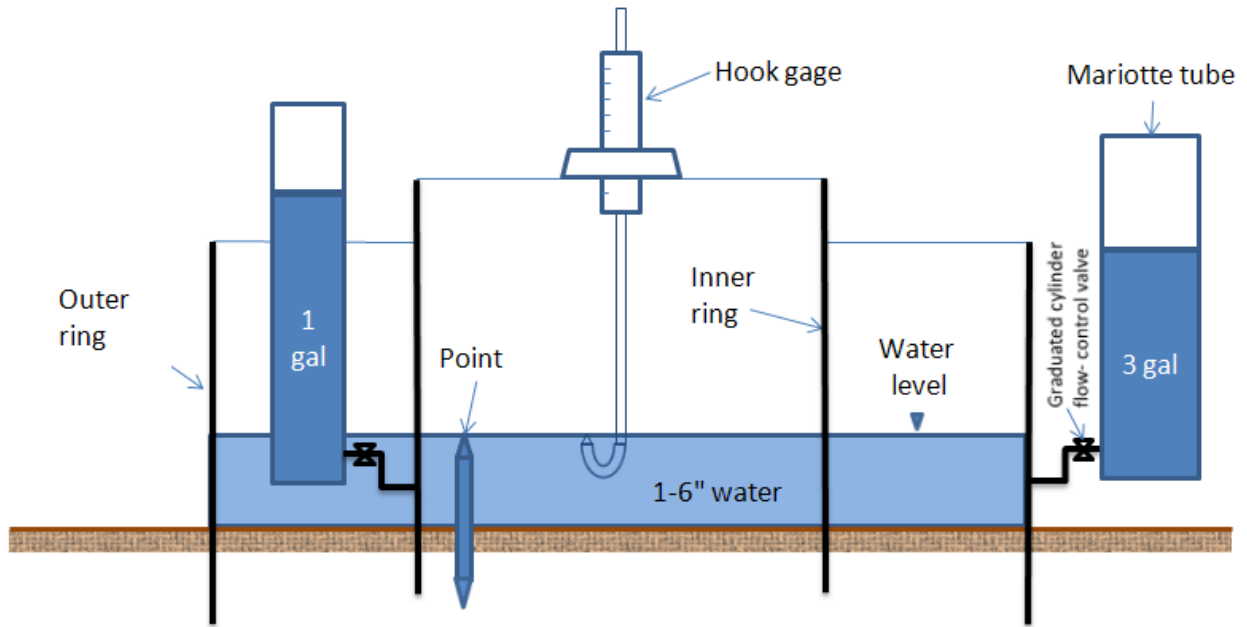

Figure VII.10. Double Ring Infiltrometer Set-up with Mariotte Tubes



(Photo courtesy of Turf-Tec International)

Figure VII.11. Double Ring Infiltrometer Set-up for Test at Basin Surface Elevation



(Photo courtesy of Turf-Tec International)

Figure VII.12. Sample Test Data Form for Double Ring Infiltrometer Test

DOUBLE RING INFILTRMETER TEST DATA										
Project Name and Test Location:				Constants-		Ring Data		Liquid Containers		
						Area, A_r (in ²)	Depth of Liquid (in)	No.	Vol., V_r (in ³ /in)	
Test By:		USCS Class:		Inner Ring:		Annular Space:				
Water Table Depth:			Penetration of Rings into Soil (in.):			Inner:		Outer:		
Date of Test:		Liquid Used:		pH:		Ground Temp (°F):		at Depth:		
Liquid Level Maintained by using: <input type="checkbox"/> Flow Valve <input type="checkbox"/> Float Valve <input type="checkbox"/> Mariotte Tube <input type="checkbox"/> Other:										
Additional Comments:										
Time interval	Time (hr:min)	Dt (min) & Total	Inner Ring		Annular Ring		Liquid Temp °F	Infiltration Rate, I**		Remarks
			Elev., H (In)	ΔH (in) &	Elev., H (In)	ΔH (in) &		Inner in/hr	Outer in/hr	
1 - Start										
End										
2 - Start										
End										
3 - Start										
End										
4 - Start										
End										
5 - Start										
End										
6 - Start										
End										
7 - Start										
End										
8 - Start										
End										
9 - Start										
End										
10 - Start										
End										
11 - Start										
End										
12 - Start										
End										
13 - Start										
End										
14 - Start										
End										
15 - Start										
End										

*Flow, $Q_f = \Delta H \times V_r$ **Infiltration Rate, $I = (Q_f/A_r)/\Delta t$

VII.3.7. Well Permeameter Method (USBR Procedure 7300-89)

Similar to a constant-head version of the percolation test used for seepage pit design is the Well Permeameter Method of the United States Bureau of Reclamation (see [Figure VII.13](#) and [Figure VII.14](#)).¹²USBR 7300-89 is an in-hole hydraulic conductivity test performed by drilling test wells with a 6-8 inch diameter auger to the desired depth. This test measures the rate at which water flows into the soil under constant-head flow conditions and is used to determine field-saturated hydraulic conductivity. As with the percolation test, the rate determined with this test is a “percolation rate” and not an infiltration rate, but this procedure uses special equation(s) to establish an infiltration rate from the data produced. See USBR procedure 7300-89 for more details.

Figure VII.13. Typical Well Permeameter Test Installation



¹² A detailed description of this procedure along with a complete example using the associated equations can be found in the United States Bureau of Mines and Reclamation (USBR) document 7300-89.

Figure VII.14. Well Permeameter Test Equipment

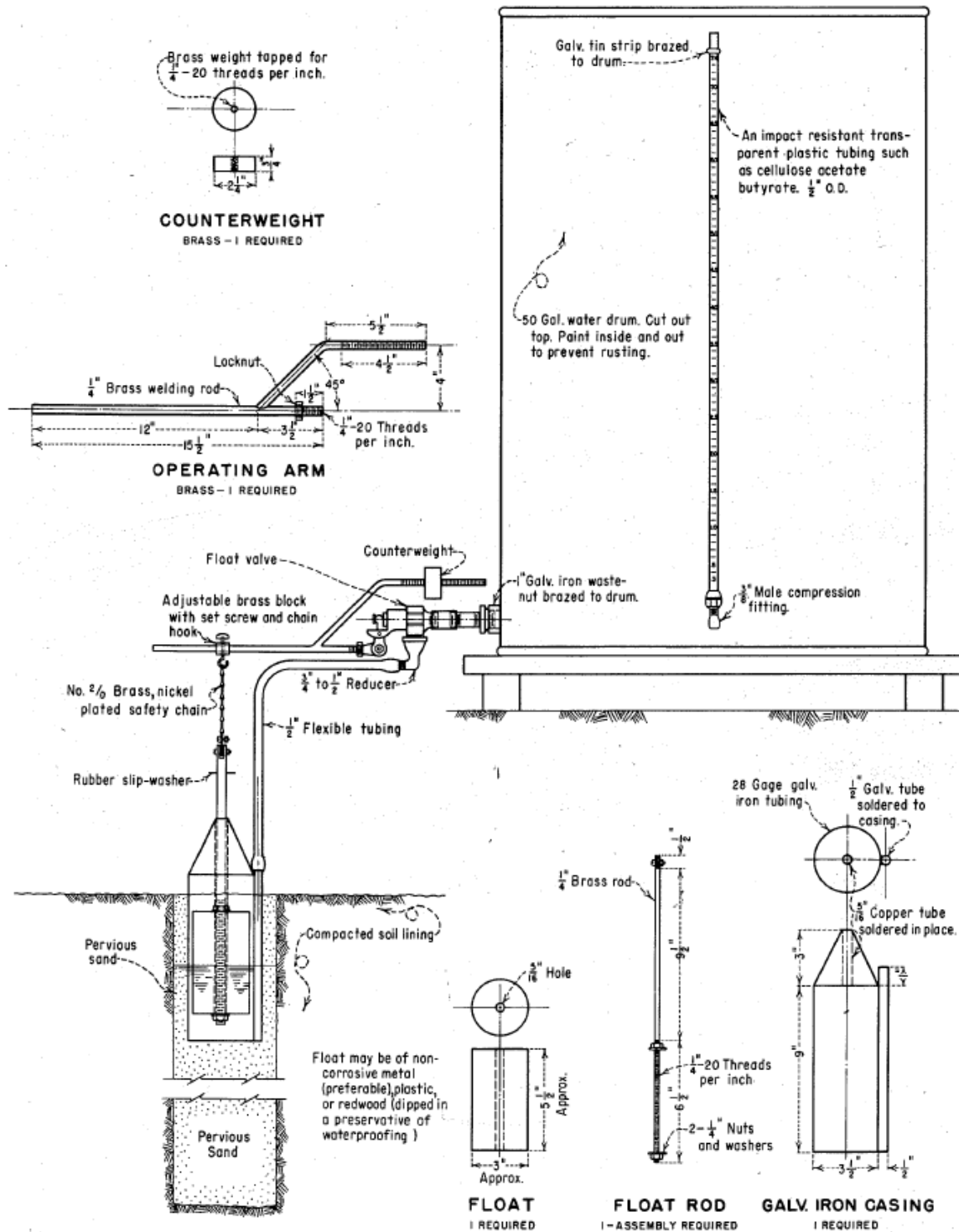

VII.3.8. Percolation Test Procedure

The percolation test procedure below (per Riverside County Department of Environmental Health) should only be performed by those individuals trained and educated to perform, understand and evaluate the field conditions and tests. This would include those who hold one of the following State of California credentials and registrations: Professional Civil and Geotechnical Engineers, Certified Engineering Geologist and Certified Hydrogeologist.

The procedure for this test varies, depending on the depth of the hole to be used. Procedures for both scenarios (less than 10 feet or 10 - 40 feet deep) and diagrams ([Figure VII.15](#) to [Figure VII.17](#)) are included below. When the percolation testing has been completed, a 3 foot long surveyor's stake (lath) shall be flagged with highly visible banner tape and placed in the location of the test indicating date, test hole number as shown on the field data sheet, and firm performing the test.

VII.3.8.1. Shallow Percolation Test (less than 10 feet)

Test Preparation

- 1) The test hole opening shall be between 8 and 12 inches in diameter or between 7 and 11 inches on each side if square.
- 2) The bottom elevation of the test hole shall correspond to the bottom elevation of the proposed basin (infiltration surface). Keep in mind that this procedure will require the test hole to be filled with water to a depth of at least 5 times the hole's radius.
- 3) The bottom of the test hole shall be covered with 2 inches of gravel.
- 4) The sides of the hole shall remain undisturbed (not smeared) after drilling and any cobbles encountered left in place.
- 5) **Pre-soaking** shall be used with this procedure. Invert a full 5 gallon bottle (more if necessary) of clear water supported over the hole so that the water flow into the hole holds constant at a level at least 5 times the hole's radius above the gravel at the bottom of the hole. Testing may commence after all of the water has percolated through the test hole or after 15 hours has elapsed since initiating the pre-soak. However, to assure saturated conditions, testing must commence no later than 26 hours after all pre-soak water has percolated through the test hole. The use of the "continuous pre-soak procedure" is no longer accepted. When sandy soils (as described below) are present, the test shall be run immediately.

Test Procedure

Test hole shall be carefully filled with water to a depth equal to at least 5 times the hole's radius ($H/r > 5$) above the gravel at the bottom of the test hole prior to each test interval.

- In **sandy soils**, when 2 consecutive measurements show that 6 inches of water seeps away in less than 25 minutes, the test shall be run for an additional hour with measurements taken every 10 minutes. Measurements shall be taken with a precision of 0.25 inches or better. The drop that occurs during the final 10 minutes is used to calculate the percolation rate. Field data must show the two 25 minute readings and the six 10 minute readings.
- In **non-sandy soils**, obtain at least twelve measurements per hole over at least six hours with a precision of 0.25 inches or better. From a fixed reference point, measure the drop in water level over a 30 minute period for at least 6 hours, refilling after every 30 minute reading. The total depth of the hole must be measured at every reading to verify that collapse of the borehole has not occurred. The drop that occurs during the final reading is used to calculate the percolation rate.

Figure VII.15. Test Pit for Shallow Percolation Test

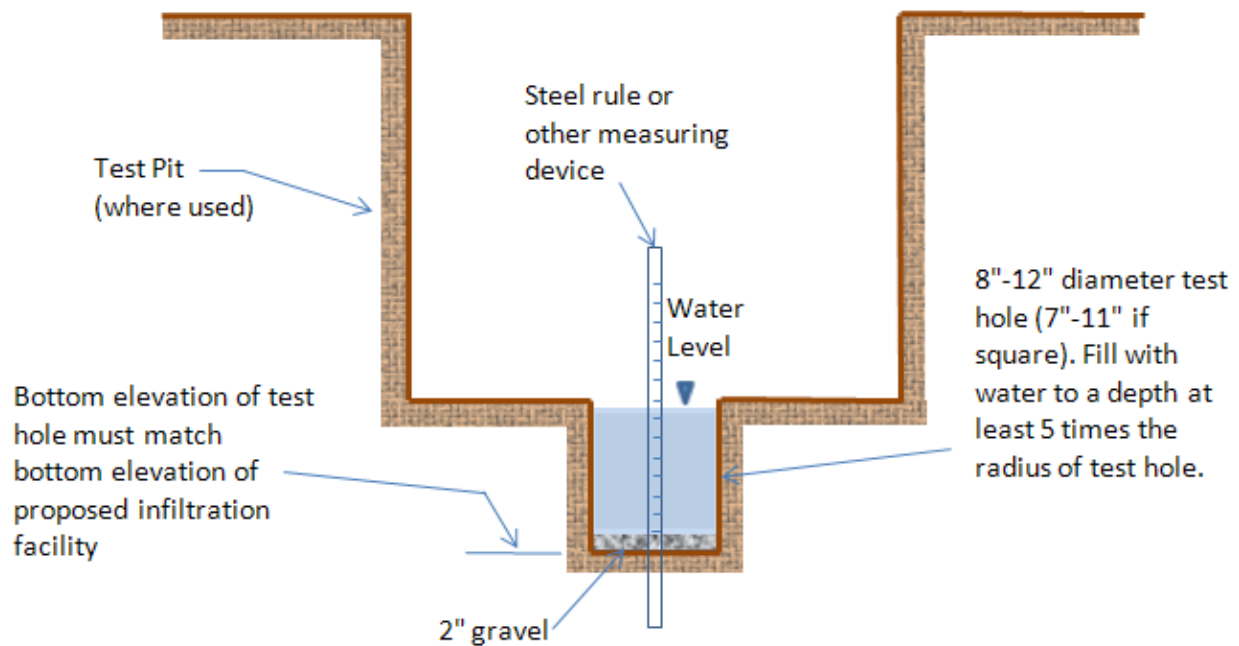

VII.3.8.2. Deep Percolation Test (10 - 40 feet)

Test Preparation

- 1) Borehole diameter shall be either 6 inch or 8 inch only. No other diameter test holes will be accepted.
- 2) The bottom elevation of the test hole shall correspond to the bottom elevation of the proposed basin (infiltration surface). Keep in mind that this procedure will require the test hole to be filled with water to a depth of at least 5 times the hole's radius.
- 3) The bottom of the test hole shall be covered with 2 inches of gravel.
- 4) The sides of the hole shall remain undisturbed (not smeared) after drilling and any cobbles encountered left in place. Special care should be taken to avoid cave-in.
- 5) **Pre-soaking** shall be used with this procedure. Invert a full 5 gallon bottle of clear water supported over the hole so that the water flow into the hole holds constant at a maximum depth of 4 feet below the surface of the ground or if grading cuts are anticipated, to the approximate elevation of the **top** of the basin but at least 5 times the hole's radius ($H/r > 5$). Pre-soaking shall be performed for 24 hours unless the site consists of sandy soils containing little or no clay. If sandy soils exist as described below, the tests may then be run after a 2 hour pre-soak. However, to assure saturated conditions, testing must commence no later than 26 hours after all pre-soak water has percolated through the test hole. The "continuous pre-soak procedure" is not accepted. When sandy soils (as described below) are present, the test shall be run immediately.

Figure VII.16. Test Pit for Deep Percolation Test

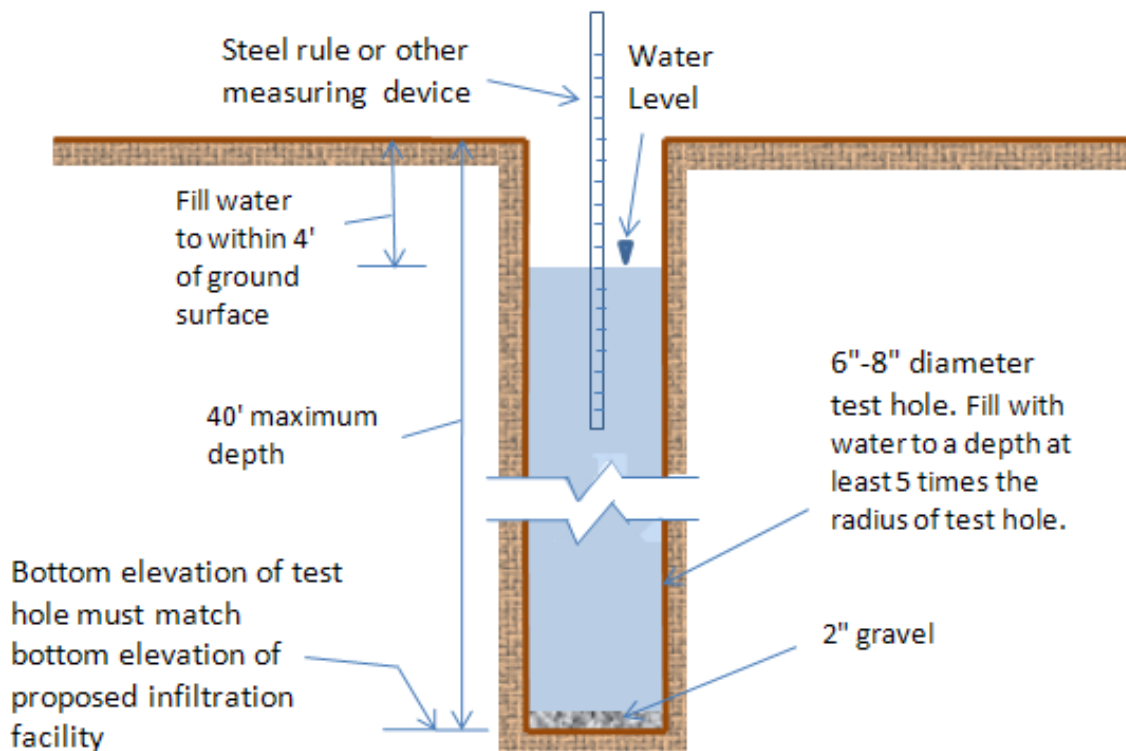

Test Procedure

Carefully fill the hole with clear water to a maximum depth of 4 feet below the surface of the ground or, if grading cuts are anticipated, to the approximate elevation of the **top** of the basin. However, at a minimum, the bore hole shall be filled with water to a depth equal to 5 times the hole's radius ($H/r > 5$).

In **sandy soils**, when 2 consecutive measurements show that 6 inches of water seeps away in less than 25 minutes, the test shall be run for an additional hour with measurements taken every 10 minutes. Measurements shall be taken with a precision of 0.25 inches or better. The drop that occurs during the final 10 minutes is used to calculate the percolation rate. Field data must show the two 25 minute readings and the six 10 minute readings.

In **non-sandy soils**, the percolation rate measurement shall be made on the day following initiation of the pre-soak as described in Item #5 above. From a fixed reference point, measure the drop in water level over a 30 minute period for at least 6 hours, refilling after every 30 minute reading. Measurements shall be taken with a precision of 0.25 inches or better. The total depth of hole must be measured at every reading to verify that collapse of the borehole has not occurred. The drop that occurs during the final reading is used to calculate the percolation rate.

Figure VII.17. Photo of Percolation Test Pit.



(Use of perforated PVC pipe is a variation.)

Figure VII.18. Sample Test Data Form for Percolation Test

Percolation Test Data Sheet								
Project:				Project No:			Date:	
Test Hole No:				Tested By:				
Depth of Test Hole, D_T :				USCS Soil Classification:				
Test Hole Dimensions (inches)					Length	Width		
Diameter (if round)=					Sides (if rectangular)=			
Sandy Soil Criteria Test*								
Trial No.	Start Time	Stop Time	Time Interval, (min.)	Initial Depth to Water (in.)	Final Depth to Water (in.)	Change in Water Level (in.)	Greater than or Equal to 6"?(y/n)	
1								
2								
*If two consecutive measurements show that six inches of water seeps away in less than 25 minutes, the test shall be run for an additional hour with measurements taken every 10 minutes. Other wise, pre-soak (fill) overnight. Obtain at least twelve measurements per hole over at least six hours (approximately 30 minute intervals) with a precision of at least 0.25".								
Trial No.	Start Time	Stop Time	Δt Time Interval (min.)	D_o Initial Depth to Water (in.)	D_f Final Depth to Water (in.)	ΔD Change in Water Level (in.)	Percolation Rate (min./in.)	
1								
2								
3								
4								
5								
6								
7								
8								
9								
10								
11								
12								
13								
14								
15								
COMMENTS:								

Example VII.1: Percolation Rate Conversion Example

(Porchet Method, aka Inverse Borehole Method):

The bottom of a proposed infiltration basin would be at 5.0 feet below natural grade. Percolation tests are performed within the boundaries of the proposed basin location with the depth of the test hole set at the infiltration surface level (bottom of the basin). The Percolation Test Data Sheet (Table 5) is prepared as the test is being performed. After the minimum required number of testing intervals, the test is complete. The data collected at the final interval is as follows:

Time interval, $\Delta t = 10$ minutes	Initial Depth to Water, $D_0 = 12.25$ inches
Final Depth to Water, $D_f = 13.75$ inches	Total Depth of Test Hole, $D_T = 60$ inches
¹³ Test Hole Radius, $r = 4$ inches	

The conversion equation is used:

$$I_t = \frac{\Delta H(60r)}{\Delta t(r + 2H_{avg})}$$

“ H_o ” is the initial height of water at the selected time interval.

$$H_o = D_T - D_0 = 60 - 12.25 = 47.75 \text{ inches}$$

“ H_f ” is the final height of water at the selected time interval.

$$H_f = D_T - D_f = 60 - 13.75 = 46.25 \text{ inches}$$

“ ΔH ” is the change in height over the time interval.

$$\Delta H = \Delta D = H_o - H_f = 47.75 - 46.25 = 1.5 \text{ inches}$$

“ H_{avg} ” is the average head height over the time interval.

$$H_{avg} = (H_o - H_f)/2 = (47.75 - 46.25)/2 = 47.0 \text{ inches}$$

“ I_t ” is the tested infiltration rate.

$$I_t = \frac{\Delta H(60r)}{\Delta t(r + 2H_{avg})} = \frac{(1.5 \text{ in})\left(\frac{60 \text{ min}}{\text{hr}}\right)(4 \text{ in})}{(10 \text{ min})((4 \text{ in}) + 2(47 \text{ in}))} = 0.37 \text{ in/hr}$$

¹³ Where a rectangular test hole is used, an equivalent radius should be determined based on the actual area of the rectangular test hole (i.e., $r = (A/\pi)^{0.5}$).

VII.4. Considerations for Infiltration Rate Factor of Safety

Given the known potential for infiltration BMPs to fail over time, an appropriate factor of safety applied to infiltration testing results must be mandatory. The infiltration rate will decline between maintenance cycles as the BMP surface becomes occluded and particulates accumulate in the infiltrative layer. Monitoring of actual facility performance has shown that the full-scale infiltration rate is far lower than the rate measured by small-scale testing. It is important that adequate conservatism is incorporated in the selection of design infiltration rates. The design infiltration rate discussed here is the infiltration rate of the underlying soil, below the elevation to which soil amendments would not be provided.

The factor of safety that should be applied to measured infiltration rates is a function of:

- Suitability of underlying soils for infiltration
- The infiltration system design.

These factors are discussed in the following sections.

The *measured infiltration rate* calculated for the purpose of infiltration infeasibility screening ([TGD Section 2.4.2.4](#)) shall be based on a factor of safety of 2.0 applied to the rates obtained from the infiltration test results. No adjustments from this value are permitted. The factor of safety used to compute the *design infiltration rate* shall not be less than 2.0, but may be higher at the discretion of the design engineer and acceptance of the plan reviewer, per the considerations described in the following sections.

It is recognized that there are competing objectives in the selection of a factor of safety. There is an initial economic incentive to select a lower factor of safety to yield smaller BMP designs. A low factor of safety also allows a broader range of systems to be considered “feasible” in marginal conditions. However, there are both economic and environmental incentives for the use of an appropriate factor of safety to prevent premature failure and substandard performance. The use of an artificially low factor of safety to demonstrate feasibility in the design process is shortsighted in that it does not consider the long term feasibility of the system.

The best way to balance these competing factors is through a commitment to thorough site investigation, use of effective pretreatment controls, good construction practices, the commitment to restore the infiltration rates of soils that are damaged by prior uses or construction practices, and the commitment to effective maintenance practices. However, these commitments do not mitigate the need to apply a factor of safety to account for uncertainty and long term deterioration that cannot be technically mitigated. Therefore, a factor of safety of no less than 2.0 shall be used to compute the design infiltration rate.

VII.4.1. Site Suitability Considerations

Suitability assessment related considerations include ([Table VII.3](#)):

- Soil assessment methods – the site assessment extent (e.g., number of borings, test pits, etc.) and the measurement method used to estimate the short-term infiltration rate.
- Predominant soil texture/percent fines – soil texture and the percent of fines can greatly influence the potential for clogging.
- Site soil variability – site with spatially heterogeneous soils (vertically or horizontally) as determined from site investigations are more difficult to estimate average properties for resulting in a higher level of uncertainty associated with initial estimates.
- Depth to seasonal high groundwater/impervious layer – groundwater mounding may become an issue during excessively wet conditions where shallow aquifers or shallow clay lenses are present.

Table VII.3: Suitability Assessment Related Considerations for Infiltration Facility Safety Factors

Consideration	High Concern	Medium Concern	Low Concern
Assessment methods (see explanation below)	Use of soil survey maps or simple texture analysis to estimate short-term infiltration rates	Direct measurement of ≥ 20 percent of infiltration area with localized infiltration measurement methods (e.g., infiltrometer)	Direct measurement of ≥ 50 percent of infiltration area with localized infiltration measurement methods or Use of extensive test pit infiltration measurement methods
Texture Class	Silty and clayey soils with significant fines	Loamy soils	Granular to slightly loamy soils
Site soil variability	Highly variable soils indicated from site assessment or limited soil borings collected during site assessment	Soil borings/test pits indicate moderately homogeneous soils	Multiple soil borings/test pits indicate relatively homogeneous soils
Depth to groundwater/ impervious layer	<5 ft below facility bottom	5-10 ft below facility bottom	>10 below facility bottom

Localized infiltration testing refers to methods such as the double ring infiltrometer test (ASTM D3385-88) which measure infiltration rates over an area less than 10 sq-ft, may include lateral

flow, and do not attempt to account for heterogeneity of soil. The amount of area each test represents should be estimated depending on the observed heterogeneity of the soil.

Extensive infiltration testing refers to methods that include excavating a significant portion of the proposed infiltration area, filling the excavation with water, and monitoring drawdown. The excavation should be to the depth of the proposed infiltration surface and ideally be at least 50 to 100 square feet.

In all cases, testing should be conducted in the area of the proposed BMP where, based on review of available geotechnical data, soils appear least likely to support infiltration.

VII.4.2. Design Related Considerations

Design related considerations include ([Table VII.4](#)):

- Size of area tributary to facility – all things being equal, risk factors related to infiltration facilities increase with an increase in the tributary area served. Therefore facilities serving larger tributary areas should use more restrictive adjustment factors.
- Level of pretreatment/expected influent sediment loads – credit should be given for good pretreatment by allowing less restrictive factors to account for the reduced probability of clogging from high sediment loading. Also, facilities designed to capture runoff from relatively clean surfaces such as rooftops are likely to see low sediment loads and therefore should be allowed to apply less restrictive safety factors.
- Redundancy – facilities that consist of multiple subsystems operating in parallel such that parts of the system remains functional when other parts fail and/or bypass should be rewarded for the built-in redundancy with less restrictive correction and safety factors. For example, if bypass flows would be at least partially treated in another BMP, the risk of discharging untreated runoff in the event of clogging the primary facility is reduced. A bioretention facility that overflows to a landscaped area is another example.
- Compaction during construction – proper construction oversight is needed during construction to ensure that the bottoms of infiltration facility are not overly compacted. Facilities that do not commit to proper construction practices and oversight should have to use more restrictive correction and safety factors.

Table VII.4: Design Related Considerations for Infiltration Facility Safety Factors

Consideration	High Concern	Medium Concern	Low Concern
Tributary area size	Greater than 10 acres.	Greater than 2 acres but less than 10 acres.	2 acres or less.
Level of pretreatment/ expected influent sediment loads	Pretreatment from gross solids removal devices only, such as hydrodynamic separators, racks and screens AND tributary area includes landscaped areas, steep slopes, high traffic areas, or any other areas expected to produce high sediment, trash, or debris loads.	Good pretreatment with BMPs that mitigate coarse sediments such as vegetated swales AND influent sediment loads from the tributary area are expected to be relatively low (e.g., low traffic, mild slopes, disconnected impervious areas, etc.).	Excellent pretreatment with BMPs that mitigate fine sediments such as bioretention or media filtration OR sedimentation or facility only treats runoff from relatively clean surfaces, such as rooftops.
Redundancy of treatment	No redundancy in BMP treatment train.	Medium redundancy, other BMPs available in treatment train to maintain at least 50% of function of facility in event of failure.	High redundancy, multiple components capable of operating independently and in parallel, maintaining at least 90% of facility functionality in event of failure.
Compaction during construction	Construction of facility on a compacted site or elevated probability of unintended/ indirect compaction.	Medium probability of unintended/ indirect compaction.	Heavy equipment actively prohibited from infiltration areas during construction and low probability of unintended/ indirect compaction.

VII.4.3. Determining Factor of Safety

A factor of safety shall be used. To assist in selecting the appropriate design infiltration rate, the measured short term infiltration rate should be adjusted using a weighted average of several safety factors using the worksheet shown in [Worksheet H](#) below. The design infiltration rate would be determined as follows:

1. For each consideration shown in [Table VII.3](#) and [Table VII.4](#) above, determine whether the consideration is a high, medium, or low concern.
2. For all high concerns, assign a factor value of 3, for medium concerns, assign a factor value of 2, and for low concerns assign a factor value of 1.
3. Multiply each of the factors by the corresponding weight to get a product.
4. Sum the products within each factor category to obtain a safety factor for each.
5. Multiply the two safety factors together to get the final combined safety factor. If the combined safety factor is less than 2, then 2 shall be used as the safety factor.
6. Divide the measured short term infiltration rate by the combined safety factor to obtain the adjusted design infiltration rate for use in sizing the infiltration facility.

The design infiltration rate shall be used to size BMPs and to evaluate their expected long term performance. This rate shall not be less than 2, but may be higher at the discretion of the design engineer.

Worksheet H: Factor of Safety and Design Infiltration Rate and Worksheet

Factor Category		Factor Description	Assigned Weight (w)	Factor Value (v)	Product (p) $p = w \times v$
A	Suitability Assessment	Soil assessment methods	0.25		
		Predominant soil texture	0.25		
		Site soil variability	0.25		
		Depth to groundwater / impervious layer	0.25		
		Suitability Assessment Safety Factor, $S_A = \Sigma p$			
B	Design	Tributary area size	0.25		
		Level of pretreatment/ expected sediment loads	0.25		
		Redundancy	0.25		
		Compaction during construction	0.25		
		Design Safety Factor, $S_B = \Sigma p$			
Combined Safety Factor, $S_{TOT} = S_A \times S_B$					
Measured Infiltration Rate, inch/hr, K_M (corrected for test-specific bias)					
Design Infiltration Rate, in/hr, $K_{DESIGN} = S_{TOT} \times K_M$					
Supporting Data					
Briefly describe infiltration test and provide reference to test forms:					

Note: The minimum combined adjustment factor shall not be less than 2.0 and the maximum combined adjustment factor shall not exceed 9.0.

VII.5. References

ASTM D 3385-94, 2003. "Standard Test Method for Infiltration Rate of Soils Field Using Double-Ring Infiltrometer." American Society for Testing Materials, Conshohocken, PA. 10 Jun, 2003.

Caltrans, 2003. "Infiltration Basin Site Selection". Study Volume I. California Department of Transportation. Report No. CTSW-RT-03-025.

City of Portland, 2010. *Appendix F.2: Infiltration Testing*. Portland Stormwater Management Manual, Revised February 1, 2010.

United States Department of the Interior, Bureau of Reclamation (USBR), 1990a, "Procedure for Performing Field Permeability Testing by the Well Permeameter Method (USBR 7300-89)," in *Earth Manual, Part 2, A Water Resources Technical Publication*, 3rd ed., Bureau of Reclamation, Denver, Colo.

APPENDIX VIII. GROUNDWATER-RELATED INFILTRATION FEASIBILITY CRITERIA

Infiltration BMPs shall not be used where they would adversely affect groundwater quality or where depth to groundwater would limit infiltration. The purpose of this section is to provide guidelines for allowable use of infiltration BMPs to protect groundwater quality and ensure physical feasibility relative to groundwater and groundwater-related geotechnical considerations. This section considers:

- Depth to groundwater and mounding potential,
- Presence of groundwater plumes,
- Wellhead protection and septic systems,
- Contamination risks from land use activities in the area tributary to the BMP,
- Consultation with applicable groundwater agencies, and
- Technical requirements for conducting site specific studies,

VIII.1. Intended Use

The criteria contained in this section are intended to be used as part of the overall feasibility screening process. If other feasibility criteria (e.g., low soil infiltration rate) render infiltration infeasible, it is not necessary to also consider the criteria contained in this section. However, before infiltration BMPs are approved for use on a project, these groundwater quality-related criteria must be evaluated.

VIII.2. Depth to Groundwater and Mounding Potential

Minimum separation between the infiltrating surface (bottom of infiltration facility) and seasonally high mounded groundwater shall be observed in the design of infiltration BMPs, depending on BMP type.

- If the depth to unmounded seasonally high groundwater is greater than 15 feet, the depth to groundwater does not constrain infiltration
- If separation to unmounded seasonally high groundwater is greater than 10-feet and the infiltration area is less than 2,000 sq-ft, the depth to groundwater does not constrain infiltration.
- The separation between the infiltrating surface and the seasonally high mounded groundwater table shall not be less than 5 feet for all BMP types. BMPs for which 5-foot minimum separation applies include:

- Rain gardens and dispersion trenches (small, residential applications)
 - Bioretention and planters
 - Permeable Pavement
 - Similar BMPs infiltrating over an extensive surface area and providing robust pretreatment or embedded treatment processes.
- Separation to mounded seasonally high groundwater shall be at least 10 feet for infiltration devices that inject water below the subsurface and surface infiltration BMPs with tributary area and land use activities that are considered to pose a more significant risk to groundwater quality. BMPs for which the 10-foot separation applies include:
 - Dry wells
 - Subsurface infiltration galleries or vaults
 - Surface Infiltration Basins
 - Infiltration Trenches
 - Other functionally similar devices or BMPs.

VIII.2.1. Approved Methods for Determining the Depth to Seasonally High Groundwater

The seasonally high groundwater table is defined as the depth to the highest level of the saturated groundwater zone. It is quantified as the average of measured annual minima (i.e., the shallowest recorded measurements in each water year, defined as October 1 through September 30 are averaged) for all years on record.

The depth to seasonally high groundwater is ideally determined from long-term groundwater level data. If groundwater level data are not available or are inadequate, the seasonal high groundwater depth can be estimated by redoximorphic analytical methods combined with temporary groundwater monitoring for November 1 through April 1 at the proposed Project site. In this approach, a professional geologist assesses soil-mottling characteristics of soil cores to determine the depth at which soil features display reductive conditions which indicate the seasonal height of groundwater.

VIII.2.2. Methods for Evaluation of Groundwater Mounding Potential

Stormwater infiltration and recharge to the underlying groundwater table will in most cases create a groundwater mound beneath the infiltration facility. The height and shape of the mound depends on the infiltration system design, the recharge rate, and the hydrogeologic conditions at the site, especially the horizontal hydraulic conductivity and the saturated thickness. Groundwater mounding beneath infiltration facilities also depends on the precipitation patterns, which affects the applied recharge rates and underlying soil moisture conditions. Maximum mounding potential is likely to occur in response to cumulative

precipitation over relatively short periods, for example, a series of intense winter storms over a one to two week period.

Methods for quantifying groundwater mounding potential range from detailed modeling studies to simple conservative estimation techniques. The methods employed by the project proponent will be subject to the acceptance of the reviewing agency.

Mounding Evaluation with Modeling Studies: A rigorous evaluation of mounding potential requires detailed site characterization and detailed modeling that accounts for the transient nature of stormwater infiltration and the site-specific hydrogeological conditions. For example, Carlton (2010)¹⁴ used MODFLOW, an industry standard groundwater flow model, to evaluate groundwater mounding potential from infiltration facilities in hypothetical 1-acre and 10-acre developments. Modeling studies to evaluate groundwater mounding potential are applicable for design studies of large regional facilities. Detailed modeling analyses are typically not feasible for evaluation of on-site facilities in small development projects or dispersed small-scale facilities in larger projects.

Mounding Estimates Based on Simplified Groundwater Equations: Estimates of maximum mounding potential can be developed from analytical solutions to groundwater equations, called the Hantush equations. These equations incorporate a number of simplifying assumptions about the hydrogeology of the site including assumptions of uniform horizontal hydraulic conductivity and vertical infiltration rates. Solution of the Hantush equations can be accomplished with a simple Excel spreadsheet tool developed by the USGS (Carlton, 2010) available at online at <http://pubs.usgs.gov/sir/2010/5102/>.

This tool is simple to use but requires inputs about the saturated zone hydraulic conductivity, the thickness of the saturated zone, and estimates of the specific yield, which is related to the effective porosity. The tool also requires inputs about the infiltration conditions, including the dimensions of the infiltration facility, the uniform infiltration rate and the period application that will result in the maximum mounding height. Use of the USGS groundwater mounding tool is applicable and recommended for planning or design level analysis where there is the sufficient information of the surface conditions of the site and use of detailed modeling is not warranted.

Where information is not available, the following assumptions are recommended for using this tool to evaluating the potential for mounding under small-scale localized BMPs. Site-specific data and professional judgment should always be used in conducting groundwater mounding analyses.

¹⁴ Carleton, G.B., 2010, Simulation of groundwater mounding beneath hypothetical stormwater infiltration basins: U.S. Geological Survey Scientific Investigations Report 2010–5102, 64 p. <http://pubs.usgs.gov/sir/2010/5102/>

- Recharge rate should be set to the design infiltration rate of the stormwater BMP, assuming that the BMP operates at its design infiltration rate throughout the critical period for groundwater mounding.
- The horizontal hydraulic conductivity should be set to 10 times the measured infiltration rate of the soil to account for typical anisotropy of natural soils (ratio of horizontal to vertical hydraulic conductivity). Note the measured infiltration rate will generally be greater than or equal to 2 times the design infiltration rate.
- The period of simulation should be set to 10 days. Applying the design infiltration rate continuously over 10 days generally results in 3-5 times the DCV infiltrated over this period considering typical BMP drawdown times.
- The specific yield should be set to 0.2.
- The saturated zone thickness should be set to 20 feet.

An example using the USGS tool is included in Example [VIII.1](#) below.

Example VIII.1: Application of USGS Groundwater Mounding Tool Using a Hypothetical Range of Infiltration Scenarios

Given:
<ul style="list-style-type: none"> • Measured soil infiltration rate: 0.2 to 4 inches per hour • Design infiltration rate: 0.1 to 2 inches per hour (Factor of Safety = 2.0) • Horizontal Hydraulic Conductivity: 2 to 40 inches per hour (Anisotropy: 10:1 (H:V) applied to measured infiltration rate) • Facility footprint: 500 to 4,000 sq-ft • <i>System aspect ratio</i>: 1:1 (square) and 5:1 • Period of simulation: 10 days (total infiltrated depth =24 to 480 inches) • Saturated zone thickness: 20 feet • Specific yield: 0.2
Required:
<ul style="list-style-type: none"> • Compute maximum mounding heights using USGS tool
Solution:

Maximum mounding heights calculated with the USGS tool are given in Figure VIII.1. While these results reflect a relatively conservative case, they indicate that system size and design infiltration rate both influence the potential for mounding. In addition, a linear geometry reduces the magnitude of mounding somewhat compared to a square geometry with the same footprint.

Figure VIII.1: Example Calculations of Maximum Mounding Height by Facility Configuration from USGS Calculator (Carlton, 2010)

(For illustration purposes only based on input assumptions above; inputs shall be based on professional judgment)

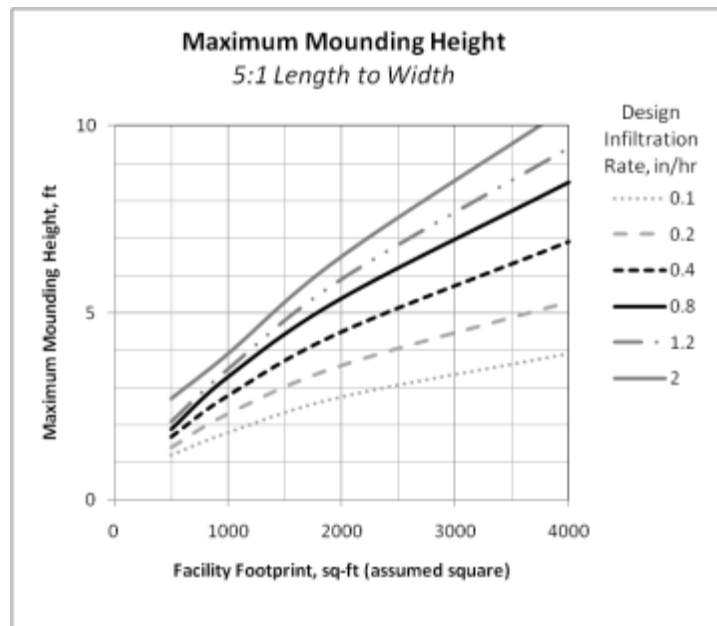
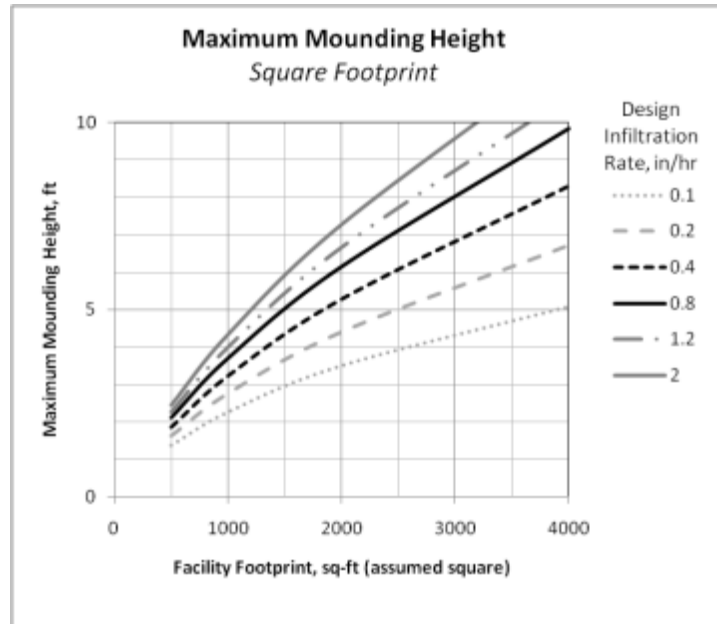

VIII.3. Groundwater Plumes

Infiltration shall not be allowed in the vicinity of mapped or potential groundwater plumes, except where infiltration would not adversely impact groundwater conditions as determined

via a site-specific or watershed study applicable to the site. In the absence of a site specific study, the following criteria apply:

- Infiltration is prohibited within *plume protection boundaries* identified by Orange County Water District (OCWD) (See [Figure VIII.2](#)), or equivalent boundaries identified by applicable groundwater agencies, unless a site specific study demonstrates that infiltration would not adversely impact groundwater conditions.
- Infiltration is prohibited in identified natural pollutant source areas (e.g., selenium) (See [Figure VIII.2](#)), unless a site specific study demonstrates that infiltration would not adversely impact groundwater conditions,
- Infiltration is prohibited within 250 feet of contaminated sites, such as sites found in the Geotracker or EnviroStor databases (<http://geotracker.swrcb.ca.gov/>, <http://www.envirostor.dtsc.ca.gov/public/>), unless a site specific study demonstrates that infiltration would not adversely impact groundwater conditions. The study must include a review of the magnitude and type of the original contaminants and byproducts shall be used to assess the level of risk posed by infiltration in the vicinity of closed sites. This criterion applies to active contaminated sites or closed sites that have significant remaining potential for pollutant mobilization as a result of stormwater infiltration.
- A site-specific investigation shall always be performed to assess the feasibility of stormwater infiltration when the project proposes to redevelop a previously-contaminated site (e.g., Brownfields or otherwise contaminated).

As locations, boundaries, and number of contamination sites is subject to change, it is the responsibility of applicants to use the most up-to-date maps available from the permittees and applicable groundwater management agencies. Requirements for conducting site-specific studies vary with project size and are identified in Section [VIII.8](#).

Basis for 250-foot Setback

The 250-foot separation distance from contaminated sites is based on the following considerations:

- In general terms, the degree of subsurface contamination typically decreases in the horizontal direction away from a contaminated site (although there can be site-specific conditions where this is not the case);
- As the distance between a contaminated site and a potential engineered infiltration system increases, the risk decreases that the engineered infiltration system will infiltrate water into subsurface contamination or otherwise negatively affect contamination originating from the contaminated site;
- By precluding engineered infiltration systems within 250 feet of a contaminated site, the risk decreases that infiltration would be increased through an area of the subsurface containing non-aqueous phase liquid contamination or areas with groundwater containing very high levels of contamination;
- A survey of sites contaminated with petroleum-related products estimated horizontal benzene plume lengths (California Leaking Underground Fuel Tank (LUFT) Historical

Case Analysis, UCRL-AR-122207, prepared by Lawrence Livermore National Laboratory, 1995). Based on a 10 part per billion concentration threshold, the survey estimated that 90 percent of the sites had benzene plume lengths of 261 feet or less. Some contaminants may have longer or shorter plume lengths than benzene and the amount of data on plume lengths is increasing as additional data are collected. Additional data and analysis may warrant reconsideration of this issue in the future.

VIII.4. Requirements for BMP Selection by Tributary Land Use Activities

Table VIII.1 provides criteria for selection of BMPs to address the potential for contamination of groundwater from tributary land use activities. Infiltration BMPs shall be selected and applied as recommended by **Table VIII.1**.

To prevent contamination from materials used in the construction of the infiltration BMP itself, soil media, construction materials, and construction practices should be appropriately selected to ensure that hazardous chemicals or groundwater pollutants of concern are not inadvertently leached to the underlying groundwater.

Figure VIII.2: North Orange County Groundwater Basin Protection Boundary and Plume Protection Boundaries (See Figure XVI.2f for high resolution exhibit)

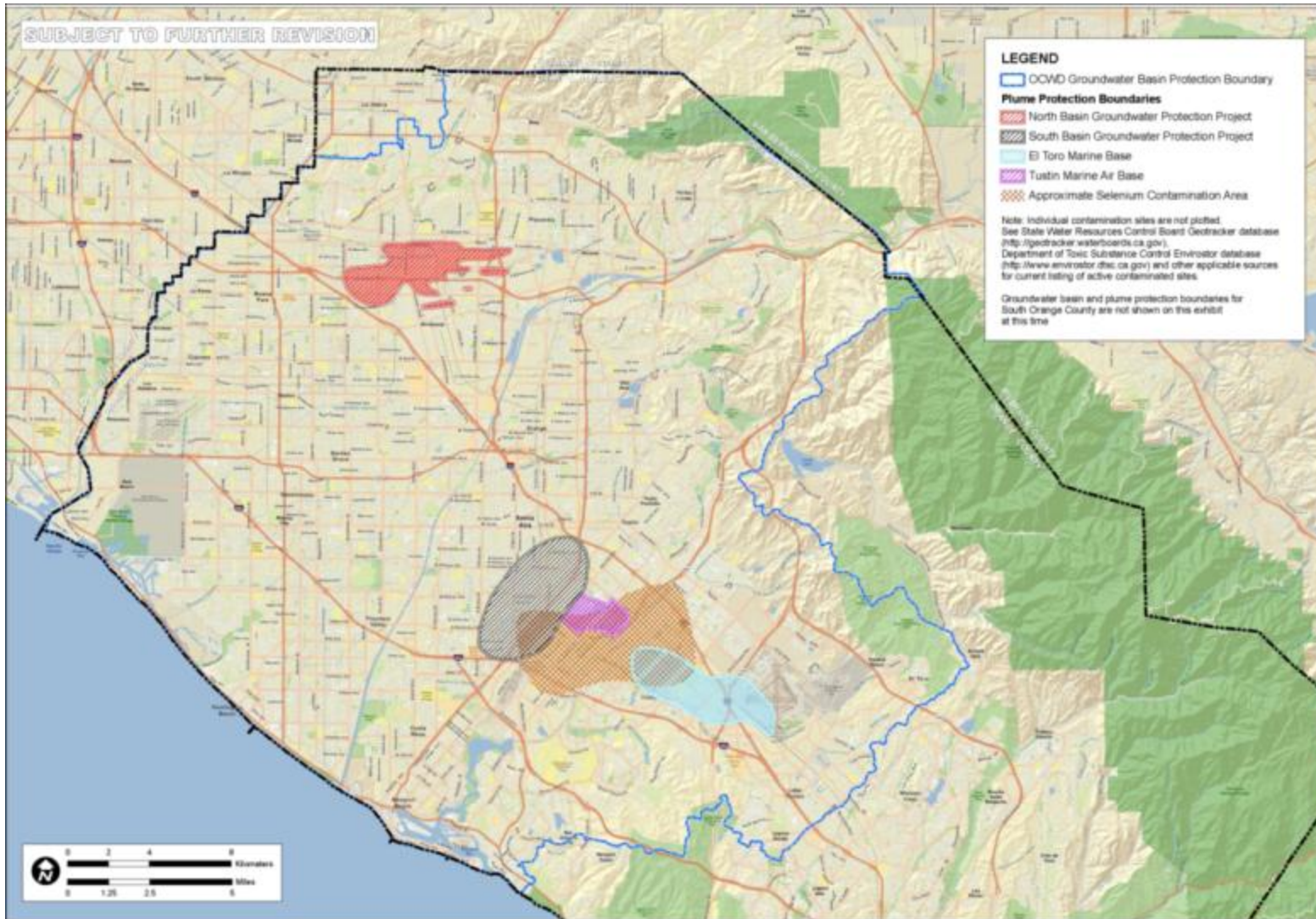

Table VIII.1: Recommendations/Requirements for BMP Selection to Minimize Groundwater Quality Impacts

Tributary Area Risk Category	Narrative Description of Category	Example Land Use Activities	BMP Selection Requirements
Low Runoff Contamination Potential	BMP receives runoff from a mix of land covers that are expected to have relatively clean runoff; significant spills in tributary area are unlikely.	<ul style="list-style-type: none"> • Rooftops with roofing material and downspouts free of copper and zinc • Patios, sidewalks, and other pedestrian areas • Mixed residential land uses with applicable source controls • Institutional land uses with applicable source controls • Driveways and minor streets 	<ul style="list-style-type: none"> • Any infiltration BMP type may be used • Pretreatment for sediment is strongly recommended, as applicable, to mitigate clogging
Moderate Runoff Contamination Potential	BMP receives runoff from a mix of land covers, more than 10 percent of which have the potential to generate stormwater pollutants at levels that could potentially contaminate groundwater; there is potential for minor spills in the tributary area.	<ul style="list-style-type: none"> • Roadways greater than 5,000 ADT but less than 25,000 ADT • Commercial and institutional parking lots • Commercial land uses • Light industrial that does not include usage of chemicals that are mobile in stormwater and groundwater • Trash storage areas 	<ul style="list-style-type: none"> • Any infiltration BMP type may be used • Pretreatment shall be used • The type of pretreatment shall be selected to address potential groundwater contaminants potentially found in stormwater runoff.
High Runoff Contamination Potential	BMP receives runoff from a mix of land covers, more than 10 percent of which have significant unavoidable potential to generate stormwater pollutants in quantities that could be detrimental to groundwater quality; and/or there is significant potential for major spills that could drain to BMPs.	<ul style="list-style-type: none"> • Roads greater than 25,000 ADT • Heavy and light industrial pollutant source areas, including areas with exposed industrial activity and high use industrial truck traffic, and any areas that cannot be isolated these areas. Does not include lower risk source sources areas within industrial zones (e.g., roofs, offices, and parking areas) that are hydrologically isolated from industrial pollutant source areas • Automotive repair shops • Car washes • Fleet storage areas • Nurseries, agriculture, and heavily managed landscape areas with extensive use of fertilizer • Fueling stations (infiltration prohibited under all conditions) 	<ul style="list-style-type: none"> • Infiltration is prohibited unless advanced pretreatment and spill isolation can be feasibly used and enhanced monitoring and inspection are implemented. • Large projects¹⁵ must evaluate feasibility of advanced pretreatment and spill isolation. • Small projects¹⁵ may consider infiltration to be infeasible with narrative discussion.

¹⁵ See Table VIII.2 for definition of “Large” and “Small” projects.

VIII.5. Well Head Protection and Septic Systems

To ensure protection of groundwater quality, the following criteria shall be met:

- Stormwater shall not be infiltrated within 100 feet horizontally of a water supply well, non-potable well, or spring.
- Stormwater shall not be infiltrated within 100 feet horizontally of a septic tank drain field.

Because data regarding the location of supply wells, springs, and septic systems is not generally available to the public, the project proponent is strongly encouraged to consult with the local review agency early in the WQMP preparation process to determine whether these conditions apply to all or part of the project site.

VIII.6. Stormwater Runoff Pollutants

Stormwater BMPs shall be selected to minimize the introduction of contaminants into groundwater via infiltration of stormwater runoff. The potential for groundwater contamination from pollutants found in stormwater runoff is a function of the land use activities that are present in the tributary area to the BMP. [Table VIII.2](#) provides requirements for selection of BMPs and pretreatment devices based on the level of risk posed by land use activities.

VIII.7. Consultation with Applicable Groundwater Management Agencies

Projects that propose to infiltrate stormwater are required to consult with the applicable groundwater management agency to the extent necessary to ensure that groundwater quality is protected.

The process for consultation with applicable groundwater management agencies was under development at the time of publication and is not included in this TGD. It is anticipated that guidelines will be published in the future that include:

- Description of the consultation process
- Description of the conditions under which consultation is necessary
- Discussion of the point in the project process at which consultation should be initiated for qualifying projects
- Discussion of the review schedule and fees (if applicable)
- Materials that should be submitted as part of this process
- Discussion of potential outcomes and actions from this process

Until guidelines are published, all infiltration activities should be coordinated with the applicable groundwater management agency, such as OCWD, to ensure groundwater quality is protected. It is recommended that coordination be initiated as early as possible during the Preliminary/Conceptual WQMP development process.

Applicable groundwater management agencies

North Orange County Groundwater Basin:	Orange County Water District Attn: Director of Planning 18700 Ward Street Fountain Valley, CA 92708
San Juan Groundwater Basin:	San Juan Basin Authority

In addition, LID infiltration facilities may potentially be categorized as “Class V Injection Wells” under the federal Underground Injection Control (UIC) Program, which is regulated in California by U.S. EPA Region 9. The EPA defines a Class V well as any bored, drilled, or driven shaft, or dug hole that is deeper than its widest surface dimension, or an improved sinkhole, or a subsurface fluid distribution system (an infiltration system with piping to enhance infiltration capabilities). A UIC permit may be required for such a facility (for details see <http://www.epa.gov/region9/water/groundwater/uic-classv.html>).

VIII.8. Technical Requirements for Site Specific Study of Infiltration Impacts on Groundwater Quality

VIII.8.1. Project Size Applicability

Regardless of project size, any project proposing to use infiltration BMPs within a *plume protection boundary* (see Exhibit IX-3) or within 250 ft of a contaminated site shall conduct a site-specific study prior to using these BMPs to demonstrate that infiltration will not have adverse impacts on groundwater quality.

For small projects, a site-specific study is not required unless the project proponent chooses to use infiltration, in which case a site-specific study shall be prepared. If the proponent does not choose to use infiltration, the presence of one of the above-referenced conditions (including: shallow groundwater depth or mounding potential, presence of groundwater plumes, proximity to wellheads or septic systems, risks from land use activities, or other site-specific feasibility concerns) is sufficient to demonstrate infeasibility of infiltration BMPs.

For large projects, a site-specific study is required to determine if infiltration is feasible and would not adversely impact groundwater quality in the vicinity of plume(s) and/or contaminated sites, or adversely affect groundwater drinking supplies.

Large projects and small projects are defined in [Table VIII.2](#).

Table VIII.2: Definition of Project Size Categories

	Residential	Commercial, Institutional	Industrial
Small Projects	Less than 10 acres and less than 30 DU	Less than 5 acres and less than 50,000 SF	Less than 2 acre and less than 20,000 SF
Large Projects	Greater than 10 acres or greater than 30 DU	Greater than 5 acres or greater than 50,000 SF	Greater than 2 acre or greater than 20,000 SF

VIII.8.2. Information and Documentation Required in Site-Specific Study

If a project proponent proposes to use infiltration BMPs within a *plume protection boundary* (see Exhibit IX-3) or within 250 ft of a contaminated site, the project proponent shall provide a written report to demonstrate that infiltration does not pose an adverse risk to groundwater. The written report should be prepared by a state-certified professional and provided to OCWD for review and comment. The report shall document that the following conditions are met:

1. Lateral and vertical extent of soil or groundwater contamination is defined at the site and is defined for off-site areas if contamination has migrated to the boundary of the site.
2. Groundwater conditions are defined based on site specific data (e.g., subsurface sediment characteristics, depth to groundwater, groundwater flow direction, rate of groundwater movement).
3. Ongoing monitoring of soil or groundwater contamination is occurring and will continue to occur, as necessary.
4. A state-certified professional evaluates soil and groundwater data and evaluates whether proposed stormwater infiltration could cause adverse impacts to groundwater quality; an adverse impact to groundwater quality could include changing the movement of groundwater contamination, causing additional amounts of contamination in the unsaturated zone to migrate into the saturated zone, or negatively impacting an existing remediation system.
5. The applicable regulatory agency is identified and has continuing authority to require additional investigation or cleanup work if stormwater infiltration causes an adverse impact on groundwater quality.

In summary, infiltration shall not be allowed for sites where there is substantial evidence of an adverse risk to groundwater quality.

Worksheet I: Summary of Groundwater-related Feasibility Criteria

1	Is project large or small? (as defined by Table VIII.2) circle one	Large		Small
2	What is the tributary area to the BMP?	A		acres
3	What type of BMP is proposed?			
4	What is the infiltrating surface area of the proposed BMP?	A_{BMP}		sq-ft
5	What land use activities are present in the tributary area (list all)			
6	What land use-based risk category is applicable?	L	M	H
7	If M or H, what pretreatment and source isolation BMPs have been considered and are proposed (describe all):			
8	What minimum separation to mounded seasonally high groundwater applies to the proposed BMP? See Section VIII.2 (circle one)	5 ft		10 ft
9	Provide rationale for selection of applicable minimum separation to seasonally high mounded groundwater:			
10	What is separation from the infiltrating surface to seasonally high groundwater?	SHGWT		ft
11	What is separation from the infiltrating surface to mounded seasonally high groundwater?	Mounded SHGWT		ft
12	Describe assumptions and methods used for mounding analysis:			
13	Is the site within a plume protection boundary (See Figure	Y	N	N/A

Worksheet I: Summary of Groundwater-related Feasibility Criteria

	VIII.2)?	
14	Is the site within a selenium source area or other natural plume area (See Figure VIII.2)?	Y N N/A
15	Is the site within 250 feet of a contaminated site?	Y N N/A
16	If site-specific study has been prepared, provide citation and briefly summarize relevant findings:	
17	Is the site within 100 feet of a water supply well, spring, septic system?	Y N N/A
18	Is infiltration feasible on the site relative to groundwater-related criteria?	Y N
Provide rationale for feasibility determination:		

Note: if a single criterion or group of criteria would render infiltration infeasible, it is not necessary to evaluate every question in this worksheet.

APPENDIX IX. TECHNICAL BASIS FOR GREEN ROOF DESIGN CRITERIA

The purpose of this appendix is to present minimum criteria for green roofs (roofs with growing media and vegetation) to be considered “self-retaining” for new development and significant redevelopment projects in Orange County. Self-retaining areas are designed to retain the DCV and no further management of these areas is required to meet LID and treatment control performance criteria. This category also includes brown roofs, which are designed with vegetation intended to go seasonally dormant during dry periods. This document describes the functional definition of “self-retaining” that has been applied to green roofs, presents an overview of the analytical methods used to evaluate performance of a range of design criteria, and presents the results of this analysis in terms of the minimum design criteria for green roofs to be considered self-retaining.

IX.1. Functional Definition of “Self-Retaining” for Green roofs

HSCs are group of low-tech stormwater management measures that reduce stormwater runoff volume through landscape dispersion and interception of stormwater. As described above, if an HSC is to be considered “self-retaining,” it should fully retain the volume from the LID design storm event.

Green roofs are a form of HSC. These systems reduce stormwater runoff volume by retaining a portion of rainfall in soil pores and surface and plant depression storage during storm events and making it available for subsequent ET. Green roofs also provide biotreatment/ biofiltration of water draining through and over roofs, removing pollutants deposited from the atmosphere or from adjacent transportation land uses. Finally, green roofs can have additional benefits beyond stormwater management, including reductions in building heating and cooling costs and reductions in urban heat island effects. As such, green roofs should be encouraged where they can provide appreciable benefit for stormwater management. They do require irrigation, so their effects on water demand should be considered. In addition, green roofs may use reclaimed water for irrigation and measures may be required to mitigate the risk of discharges leaving the site. Green roofs are considered to be self-retaining on the basis that they provide the maximum feasible area for ET and provide biotreatment for the remaining portion of the DCV. Ground-level LID BMPs must still be provided for ground level drainage areas, where feasible, and optionally can be sized to provide additional volume reduction and biotreatment of runoff from green roofs.

The volume reduction potential of green roofs is relatively limited in the southern California climate because of typical patterns of precipitation and ET: during winter months when the majority of rainfall occurs, and particularly during the typical short periods of back-to-back rainfall events, ET rates are relatively low, and pore space is recovered relatively slowly. As such, it is not generally possible for green roofs to provide reliable reduction of the entire DCV within the timeframe criteria applied to other HSCs. To recognize this limitation and still encourage the use of these system, a green roof would be considered to be “self-retaining” (i.e., requiring no other stormwater mitigation measures for the DCV) if the roof retains at least 40 percent of average long term precipitation volume and biotreats the remaining volume.

IX.2. Analysis Inputs

To determine the minimum design criteria for a green roof to be considered self-retaining, a simple modeling analysis of precipitation, ET patterns, and green roof design parameters was conducted. This analysis included the following inputs:

- **60 year of hourly precipitation data** from the NCDC Los Angeles International Airport (LAX) climate station (COOP ID: 045114)¹⁶. The average annual precipitation at LAX is 12 inches, which is approximately the same as observed over much of Orange County, therefore this analysis is applicable to Orange County.
- **Monthly normal reference ET data** from the NCDC Cooperative Summary of the Day at LAX (COOP ID: 045114) (See note 16).
- **Ranges of green roof extensiveness.** Extensiveness is defined as the ratio of the area covered by green roof to the area tributary to the roof (including the roof itself). Extensiveness has a maximum of 1.0. For the study, extensiveness varied from 0.5 (half the roof occupied by green roof with the remaining area draining to the green roof) to 1.0 (the full roof covered by the green roof, or the green roof portion not receiving any “run-on” from other areas).
- **Ranges of landscape coefficients.** The landscape coefficient (K_L) is a multiplier on the ET rate that accounts for the plant species, micro climate (exposure, etc.), and the density of vegetative cover. For the study, landscape coefficients of 0.5 and 0.75 were evaluated, representing low water use species and moderate water use species, respectively. Landscape coefficients are generally believed to be higher on roof tops than for ground-level landscaping because of high exposure to sun and wind. It is not recommended that high water use species be used in green roofs because of the high irrigation demand exerted during summer months and winter dry periods.

¹⁶ This analysis was prepared from data originally developed for another Geosyntec project; therefore different input data sources have been used than were used for other analyses described in this TGD. The input data used for this analysis is believed to be representative of Orange County and differences are very likely within the range of model sensitivity/uncertainty.

- **Ranges of soil moisture retention depth.** Green roof moisture retention depth is the equivalent depth of water that a green roof can hold long enough for ET to have an appreciable effect. For engineered extensive or intensive roofs, this is defined as the field capacity (FC, the volumetric water content retained in soil after a prolonged period of draining) minus the wilting point (WP, the lowest volumetric water content that can be achieved via plant transpiration processes). This is generally 15 to 20 percent of the actual thickness of the green roof, depending on the characteristics of the growing media. Some proprietary green roof systems utilized specialized light weight media with enhanced soil moisture retention properties or synthetic materials such as plastic cup layers and wicking materials. These systems are generally specified in terms of the effective depth of water they retain (i.e., the soil moisture retention depth). Soil moisture retention depth was varied from 0 up to 4 inches for this study, representing simple green roofs up to approximately 30 inches deep.

IX.3. Analysis Methods

For the purpose of this analysis, Geosyntec developed a model written in VBA (Excel) that incorporates the inputs described above on an hourly basis and tracks the transient storage contained in soil moisture storage. The model can best be thought of as physically representing a bucket of water, where the water level in the bucket corresponds to the amount of moisture held in the green roof soil. Precipitation is applied over the roof and other areas tributary to the roof at hourly time steps corresponding to historical records. When the capacity of the soil moisture layer is exceeded, runoff occurs. During and between events, the monthly normal ET rate is applied to the stored water to recover the storage in the soil moisture layer (i.e., empty the bucket). The precipitation and runoff is tracked and totaled for the model run, yielding the average fraction volume removed.

IX.4. Results

Results are presented in terms of the soil moisture retention depth required to achieve at least 40 percent reduction in volume. Results are presented in Table IX.1. Graphical output of model results are shown in Figure IX.1 and [Figure IX.2](#), and are expressed in terms of landscape coefficient. The landscape coefficient describes the fraction of reference ET that can be assumed to be evapotranspired for a given plant palette. The higher the landscape coefficient, the shallower the depth of the green roof needs to be to achieve 40 percent retention. This would be expected, since water lost to ET is retained (does not run off) and higher landscape coefficient increases the rate of ET. Likewise increasing the extensiveness of a roof has the same effect, since larger green roof surface area per unit of stored volume yields faster moisture recovery rates.

It should be noted that when designing a green roof, consideration should be given to summer irrigation demands as well as wet season performance. While a higher landscape coefficient and

more extensive area would theoretically increase wet season performance, this would also tend to increase irrigation demand during the dry season and during dry periods of the wet season.

Table IX.1: Green Roof Moisture Retention Depth Required for 40 Percent Volume Reduction, Los Angeles/Orange County

<i>Landscape Coefficient (K_L) = 0.5</i>						
Extensiveness	0.5	0.6	0.7	0.8	0.9	1.0
Minimum Required Moisture Retention Depth, inches	1.3	1.05	0.9	0.8	0.7	0.6
Typical Soil Depth Required to Provide Minimum Moisture Retention Depth(FC - WP = 0.15)	8.7	7.0	6.0	5.3	4.7	4.0
<i>Landscape Coefficient (K_L) = 0.75</i>						
Extensiveness	0.5	0.6	0.7	0.8	0.9	1.0
Minimum Required Moisture Retention Depth, inches	0.9	0.75	0.65	0.55	0.5	0.45
Typical Soil Depth Required to Provide Minimum Moisture Retention Depth(FC - WP = 0.15)	6.0	5.0	4.3	3.7	3.3	3.0

K_L = Landscape Coefficient; WP = soil wilting point; FC = soil field capacity

Figure IX.1: Green Roof Performance Relationships for Los Angeles and Orange County, Landscape Coefficient (K_L) = 0.5 (Low water use plant palette)

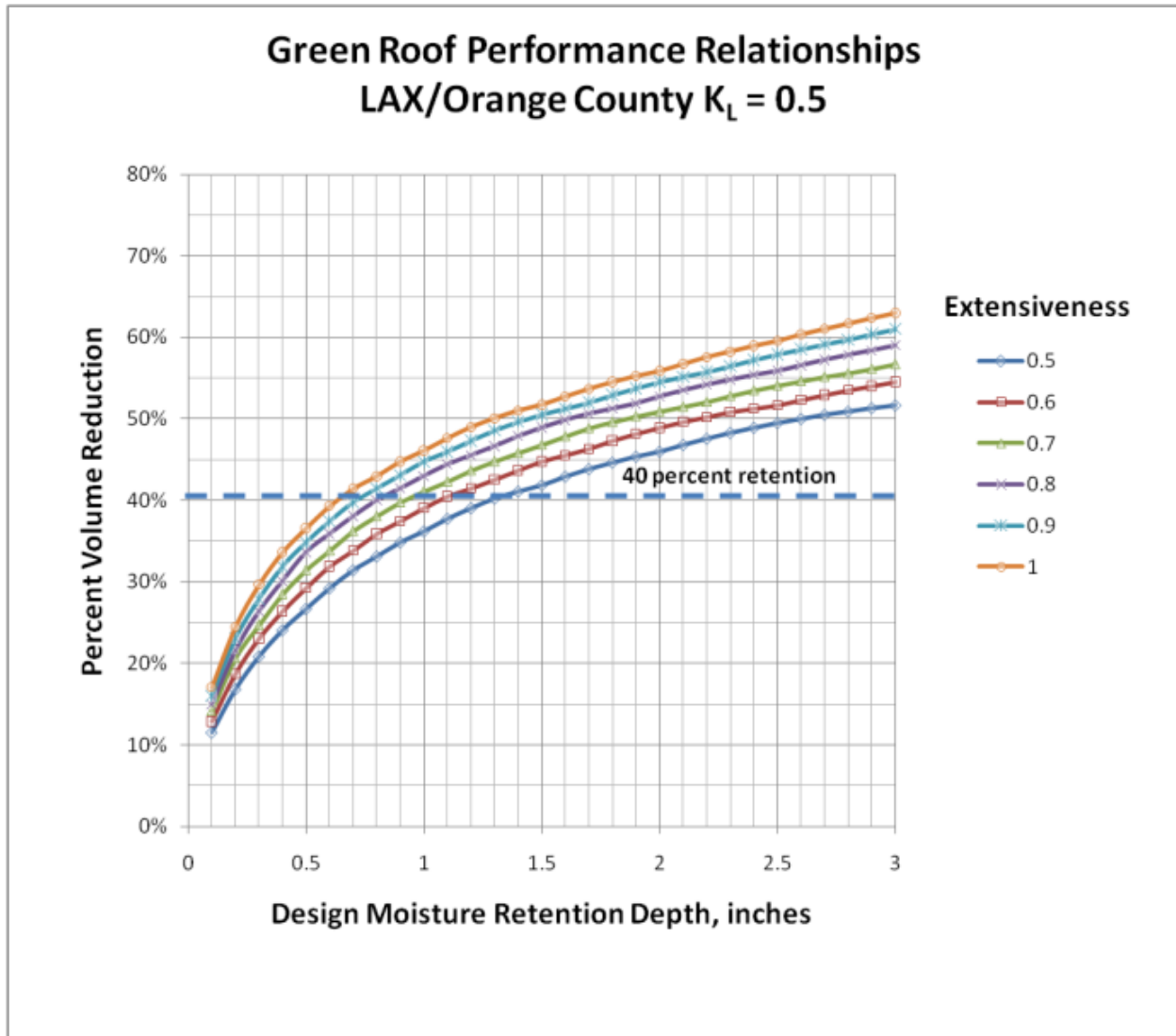
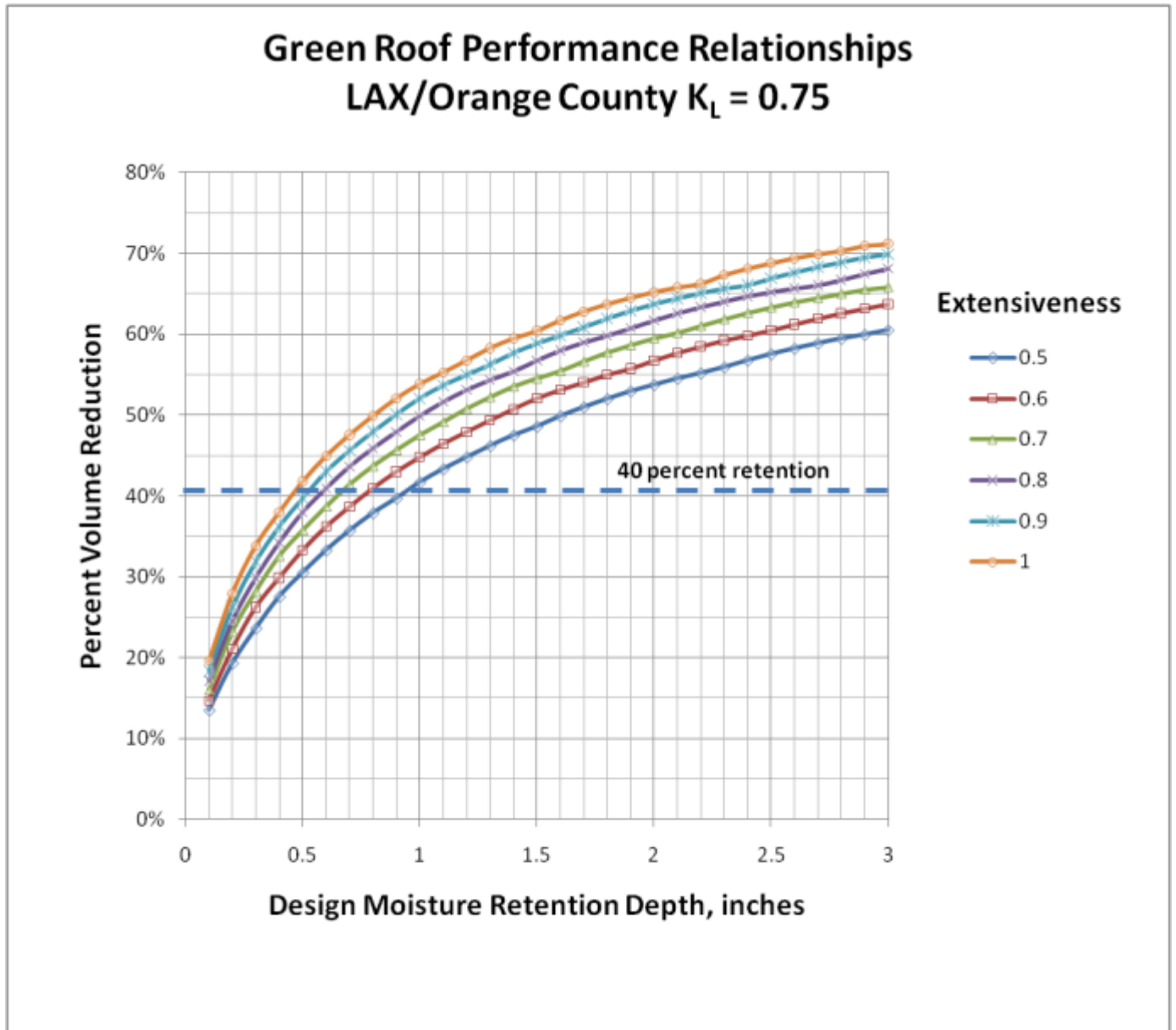

Figure IX.2: Green Roof Performance Relationships for Los Angeles and Orange County, Landscape Coefficient (K_L) = 0.75 (Moderate water use plant palette)



APPENDIX X. HARVEST AND USE DEMAND CALCULATIONS AND FEASIBILITY SCREENING

X.1. Introduction

The purpose of this appendix is to provide guidance for calculating harvested water demand and provide the technical basis for the harvest and use feasibility screening thresholds. This appendix contains the following:

- References for harvested water demand and guidance for preparing project-specific harvested water demand calculations
- Evaluation of required harvested water demand for minimum partial feasibility of harvest and use systems

Harvested water demand should be evaluated at the scale of the project, and not limited to single drainage areas. It is assumed that harvested water collected from one drainage area could be used within another.

X.2. Harvested Water Demand Calculation

The following sections provide technical references and guidance for estimating the harvested water demand of a project. These references are intended to be used for the planning phase of a project and for feasibility screening purposes.

X.2.1. Key Differences in Demand Calculations for Harvest and Use Feasibility versus Water Supply Planning

It is very important to note that harvested water demand calculations differ in purpose and methods from water demand calculations done for water supply planning. When designing harvest and use systems for stormwater management, a reliable method of relatively quickly regenerating storage capacity (i.e., using water) must exist to provide storage capacity for subsequent storms. Therefore, demand calculations for harvest and use BMPs should attempt to estimate the *actual demand that is reliably present to drain stormwater cisterns during the wet season and especially within short-term (week to a couple of weeks) series of storms that are typical*. This objective is fundamentally different from the objectives of water demand forecasting calculations done for water supply planning, which may err toward higher estimates of demand to provide conservatism to account for uncertainty. Harvested water demand calculations used to determine the feasibility of harvest and use BMPs must be based

on estimates of actual expected demand that are reliably present to drain the cistern during the wet season.

X.2.2. Types of Harvested Water Demand

Types of non-potable water demand anticipated to be applicable in the foreseeable future include:

- Toilet and urinal flushing
- Irrigation
- Vehicle washing
- Evaporative cooling
- Dilution water for recycled water systems
- Industrial processes
- Other non-potable uses

The following sections are divided between toilet flushing, outdoor irrigation demand, and other non-potable demands. The primary distinction between toilet/urinal flushing and irrigation demand is the level of treatment and disinfection that is required to use the water and the seasonal pattern of the demand. Other non-potable demands (e.g. industrial processes for example) are anticipated to be highly project specific and should be calculated using project-specific information.

X.2.3. Toilet and Urinal Flushing Demand Calculations

The following guidelines should be followed for computing harvested water demand from toilet and urinal flushing:

- If reclaimed water is planned for use for toilet and urinal flushing, then the demand for harvested stormwater is equivalent to the total demand minus the reclaimed water supplied, and should be reduced by the amount of reclaimed water that is available during the wet season. The basis for this priority is provided in Section [X.2.8](#).
- Demand calculations for toilet and urinal flushing should be based on the average rate during the wet season for a typical year.
- Demand calculations should include changes in occupancy over weekends and around holidays and changes in attendance/enrollment over school vacation periods.
- For facilities with generally high demand but periodic shut downs (e.g., for vacations, maintenance, or other reasons), a project specific analysis should be conducted to determine whether performance stormwater management can be maintained despite shut downs.
- Such an analysis should consider the statistical distributions of precipitation and demand, foremost the relationship of demand to the wet seasons of the year.

Table X.1 provides planning level estimated toilet and urinal flushing demand per resident or employee for a variety of project types. The per capita use per day is based on daily employee or resident usage. For non-residential types of development, the “visitor factor” and “student factor” (for schools) should be multiplied by the employee use to account for toilet and urinal usage for non-employees using facilities.

Table X.1: Toilet and Urinal Water Usage per Resident or Employee

Land Use Type	Toilet User Unit of Normalization	Per Capita Use per Day		Visitor Factor ⁴	Water Efficiency Factor	Total Use
		Toilet Flushing ^{1,2}	Urinals ³			
Residential	Resident	18.5	NA	NA	0.5	9.3
Office	Employee (non-visitor)	9.0	2.27	1.1	0.5	7 (avg)
Retail	Employee (non-visitor)	9.0	2.11	1.4	0.5	
Schools	Employee (non-student)	6.7	3.5	6.4	0.5	33
Various Industrial Uses (excludes process water)	Employee (non-visitor)	9.0	2	1	0.5	5.5

1- Based on American Waterworks Association Research Foundation,1999. Residential End Uses of Water. Denver, CO: AWWARF

2 - Based on use of 3.45 gallons per flush and average number of per employee flushes per subsector, Table D-1 for MWD (Pacific Institute, 2003)

3 - Based on use of 1.6 gallons per flush, Table D-4 and average number of per employee flushes per subsector, Appendix D (Pacific Institute, 2003)

4 - Multiplied by the demand for toilet and urinal flushing for the project to account for visitors. Based on proportion of annual use allocated to visitors and others (includes students for schools; about 5 students per employee) for each subsector in Table D-1 and D-4 (Pacific Institute, 2003)

5 - Accounts for requirements to use ultra low flush toilets in new development projects; assumed that requirements will reduce toilet and urinal flushing demand by half on average compared to literature estimates. Ultra low flush (ULF) toilets are required in all new construction in California as of January 1, 1992. ULF toilets must use no more than 1.6 gallons per flush (gpf) and ULF urinals must use no more than 1 gpf.

(http://www.fypower.org/com/tools/products_results.html?id=100139) Note: If zero flush urinals are being used, adjust accordingly.

X.2.4. General Requirements for Irrigation Demand Calculations

The following guidelines should be followed for computing harvested water demand from landscape:

- If reclaimed water is planned for use for landscape irrigation, then the demand for harvested stormwater should be reduced by the amount of reclaimed water that is available during the wet season. The basis for this priority is provided in Section [X.2.8](#).
- Irrigation rates should be based on the irrigation demand exerted by the types of landscaping that are proposed for the project, with consideration for water conservation requirements.
- Irrigation rates should be estimated to reflect the average wet season rates (defined as November through April) accounting for the effect of storm events in offsetting harvested water demand. In the absence of a detailed demand study, it should be assumed that irrigation demand is not present during days with greater than 0.1 inches of rain and the subsequent 3 day period. This irrigation shutdown period is consistent with standard practice in land application of wastewater and is applicable to stormwater to prevent irrigation from resulting in dry weather runoff. Based on a statistical analysis of Orange County rainfall patterns, approximately 30 percent of wet season days would not have a demand for irrigation.
- If land application of stormwater is proposed (irrigation in excess of agronomic demand), then this BMP must be considered to be an infiltration BMP and feasibility screening for infiltration must be conducted. In addition, it must be demonstrated that land application would not result in greater quantities of runoff as a result of saturated soils at the beginning of storm events. Agronomic demand refers to the rate at which plants use water.

The following sections describe methods that should be used to calculate harvested water irrigation demand. While these methods are simplified, they provide a reasonable estimate of potential harvested water demand that is appropriate for feasibility analysis and project planning. These methods may be replaced by a more rigorous project-specific analysis that meets the intent of the criteria above.

X.2.5. OC Irrigation Code Demand Calculation Method

This method is based on the [County of Orange Landscape and Irrigation Code and Implementation Guidelines](#) Ordinance No. 09-010 (OC Irrigation Code). The OC Irrigation Code includes a formula for estimating a project's annual Estimated Applied Water Use (EAWU) based on the reference evaporation, landscape coefficient, and irrigation efficiency.

For the purpose of calculating harvested water irrigation demand applicable to the sizing of harvest and use systems, the EAWU has been modified to reflect typical wet-season irrigation demand. This method assumes that the wet season is defined as November through April. This method further assumes that no irrigation water will be applied during days with precipitation totals greater than 0.1 inches or within the 3 days following such an event. Based on these assumptions and an analysis of Irvine precipitation patterns, irrigation would not be applied during approximately 30 percent of days from November through April.

The following equation is used to calculate the Modified EAWU:

$$\text{Modified EAWU} = (\text{ET}_{\text{OWet}} \times K_L \times \text{LA} \times 0.015) / \text{IE}$$

Where:

Modified EAWU = estimated daily average water usage during wet season

ET_{OWet} = Average Reference ET from November through April (inches per month, See Section X.2.5.1)

K_L = Landscape Coefficient, K_L = K_s × K_d × K_{mc} (See Section X.2.5.2)

K_s = species factor

K_d = density factor

K_{mc} = microclimate factor

LA = Landscape Area (sq-ft)

IE = Irrigation Efficiency (assume 90 percent for demand calculations)

In this equation, the coefficient (0.015) accounts for unit conversions and shut down of irrigation during and for the three days following a significant precipitation event:

$$0.015 = (1 \text{ mo}/30 \text{ days}) \times (1 \text{ ft}/12 \text{ in}) \times (7.48 \text{ gal}/\text{cu-ft}) \times (\text{approximately } 7 \text{ out of } 10 \text{ days with irrigation demand from November through April})$$

When using this method, the worksheets contained within the OC Irrigation Code may be useful to determine the irrigation use for a project site, with the appropriate modifications to reflect the Modified EAWU calculations. These worksheets allow the user to area-weight the inputs for irrigation.

X.2.5.1. Reference ET Data

Table X.2 contains data derived from CIMIS for the cities of Irvine, Santa Ana, and Laguna Beach.

Table X.2: Monthly Reference ET Rates for Orange County (Inches)

Station	J	F	M	A	M	J	J	A	S	O	N	D	Annual	Wet Season Average (in/mo) (Nov to Apr)
Irvine	2.2	2.5	3.7	4.7	5.2	5.9	6.3	6.2	4.6	3.7	2.6	2.3	49.9	3.00
Laguna Beach	2.2	2.7	3.4	3.8	4.6	4.6	4.9	4.9	4.4	3.4	2.4	2.0	43.3	2.75
Santa Ana	2.2	2.7	3.7	4.5	4.6	5.4	6.2	6.1	4.7	3.7	2.5	2.0	48.3	2.93

Source: [County of Orange Landscape and Irrigation Code and Implementation Guidelines](#)

X.2.5.2. Landscape Coefficient (K_L)

The [Water Use Classifications of Landscape Species](#) (WUCOLS, University of California and Department of Water Resources, 2000) should be used to determine the landscape coefficient that is applicable to each landscape irrigation zone. The landscape coefficient, K_L , is based on the product of the species factor (K_s), the density (K_d), and the microclimate (K_{mc}).

- The species factor is based on plant water needs derived from available data. At the time of the 2000 WUCOLS, 1,800 plant species had been evaluated for relative water needs. Specific species factors for these plant species are available in WUCOLS.
- The density factor is related to the vegetative or leaf cover for different plantings. Thinner or thicker than average density conditions are assigned density coefficients less than or greater than 1.0, respectively.
- The microclimate factor is related to features present in the urban landscape that influence temperature, wind, shading, and other climatic factors. An ‘average’ microclimate is equivalent to reference ET conditions (1.0), which is relatively uninfluenced by nearby buildings, structures, etc.

Table X.3 provides a general overview of these factors, ranging from low to high water use plant palettes.

Table X.3: Species, Density, and Microclimate Factors from WUCOLS for High, Moderate, Low and Very Low Water Use Plant Palettes

	High	Moderate	Low	Very Low
Species Factor* (k_s)	0.7-0.9	0.4-0.6	0.1-0.3	<0.1
Density (k_d)	1.1-1.3	1.0	0.5-0.9	
Microclimate (k_{mc})	1.1-1.4	1.0	0.5-0.9	

Source: [Water Use Classifications of Landscape Species](#) (WUCOLS, University of California and Department of Water Resources, 2000)

Table X.4 provides recommended composite landscape coefficients that are appropriate for planning purposes and feasibility screening.

Table X.4: Planning Level Recommendations for Landscape Coefficient (K_L)

General Landscape Type	Recommended Planning Level Landscape Coefficient (K _L)
Conservation Landscape Design (non-active turf)	K _L = 0.35
Active Turf Areas	K _L = 0.7

X.2.5.3. Planning Level Irrigation Demands

Using the inputs above, daily average wet season demands were developed for an acre of irrigated area based on location and landscape type (Table X.5). These demand estimates can be used to calculate the drawdown of harvest and use systems for the purpose of LID BMP sizing calculations ([Appendix I](#)).

Table X.5: Modified EWUA Daily Average Irrigation Demand by Location and Landscape Coefficient

General Landscape Type	Daily Average Modified EWUA (gpd per irrigated acre)		
	Irvine	Santa Ana	Laguna
Conservation Landscape Design (non-active turf): K _L = 0.35	740	720	680
Active Turf Areas: K _L = 0.7	1,480	1,450	1,360

X.2.6. EIATA Demand Calculation and Sizing Method

The TGD also supports an alternative approach for quantifying harvested water demand that relies on the Effective Irrigated Area to Tributary Area (EIATA) ratio as a tool for sizing stormwater harvest and use systems. This ratio was developed to be a primary indicator of the ability of a harvest and use system to effectively capture and manage stormwater.

The EIATA ratio is calculated as follows:

$$EIATA = LA \times K_L / [IE \times \text{Tributary Impervious Area}]$$

Where:

EIATA = effective irrigated area to tributary area ratio (ac/ac)

LA = landscape area irrigated with harvested water, sq-ft

K_L = Area-weighted landscape coefficient (per guidance above)

IE = irrigation efficiency (assume 0.90)

The calculated EIATA ratio can be used in [Figure X.1](#) to relate DCV to system performance. [Figure X.1](#) was developed in USEPA SWMM5.0 with 22 years of hourly precipitation and reference ET data from the Irvine CIMIS gage. The model accounts for short term suspension of irrigation demand following storm events by applying irrigation only after 0.25 inches of reference ET had occurred since the end of rainfall. This nomograph is applicable across Orange County.

Instructions for using this nomograph are contained in ([Appendix I](#)).

Figure X.1: Harvest and Use Sizing Nomograph

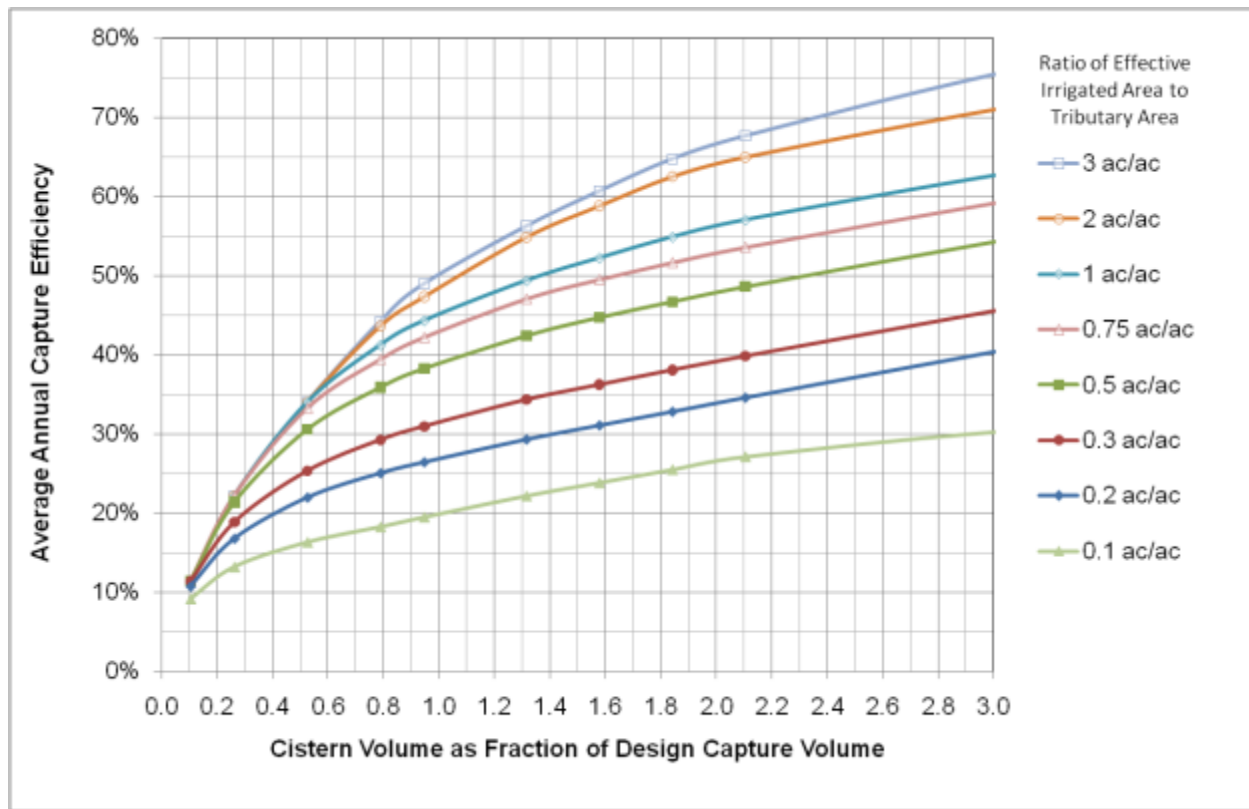

X.2.7. Calculating Other Harvested Water Demands

Calculations of other harvested water demands should be based on the knowledge of land uses, industrial processes, and other factors that are project-specific. Demand should be calculated based on the following guidelines:

- Demand calculations should represent actual demand that is anticipated during the wet season (November through April).

- Sources of demand should only be included if they are reliably and consistently present during the wet season.
- Where demands are substantial but irregular, a more detailed analysis should be conducted based on a statistical analysis of anticipated demand and precipitation patterns.

X.2.8. Reclaimed Water Priority in Demand Calculations

If reclaimed water is available to meet or partially meet project non-potable water demands, the decision to use reclaimed water or harvested runoff water rests with the project proponent. If the project proponent elects to use reclaimed water or is required to use reclaimed water based on conditions placed on the project, then the demand for harvested water should be reduced by the amount of reclaimed water available. This criterion effectively allows the project proponent to consider harvest and use to be infeasible if sufficient reclaimed water supply is available to meet the project demand for harvested water.

This criterion intentionally prioritizes the use of reclaimed water over harvested water in cases where demand overlaps. The use of reclaimed water is being prioritized based upon the following considerations:

- In Order 2009-06, the State Water Board finds that "...recycled water is safe for approved uses, and strongly supports recycled water as a safe alternative to potable water for such approved uses." There are several other state mandates for reduction of potable water demand.
- A substantial investment has been made in the production and distribution of reclaimed water by local agencies to reduce potable water demand to meet state mandates.
- Utilizing reclaimed water where available inherently reduces the amount of treated municipal effluent discharged to the ocean. For those entities that rely primarily on use of reclaimed water for disposal of treated wastewaters, such as the Irvine Ranch Water District, prioritizing use of runoff over reclaimed water could increase wastewater discharges significantly during wet weather periods.
- Utilizing the capacity of the reclaimed water system, where available, has a significantly larger benefit for offsetting potable water supply than stormwater harvest and use systems. Reclaimed water is available year round therefore can effectively fulfill all project non-potable water demands. In contrast, a harvested water system designed for stormwater management would tend to make water available for a relatively minor fraction of the year (during storm events and for a relatively short period after), thereby meeting a substantially lower fraction of the project non-potable water demand.
- It is possible to engineer and deploy a combined reclaimed water/harvested stormwater non-potable use system. However, the costs of including both options would be much higher than employing one or the other. In addition, the most difficult time for

reclaimed water disposal is during extended wet periods (irrigation reduced and more wastewater from inflow and infiltration).

- The use of reclaimed water to supplant the use of harvested water for irrigation could contribute to groundwater quality impacts. This depends on the quality of harvested runoff that might alternatively be used compared to the quality of the reclaimed water. However, the maximum potential fraction of the total inflow to the groundwater basin influenced by the priority for reclaimed water versus harvested water is believed to be very minor based on the applicability of the New Development and Significant Redevelopment LID requirements in the foreseeable future and will therefore not have a significant impact on groundwater quality.
- In addition, potential impacts to groundwater quality related to use of reclaimed water, particularly salt and nutrient accumulation, must be evaluated and managed by providers of reclaimed water¹⁷. The priority for use of reclaimed water expressed in this TGD does not conflict or interfere with the obligation of reclaimed water providers to manage the application of reclaimed water. If, as a groundwater quality management action, a reclaimed water provider must limit the application of reclaimed water, it would be the responsibility of the reclaimed water provider to limit the amount of reclaimed water that is made available to a proposed project and/or limit its allowable uses on a project. This would limit the amount of project demand that can be offset by reclaimed water and would thereby require harvested water to be considered in applicable scenarios.
- Finally, it is noted that the State Board has evaluated, in general, the potential negative environmental consequences of reclaimed water on groundwater quality as part of developing its policy on reclaimed water, and the State Board supports the use of reclaimed water for landscape irrigation.

X.3. Planning Level Harvest and Use Feasibility Thresholds

This section describes the technical analysis and assumptions that were used to develop planning level feasibility thresholds for harvest and use systems. The intent of these thresholds is to identify projects with low potential for successful harvest and use and provide a means for applicants to readily demonstrate infeasibility of harvest and use, where clearly infeasible, without the need for a detailed project specific analysis.

X.3.1. Minimum Partial Capture Threshold

If a harvest and use system is designed with storage volume equal to the DCV from the tributary area but still achieves less than 40 percent capture, the system does not meet the

¹⁷ In Water Quality Order No. 2000-07, the State Water Board determined that a Producer (i.e., reclaimed water purveyor) cannot shift responsibility for discharged salt to the User (i.e., project proponent).

minimum incremental benefit required to mandate its use (See discussion of threshold incremental benefit in [Appendix XIII](#)). This level of performance is termed the “minimum partial capture.” A harvest and use system would be considered to achieve less than “minimum partial capture” if:

- Based on a system sized for the full DCV from the tributary area, and
- Based on the combined project demand for harvested water,
- The system draws down in greater than 30 days (720 hours), therefore captures less than 40 percent of average annual runoff (See Figure III.2).

Harvest and use systems with demand lower than required to achieve minimum partial capture are not required to be considered to demonstrate retention of stormwater to the MEP. If this is the case, other LID BMPs must be evaluated for retention and/or biotreatment of the Project DCV.

X.3.2. Demand Thresholds for Minimum Partial Capture

Table X.6 provides the minimum combined project demand to meet the minimum partial capture for the range of precipitation zones found in Orange County. Projects with a total demand below this value not required to prepare a project specific evaluation of harvest and use feasibility.

Table X.6: Harvested Water Demand Thresholds for Minimum Partial Capture

Design Capture Storm Depth¹, inches	Wet Season Demand Required for Minimum Partial Capture², gpd per impervious acre
0.60	490
0.65	530
0.70	570
0.75	610
0.80	650
0.85	690
0.90	730
0.95	770
1.00	810

1 - Based on isopluvial map (See [XVI.1](#))

2 -Minimum Partial Capture is a performance standard whereby system performance exceeds 40 percent capture (See [Appendix XIII](#)) , such that the system must be considered for use even if it cannot achieve the full DCV.

X.3.3. TUTIA Ratio Thresholds for Minimum Partial Capture

Table X.7 provides thresholds for TUTIA (Toilet Users to Impervious Area) ratio required to achieve minimum partial capture of the stormwater DCV (i.e. at least 40 percent average annual capture efficiency with a system sized for the DCV). Projects with TUTIA ratios below this value and without other significant demands for harvested water are not required to prepare a project specific evaluation of harvest and use feasibility. The values in Table X.7 reflect the minimum TUTIA ratio required to achieve at least 40 percent average annual capture efficiency with a system sized for the DCV.

Table X.7: Minimum TUTIA for Minimum Partial Capture

Project Type	Residential	Retail and Office Commercial	Industrial	Schools ¹
<i>Basis of Toilet User Calculation</i>	<i>Resident</i>	<i>Employee (non-visitor)</i>	<i>Employee (non-visitor)</i>	<i>Employee (non-student)</i>
Design Capture Storm Depth, inches	Minimum TUTIA Ratio Required for Minimum Partial Capture (toilet users/impervious acre)			
0.6	74	98	125	21
0.65	80	106	135	23
0.7	86	114	145	24
0.75	92	122	155	26
0.8	98	130	165	28
0.85	104	138	176	30
0.9	110	146	186	31
0.95	117	154	196	33
1	123	162	206	35

1 - based on employees only; assumes approximately 5 students per employee.

X.3.4. Irrigated Area Thresholds for Minimum Partial Capture

Table X.8 provides thresholds for irrigated area per impervious acre for minimum partial capture of the stormwater DCV. Projects with irrigation area below this value and without other sources of significant demand will generally not be required to prepare a project specific evaluation of harvest and use feasibility. The values in Table X.8 reflect the minimum irrigated area per impervious area required to achieve at least 40 percent average annual capture efficiency with a system sized for the DCV.

Table X.8: Minimum Irrigated Area for Potential Partial Capture Feasibility

General Landscape Type	Conservation Design: $K_L = 0.35$			Active Turf Areas: $K_L = 0.7$		
	<i>Closest ET Station</i>	<i>Irvine</i>	<i>Santa Ana</i>	<i>Laguna</i>	<i>Irvine</i>	<i>Santa Ana</i>
Design Capture Storm Depth, inches	Minimum Required Irrigated Area per Tributary Impervious Acre for Potential Partial Capture, ac/ac					
0.60	0.66	0.68	0.72	0.33	0.34	0.36
0.65	0.72	0.73	0.78	0.36	0.37	0.39
0.70	0.77	0.79	0.84	0.39	0.39	0.42
0.75	0.83	0.84	0.90	0.41	0.42	0.45
0.80	0.88	0.90	0.96	0.44	0.45	0.48
0.85	0.93	0.95	1.02	0.47	0.48	0.51
0.90	0.99	1.01	1.08	0.49	0.51	0.54
0.95	1.04	1.07	1.14	0.52	0.53	0.57
1.00	1.10	1.12	1.20	0.55	0.56	0.60

Worksheet J: Summary of Harvested Water Demand and Feasibility

1	What demands for harvested water exist in the tributary area (check all that apply):		
2	Toilet and urinal flushing		<input type="checkbox"/>
3	Landscape irrigation		<input type="checkbox"/>
4	Other: _____		<input type="checkbox"/>
5	What is the design capture storm depth? (Figure III.1)	d	inches
6	What is the project size?	A	ac
7	What is the acreage of impervious area?	IA	ac
For projects with both toilet flushing and indoor demand			
8	What is the minimum use required for partial capture? (Table X.6)		gpd
9	What is the project estimated minimum wet season total daily use?		gpd
10	Is partial capture potentially feasible? (Line 9 > Line 8?)		
For projects with only toilet flushing demand			
11	What is the minimum TUTIA for partial capture? (Table X.7)		
12	What is the project estimated TUTIA?		

Worksheet J: Summary of Harvested Water Demand and Feasibility

13	Is partial capture potentially feasible? (Line 12 > Line 11?)		
For projects with only irrigation demand			
14	What is the minimum irrigation area required based on conservation landscape design? (Table X.8)		ac
15	What is the proposed project irrigated area? (multiply conservation landscaping by 1; multiply active turf by 2)		ac
16	Is partial capture potentially feasible? (Line 15 > Line 14?)		
Provide supporting assumptions and citations for controlling demand calculation:			

APPENDIX XI. CRITERIA FOR DESIGNING BMPS TO ACHIEVE MAXIMUM FEASIBLE RETENTION AND BIOTREATMENT

XI.1. Purpose and Intended Use

The purposes of this appendix are two-fold:

- 1) To provide guidance for designing biotreatment BMPs to achieve the maximum feasible Infiltration and ET. Where biotreatment BMPs are used, they must be designed to achieve this objective.
- 2) To provide guidance for designing BMPs to retain and biotreat stormwater to the maximum extent practicable (MEP) for sites that cannot fully retain or biotreat the DCV. Retention must be used to the MEP before biotreatment is used.

This section includes:

- Criteria for designing biotreatment BMPs to achieve maximum feasible infiltration and ET
- Criteria for designing BMPs to achieve maximum feasible retention of the stormwater design volume
- Criteria for designing BMPs to achieve maximum feasible retention plus biotreatment of the stormwater design volume
- Supporting criteria for designing BMPs to achieved maximum feasible retention plus biotreatment of the stormwater design volume

This Appendix is intended to be applied as referenced from the BMP selection and design process described in [TGD Section 2.4](#).

XI.2. Criteria for Designing Biotreatment BMPs to Achieve Maximum Feasible Infiltration and ET

Infiltration and ET are volume reduction processes that occur in biotreatment BMPs, but they are not the principal treatment mechanism. However, these incidental processes must be promoted whenever biotreatment BMPs are designed for a project. This section is intended to be used design biotreatment to BMPs to result in maximum feasible infiltration and ET in cases where neither infiltration nor harvest and use are feasible based on infiltration feasibility criteria contained in [TGD Section 2.4.2.4](#), or where infiltration BMPs and/or harvest and use BMPs are partially feasible and biotreatment BMPs must be used for the remaining design volume.

Evapotranspiration. To design biotreatment BMPs to achieve maximum feasible ET, BMPs shall be designed with amended soils consistent with Biotreatment Selection, Design, and Maintenance Requirements contained in [Appendix XII](#).

Infiltration. To design biotreatment BMPs to achieve the maximum feasible infiltration, retention volume shall be provided below the lowest surface discharge point. The amount of retention volume that shall be provided depends on the infiltration rate of the soil. This practice shall not be used where there is substantial evidence that infiltration would pose an unmitigated risk per the infiltration feasibility criteria contained in [TGD Section 2.4.2.4](#).

In cases where incidental infiltration passes the infeasibility criteria in [TGD Section 2.4.2.4](#), the criteria for designing biotreatment BMPs to achieve the maximum feasible infiltration are as follows.

XI.2.1. BMPs with Underdrains

Retention volume shall be provided below the underdrains of the BMP per the following criteria:

- A gravel storage layer shall be installed below the invert elevation of the underdrains, as applicable.
- Rock should be assumed to have a porosity of 0.4 unless otherwise supported, and
- The depth of rock should be selected so that the underdrain layer empties in 48 hours.
- Where the infiltration rate of the underlying soil is not known, a rate of 0.1 in/hr shall be assumed, resulting in a gravel depth of 12 inches.

Example:

- Soil has a *measured infiltration rate* of 0.15 inches per hour and risk-based factors do not apply.
- Depth that can be infiltrated in 48 hours = 0.15 in/hr × 48 hours = 7.2 inches
- Depth of gravel to provide this depth of water = 7.2 inches / 0.4 = 18 inches.

XI.2.2. Swales and Filter Strips without Underdrains

Retention volume shall be provided below the lowest surface discharge of the BMP per the following criteria:

- Check dams and outlet controls shall be installed, as applicable, to retain water on the surface and amended soil.
- The storage depth shall be selected to drain in 24 hours.
- Where the infiltration rate of the underlying soil is not known, a surface ponding depth of 2 inches shall be used.
- Soils shall be amended to promote infiltration consistent with Biotreatment Selection, Design, and Maintenance Requirements contained in [Appendix XII](#).

Example:

- Underlying has an estimated infiltration rate of 0.1 inches per hour (with soil amendments considered) and risk-based factors do not apply.
- Depth that can be infiltrated in 24 hours = 0.1 in/hr × 24 hours = 2.4 inches.

XI.2.3. Dry Extended Detention Basins

Soils shall be amended to promote subsurface storage and infiltration consistent with Biotreatment Selection, Design, and Maintenance Requirements contained in [Appendix XII](#).

XI.2.4. Wet Ponds and Constructed Wetlands

Wet ponds and constructed wetlands achieve high pollutant removal efficiency, in part, by maintaining a permanent pool. These BMPs should not be designed to achieve volume reduction as a primary goal; however some incidental volume reduction is expected to occur.

XI.3. Criteria for Designing BMPs to Achieve Maximum Feasible Retention of the Stormwater Design Volume

The requirements of this section are intended to apply when the entire DCV cannot be feasibly retained, but retention of the stormwater design volume is potentially feasible per the infeasibility criteria contained in [TGD Section 2.4.2.4](#). BMPs shall be designed to retain the stormwater design volume to the MEP by demonstrating that the applicable criteria in the following subsections are met.

XI.3.1. General Criteria

If at any time in this process, the stormwater design volume can be retained and drawn down in less than or equal to 48 hours, or the BMP is demonstrated to retain 80 percent of average annual stormwater runoff (per methods contained in [Appendix III.3.2](#)) and HCOCs are addressed (per methods contained in [Appendix IV](#) (North Orange County permit area) or [Appendix V](#) (South Orange County permit area)), the system does not need to be sized to manage any additional stormwater volume.

If after meeting the criteria contained in the following subsections, it is demonstrated that the resulting design would retain less 40 percent of average annual runoff volume on a drainage area basis, the BMP is not required to be used to demonstrate that BMPs have been designed to retain the design volume to the MEP. Instead, a biotreatment BMP must be used to the MEP and must be designed to provide maximum feasible infiltration and ET. See [Appendix XIII](#) for the technical basis of the 40 percent capture threshold criterion.

XI.3.2. Infiltration BMPs

This section provides criteria that shall be met to demonstrate that infiltration BMPs have been designed to retain stormwater design volume to the MEP.

- All applicable HSCs shall be provided except where they are mutually exclusive with each other or with LID BMPs. Mutual exclusivity may result from overlapping BMP footprints such that either would be potentially feasible by itself, but both could not be implemented; and
- Site design allowances for infiltration BMPs shall meet or exceed minimum site design criteria (See Section [XI.5.1](#) for criteria) , and
- Using the infiltration area that meets the minimum site design criteria (Section [XI.5.1](#)), and using a design infiltration that meets the minimum criteria for feasibility evaluation (See Section [XI.5.2](#)), BMP retention depth has been selected such that:
 - The combined storage volume provided by HSCs and retention BMPs equals or exceeds the stormwater design volume, or
 - Retention depth provided in BMPs (volume contained below lowest design discharge elevation) equals or exceeds the depth that would draw down in 48 hours based on the design infiltration rate. (For example: if the design infiltration rate is 0.25 inches per hour, this criterion would be met by providing at least 12 inches of retention storage [0.5 in/hr × 48 hr]). Intent: The depth corresponding to 48-hr drawdown represents the point of diminishing returns with respect to additional volume for additional capture efficiency, or
 - Deeper depth may be provided, however additional volume would be required to compensate for longer drawdown time ([Appendix III.3.2](#)). Surface drawdown shall not exceed 96 hours because of vector issues. Drawdown time of subsurface storage may exceed 96 hours, however consideration should be given to maintenance activities and plant survival, as applicable, in selecting a maximum subsurface drawdown time.

XI.3.3. Harvest and Use BMPs

This section provides criteria that shall be met to demonstrate that harvest and use BMPs have been designed to retain stormwater design volume to the MEP.

- All applicable HSCs ([Appendix XIV.1](#)) shall be provided except where they are mutually exclusive. Mutual exclusivity may result from overlapping BMP footprints such that either would be potentially feasible by itself, but both could not be implemented, and
- The combined storage volume provided in HSCs and harvest and use BMP(s) equals or exceeds the DCV, and
- All applicable demand for harvested water has been considered per criteria contained in [Appendix X](#).

XI.4. Criteria for Designing BMPs to Result in Maximum Feasible Retention plus Biotreatment of the Stormwater Design Volume

The requirements of this section are intended to apply when the entire stormwater design volume cannot be feasibly retained, and therefore biotreatment BMPs must be added to the system to manage the remaining stormwater design volume to the MEP. Adding biotreatment BMPs to a system that has already been designed for the maximum feasible retention may

necessarily require some retention volume to be converted to biotreatment volume to result in a design that achieves the highest combined pollutant load reduction. This section is intended to be used after the maximum feasible retention volume has been calculated.

The following criteria that shall be met to demonstrate that biotreatment BMPs have been designed to retain stormwater design volume to the MEP

- Biotreatment components shall be added to treat runoff from a project's drainage area without reducing retention such that combined, biotreatment and retention BMPs capture and manage 80 percent of average annual runoff (See approaches for sizing of treatment trains and multi-part systems in [Appendix III.5](#)),

OR

- A combination BMP or multi-part BMP incorporating both retention and biotreatment volume shall be provided that capture and manages (retains plus biotreats) at least 80 percent of average annual runoff, and no more than half of the maximum feasible retention volume computed in Section [XI.3](#) has been shifted to biotreatment.

Any stormwater design volume that remains after meeting these criteria shall be considered infeasible to retain or biotreat on-site and alternative compliance obligations shall be computed as described in [Appendix VI](#).

XI.5. Supporting Criteria for Designing BMPs to Achieve Maximum Feasible Retention and Biotreatment

This section provides criteria to support the design of BMPs to retain and biotreat the stormwater design volume to the MEP. The requirements of this section are intended to apply only to projects demonstrating that BMPs have been designed to achieve the maximum retention and biotreatment per Sections [XI.3](#) and [XI.4](#), respectively, as referenced from these sections.

XI.5.1. Criteria for Site Design to Allow BMPs

Project site designs shall be developed to allow BMPs to the MEP per the criteria contained in this section. This section is applicable as referenced from Sections [XI.3](#) and [XI.4](#).

- At least the recommended portion of the site specified [Table XI.1](#) (or a more stringent table developed by local jurisdictions) shall be provided in the site plans for surface plus subsurface BMPs. Local jurisdictions may develop a more stringent table (i.e., greater area required to be provided) at their discretion. In the absence of such a table, [Table XI.1](#) shall be the default; and
- The site shall be configured such that runoff can be routed to BMPs located in the available area(s) of the site; and
- The site shall be laid out such that BMPs are located over infiltrative soils as practicable given the constraints of the site, unless infiltration is infeasible for risk-based reasons identified in [TGD Section 2.4.2.4](#), and

- Satisfaction of these criteria shall be documented in exhibits or narrative descriptions.

OR

- A site specific study shall be prepared as part of the Project WQMP that documents that the site cannot be designed to allow more area for BMPs. The study may consider:
 - Site conditions/constraints (e.g., depth to groundwater, topography, existing utilities)
 - Zoning/code requirements (e.g., target density, accessibility, traffic circulation, health and safety, setbacks, etc.)
 - Economic feasibility

Table XI.1 provides the recommended percentage of a project site that is required to be made available for LID BMPs in order to meet minimum criteria for site design to allow BMPs.

Table XI.1: Recommended Minimum Criteria for Site Design

Project Type		Recommended effective area ¹ required to be made available for LID BMPs (surface + subsurface facilities) to meet site design criteria ² (percent of site)
New Development	SF/MF Residential < 7 du/ac	10
	SF/MF Residential 7 – 18 du/ac	7
	SF/MF Residential > 18 du/ac	5
	Mixed Use, Commercial, Institutional/Industrial w/ FAR < 1.0	10
	Mixed Use, Commercial, Institutional/Industrial w/ FAR 1.0 – 2.0	7
	Mixed Use, Commercial, Institutional/Industrial w/ FAR > 2.0	5
	Podium (parking under > 75% of project)	3
	Projects with zoning allowing development to lot lines	2
	Transit Oriented Development ³	5
	Parking	5

Table XI.1: Recommended Minimum Criteria for Site Design

	Project Type	Recommended effective area ¹ required to be made available for LID BMPs (surface + subsurface facilities) to meet site design criteria ² (percent of site)
Redevelopment	SF/MF Residential < 7 du/ac	5
	SF/MF Residential 7 – 18 du/ac	4
	SF/MF Residential > 18 du/ac	3
	Mixed Use, Commercial, Institutional/Industrial w/ FAR < 1.0	5
	Mixed Use, Commercial, Institutional/Industrial w/ FAR 1.0 – 2.0	4
	Mixed Use, Commercial, Institutional/Industrial w/ FAR > 2.0	3
	Podium (parking under > 75% of project)	2
	Projects with zoning allowing development to lot lines	1
	Transit Oriented Development ³	3
	Projects in Historic Districts	3

¹ “Effective area” is defined as area which 1) is suitable for a BMP (for example, if infiltration is potentially feasible for the site based on infeasibility criteria, infiltration must be allowed over this area) and 2) receives runoff from impervious areas.

²Criteria for site design are only required to be met if the Project WQMP seeks to demonstrate that the full stormwater design volume cannot be feasibly managed on-site.

³ Transit oriented development is defined as a development with development center within one half mile of a mass transit center.

Key: du/ac = dwelling units per acre, FAR = Floor Area Ratio = ratio of gross floor area of building to gross lot area
MF = Multi Family, SF = Single Family

The table is intended to be used in the feasibility process as follows:

- If a project seeks to demonstrate that it is not feasible to manage the entire design stormwater volume on-site, it is necessary to demonstrate that minimum criteria for site design have been met as part of making this determination by comparing the effective area provided for LID BMPs within the drainage are to the values in [Table XI.1](#).
- If the percentage of the site recommended in [Table XI.1](#) is provided and LID BMPs still does not achieve the stormwater design volume, then this allows for remaining volume to be met through alternative compliance. If the percentage of the site [Table XI.1](#) is not provided for LID BMPs and the stormwater design volume is not managed, this provides grounds for a reviewer to request that additional area be made available for BMPs in the site design until either the percentage of the site in [Table XI.1](#) is provided or the entire stormwater design volume is managed.
- The project may provide more area for LID BMPs if desired.

Local jurisdictions may choose to develop analogous tables more stringent (i.e., higher areas required to be provided) than [Table XI.1](#). Projects that employ LID BMPs to retain the full stormwater design volume (as documented by the Project WQMP) are not required to demonstrate that they meet criteria for site design.

XI.5.2. Criteria for Selecting Design Infiltration Rate for Feasibility Evaluation

Infiltration factor of safety shall be selected based on criteria contained in [Appendix VII.4](#), and shall not be less than 2.0 under any condition. The designer may provide a higher factor of safety in the design of BMPs as warranted by project-specific factors described in [Appendix VII.4](#). For the purpose of designing BMPs to achieve the maximum feasible retention plus biotreatment, the acceptable factor of safety should be minimized through a commitment to thorough site investigation, use of effective pretreatment controls, good construction practices, the commitment to restore the infiltration rates of soils that are damaged by prior uses or construction practices, and the commitment to effective maintenance practices. In most cases, it is believed that a factor of safety of 2.0 is attainable with these commitments; however this does not remove the responsibility of the designer to apply a prudent factor of safety based on project-specific considerations.

XI.5.3. Criteria for Identifying All Possible Harvested Water Demands

The intent of this section is to provide criteria for identifying all possible demands for harvested water. The following criteria shall be met to demonstrate that all potential demands for harvested water have been considered:

- Potential demands for harvested water shall include all *consistent and reliable demands for non-potable water*, as defined below, that do not conflict with codes or ordinances in place at the time of Project WQMP submittal and do not conflict with prior water rights claims,
- *Consistent and reliable demands for non-potable water* shall include those demands identified in [Appendix IX](#) and any other non-potable demands meeting the general criteria of [Appendix IX](#):
 - Irrigation water demand, as estimated via methods described in [Appendix IX](#) or an equivalent method as approved by the local jurisdiction.
 - Indoor toilet flushing demand, as estimated via methods described in [Appendix IX](#) or an equivalent method as approved by the local jurisdiction. Occupancy estimates shall be based on the lowest forecasted average annual occupancy beyond 2 years of completion.
 - Industrial process water demand, vehicle wash water, evaporative cooling water, and other non-potable uses based on the criteria for calculating harvested water demand contained in [Appendix IX](#), for processes not anticipated to change in the foreseeable future. For building uses anticipated to change, a good faith estimate of the minimum typical wet season harvested water demand shall be used to evaluate the feasibility of harvest and use systems.

- Reclaimed water supply shall be evaluated on a project-specific basis and subtracted from harvested water demands; in the absence of project-specific conditions of approval, reclaimed water available to the project shall take priority over use of harvested stormwater and should reduce the demand for harvested water by the amount of reclaimed water available. The basis for this priority is provided in **Appendix X.2.8**.

APPENDIX XII. CONCEPTUAL BIOTREATMENT SELECTION, DESIGN, AND MAINTENANCE CRITERIA

The purpose of this Appendix is to provide conceptual-level guidance for selection, design, and maintenance of biotreatment BMPs. This Appendix is intended to be used as a concise reference for the biotreatment BMP design philosophy.

This Appendix is not intended to provide BMP-specific guidance or design-level specifications. BMP-specific guidance for the recognized suite of available biotreatment BMPs is provided in BMP Fact Sheets in [Appendix XIV](#).

This Appendix is not intended to be use for specific criteria. Detailed and prescriptive guidance for sizing and designing biotreatment to achieve the maximum feasible infiltration and ET is provided in [Appendix XI](#).

XII.1. Definition of Biotreatment BMPs

Biotreatment BMPs are a broad class of structural LID BMPs that treat stormwater using a suite of treatment mechanisms characteristic of biologically active systems. The design of biotreatment BMPs should strive to achieve the following goals, as applicable:

- Foremost, the BMP should be designed to provide the highest possible pollutant removal, with emphasis on removal of pollutants of concern.
- The BMP should be aesthetically pleasing.
- The BMP should provide multiple benefits such as aesthetic enjoyment, wildlife habitat, open space, and/or support recreational use (i.e. be an element of a trail system);
- The BMP should include educational signage for visitors if appropriate; that
- Ancillary elements (fencing, gates, and access roads) should serve to mitigate risks (i.e. drowning, vandalism) and minimize costs of maintenance.

Biotreatment BMPs provide a variety of treatment mechanisms to remove both suspended and dissolved pollutants in urban storm water runoff. All biotreatment BMPs include treatment mechanisms that employ soil microbes and plants. Biotreatment BMPs may be either flow-based (limited storage) or volume-based (storage a key design component) and are designed to treat and discharge urban stormwater runoff to a downstream conveyance system. Biotreatment BMPs can be designed to promote infiltration and ET even though they are treat-and-release BMPs. Systems not designed primarily to infiltrate or evapotranspire stormwater may still reduce the volume of stormwater via infiltration and ET. If necessary to mitigate risks to

structures, human health, or other concerns, a biotreatment BMP may also be lined to prevent infiltration of urban storm water runoff into the underlying soils.

Operations and maintenance of biotreatment BMPs should emphasize preservation of hydraulic function and the promotion of robust biological processes. Biotreatment BMPs typically utilize “soft” infrastructure (e.g., vegetative slope stabilization as opposed to rip rap slope stabilization) and therefore require an adaptive approach to maintenance and performance enhancement, more typical of landscape maintenance than maintenance of hard infrastructure.

Note that while biotreatment BMPs may provide habitat value, plant growth may damage infrastructure elements in the facility such as fencing, curbs, etc. This hazard can be mitigated by incorporating root barriers or through regular maintenance.

The following sections provide principles that should govern the design, operation, and maintenance of biotreatment BMPs installed to meet permit requirements in Orange County.

XII.2. Biotreatment Selection to Address Pollutants of Concern

Biotreatment BMPs shall be selected that provide unit operations and processes (UOPs) that address the project pollutants of concern. The process of biotreatment BMP selection shall consist of the steps described in [TGD Section 2.4.2.5](#).

XII.3. Conceptual Biotreatment Design Requirements

Biotreatment design requirements shall be consistent with the following principles:

- **Biotreatment BMPs shall be sized according to permit requirements described in the Section 2.4 of the [Model WQMP](#).**
- **Biotreatment BMPs shall incorporate unit processes to address pollutants of concern. See [TGD Section 2.4.2.5](#) for guidance.**
- **Biotreatment BMPs shall be designed to achieve the maximum feasible infiltration and ET by adhering to the criteria described in [Appendix XI](#).**
- **Biotreatment BMPs shall be designed per the published design standards contained in the BMP Fact Sheets ([Appendix XIV.5](#)) and the design manuals referenced by these Fact Sheets.**
- **Biotreatment BMPs shall support a robust vegetative and microbial community appropriate to the local climate:**
 - For bioretention systems¹⁸, select vegetation that is drought tolerant and can also survive extended periods of saturated soils.

¹⁸ The use of the term “bioretention systems” in this appendix refers to bioretention with underdrains, rain gardens with underdrains, planter boxes with underdrains, curb-extension planter boxes with underdrains, proprietary bioretention systems, and other similar BMPs.

- For constructed stormwater wetlands and wet detention basins (wet ponds), select native species that include significant rhizomes and provide habitat benefits.
- For constructed stormwater wetlands and wet detention basins (wet ponds) provide appropriate mix of open water to vegetated area. The appropriate mix depends on the primary target constituents. For example, where nitrate is the dominant nutrient, the appropriate mix would include a higher proportion of vegetated area such as 80% vegetated, 20% open water.
- For dry extended vegetated detention basins, vegetated swales, and filter strips, select a variety of plant species that are drought tolerant, but can also survive periodic inundation.
- Provide an irrigation system, if necessary, for plant establishment and maintenance.
- **Biotreatment BMPs shall incorporate amended media and soils designed for the intended function of the BMP.**
 - Select amended media for use in bioretention systems that is effective at removing pollutants of concern, can absorb and evapotranspire runoff, and where appropriate, can facilitate infiltration.
 - Select media and soils that will not potentially leach pollutants, specifically dissolved nutrients and metals in some cases.
 - Amend soils in dry extended detention basins, swales, and filter strips to provide suitable soils for supporting plants, which can absorb and evapotranspire runoff and where appropriate facilitate infiltration.
 - Design wet detention basins (wet ponds) and constructed stormwater wetlands using soils that support growth of attached plants.
- **BMPs hydraulics shall be designed to maximize pollutant removal functions.**
 - For all biotreatment BMPs, design inlets or overland flow entry to BMPs to prevent scour or re-entrainment of pollutants.
 - Provide maximum flow path distance between outlet and inlet and with sufficient length to width ratio to limit short circuiting.
 - For constructed stormwater wetlands and wet detention basins, provide the storage capacity for the DCV in the wet pool at a minimum.
 - Seasonal constructed stormwater wetlands and seasonal wet detention basins should not be used unless there is a reasonable expectation that tributary land uses will provide dry weather flows during seasonally wet period to maintain vegetation and prevent stagnant water.
 - For constructed stormwater wetlands and wet detention basins designed to be continually wet (opportunities may be limited in Orange County), ensure that a low-flow source of water is present to maintain vegetation and prevent stagnant conditions.
 - Design features shall allow for monitoring of drawdown such as depth markers and monitoring ports.

- For bioretention systems, provide media contact time sufficient for pollutant removal, with upper limitations on contact time to avoid leaching of retained pollutants. Traditional media should generally be designed in the range of 2 to 12 inches per hour, while specialized media can be effective for many pollutants of concern at much higher flowrates (residence times on the order of several minutes). For bioretention systems, design media mix and layer separation systems (i.e. between media and gravel layers) to reduce potential for clogging.
- For bioretention systems that include infiltration as a component, design a gravel pool below the underdrains (where used; ensure that the soils below this area can infiltrate (i.e., do not compact, or if compacted, restore soil infiltration capacity)). The minimum depth of gravel pool should be determined based on the underlying infiltration based on the amount of water that will infiltrate in 48 hours (see [Appendix XI.2](#))
- For bioretention systems that will include infiltration as a component, the soil below the gravel pool must be able to allow infiltration. The soil may not be compacted. If the soil is compacted, the soil infiltration capacity must be restored.
- Consider using hydraulic control on the outlet of bioretention systems whenever practical rather than using media with lower infiltration rates for hydraulic control. This practice aids in avoiding clogging and can improve uniformity of performance over the life of the facility.
- For bioretention systems, do not use geotextile fabrics between layers of media due to clogging issues; use progressively-graded aggregate layers to prevent migration of fines if necessary.
- For bioretention systems limit ponding depths to 12 inches, unless system is isolated from public access via fencing or equivalent, then ponding depths should be limited to 18 inches.
- Bioretention systems and dry extended detention basins shall be designed to limit surface ponding to less than 96 hours for vector control per [California Department of Health Guidelines](#). To provide a margin of safety, bioretention systems and extended detention basins should be designed to limit surface ponding to 72 hours. Subsurface ponding (in stone or gravel trenches) can create a vector hazard if the media has pore spaces that vectors can breed in.
- For biotreatment BMPs that employ extended detention, design outlet structures to ensure appropriate drawdown times and patterns and prevent floatables from leaving the facility; ensure that small storms receive appropriate extended detention times. A common rule of thumb is that the bottom half of the facility volume should draw down in two thirds of the total drawdown time.
- Outlet structures should be located and designed so that they are accessible for inspection and maintenance.
- For vegetated swales and filter strips, provide level spreaders and check dams where appropriate to promote even distribution of flow across the system.

- Design systems such that flows above the BMP design intensity are provided a flow route that bypasses the BMP or can be passed through the BMP without entraining soils, media, or captured pollutants.
- **Biotreatment BMPs shall be subject to rigorous construction oversight, acceptance, and documentation process.**
 - Provide construction oversight by trained professionals to ensure that the BMP is installed as designed.
 - Consider conducting a flow test for bioretention systems to ensure they function at the design level.
 - Require the preparation of as-built drawings that clearly indicated design features of the BMP and inlet and outlet systems.
 - Inspect BMPs after initial commissioning to ensure that they are functioning as intended. More frequent inspection during initial operation periods (i.e., first rainy season) can help to mitigate early problems and ensure design level performance.

XII.4. Conceptual Biotreatment Operation Requirements

An operation and maintenance plan shall be developed for biotreatment BMPs that includes the following elements:

- **Frequency and type of inspections,**
- **Observations during wet weather to visually observe whether the BMP is functioning as intended,**
- **List of parameters/checklists for identifying maintenance needs and triggering maintenance activities,**
- **Vegetation management plan, including routine maintenance, and irrigation, if necessary,**
- **Sediment, trash and debris removal, and**
- **Routine and major (infrequent) maintenance activities.**

Reclaimed water considerations for operation of biotreatment BMPs:

If the project utilizes reclaimed water for irrigation, the project is required to comply with all waste discharge requirements and water provider use requirements applicable to the project. It is the responsibility of the project owner to ensure that operation of the project complies with these requirements. It is the responsibility of the water provider to ensure that requirements associated with the use of reclaimed water result in BMP operations that are protective of receiving water quality.

XII.5. Conceptual Biotreatment Maintenance Requirements

Biotreatment maintenance requirements contained in the Project O&M Plan shall be consistent with the following principles:

- **Routine maintenance shall be provided to ensure consistently high performance and extend facility life.**
 - Maintain vegetation and media to perpetuate a robust vegetative and microbial community (thin/trim vegetation, replace spent media and mulch).
 - Periodically remove dead vegetative biomass to prevent export of nutrients or clogging of the system.
 - Remove accumulated sediment before it significantly interferes with system function.
 - Where filtration/infiltration is employed, conduct maintenance to prevent surface clogging (surface scarring, raking, mulch replacement, etc.).
 - Add energy dissipation and scour-protection as required based on facility inspection.
 - Routinely remove accumulated sediment at the inlet and outlet and trash and debris from the entire BMP.
- **Major maintenance shall be provided when the performance of the facility declines significantly and cannot be restored through routine maintenance.**
 - Replace media / planting soils as triggered by reduction in filtration/infiltration rates or decline in health of biological processes.
 - Provide major sediment removal to restore volumetric capacity of basin-type BMPs.
 - Repair or modify inlets/outlets to restore original function or enhance function based on observations of performance.

Detailed descriptions of BMP maintenance activities are provided in:

- Los Angeles County Stormwater BMP Operations and Maintenance Manual, Chapter 5:
http://dpw.lacounty.gov/DES/design_manuals/StormwaterBMPDesignandMaintenance.pdf

APPENDIX XIII. THRESHOLD INCREMENTAL BENEFIT CRITERION

XIII.1. Intended Application

The purpose of this Criterion is to help ensure that the most effective retention and biotreatment BMPs are selected for use. The Permits require that a design volume be included for retaining stormwater on site (if feasible). As the permit makes no mention of recovering this storage to be able to manage subsequent runoff events, it is possible that one could select a LID retain on site BMP that would be relatively ineffective due to low drawdown rates (for example, insufficient demand for irrigation use of harvested water) and resulting excessive overflows or bypasses of LID systems. This criterion is intended to ensure that harvest and use systems would result in equal or better performance than a biotreatment system which has been designed to maximize infiltration and evapotranspiration as required by this Model WQMP and TGD. This criterion in no way restricts one from including LID features that do not meet this criteria, but in that case the project proponent would need to include additional LID features to meet the overall requirement to retain on site, and if infeasible, biotreat on-site, 80 percent of average annual stormwater runoff volume.

The following criterion is intended to be applied as part of determining the maximum feasible retention volume as part of the BMP selection and design process:

If a hypothetical BMP is designed to achieve the maximum feasible retention per the criteria contained **Appendix XI.3**, and, meeting these criteria, the BMP would achieve less than 40 percent capture of average annual runoff, then it is not mandatory to use the given BMP in order to demonstrate that the system has been designed to achieve the maximum feasible retention of the DCV.

This criterion does not suspend the requirements to (1) consider all applicable HSCs that are designed to provide retention, (2) conduct a rigorous feasibility analysis of all other retention BMPs before moving to biotreatment, and (3) to design biotreatment BMPs, if used, to achieve the maximum feasible infiltration and ET. As a result, the application of this criterion does not result in an “all or nothing” scenario for retention; rather it is intended to provide an objective basis for identifying BMPs for which *costs* (due to resulting multiple BMPs being required would) *greatly outweigh pollution control benefits*. In this case, the criterion allows the project to distribute the DCV to more cost-effective BMPs and still achieve retention with HSCs and biotreatment BMPs.

Based on the analysis described in **Appendix III.6**, a BMP designed for the full DCV will exceed 40 percent capture (and therefore be a mandatory consideration) if the storage can be recovered in 720 hours (30 days) or faster. Therefore this criterion would only apply in extremely limited cases where the DCV cannot be drained in less than 30 days. Generally, it will only apply to harvest and use systems where demand is extremely limited to manage the DCV.

This criterion does not apply to HSC (e.g., downspout disconnection, rain barrels), which are relatively inexpensive compared to engineered harvest and use systems and are commonly designed with the intent of providing relatively small incremental benefit to contribute to an overall effective system. HSCs must be considered wherever there are opportunities for their use.

XIII.2. Regulatory Basis

The Santa Ana Regional Water Quality Control Board MS4 Permit ([Order R8-2009-0030](#)) (“North County Permit”) and the San Diego Regional Water Quality Control Board MS4 Permit ([Order R9-2009-0002](#)) (“South County Permit”) have been adopted with specific requirements for new development and significant redevelopment stormwater control. Both permits are based on the MEP¹⁹ standard included in the 1987 amendments of the Clean Water Act.

The permits require “retention” (meaning no surface or piped discharges) of stormwater on site as the first alternative, LID BMPs, and allow biotreatment BMPs to be considered only after infiltration, harvest and use, and ET cannot be feasibly implemented to address the entire DCV. The South County Permit requires a “*technical feasibility analysis including cost benefit analysis*” (F.1.d(7)(b)). The North County Permit, by way of its description of the MEP standard (see Footnote 19), requires the consideration of multiple interrelated factors in assessing feasibility. The North Orange County Permit also allows waivers of BMP requirements to be granted “*...if the cost of BMP implementation greatly outweighs the pollution control benefits...*” (XII.E.1). Therefore, there is sound regulatory basis for the consideration of cost-effectiveness, societal factors, and effects on other media, in addition to physical/technical factors, in the evaluation of feasibility of retention on-site.

For example, it would nearly always be physically feasible to install a tank to store the DCV for a project for subsequent use of captured water. However, unless sufficient demand for the captured water exists to empty the tank relatively quickly between storm events, the tank would be relatively ineffective for stormwater management. If the tank was on-line, then it

¹⁹ The North County Permit describes MEP as follows: “MEP is not defined in the Clean Water Act; it refers to management practices, control techniques, and system, design and engineering methods for the control of pollutants taking into account considerations of synergistic, additive, and competing factors, including, but not limited to, gravity of the problem, technical feasibility, fiscal feasibility, public health risks, societal concerns, and social benefits.”

would in effect behave primarily as a wet-vault, whose performance is typically much less than biotreatment. If it was off-line (tank is bypassed when full), then there would be significant untreated flows.

While a system with a low demand would technically fulfill the volumetric LID performance criteria contained in the permits (South County Permit at F.1.d(4)(d)(i), and North County Permit at XII.C.2), this system would be inconsistent with the intent of the permits, and would not meet the MEP requirement and therefore should not be encouraged or mandated. The cost and potential effects on other media associated with such a system would greatly outweigh the pollution control benefits it provides. The direct costs and other environmental and societal effects associated with such a system would include:

- Cost to provide the tank and distribution system,
- Cost to provide and additional BMP(s) to retain or biotreat the overflow from the tank up to 80 percent capture,
- Energy and resources used to manufacture of plastic, metal, or concrete tanks,
- Energy and resources used manufacture of pumps, treatment systems, and piping,
- Energy and air quality impacts associated with shipping and installing the system
- Energy and air quality impacts associated with transportation for specialized maintenance activities
- Disposal of system elements at the end of usable life.

This analysis seeks to identify a minimum level of performance of retention BMPs at which the ‘alternative scenario’ (i.e., biotreatment), after all retention options have been exhausted, would achieve approximately equivalent volume reduction and a higher level of treatment. This analysis assumes that the designer is faced with a mutually exclusive choice between using an infiltration, evapotranspiration, or harvest and use retention BMP versus using a biotreatment BMP or, in the case of a tandem system (e.g., a green roof is the principal retention BMP, with the balance of the drainage area’s DCV, or more, treated in a biotreatment system), a combination of both classes of BMPs.

XIII.3. Comparison to Anticipated Performance of Alternative Scenario

The numeric threshold should reflect conditions where *the cost of BMP implementation greatly outweighs the pollution control benefits* and where the “*alternative scenario*” allowed by the criterion provides similar effectiveness and much lower cost. For both infiltration BMPs and harvest and use BMPs, this can be referenced to the volume reduction and treatment performance that would be achieved by biotreatment BMPs designed for the maximum feasible partial retention (i.e., the *alternative scenario*).

In the case that infiltration and harvest and use are not feasible, the alternative scenario is biotreatment BMPs designed for the maximum partial retention. Biotreatment BMPs must be

designed to achieve the maximum feasible retention and ET of stormwater per the specific criteria contained in [Appendix XI](#), and must be designed to biotreat runoff as feasible up to 80 percent average annual capture efficiency.

When designed to these criteria, biotreatment BMPs are expected to achieve retention of a substantial volume of stormwater. A recent analysis of the monitored inflow and outflow data contained in the International Stormwater BMP Database showed average long term volume reductions on the order of 40 percent for biofilters, 30 percent for extended detention basins, and 60 percent for bioretention areas. These values represent the average of observed total volume reductions through infiltration and transpiration during entire monitoring studies. Total volume reductions during a study were calculated based on comparison of the total inflow volume and outflow volumes measured over the duration of each study (including multiple - up to 65 - storm events). As these analyses utilized long-term observed volume reductions over a series of storm events, they provide a valid comparison to the capture efficiency and volume reduction criteria contained in this TGD that were developed upon long-term hydrologic simulations and summaries.

Table XIII.1: Volume Reduction Summary of Biotreatment BMP Categories in the International Stormwater BMP Database

BMP Category	# of Monitoring Studies	25th Percentile	Median	75th Percentile	Average
Biofilter – Grass Strips	16	18%	34%	54%	38%
Biofilter – Grass Swales	13	35%	42%	65%	48%
Bioretention (with underdrains)	7	45%	57%	74%	61%
Detention Basins – Surface, Grass Lined	11	26%	33%	43%	33%

NOTES

Relative volume reduction = (Study Total Inflow Volume - Study Total Outflow Volume)/(Study Total Inflow Volume)

Excluded other categories due to lack of sufficiently robust dataset or inability to conduct reasonableness screening.

Summary does not reflect performance categorized according to storm size (bin).

Source: International Stormwater Best Management Practices (BMP) Database, Technical Summary: Volume Reduction. January 2011. <http://www.bmpdatabase.org/Docs/Volume%20Reduction%20Technical%20Summary%20Jan%202011.pdf>

These values provide a benchmark for comparing the performance of LID BMPs (infiltration, harvest and use, and evapotranspiration) against the performance of LID biotreatment BMPs, which under some circumstances, may provide a similar level of retention plus offer other pollutant treatment mechanisms. This analysis shows that while LID biotreatment BMPs are not designed to fully retain the DCV, they are capable of providing substantial volume reductions, on the order of half of the water that is captured and managed. This analysis further

shows that a well designed LID biotreatment BMP that has been designed to capture 80 percent of average annual storm water runoff and has been designed to achieve maximum feasible volume reduction would be expected to achieve total long term volume reduction on the order of 40 percent of long term runoff volume. This means that a designer, faced with a LID retention BMP with a performance of 40 percent or less could substitute the LID retention BMP with a LID biotreatment BMP that is capable of carrying 100 percent of the DCV without impairing the overall performance of the site's system of BMPs. This is because roughly 40 percent of the DCV will be incidentally infiltrated or evapotranspired by the LID biotreatment BMP - roughly equal or better than the low-performing LID retention BMP. Therefore, it is appropriate to designate 40 percent retention as a threshold for eliminating the mandatory selection and use of a specific LID retention measure in favor of using LID bioretention BMPs that achieve a comparable or greater level of retention for the system as a whole. This threshold must not be used to reduce the site's overall level of retention.

APPENDIX XIV. BMP FACT SHEETS

This appendix contains BMP fact sheets for the following BMP categories:

Hydrologic Source Control Fact Sheets (HSC)

- HSC-1: Localized On-Lot Infiltration**
- HSC-2: Impervious Area Dispersion**
- HSC-3: Street Trees**
- HSC-4: Residential Rain Barrels**
- HSC-5: Green Roof / Brown Roof**
- HSC-6: Blue Roof**

Infiltration BMP Fact Sheets (INF)

- INF-1: Infiltration Basin Fact Sheet**
- INF-2: Infiltration Trench Fact Sheet**
- INF-3: Bioretention with no Underdrain**
- INF-4: Bioinfiltration Fact Sheet**
- INF-5: Drywell**
- INF-6: Permeable Pavement (concrete, asphalt, and pavers)**
- INF-7: Underground Infiltration**

Harvest and Use BMP Fact Sheets (HU)

- HU-1: Above-Ground Cisterns**
- HU-2: Underground Detention**

Biotreatment BMP Fact Sheets (BIO)

- BIO-1: Bioretention with Underdrains**
- BIO-2: Vegetated Swale**
- BIO-3: Vegetated Filter Strip**
- BIO-4: Wet Detention Basin**
- BIO-5: Constructed Wetland**
- BIO-6: Dry Extended Detention Basin**
- BIO-7: Proprietary Biotreatment**

Treatment Control BMP Fact Sheets (TRT)

- TRT-1: Sand Filters**
- TRT-2: Cartridge Media Filter**

Pretreatment/Gross Solids Removal BMP Fact Sheets (PRE)

PRE-1: Hydrodynamic Separation Device

PRE-2: Catch Basin Insert Fact Sheet

Note: ET plays an important role in the performance of HSC, INF, HU, and BIO BMPs. However, specific fact sheets for ET are not included. Criteria for designing BMPs to achieve the maximum feasible infiltration and ET are contained in [Appendix XI](#).

The BMP designs described in these fact sheets and in the referenced design manuals shall constitute what are intended as LID and Treatment Control BMPs for the purpose of meeting stormwater management requirements. Other BMP types and variations on these designs may be approved at the discretion of the reviewing agency if documentation is provided demonstrating similar functions and equivalent or better expected performance.

XIV.1. Hydrologic Source Control Fact Sheets (HSC)

HSC-1: Localized On-Lot Infiltration

‘Localized on-lot infiltration’ refers to the practice of collecting on-site runoff from small distributed areas within a catchment and diverting it to a dedicated on-site infiltration area. This technique can include disconnecting downspouts and draining sidewalks and patios into french drains, trenches, small rain gardens, or other surface depressions. For downspout disconnections and other impervious area disconnection involving dispersion over pervious surfaces, but without intentional ponding, see HSC-2: Impervious Area Dispersion.

Also known as:

- Downspout infiltration
- Retention grading
- French drains
- On-lot rain gardens



On-lot rain garden
Source: lowimpactdevelopment.org

Feasibility Screening Considerations

- ‘Localized on-lot infiltration’ shall meet infiltration infeasibility screening criteria to be considered for use.

Opportunity Criteria

- Runoff can be directed to and temporarily pond in pervious area depressions, rock trenches, or similar.
- Soils are adequate for infiltration or can be amended to provide an adequate infiltration rate.
- Shallow utilities are not present below infiltration areas.

OC-Specific Design Criteria and Considerations

- A single on-lot infiltration area should not be sized to retain runoff from impervious areas greater than 4,000 sq. ft.; if the drainage area exceeds this criteria, sizing should be based on calculations for bioretention areas or infiltration trenches.
- Soils should be sufficiently permeable to eliminate ponded water within 24 hours following a 85th percentile, 24-hour storm event.
- Maximum ponding depth should be should be less than 3 inches and trench depth should be less than 1.5 feet.
- Infiltration should not be used when the depth to the mounded seasonally high table is within 5 feet of the bottom of infiltrating surface.
- Infiltration via depression storage, french drains, or rain gardens should be located greater than 8 feet from building foundations.
- Site slope should be less than 10%.
- Infiltration unit should not be located within 50 feet of slopes greater than 15 percent.
- Side slopes of rain garden or depression storage should not exceed 3H:1V.
- Effective energy dissipation and uniform flow spreading methods should be employed to prevent erosion resulting fromwater entering infiltration areas.

- Overflow should be located such that it does not cause erosion or and is conveyed away from structures toward the downstream conveyance and treatment system. .

Calculating HSC Retention Volume

- The retention volume provided by localized on-lot infiltration can be computed as the storage volume provided by surface ponding and the pore space within an amended soil layer or gravel trench.
- Estimate the average retention volume per 1000 square feet impervious tributary area provided by on-lot infiltration.
- Look up the storm retention depth, d_{HSC} from the chart to the right.
- The max d_{HSC} is equal to the design capture storm depth for the project site.

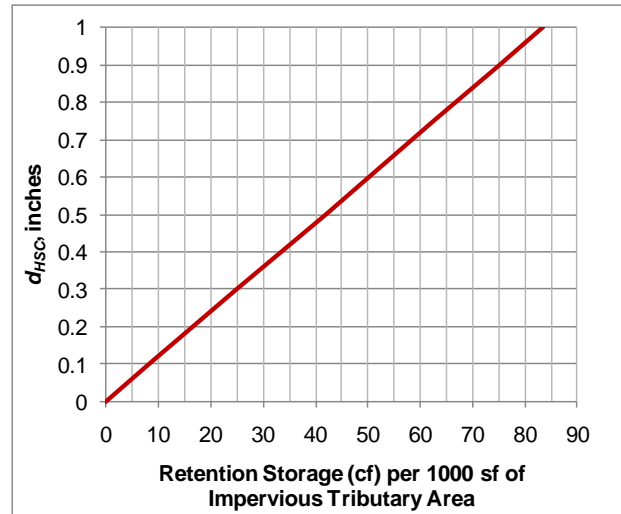

Configuration for Use in a Treatment Train

- Localized on-lot infiltration would typically serve as the first in a treatment train and should only be used where tributary areas do not generate significant sediment that would require pretreatment to mitigate clogging.
- The use of impervious area disconnection reduces the sizing requirement for downstream LID and/or conventional treatment control BMPs.

Additional References for Design Guidance

- LID Center – Rain Garden Design Template. http://www.lowimpactdevelopment.org/raingarden_design/
- University of Wisconsin Extension. Rain Gardens: A How-To Manual for Homeowners. <http://learningstore.uwex.edu/assets/pdfs/GWQ037.pdf>

HSC-2: Impervious Area Dispersion

Impervious area dispersion refers to the practice of routing runoff from impervious areas, such as rooftops, walkways, and patios onto the surface of adjacent pervious areas. Runoff is dispersed uniformly via splash block or dispersion trench and soaks into the ground as it move slowly across the surface of pervious areas. Minor ponding may occur, but it is not the intent of this practice to actively promote localized on-lot storage (See HSC-1: Localized On-Lot Infiltration).

- Also known as:**
- Downspout disconnection
 - Impervious area disconnection
 - Sheet flow dispersion



Simple Downspout Dispersion
 Source:
toronto.ca/environment/water.htm

Feasibility Screening Considerations

- Impervious area dispersion can be used where infiltration would otherwise be infeasible, however dispersion depth over landscaped areas should be limited by site-specific conditions to prevent standing water or geotechnical issues.

Opportunity Criteria

- Rooftops and other low traffic impervious surface present in drainage area.
- Soils are adequate for infiltration. If not, soils can be amended to improve capacity to absorb dispersed water (see MISC-2: Amended Soils).
- Significant pervious area present in drainage area with shallow slope
- Overflow from pervious area can be safely managed.

OC-Specific Design Criteria and Considerations

- Soils should be preserved from their natural condition or restored via soil amendments to meet minimum criteria described in Section .
- A minimum of 1 part pervious area capable of receiving flow should be provided for every 2 parts of impervious area disconnected.
- The pervious area receiving flow should have a slope ≤ 2 percent and path lengths of ≥ 20 feet per 1000 sf of impervious area.
- Dispersion areas should be maintained to remove trash and debris, loose vegetation, and protect any areas of bare soil from erosion.
- Velocity of dispersed flow should not be greater than 0.5 ft per second to avoid scour.

Calculating HSC Retention Volume

- The retention volume provided by downspout dispersion is a function of the ratio of impervious to pervious area and the condition of soils in the pervious area.
- Determine flow patterns in pervious area and estimate footprint of pervious area receiving dispersed flow. Calculate the ratio of pervious to impervious area.
- Check soil conditions using the soil condition design criteria below; amend if necessary.
- Look up the storm retention depth, d_{HSC} from the chart below.

- The max d_{HSC} is equal to the design storm depth for the project site.

Soil Condition Design Criteria

- Maximum slope of 2 percent
- Well-established lawn or landscaping
- Minimum soil amendments per criteria in MISC-2: Amended Soils.

Configuration for Use in a Treatment Train

- Impervious area disconnection is an HSC that may be used as the first element in any treatment train
- The use of impervious area disconnection reduces the sizing requirement for downstream LID and/or treatment control BMPs



¹ Pervious area used in calculation should only include the pervious area receiving flow, not pervious area receiving only direct rainfall or upslope pervious drainage.

Additional References for Design Guidance

- SMC LID Manual (pp 131)
http://www.lowimpactdevelopment.org/guest75/pub/All_Projects/SoCal_LID_Manual/SoCalLID_Manual_FINAL_040910.pdf
- City of Portland Bureau of Environmental Services. 2010. How to manage stormwater – Disconnect Downspouts. <http://www.portlandonline.com/bes/index.cfm?c=43081&a=177702>
- Seattle Public Utility:
http://www.cityofseattle.org/util/stellent/groups/public/@spu/@usm/documents/webcontent/spu01_006395.pdf
- Thurston County, Washington State (pp 10):
http://www.co.thurston.wa.us/stormwater/manual/docs-faqs/DG-5-Roof-Runoff-Control_Rev11Jan24.pdf

HSC-3: Street Trees

By intercepting rainfall, trees can provide several aesthetic and stormwater benefits including peak flow control, increased infiltration and ET, and runoff temperature reduction. The volume of precipitation intercepted by the canopy reduces the treatment volume required for downstream treatment BMPs. Shading reduces the heat island effect as well as the temperature of adjacent impervious surfaces, over which stormwater flows, and thus reduces the heat transferred to downstream receiving waters. Tree roots also strengthen the soil structure and provide infiltrative pathways, simultaneously reducing erosion potential and enhancing infiltration.

<i>Also known as:</i>
➤ <i>Canopy interception</i>

<p>Street trees Source: Geosyntec Consultants</p>

Feasibility Screening Considerations

- Not applicable

Opportunity Criteria

- Street trees can be incorporated in green streets designs along sidewalks, streets, parking lots, or driveways.
- Street trees can be used in combination with bioretention systems along medians or in traffic calming bays.
- There must be sufficient space available to accommodate both the tree canopy and root system.

OC-Specific Design Criteria and Considerations

- Mature tree canopy, height, and root system should not interfere with subsurface utilities, suspended powerlines, buildings and foundations, or other existing or planned structures. Required setbacks should be adhered to.
- Depending on space constraints, a 20 to 30 foot diameter canopy (at maturity) is recommended for stormwater mitigation.
- Native, drought-tolerant species should be selected in order to minimize irrigation requirements and improve the long-term viability of trees.
- Trees should not impede pedestrian or vehicle sight lines.
- Planting locations should receive adequate sunlight and wind protection; other environmental factors should be considered prior to planting.
- Frequency and degree of vegetation management and maintenance should be considered with respect to owner capabilities (e.g., staffing, funding, etc.).
- Soils should be preserved in their natural condition (if appropriate for planting) or restored via soil amendments to meet minimum criteria described in MISC-2: Amended Soils. If necessary, a landscape architect or plant biologist should be consulted.
- A street tree selection guide, such as that specific to the City of Los Angeles, may need to be consulted to select species appropriate for the site design constraints (e.g., parkway size, tree height, canopy spread, etc.)
- Infiltration should not cause geotechnical hazards related to adjacent structures (buildings,

roadways, sidewalks, utilities, etc.)

Calculating HSC Retention Volume

- The retention volume provided by street trees via canopy interception is dependent on the tree species, time of the year, and maturity.
- To compute the retention depth, the expected impervious area covered by the full tree canopy after 4 years of growth must be computed (I_{HSC}). The maximum retention depth credit for canopy interception (d_{HSC}) is 0.05 inches over the area covered by the canopy at 4 years of growth.

Configuration for Use in a Treatment Train

- As a HSC, street trees would serve as the first step in a treatment train by reducing the treatment volume and flow rate of a downstream treatment BMP.

Additional References for Design Guidance

- California Stormwater BMP Handbook.
http://www.cabmphandbooks.com/Documents/Development/Section_3.pdf
- City of Los Angeles, Street Tree Division - Street Tree Selection Guide.
<http://bss.lacity.org/UrbanForestryDivision/StreetTreeSelectionGuide.htm>
- Portland Stormwater Management Manual.
<http://www.portlandonline.com/bes/index.cfm?c=35122&a=55791>
- San Diego County – Low Impact Development Fact Sheets.
<http://www.sdcounty.ca.gov/dplu/docs/LID-Appendices.pdf>

HSC-4: Residential Rain Barrels

Rain barrels are above ground storage vessels that capture runoff from roof downspouts during rain events and detain that runoff for later reuse for irrigating landscaped areas. The temporary storage of roof runoff reduces the runoff volume from a property and may reduce the peak runoff velocity for small, frequently occurring storms. In addition, by reducing the amount of storm water runoff that flows overland into a storm water conveyance system (storm drain inlets and drain pipes), less pollutants are transported through the conveyance system into local creeks and ocean. The reuse of the detained water for irrigation purposes leads to the conservation of potable water and the recharge of groundwater.

Feasibility Screening Considerations

- Rain barrels not actively managed that overflow to infiltration areas shall be screened as Infiltration BMPs for feasibility screening.

Opportunity Criteria

- Rooftops with downspouts or other suitable conveyances (e.g. rain chains) present in the drainage area.
- If detained water will be used for irrigation, sufficient vegetated areas and other impervious surfaces must be present in drainage area.
- Storage capacity and sufficient area for overflow dispersion must be accounted for.

OC-Specific Design Criteria and Considerations

- Screens on gutters and downspouts should be used to remove sediment and particles as the water enters the barrel or cistern. Removable child-resistant covers and mosquito screening should be used to prevent unwanted access.
- Above-ground barrels should be secured in place.
- Above-ground barrels should not be located on uneven or sloped surfaces; if installed on a sloped surface, the base where the cistern will be installed should be leveled prior to installation.
- Overflow dispersion should occur greater than 8 feet from building foundations.
- Dispersion should not cause geotechnical hazards related to slope stability.
- Dispersion should be only allowed to stable vegetated areas where erosion or suspension of sediment is minimized.
- Effective energy dissipation and uniform flow spreading methods should be employed to prevent erosion and facilitate dispersion.
- Aesthetics should be considered for placement of barrels and incorporation into surroundings. Placement should allow easy access for regular maintenance.



- To draw down a 55 gallon rain barrel within 2 days with plant watering, at least 1,600 square feet of conservation landscape or 800 square feet of active turf area is needed.

Calculating HSC Retention Volume

- At least 1,600 sq-ft of conservation landscape or 800 sq-ft of active turf landscape shall be provided for each rain barrel to claim an HSC credit volume
- The effective volume provided by rain barrels that are not actively managed can be computed as 50% of the total storage volume (e.g., 27.5 gallons for each 55 gallon barrel).
- If the rain barrel is actively managed then it should be treated as a cistern as described in **Appendix XIV.4**.
- Estimate the average retention volume per 1000 square feet impervious tributary area provided by rain barrels. Example:
 - 500 square feet of roof draining to a 55 gallon rain barrel
 - Retention volume = $(55/2) = 27.5$ gallons
 - Retention volume per 1000 sq feet = $27.5 \text{ gallons} / 0.5 = 55 \text{ gallons per } 1000 \text{ sq-ft}$
 - Based on the retention storage estimated, look up the storm retention depth, d_{HSC} from the chart to the right = 0.07 inches
 - The max d_{HSC} is equal to the design storm depth for the project site.

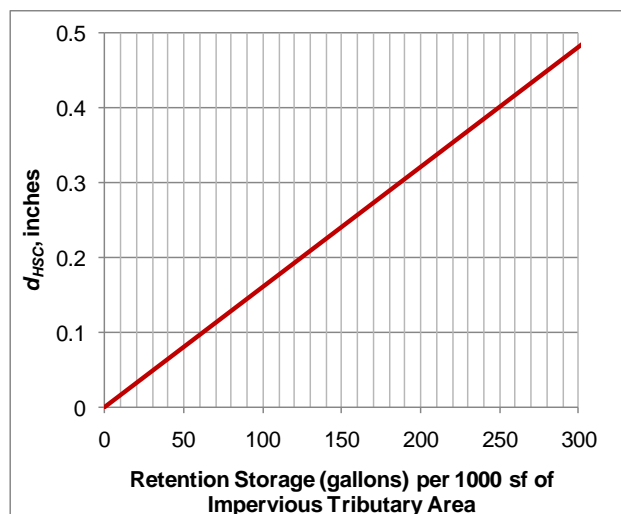

Configuration for Use in a Treatment Train

- Rain barrels can be combined into a treatment train to provide enhanced water quality treatment and reductions in the runoff volume and rate. For example, if a green roof is placed upgradient of a rain barrel, the rate and volume of water flowing to the barrel can be reduced and the water quality enhanced.
- Rain barrels can be incorporated into the landscape design of a site and can be aesthetically pleasing as well as functional for irrigation purposes.

Additional References for Design Guidance

- Santa Barbara BMP Guidance Manual, Chapter 6:
http://www.santabarbaraca.gov/NR/rdonlyres/91D1FA75-C185-491E-A882-49EE17789DF8/0/Manual_071008_Final.pdf
- County of Los Angeles Low Impact Development Standards Manual:
http://dpw.lacounty.gov/wmd/LA_County_LID_Manual.pdf
- SMC LID Manual (pp 114):
http://www.lowimpactdevelopment.org/guest75/pub/All_Projects/SoCal_LID_Manual/SoCalLID_Manual_FINAL_040910.pdf
- San Diego County LID Handbook Appendix 4 (Factsheet 26):
<http://www.sdcounty.ca.gov/dplu/docs/LID-Appendices.pdf>

HSC-5: Green Roof / Brown Roof

Green roofs are also known as ecoroofs, roof gardens, or vegetated roof covers. Green roofs are roofing systems that layer a soil/vegetative cover over a waterproofing membrane. There are two types of green roofing systems; extensive, which is a light weight system and intensive, which is a heavier system that allows for larger plants but requires additional maintenance. A green roof mimics pre-development conditions by limiting the impervious area created by development. Green roofs filter, absorb, and evapotranspire precipitation to help mitigate the effects of urbanization on water quality and delivery of excess runoff to the local storm water conveyance systems.

Brown roofs are essentially a type of green roof designed to maximize biodiversity. Brown roofs typically utilize natural soil and locally available substrates to create a protected biodiverse habitat for specific species of local flora and fauna. Rather than landscaping the roof during construction, plants are left to germinate and grow on their own in the native soils, thus the “brown” (i.e., initially unvegetated) designation. Hand-seeding may be implemented where self-colonization via airborne seeds is unlikely.



Feasibility Screening Considerations

- Green roofs should be selected with consideration for their impacts on irrigation during the dry season and during dry periods of the wet season.

Opportunity Criteria

- Green roofs can be applied to multi-family residential, commercial, or institutional land uses including rooftops and decks above building structures (e.g., parking structures, outdoor eating area roofs, or storage facilities).
- Roofs are ideally multi-story with significant structural over-design to support the additional weight of the soil, retained water, and plants, as confirmed by a licensed structural engineer.
- Roofs are ideally relatively flat.

OC-Specific Design Criteria and Considerations

- Saturated soil will weigh approximately 10 – 25 lbs/square foot. If the building and roof are not designed to hold this weight (such as in a retrofit situation), a licensed structural engineer should be consulted.
- Soil depth should be consistent with minimum depths provided in [Appendix IX](#).
- A drain pipe (gutter) is required to convey runoff safely from the roof.
- Depending on the design of the roof, a drainage layer may be required to move the excess runoff off of the roof.

- A waterproof membrane, preventing the roof runoff from penetrating and damaging the roofing material, should be used. There are many materials available for this purpose; they come in various forms (i.e., rolls, sheets, liquid) and exhibit different characteristics (e.g., flexibility, strength, etc.). Depending on the type of membrane chosen a root barrier may be required to prevent roots from compromising the integrity of the membrane.
- Green roofs should be about 90% vegetated with a mix of erosion resistant plant species that effectively bind the soil and can withstand the extreme environment of rooftops (i.e., heat, cold, and high winds).
- A diverse selection of low growing plants that thrive under the specific site, climatic, and watering conditions should be specified. A mixture of drought tolerant, self-sustaining (perennial or self-sowing without need for fertilizers, herbicides, and or pesticides) is most effective. Native or adapted sedum/succulent plants are preferred because they generally require less fertilizer, limited maintenance, and are more drought resistant than exotic plants. When appropriate, green roofs may be planted with larger plants; however, this depends on structural support, soil depth, and irrigation requirements.
- Irrigation is required if the seed is planted in spring or summer. Use of a permanent smart (self-regulating) irrigation system, or other watering system, may help provide maximal water quality performance. Drought-tolerant plants should be specified to minimize irrigation requirements. For projects seeking “High Performance Building” recognition, ASHRAE Standard 189.1 states that potable water cannot be used for irrigating green roofs after they are established.
- Locate the green roof in an area without excessive shade to avoid poor vegetative growth. For moderately shaded areas, shade tolerant plants should be used.
- Project-specific planting recommendations should be provided by a landscape professional including recommendations on appropriate plants, fertilizer, mulching applications, and irrigation requirements (if any) to ensure healthy vegetation growth.

Sizing

Appendix IX provides minimum criteria for green roofs to be considered self-retaining and shall be the governing sizing basis for green roofs.

Configuration for Use in a Treatment Train

- If implemented in a treatment train, green roofs are typically at the most upstream end. A green roof placed upgradient of a cistern can improve the quality and reduce the rate and volume of water flowing to the cistern. Alternatively, a planter box could be placed downstream of a downspout that drains the green roof.

Additional References for Design Guidance

- Los Angeles Unified School District Stormwater Technical Manual, 2009.
http://www.laschools.org/employee/design/fs-studies-and-reports/download/white_paper_report_material/Storm_Water_Technical_Manual_2009-opt-red.pdf?version_id=76975850
- City of Santa Barbara, Technical Guidance Manual for Post-Construction Storm Water Management, 2008. http://www.santabarbaraca.gov/NR/rdonlyres/91D1FA75-C185-491E-A882-49EE17789DF8/0/Manual_071008_Final.pdf
- Portland Stormwater Management Manual.
<http://www.portlandonline.com/bes/index.cfm?c=35122&a=55791>
- San Diego County – Low Impact Development Fact Sheets.
<http://www.sdcounty.ca.gov/dplu/docs/LID-Appendices.pdf>

- Brown Roofs. <http://www.brownroofs.co.uk/brown-roof-maintenance.php>

HSC-6: Blue Roof

Blue roofs, also known as rooftop detention systems, serve as a rooftop storage designed to reduce runoff peaks and volumes. Captured stormwater, up to the design depth, is held on the rooftop until the water either evaporates or is slowly metered out via flow restriction valves. With sufficient waterproofing blue roofs can be implemented on existing structures, given that the roof and building are of sufficient structural integrity to support the weight for the ponded water. As blue roofs lack vegetation, they require significantly less maintenance than green or brown roofs. *Note: Blue roofs should not be designed to hold standing water longer than 96 hours in order to mitigate vector hazards.*

<i>Also known as:</i>
➤ <i>Rooftop Detention Systems</i>

<p>Blue Roof <i>Source: New York Department of Environmental Protection</i></p>

Feasibility Screening Considerations

- Potential feasibility concerns for blue roofs relate to standing water (vectors) and structural requirements, however these constraints can generally be overcome with careful design.

Opportunity Criteria

- Blue roofs can be applied to multi-family residential, commercial, or institutional land uses including rooftops and decks above building structures (e.g., parking structures, outdoor eating area roofs, or storage facilities).
- Building structure must be adequate to support the additional weight of the retained water.
- Roof slope must be flat.

OC-Specific Design Criteria and Considerations

- A licensed structural engineer should be consulted regarding the weight bearing capacity of the structure prior to design. Retrofit may be required.
- Blue roof discharges must be treated by an acceptable biotreatment BMP.
- A drain pipe (gutter) is required to convey runoff safely from the roof.
- A waterproof membrane, preventing the retained water from penetrating and damaging the roofing material, should be used. There are many materials available for this purpose; they come in various forms (i.e., rolls, sheets, liquid) and exhibit different characteristics (e.g., flexibility, strength, etc.).
- Unless covered, the maximum detention time should comply with all local, state, and federal regulations. Maximum hold time is typically 72-hours to prevent the breeding of mosquitoes.
- Over time rooftop vegetation may sprout by means of windblown sediment and seeds, especially in a dusty, windy environment. Roof drains should be inspected for clogging, as this may adversely affect downstream BMPs.

Sizing

- Blue roofs will not generally be able to achieve full retention of the DCV and are most applicable as HSCs as the first part of a treatment train. In this role, the retention depth of the blue roof would be removed from the remaining sizing criteria for downstream BMPs.

Configuration for Use in a Treatment Train

- A blue roof would serve as the first unit within a treatment train, with captured flows metered to a planter box, rain garden, infiltration gallery, or, if the site is not conducive for infiltration, potentially to a cistern or underground detention area for on-site rainwater use.

Additional References for Design Guidance

- City of New York – Sustainable Stormwater Management Plan, 2008.
http://www.nyc.gov/html/planyc2030/downloads/pdf/sustainable_stormwater_plan.pdf
- Environmental Protection – Blue Roofs the Stormwater-Sustainability Link.
<http://eponline.com/blogs/planetshed/2010/04/blue-roofs-the-stormwatersustainability-link.aspx>

XIV.2. Miscellaneous BMP Design Element Fact Sheets (MISC)

MISC-1: Planting/Storage Media

Planting and storage media is a critical design element for several common BMP types, including bioretention, bioinfiltration, swales, filter strips, and greenroofs. This fact sheet is intended to be used as referenced from these fact sheets.

General Design Criteria

- Planting/storage media should be designed to achieve the long term hydraulic design requirements associated with the design of the facility (i.e., design K_{sat}).
- The planting media shall be designed to address pollutants of concern at the design hydraulic capacity.
- Bioretention soil shall also support vigorous plant growth.
- Planting media should consist of 60 to 80% fine sand and 20 to 40% compost.
- Planting media for projects draining to nutrient sensitive receiving water should adhere to recommendations for nutrient sensitive planting media provided below.

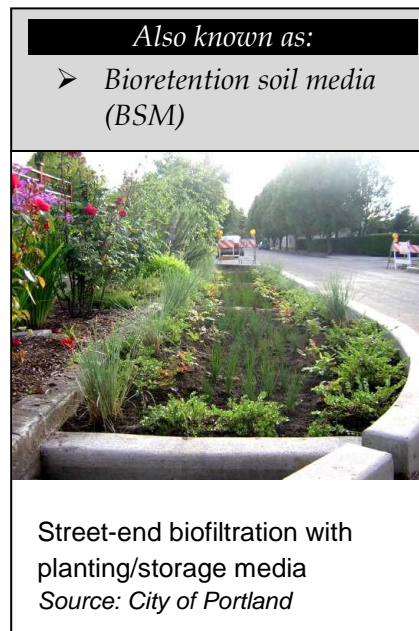

Sand

- Sand should be free of wood, waste, coating such as clay, stone dust, carbonate, etc., or any other deleterious material. All aggregate passing the No. 200 sieve size should be non-plastic. Sand for bioretention should be analyzed by an accredited lab using #200, #100, #40, #30, #16, #8, #4, and 3/8 sieves (ASTM D 422 or as approved by the local permitting authority) and meet the following gradation (Note: all sands complying with ASTM C33 for fine aggregate comply with the gradation requirements below):

Sieve Size (ASTM D422)	% Passing (by weight)	
	Minimum	Maximum
3/8 inch	100	100
#4	90	100
#8	70	100
#16	40	95
#30	15	70
#40	5	55
#100	0	15
#200	0	5

- Note: the gradation of the sand component of the media is believed to be a major factor in the hydraulic conductivity of the media mix. If the desired hydraulic conductivity of the media cannot be achieved within the specified proportions of sand and compost (#2), then it may be necessary to utilize sand at the coarser end of the range specified in the table above (“minimum” column).

Compost

Compost should be a well decomposed, stable, weed free organic matter source derived from waste materials including yard debris, wood wastes, or other organic materials not including manure or biosolids meeting standards developed by the US Composting Council (USCC). The product shall be certified through the USCC Seal of Testing Assurance (STA) Program (a compost testing and information disclosure program). Compost quality should be verified via a lab analysis to be:

- Feedstock materials shall be specified and include one or more of the following: landscape/yard trimmings, grass clippings, food scraps, and agricultural crop residues.
- Organic matter: 35-75% dry weight basis.
- Carbon and Nitrogen Ratio: 15:1 < C:N < 25:1
- Maturity/Stability: shall have dark brown color and a soil-like odor. Compost exhibiting a sour or putrid smell, containing recognizable grass or leaves, or is hot (120 F) upon delivery or rewetting is not acceptable.
- Toxicity: any one of the following measures is sufficient to indicate non-toxicity:
 - NH4:NH3 < 3
 - Ammonium < 500 ppm, dry weight basis
 - Seed Germination > 80% of control
 - Plant trials > 80% of control
- Solvita® > 5 index value
- Nutrient content:
 - Total Nitrogen content 0.9% or above preferred
 - Total Boron should be <80 ppm, soluble boron < 2.5 ppm
- Salinity: < 6.0 mmhos/cm
- pH between 6.5 and 8 (may vary with plant palette)
- Compost for bioretention should be analyzed by an accredited lab using #200, ¼ inch, ½ inch, and 1 inch sieves (ASTM D 422 or as approved by the local permitting authority) and meet the following gradation:

Sieve Size (ASTM D422)	% Passing (by weight)	
	Minimum	Maximum
1 inch	99	100
½ inch	90	100
¼ inch	40	90
#200	2	10

- Tests should be sufficiently recent to represent the actual material that is anticipated to be delivered to the site. If processes or sources used by the supplier have changed significantly since the most recent testing, new tests should be requested.
- Note: the gradation of compost used in bioretention media is believed to play an important role in the saturated hydraulic conductivity of the media. To achieve a higher saturated hydraulic conductivity, it may be necessary to utilize compost at the coarser end of this range (“minimum” column). The percent passing the #200 sieve (fines) is believed to be the most important factor in hydraulic conductivity. In addition, a coarser compost mix provides more heterogeneity of the bioretention media, which is believed to be advantageous for more rapid development of soil structure needed to support health biological processes. This may be an advantage for plant establishment with lower nutrient and water input.

Mulch

- Planting area should generally be covered with 2 to 4 inches (average 3 inches) of mulch at the start and an additional placement of 1 to 2 inches of mulch should be added annually. *The intention is that to help sustain the nutrient levels, suppress weeds, retain moisture, and maintain infiltration capacity.*
- For nutrient-sensitive planting/storage media design, inorganic mulch such as gravel, may be used.

Planting/Storage Media Design for Nutrient Sensitive Receiving Waters

Where the BMP discharges to receiving waters with nutrient impairments or nutrient TMDLs, the planting media placed should be designed with the specific goal of minimizing the potential for initial and long term leaching of nutrients from the media.

- In general, the potential for leaching of nutrients can be minimized by:
 - Utilizing stable, aged compost (as required of media mixes under all conditions).
 - Utilizing other sources of organic matter, as appropriate, that are safe, non-toxic, and have lower potential for nutrient leaching than compost.
 - Reducing the content of compost or other organic material in the media mix to the minimum amount necessary to support vigorous plant growth and healthy biological processes.
- A landscape architect should be consulted to assist in the design of planting/storage media to balance the interests of plant establishment, water retention capacity (irrigation demand), and the potential for nutrient leaching. The following practices should be considered in developing the media mix design:
 - The actual nutrient content and organic content of the selected compost source should be considered when specifying the proportions of compost and sand. The compost specification allows a range of organic content over approximately a factor of 2 and nutrient content may vary more widely. Therefore determining the actual organic content and nutrient content of the compost expected to be supplied is important in determining the proportion to be used for amendment.
 - A commitment to periodic soil testing for nutrient content and a commitment to adaptive management of nutrient levels can help reduce the amount of organic amendment that must be provided initially. Generally, nutrients can be added planting areas through the addition of organic mulch, but cannot be removed.
 - Plant palettes and the associated planting mix should be designed with native plants where possible. Native plants generally have a broader tolerance for nutrient content, and can be longer lived in leaner/lower nutrient soils. An additional benefit of lower nutrient levels is that native plants will generally have less competition from weeds.

- Nutrients are better retained in soils with higher cation exchange capacity (CEC). CEC can be increased through selection of organic material with naturally high CEC, such as peat, and/or selection of inorganic material with high CEC such as some sands or engineered minerals (e.g., low P-index sands, zeolites, rhyolites, etc). Including higher CEC materials would tend to reduce the net leaching of nutrients.
- Soil structure can be more important than nutrient content in plant survival and biologic health of the system. If a good soil structure can be created with very low amounts of compost, plants survivability should still be provided. Soil structure is loosely defined as the ability of the soil to conduct and store water and nutrients as well as the degree of aeration of the soil. While soil structure generally develops with time, planting/storage media can be designed to promote earlier development of soil structure. Soil structure is enhanced by the use of amendments with high hummus content (as found in well-aged organic material). In addition, soil structure can be enhanced through the use of compost/organic material with a distribution of particle sizes (i.e., a more heterogeneous mix). Finally, inorganic amendments such as polymer beads may be useful for promoting aeration and moisture retention associated with a good soil structure. An example of engineered soil to promote soil structure can be found here:
<http://www.hort.cornell.edu/uhi/outreach/pdfs/custructuralsoilwebpdf.pdf>
- Younger plants are generally more tolerant of lower nutrient levels and tend to help develop soil structure as they grow. Starting plants from smaller transplants can help reduce the need for organic amendments and improve soil structure. The project should be able to accept a plant mortality rate that is somewhat higher than starting from larger plants and providing high organic content.
- With these considerations, it is anticipated that less than 10 percent compost amendment could be used, while still balancing plant survivability and water retention.

We wish to express our gratitude to following individuals for their feedback on the design of planting/storage media for nutrient sensitive receiving waters in Southern California.

Deborah Deets, City of Los Angeles Bureau of Sanitation

Drew Ready, LA and San Gabriel Rivers Watershed Council

Rick Fisher, ASLA, City of Los Angeles Bureau of Engineering

Dr. Garn Wallace, Wallace Laboratories

Glen Dake, GDML

Jason Schmidt, Tree People

The guidance provided herein does not reflect the individual opinions of any individual listed above and should not be cited or otherwise attributed to those listed.

Selecting Plants for Planting/Storage Media

- Plant materials should be tolerant of summer drought, ponding fluctuations, and saturated soil conditions for 48 to 96 hours.
- It is recommended that a minimum of three types of tree, shrubs, and/or herbaceous groundcover species be incorporated to protect against facility failure due to disease and insect infestations of a single species.
- Native plant species and/or hardy cultivars that are not invasive and do not require chemical inputs should be used to the maximum extent feasible.

MISC-2: Amended Soils

Soil amendments alter the soil characteristics to allow it to absorb, infiltrate, and retain more water to help reduce runoff volume and velocity, filter pollutants, increase the quality and quantity of vegetation, and reduce erosion potential more effectively than soils without soil amendments. Mulch is an amendment that is added on the top of the soil, rather than mixed into the soil, which reduces evaporation and adds to the aesthetics of a site. Compost and fertilizers are common soil amendments that must be completely mixed into the soil to function properly.



Soil amended area at U.S. EPA Ariel Rios building.

Source:

http://www.epa.gov/oaintrnt/stormwater/hq_projects.htm

General Criteria

- Compost, soil conditioners, and fertilizers should be rototilled into the native soil to a minimum depth of 6" (12 inches preferred). Mulch at grade should be spread over all planting areas to a depth of 3".
- Sand can be used as an amendment to improve the drainage rates of amended soils. Sand should be free of stones, stumps, roots or other similar objects larger than 5 mm
- Incorporating compost and other organics into the root zone results in enhanced biological activity, attenuation of environmental contaminants, increased moisture holding capacity, and improved soil structure. Compost shall meet the specifications below.
- All soil amendments should be free of stones, stumps, roots or other similar objects larger than 2 inches.
- All soil amendments should be free of glass, plastic, metal, and other deleterious materials.

Accounting for Soil Amendments in Sizing Calculations

No retention credit is given for amended soils alone. Amended soils should be used as part of HSC-2 Impervious Area Dispersion, and to increase the retention volume of Infiltration and Biotreatment BMPs.

Additional References

Los Angeles Unified School District (LAUSD) Stormwater Technical Manual, Chapter 3:
http://www.laschools.org/employee/design/fs-studies-and-reports/download/white_paper_report_material/Storm_Water_Technical_Manual_2009-opt-red.pdf?version_id=76975850

Santa Barbara BMP Guidance Manual, Chapter 5:
http://www.santabarbaraca.gov/NR/rdonlyres/91D1FA75-C185-491E-A882-49EE17789DF8/0/Manual_071008_Final.pdf

- San Diego County LID Handbook Appendix 4 (Factsheet 30):
<http://www.sdcounty.ca.gov/dplu/docs/LID-Appendices.pdf>

XIV.3. Infiltration BMP Fact Sheets (INF)

INF-1: Infiltration Basin Fact Sheet

An infiltration basin consists of an earthen basin constructed in naturally pervious soils (Type A or B soils) with a flat bottom. An energy dissipating inlet must be provided, along with an emergency spillway to control excess flows. An optional relief underdrain may be provided to drain the basin if standing water conditions occur. A forebay settling basin or separate treatment control measure must be provided as pretreatment. An infiltration basin retains the stormwater quality design volume in the basin and allows the retained runoff to percolate into the underlying soils in 72 hours or less. The bottom of an infiltration basin is typically vegetated with dryland grasses or irrigated turf grass; however other types of vegetation are permissible if they can survive periodic inundation and long inter-event dry periods.

Feasibility Screening Considerations

- Infiltration basins shall pass infeasibility screening criteria to be considered for use
- Infiltration basins pose a potential risk of groundwater contamination if underlying soils have very high permeability and low pollutant assimilation capacity; pretreatment should always be provided.
- Evaporation tends to be minor, therefore increases in infiltration compared to natural conditions may result.
- The potential for groundwater mounding should be evaluated if depth to seasonally high groundwater (unmounded) is less than 15 feet.

<p style="text-align: center;"><i>Also known as:</i></p> <ul style="list-style-type: none"> ➤ <i>Recharge basins</i> ➤ <i>Infiltration pond</i>

<p>Infiltration Basin</p> <p><i>Source: Pennsylvania Stormwater BMP Manual</i></p>

Opportunity Criteria

- Soils are adequate for infiltration or can be amended to provide an adequate infiltration rate.
- Typically need 2-5 percent of drainage area available for infiltration.
- Space available for pretreatment (biotreatment or treatment control BMP as described below).
- Potential for groundwater contamination can be mitigated through isolation of pollutant sources, pretreatment of inflow, and/or demonstration of adequate treatment capacity of underlying soils.
- Infiltration is into native soil, or
- The depth of engineered fill is ≤ 5 feet from the bottom of the facility to native material and infiltration into fill is approved by a geotechnical professional.
- Tributary area land uses include mixed-use and commercial, single-family and multi-family, roads and parking lots, and parks and open spaces. Basins can be integrated into parks and open spaces. High pollutant land uses should not be tributary to infiltration BMPs.

OC-Specific Design Criteria and Considerations

- Placement of BMPs shall observe geotechnical recommendations with respect to geological hazards (e.g. landslides, liquefaction zones, erosion, etc.) and set-backs (e.g., foundations,

- utilities, roadways, etc.)
- For facilities with tributary area less than 5 acres, minimum separation to mounded seasonally high groundwater of 5 feet shall be observed.
 - For facilities with tributary area greater than 5 acres, minimum separation to mounded seasonally high groundwater of 10 feet shall be observed.
 - Minimum pretreatment (settling forebay or separate BMP) should be provided upstream of the infiltration basin, and water bypassing pretreatment should not be directed to the infiltration basin.
 - If a settling forebay is used, forebay should have a volume equal to 25% of facility volume and have a minimum length to width ratio of 2:1
 - Infiltration basins should not be used for drainage areas with high sediment production potential unless preceded by full treatment control with a BMP effective for sediment removal.
 - Side-slopes should be no steeper than 3H:1V.
 - Design infiltration rate should be determined consistent with guidance contained in **Appendix VII**.
 - Energy dissipators should be provided at inlet and outlet to prevent erosion.
 - An overflow device must be provided if basin is on-line.
 - A minimum freeboard of one foot should be provided above the overflow device (for an on-line basin) or the outlet (for an off-line basin).
 - Infiltration basin bottom must be as flat as possible.
 - Basin length to width ratio should be a minimum of 2:1 L:W.

Simple Sizing Method for Infiltration Basins

If the Simple DCV Sizing Method is used to size an infiltration basin, the user calculates the DCV and designs the BMP geometry required to draw down the DCV in 48 hours. The sizing steps are as follows:

Step 1: Determine Infiltration Basin DCV

Calculate the DCV using the Simple Design Capture Volume Sizing Method described in **Appendix III.3.1**.

Step 2: Determine the 48-hour Depth

The depth of water that can be drawn down in 48 hours can be calculated using the following equation:

$$d_{48} = K_{\text{DESIGN}} \times 4$$

Where:

d_{48} = basin 48-hour drawdown depth, ft

K_{DESIGN} = basin design infiltration rate, in/hr (See **Appendix VII**)

This is the maximum depth of the basin below the overflow device to achieve drawdown in 48 hours.

Step 3: Calculate the Required Infiltrating Area

The required infiltrating area (i.e. basin area at mid ponding depth) can be calculated using the following equation:

$$A = \text{DCV} / (d_p)$$

Where:

A = required basin infiltrating area, sq-ft (assumed to be the basin area at mid-ponding depth)

DCV = design capture volume, cu-ft (see Step 1)

d_p = ponding depth, ft (should be equal to or less than d_{48})

Capture Efficiency Method for Infiltration Basins

If BMP geometry has already been defined and deviates from the 48 hour drawdown time, the designer can use the Capture Efficiency Method for Volume-Based, Constant Drawdown BMPs (See [Appendix III.3.2](#)) to determine the fraction of the DCV that must be provided to manage 80 percent of average annual runoff volume. This method accounts for drawdown time different than 48 hours.

Step 1: Determine the drawdown time associated with the selected basin geometry

$$DD = (d_p / K_{DESIGN}) \times 12$$

Where:

DD = time to completely drain infiltration basin ponding depth, hours

d_p = ponding depth below overflow device, ft

K_{DESIGN} = basin design infiltration rate, in/hr (See [Appendix VII](#))

Step 2: Determine the Required Adjusted DCV for this Drawdown Time

Use the Capture Efficiency Method for Volume-Based, Constant Drawdown BMPs ([Appendix III.3.2](#)) to calculate the fraction of the DCV the basin must hold to achieve 80 percent capture of average annual stormwater runoff volume based on the basin drawdown time calculated above.

Step 3: Determine the Basin Infiltrating Area Needed

The required infiltrating area (i.e. basin bottom) can be calculated using the following equation:

$$A = DCV / ((d_p))$$

Where:

A = required basin infiltrating area, sq-ft (assumed to be the basin area at mid-ponding depth)

DCV = design capture volume, adjusted for drawdown time, cu-ft (see Step 1)

d_p = ponding depth, ft

If the area required is greater than the selected basin area, adjust surface area or adjust ponding depth and recalculate required area until the required area is achieved.

Configuration for Use in a Treatment Train

- Infiltration basins may be preceded in a treatment train by HSCs in the drainage area, which would reduce the required design volume of the basins.
- Infiltration basins must be preceded by some form of pretreatment, which may be biotreatment or a treatment control BMP; if an approved biotreatment BMP is used as pretreatment, the overflow from the infiltration basin may be considered “biotreated” for the purposes of meeting the LID requirements.
- The overflow or bypass from an infiltration basin can be routed to a downstream biotreatment BMP and/or a treatment control BMP if additional control is required to achieve LID or treatment control requirements.

Additional References for Design Guidance

- CASQA BMP Handbook for New and Redevelopment:
<http://www.cabmphandbooks.com/Documents/Development/TC-11.pdf>
- SMC LID Manual (pp 139):
http://www.lowimpactdevelopment.org/guest75/pub/All_Projects/SoCal_LID_Manual/SoCalLID_Manual_FINAL_040910.pdf
- Los Angeles County Stormwater BMP Design and Maintenance Manual, Chapter 6:
http://dpw.lacounty.gov/DES/design_manuals/StormwaterBMPDesignandMaintenance.pdf
- City of Portland Stormwater Management Manual (Basin, page 2-57)
<http://www.portlandonline.com/bes/index.cfm?c=47954&a=202883>
- San Diego County LID Handbook Appendix 4 (Factsheet 2):
<http://www.sdcountry.ca.gov/dplu/docs/LID-Appendices.pdf>

INF-2: Infiltration Trench Fact Sheet

An infiltration trench is a long, narrow, rock-filled trench with no outlet other than an overflow outlet. Runoff is stored in the void space between stones and infiltrates through the bottom and sides of the trench. Infiltration trenches provide the majority of their pollutant removal benefits through volume reduction. Pretreatment is important for limiting amounts of coarse sediment entering the trench which can clog and render the trench ineffective. *Note: if an infiltration trench is "deeper than its widest surface dimension," or includes an assemblage of perforated pipes, drain tiles, or other similar mechanisms intended to distribute runoff below the surface of the ground, it would probably be considered a "Class V Injection Well" under the federal Underground Injection Control (UIC) Program, which is regulated in California by U.S. EPA Region 9. A UIC permit may be required for such a facility (for details see <http://www.epa.gov/region9/water/groundwater/uic-classv.html>).*

<i>Also known as:</i>
<ul style="list-style-type: none"> ➤ <i>French Drains</i> ➤ <i>Rock Trenches</i> ➤ <i>Exfiltration Trenches</i> ➤ <i>Soak-aways</i> ➤ <i>Soakage Trenches</i>

<p>Infiltration Trench</p> <p>Source: www.dot.ca.gov</p>

Feasibility Screening Considerations

- Infiltration trenches shall pass infeasibility screening criteria to be considered for use
- Infiltration trenches, particularly deeper designs, may not provide significant attenuation of stormwater pollutants if underlying soils have high permeability; potential risk of groundwater contamination.
- The potential for groundwater mounding should be evaluated if depth to seasonally high groundwater (unmounded) is less than 15 feet.

Opportunity Criteria

- Soils are adequate for infiltration or can be amended to provide an adequate infiltration rate.
- Drainage area area is ≤ 5 acres and has low to moderate sediment production.
- 2-3 percent of drainage area available for infiltration (generally requires less surface area than infiltration basins and bioretention areas without underdrain).
- Space available for pretreatment (biotreatment or treatment control BMP as described below).
- Potential for groundwater contamination can be mitigated through isolation of pollutant sources, pretreatment of inflow, and/or demonstration of adequate treatment capacity of underlying soils.
- Infiltration is into native soil, or depth of engineered fill is ≤ 5 feet from the bottom of the facility to native material and infiltration into shallow fill is approved by a geotechnical professional.
- Tributary area land uses include open areas adjacent to parking lots, driveways, and buildings, and roadway medians and shoulders.

OC-Specific Design Criteria and Considerations

- Must comply with local, state, and federal UIC regulations if applicable; a permit may be required.

- Placement of BMPs should observe geotechnical recommendations with respect to geological hazards (e.g. landslides, liquefaction zones, erosion, etc.) and set-backs (e.g., foundations, utilities, roadways, etc.)
- For facilities with tributary area less than 1 acre and less than 3 foot depth, minimum separation to mounded seasonally high groundwater of 5 feet shall be observed.
- For facilities with tributary area greater than 1 acre or deeper than 3 feet, minimum separation to mounded seasonally high groundwater of 10 feet shall be observed.
- Minimum pretreatment should be provided upstream of the infiltration trench, and water bypassing pretreatment should not be directed to the infiltration trench.
- Infiltration trenches should not be used for drainage areas with high sediment production potential unless preceded by full treatment control with a BMP effective for sediment removal.
- Ponded water should not persist within 1 foot of the surface of the facility for longer than 72 hours following the end of a storm event (observation well is needed to allow observation of drain time).
- Energy dissipators should be provided at inlet and outlet to prevent erosion.
- An overflow device must be provided if basin is on-line.
- A minimum freeboard of one foot should be provided above the overflow device (for an on-line basin) or the outlet (for an off-line basin).
- Longitudinal trench slope should not exceed 3%.
- Side slopes above trench fill should not be steeper than 3:1.

Simple Sizing Method for Infiltration Trenches

If the Simple Design Capture Volume Sizing Method is used to size an infiltration trench, the user calculates the DCV and then designs the geometry required to draw down the DCV in 48 hours. The sizing steps are as follows:

Step 1: Determine Infiltration Basin DCV

Calculate the DCV using the Simple Design Capture Volume Sizing Method described in **Appendix III.3.1**.

Step 2: Determine the 48-hour Effective Depth

The depth of water that can be drawn down in 48 hours can be calculated using the following equation:

$$d_{48} = K_{\text{DESIGN}} \times \text{SACF} \times 48 \text{ hours}$$

Where:

d_{48} = trench effective 48-hour depth, ft

K_{DESIGN} = basin design infiltration rate, in/hr (See **Appendix VII**)

SACF = Surface Area Correction Factor = ranges from 1.0 (sides insignificant or not accounted) to 2.0 (sides plus bottom are 2 times the surface area of the bottom at mid depth) to account for the ratio of infiltration through the sides of the trench to the bottom footprint of the trench; should be based on anticipated trench geometry and wetted surface area at mid-depth.

This is the maximum effective depth of the trench below the overflow device to achieve drawdown in 48 hours.

Step 3: Determine the Trench Ponding Depth and Trench Depth

The depth of water stored in the ponding depth (i.e. above the trench fill) and within the trench itself should be equal or less than d_{48} . Determine the ponding depth and the trench fill depth such that:

$$d_{48} \geq (n_T \times d_T + d_P)$$

Where:

d_{48} = trench effective 48-hour depth, ft (from Step 2)

n_T = porosity of trench fill; 0.35 may be assumed where other information is not available

d_T = depth of trench fill, ft

d_P = ponding depth, ft (should not exceed 1 ft)

Step 4: Calculate the Required Infiltrating Area

The required footprint area can be calculated using the following equation:

$$A = DCV / ((n_T \times d_T) + d_P)$$

Where:

A = required trench footprint area, sq-ft

DCV = design capture volume, cu-ft (see Step 1)

n_T = porosity of trench fill; 0.35 may be assumed where other information is not available

d_T = depth of trench fill, ft

d_P = ponding depth, ft

Capture Efficiency Method for Infiltration Trenches

If BMP geometry has already been defined and deviates from the 48 hour drawdown time, the designer can use the Capture Efficiency Method for Volume-Based, Constant Drawdown BMPs ([Appendix III.3.2](#)) to determine the fraction of the DCV that must be provided to manage 80 percent of average annual runoff volume. This method accounts for drawdown time different than 48 hours.

Step 1: Determine the drawdown time associated with the selected trench geometry

$$DD = ((n_T \times d_T) + d_P) / (K_{DESIGN} \times SACF) \times 12$$

Where:

DD = time to completely drain infiltration basin ponding depth, hours

n_T = porosity of trench fill; 0.35 may be assumed where other information is not available

d_T = depth of trench fill, ft

d_P = ponding depth, ft

SACF = Surface Area Correction Factor = ranges from 1.0 (sides insignificant or not accounted) to 2.0 (sides plus bottom are 2 times the surface area of the bottom at mid depth) to account for the ratio of infiltration through the sides of the trench to the bottom footprint of the trench; should be based on anticipated trench geometry and wetted surface area at mid-depth.

K_{DESIGN} = basin design infiltration rate, in/hr (See [Appendix VII](#))

Step 2: Determine the Required Adjusted DCV for this Drawdown Time

Use the Capture Efficiency Method for Volume-Based, Constant Drawdown BMPs ([Appendix III.3.2](#)) to calculate the required fraction of the DCV the basin must hold to achieve 80 percent capture of average annual stormwater runoff volume based on the trench drawdown time calculated above.

Step 3: Determine the Trench Infiltrating Area Needed

The required footprint area can be calculated using the following equation:

$$A = DCV / ((n_T \times d_T) + d_p)$$

Where:

A = required trench footprint area, sq-ft

DCV = design capture volume, cu-ft (see Step 1)

n_T = porosity of trench fill; 0.35 may be assumed where other information is not available

d_T = depth of trench fill, ft

d_p = ponding depth, ft

If the area required is greater than the selected trench area, adjust surface area or adjust ponding and/or trench depth and recalculate required area until the required area is achieved.

Configuration for Use in a Treatment Train

- Infiltration trenches may be preceded in a treatment train by HSCs in the drainage area, which would reduce the required volume of the trench.
- Infiltration trenches must be preceded by some form of pretreatment which may be biotreatment or a treatment control BMP; if an approved biotreatment BMP is used as pretreatment, the overflow from the infiltration trench may be considered “biotreated” for the purposes of meeting the LID requirements
- The overflow or bypass from an infiltration trench can be routed to a downstream biotreatment BMP and/or a treatment control BMP if additional control is required to achieve LID or treatment control requirements

Additional References for Design Guidance

- CASQA BMP Handbook for New and Redevelopment:
<http://www.cabmphandbooks.com/Documents/Development/TC-10.pdf>
- SMC LID Manual (pp 141):
http://www.lowimpactdevelopment.org/guest75/pub/All_Projects/SoCal_LID_Manual/SoCalLID_Manual_FINAL_040910.pdf
- Los Angeles County Stormwater BMP Design and Maintenance Manual, Chapter 6:
http://dpw.lacounty.gov/DES/design_manuals/StormwaterBMPDesignanddrainageareaintenance.pdf
- City of Portland Stormwater Management Manual (Soakage Trenches, page 2-82)
<http://www.portlandonline.com/bes/index.cfm?c=47954&a=202883>
- San Diego County LID Handbook Appendix 4 (Factsheet 1):
<http://www.sdcounty.ca.gov/dplu/docs/LID-Appendices.pdf>

INF-3: Bioretention with no Underdrain

Bioretention stormwater treatment facilities are landscaped shallow depressions that capture and filter stormwater runoff. These facilities function as a soil and plant-based filtration device that removes pollutants through a variety of physical, biological, and chemical treatment processes. The facilities normally consist of a ponding area, mulch layer, planting soils, and plants. As stormwater passes down through the planting soil, pollutants are filtered, adsorbed, and biodegraded by the soil and plants. For areas with low permeability native soils or steep slopes, bioretention areas can be designed with an underdrain system that routes the treated runoff to the storm drain system rather than depending entirely on infiltration.



Feasibility Screening Considerations

- Bioretention with no underdrains shall pass infiltration infeasibility screening criteria to be considered for use.

Opportunity Criteria

- Land use may include commercial, residential, mixed use, institutional, and subdivisions. Bioretention may also be applied in parking lot islands, cul-de-sacs, traffic circles, road shoulders, and road medians.
- Drainage area is ≤ 5 acres, preferably ≤ 1 acre.
- Area available for infiltration.
- Soils are adequate for infiltration or can be amended to improve infiltration capacity. Site slope is less than 15 percent.

OC-Specific Design Criteria and Considerations

- Placement of BMPs should observe geotechnical recommendations with respect to geological hazards (e.g. landslides, liquefaction zones, erosion, etc.) and set-backs (e.g., foundations, utilities, roadways, etc.)
- Depth to mounded seasonally high groundwater shall not be less than 5 feet.
- If sheet flow is conveyed to the treatment area over stabilized grassed areas, the site must be graded in such a way that minimizes erosive conditions; sheet flow velocities should not exceed 1 foot per second.
- Ponding depth should not exceed 18 inches; fencing may be required if ponding depth exceeds 6 inches to mitigate the risk of drowning.
- Planting/storage media shall be based on the recommendations contained in MISC-1: Planting/Storage Media
- The minimum amended soil depth is 1.5 feet (3 feet is preferred).
- The maximum drawdown time of the planting soil is 48 hours.

- Infiltration pathways may need to be restricted due to the close proximity of roads, foundations, or other infrastructure. A geomembrane liner, or other equivalent water proofing, may be placed along the vertical walls to reduce lateral flows. This liner should have a minimum thickness of 30 mils.
- Plant materials should be tolerant of summer drought, ponding fluctuations, and saturated soil conditions for 48 hours; native plant species and/or hardy cultivars that are not invasive and do not require chemical fertilizers or pesticides should be used to the maximum extent feasible.
- The bioretention area should be covered with 2-4 inches (average 3 inches) of mulch at startup and an additional placement of 1-2 inches of mulch should be added annually.
- An optional gravel drainage layer may be installed below planting media to augment storage volume.
- An overflow device is required at the top of the ponding depth.
- Dispersed flow or energy dissipation (i.e. splash rocks) for piped inlets should be provided at basin inlet to prevent erosion.

Simple Sizing Method for Bioretention with no Underdrain

If the Simple Design Capture Volume Sizing Method described in **Appendix III.3.1** is used to size a bioretention area with underdrains, the user calculates the DCV and designs the system with geometry required to draw down the DCV in 48 hours. The sizing steps are as follows:

Step 1: Determine the Bioretention Design Capture Volume

Calculate the DCV using the Simple Design Capture Volume Sizing Method described in **Appendix III.3.1**.

Step 2: Determine the 48-hour Ponding Depth

The depth of effective storage depth that can be drawn down in 48 hours can be calculated using the following equation:

$$d_{48} = K_{DESIGN} \times 4$$

Where:

d_{48} = bioretention 48-hour effective depth, ft

K_{DESIGN} = bioretention design infiltration rate, in/hr (See **Appendix VII**)

This is the maximum effective depth of the basin below the overflow device to achieve drawdown in 48 hours. Effective depth includes ponding water and media/aggregate pore space.

Step 3: Design System Geometry to Provide d_{48}

Design system geometry such that

$$d_{48} \geq d_{EFFECTIVE} = (d_P + n_M d_M + n_G d_G)$$

Where:

d_{48} = depth of water that can drain in 48 hours

$d_{EFFECTIVE}$ = total effective depth of water stored in bioretention area, ft

d_P = bioretention ponding depth, ft (should be less than or equal to 1.5 ft)

n_M = bioretention media porosity

d_M = bioretention media depth, ft

n_G = bioretention gravel layer porosity; 0.35 may be assumed where other information is not available

d_G = bioretention gravel layer depth, ft

Step 4: Calculate the Required Infiltrating Area

The required infiltrating area (i.e. measured at the media surface) can be calculated using the following equation:

$$A = DCV / d_{EFFECTIVE}$$

Where:

A = required infiltrating area, sq-ft (measured as the media surface area)

DCV = design capture volume, cu-ft (see Step 1)

$d_{EFFECTIVE}$ = total effective depth of water stored in bioretention area, ft (from Step 3)

This does not include the side slopes, access roads, etc. which would increase bioretention footprint.

Capture Efficiency Method for Bioretention with no Underdrain

If BMP geometry has already been defined and deviates from the 48 hour drawdown time, the designer can use the Capture Efficiency Method for Volume-Based, Constant Drawdown BMPs (See [Appendix III.3.2](#)) to determine the fraction of the DCV that must be provided to manage 80 percent of average annual runoff volume. This method accounts for drawdown time different than 48 hours.

Step 1: Determine the drawdown time associated with the selected basin geometry

$$DD = (d_{EFFECTIVE} / K_{DESIGN}) \times 12 \text{ in/ft}$$

Where:

DD = time to completely drain infiltration basin ponding depth, hours

$$d_{EFFECTIVE} \leq (d_P + n_M d_M + n_G d_G)$$

d_P = bioretention ponding depth, ft (should be less than or equal to 1.5 ft)

n_M = bioretention media porosity

d_M = bioretention media depth, ft

n_G = bioretention gravel layer porosity; 0.35 may be assumed where other information is not available

d_G = bioretention gravel layer depth, ft

K_{DESIGN} = basin design infiltration rate, in/hr (See [Appendix VII](#))

Step 2: Determine the Required Adjusted DCV for this Drawdown Time

Use the Capture Efficiency Method for Volume-Based, Constant Drawdown BMPs (See [Appendix III.3.2](#)) to calculate the fraction of the DCV the basin must hold to achieve 80 percent capture of average annual stormwater runoff volume based on the basin drawdown time calculated above.

Step 4: Check that the Bioretention Effective Depth Drains in no Greater than 96 Hours

$$DD = (d_{EFFECTIVE} / K_{DESIGN}) \times 12$$

Where:

DD = time to completely drain bioretention facility, hours

$d_{EFFECTIVE}$ = total effective depth of water stored in bioretention area, ft (from Step 3)

K_{DESIGN} = basin design infiltration rate, in/hr (See [Appendix VII](#))

If DD_{ALL} is greater than 96 hours, adjust bioretention media depth and/or gravel layer depth until DD is less than 96 hours. This duration is based on preventing extended periods of saturation from causing plant mortality.

Step 5: Determine the Basin Infiltrating Area Needed

The required infiltrating area (i.e. the surface area of the top of the media layer) can be calculated using the following equation:

$$A = DCV / d_{EFFECTIVE}$$

Where:

A = required infiltrating area, sq-ft (measured at the media surface)

DCV = design capture volume, adjusted for drawdown time, cu-ft (see Step 1)

$d_{EFFECTIVE}$ = total effective depth of water stored in bioretention area, ft (from Step 3)

This does not include the side slopes, access roads, etc. which would increase bioretention footprint. If the area required is greater than the selected basin area, adjust surface area or adjust ponding depth and recalculate required area until the required area is achieved.

Configuration for Use in a Treatment Train

- Bioretention areas may be preceded in a treatment train by HSCs in the drainage area, which would reduce the required volume of the bioretention cell.
- Bioretention areas can be incorporated in a treatment train to provide enhanced water quality treatment and reductions in runoff volume and rate. For example, runoff can be collected from a roadway in a vegetated swale that then flows to a bioretention area. Similarly, bioretention could be used to manage overflow from a cistern.

Additional References for Design Guidance

- CASQA BMP Handbook for New and Redevelopment:
<http://www.cabmphandbooks.com/Documents/Development/TC-32.pdf>
 - SMC LID Manual (pp 68):
http://www.lowimpactdevelopment.org/guest75/pub/All_Projects/SoCal_LID_Manual/SoCal_LID_Manual_FINAL_040910.pdf
 - Los Angeles County Stormwater BMP Design and Maintenance Manual, Chapter 5:
http://dpw.lacounty.gov/DES/design_manuals/StormwaterBMPDesignandMaintenance.pdf
 - San Diego County LID Handbook Appendix 4 (Factsheet 7):
<http://www.sdcounty.ca.gov/dplu/docs/LID-Appendices.pdf>
 - Los Angeles Unified School District (LAUSD) Stormwater Technical Manual, Chapter 4.
http://www.laschools.org/employee/design/fs-studies-and-reports/download/white_paper_report_material/Storm_Water_Technical_Manual_2009-opt-red.pdf?version_id=76975850
- County of Los Angeles Low Impact Development Standards Manual, Chapter 5:
http://dpw.lacounty.gov/wmd/LA_County_LID_Manual.pdf

INF-4: Bioinfiltration Fact Sheet

Bioinfiltration facilities are designed for partial infiltration of runoff and partial biotreatment. These facilities are similar to bioretention devices with underdrains but they include a raised underdrain above a gravel sump designed to facilitate infiltration. These facilities can be used in areas where there are no hazards associated with infiltration, but infiltration of the full DCV may not be feasible due to low infiltration rates or high depths of fill. These facilities may not result in retention of the full DCV but they can be used to achieve the maximum feasible infiltration and ET.

<i>Also known as:</i>
<ul style="list-style-type: none"> ➤ <i>Rain gardens</i> ➤ <i>Infiltration planter</i>

<p>Bioretention Source: Geosyntec Consultants</p>

Feasibility Screening Considerations

- Bioinfiltration shall pass infeasibility screening criteria for infiltration BMPs ([TGD Section 2.4.2.4](#)) to be considered for use.
- Infiltration rates are allowed to be less than 0.3 inches per hour.

Opportunity Criteria

- Land use may include commercial, residential, mixed use, institutional, and subdivisions. Bioretention may also be applied in parking lot islands, cul-de-sacs, traffic circles, road shoulders, and road medians.
- Drainage area is ≤ 5 acres, preferably ≤ 1 acre.
- Area is available for infiltration.
- Site slope is less than 15 percent.

OC-Specific Design Criteria and Considerations

- Placement of BMPs should observe geotechnical recommendations with respect to geological hazards (e.g. landslides, liquefaction zones, erosion, etc.) and set-backs (e.g., foundations, utilities, roadways, etc.)
- Depth to mounded seasonally high groundwater shall not be less than 5 feet.
- If sheet flow is conveyed to the treatment area over stabilized grassed areas, the site must be graded in such a way that minimizes erosive conditions; sheet flow velocities should not exceed 1 foot per second.
- Ponding depth should not exceed 18 inches; fencing may be required if ponding depth exceeds 6 inches to mitigate the risk of drowning.
- Planting/storage media shall be based on the recommendations contained in MISC-1: Planting/Storage Media
- The minimum amended soil depth is 1.5 feet (3 feet is preferred).
- The depth of gravel below the underdrain elevation must be designed so that the effective depth that would infiltrate in 48 hours is stored in the gravel layer.
- Underdrain should be placed at the top of the gravel drainage layer to facilitate infiltration.

- Infiltration pathways may need to be restricted due to the close proximity of roads, foundations, or other infrastructure. A geomembrane liner, or other equivalent water proofing, may be placed along the vertical walls to reduce lateral flows. This liner should have a minimum thickness of 30 mils.
- Plant materials should be tolerant of summer drought, ponding fluctuations, and saturated soil conditions for 48 hours; native plant species and/or hardy cultivars that are not invasive and do not require chemical fertilizers or pesticides should be used to the maximum extent feasible
- The bioinfiltration area should be covered with 2-4 inches (average 3 inches) of mulch at startup and an additional placement of 1-2 inches of mulch should be added annually.
- An overflow device is required at the top of the ponding depth.
- Dispersed flow or energy dissipation (i.e. splash rocks) for piped inlets should be provided at basin inlet to prevent erosion.
- Planting/storage media shall be based on the recommendations contained in MISC-1: Planting/Storage Media
- Ponding area side slopes shall be 3H:1V.

Simple Sizing Method for Bioinfiltration

If the Simple Design Capture Volume Sizing Method described in **Appendix III.3.1** is used to size a bioinfiltration facility, the user selects the basin geometry and then determines the volume retained. The sizing steps are as follows:

Step 1: Select Bioinfiltration Geometry

Determine the desired ponding depth (not to exceed 1.5 ft), gravel depth, surface area, and media saturated hydraulic conductivity. A target media hydraulic conductivity of 5 inches per hour is recommended.

Step 2: Verify that the Ponding Depth will Draw Down within 48 Hours

The ponding area drawdown time can be calculated using the following equation:

$$DD_P = (d_P / K_{MEDI A}) \times 12$$

Where:

DD_P = time to drain ponded water, hours

$d_{EFFECTIVE}$ = total effective depth of water stored in bioretention area, ft (from Step 3)

$K_{MEDI A}$ = media design infiltration rate, in/hr (equivalent to the media hydraulic conductivity with a factor of safety of 2; $K_{MEDI A}$ of 2.5 in/hr should be used as a default unless other information is available to support an alternative value.)

If the drawdown time exceeds 48 hours, adjust ponding depth and/or media filter until 48 hour drawdown time is achieved.

Step 3: Verify That Gravel Depth is Designed for 48 Hour Drawdown

In order to demonstrate that bioinfiltration systems have been designed to achieve the maximum feasible retention (See **Appendix XI**), the gravel depth below the underdrains must be designed with a thickness such that it draws down in 48 hours.

$$DD_G = ((d_G \times n_G) / K_{DESIGN}) \times 12$$

Where:

DD_G = time to drain gravel layer, hours

n_G = bioretention gravel layer porosity; 0.35 may be assumed where other information is not available

d_G = bioretention gravel layer depth, ft

K_{DESIGN} = bioretention design infiltration rate, in/hr (See [Appendix VII](#))

If DD_G is less than 48 hours, adjust d_G until DD_G is at least 48 hours or greater.

Step 4: Determine the BMP Area Needed

The required infiltrating area (i.e. the surface area of the top of the media layer) can be calculated using the following equation:

$$A = DCV / d_{EFFECTIVE}$$

Where:

A = required infiltrating area, sq-ft (measured at the media surface)

DCV = design capture volume, cu-ft (see Step 1)

$d_{EFFECTIVE}$ = total effective depth of water stored in bioretention area, ft

$$d_{EFFECTIVE} = (d_P + n_M d_M + n_G d_G)$$

d_P = bioretention ponding depth, ft (should be less than or equal to 1.5 ft)

n_M = bioretention media porosity

d_M = bioretention media depth, ft

n_G = bioretention gravel layer porosity; 0.35 may be assumed where other information is not available

d_G = bioretention gravel layer depth, ft

This does not include the side slopes, access roads, etc. which would increase bioretention footprint. If the area required is greater than the selected basin area, adjust surface area or adjust ponding depth and recalculate required area until the required area is achieved.

Capture Efficiency Method for Bioinfiltration

Option 1: Accounting for Retention plus Biotreatment in Capture Efficiency Calculation

To size bioinfiltration facilities using the Capture Efficiency Method, the system should be divided into its retention and biotreatment components and analyzed as a treatment train per instructions in [Appendix III.5 Sizing Approaches for Treatment Trains and Hybrid Systems](#).

- Retention Storage: Water stored in gravel below underdrains.
- Biotreatment Storage: Water stored in surface ponding and media pore space.

The retention component should be analyzed as the first component of the treatment train, and will yield a capture efficiency that is used as an input to the biotreatment sizing approach.

The retention component should be sized such that the depth of gravel drains in 48 hours at the design infiltration rate.

Option 2: Sizing of Biotreatment Only; Presumptive Approach for Retention

Alternatively, bioinfiltration BMPs can be sized accounting for only the capture efficiency of the biotreatment component (See BIO-1: Bioretention with Underdrains for sizing methods). The retention component should be sized such that the depth of gravel drains in 48 hours or greater at the design infiltration rate. This provides presumption that water is infiltrated without quantifying the volume that is infiltrated. It is inherently a conservative sizing method.

Configuration for Use in a Treatment Train

- Bioinfiltration areas are inherently a treatment train BMP because they include both retention and biotreatment components.
- Bioinfiltration areas may be preceded in a treatment train by HSCs in the drainage area, which would reduce the required volume of the bioretention cell.
- Bioinfiltration areas can be incorporated in a treatment train to provide enhanced water quality treatment and reductions in runoff volume and rate.

Additional References for Design Guidance

- CASQA BMP Handbook for New and Redevelopment:
<http://www.cabmphandbooks.com/Documents/Development/TC-32.pdf>
- SMC LID Manual (pp 68):
http://www.lowimpactdevelopment.org/guest75/pub/All_Projects/SoCal_LID_Manual/SoCalLID_Manual_FINAL_040910.pdf
- Los Angeles County Stormwater BMP Design and Maintenance Manual, Chapter 5:
http://dpw.lacounty.gov/DES/design_manuals/StormwaterBMPDesignandMaintenance.pdf
- San Diego County LID Handbook Appendix 4 (Factsheet 7):
<http://www.sdcounty.ca.gov/dplu/docs/LID-Appendices.pdf>
- Los Angeles Unified School District (LAUSD) Stormwater Technical Manual, Chapter 4:
http://www.laschools.org/employee/design/fs-studies-and-reports/download/white_paper_report_material/Storm_Water_Technical_Manual_2009-opt-red.pdf?version_id=76975850
- County of Los Angeles Low Impact Development Standards Manual, Chapter 5:
http://dpw.lacounty.gov/wmd/LA_County_LID_Manual.pdf

INF-5: Drywell

Drywells are similar to infiltration trenches in their design and function, but generally have a greater depth to footprint area ratio and can be installed at relatively large depths. A drywell is a subsurface storage facility designed to temporarily store and infiltrate runoff, primarily from rooftops or other impervious areas with low pollutant loading. A drywell may be either a small excavated pit filled with aggregate or a prefabricated storage chamber or pipe segment. Drywells can be used to reduce the volume of runoff from roofs and other relatively clean surfaces. While roofs are generally not a significant source of stormwater pollutants, they can be a major contributor of runoff volumes. Therefore, drywells can indirectly enhance water quality by reducing the water quality design volume that must be treated by other, downstream stormwater management facilities. *Note: A drywell is considered a "Class V Injection Wells" under the federal Underground Injection Control (UIC) Program regulated in California by U.S. EPA Region 9. A UIC permit may be required (for details see <http://www.epa.gov/region9/water/groundwater/uic-classv.html>).*

<i>Also known as:</i>
<ul style="list-style-type: none"> ➤ Soakaway Pits ➤ Infiltration Sumps ➤ Rock Sumps ➤ Underground Injection Controls

<p>Drywell Source: K&A Enterprises</p>

Feasibility Screening Considerations

- Drywells shall pass infiltration infeasibility screening criteria ([TGD Section 2.4.2.4](#)) to be considered for use.
- Dry wells provide a more direct pathway for stormwater to groundwater, therefore pose a greater risk to groundwater quality than surface infiltration systems.

Opportunity Criteria

- Drywells may be used to infiltrate roof runoff, either directly or from the overflow from a cistern.
- Soils are adequate for infiltration or can be amended to provide an adequate infiltration rate.
- Space available for pretreatment (biotreatment or treatment control BMP as described below).
- The drywell must be located in native soil; over-excavated by at least one foot in depth and replaced uniformly without compaction.
- Potential for groundwater contamination can be mitigated through isolation of pollutant sources, pretreatment of inflow, and/or demonstration of adequate treatment capacity of underlying soils.
- Infiltration is into native soil, or depth of engineered fill is ≤ 5 feet from the bottom of the facility to native material and infiltration into fill is approved by a geotechnical professional.

OC-Specific Design Criteria and Considerations

- Must comply with local, state, and federal UIC regulations; a permit may be required.
- Minimum set-backs from foundations and slopes should be observed

- Infiltration should not cause geotechnical concerns related to slope stability, liquefaction, or erosion.
- Minimum separation to mounded seasonally high groundwater of 10 feet shall be observed.
- Drywells should not receive untreated stormwater runoff, except rooftop runoff. Pretreatment of runoff from other surfaces is necessary to prevent premature failure that results from clogging with fine sediment, and to prevent potential groundwater contamination due to nutrients, salts, and hydrocarbons.
- Design infiltration rate should be determined with an infiltration test at each drywell location.
- Drywell should be encased by 1 foot of coarse (3/4" to 2 1/2"), round river rock on sides and bottom of facility.
- Maximum facility depth is 25 feet with the approval of a geotechnical professional; preferred depth less than 10 feet does not require geotechnical approval.
- If inlet is an underground pipe, a fine mesh screen should be installed to prevent coarse solids from entering drywell.
- An overflow route must be installed for flows that overtop facility.

Sizing Criteria for Drywells

Drywell sizing is highly site-specific. Sizing calculations shall demonstrate via the methods described in [Appendix III](#) or via project-specific methods that the system captures and fully discharges the DCV within 48 hours following the end of precipitation, or captures and infiltrates 80 percent of average annual runoff volume.

Configuration for Use in a Treatment Train

- Drywells may be preceded in a treatment train by HSCs in the drainage area, which would reduce the required volume of the drywell.
- Drywells treating any areas other than roof tops must be preceded by a robust biotreatment or conventional treatment capable of addressing all potentially generated pollutants.
- Drywells may be used in conjunction with other infiltration BMPs to increase the infiltration capacity of the entire treatment train system.

Additional References for Design Guidance

- Stormwater Management in Western Washington (Volume III: Hydrologic Analysis and Flow Control Design BMPs) <http://www.ecy.wa.gov/pubs/0510031.pdf>
- Los Angeles Unified School District (LAUSD) Stormwater Technical Manual, Chapter 4: http://www.laschools.org/employee/design/fs-studies-and-reports/download/white_paper_report_material/Storm_Water_Technical_Manual_2009-opt-red.pdf?version_id=76975850
- City of Portland Stormwater Management Manual (Drywell, page 2-87) <http://www.portlandonline.com/bes/index.cfm?c=47954&a=202883>
- San Diego County LID Handbook Appendix 4 (Factsheet 25): <http://www.sdcounty.ca.gov/dplu/docs/LID-Appendices.pdf>
- City of Santa Barbara Storm Water BMP Guidance Manual, Chapter 6: http://www.santabarbaraca.gov/NR/rdonlyres/91D1FA75-C185-491E-A882-49EE17789DF8/0/Manual_071008_Final.pdf

INF-6: Permeable Pavement (concrete, asphalt, and pavers)

Permeable pavements contain small voids that allow water to pass through to a gravel base. They come in a variety of forms; they may be a modular paving system (concrete pavers, grass-pave, or gravel-pave) or poured in place pavement (porous concrete, permeable asphalt). All permeable pavements treat stormwater and remove sediments and metals to some degree within the pavement pore space and gravel base. While conventional pavement result in increased rates and volumes of surface runoff, properly constructed and maintained porous pavements, allow stormwater to percolate through the pavement and enter the soil below. This facilitates groundwater recharge while providing the structural and functional features needed for the roadway, parking lot, or sidewalk. The paving surface, subgrade, and installation requirements of permeable pavements are more complex than those for conventional asphalt or concrete surfaces. For porous pavements to function properly over an expected life span of 15 to 20 years, they must be properly sited and carefully designed and installed, as well as periodically maintained. Failure to protect paved areas from construction-related sediment loads can result in their premature clogging and failure.

<p><i>Also known as:</i></p> <ul style="list-style-type: none"> ➤ <i>Pervious pavement</i> ➤ <i>Porous concrete</i> ➤ <i>Pavers</i> ➤ <i>Permeable asphalt</i>

<p>Permeable Pavement Source: Geosyntec Consultants</p>

Feasibility Screening Considerations

- Permeable pavement shall pass infiltration infeasibility screening to be considered for use.
- Permeable pavements pose a potential risk of groundwater contamination; they may not provide significant attenuation of stormwater pollutants if underlying soils have high permeability.

Opportunity Criteria

- Permeable pavement areas can be applied to individual lot driveways, walkways, parking lots, low-traffic roads, high-traffic (with low speeds) roads/lots, golf cart paths, within road right-of-ways, and in parks and along open space edges. Impervious surfaces draining to the BMP are limited to surfaces immediately adjacent to the permeable pavement, rooftop runoff, and other nearby surfaces that do not contain significant sediment loads.
- Soils are adequate for infiltration or can be amended to provide an adequate infiltration rate.
- Infiltration is into native soil, or depth of engineered fill is ≤ 5 feet from the bottom of the facility to native material and infiltration into fill is approved by a geotechnical professional.

OC-Specific Design Criteria and Considerations

- Placement of BMPs should observe geotechnical recommendations with respect to geological hazards (e.g. landslides, liquefaction zones, erosion, etc.) and set-backs (e.g., foundations, utilities, roadways, etc)
- Minimum separation to mounded seasonally high groundwater of 5 feet shall be observed.

- A biotreatment BMP should be provided for all runoff from off-site sources that are not directly adjacent to the permeable pavement, with the exception of rooftops.
- Permeable pavement should not be used for drainage areas with high sediment production potential (e.g., landscape areas) unless preceded by full treatment control with a BMP effective for sediment removal
- All aggregate used to construct permeable pavement shall be thoroughly washed before being delivered to the construction site.
- The top or wearing layer course (permeable pavement course) should consist of asphalt or concrete with greater than normal percentage of voids, or paving stones.
- A layer of washed fine aggregate (e.g., No. 8) just under the permeable pavement course may be installed to provide a level surface for installing the permeable pavement and also acts as a filter to trap particles and help prevent the reservoir layer from clogging. This layer can also act as interstitial media between pavers.
- Below this layer, the bedding and filter course course should be 1.5 to 3 inches deep and may be underlain by choking stone to prevent the smaller sized aggregate from migrating into the large aggregate base layer.
- The bedding, filter, and choke stone layers, as applicable, are referred to collectively as the bedding and filter course.
- The aggregate reservoir layer should be designed to function as a support layer as well as a reservoir layer the reservoir layer should be washed, open-graded No. 57 aggregate without any fine sands.
- The type of pedestrian traffic should be considered when determining which type of permeable pavement to use in particular locations (e.g., pavers may not be a good option for locations where people wearing high heels will be walking).
- An overflow device is required in the form of perimeter control or overflow pipes. This should generally be set at an elevation to prevent ponding of water into the bedding and filter course.

Figure XIV.1: Schematic Diagram of Permeable Pavement without Underdrains

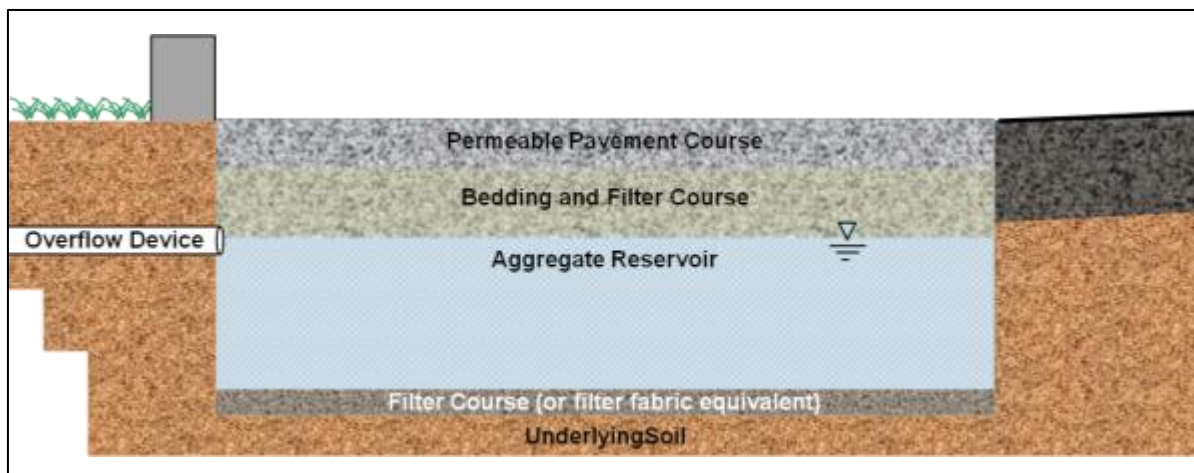

Simple Sizing Method for Permeable Pavement

Permeable pavement that manages only direct rainfall and runoff from adjacent impermeable surfaces less than 50 percent the size of the permeable pavement are not required to conduct sizing calculations. These areas are assumed to be self-retaining for the purpose of drainage planning. For permeable pavement with larger tributary area ratios, sizing calculations must be performed.

If the Simple Design Capture Volume Sizing Method described in **Appendix III.3.1** is used to size permeable pavement, the user calculates the DCV, designs the geometry required to draw down the DCV in 48 hours, then determines the area that is needed for the BMP. The area of the porous pavement itself as well as the area of the tributary areas should be considered in calculating the DCV. The sizing steps are as follows:

Step 1: Determine Permeable Pavement DCV

Calculate the DCV using the Simple Design Capture Volume Sizing Method described in **Appendix III.3.1**.

Step 2: Determine the 48-hour Effective Depth

The depth of water that can be drawn down in 48 hours can be calculated using the following equation:

$$d_{48} = K_{DESIGN} \times 48 \text{ hours} \times 1 \text{ ft}/12 \text{ inches}$$

Where:

d_{48} = pavement effective 48-hour drawdown depth, ft

K_{DESIGN} = basin design infiltration rate, in/hr (See **Appendix VII**)

This is the maximum effective depth of water storage in the aggregate reservoir to achieve drawdown in 48 hours.

Step 3: Determine the Aggregate Reservoir Depth

The depth of water stored in the gravel reservoir should be equal or less than d_{48} . Determine the reservoir depth such that:

$$d_{48} \geq (n_R \times d_R)$$

Where:

d_{48} = trench effective 48-hour depth, ft (from Step 2)

n_R = porosity of aggregate reservoir fill; 0.35 may be assumed where other information is not available

d_R = depth of trench fill, ft

Step 4: Calculate the Required Infiltrating Area

The required infiltrating area can be calculated using the following equation:

$$A = DCV / (n_R \times d_R)$$

Where:

A = required footprint area, sq-ft

DCV = design capture volume, cu-ft (see Step 1)

n_R = porosity of trench fill; 0.35 may be assumed where other information is not available

d_R = depth of trench fill, ft

This area is equal to the required pavement area.

The ratio total tributary area (including the porous pavement) to the area of the porous pavement should not exceed 4:1.

Capture Efficiency Method for Permeable Pavement

If BMP geometry has already been defined and deviates from the 48 hour drawdown time, the designer can use the Capture Efficiency Method for Volume-Based, Constant Drawdown BMPs (See **Appendix III.3.2**) to determine the fraction of the DCV that must be provided to manage 80 percent of average annual runoff volume. This method accounts for drawdown time different than 48 hours.

Option 1: Pavement Geometry is Predefined

Step 1: Determine the Drawdown Time Associated with the Selected Pavement Geometry

$$DD = ((n_R \times d_R) / K_{DESIGN}) \times 12 \text{ in/ft}$$

Where:

DD = time to completely drain pavement, hours

n_R = porosity of reservoir fill; 0.35 may be assumed where other information is not available

d_R = depth of reservoir, ft

K_{DESIGN} = basin design infiltration rate, in/hr (See **Appendix VII**)

Step 2: Determine the Required Adjusted DCV for this Drawdown Time

Use the Capture Efficiency Method for Volume-Based, Constant Drawdown BMPs (See **Appendix III.3.2**) to calculate the draw-down adjusted DCV that the basin must hold to achieve 80 percent capture of average annual stormwater runoff volume based on the pavement drawdown time calculated above.

Step 3: Determine the Pavement Infiltrating Area Needed

The required infiltrating area can be calculated using the following equation:

$$A = DCV / (n_R \times d_R)$$

Where:

A = required footprint area, sq-ft

DCV = design capture volume, cu-ft (see Step 1)

n_R = porosity of reservoir fill; 0.35 may be assumed where other information is not available

d_R = depth of reservoir, ft

If the area required is greater than the selected pavement area, adjust reservoir depth and recalculate required area until the required area is achieved.

Configuration for Use in a Treatment Train

- Permeable pavement may be preceded in a treatment train by HSCs in the drainage area, which would reduce the runoff volume to be infiltrated by the permeable pavement
- Permeable pavement areas can be designed to be self-retaining to lessen the pollutant and volume load on downstream BMPs.

Additional References for Design Guidance

- SMC LID Manual (pp 84):
http://www.lowimpactdevelopment.org/guest75/pub/All_Projects/SoCal_LID_Manual/SoCal_ID_Manual_FINAL_040910.pdf

- Los Angeles Unified School District (LAUSD) Stormwater Technical Manual, Chapter 5:
http://www.laschools.org/employee/design/fs-studies-and-reports/download/white_paper_report_material/Storm_Water_Technical_Manual_2009-opt-red.pdf?version_id=76975850
- City of Portland Stormwater Management Manual (Pervious Pavement, page 2-40)
<http://www.portlandonline.com/bes/index.cfm?c=47954&a=202883>
San Diego County LID Handbook Appendix 4 (Factsheets 8, 9 & 10):
<http://www.sdcounty.ca.gov/dplu/docs/LID-Appendices.pdf>
City of Santa Barbara Storm Water BMP Guidance Manual, Chapter 6:
http://www.santabarbaraca.gov/NR/rdonlyres/91D1FA75-C185-491E-A882-49EE17789DF8/0/Manual_071008_Final.pdf
County of Los Angeles Low Impact Development Standards Manual, Chapter 5:
http://dpw.lacounty.gov/wmd/LA_County_LID_Manual.pdf

INF-7: Underground Infiltration

Underground infiltration is a vault or chamber with an open bottom that used to store runoff and percolate into the subsurface. A number of vendors offer proprietary infiltration products that allow for similar or enhanced rates of infiltration and subsurface storage while offering durable prefabricated structures. There are many varieties of proprietary infiltration BMPs that can be used for roads and parking lots, parks and open spaces, single and multi-family residential, or mixed-use and commercial uses.



Also known as:

- *Infiltration vault*
- *Recharge vault*

Underground Infiltration

Source: <http://www.contech-cpi.com>

Feasibility Screening Considerations

- Infiltration bays shall pass infeasible screening criteria to be considered for use.
- Underground infiltration galleries pose a potential risk of groundwater contamination; pretreatment should be used.

Opportunity Criteria

- Soils are adequate for infiltration or can be amended to provide an adequate infiltration rate.
- Appropriate for sites with limited surface space.
- Can be placed beneath roads, parking lots, parks, and athletic fields.
- Potential for groundwater contamination can be mitigated through isolation of pollutant sources, pretreatment of inflow, and/or demonstration of adequate treatment capacity of underlying soils.
- Infiltration is into native soil, or depth of engineered fill is ≤ 5 feet from the bottom of the facility to native material and infiltration into fill is approved by a geotechnical professional.
- Tributary area land uses include mixed-use and commercial, single-family and multi-family, roads and parking lots, and parks and open spaces. High pollutant land uses should not be tributary to infiltration BMPs.

OC-Specific Design Criteria and Considerations

- Placement of BMPs should observe geotechnical recommendations with respect to geological hazards (e.g. landslides, liquefaction zones, erosion, etc.) and set-backs (e.g., foundations, utilities, roadways, etc.)
- Minimum separation to mounded seasonally high groundwater of 10 feet shall be observed.
- Minimum pretreatment should be provided upstream of the infiltration facility, and water bypassing pretreatment should not be directed to the facility.
- Underground infiltration should not be used for drainage areas with high sediment production potential unless preceded by full treatment control with a BMP effective for sediment removal.
- Design infiltration rate should be determined as described in [Appendix VII](#).
- Inspection ports or similar design features shall be provided to verify continued system performance and identify need for major maintenance.

- For infiltration facilities beneath roads and parking areas, structural requirements should meet H-20 load requirements.

Computing Underground Infiltration Device Size

Underground infiltration devices vary by design and by proprietary designs. The sizing method selected for use must be based on the BMP type it most strongly resembles.

- For underground infiltration devices with open pore volume (e.g., vaults, crates, pipe sections, etc), sizing will be most similar to infiltration basins.
- For underground infiltration devices with pore space (e.g., aggregate reservoirs), sizing will be most similar to permeable pavement.

Additional References for Design Guidance

- Los Angeles Unified School District (LAUSD) Stormwater Technical Manual, Chapter 5:
http://www.laschools.org/employee/design/fs-studies-and-reports/download/white_paper_report_material/Storm_Water_Technical_Manual_2009-opt-red.pdf?version_id=76975850

XIV.4. Harvest and Use BMP Fact Sheets (HU)

HU-1: Above-Ground Cisterns

Cisterns are large rain barrels. While rain barrels are less than 100 gallons, cisterns range from 100 to more than 10,000 gallons in capacity. Cisterns collect and temporarily store runoff from rooftops for later use as irrigation and/or other non-potable uses. The following components are generally required for installing and utilizing a cistern: (1) pipes that divert rooftop runoff to the cistern, (2) an overflow for when the cistern is full, (3) a pump, and (4) a distribution system to supply the intended end uses.

Feasibility screening consideration, opportunity criteria, design criteria, etc. for this BMP are listed below under HU-2: Underground Detention.

HU-2: Underground Detention

Underground detention facilities are subsurface tanks, vaults, or oversized pipes that store stormwater runoff. Similar to cisterns, underground detention facilities can store water for later use as irrigation and/or other non-potable uses.



Above-Ground Cisterns
Source: Sunset Publishing Corporation



Underground detention tank
Source: www.webtecgeos.com

Feasibility Screening Considerations

- The primary feasibility considerations for harvest and use systems for stormwater management is the presence of consistent and reliable demand that is sufficient to drain the systems relatively quickly between storms. [Appendix X](#) provides guidance for calculating harvested water demand.
- Use of harvested water should not conflict with applicable plumbing and health codes at the time of project application.

Opportunity Criteria

- Cisterns may collect rooftop runoff, and if located underground, may collect ground-level runoff.
- Cisterns may be installed in any type of land use provided space is available and adequate water demand exists.
- Stored water may supply non-potable water use demands such as irrigation and toilet flushing.
- Cisterns and underground detention facilities may also be used for peak flow control if active storage volume and hydraulic controls are provided above the retained storage or systems are operated with advanced controllers.

OC-Specific Design Criteria and Considerations for Above-Ground Cisterns

- Cistern systems should include prescreening in the form of screens on gutters and downspouts to remove vegetative debris and sediment from the runoff prior to entering the cistern.

- Above-ground cisterns should be secured in place and comply with applicable building codes.
- Above-ground cisterns should not be located on uneven or sloped surfaces; if installed on a sloped surface, the base where the cistern will be installed should be leveled and designed for the weight of the filled cistern prior to installation.
- Child-resistant covers and mosquito screens should be placed on all water entry holes.
- A first flush diverter may be installed so that initial runoff bypasses the cistern.
- Above-ground cisterns should be installed in a location with easy access for maintenance or replacement.
- Plumbing systems should be installed in accordance with the current California Building and Plumbing Codes (CBC – part of California Code of Regulations, Title 24).
When a potable water supply line is connected to a cistern system to provide dry-season make-up water, cross-contamination should be prevented by providing a backflow prevention system on the potable water supply line and/or an air gap.
- In cases where there is non-potable indoor use demand, proper pretreatment measures should be installed such as pre-filtration, cartridge filtration, and/or disinfection.

OC-Specific Design Criteria and Considerations for Underground Cisterns/Detention Systems

- Access entry covers (36" diameter minimum) should be locking and within 50 feet of all areas of the detention tank.
- In cases where the detention facility provides sediment containment, the facility should be laid flat and there should be at least ½ foot of dead storage within the tank or vault.
- Outlet structures should be designed using the 100-year storm as overflow and should be easily accessible for maintenance activities.
- For detention facilities beneath roads and parking areas, structural requirements should meet H-20 load requirements.
- In cases where shallow groundwater may cause flotation, buoyant forces should be counteracted with backfill, anchors, or other measures.
- Underground detention facilities should be installed on consolidated and stable native soil; if the facility is constructed in fill slopes, a geotechnical analysis should be performed to ensure stability.
- Plumbing systems should be installed in accordance with the current California Building and Plumbing Codes (CBC – part of California Code of Regulations, Title 24).
When a potable water supply line is connected to a cistern system to provide dry-season make-up water, cross-contamination should be prevented by providing a backflow prevention system on the potable water supply line and/or an air gap.
- In cases where there is non-potable indoor reuse demand, proper pretreatment measures should be installed such as pre-filtration, cartridge filtration, and/or disinfection.

Types of Harvested Water Demands

Harvested rainwater can be used for irrigation and other non-potable uses (if local, State, and Federal ordinances allow). The use of captured stormwater allows a reduced demand on the potable water supply.

Irrigation Use

- Subsurface (or drip) irrigation should not require disinfection pretreatment prior to use; other irrigation types, such as spray irrigation, may require additional pretreatment prior to use
- Selecting native and/or drought tolerant plants for landscaped area will reduce irrigation demand, thereby reducing the needed size of the storage facility and the amount of tributary area that can be successfully managed with a harvest and use system.

Indoor Use

- Indoor uses generally require filtration and disinfection and should only be considered if permitted by local, State, or Federal codes and ordinances.
- Domestic uses (single-family uses) may include toilet flushing.
- Offices, commercial developments, and industrial facility indoor uses may use cisterns for toilet and urinal flushing. Demands for these specific land uses are include in [Appendix X](#).
- Pretreatment requirements per local, State, or Federal codes and ordinances should be applied

Other Non-Potable Uses

- Other non-potable uses may include vehicle/equipment washing, evaporative cooling, industrial processes, and dilution water for recycled water systems (if local, State, and Federal ordinances allow)
- Pretreatment requirements per local, State, or Federal codes and ordinances should be applied

Harvested Water Demand Calculations and Feasibility Thresholds

[Appendix X](#) provides guidance for estimating harvesting water demand and determining whether demand is potentially sufficient to provide a significant benefit for stormwater management.

Simple Sizing Method for Cisterns

If the Simple Design Capture Volume Sizing Method described in [Appendix III.3.1](#) is used to size harvest and use systems, the user calculates the DCV and determines whether demand is sufficient to drain the tank in 48 hours following the end of rainfall. The sizing steps are as follows:

Step 1: Determine Cistern DCV

Calculate the DCV using the Simple Design Capture Volume Sizing Method described in [Appendix III.3.1](#). This is the required cistern size.

Step 2: Determine the 48-hour Required Demand

Calculate the daily demand needed to draw down the DCV in 48 hours using the following equation:

$$\text{Demand}_{48} = (\text{DCV}/2)*7.48$$

Where:

Demand₄₈ = daily demand required (gal/day)

DCV = design capture volume, cu-ft

Use the guidance in [Appendix X](#) determine the non-potable uses needed to generate the required demand.

Designing Cisterns to Achieve the Maximum Feasible Retention Volume

It is rare that cisterns can be sized to capture the full DCV and use this volume in 48 hours. However, if the demand exceeds minimum harvested water demand thresholds, cisterns should be sized to achieve at least 40 percent capture of average annual runoff volume.

Step 1: Determine if the Project Meets the Minimum Harvested Water Demand Thresholds

Determine the Project's design capture storm depth, then use the TUTIA thresholds table ([Appendix X](#)) for indoor uses, or the Irrigated Area thresholds table ([Appendix X](#)) for outdoor uses, to determine whether the project meets the minimum harvested water demand thresholds. If the project does not meet the minimum harvested water demand thresholds, harvest and use does not meet the minimum incremental benefit required to such that its use must be evaluated. .

If the project meets or exceeds the minimum harvested water demand thresholds, continue to Step 2 or Step 3 (equally-allowable pathways).

Step 2: Iteratively Determine the Cistern Volume for 80 percent capture of average annual stormwater runoff volume

Cisterns can be sized using the Capture Efficiency Method for Volume-Based, Constant Drawdown BMPs (See [Appendix III.3.2](#)). This approach requires an iterative sizing process in which the user selects the initial cistern size and the project harvested water demand, then calculates the time required for the cistern to drain. Based on the drain time, the cistern size is increased or decreased and the calculations are done again until the initially assumed size and the required size are within 10 percent.

- a. Calculate wet season harvested water demand using guidance contained in [Appendix X](#).
- b. Select cistern size in terms of the design rainfall depth.
- c. Calculate the cistern volume using hydrologic method described in [Appendix III.1.1](#).
- d. Compute the drawdown time of the cistern as:
$$\text{Drawdown Time (hr)} = [\text{Volume (cu-ft)} \times 7.48 \text{ gal/cu-ft} \times 24\text{hr/day}] / [\text{Demand (gpd)}]$$
- e. Based on design rainfall depth and drawdown time using guidance provided in [Appendix III](#) to calculate long term average capture efficiency.
- f. If capture is between 75 and 85 percent, further iterations are not required.
- g. If capture is less than 80 percent capture of average annual stormwater runoff volume, return to Step (b) and increase design rainfall depth.
- h. If capture is greater than 80 percent, return to Step (b) and increase design rainfall depth.

Step 3: Determine Cistern Volume and Drawdown to Achieve Maximum Practicable Capture Efficiency

The applicant is not required to provide a cistern greater than the DCV to demonstrate that BMPs have been designed to achieve the maximum feasible retention. The following steps should be used to compute the maximum feasible fraction of stormwater than can be retained with harvest and use BMPs:

- a. Calculate wet season harvested water demand using guidance contained in [Appendix X](#), accounting for all applicable demands.
- b. Calculate the DCV using hydrologic method described in [Appendix III.1.1](#) and size the cistern for this volume.

- c. Compute the drawdown time of the cistern as:
Drawdown Time (hr) = [Volume (cu-ft) × 7.48 gal/cu-ft × 24hr/day]/[Demand (gpd)]
- d. Based on 1.0 × design capture storm depth and the drawdown time computed in Step I, calculate the long term average capture efficiency using the Capture Efficiency Method for Volume-Based, Constant Drawdown BMPs (See **Appendix III.3.2**).
- e. If capture efficiency is less than 40 percent, harvest and use is not required to be considered for use on the project.
- f. If capture efficiency is greater than 40 percent, provide a cistern sized for the DCV and provide volume or flowrate to treat the remaining volume up to 80 percent total average annual capture using biotreatment BMP.

Configuration for Use in a Treatment Train

- Cisterns can be combined into a treatment train to provide enhanced water quality treatment and reductions in the runoff volume and rate. For example, if a green roof is placed upgradient of a cistern, the rate and volume of water flowing to the cistern can be reduced and the water quality enhanced.
- Cisterns can be incorporated into the landscape design of a site and can be aesthetically pleasing as well as functional for irrigation purposes.
- Treatment of the captured rainwater (i.e. disinfection) may be required depending on the end use of the water.
- Cisterns can be designed to overflow to biotreatment BMPs.

Additional References for Design Guidance

- Santa Barbara BMP Guidance Manual, Chapter 6:
http://www.santabarbaraca.gov/NR/rdonlyres/91D1FA75-C185-491E-A882-49EE17789DF8/0/Manual_071008_Final.pdf
 - County of Los Angeles Low Impact Development Standards Manual, Chapter 5:
http://dpw.lacounty.gov/wmd/LA_County_LID_Manual.pdf
 - SMC LID Manual (pp 114):
http://www.lowimpactdevelopment.org/guest75/pub/All_Projects/SoCal_LID_Manual/SoCalLID_Manual_FINAL_040910.pdf
- San Diego County LID Handbook Appendix 4 (Factsheet 26):
<http://www.sdcountry.ca.gov/dplu/docs/LID-Appendices.pdf>

XIV.5. Biotreatment BMP Fact Sheets (BIO)

Conceptual criteria for biotreatment BMP selection, design, and maintenance are contained in [Appendix XII](#). These criteria are generally applicable to the design of biotreatment BMPs in Orange County and BMP-specific guidance is provided in the following fact sheets.

Note: Biotreatment BMPs shall be designed to provide the maximum feasible infiltration and ET based on criteria contained in [Appendix XI.2](#).

BIO-1: Bioretention with Underdrains

Bioretention stormwater treatment facilities are landscaped shallow depressions that capture and filter stormwater runoff. These facilities function as a soil and plant-based filtration device that removes pollutants through a variety of physical, biological, and chemical treatment processes. The facilities normally consist of a ponding area, mulch layer, planting soils, and plants. As stormwater passes down through the planting soil, pollutants are filtered, adsorbed, biodegraded, and sequestered by the soil and plants. Bioretention with an underdrain are utilized for areas with low permeability native soils or steep slopes where the underdrain system that routes the treated runoff to the storm drain system rather than depending entirely on infiltration. [Bioretention must be designed without an underdrain](#) in areas of high soil permeability.

Also known as:

- Rain gardens with underdrains
- Vegetated media filter
- Downspout planter boxes



Bioretention
Source: Geosyntec Consultants

Feasibility Screening Considerations

- If there are no hazards associated with infiltration (such as groundwater concerns, contaminant plumes or geotechnical concerns), [bioinfiltration facilities](#), which achieve partial infiltration, should be used to maximize infiltration.
- Bioretention with underdrain facilities should be lined if contaminant plumes or geotechnical concerns exist. If high groundwater is the reason for infiltration infeasibility, bioretention facilities with underdrains do not need to be lined.

Opportunity Criteria

- Land use may include commercial, residential, mixed use, institutional, and subdivisions. Bioretention may also be applied in parking lot islands, cul-de-sacs, traffic circles, road shoulders, road medians, and next to buildings in planter boxes.
- Drainage area is ≤ 5 acres.
- Area is available for infiltration.

- Site must have adequate relief between land surface and the stormwater conveyance system to permit vertical percolation through the soil media and collection and conveyance in underdrain to stormwater conveyance system.

OC-Specific Design Criteria and Considerations

- Ponding depth should not exceed 18 inches; fencing may be required if ponding depth is greater than 6 inches to mitigate drowning.
- The minimum soil depth is 2 feet (3 feet is preferred).
- The maximum drawdown time of the bioretention ponding area is 48 hours. The maximum drawdown time of the planting media and gravel drainage layer is 96 hours, if applicable.
Infiltration pathways may need to be restricted due to the close proximity of roads, foundations, or other infrastructure. A geomembrane liner, or other equivalent water proofing, may be placed along the vertical walls to reduce lateral flows. This liner should have a minimum thickness of 30 mils.
- If infiltration in bioretention location is hazardous due to groundwater or geotechnical concerns, a geomembrane liner must be installed at the base of the bioretention facility. This liner should have a minimum thickness of 30 mils.
- The planting media placed in the cell shall be designed per the recommendations contained in MISC-1: Planting/Storage Media
- Plant materials should be tolerant of summer drought, ponding fluctuations, and saturated soil conditions for 48 hours; native place species and/or hardy cultivars that are not invasive and do not require chemical inputs should be used to the maximum extent feasible
- The bioretention area should be covered with 2-4 inches (average 3 inches) or mulch at the start and an additional placement of 1-2 inches of mulch should be added annually.
- Underdrain should be sized with a 6 inch minimum diameter and have a 0.5% minimum slope.
- Underdrain should be slotted polyvinyl chloride (PVC) pipe; underdrain pipe should be more than 5 feet from tree locations (if space allows).
- A gravel blanket or bedding is required for the underdrain pipe(s). At least 0.5 feet of washed aggregate must be placed below, to the top, and to the sides of the underdrain pipe(s).
- An overflow device is required at the top of the bioretention area ponding depth.
- Dispersed flow or energy dissipation (i.e. splash rocks) for piped inlets should be provided at basin inlet to prevent erosion.
- Ponding area side slopes shall be no steeper than 3:1 (H:V) unless designed as a planter box BMP with appropriate consideration for trip and fall hazards.

Simple Sizing Method for Bioretention with Underdrain

If the Simple Design Capture Volume Sizing Method described in **Appendix III.3.1** is used to size a bioretention with underdrain facility, the user selects the basin depth and then determines the appropriate surface area to capture the DCV. The sizing steps are as follows:

Step 1: Determine DCV

Calculate the DCV using the Simple Design Capture Volume Sizing Method described in **Appendix III.3.1**.

Step 2: Verify that the Ponding Depth will Draw Down within 48 Hours

The ponding area drawdown time can be calculated using the following equation:

$$DD_P = (d_P / K_{MEDIUM}) \times 12 \text{ in/ft}$$

Where:

DD_P = time to drain ponded water, hours

d_P = depth of ponding above bioretention area, ft (not to exceed 1.5 ft)

K_{MEDIUM} = media design infiltration rate, in/hr (equivalent to the media hydraulic conductivity with a factor of safety of 2; K_{MEDIUM} of 2.5 in/hr should be used unless other information is available)

If the drawdown time exceeds 48 hours, adjust ponding depth and/or media infiltration rate until 48 hour drawdown time is achieved.

Step 3: Determine the Depth of Water Filtered During Design Capture Storm

The depth of water filtered during the design capture storm can be estimated as the amount routed through the media during the storm, or the ponding depth, whichever is smaller.

$$d_{FILTERED} = \text{Minimum} [((K_{MEDIUM} \times T_{ROUTING})/12), d_P]$$

Where:

$d_{FILTERED}$ = depth of water that may be considered to be filtered during the design storm event, ft

K_{MEDIUM} = media design infiltration rate, in/hr (equivalent to the media hydraulic conductivity with a factor of safety of 2; K_{MEDIUM} of 2.5 in/hr should be used unless other information is available)

$T_{ROUTING}$ = storm duration that may be assumed for routing calculations; this should be assumed to be no greater than 3 hours. If the designer desires to account for further routing effects, the Capture Efficiency Method for Volume-Based, Constant Drawdown BMPs (See **Appendix III.3.2**) should be used.

d_P = depth of ponding above bioretention area, ft (not to exceed 1.5 ft)

Step 4: Determine the Facility Surface Area

$$A = DCV / (d_P + d_{FILTERED})$$

Where:

A = required area of bioretention facility, sq-ft

DCV = design capture volume, cu-ft

$d_{FILTERED}$ = depth of water that may be considered to be filtered during the design storm event, ft

d_P = depth of ponding above bioretention area, ft (not to exceed 1.5 ft)

Capture Efficiency Method for Bioretention with Underdrains

If the bioretention geometry has already been defined and the user wishes to account more explicitly for routing, the user can determine the required footprint area using the Capture Efficiency Method for Volume-Based, Constant Drawdown BMPs (See **Appendix III.3.2**) to determine the fraction of the DCV that must be provided to manage 80 percent of average annual runoff volume. This method accounts for drawdown time different than 48 hours.

Step 1: Determine the drawdown time associated with the selected basin geometry

$$DD = (d_P / K_{DESIGN}) \times 12 \text{ in/ft}$$

Where:

DD = time to completely drain infiltration basin ponding depth, hours

d_p = bioretention ponding depth, ft (should be less than or equal to 1.5 ft)

K_{DESIGN} = design media infiltration rate, in/hr (assume 2.5 inches per hour unless otherwise proposed)

If drawdown is less than 3 hours, the drawdown time should be rounded to 3 hours or the Capture Efficiency Method for Flow-based BMPs (See [Appendix III.3.3](#)) shall be used.

Step 2: Determine the Required Adjusted DCV for this Drawdown Time

Use the Capture Efficiency Method for Volume-Based, Constant Drawdown BMPs (See [Appendix III.3.2](#)) to calculate the fraction of the DCV the basin must hold to achieve 80 percent capture of average annual stormwater runoff volume based on the basin drawdown time calculated above.

Step 3: Determine the Basin Infiltrating Area Needed

The required infiltrating area (i.e. the surface area of the top of the media layer) can be calculated using the following equation:

$$A = \text{Design Volume} / d_p$$

Where:

A = required infiltrating area, sq-ft (measured at the media surface)

Design Volume = fraction of DCV, adjusted for drawdown, cu-ft (see Step 2)

d_p = ponding depth of water stored in bioretention area, ft (from Step 1)

This does not include the side slopes, access roads, etc. which would increase bioretention footprint. If the area required is greater than the selected basin area, adjust surface area or adjust ponding depth and recalculate required area until the required area is achieved.

Configuration for Use in a Treatment Train

- Bioretention areas may be preceded in a treatment train by HSCs in the drainage area, which would reduce the required design volume of the bioretention cell. For example, bioretention could be used to manage overflow from a cistern.
- Bioretention areas can be used to provide pretreatment for underground infiltration systems.

Additional References for Design Guidance

- CASQA BMP Handbook for New and Redevelopment:
<http://www.cabmphandbooks.com/Documents/Development/TC-32.pdf>
- SMC LID Manual (pp 68):
http://www.lowimpactdevelopment.org/guest75/pub/All_Projects/SoCal_LID_Manual/SoCal_LID_Manual_FINAL_040910.pdf
- Los Angeles County Stormwater BMP Design and Maintenance Manual, Chapter 5:
http://dpw.lacounty.gov/DES/design_manuals/StormwaterBMPDesignandMaintenance.pdf
- San Diego County LID Handbook Appendix 4 (Factsheet 7):
<http://www.sdcounty.ca.gov/dplu/docs/LID-Appendices.pdf>
Los Angeles Unified School District (LAUSD) Stormwater Technical Manual, Chapter 4:
http://www.laschools.org/employee/design/fs-studies-and-reports/download/white_paper_report_material/Storm_Water_Technical_Manual_2009-opt-red.pdf?version_id=76975850
- County of Los Angeles Low Impact Development Standards Manual, Chapter 5:
http://dpw.lacounty.gov/wmd/LA_County_LID_Manual.pdf

BIO-2: Vegetated Swale

Vegetated swale filters (vegetated swales) are open, shallow channels with low-lying vegetation covering the side slopes and bottom that collect and slowly convey runoff flow to downstream discharge points. Vegetated swales provide pollutant removal through settling and filtration in the vegetation (usually grasses) lining the channels. In addition, they provide the opportunity for volume reduction through infiltration and ET, and reduce the flow velocity in addition to conveying storm water runoff. Where soil conditions allow, volume reduction in vegetated swales can be enhanced by adding a gravel drainage layer underneath the swale allowing additional flows to be retained and infiltrated. Where slopes are shallow and soil conditions limit or prohibit infiltration, an underdrain system or low flow channel for dry weather flows may be required to minimize ponding and convey treated and/or dry weather flows to an acceptable discharge point. An effective vegetated swale achieves uniform sheet flow through a densely vegetated area for a period of several minutes. The vegetation in the swale can vary depending on its location within the project area and is generally the choice of the designer, subject to the design criteria outlined in this section.

<i>Also known as:</i>
<ul style="list-style-type: none"> ➤ <i>Bioswale</i> ➤ <i>Biofiltration swale</i> ➤ <i>Grass swale</i>

<p>Vegetated Swale Source: Geosyntec Consultants</p>

Feasibility Screening Considerations

- Swales may cause incidental infiltration; however, infiltration is not a mandatory mechanism for pollutant removal for swales and it may create hazards in some circumstances. Therefore, conditions should be evaluated to determine whether circumstances require an impermeable liner to avoid infiltration into the subsurface.

Opportunity Criteria

- Open areas are needed for vegetated swales, including, but not limited to, road shoulders, road medians, parks and athletic fields and can be constructed in residential or commercial areas.
- Site slope is less than 10 percent.
- Drainage area is ≤ 5 acres.
- Vegetated swales must not interfere with flood control functions of existing conveyance and detention structures.

OC-Specific Design Criteria and Considerations

- Swales should have a minimum bottom width of 2 feet and a maximum bottom width of 10 feet. Swale dividers should be used if the bottom width must exceed 10 feet to promote even distribution of flow across the swale. Local jurisdictions may require larger minimum widths based on maintenance requirements.
- The channel side slope should not exceed 2:1 (H:V) for a total swale depth of 1 foot or less. For deeper swales or mowed grass swales, the maximum channel side slope should be 3:1. Where space is constrained, swales may have vertical concrete or block walls provided that slope

stability, maintenance access and public safety considerations are met.

- The minimum swale length for biotreatment applications is 100 feet. The minimum residence time for flows in the swale is 10 minutes.
- If slope is less than 1.5%, underdrains should be provided for the length of the swale
- A gravel blanket or bedding is required around the underdrain pipe(s). At least 0.5 feet of washed aggregate must be placed below, to the top, and to the sides of the underdrain pipe(s).
- If an underdrain is included, an amended soil layer of 1 foot minimum thickness must be provided above the underdrain meeting the specifications of MISC-1: Planting/Storage Media.
- The maximum bed slope in flow direction should not exceed 6% (unless check dams are provided).
- The maximum flow velocity should not exceed 1.0 ft/sec for water quality treatment swales.
- For infrequently mowed swales, a maximum flow depth of 4 inches should be implemented. For frequently mowed turf swales, the maximum flow depth is 2 inches.
- The vegetation height should be maintained between 4 to 6 inches.
- Gradual meandering bends in the swale are desirable for aesthetic purposes and to promote slower flow and particulate settling.
- Blockages in the swale that result in uneven flow distribution and points of concentrated flow should be avoided. Blockages that should be avoided include trees, bushes, light pole piers, and utility vaults or pads.

Sizing Method for Vegetated Swales

The Design Capture Method for Flow-based BMPs should be used to determine the design flowrate for a vegetated swale. The user then selects the design flow depth and longitudinal slope and uses the sizing steps below to determine the length and width of the swale. The sizing steps are as follows:

Step 1: Determine Design Flowrate (Q)

Calculate the Design Flowrate (Q) using the Capture Efficiency Method for Flow-based BMPs (See [Appendix III.3.3](#)). Inputs include the time of concentration of the catchment (T_c) and the capture efficiency achieved upstream by HSCs or other BMPs.

Step 2: Estimate the Swale Bottom Width

For shallow flow depths, channel side slopes can be ignored and the bottom width can be calculated using a simplified form of Manning's formula:

$$b = (Q \times n_{wQ}) / (1.49 \times y^{1.67} \times s^{0.5})$$

Where:

b = estimated swale bottom width, ft

Q = design flowrate, cfs

n_{wQ} = Manning's roughness coefficient for shallow flow conditions, use 0.2 unless other information is available

y = design flow depth, ft (not to exceed 4 inches or 0.33 ft)

s = longitudinal slope in flow direction, ft/ft (not to exceed 0.06)

If b is between 2 and 10 feet, proceed to step 3.

If b is less than 2 feet, increase b to 2 feet and recalculate design flow depth using the following:

$$y = ((Q \times n_{WQ}) / (1.49 \times b \times s^{0.5}))^{0.6}$$

If b is greater than 10 feet, one of the following steps is necessary:

- Increase longitudinal slope to a maximum of 6% or 0.06, and recalculate b
- Increase design flow depth to a maximum of 4 inches or 0.33 ft, and recalculate b
- Install a divider lengthwise along swale bottom at least three-quarters of the swale length, beginning at the inlet. The swale width can be increased to 16 feet if a divider is provided.

Step 3: Determine Design Flow Velocity

Calculate the design flow velocity using the following equation:

$$V_{WQ} = Q / A_{WQ}$$

Where:

V_{WQ} = design flow velocity, fps

Q = design flowrate, cfs

$A_{WQ} = by + Zy^2$, cross sectional area of flow at design depth

Z = side slope length per unit height

If the design flow velocity exceeds 1 foot per second, design parameters in Step 2 should be adjusted (slope, bottom width, or design flow depth) until V_{WQ} is equal or less than 1 fps.

Step 4: Calculate Swale Length

Calculate the swale length needed to achieve a minimum hydraulic residence time of 10 minutes using the following equation:

$$L = 60 \times t_{HR} \times V_{WQ}$$

Where:

L = swale length, ft

t_{HR} = hydraulic residence time, min (minimum 10 minutes)

V_{WQ} = design flow velocity, fps

Step 5: If Needed, Adjust Swale Length to Site Constraints

Note that oftentimes swale length can be accommodated by providing a meandering swale. However, if swale length is too large for the site, the length can be adjusted as follows:

- Calculate the swale treatment top area (A_{TOP}), based on the swale length calculated in Step 4:

$$A_{TOP} = (b_i + b_{SLOPE}) \times L_i$$

Where:

A_{TOP} = top area (ft²) at the design treatment depth

b_i = bottom width (ft), calculated in Step 2

b_{SLOPE} = the additional top width (ft) above the side slope for the design water depth (for 3:1 side slopes and a 4-inch water depth, $b_{slope} = 2$ feet)

L_i = initial length (ft) calculated in Step 4

- Use the swale top area and a reduced swale length (L_f) to increase the bottom width, using the following equation:

$$L_f = A_{TOP} / (b_f + b_{SLOPE})$$

Where:

L_F = reduced swale length (ft)

b_F = increased bottom width (ft)

- Recalculate V_{WQ} according to Step 3 using the revised cross-sectional area A_{WQ} based on the increased bottom width (b_F). Revise the design as necessary if the design flow velocity exceeds 1 foot per second.
- Recalculate to ensure that the 10 minute retention time is retained.

Configuration for Use in a Treatment Train

- Vegetated swales can be incorporated in a treatment train to provide enhanced water quality treatment and reductions in runoff volume and rate. For example, if a vegetated swale is placed upgradient of a dry extended detention (ED) basin, the rate and volume of water flowing to the dry ED basin can be reduced and the water quality enhanced. As another example, dry ED basins may be placed upstream a vegetated swale to reduce the size of the vegetated swale.
- Vegetated swales can be used as pretreatment for infiltration BMPs.
- If designed with an infiltration sump, vegetated “bioinfiltration” swales can provide retention and biotreatment capacity.

Additional References for Design Guidance

Los Angeles Unified School District (LAUSD) Stormwater Technical Manual, Chapter 4:

http://www.laschools.org/employee/design/fs-studies-and-reports/download/white_paper_report_material/Storm_Water_Technical_Manual_2009-opt-red.pdf?version_id=76975850

Santa Barbara BMP Guidance Manual, Chapter 6:

http://www.santabarbaraca.gov/NR/rdonlyres/91D1FA75-C185-491E-A882-49EE17789DF8/0/Manual_071008_Final.pdf

- County of San Diego Drainage Design Manual for design criteria, Section 5.5:
<http://www.co.san-diego.ca.us/dpw/floodcontrol/floodcontrolpdf/drainage-designmanual05.pdf>

County of Los Angeles Low Impact Development Standards Manual, Chapter 5:

http://dpw.lacounty.gov/wmd/LA_County_LID_Manual.pdf

- Los Angeles County Stormwater BMP Design and Maintenance Manual:
http://dpw.lacounty.gov/DES/design_manuals/StormwaterBMPDesignandMaintenance.pdf

BIO-3: Vegetated Filter Strip

Vegetated filter strips are designed to treat sheet flow runoff from adjacent impervious surfaces or intensive landscaped areas such as golf courses. Filter strips decrease runoff velocity, filter out total suspended solids and associated pollutants, and provide some infiltration into underlying soils. While some assimilation of dissolved constituents may occur, filter strips are generally more effective in trapping sediment and particulate-bound metals, nutrients, and pesticides. Filter strips are more effective when the runoff passes through the vegetation and thatch layer in the form of shallow, uniform flow. Biological and chemical processes may help break down pesticides, uptake metals, and utilize nutrients that are trapped in the filter.

<i>Also known as:</i>
<ul style="list-style-type: none"> ➤ <i>Buffer strip</i> ➤ <i>Vegetated buffer</i>

<p>Vegetated filter strip. <i>Source:</i> http://www.wsdot.wa.gov/Environment/WaterQuality/Research/Reports.htm</p>

Feasibility Screening Considerations

- Vegetated filter strips may cause incidental infiltration. Therefore, an evaluation of site conditions should be conducted to evaluate whether the BMP should include an impermeable liner to avoid infiltration into the subsurface.

Opportunity Criteria

- Filter strips provide an attractive and inexpensive vegetative storm water runoff BMP that can be easily incorporated into the landscape design of a site.
- Open areas are needed for vegetated filter strips, including road and highway shoulders, small parking lots, and residential, commercial, or institutional landscaped areas.
- Must be sited adjacent to impervious surfaces which can sheet flow onto filter strips.
- Shallow, evenly distributed flow across entire width of strip is recommended.
- Steep terrain and/or a large tributary area may cause concentrated, erosive flows. The site slope should not exceed 5%.
- Drainage area is ≤ 2 acres with a maximum length (in the direction of flow towards the filter strip) of 150 feet.

OC-Specific Design Criteria and Considerations

- For biotreatment applications, the minimum length in the flow direction is 15 feet, and the maximum length in the flow direction is 150 feet. If filter strip is used for pretreatment, the minimum filter strip length is 7.5 feet.
- The width of the filter strip should extend across the full width of the tributary area, with the upstream boundary of the filter strip located contiguous to the developed area.
- A minimum design residence time of 10 minutes is recommended for biotreatment applications, or 5 minutes for pretreatment uses.
- The bed slope in flow direction should be between 2 - 6%.

- The slope in the direction perpendicular to flow should not exceed 4%.
- The maximum design flow depth should be 1 inch.
- The design flow velocity should not exceed 1 ft/sec.
- Irrigated turf grass or approved equal should be used for vegetation. Grass height should be maintained between 2 – 4 inches.
- The top of the strip should be installed 2 to 5 inches below the adjacent pavement to allow for vegetation and sediment accumulation at the edge of the strip. A beveled transition is acceptable and may be required per roadside design specifications

Sizing Approach for Vegetated Filter Strip

The Design Capture Method for Flow-based BMPs should be used to determine the design flowrate for a vegetated filter strip. The user then selects the design flow depth and longitudinal slope and uses the sizing steps below to determine the length and width of the swale. The sizing steps are as follows:

Step 1: Determine Design Flowrate (Q)

Calculate the Design Flowrate (Q) using the Capture Efficiency Method for Flow-based BMPs (See [Appendix III.3.3](#)). Inputs include the time of concentration of the catchment (T_c) and the capture efficiency achieved upstream by HSCs or other BMPs.

Step 2: Calculate the Minimum Filter Strip Width

$$W_{MIN} = Q / q_{A,MIN}$$

Where:

W_{MIN} = minimum width of filter strip (and tributary area), ft

Q = design flow, cfs

$q_{A,MIN}$ = minimum linear unit application rate, 0.005 cfs/ft

Step 3: Calculate the Design Flow Depth

$$d_F = 12 \times ((Q \times n_{WQ}) / (1.49 \times W_{TRIB} \times s^{0.5}))^{0.6}$$

Where:

d_F = design flow depth, in

Q = design flow, cfs

n_{WQ} = Manning's roughness coefficient for shallow flow conditions, use 0.2 unless other information is available

W = width of strip (and tributary area), ft (should be equal or greater than W_{MIN})

s = longitudinal slope in flow direction, ft/ft (not to exceed 0.06)

Step 4: Calculate the Filter Strip Design Velocity

Calculate the filter strip design velocity using the following equation:

$$V_{WQ} = Q / (d_F \times W)$$

Where:

V_{WQ} = filter strip design flow velocity, fps

d_F = design flow depth, in

Q = design flow, cfs

W = width of strip (and tributary area), ft

The design flow velocity should not exceed 1 foot per second. If the velocity exceeds 1 fps, adjust the strip longitudinal slope to decrease the velocity.

Step 5: Calculate Filter Strip Length

Calculate the filter strip length required to achieve the required minimum residence time using the following equation:

$$L = 60 \times t_{HR} \times V_{WQ}$$

Where:

L = filter strip length, ft (must be 15 ft to 150 ft for biotreatment)

t_{HR} = hydraulic residence time, min (minimum 10 minutes for biotreatment)

V_{WQ} = design flow velocity, fps

Configuration for Use in a Treatment Train

- Filter strips are often used as pretreatment devices for other larger capacity BMPs such as bioretention areas and assist by filtering sediment and associated pollutants prior to entering the larger capacity BMP, preventing clogging and reducing the maintenance requirements for larger capacity BMPs.

Additional References for Design Guidance

- Santa Barbara BMP Guidance Manual, Chapter 6:
http://www.santabarbaraca.gov/NR/rdonlyres/91D1FA75-C185-491E-A882-49EE17789DF8/0/Manual_071008_Final.pdf
- Los Angeles County Stormwater BMP Design and Maintenance Manual, Chapter 4:
http://dpw.lacounty.gov/DES/design_manuals/StormwaterBMPDesignandMaintenance.pdf
- Los Angeles Unified School District (LAUSD) Stormwater Technical Manual, Chapter 4:
http://www.laschools.org/employee/design/fs-studies-and-reports/download/white_paper_report_material/Storm_Water_Technical_Manual_2009-opt-red.pdf?version_id=76975850
- SMC LID Manual (pp 135):
http://www.lowimpactdevelopment.org/guest75/pub/All_Projects/SoCal_LID_Manual/SoCalLID_Manual_FINAL_040910.pdf

BIO-4: Wet Detention Basin

Wet detention basins are constructed, naturalistic ponds with a permanent or seasonal pool of water (also called a “wet pool” or “dead storage”). Aquascape facilities, such as artificial lakes, are a special form of wet pool facility that can incorporate innovative design elements to allow them to function as a stormwater treatment facility in addition to an aesthetic water feature. Wet ponds require base flows to exceed or match losses through evaporation and/or infiltration, and they must be designed with the outlet positioned and/or operated in such a way as to maintain a permanent pool. Wet ponds can be designed to provide extended detention of incoming flows using the volume above the permanent pool surface.

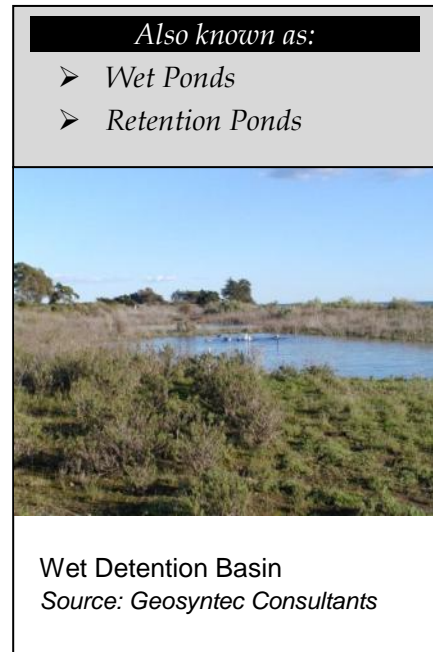

Feasibility Screening Considerations

- Feasibility screening is not applicable to wet ponds; however the potential risk of groundwater contamination should be considered in selection and design.

Opportunity Criteria

- Can provide aesthetic/recreational value for a project.
- Requires relatively large open space area at outlet of drainage area.
- Generally most applicable for drainage areas larger than 10 acres; however may be applied to smaller drainage areas.
- Applicable in drainage areas with source of base flow to maintain water level.

OC-Specific Design Criteria and Considerations

- Minimum set-backs from foundations and slopes should be observed.
- Retention of permanent pool volume should not cause geotechnical concerns related to slope stability. Proposed basins in areas with slopes greater than 15 percent or within 200 feet from the top of a hazardous slope or landslide area require geotechnical investigation.
- Design should include a sediment forebay to remove coarse solids.
- Flow path length to width ratio is 2:1 (minimum) and 3:1 or greater (preferred).
- Maximum side slope (H:V) should be 4:1 interior and 3:1 exterior, unless protected from public access by fencing and approved for stability by a geotechnical professional.
- Wetland vegetation must not occupy more than 25% of surface area.
- A buffer zone with a minimum width of 25 feet should be provided around the top perimeter of the wet detention basin.

- Inlets and outlets should be positioned to maximize flowpaths through the facility. All inlets should enter the first cell of the wet detention basin.
- The inlet to wet detention basin should be submerged to dissipate the energy of incoming flow. Energy dissipation should also be used at the outlet of the basin.
- Minimum freeboard should be 1 foot (2 feet preferred) above the maximum water surface elevation for on-line basins and 1 foot maximum for off-line basins.
- Maximum basin residence time for dry weather flows is 7 days.

Computing Sizing Criteria for Wet Detention Basins

- This document does not provide specific sizing guidance for wet detention basins. Wet basins should be designed by a team of specialists that understand wetland ecology and biology and are familiar with methods to avoid stagnation, odors, and vector issues associated with maintaining a permanent pool. The BMP designer(s) must demonstrate that the facility is sized to capture and treat the volume of runoff not being addressed by upstream BMPs such that 80 percent of average annual stormwater runoff volume from the site is retained or biotreated.
- The retention volume within a wet detention basin is the equal to the permanent pool volume. The drawdown time criteria, or the rate at which the retention volume becomes available, does not apply to wet detention basins. All runoff in excess of the retention volume that flows through the basin is considered biotreated.
- The permanent pool volume should be at least 50 percent of the volume of active (extended detention) storage.

Configuration for Use in a Treatment Train

- Wet detention basins would generally be designed to serve as the final BMP before discharging runoff off-site.
- Wet detention basins may be preceded in a treatment train by HSCs and LID BMPs in the drainage area, which would reduce the pollutant load and volume of runoff entering the basin, thereby reducing the sizing requirements of the wet detention basin.
- Wet detention basins can be designed to precede other LID or treatment control BMPs, providing equalization and pretreatment.

Additional References for Design Guidance

- CASQA BMP Handbook for New and Redevelopment:
<http://www.cabmphandbooks.com/Documents/Development/TC-20.pdf>
- Los Angeles County Stormwater BMP Design and Maintenance Manual:
http://dpw.lacounty.gov/DES/design_manuals/StormwaterBMPDesignandMaintenance.pdf
- LA County LID Manual, Chapter 5: http://dpw.lacounty.gov/wmd/LA_County_LID_Manual.pdf
- Portland Stormwater Management Manual:
<http://www.portlandonline.com/bes/index.cfm?c=47953&>
- Western Washington Stormwater Management Manual, Volume V, Chapter 10:
<http://www.ecy.wa.gov/pubs/0510033.pdf>

BIO-5: Constructed Wetland

A constructed wetland is a system consisting of a sediment forebay and one or more permanent micro-pools with aquatic vegetation covering a significant portion of the basin. Constructed treatment wetlands typically include components such as an inlet with energy dissipation, a sediment forebay for settling out coarse solids and to facilitate maintenance, shallow sections (1 to 2 feet deep) planted with emergent vegetation, deeper areas or micro pools (3 to 5 feet deep), and a water quality outlet structure. The interactions between the incoming stormwater runoff, aquatic vegetation, wetland soils, and the associated physical, chemical, and biological unit processes are a fundamental part of constructed wetlands.

<i>Also known as:</i>
<ul style="list-style-type: none"> ➤ <i>Stormwater Wetlands</i> ➤ <i>Wetland Basins</i> ➤ <i>Treatment Wetland</i>

<p style="text-align: center;">Constructed Wetland Source: Geosyntec Consultants</p>

Feasibility Screening Considerations

- Feasibility screening is not applicable to constructed wetlands; however the potential risk of groundwater contamination should be considered in selection and design.

Opportunity Criteria

- Potential regional treatment for a relatively large watershed drainage area.
- Applicable for use with projects involving roads, highways, commercial residences, parks, open spaces, or golf courses.
- Requires large footprint area. Applicable for drainage areas treating areas larger than 10 acres and less than 10 square miles.
- Applicable in drainage areas with source of base flow to maintain water level.
- Wetlands present potential safety concerns and habitat for mosquito and midge breeding.

OC-Specific Design Criteria and Considerations

- Minimum set-backs from foundations and slopes should be observed.
Infiltration should not cause geotechnical concerns related to slope stability or erosion.
- Proposed basins in areas with slopes greater than 7 percent or within 200 feet from the top of a hazardous slope or landslide area require geotechnical investigation and report completed by licensed civil engineer.
- A natural shape and range of intermixed depths is recommended for constructed wetland geometry.
- Design includes sediment forebay to remove coarse solids.
- Maximum residence time equals 7 days (dry weather).
- Flow path length to width ratio is 3:1 (minimum) and 4:1 or greater (preferred).

- Minimum side slope ratio (H:V) should be 4:1 for interior side slopes, 2:1 for exterior sideslopes, and 3:1 for landscaped slopes.
- A buffer zone with a minimum width of 25 feet should be provided around the top perimeter of the constructed treatment wetlands.
- A source of water should be provided if water balance indicates losses will exceed inputs.
- Inlets and outlets should be positioned to maximize flowpaths through the facility. All inlets should enter the first cell of the wet detention basin.
- Minimum freeboard should be 1 foot above the maximum water surface elevation.

Computing Sizing Criteria for Constructed Wetlands

This document does not provide specific sizing guidance for constructed wetlands. Wetlands should be designed by a team of wetland specialists that understand wetland ecology and biology and are familiar with methods to avoid stagnation, odors, and vector issues associated with maintaining a permanent pool. The BMP designer(s) must demonstrate that the facility is sized to capture and treat the volume of runoff not being addressed by upstream BMPs such that 80 percent of the total average annual runoff from the site is retained or treated.

The retention volume within a constructed wetland is the equal to the permanent pool volume. The drawdown time criteria, or the rate at which the retention volume becomes available, does not apply to constructed wetlands. All runoff in excess of the retention volume that flows through the wetland is considered biotreated.

Configuration for Use in a Treatment Train

- Constructed wetland basins would generally be designed to serve as the final BMP before discharging runoff off-site.
- Constructed wetland basins may be preceded in a treatment train by HSCs and LID BMPs in the drainage area, which would reduce the pollutant load and volume of runoff entering the basin, thereby reducing the sizing requirements of the wet detention basin.

Additional References for Design Guidance

- Western Washington Stormwater Management Manual, Volume V, Chapter 10:
<http://www.ecy.wa.gov/pubs/0510033.pdf>
- CASQA BMP Handbook for New and Redevelopment:
<http://www.cabmphandbooks.com/Documents/Development/TC-21.pdf>
- Los Angeles County Stormwater BMP Design and Maintenance Manual, Chapter 7:
http://dpw.lacounty.gov/DES/design_manuals/StormwaterBMPDesignandMaintenance.pdf
- LA County LID Manual, Chapter 5: http://dpw.lacounty.gov/wmd/LA_County_LID_Manual.pdf
- SMC LID Manual:
http://www.lowimpactdevelopment.org/guest75/pub/All_Projects/SoCal_LID_Manual/SoCalLID_Manual_FINAL_040910.pdf

BIO-6: Dry Extended Detention Basin

Dry extended detention basins (DEDBs) are basins whose outlets have been designed to detain the stormwater quality design volume, SQDV, for 36 to 48 hours to allow particulates and associated pollutants to settle out. DEDBs do not have a permanent pool; they are designed to drain completely between storm events. They can also be used to provide hydromodification and/or flood control by modifying the outlet control structure and providing additional detention storage. The slopes, bottom, and forebay of DEDBs are typically vegetated. Considerable stormwater volume reduction can occur in DEDBs when they are located in permeable soils and are not lined with an impermeable barrier.



For dry extended detention basins to be considered as biotreatment BMPs, they must meet all applicable guidelines described in this Fact Sheet and in [Appendix XII](#).

If dry extended detention basins do not meet these guidelines, they shall be considered treatment control BMPs.

Level 1 Screening Considerations

- Infiltration feasibility is not generally applicable to DEDBs; however some incidental infiltration will occur.
- The potential risk of groundwater contamination and geotechnical hazards should be considered in determining whether a liner is needed.

Opportunity Criteria

- Most applicable for larger drainage areas where significant area is available at the downstream end of the drainage area.
- Can be integrated into open areas or play fields.
- Not ideal in areas where high seasonal groundwater would limit depth or require lining.
- Can be integrated into flood control facilities where essential functions of flood control facilities are not compromised.

Criteria for Categorization of DEDBs as Biotreatment BMP

In order to to be categorized as Biotreatment BMPs, DEDBs should be designed to meet the following minimum criteria. DEDBs not meeting these criteria but meeting the OC-Specific design criteria listed next are categorized as treatment control BMPs.

- Maximum treatment depth should be 6 feet
- Robust, diverse, and extensive vegetation should be designed and maintained to an average height not less than > 12 inches. Soils should be amended per soil amendment criteria contained in MISC-2: Amended Soils if vegetation cannot be readily established.

- Hardscape within basin should be limited to essential access roads.
- Design should include a vegetated sediment forebay that encompasses between 20 and 30 percent of the basin volume.
- The basin should be designed to draw down over 48 to 72 hours. The basin should be designed such that drawdown time for the bottom 50 percent of the treatment volume is not less than 2/3 of the entire drawdown time.
- The L:W ratio of the basin should meet or exceed 2:1.
- A micropool should be provided upstream of the outlet structure and/or media filtration should be integrated with the outlet structure.

OC-Specific Design Criteria and Considerations

- Minimum set-backs from foundations and slopes should be observed
- Infiltration should not cause geotechnical concerns related to slope stability or erosion. Proposed basins in areas with slopes greater than 15 percent or within 200 feet from the top of a hazardous slope or landslide area require geotechnical investigation.
- Depth from bottom of facility to seasonal high groundwater table should be ≥ 2 feet.
- DEDBs are preferably off-line, designed to bypass peak flows.
- Minimum freeboard equals 1 foot for offline facilities and 2 feet for online facilities.
- Maximum side slope (H:V) preferably equals 4:1 interior and 3:1 exterior; steeper slopes permitted with fencing and geotechnical analysis.
- Longitudinal slope preferably 0%-2%.
- Low flow channel with gravel infiltration trench preferably provided where infiltration is allowable; designed to eliminate maximum estimated dry weather flowrate.

Computing Sizing Criteria for Dry Extended Detention Basins

- DEDBs should be sized for the DCV, calculated per the Simple Design Capture Volume Sizing Method.
- Routing calculations should demonstrate that the outlet structure is designed to achieve the target drawdown time and pattern: The basin should be designed to draw down over 48 to 72 hours. The basin should be designed such that drawdown time for the bottom 50 percent of the treatment volume is not less than 2/3 of the entire drawdown time.

Configuration for Use in a Treatment Train

- Dry extended detention basins may be preceded in a treatment train by HSCs and LID BMPs in the drainage area, which would reduce the remaining biotreatment/treatment control requirements and allow the basin to be smaller in volume.
- Dry extended detention basins can be located upstream of LID or treatment control BMPs to provide peak flow equalization.

Additional References for Design Guidance

- CASQA BMP Handbook for New and Redevelopment:
<http://www.cabmphandbooks.com/Documents/Development/TC-22.pdf>

- SMC LID Manual (pp 145):
http://www.lowimpactdevelopment.org/guest75/pub/All_Projects/SoCal_LID_Manual/SoCalLID_Manual_FINAL_040910.pdf
- Los Angeles County Stormwater BMP Design and Maintenance Manual, Chapter 2:
http://dpw.lacounty.gov/DES/design_manuals/StormwaterBMPDesignandMaintenance.pdf
- City of Portland Stormwater Management Manual (Pond, page 2-68)
<http://www.portlandonline.com/bes/index.cfm?c=47954&a=202883>
- San Diego County LID Handbook Appendix 4 (Factsheet 3):
<http://www.sdcounty.ca.gov/dplu/docs/LID-Appendices.pdf>

BIO-7: Proprietary Biotreatment

Proprietary biotreatment devices are devices that are manufactured to mimic natural systems such as bioretention areas by incorporating plants, soil, and microbes engineered to provide treatment at higher flow rates or volumes and with smaller footprints than their natural counterparts. Incoming flows are typically filtered through a planting media (mulch, compost, soil, plants, microbes, etc.) and either infiltrated or collected by an underdrain and delivered to the storm water conveyance system. Tree box filters are an increasingly common type of proprietary biotreatment device that are installed at curb level and filled with a bioretention type soil. For low to moderate flows they operate similarly to bioretention systems and are bypassed during high flows. Tree box filters are highly adaptable solutions that can be used in all types of development and in all types of soils but are especially applicable to dense urban parking lots, street, and roadways.

<p><i>Also known as:</i></p> <ul style="list-style-type: none"> ➤ <i>Catch basin planter box</i> ➤ <i>Bioretention vault</i> ➤ <i>Tree box filter</i>

<p>Proprietary biotreatment <i>Source:</i> http://www.americastusa.com/index.php/filterra/</p>

Feasibility Screening Considerations

- Proprietary biotreatment devices that are unlined may cause incidental infiltration. Therefore, an evaluation of site conditions should be conducted to evaluate whether the BMP should include an impermeable liner to avoid infiltration into the subsurface.

Opportunity Criteria

- Drainage areas of 0.25 to 1.0 acres.
- Land use may include commercial, residential, mixed use, institutional, and subdivisions. Proprietary biotreatment facilities may also be applied in parking lot islands, traffic circles, road shoulders, and road medians.
- Must not adversely affect the level of flood protection provided by the drainage system.

OC-Specific Design Criteria and Considerations

- Frequent maintenance and the use of screens and grates to keep trash out may decrease the likelihood of clogging and prevent obstruction and bypass of incoming flows.
- Consult proprietors for specific criteria concerning the design and performance.
- Proprietary biotreatment may include specific media to address pollutants of concern. However, for proprietary device to be considered a biotreatment device the media must be capable of supporting rigorous growth of vegetation.
- Proprietary systems must be acceptable to the reviewing agency. Reviewing agencies shall have the discretion to request performance information. Reviewing agencies shall have the discretion to deny the use of a proprietary BMP on the grounds of performance, maintenance considerations, or other relevant factors.

- In right of way areas, plant selection should not impair traffic lines of site. Local jurisdictions may also limit plant selection in keeping with landscaping themes.

Computing Sizing Criteria for Proprietary Biotreatment Device

- Proprietary biotreatment devices can be volume based or flow-based BMPs.
- Volume-based proprietary devices should be sized using the Simple Design Capture Volume Sizing Method described in [Appendix III.3.1](#) or the Capture Efficiency Method for Volume-Based, Constant Drawdown BMPs described in [Appendix III.3.2](#).
- The required design flowrate for flow-based proprietary devices should be computed using the Capture Efficiency Method for Flow-based BMPs described in [Appendix III.3.3](#).

Additional References for Design Guidance

- Los Angeles Unified School District (LAUSD) Stormwater Technical Manual, Chapter 4:
http://www.laschools.org/employee/design/fs-studies-and-reports/download/white_paper_report_material/Storm_Water_Technical_Manual_2009-opt-red.pdf?version_id=76975850
- Los Angeles County Stormwater BMP Design and Maintenance Manual, Chapter 9:
http://dpw.lacounty.gov/DES/design_manuals/StormwaterBMPDesignandMaintenance.pdf
- Santa Barbara BMP Guidance Manual, Chapter 6:
http://www.santabarbaraca.gov/NR/rdonlyres/91D1FA75-C185-491E-A882-49EE17789DF8/0/Manual_071008_Final.pdf

XIV.6. Treatment Control BMP Fact Sheets (TRT)

TRT-1: Sand Filters

Sand filters operate by filtering stormwater through a constructed media bed (generally sand) with an underdrain system. Runoff enters the filter and spreads over the surface. As flows increase, water backs up on the surface of the filter where it is held until it can percolate through the sand. The treatment pathway is vertical (downward through the media) to an engineered underdrain system that is connected to the downstream storm drainage system. As stormwater passes through the sand, pollutants are trapped on the surface of the filter, in the small pore spaces between sand grains, or are adsorbed to the sand surface.



Feasibility

- Site conditions should be assessed to determine if systems should be lined to prevent incidental infiltration.

Opportunity Criteria

- Intended for use when retention and biotreatment options are infeasible.
- Locate away from trees producing leaf litter or areas contributing significant sediment that could cause clogging.
- Pretreatment is necessary to eliminate significant sediment load or other large particles that could reduce the infiltration capacity of the filter. Refer to [Appendix XIV.7](#) for information on pretreatment devices. Pretreatment can also be performed in a sedimentation chamber, which precedes the filter bed.
- Drainage area topography and downstream drainage configuration must have adequate relief to allow for percolation through the sand and collection and conveyance through the underdrain stormwater conveyance system; four feet is recommended between inlet and outlet of filter.
- Not applicable in areas of permanent or seasonal high groundwater (less than five feet below ground surface)
- Open bed sand filters should not be placed in areas subject to seed sources and where hydrologic conditions promote prolific germination of plants in the media. Undesired plant growth will substantially increase maintenance costs and threaten to damage the filter or impair its performance.

OC-Specific Design Criteria and Considerations

- Where incidental infiltration would potentially cause geotechnical concerns, systems should be lined with an impermeable membrane or layer.
- Minimum set-backs from foundations and slopes should be observed if the facility is not lined.
- Filter bed depth (i.e., media thickness) is at least 24 inches, but 36 inches preferred.

- Max ponding depth above filter should not exceed 6 feet.
- Saturated hydraulic conductivity of media should be selected to address pollutants of concern and factors of safety in design should be set to account for deterioration of performance between maintenance.
- Side slopes should not exceed and 2:1 H:V unless stabilization approved by licensed geotechnical engineer.
- Minimum pretreatment should be provided upstream of the filter, and water bypassing pretreatment should not be directed to the filter.
- Filters should be designed and maintained such that ponded water should not persist for longer than 72 hours following a storm event.

Computing Sizing Criteria for Media Filter

- Media filters with significant surface storage should be sized as volume-based BMPs.
- Alternatively, media filters may be sized as flow-based BMPs when storage is not significant.

Calculating Sand Filter Drawdown Rate for Volume-based Sizing Calculations

Volume-based sizing of sand filters should be conducted identically to [bioretention with underdrains](#).

Maximum ponding depth should be increased to 6 feet in this sizing calculation.

Calculating Sand Filter Design Flowrate Rate if Sized as Flow-based BMP

The required design flowrate should be calculated based on the [Capture Efficiency Method for Flow-based BMPs](#) (See [Appendix III.3.3](#)).

The flow-based treatment capacity of a sand filter may be estimated as:

$$Q_{\text{capacity}} = K_{\text{sat}} \times I_{\text{full}} \times A / [24 \text{ hr/day}]$$

Where,

K_{sat} = design saturated hydraulic conductivity, feet/day (set to account for long-term deterioration of performance)

I_{full} = gradient across filter bed when storage is full = (depth of water at overflow + depth of media bed)/(depth of media bed)

A = surface area of media bed, sq-ft

Configuration for Use in a Treatment Train

- Sand filters may be preceded in a treatment train by HSCs and LID BMPs in the drainage area, which would reduce the required size of the filter.
- Sand filters should be preceded by some form of pretreatment which will remove the largest particles before entering and potentially clogging the sand filter.
- Sand filters can be used to provide pretreatment for infiltration basins or other LID infiltration BMPs.

Additional References for Design Guidance

- CASQA BMP Handbook for New and Redevelopment:
<http://www.cabmphandbooks.com/Documents/Development/TC-40.pdf>

- Los Angeles County Stormwater BMP Design and Maintenance Manual, Chapter 8:
http://dpw.lacounty.gov/DES/design_manuals/StormwaterBMPDesignandMaintenance.pdf
- LA County LID Manual: http://dpw.lacounty.gov/wmd/LA_County_LID_Manual.pdf
- San Diego County LID Handbook Appendix 4 (Factsheet 6):
<http://www.sdcountry.ca.gov/dplu/docs/LID-Appendices.pdf>
- SMC LID Manual:
http://www.lowimpactdevelopment.org/guest75/pub/All_Projects/SoCal_LID_Manual/SoCalLID_Manual_FINAL_040910.pdf
- LA County LID Manual: http://dpw.lacounty.gov/wmd/LA_County_LID_Manual.pdf
- Portland Stormwater Management Manual:
<http://www.portlandonline.com/bes/index.cfm?c=47953&>
- Western Washington Stormwater Management Manual:
<http://www.ecy.wa.gov/pubs/0510033.pdf>

TRT-2: Cartridge Media Filter

Cartridge media filters (CMFs) are manufactured devices that consist of a series of modular filters packed with engineered media that can be contained in a catch basin, manhole, or vault that provide treatment through filtration and sedimentation. The manhole or vault may be divided into multiple chambers where the first chamber acts as a pre-settling basin for removal of coarse sediment while another chamber acts as the filter bay and houses the filter cartridges. A variety of media types are available from various manufacturers which can target pollutants of concern.



Feasibility Screening Considerations

- Not applicable

Opportunity Criteria

- Intended for use when retention and biotreatment options are infeasible.
- Recommended for drainage area with limited available surface area or where surface BMPs would restrict uses.
- For drainage areas with significant areas of non-stabilized soil, permanent soil stabilization must be achieved before cartridge media filters are installed and put on line to minimize risk of clogging.
- Depending on the number of cartridges, maintenance events can have long durations. Care should be exercised in siting these facilities so that maintenance events will not significantly disrupt businesses or traffic.

OC-Specific Design Criteria and Considerations

- Cartridge media filter BMP vendors should be consulted regarding design and specifications.
- Filter media should be selected to target pollutants of concern. A combination of media may be appropriate to remove a variety of pollutants.
- If CMF are integrated with a vault for equalization, the system should be designed to completely drain the vault within 96 hours of storm event or otherwise protect against standing water and mosquito breeding concerns.

Computing Sizing Criteria for Cartridge Media Filters

The required design flowrate should be calculated based on the [Capture Efficiency Method for Flow-based BMPs](#) (See [Appendix III.3.3](#)).

Additional References for Design Guidance

- Los Angeles County Stormwater BMP Design and Maintenance Manual, Chapter 9: http://dpw.lacounty.gov/DES/design_manuals/StormwaterBMPDesignandMaintenance.pdf

- SMC LID Manual:
http://www.lowimpactdevelopment.org/guest75/pub/All_Projects/SoCal_LID_Manual/SoCalLID_Manual_FINAL_040910.pdf
- Western Washington Stormwater Management Manual, Volume V, Chapter 12:
<http://www.ecy.wa.gov/pubs/0510033.pdf>

XIV.7. Pretreatment/Gross Solids Removal BMP Fact Sheets (PRE)

PRE-1: Hydrodynamic Separation Device

Hydrodynamic separation devices are inline pretreatment units designed to remove trash, debris, and coarse sediment using screening, gravity settling, and centrifugal forces generated by forcing the influent into a circular motion. Several companies manufacture units with a variety of design components including separate chambers, baffles, sorbent media, screens, and flow control orifices. Therefore, additional constituents may be targeted depending on the design; however, the short residence time and potential for captured materials to be released during high flows limits the acceptable use of this BMP type as a standalone treatment control BMP.

Also known as:

- Vortex Separators
- Swirl Concentrators
- Gross solids removal devices (GSRDs)



Hydrodynamic Separation Device
Source: Contech Stormwater Solution, Inc.

Opportunity Criteria

- Hydrodynamic separation devices are effective for the removal of coarse sediment, trash, and debris, and are useful as pretreatment in combination with other BMP types that target smaller particle sizes. They are most effective in urban areas where coarse sediment, trash, and debris are pollutants of concern.
- Hydrodynamic devices represent a wide range of device types that have different unit processes and design elements (e.g., storage versus flow-through designs, inclusion of media filtration, etc.) that vary significantly within the category. These design features likely have significant effects on BMP performance; therefore, generalized performance data for hydrodynamic devices is not practical.

OC-Specific Design Criteria and Considerations

- Proprietary hydrodynamic device BMP vendors are constantly updating and expanding their product lines so refer to the latest design guidance from each of the vendors. General guidelines on the performance, operations and maintenance of proprietary devices are provided by the vendors.
- Operations and maintenance requirements include: clearing trash, debris, and sediment around insert grate and inside chamber, and repairing screens and media if damaged or severely clogged.

Computing Sizing Criteria for Hydrodynamic Devices

- Hydrodynamic separation devices should be adequately sized to pretreat the entire design volume or design flow rate of the downstream BMP.
- The required design flowrate should be calculated based on the Capture Efficiency Method for Flow-based BMPs (See **Appendix III**) to achieve 80 percent capture of the average annual stormwater runoff volume.

Proprietary Hydrodynamic Device Manufacturer Websites

- **Table XIV.1** is a list of manufacturers that provide hydrodynamic separation devices. The inclusion of these manufacturers does not represent an endorse of their products. Other devices and manufacturers may be acceptable for pretreatment.

Table XIV.1: Proprietary Hydrodynamic Device Manufacturer Websites

Device	Manufacturer	Website
Rinker In-Line Stormceptor®	Rinker Materials™	www.rinkerstormceptor.com
FloGard® Dual-Vortex Hydrodynamic Separator	KriStar Enterprises Inc.	www.kristar.com
Contech® CDS ^a ™	Contech® Construction Products Inc.	www.contech-cpi.com
Contech® Vortechs™	Contech® Construction Products Inc.	www.contech-cpi.com
Contech® Vorsentry™	Contech® Construction Products Inc.	www.contech-cpi.com
Contech® Vorsentry™ HS	Contech® Construction Products Inc.	www.contech-cpi.com
BaySaver BaySeparator	Baysaver Technologies Inc.	www.baysaver.com

Additional References for Design Guidance

- CASQA BMP Handbook for New and Redevelopment:
<http://www.cabmphandbooks.com/Documents/Development/MP-51.pdf>
- Los Angeles County Stormwater BMP Design and Maintenance Manual, Chapter 9:
http://dpw.lacounty.gov/DES/design_manuals/StormwaterBMPDesignandMaintenance.pdf

PRE-2: Catch Basin Insert Fact Sheet

Catch basin inserts are manufactured filters or fabric placed in a drop inlet to remove sediment and debris and may include sorbent media (oil absorbent pouches) to remove floating oils and grease. Catch basin inserts are selected specifically based upon the orientation of the inlet and the expected sediment and debris loading.

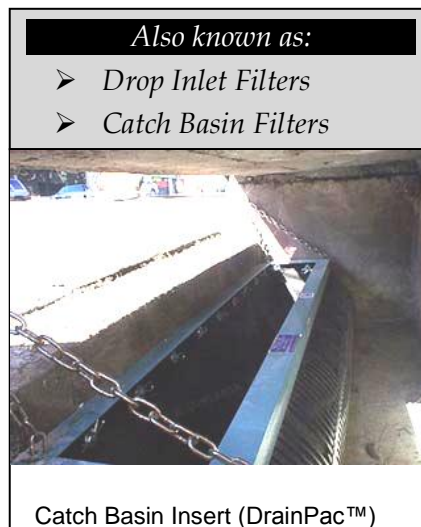

Opportunity Criteria

- Catch basin inserts come in such a wide range of configurations that it is practically impossible to generalize the expected performance. Inserts should mainly be used for catching coarse sediments and floatable trash and are effective as pretreatment in combination with other types of structures that are recognized as water quality treatment BMPs. Trash and large objects can greatly reduce the effectiveness of catch basin inserts with respect to sediment and hydrocarbon capture.
- Catch basin inserts are applicable for drainage area that include parking lots, vehicle maintenance areas, and roadways with catch basins that discharge directly to a receiving water.

OC-Specific Design Criteria and Considerations

- Frequent maintenance and the use of screens and grates to keep trash out may decrease the likelihood of clogging and prevent obstruction and bypass of incoming flows.
- Consult proprietors for specific criteria concerning the design of catch basin inserts.
- Catch basin inserts can be installed with specific media for pollutants of concern.

Proprietary Manufacturer / Supplier Websites

- **Table XIV.2** is a list of manufacturers that provide catch basin inserts. The inclusion of these manufacturers does not represent an endorse of their products. Other devices and manufacturers may be acceptable for pretreatment.

Table XIV.2: Proprietary Catch Basin Insert Manufacturer Websites

Device	Manufacturer	Website
AbTech Industries Ultra-Urban Filter™	AbTech Industries	www.abtechindustries.com
Aquashield Aqua-Guardian™ Catch Basin Insert	Aquashield™ Inc.	www.aquashieldinc.com
Bowhead StreamGuard™	Bowhead Environmental & Safety, Inc.	http://www.shopbowhead.com/
Contech® Triton Catch Basin Filter™	Contech® Construction Products Inc.	www.contech-cpi.com
Contech® Triton Curb Inlet Filter™	Contech® Construction Products Inc.	www.contech-cpi.com

Table XIV.2: Proprietary Catch Basin Insert Manufacturer Websites

Device	Manufacturer	Website
Contech® Triton Basin StormFilter™	Contech® Construction Products Inc.	www.contech-cpi.com
Contech® Curb Inlet StormFilter™	Contech® Construction Products Inc.	www.contech-cpi.com
Curb Inlet Basket	SunTree Technologies Inc.	www.suntreetech.com
Curb Inlet Grates	EcoSense International™	http://www.ecosenseint.com/
DrainPac™	United Storm Water, Inc.	http://www.unitedstormwater.com
Grate Inlet Skimmer Box	SunTree Technologies Inc.	www.suntreetech.com
KriStar FloGard+PLUS®	KriStar Enterprises Inc.	www.kristar.com
KriStar FloGard®	KriStar Enterprises Inc.	www.kristar.com
KriStar FloGard LoPro Matrix Filter®	KriStar Enterprises Inc.	www.kristar.com
Nyloplast Storm-PURE Catch Basin Insert	Nyloplast Engineered Surface Drainage Products	www.nyloplast-us.com
StormBasin®	FabCo® Industries Inc.	www.fabco-industries.com
Stormdrain Solutions Interceptor	FabCo® Industries Inc.	www.fabco-industries.com
Stormdrain Solutions Inceptor®	Stormdrain Solutions	www.stormdrains.com
StormPod®	FabCo® Industries Inc.	www.fabco-industries.com
Stormwater Filtration Systems	EcoSense International™	http://www.ecosenseint.com/
Ultra-CurbGuard®	UltraTech International Inc.	www.spillcontainment.com
Ultra-DrainGuard®	UltraTech International Inc.	www.spillcontainment.com
Ultra-GrateGuard®	UltraTech International Inc.	www.spillcontainment.com
Ultra-GutterGuard®	UltraTech International Inc.	www.spillcontainment.com
Ultra-InletGuard®	UltraTech International Inc.	www.spillcontainment.com

APPENDIX XV. WORKSHEETS

This section provides hyperlinks to each of the worksheets embedded in text of these TGD Appendices.

- [Worksheet A: Hydrologic Source Control Calculation Form \(III-7\)](#)
- [Worksheet B: Simple Design Capture Volume Sizing Method \(III-16\)](#)
- [Worksheet C: Capture Efficiency Method for Volume-Based, Constant Drawdown BMPs \(III-20\)](#)
- [Worksheet D: Capture Efficiency Method for Flow-Based BMPs \(III-24\)](#)
- [Worksheet E: Determining Capture Efficiency of Volume Based, Constant Drawdown BMP based on Design Volume \(III-29\)](#)
- [Worksheet F: Determining Capture Efficiency of a Flow-based BMP based on Treatment Capacity \(III-33\)](#)
- [Worksheet G: Alternative Compliance Volume Worksheet \(VI-7\)](#)
- [Worksheet H: Factor of Safety and Design Infiltration Rate and Worksheet \(VII-35\)](#)
- [Worksheet I: Summary of Groundwater-related Feasibility Criteria \(VIII-13\)](#)
- [Worksheet J: Summary of Harvested Water Demand and Feasibility \(X-13\)](#)

APPENDIX XVI. EXHIBITS

XVI.1. Rainfall Zones Map

Figure XVI.1: Orange County Rainfall Zones Map

Exhibit on following page

SUBJECT TO FURTHER REVISION

LEGEND

- Orange County Precipitation Stations
- 24 Hour, 85th Percentile Rainfall (Inches)
- - - 24 Hour, 85th Percentile Rainfall (Inches) - Extrapolated
- City Boundaries

Rainfall Zones

Design Capture Storm Depth (inches)

- 0.65"
- 0.7
- 0.75
- 0.80
- 0.85
- 0.90
- 0.95
- 1.00
- 1.10"

Note: Events defined as 24-hour periods (calendar days) with greater than 0.1 inches of rainfall.
For areas outside of available data coverage, professional judgment shall be applied.

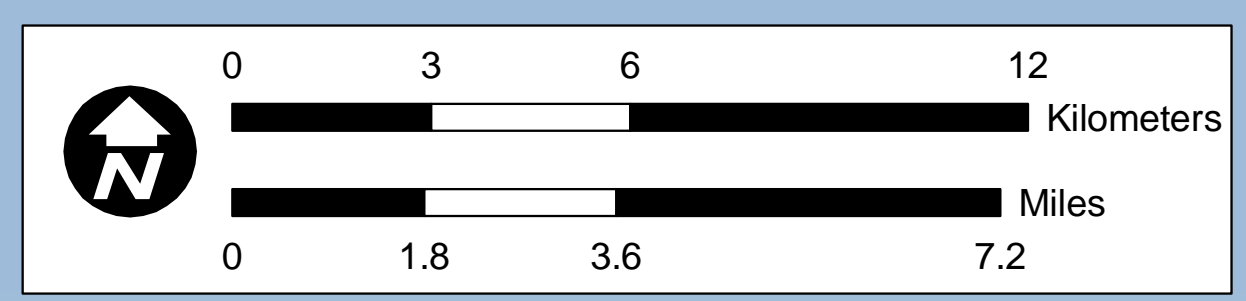
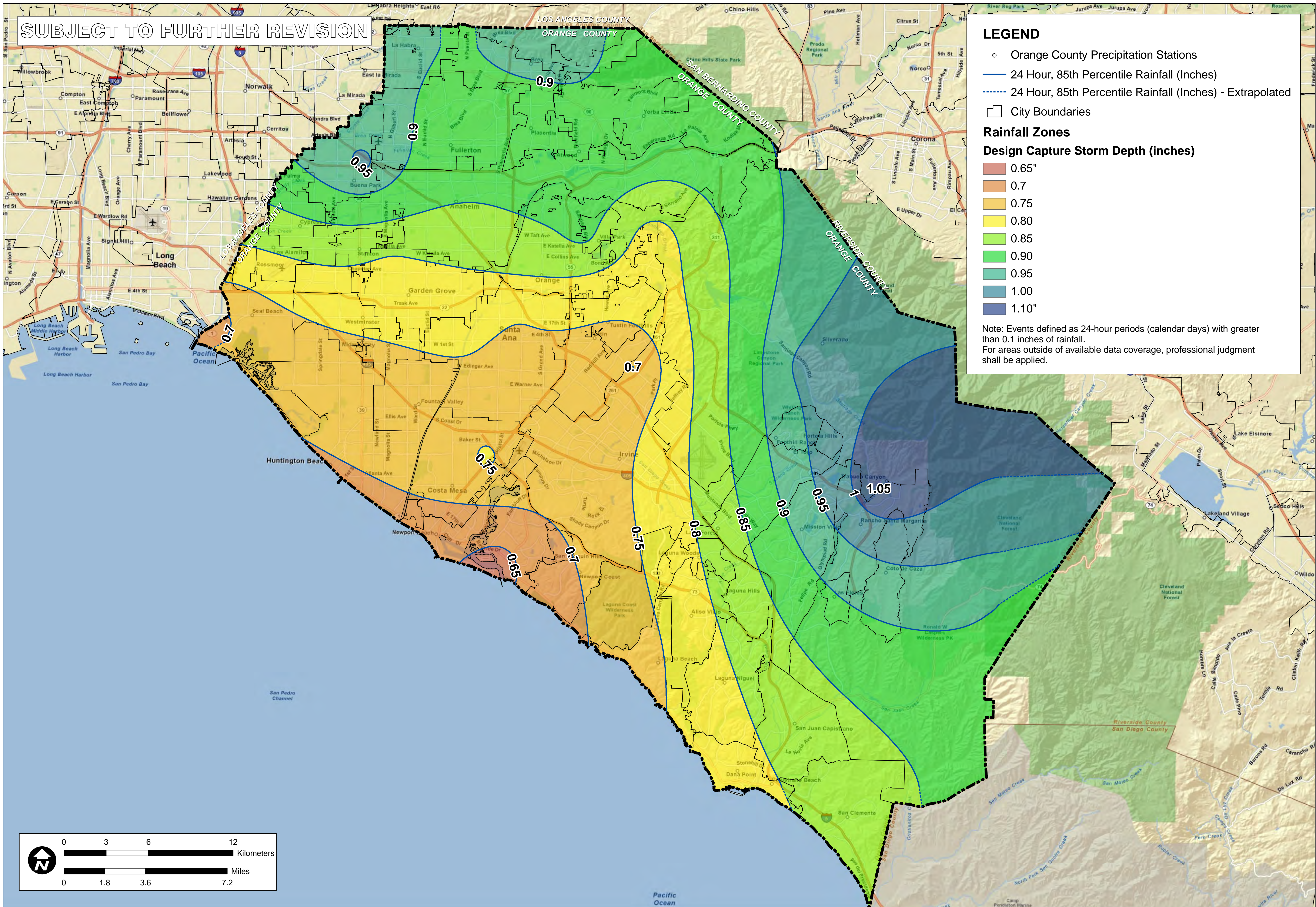

ORANGE COUNTY
TECHNICAL GUIDANCE
DOCUMENT

RAINFALL ZONES

TITLE
 JOB
 SCALE 1" = 1.8 miles
 DESIGNED TH
 DRAWING TH
 CHECKED BMP
 DATE 04/22/10
 JOB NO. 9526-E

ORANGE CO. CA



FIGURE
XVI-1

P:\9526E\6-GIS\Mxd\Reports\Infiltration\Feasibility_20110215\9526E_FigureXVI-1_RainfallZones_20110215.mxd





XVI.2. Infiltration Feasibility Constraints Maps

Figure XVI.2: Infiltration Feasibility Constraints Maps

Exhibits start on following page

SUBJECT TO FURTHER REVISION

LEGEND

-  City Boundaries
- Hydrologic Soil Groups**
-  A Soils
-  B Soils
-  C Soils
-  D Soils

Source:
 Soils: Natural Resources Conservation Service (NRCS)
 Soil Survey - soil_ca678, Orange County & Western Riverside
 Date of publication: 2006-02-08
<http://websoilsurvey.nrcs.usda.gov/app/HomePage.htm>

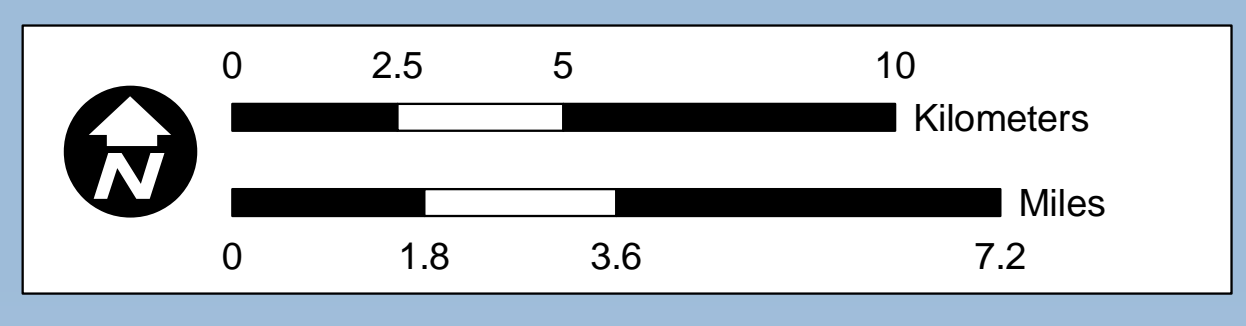
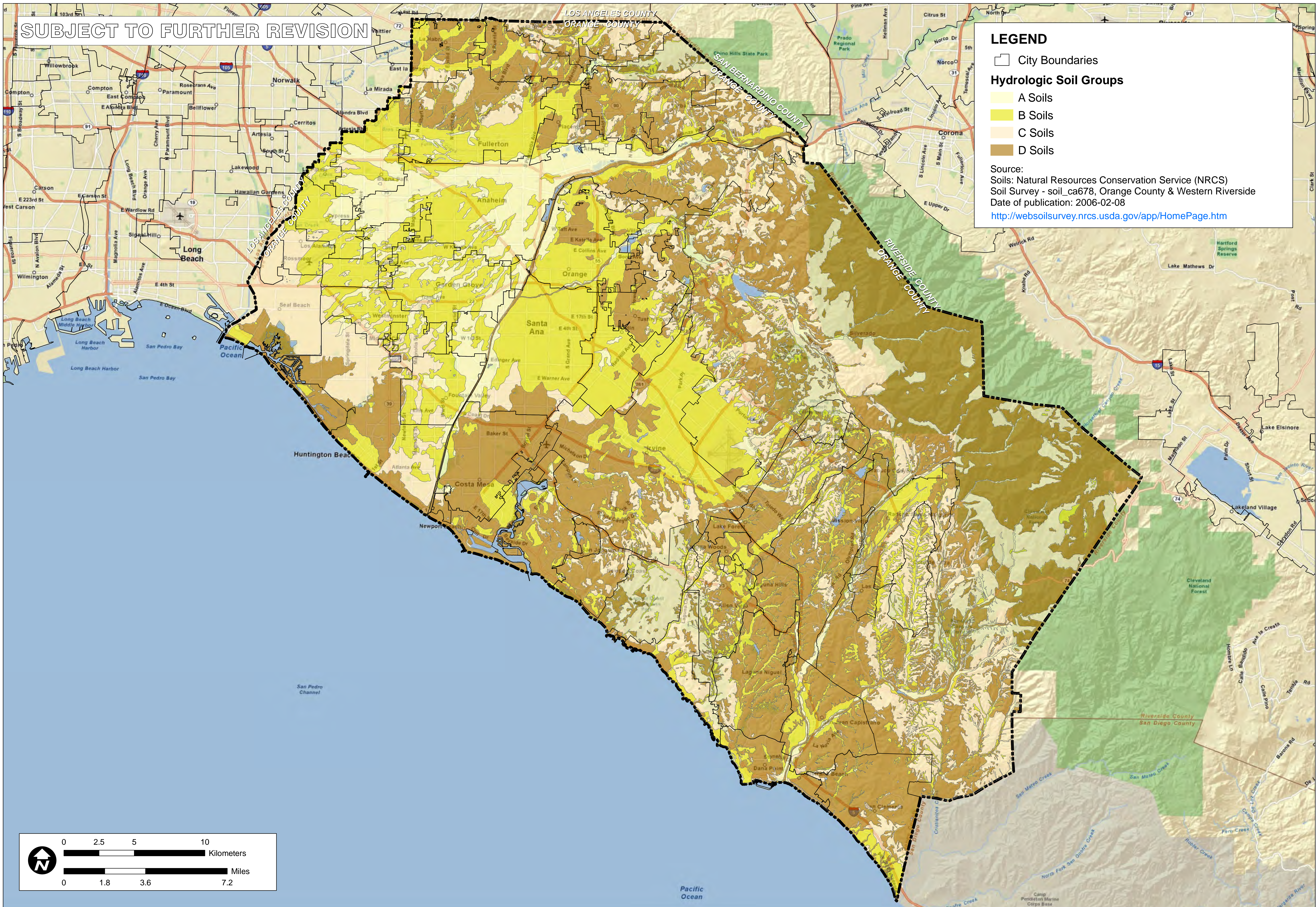

TITLE: NRCS HYDROLOGIC SOILS GROUPS
 JOB: ORANGE COUNTY INFILTRATION STUDY
 SCALE: 1" = 1.8 miles
 DESIGNED: TH
 DRAWING: TH
 CHECKED: BMP
 DATE: 02/09/11
 JOB NO.: 9526-E
 ORANGE CO. CA



PACE
Advanced Water Engineering

FIGURE XVI-2a

P:\9526E\6-GIS\Mxd\Reports\InfiltrationFeasibility_20110215\9526E_FigureXVI-2a_HydroSoils_20110215.mxd

SUBJECT TO FURTHER REVISION

LEGEND

City Boundaries

Hydrologic Soil Groups

D Soils

Source:
D Soils: Natural Resources Conservation Service (NRCS)
Soil Survey - soil_ca678, Orange County & Western Riverside
Date of publication: 2006-02-08

<http://websoilsurvey.nrcs.usda.gov/app/HomePage.htm>

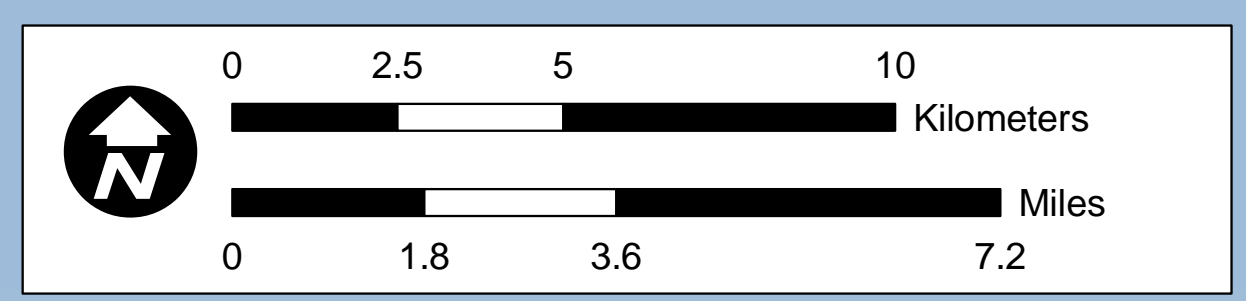
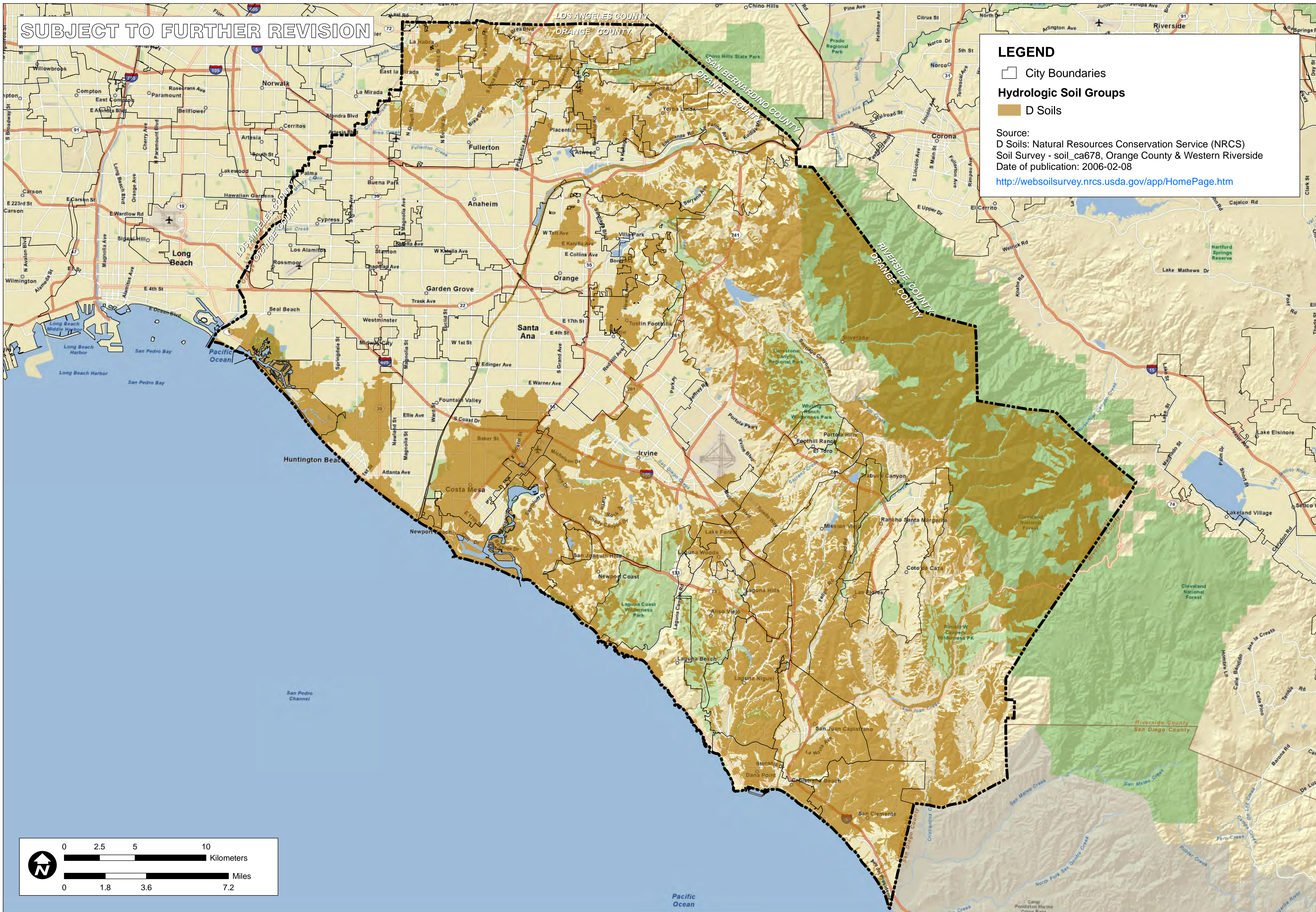

TITLE

JOB

SCALE 1" = 1.8 miles

DESIGNED TH

DRAWING TH

CHECKED BMP

DATE 02/09/11

JOB NO. 9526-E

ORANGE COUNTY

INFLTRATION STUDY

ORANGE CO.

CA

HYDROLOGIC SOIL GROUP

TYPE D NRCS SOIL SURVEY

FIGURE

XVI-2b



P:\9526E\6-GIS\Mxd\Reports\InfiltrationFeasibility_20110215\9526E_FigureXVI-2b_D-Soils_20110215.mxd

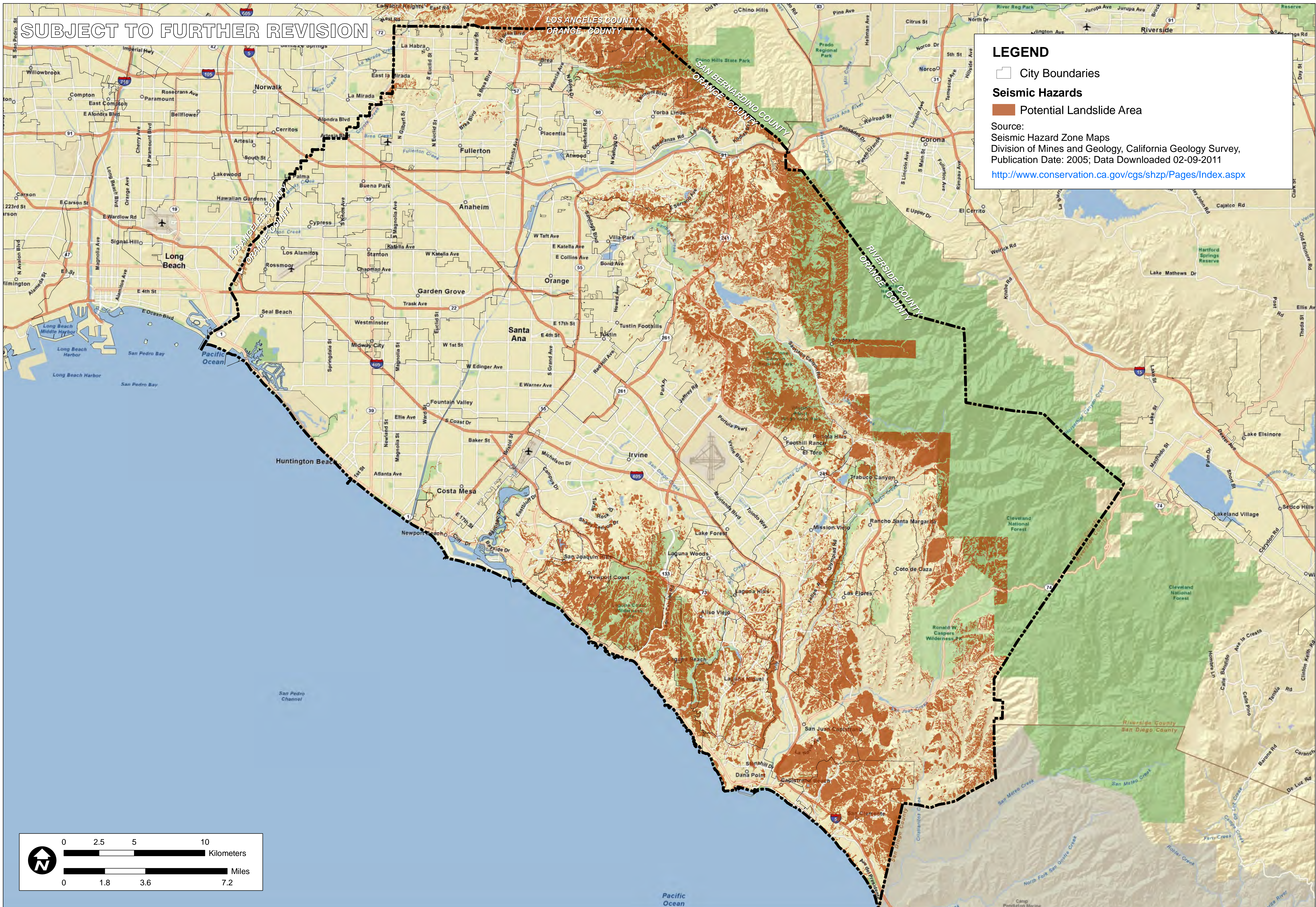

SUBJECT TO FURTHER REVISION

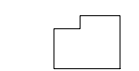

LEGEND

-  City Boundaries
- Seismic Hazards**
-  Potential Landslide Area

Source:
 Seismic Hazard Zone Maps
 Division of Mines and Geology, California Geology Survey,
 Publication Date: 2005; Data Downloaded 02-09-2011
<http://www.conservation.ca.gov/cgs/shzp/Pages/Index.aspx>

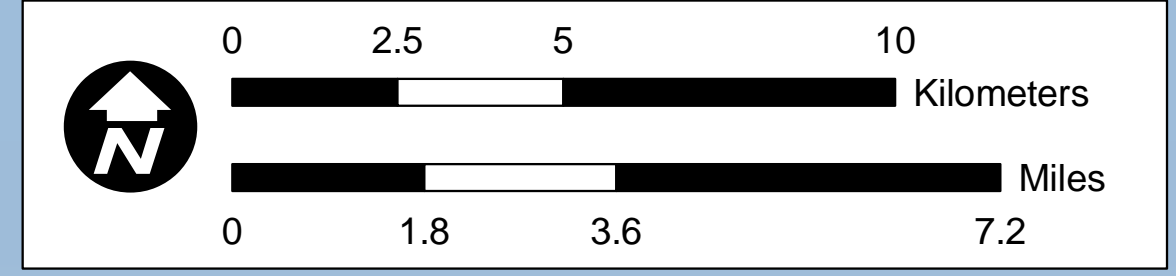

<p>ORANGE COUNTY INFILTRATION STUDY</p>		<p>CA</p>									
<p>ORANGE CO.</p>		<p>ORANGE CO.</p>									
<p>SCALE 1" = 1.25 miles</p> <table border="1" style="width: 100%; border-collapse: collapse;"> <tr> <td>DESIGNED</td> <td>TH</td> </tr> <tr> <td>DRAWING</td> <td>TH</td> </tr> <tr> <td>CHECKED</td> <td>BMP</td> </tr> <tr> <td>DATE</td> <td>02/09/11</td> </tr> <tr> <td>JOB NO.</td> <td>9526-E</td> </tr> </table>	DESIGNED	TH	DRAWING	TH	CHECKED	BMP	DATE	02/09/11	JOB NO.	9526-E	<p>TITLE</p> <p>HYDROLOGIC SOIL GROUP TYPE D NRCS SOIL SURVEY</p>
DESIGNED	TH										
DRAWING	TH										
CHECKED	BMP										
DATE	02/09/11										
JOB NO.	9526-E										
 <p>PACE Advanced Water Engineering</p>		<p>FIGURE</p> <p>XVI-2c</p>									

P:\9526E\6-GIS\Mxd\Reports\Infiltration\Feasibility_20110215\9526E_FigureXVI-2c_Landslides_20110215.mxd

SUBJECT TO FURTHER REVISION

LEGEND

- Depth To First Groundwater Contours
- City Boundaries
- ▭ OCWD Groundwater Basin Protection Boundary

Note: Data are not available for South Orange County at this time.

Source:
Sprotte, Fuller and Greenwood, 1980.
California Division of Mines and Geology;
California Geological Survey

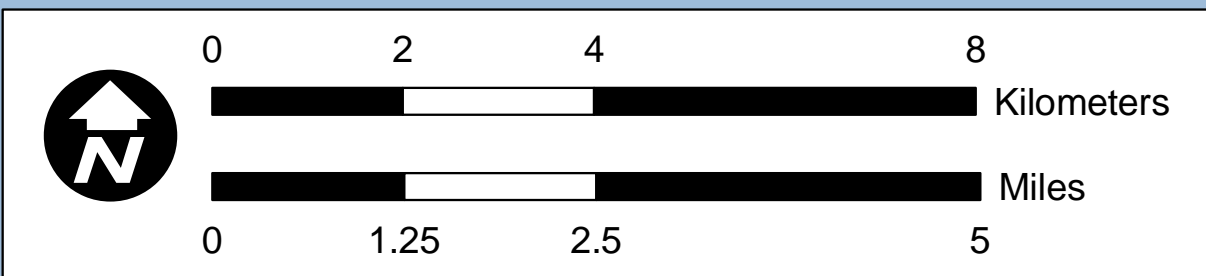
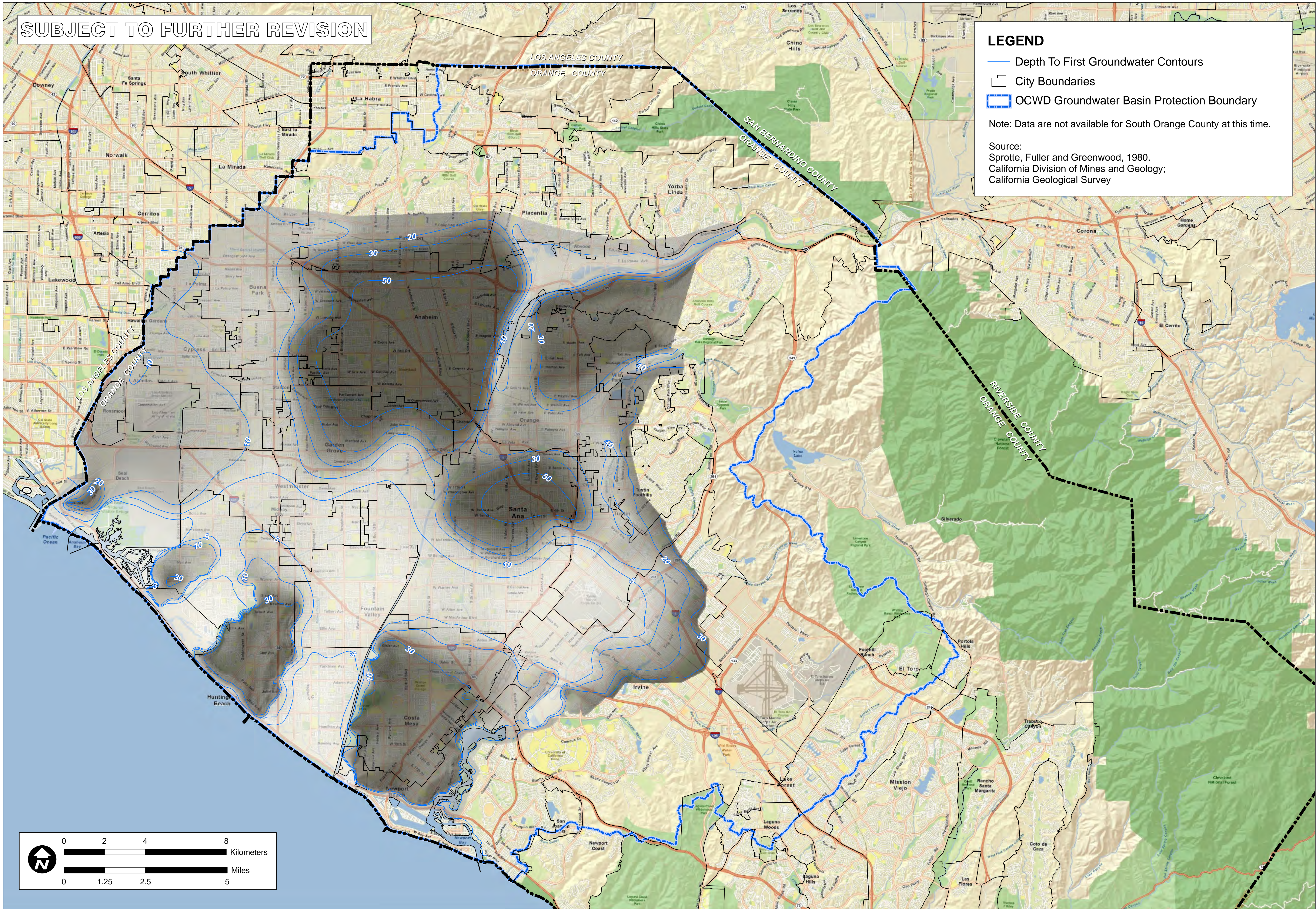

TITLE: NORTH ORANGE COUNTY MAPPED DEPTH TO FIRST GROUNDWATER

JOB: ORANGE COUNTY INFILTRATION STUDY

SCALE: 1" = 1.25 miles

DESIGNED	TH
DRAWING	TH
CHECKED	BMP
DATE	02/09/11
JOB NO.	9526-E

ORANGE CO. CA

FIGURE: XVI-2d



P:\9526E\6-GIS\Mxd\Reports\Infiltration\Feasibility_20110215\9526E_FigureXVI-2d_DepthToGroundwaterOverview_20110215.mxd

SUBJECT TO FURTHER REVISION

LEGEND

-  City Boundaries
-  OCWD Groundwater Basin Protection Boundary

Depth To Groundwater

-  ≤ 5'
-  5-10'

Note: Data are not available for South Orange County at this time.

Source:
 Sprotte, Fuller and Greenwood, 1980.
 California Division of Mines and Geology;
 California Geological Survey

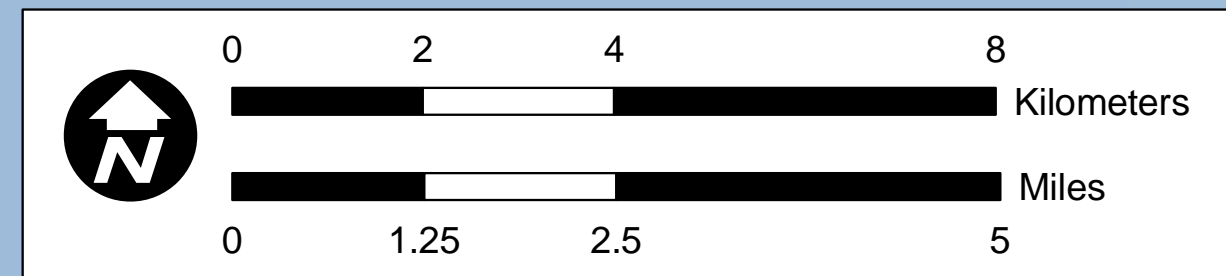
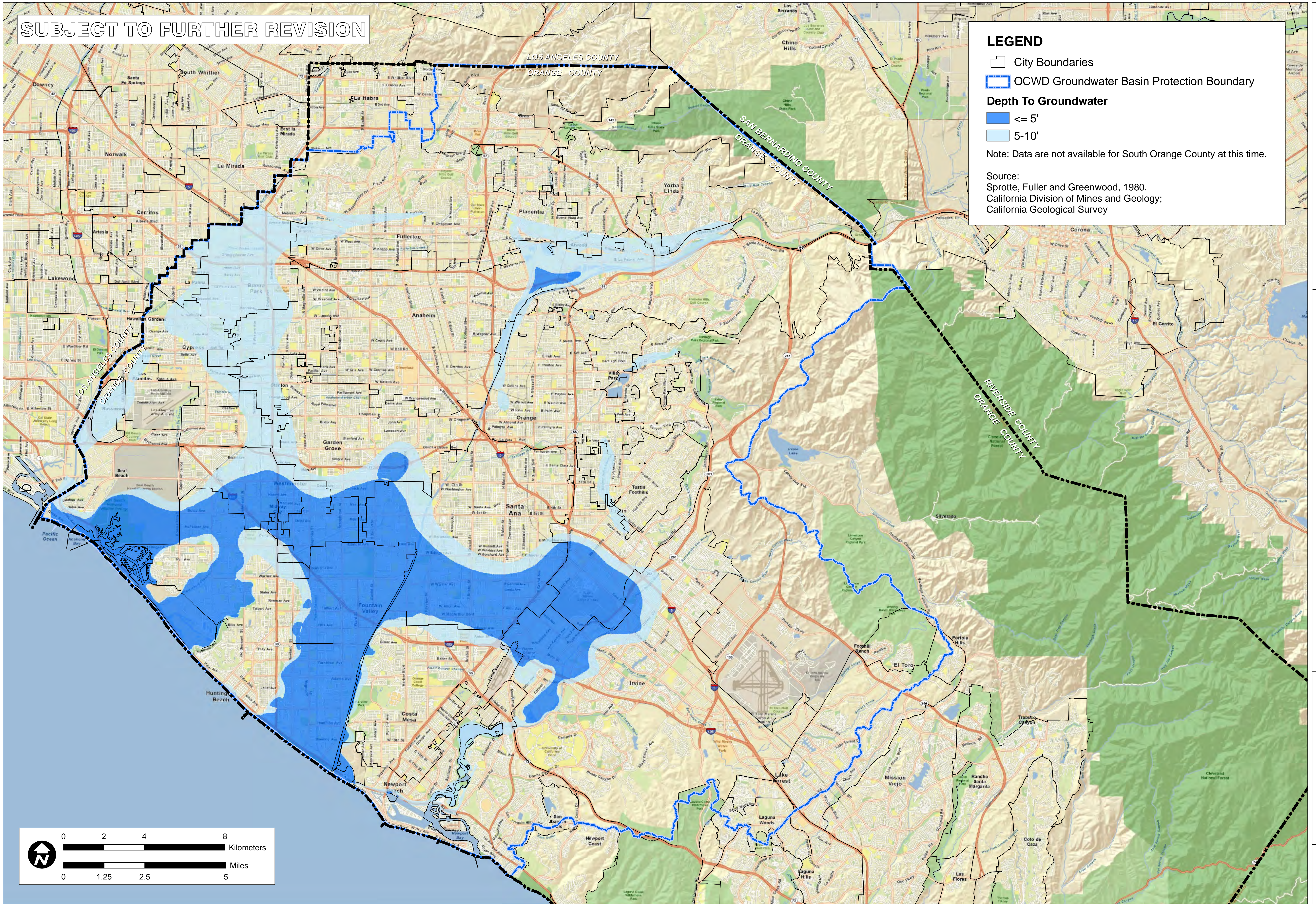

<p>TITLE</p> <p style="writing-mode: vertical-rl; transform: rotate(180deg);">NORTH ORANGE COUNTY MAPPED SHALLOW GROUNDWATER</p>	
<p>ORANGE COUNTY INFILTRATION STUDY</p>	
<p>JOB</p> <p>ORANGE CO.</p>	<p>CA</p>
<p>SCALE 1" = 1.25 miles</p>	<p>DESIGNED TH</p> <p>DRAWING TH</p> <p>CHECKED BMP</p> <p>DATE 02/09/11</p> <p>JOB NO. 9526-E</p>
	
<p>FIGURE</p> <p style="font-size: 24pt;">XVI-2e</p>	

P:\9526E\6-GIS\Mxd\Reports\InfiltrationFeasibility_20110215\9526E_FigureXVI-2e_DepthToGroundwater15ft_20110215.mxd

SUBJECT TO FURTHER REVISION

LEGEND

- City Boundaries
- OCWD Groundwater Basin Protection Boundary
- Plume Protection Boundaries**
- North Basin Groundwater Protection Project
- South Basin Groundwater Protection Project
- El Toro Marine Base
- Tustin Marine Air Base
- Approximate Selenium Contamination Area

Note: Individual contamination sites are not plotted. See State Water Resources Control Board Geotracker database (<http://geotracker.waterboards.ca.gov>), Department of Toxic Substance Control Envirostor database (<http://www.envirostor.dtsc.ca.gov>) and other applicable sources for current listing of active contaminated sites.

Groundwater basin and plume protection boundaries for South Orange County are not shown on this exhibit at this time

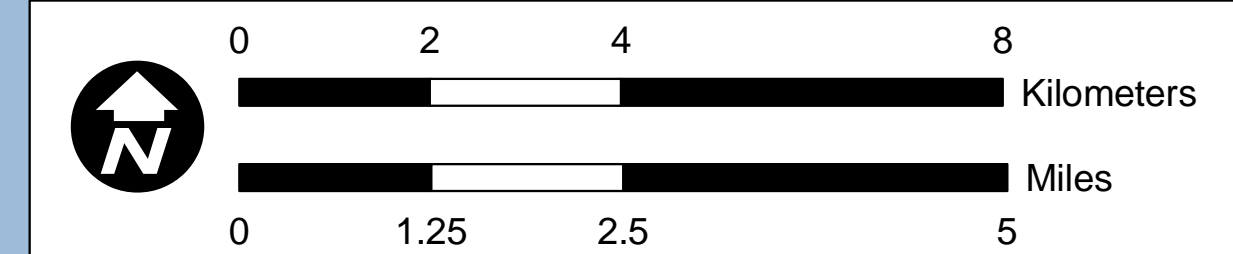
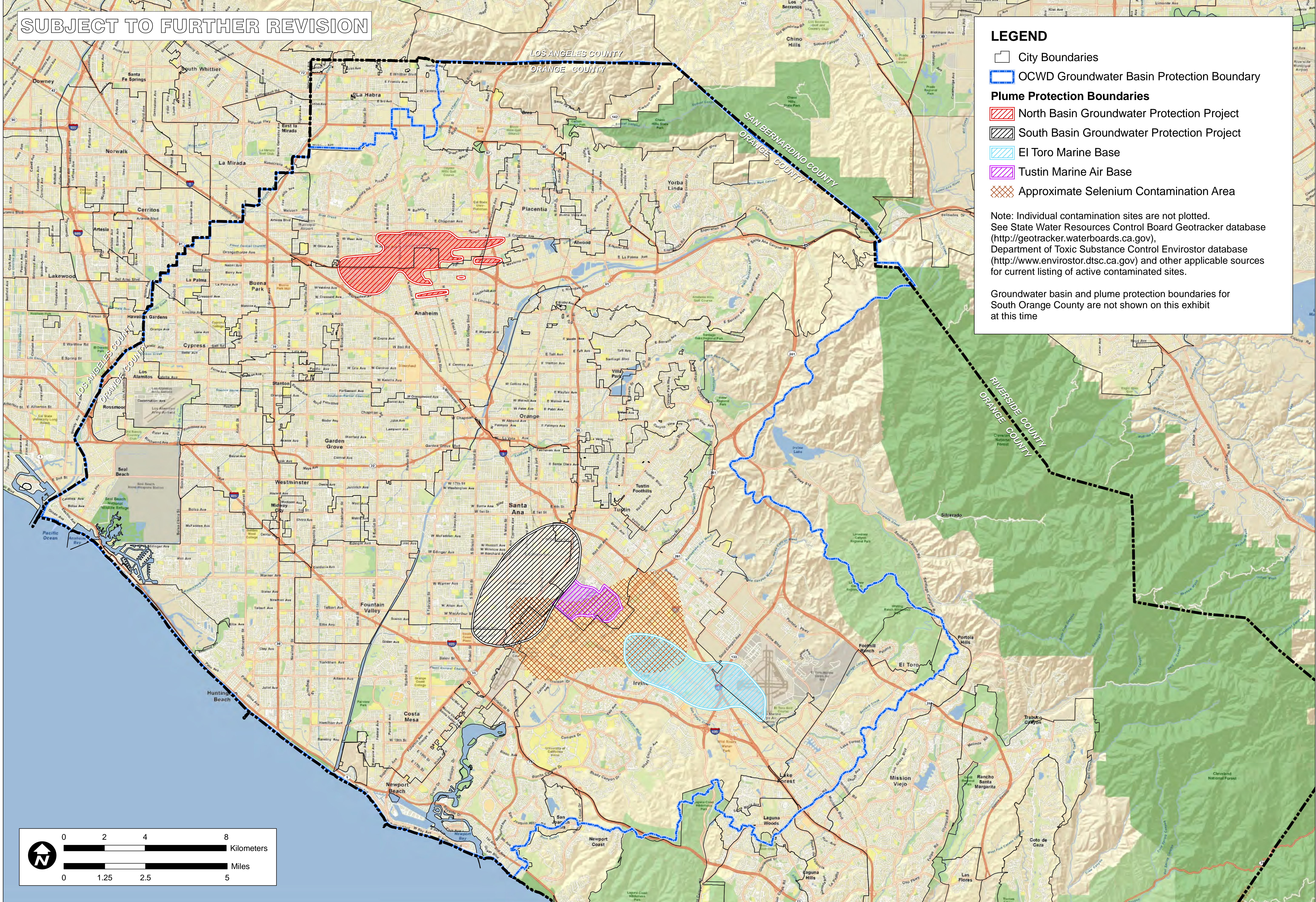

<p>NORTH ORANGE COUNTY GROUNDWATER PROTECTION AREAS</p>	
<p>ORANGE COUNTY INFILTRATION STUDY</p>	<p>CA</p>
<p>JOB</p>	
<p>SCALE 1" = 1.25 miles</p>	<p>DESIGNED TH</p>
<p>DRAWING TH</p>	<p>CHECKED BMP</p>
<p>DATE 04/22/10</p>	<p>JOB NO. 9526-E</p>
<p>ORANGE CO.</p>	
<p>FIGURE</p>	
<p>XVI-2f</p>	

P:\9526E\GIS\MapDocs\Reports\Infiltration\Feasibility_20110215\9526E_FigureXVI-2f_NorthOCGroundwaterProtectionAreasStreetMap_20110215.mxd

SUBJECT TO FURTHER REVISION

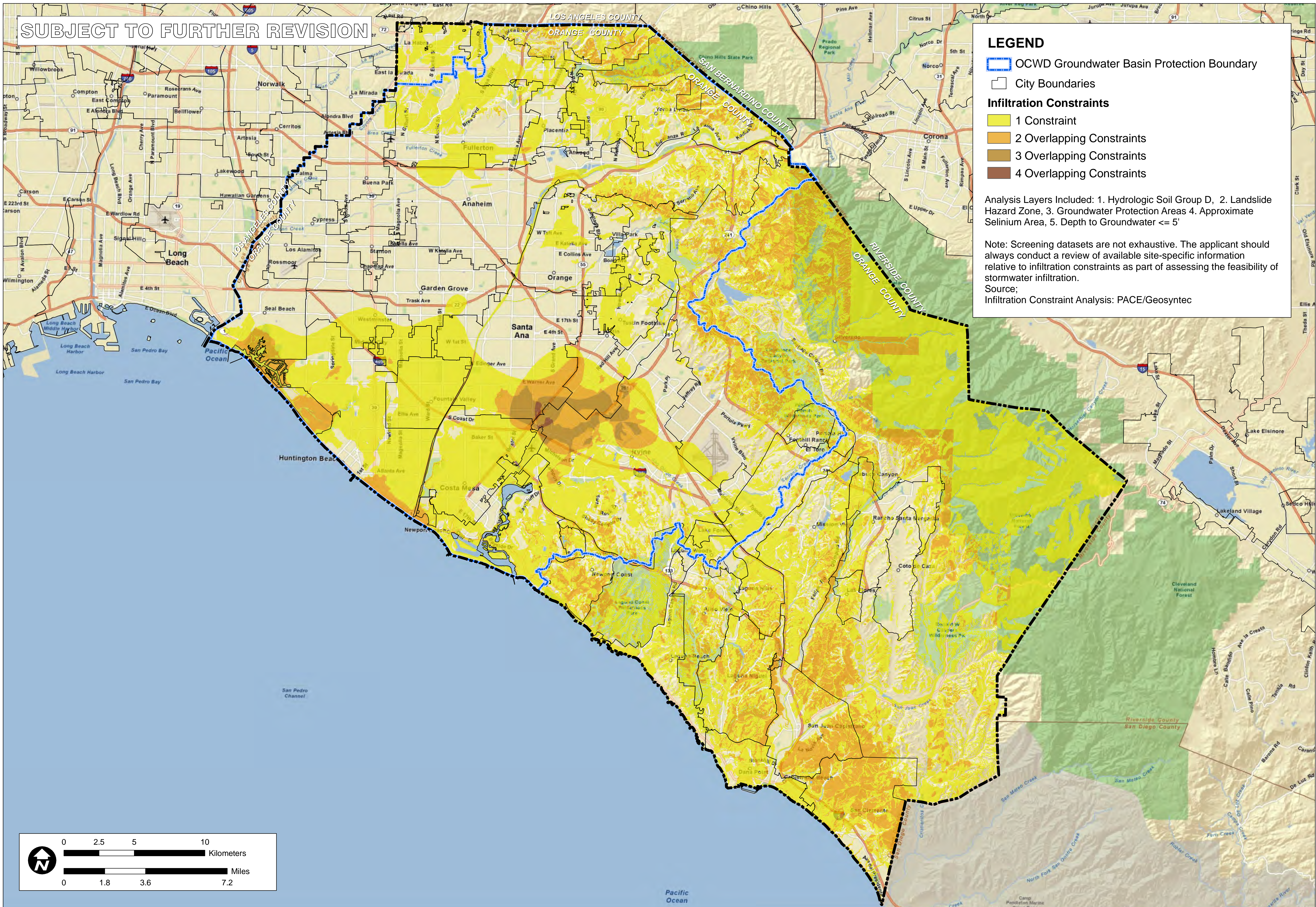

LEGEND

- OCWD Groundwater Basin Protection Boundary
- City Boundaries

Infiltration Constraints

- 1 Constraint
- 2 Overlapping Constraints
- 3 Overlapping Constraints
- 4 Overlapping Constraints

Analysis Layers Included: 1. Hydrologic Soil Group D, 2. Landslide Hazard Zone, 3. Groundwater Protection Areas 4. Approximate Selenium Area, 5. Depth to Groundwater <= 5'

Note: Screening datasets are not exhaustive. The applicant should always conduct a review of available site-specific information relative to infiltration constraints as part of assessing the feasibility of stormwater infiltration.

Source;
Infiltration Constraint Analysis: PACE/Geosyntec

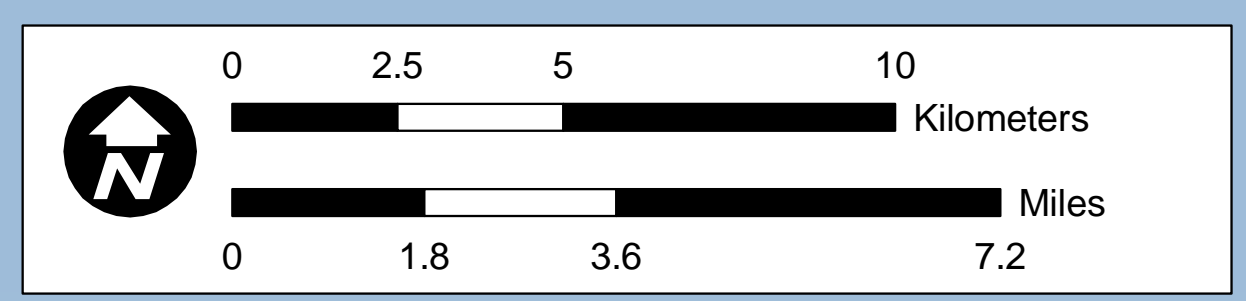

TITLE: INFILTRATION ANALYSIS OVERLAPPING CONSTRAINT LOCATIONS
 JOB: ORANGE COUNTY INFILTRATION STUDY
 SCALE: 1" = 1.8 miles
 DESIGNED: TH
 DRAWING: TH
 CHECKED: BMP
 DATE: 04/22/10
 JOB NO.: 9526-E
 ORANGE CO. CA

FIGURE XVI-2g

P:\9526E\6-GIS\Mxd\Reports\InfiltrationFeasibility_20110215\9526E_FigureXVI-2g_InfiltrationFinal_20110215.mxd

XVI.3. North Orange County Hydromodification Susceptibility Maps

Figure XVI.3: North Orange County Hydromodification Susceptibility Maps

Exhibits start on following page

PA\9526E\6-CIS\Mxd\Reports\InfiltrationFeasibility_20110215_9526E_FigureXVI-3a_SanGabrielCoyoteCreekWatershedSusceptibility_20100331.mxd

PRELIMINARY MAP SUBJECT TO FURTHER REVISION

Susceptibility

- Potential Areas of Erosion, Habitat, & Physical Structure Susceptibility

Channel Type

- Earth (Unstable)
- Earth (Stabilized)
- Stabilized

Tidel Influence

- <= Mean High Water Line (4.28')

Water Body

- Basin
- Lake
- Reservoir

Other Lands

- Airports/Military

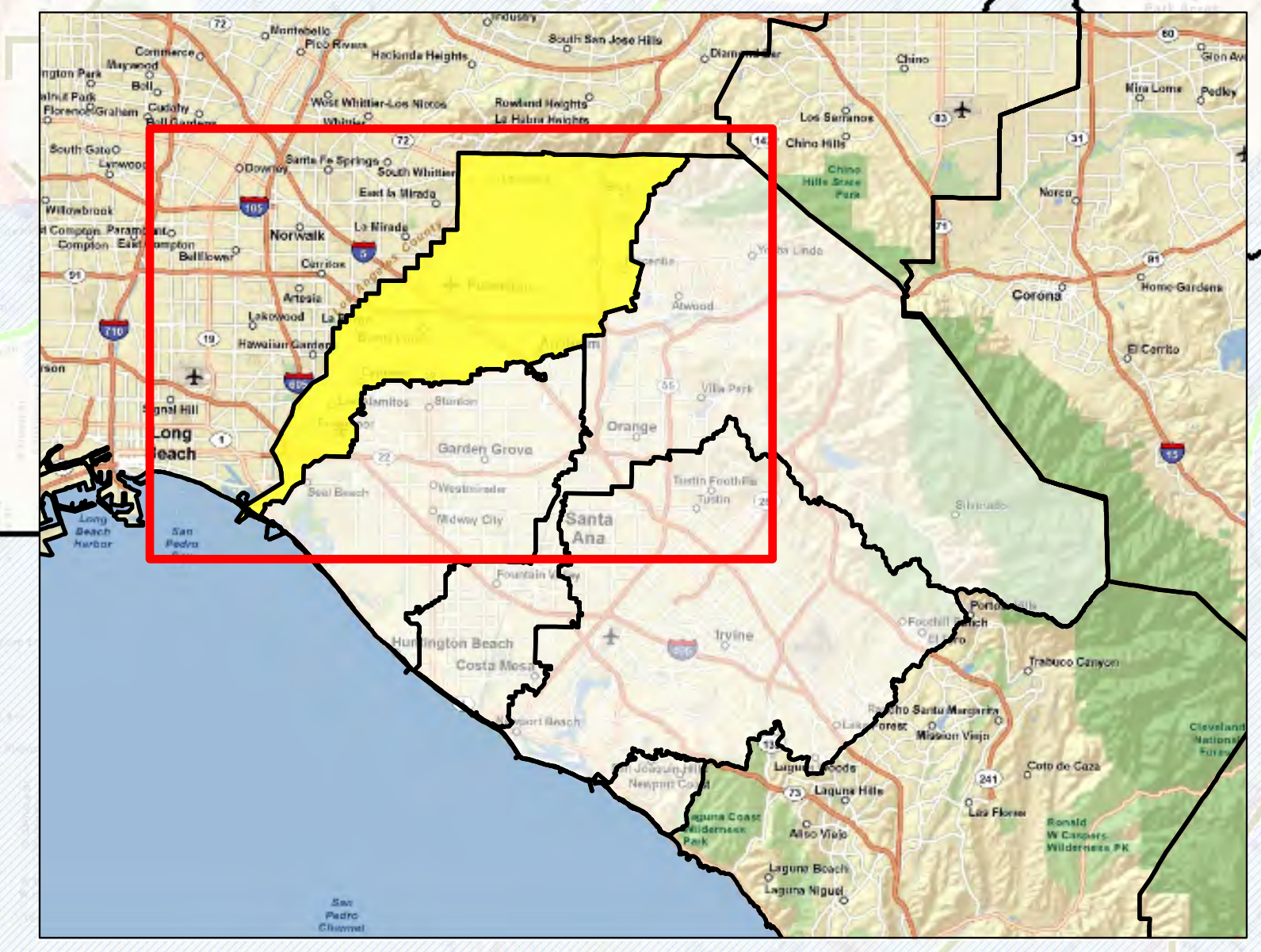
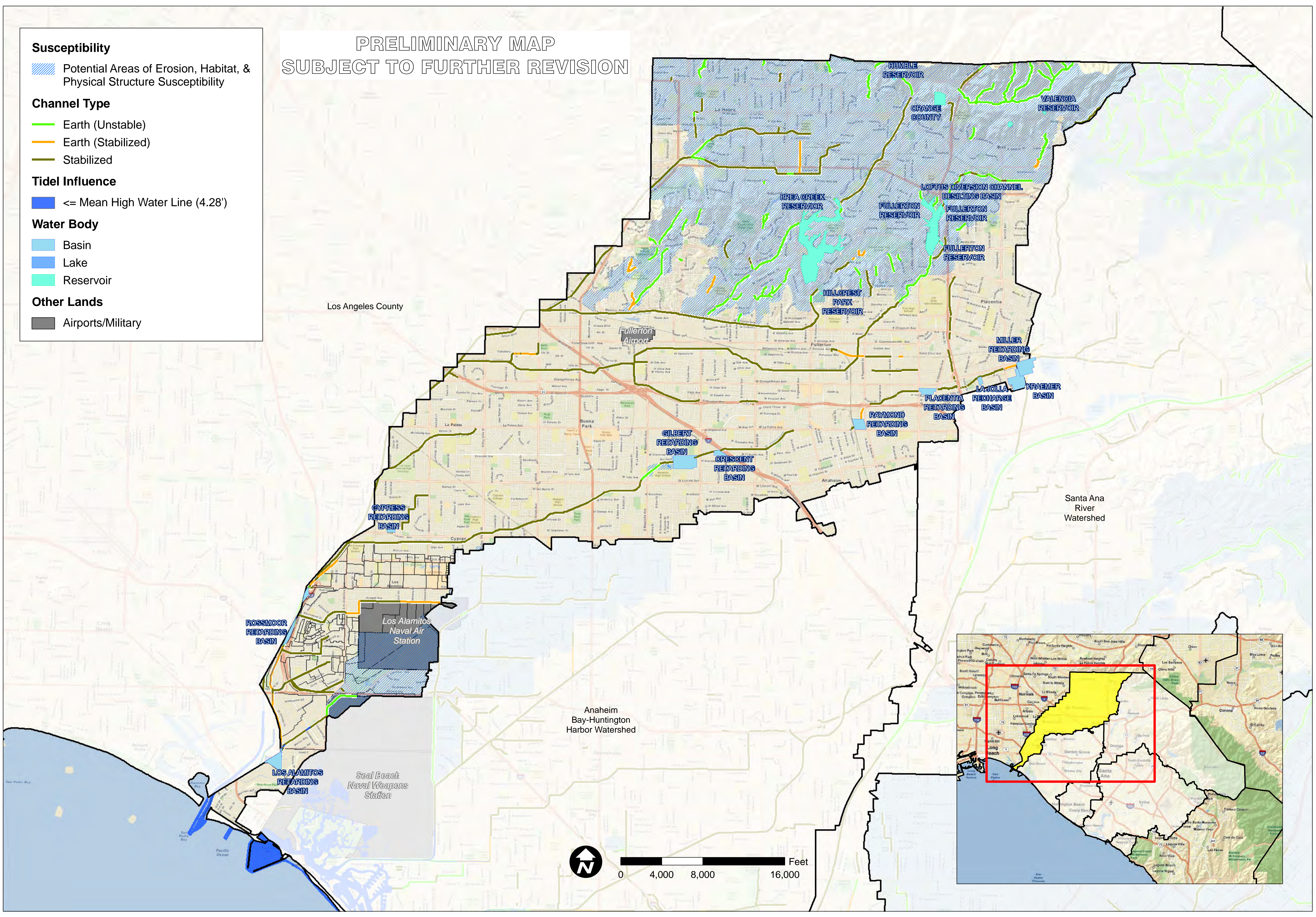

TITLE

SUSCEPTIBILITY ANALYSIS
SAN GABRIEL-COYOTE CREEK

JOB

ORANGE COUNTY
WATERSHED
MASTER PLANNING

CA

SCALE 1" = 4000'

DESIGNED	TH
DRAWING	TH
CHECKED	BMP
DATE	04/22/10
JOB NO.	9526-E

FIGURE

XVI-3a

ORANGE CO.



P:\9526E\6-CIS\Mxd\Reports\Infiltration\Feasibility_20110215_9526E_FigureXVI-3b_AnahaimBayWatershedSusceptibility_20100331.mxd

PRELIMINARY MAP - SUBJECT TO FURTHER REVISION

Susceptibility

 Potential Areas of Erosion, Habitat, & Physical Structure Susceptibility

Channel Type

 Earth (Unstable)

 Earth (Stabilized)

 Stabilized

Tidel Influence

 <= Mean High Water Line (4.28')

Water Body

 Basin

 Lake

Federal & Other Lands

 Seal Beach National Wildlife Refuge

 Airports/Military

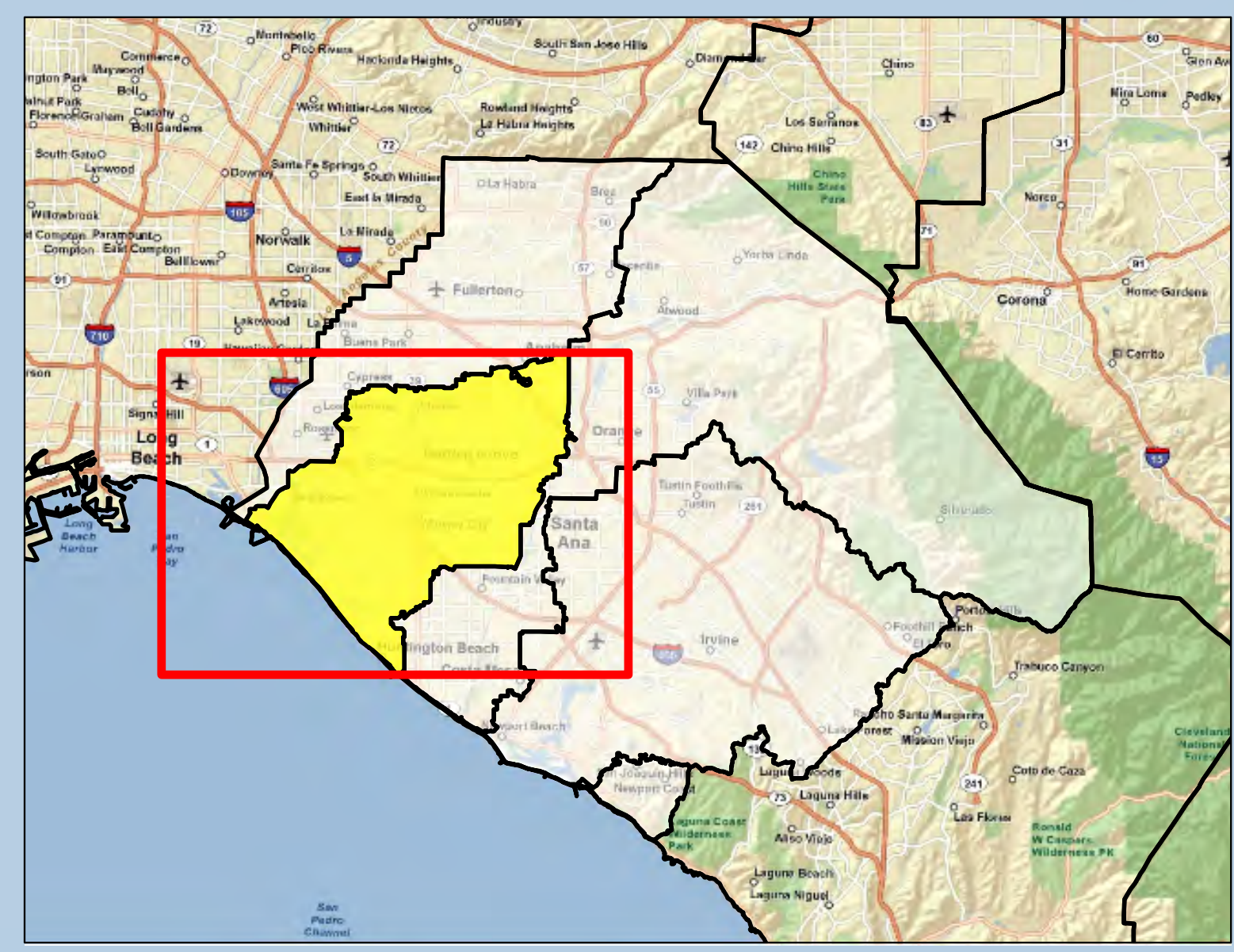
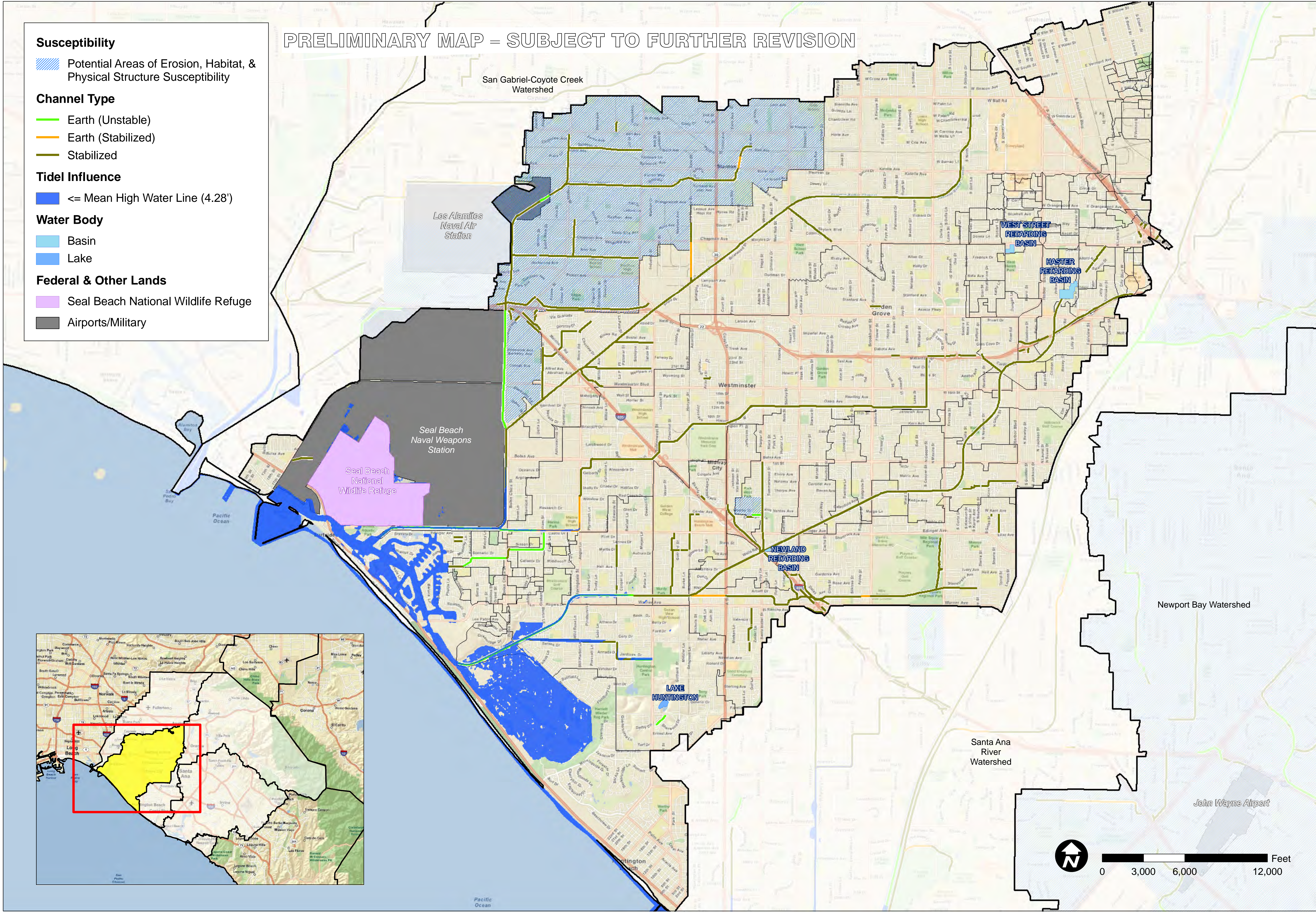

0 3,000 6,000 12,000 Feet

TITLE
SUSCEPTIBILITY ANALYSIS
ANAHEIM BAY-
HUNTINGTON HARBOR

JOB
ORANGE COUNTY
WATERSHED
MASTER PLANNING

SCALE	1" = 3000'
DESIGNED	TH
DRAWING	TH
CHECKED	BMP
DATE	04/22/10
JOB NO.	9526-E



FIGURE
XVI-3b

CA

ORANGE CO.

P:\9526E\6-GIS\Mxd\Reports\InfiltrationFeasibility\20110215\9526E_FigureXVI-3c_SantaAnaRiverSusceptibility_20100430.mxd

- Susceptibility**
- Potential Areas of Erosion, Habitat, & Physical Structure Susceptibility
- Channel Type**
- Earth (Unstable)
 - Earth (Stabilized)
 - Stabilized
- Tidel Influence**
- <= Mean High Water Line (4.28')
- Water Body**
- Basin
 - Dam
 - Lake
 - Reservoir
- Forest Areas**
- Cleveland National Forest
- Other Lands**
- Airport/Military

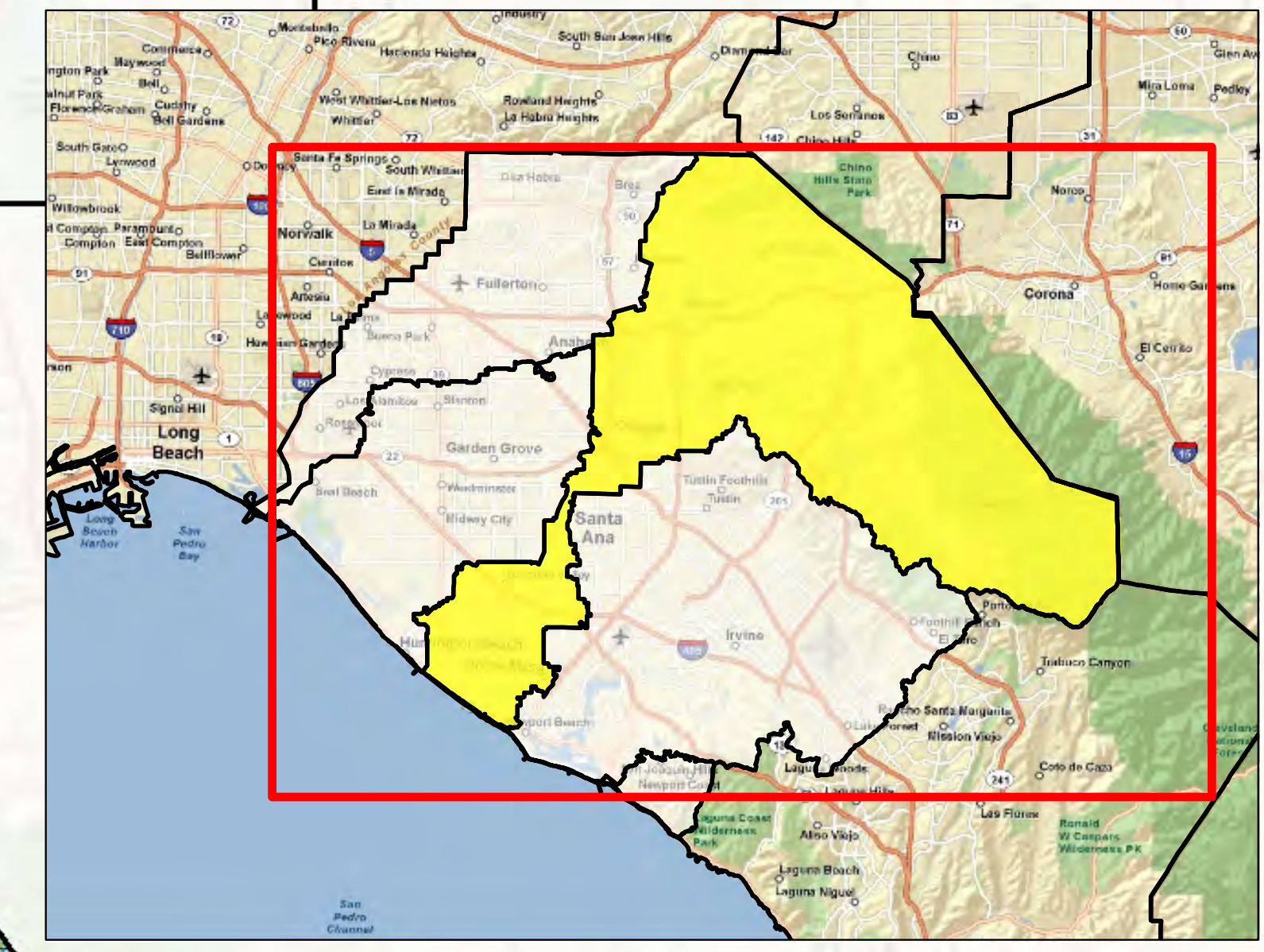
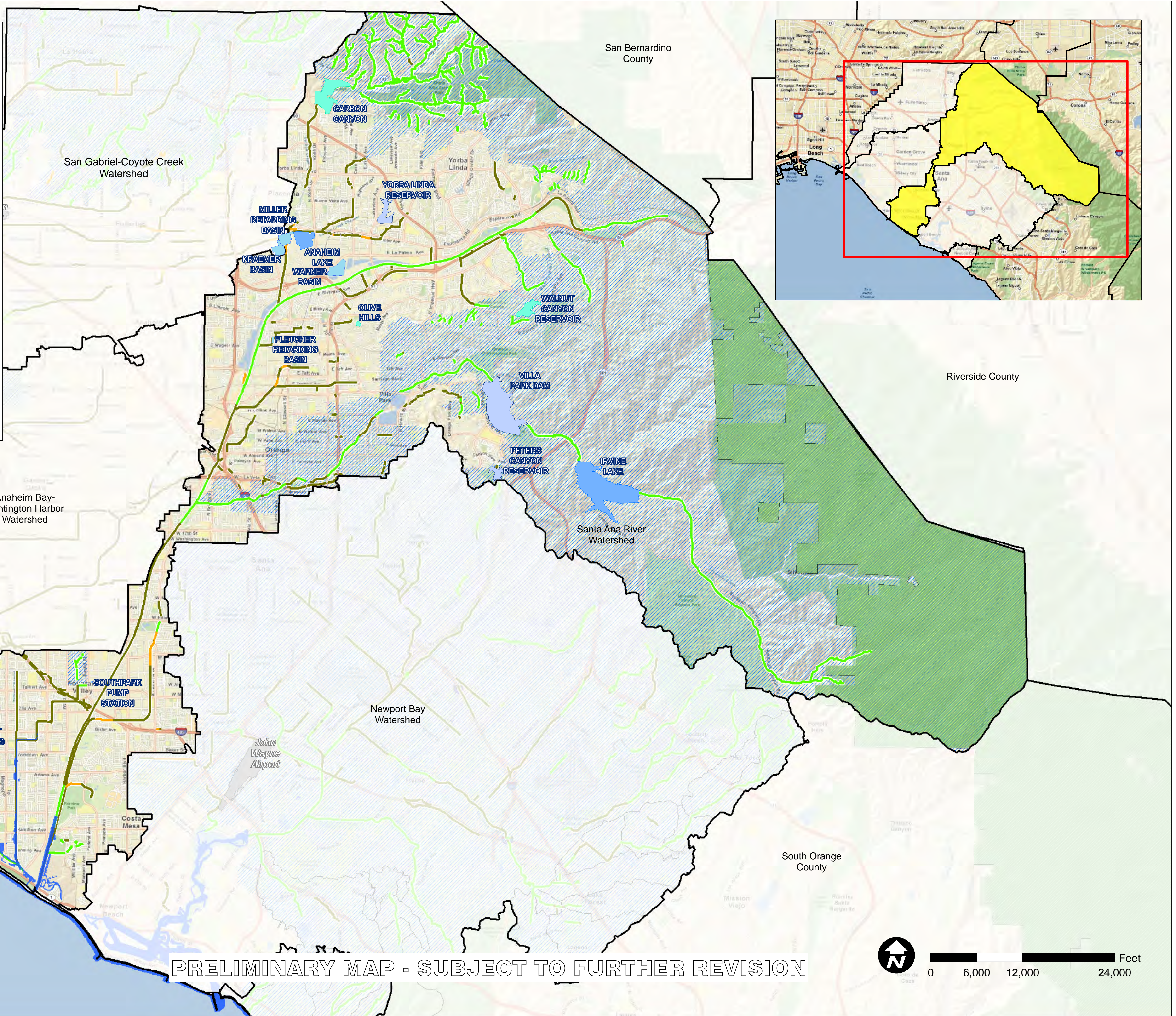

PRELIMINARY MAP - SUBJECT TO FURTHER REVISION

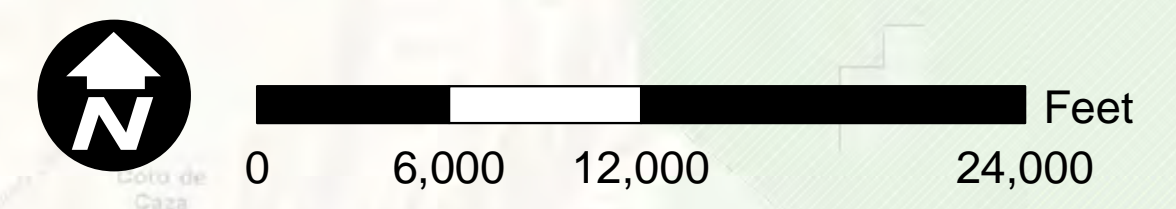

TITLE
SUSCEPTIBILITY ANALYSIS
SANTA ANA RIVER

JOB
ORANGE COUNTY
WATERSHED
MASTER PLANNING
ORANGE CO.
CA

SCALE	1" = 6000'
DESIGNED	TH
DRAWING	TH
CHECKED	BMP
DATE	04/30/10
JOB NO.	9526-E



FIGURE
XVI-3c

P:\9526E\6-GIS\Mxd\Reports\InfiltrationFeasibility_20110215\9526E_FigureXVI-3d_NewportBaySusceptibility_20100430.mxd

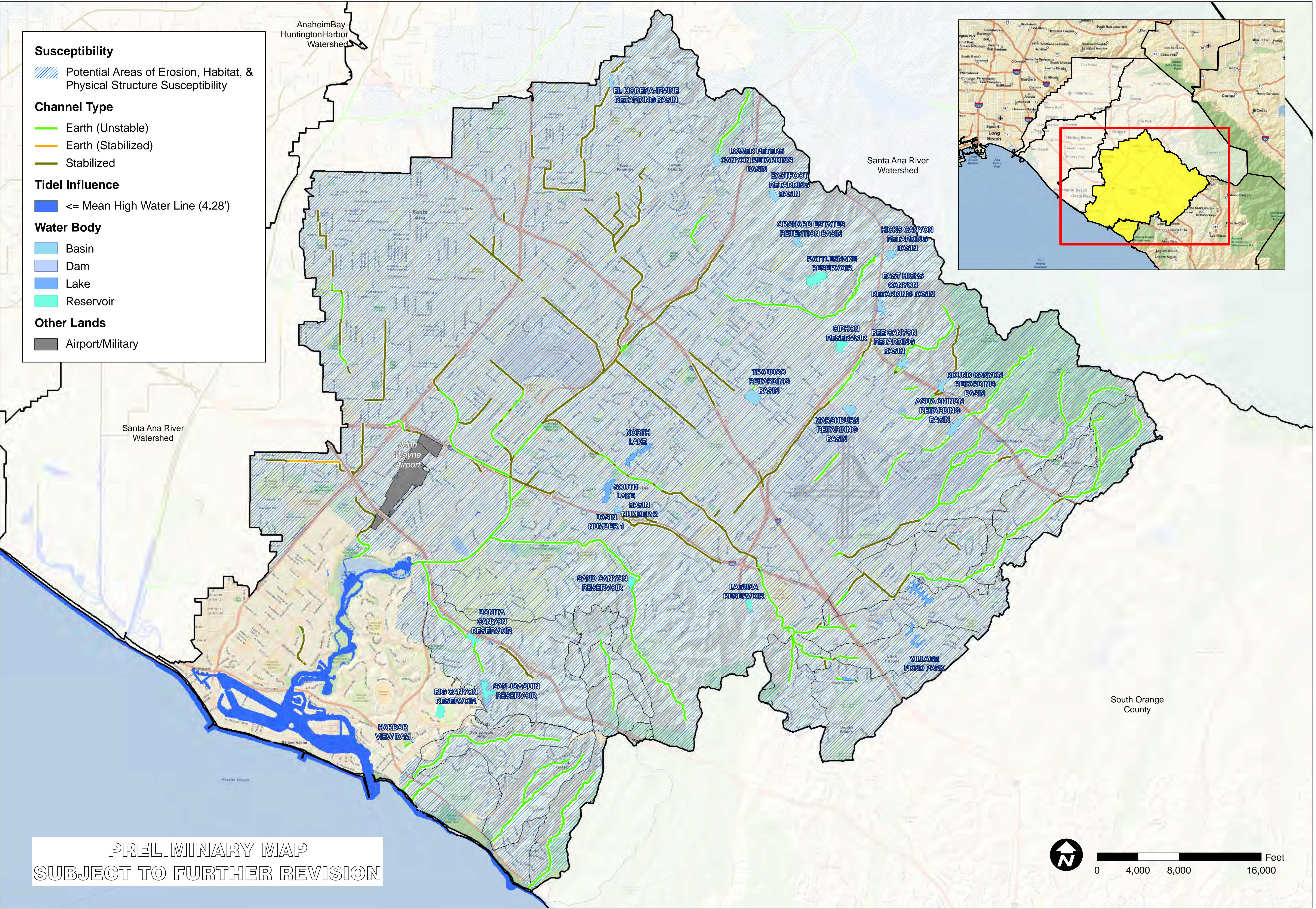

Susceptibility

- Potential Areas of Erosion, Habitat, & Physical Structure Susceptibility

Channel Type

- Earth (Unstable)
- Earth (Stabilized)
- Stabilized

Tidel Influence

- <= Mean High Water Line (4.28')

Water Body

- Basin
- Dam
- Lake
- Reservoir

Other Lands

- Airport/Military

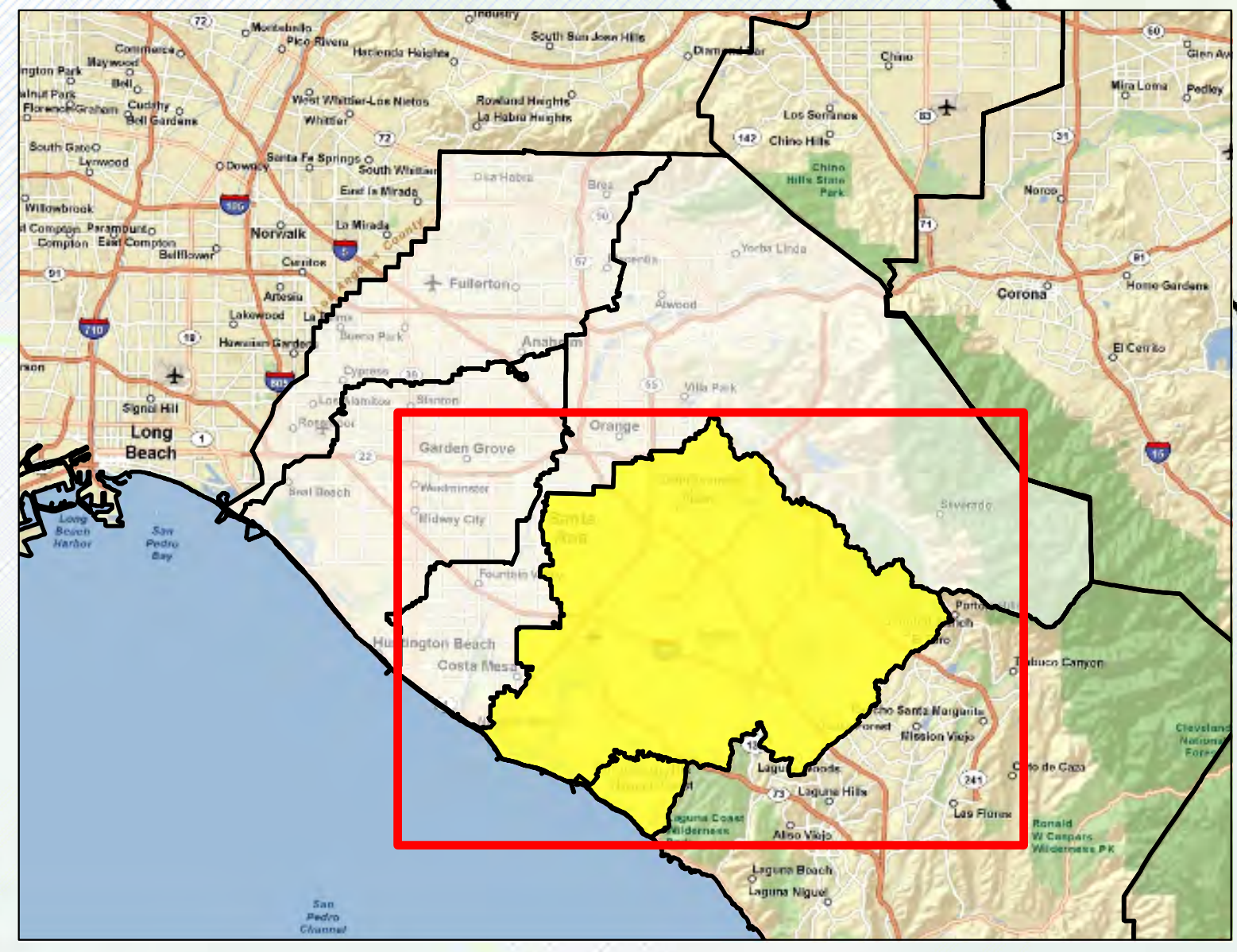

PRELIMINARY MAP
SUBJECT TO FURTHER REVISION

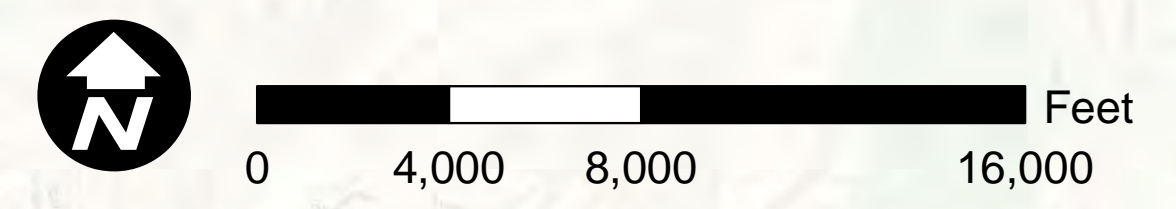

TITLE

SUSCEPTIBILITY ANALYSIS
NEWPORT BAY-
NEWPORT COASTAL STREAMS

JOB

ORANGE COUNTY
WATERSHED
MASTER PLANNING

CA

ORANGE CO.

SCALE	1" = 4000'
DESIGNED	TH
DRAWING	TH
CHECKED	BMP
DATE	04/30/10
JOB NO.	9526-E

FIGURE

XVI-3d

**APPENDIX XVII. SUPPORTING INFORMATION RELATIVE TO SANITARY
SEWER INFLOW AND INFILTRATION**

Placeholder for appendix to be developed