

CALIFORNIA REGIONAL WATER QUALITY CONTROL BOARD
CENTRAL COAST REGION

SETTLEMENT AGREEMENT AND STIPULATION FOR ENTRY OF
ADMINISTRATIVE CIVIL LIABILITY ORDER NO. R3-2014-0038
IN THE MATTER OF
SANTA CRUZ COUNTY SANITATION DISTRICT
SANTA CRUZ COUNTY

This Settlement Agreement and Stipulation for entry of Administrative Civil Liability Order (Stipulated Order or Order) is entered into by and between the Assistant Executive Officer of the California Regional Water Quality Control Board, Central Coast Region (Central Coast Water Board), on behalf of the Central Coast Water Board Prosecution Team (Prosecution Team), and Santa Cruz County Sanitation District (Discharger) (collectively known as the Parties) and is presented to the Central Coast Water Board, or its delegee, for adoption as an order by settlement, pursuant to Government Code section 11415.60.

Recitals

1. On or about August 29, 2013, Central Coast Water Board Prosecution Team issued a pre-issuance settlement communication to the Santa Cruz Sanitation District, for alleged violations of the Statewide Waste Discharge Requirements for Sanitary Sewer Systems, State Water Resources Control Board Order No. 2006-2003-DWQ (General Order).
2. The August 29, 2013 communication alleged that Discharger had two sanitary sewer overflow (SSO) events in 2011, in violation of the General Order. Staff presented its recommended penalty in accordance with the penalty methodology in the Enforcement Methodology and 13385(e).
3. The parties engaged in confidential settlement negotiations, which ultimately resolved this matter. During the settlement negotiations, a third discharge occurred in January 2014, which is also resolved by this Agreement and Order. A discussion of the modified penalty factors which the Parties ultimately agreed upon is attached hereto as Attachment A; it is presented in Excel format as Attachment B.

Regulatory Considerations

4. The Prosecution Team has concluded that the Discharger has violated Water Code section 13385 for the unauthorized discharges that occurred (commenced) on March 26, 2011, and April 18, 2011. The Prosecution Team has concluded that the Discharger has violated Water Code section 13350 for the unauthorized discharge that occurred (commenced) on January 13, 2014. The Central Coast Water Board may assess administrative civil liability based on CWC Sections 13385 or 13350, respectively, for such violations.
5. Water Code Section 13385(a)(5) states: A person who violates any of the following shall be liable civilly in accordance with this section: (5) A requirement of

Section 301, 302, 306, 307, 308, 318, 401, or 405 of the Federal Clean Water Act (33 U.S.C. Sec. 1311, 1312, 1316, 1317, 1318, 1341, or 1345), as amended. The Discharger is in violation of Section 13385(a)(5) for failing to prevent SSOs and discharging in violation of the Clean Water Act.

6. Water Code Section 13385(c)(1) states: "Civil liability may be imposed administratively by the state board or regional board pursuant to Article 2.5 (commencing with Section 13323) of Chapter 5 in an amount not to exceed the sum of both of the following: (1) Ten thousand dollars (\$10,000) for each day in which the violation occurs. (2) Where there is a discharge, any portion of which is not susceptible to cleanup or is not cleaned up, and the volume discharged but not cleaned up exceeds 1,000 gallons, an additional liability not to exceed ten dollars (\$10) multiplied by the number of gallons by which the volume discharged but not cleaned up exceeds 1,000 gallons."
7. Water Code Section 13350(a) provides: "A person who ... (2) in violation of a waste discharge requirement, waiver condition, certification, or other order or prohibition issued, reissued, or amended by a regional board or the state board, discharges waste, or causes or permits waste to be deposited where it is discharged, into the waters of the state... shall be liable civilly and remedies may be proposed, in accordance with subdivision (d) or (e)."
8. Water Code section 13350(e)(1) provides: "The state board or a regional board may impose civil liability administratively pursuant to Article 2.5 (commencing with Section 13323) of Chapter 5 either on a daily basis or on a per gallon basis, but not on both; (1) the civil liability on a daily basis shall not exceed five thousand dollars (\$5,000) for each day the violation occurs."
9. Water Code Section 13385(e) provides: "In determining the amount of any liability imposed pursuant under this section, the regional board, the state board, or the superior court, as the case may be, shall take into account the nature, circumstances, extent, and gravity of the violation or violations, whether the discharge is susceptible to cleanup or abatement, the degree of toxicity of the discharge, and, with respect to the violator, the ability to pay, the effect on its ability to continue its business, any voluntary cleanup efforts undertaken, any prior history of violations, the degree of culpability, economic benefit or savings, if any, resulting from the violation, and other matters that justice may require. At a minimum, liability shall be assessed at a level that recovers the economic benefits, if any, derived from the acts that constitute the violation."

Settlement

10. The Parties have engaged in confidential settlement negotiations and agree to settle the matter without administrative hearing or civil litigation and by presenting this Stipulated Order to the Central Coast Water Board, or its delegee, for adoption as an order by settlement pursuant to Government Code section 11415.60. The Prosecution Team believes that the resolution of the alleged violations is fair and reasonable and fulfills its enforcement objectives, that no further action is

warranted concerning the violations alleged herein, and that this Stipulated Order is in the best interests of the public.

11. The Parties are agreeing to resolve this matter for \$276,212.22, with a portion of the settlement proceeds going toward an Enhanced Compliance Action (ECA). A full discussion of the penalty calculation factors, found in the State Water Resources Control Board's (State Water Board) *Water Quality Enforcement Policy*, can be found in Attachment A, along with the factors that were modified through discussion and exchange of information by the Parties. The proposed ECA, which was developed in consultation with the Prosecution Team, is attached hereto as Attachment C.

Stipulations

The Parties stipulate to the following:

1. **Administrative Civil Liability:** The Discharger hereby agrees to the imposition of an administrative civil liability totaling **two hundred seventy-six thousand, two hundred twelve dollars and twenty-two cents (\$276,212.22)**. Not more than 30 days after the entry of an Order approving this Settlement Agreement by the Central Coast Water Board, the Discharger must pay by check to the State Water Board *Cleanup and Abatement Account* one-half of this amount or \$138,106.11, which represents half of the administrative liability amount. The Discharger shall indicate on the check the number of this Stipulation and Order and send it to the State Water Resources Control Board, Accounting Offices, Attn: ACL Payment, P.O. Box 1888, Sacramento, CA 95812-1888, and shall send a copy of the check to Julie Macedo, State Water Resources Control Board, Office of Enforcement, 1001 I Street, 16th Floor, Sacramento, CA 95814.
2. **Agreement of Discharger to Fund, Report, and Guarantee Implementation of ECA:** The remaining one-half of the administrative liability, or \$138,106.11, shall be put toward an Enhanced Compliance Action (ECA) approved by the Central Coast Water Board. The ECA is described on Attachment C. In accordance with the Enforcement Policy, ECA funds are considered a suspended liability until the ECA has been fully implemented. (Enforcement Policy, pg. 30) Discharger represents that (1) it will fund the ECA in the amount described in this Stipulation; (2) it will remain liable for the ECA suspended liability until the ECA is completed and accepted by the Central Coast Water Board in accordance with the terms of this Stipulation. Discharger agrees that the Central Coast Water Board has the right to require an audit of the funds expended by it to implement the ECA.
3. **Central Coast Water Board Acceptance of Completed ECA.** Upon the Discharger's satisfaction of its ECA obligations under this Stipulation and the completion of the ECA and any audit requested by the Central Coast Water Board, Central Coast Water Board staff shall send Discharger a letter recognizing satisfactory completion of its ECA obligations. This letter shall terminate any further ECA obligations of Discharger and result in the permanent waiver of the ECA suspended liability.

4. **Failure to Expend all ECA Suspended Liability Funds on the Approved ECA:** In the event that Discharger is not able to demonstrate to the reasonable satisfaction of the Central Coast Water Board staff that the entire ECA suspended liability has been spent to complete the components of the ECA for which Discharger is financially responsible, Discharger shall pay the difference between the ECA suspended liability and the amount Discharger can demonstrate was actually spent on the ECA as an administrative civil liability. Discharger shall pay this remainder within 30 days of its receipt of notice of the Central Coast Water Board's determination that Discharger has failed to demonstrate that the entire ECA suspended liability has been spent to complete the ECA components.
5. **Compliance with Applicable Laws:** The Discharger understands that payment of administrative civil liability in accordance with the terms of this Stipulated Order and/or compliance with the terms of this Stipulated Order is not a substitute for compliance with applicable laws, and that continuing violations of the type alleged herein may subject it to further enforcement, including additional administrative civil liability.
6. **Party Contacts for Communications related to Stipulated Order:**

For the Central Coast Water Board:

Harvey Packard
Central Coast Regional Water Quality Control Board
895 Aerovista Place, Suite 101
San Luis Obispo, CA 93401
(805) 542-4639

Julie Macedo – Senior Staff Counsel
Office of Enforcement
State Water Resources Control Board
1001 I Street, 16th Floor
Sacramento, CA 95812
(916) 323-6847

For the Discharger:

John J. Presleigh, District Engineer
Santa Cruz County Sanitation District
701 Ocean Street, Rm 410
Santa Cruz, CA 95060
(831)454-2160

T. Brooke Miller – Assistant County Counsel
Santa Cruz County Counsel's Office
701 Ocean Street, Ste. 505
Santa Cruz, CA 95060
(831) 454-2072

7. **Attorney's Fees and Costs:** Each Party shall bear all attorneys' fees and costs arising from the Party's own counsel in connection with the matters set forth herein.
8. **Matters Addressed by Stipulation:** Upon the Central Coast Water Board's, or its delegee's, adoption of this Stipulated Order, this Order represents a final and binding resolution and settlement of the violations alleged in Attachments A and B pursuant to Water Code sections 13350 and 13385. The provisions of this Paragraph are expressly conditioned on the full payment of the administrative civil liability, in accordance with Stipulation Paragraph 1 herein.
9. **Publicity.** Should Discharger or its agents or subcontractors publicize one or more elements of the ECA, they shall state in a prominent manner that the project is being partially funded as part of the settlement of an enforcement action by the Central Coast Water Board against Discharger.
10. **Public Notice:** The Discharger understands that this Stipulated Order will be noticed for a 30-day public review and comment period prior to consideration by the Central Coast Water Board, or its delegee. If significant new information is received that reasonably affects the propriety of presenting this Stipulated Order to the Central Coast Water Board, or its delegee, for adoption, the Executive Officer may unilaterally declare this Stipulated Order void and decide not to present it to the Central Coast Water Board, or its delegee. The Discharger agrees that it may not rescind or otherwise withdraw its approval of this proposed Stipulated Order.
11. **Addressing Objections Raised During Public Comment Period:** The Parties agree that the procedure contemplated for the Central Coast Water Board's adoption of the settlement by the Parties and review by the public, as reflected in this Stipulated Order, will be adequate. In the event procedural objections are raised prior to the Stipulated Order becoming effective, the Parties agree to meet and confer concerning any such objections, and may agree to revise or adjust the procedure as necessary or advisable under the circumstances.
12. **No Waiver of Right to Enforce:** The failure of the Prosecution Team or Central Coast Water Board to enforce any provision of this Stipulated Order shall in no way be deemed a waiver of such provision, or in any way affect the validity of the Order. The failure of the Prosecution Team or Central Coast Water Board to enforce any such provision shall not preclude it from later enforcing the same or any other provision of this Stipulated Order.
13. **Interpretation:** This Stipulated Order shall be construed as if the Parties prepared it jointly. Any uncertainty or ambiguity shall not be interpreted against any one Party.
14. **Modification:** This Stipulated Order shall not be modified by any of the Parties by oral representation made before or after its execution. All modifications must be in writing, signed by all Parties, and approved by the Central Coast Water Board.
15. **If Order Does Not Take Effect:** In the event that this Stipulated Order does not take effect because it is not approved by the Central Coast Water Board or its

delegee, or is vacated in whole or in part by the State Water Board or a court, the Parties acknowledge that they expect to proceed to a contested evidentiary hearing before the Central Coast Water Board to determine whether to assess administrative civil liabilities for the underlying alleged violations, unless the Parties agree otherwise. The Parties agree that all oral and written statements and agreements made during the course of settlement discussions will not be admissible as evidence in the hearing. The Parties agree to waive any and all objections based on settlement communications in this matter, including, but not limited to:

- a. Objections related to prejudice or bias of any of the Central Coast Water Board members or their advisors and any other objections that are premised in whole or in part on the fact that the Central Coast Water Board members or their advisors were exposed to some of the material facts and the Parties' settlement positions as a consequence of reviewing the Stipulation and/or the Order, and therefore may have formed impressions or conclusions prior to any contested evidentiary hearing on the NOV in this matter; or
 - b. Laches or delay or other equitable defenses based on the time period for administrative or judicial review to the extent this period has been extended by these settlement proceedings.
16. **No Admission of Liability:** In settling this matter, the Discharger does not admit to any of the findings in this Stipulated Order, or that it has been or is in violation of the Water Code, or any other federal, state, or local law or ordinance; however, the Discharger recognizes that this Stipulated Order may be used as evidence of a prior enforcement action consistent with Water Code section 13327.
 17. **Waiver of Hearing:** The Discharger has been informed of the rights provided by CWC section 13323(b), and hereby waives its right to a hearing before the Central Coast Water Board prior to the adoption of the Stipulated Order.
 18. **Waiver of Right to Petition:** The Discharger hereby waives its right to petition the Central Coast Water Board's adoption of the Stipulated Order as written for review by the State Water Board, and further waives its rights, if any, to appeal the same to a California Superior Court and/or any California appellate level court.
 19. **Covenant Not to Sue:** The Discharger covenants not to sue or pursue any administrative or civil claim(s) against any state agency or the State of California, its officers, board members, employees, representatives, agents, or attorneys arising out of or relating to any violation alleged herein.
 20. **Central Coast Water Board is Not Liable:** Neither the Central Coast Water Board members nor the Central Coast Water Board staff, attorneys, or representatives shall be liable for any injury or damage to persons or property resulting from acts or omissions by the Discharger, its directors, officers, employees, agents, representatives or contractors in carrying out activities pursuant to this Stipulated Order.
 21. **Authority to Bind:** Each person executing this Stipulated Order in a representative capacity represents and warrants that he or she is authorized to

execute this Stipulated Order on behalf of and to bind the entity on whose behalf he or she executes the Order.

22. **No Third Party Beneficiaries.** This Stipulated Order is not intended to confer any rights or obligations on any third party or parties, and no third party or parties shall have any right of action under this Stipulated Order for any cause whatsoever.
23. **Effective Date:** This Stipulated Order shall be effective and binding on the Parties upon the date the Central Coast Water Board, or its delegee, enters the Order.
24. **Counterpart Signatures:** This Stipulated Order may be executed and delivered in any number of counterparts, each of which when executed and delivered shall be deemed to be an original, but such counterparts shall together constitute one document.

IT IS SO STIPULATED.

California Regional Water Quality Control Board Prosecution Team
Central Coast Region

By: _____
Michael J. Thomas
Assistant Executive Officer

Date: _____

Santa Cruz County Sanitation District

By: Stephanie Harlan
Stephanie Harlan
Chair of the Sanitation District Board

Date: June 28, 2014

Order of the Central Coast Water Board

1. In adopting this Stipulated Order, the Central Coast Water Board or its delegee has considered, where applicable, each of the factors prescribed in CWC sections 13327, 13351 and 13385(e). The consideration of these factors is based upon information and comments obtained by the Central Coast Water Board's staff in investigating the allegations concerning the dischargers discussed herein or

execute this Stipulated Order on behalf of and to bind the entity on whose behalf he or she executes the Order.

22. **No Third Party Beneficiaries.** This Stipulated Order is not intended to confer any rights or obligations on any third party or parties, and no third party or parties shall have any right of action under this Stipulated Order for any cause whatsoever.
23. **Effective Date:** This Stipulated Order shall be effective and binding on the Parties upon the date the Central Coast Water Board, or its delegee, enters the Order.
24. **Counterpart Signatures:** This Stipulated Order may be executed and delivered in any number of counterparts, each of which when executed and delivered shall be deemed to be an original, but such counterparts shall together constitute one document.

IT IS SO STIPULATED.

California Regional Water Quality Control Board Prosecution Team
Central Coast Region

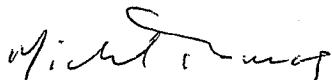
By: 
Michael J. Thomas
Assistant Executive Officer

Date: 7-18-14

Santa Cruz County Sanitation District

By: _____
Stephanie Harlan
Chair of the Sanitation District Board

Date: _____

Order of the Central Coast Water Board

1. In adopting this Stipulated Order, the Central Coast Water Board or its delegee has considered, where applicable, each of the factors prescribed in CWC sections 13327, 13351 and 13385(e). The consideration of these factors is based upon information and comments obtained by the Central Coast Water Board's staff in investigating the allegations concerning the dischargers discussed herein or

otherwise provided to the Central Coast Water Board or its delegee by the Parties and members of the public.

2. This is an action to enforce the laws and regulations administered by the Central Coast Water Board. The method of compliance with this enforcement action consists entirely of payment of an administrative penalty. As such, the Central Coast Water Board finds that issuance of this Order is not considered subject to the provisions of the California Environmental Quality Act (CEQA) as it will not result in a direct or reasonably foreseeable indirect physical change in the environment and is not considered a "project" (Public Resources Code 21065, 21080(a); 15060(c)(2),(3); 150378(a), Title 14, of the California Code of Regulations). In addition, the Central Coast Water Board finds that issuance of this Order is also exempt from the provisions of CEQA in accordance with section 15321(a)(2), Title 14, of the California Code of Regulations as an enforcement action by a regulatory agency and there are no exceptions that would preclude the use of this exemption. To the extent that the payment of a portion of the administrative liability as an ECA would trigger CEQA review, the possible activities by the ECA administrator are not yet known. If the implementation may result in significant impacts on the environment, the appropriate lead agency will address the CEQA requirements prior to approval of any work plan.
3. The terms of the foregoing Stipulation are fully incorporated herein and made part of this Order of the Central Coast Water Board.

Pursuant to CWC sections 13323, 13350, 13385 and Government Code section 11415.60, **IT IS HEREBY ORDERED** by the California Regional Water Quality Control Board, Central Coast Region.

By: _____
Kenneth A. Harris Jr.
Executive Officer

Date: _____

Attachment A

ATTACHMENT A

SANTA CRUZ COUNTY SANITATION DISTRICT

(Submitted with ACLO R3-2014-0038; Document Reflects Settlement Considerations¹)

This document provides details to support recommendations for enforcement in response to three (3) illegal Sanitary Sewer Overflows (SSO) discharges that occurred within the Santa Cruz County Sanitation District's (District) sanitary sewer collection system and reflects information submitted by the District pursuant to an initial and supplemental 13267 response as well as settlement negotiation between the parties.

1.0 Discharger Information

The District both owns and operates its sanitary sewer collection system, and is regulated by Water Quality Order Nos. 2006-0003-DWQ and 2008-0002-EXEC. The District is a non-profit public agency which provides sewage collection, treatment and disposal services to the Live Oak, Capitola, Soquel, and Aptos areas. The District's customers generate approximately 5-6 million gallons of sewage a day, which is transported from the Lode Street facility to the wastewater treatment plant located at Neary Lagoon in Santa Cruz, which is owned and operated by the City of Santa Cruz. The wastewater treatment plant treats a total of approximately 12 million gallons of wastewater per day.

2.0 Application of Water Board's Enforcement Policy²

On November 17, 2009, the State Water Board adopted Resolution No. 2009-0083 amending the Water Quality Enforcement Policy (Enforcement Policy). The Enforcement Policy was approved by the Office of Administrative Law and became effective on May 20, 2010. The Enforcement Policy establishes a methodology for assessing administrative civil liability. Use of the methodology addresses the factors in CWC section 13385(e) and 13351, which requires the Regional Water Board to consider several factors when determining the amount of civil liability to impose, including "...the nature, circumstances, extent, and gravity of the violation or violations, whether the discharge is susceptible to cleanup or abatement, the degree of toxicity of the discharge, and, with respect to the violator, the ability to pay, the effect on its ability to continue its business, any voluntary cleanup efforts undertaken, any prior history of violations, the degree of culpability, economic benefit or savings, if any, resulting from the violation, and other matters that justice may require."

The following recommendations have been developed based on the procedures included in the Water Quality Enforcement Policy methodology:

SSO Violation #1

Date: 3/26/2011

Alleged Cause of SSO: *District alleges that wet weather impacts due to a storm event caused localized flooding and excess storm water intrusion into the collection system which overwhelmed the District's final sewage pump station.*

SSO Event Description: *District alleges the SSO was caused by large amounts of storm water entering the collection system during a storm, which then overwhelmed the District's Porath Facility pump station located at 2750 Lode Street, in Santa Cruz, California. District alleges sewage spilled from several manholes at the pump station, flowed into adjacent drainage ditches, and reached Moran Beach located on the Pacific Ocean.*

¹ Settlement considerations are positions different than originally presented in Prosecution Team's initial recommended penalty, and District's response, but not disclosed here, due to the confidentiality of settlement negotiations; see Evidence Code Section 1152. Compromises are acceptable under the Enforcement Policy; see pg. 22.

² Water Board's Adopted Enforcement Policy available at: http://www.swrcb.ca.gov/water_issues/programs/enforcement/policy.shtml

The District alleges its entire sewage pump stations were fully operational and were all operating at maximum capacity during the entire SSO event. The District certified in California Integrated Water Quality System (CIWQS) that the event started at 10:50a.m. and ended at 1:40p.m.

SSO VIOLATION #1 (STEP 1): POTENTIAL FOR HARM

FACTOR 1: HARM OR POTENTIAL HARM TO BENEFICIAL USES

- **SCORE = 3 [MODERATE THREAT]**

1. A contributing factor to this SSO was large inflow and infiltration (I/I) into the sewage collection system which overwhelmed the District's DA Porath facility (final pump station in collection system network).
2. Beach health warning signs were posted by District at Moran Beach (total number of signs and days the beach was actually posted are unknown).
3. Rainfall/storm data suggests a 10 to 25 year frequency (based on 24-hour duration data analysis).

FACTOR 2: PHYSICAL, CHEMICAL, BIOLOGICAL OR THERMAL CHARACTERISTICS

- **SCORE = 3 [ABOVE-MODERATE THREAT]**

1. Above-moderate risk or direct threat to potential receptors due high levels of suspended solids, pathogenic organisms, toxic pollutants, nutrients, oil, and grease, etc. that are found in sewage.

FACTOR 3: SUSCEPTIBILITY TO CLEANUP OR ABATEMENT

- **SCORE = 1 [<50% SUSCEPTIBLE TO CLEANUP OR ABATEMENT]**

1. District alleges SSO couldn't be cleaned up or abated since SSO was caused by storm event that caused flooding and inflow of storm water into collection system, particularly from Capitola area, which then overwhelmed the District's final pump station.
2. No sewage recovery or containment procedures were implemented/deployed by District's per its own Sewer System Management Plan (SSMP) requirements during the overflow at the District's final pump station.
3. Actual amount of sewage recovered by District was 0% as specified in certified CIWQS report.

FINAL SCORE = 7 [3 + 3 + 1]

SSO VIOLATION #1 (STEP 2): ASSESSMENTS FOR DISCHARGE VIOLATIONS

VOLUME AND TOTAL NUMBER OF DAYS DETERMINATION

- **88,032 GALLONS OVER ONE DAY**

1. District determined on page 3 in its October 22, 2013 technical submittal that SSO volume was 79,954 gallons based on review of electronic system flow and level information recorded during the actual SSO event.
2. District also provided estimates in Exhibit 5 of October 22, 2013 technical submittal that the SSO would have ranged from a high of 104,110 gallons (volume of sewage discharged assuming discharge started at 13.5 feet elevation above wet well floor elevation) to 22,617 gallons (volume of sewage discharged assuming the discharge started at 14 feet above wet well floor elevation). The District recommended a value of 73,954 gallons, which assumes the spill started at 13.75 feet above the wet well floor elevation.

3. Averaging the District's ranges of reasonable estimates (104,110 gallons 13.5 feet above wet well floor elevation and 73,954 gallons@13.75 feet above wet well floor elevation) results in a total volume spill estimation of 89,032 gallons. For penalty calculations, 1,000 gallons is subtracted from this total spill volume (CWC section 13385(c)(2)).
4. This amount is less than the 100,000 gallons that was initially reported in CIWQS, but reflects a reasonable amount based upon the facts as presented. 22,000 gallons is not supportable upon the facts presented.

DEVIATION FROM REQUIREMENT

- **SCORE = MODERATE**

1. The deviation from requirements is scored as moderate because this SSO reached surface waters, which rendered Prohibition C.1. set forth in Order No. 2006-0003-DWQ ineffective. Other factors:
 - District failed to comply with SSS WDRs, Prohibition C.1 (SSO was discharged to waters of U.S.).
 - District failed to comply with SSS WDRs, Provision D.4. (failed to implement feasible steps for this SSO to prevent the spill from reaching surface waters).
 - District failed to comply with SSS WDRs, Provision D.6 (failed to provide any feasible alternatives to this SSO discharge).
 - District failed to comply with SSS WDRs, Provision D.7 (failed to control/terminate/recover any of this SSO).
 - District failed to comply with SSS WDRs, Provision D.10 (failed to provide adequate collection system capacity for peak flows during this storm event which led to this SSO).

VOLUME ASSESSMENT

- **SCORE = \$6.00 per gallon**

1. Pursuant to Water Code section 13385(a), the District is subject to administrative civil liability for violating any waste discharge requirement. The Regional Water Board may impose administrative civil liability pursuant to Article 2.5 (commencing with section 13323) of Chapter 5 in an amount not to exceed the sum of both of the following; (1) \$10,000 for each day in which the violation occurs; and (2) \$10 for each gallon of discharge that is not susceptible to cleanup or is not cleaned up in excess of 1,000 gallons.
2. The Water Quality Enforcement Policy requires application of the per gallon factor to the maximum per gallon amounts allowed under statute for the violations involved.
3. The Water Quality Enforcement Policy allows discretion to lower this score to \$2 per gallon for high volume discharges. This score has been lowered to \$6 per gallon because the final volume estimate of 89,032 and the lowest volume offered by the District would both result in \$10 per gallon calculations. The Regional Boards tend to use 100,000 gallons as a general guideline for high volume. The highest volume of 104,110 gallons submitted by the District might qualify for a discretionary reduction in the dollars per gallon penalty, but this would result, in the Prosecution Team's opinion, in an inappropriately low penalty. Therefore, we relied on the recently approved settlement agreement with Cambria Community Services District, in which a reduction to \$4.00 was approved. As that discharger was more cooperative in providing documents to the Regional Board and had slightly smaller spills, the Prosecution Team felt a reduction to \$6.00 in this instance was appropriate. This reduction can be achieved, when not a high volume discharge, through other factors as justice may require, Step 7.

SSO VIOLATION #1 (STEP 4): ADJUSTMENT FACTORS

CULPABILITY• **SCORE = 0.9**

1. Due the severity of the storm event, resources were constrained which may have hampered the District's ability to prevent or minimize the spill. A declaration of emergency was made throughout Santa Cruz.
2. District failed to comply with Provision D.10 of the Sanitary Sewer Collection System Order which states, "The Enrollee shall provide adequate capacity to convey base flows and peak flows, including flows related to wet weather events."
3. District failed to comply with the Provision D.7(v) of the Sanitary Sewer Collection System Order to provide adequate sampling to determine the nature and impact of the release.
4. District failed to respond to overflow by bypassing sewage and/or implementing containment operations to reduce/eliminate volume and impacts.

CLEANUP AND COOPERATION• **SCORE = 1.1**

1. District failed to provide adequate details and supporting technical information as required in NOV/13267 letter for the SSO volume determination, including "engineering methods, diagrams, models, references, calculations and assumptions used."
2. District did not voluntarily cooperate in returning to compliance and correct environmental damage as follows:
 - a. Procedures specified in District's SSMP not implemented for sewage recovery.
 - b. Procedures specified in District's SSMP not implemented for sampling/monitoring.
 - c. Procedures specified in District's SSMP not implemented for taking photographs.
3. District failed to provide any explanation in initial NOV/13267 response for possible future preventative measures to be implemented by District to avoid a similar SSO (examples could include considering purchasing bypass pump(s) for increasing wet weather pumping at District's final pump station; installation of additional redundancy at District's final pump station such as built-in bypassing connections and/or equipment for addressing high flows; changes to operations and maintenance practices/projects to improve pump station wet well/pipeline capacities; upgrades to procedures for storm preparedness to improve wet weather capacity (i.e., pumping down wet well throughout collection system ahead of major storm forecasted for the regional area); engineering study to review District's current pump station operations management/procedures to improve collection system pipeline storage during wet weather episodes to reduce risks of future SSOs, etc.). The District initially failed to provide a detailed engineering narrative and analysis in its initial NOV/13267 response letter. As a result, the District had to provide a significant supplemental 13267 response after meeting with the Prosecution Team in an initial settlement discussion.

HISTORY OF VIOLATIONS• **SCORE = 1.2**

1. District had eight (8) SSOs previous to this SSO:
 - a. 2,035 gallons spilled reported to have reached surface waters.
 - b. District currently has reportedly spilled >129,000 gallons to surface waters (including this SSO).
2. District performance metrics for spill recovery rates are very low (~3%), according to current CIWQS data available for Santa Cruz CSD. In addition, District provided no specific goals in NOV/13267 for target improvements to these metrics.
3. District continues to have SSOs that reach surface waters which are violations of SSS WDRs, Prohibition C.1. including an SSO certified on 2/4/2014 of 23,040 gallons (see STEP #4 in Violation #2 below for more information)

SSO VIOLATION #1 (STEP 5): DETERMINATION OF BASE LIABILITY

(See attached .XLS spreadsheet)

SSO Violation #2**Date: 4/18/2011 to 4/19/2011****Alleged Cause of SSO:** Broken sewer line due to embankment slip.

SSO Event Description: District alleges that a major "slip out" of an embankment caused lateral support to fail on one of its sewer pipelines in residential neighborhood behind apartment complex, exposing the pipe, which caused it to break, producing this SSO. Sewage flowed out of the broken line and reached New Brighton State Beach. District alleges it found this SSO by dispatching crews to the site initially to check on a reported odor complaint called-in from a local resident. At first, crews found no evidence of an SSO until being redirected by District management to go back the next day to re-investigate this location upstream of the odor complaint. District alleges it found the SSO during second site visit and began mitigation procedures. District estimates SSO started on 4/18/2011 at 00:00 (midnight) and ended right after it found the "slip out" on 4/19/2011 at 09:45a.m. Both District 13267 response and the CIWQS certified report do not include any information that this SSO caused any sewer backup(s).

SSO VIOLATION #2 (STEP 1): POTENTIAL FOR HARM**FACTOR 1: HARM OR POTENTIAL HARM TO BENEFICIAL USES**

- **SCORE = 4 [ABOVE MODERATE THREAT]**

1. Beach health warning signs were posted by District at New Brighton State Beach (total number of signs and days the beach was actually posted are unknown).
2. Beach closures indicate that above moderate harm occurred to beneficial uses, especially when the closure occurs during dry weather.

FACTOR 2: PHYSICAL, CHEMICAL, BIOLOGICAL OR THERMAL CHARACTERISTICS

- **SCORE = 3 [ABOVE-MODERATE THREAT]**

1. Above-moderate risk or direct threat to potential receptors due high levels of suspended solids, pathogenic organisms, toxic pollutants, nutrients, oil, and grease, etc. that are found in sewage.

FACTOR 3: SUSCEPTIBILITY TO CLEANUP OR ABATEMENT

- **SCORE = 1 [<50% SUSCEPTIBLE TO CLEANUP OR ABATEMENT]**

1. No sewage recovery or containment procedures were implemented/deployed by District as required by its own SSMP procedures during this SSO.
2. Actual amount of sewage recovered by District was 0% as specified in certified CIWQS report.

FINAL SCORE = 8 [4 + 3 + 1]**SSO VIOLATION #1 (STEP 2): ASSESSMENTS FOR DISCHARGE VIOLATIONS****VOLUME AND TOTAL NUMBER OF DAYS DETERMINATION**

- **23,339 GALLONS OVER TWO DAYS**

1. 23,339 gallon estimation used for penalty calculations (24,339 gallons was the District's revised estimation certified by District Engineer in District's 13267 response, which is only slightly lower than the 25,000 gallons certified in the CIWQS report). For penalty calculations, 1,000 gallons is subtracted from this total spill volume (CWC section 13385(c)(2)).
2. The District determined this spill occurred over two days.

DEVIATION FROM REQUIREMENT

- **SCORE = MODERATE**

1. District violated SSS WDRs, Prohibition C.1 (SSO was discharged to waters of U.S.).
2. District violated SSS WDRs, Provision D.7 (failed to recover any of the SSO).
3. District violated SSS WDRs, Provision D.10 (failed to provide adequate capacity to convey base flows).

VOLUME ASSESSMENT

- **SCORE = \$10.00 per gallon (not considered high volume discharge)**

SSO VIOLATION #2 (STEP 4): ADJUSTMENT FACTORS CULPABILITY

- **SCORE = 1.0**

1. The discharge was not caused by negligence and appears to have not been a predictable failure should result in a factor that does not serve to increase the base liability.
2. However, the failure of the District to implement SOPs for spill containment operations to reduce/eliminate volume and impacts makes a neutral multiplier appropriate.

CLEANUP AND COOPERATION

- **SCORE = 1.0**

1. District did not voluntarily cooperate in returning to compliance and correct environmental damage as follows:
 - a. District failed to implement SOPs for sewage recovery.
2. District did implement expedited repairs/projects to prevent a similar SSO at this location.

HISTORY OF VIOLATIONS

- **SCORE = 1.3**

1. District had nine (9) SSOs previous to this SSO:
 - a. 102,035 gallons reported to have reached surface waters.
 - b. >129,000 gallons spilled to surface waters to date (including this SSO).
2. District performance metrics for spill recovery very low (3 percent recovery rate for all SSOs) with no specific discussion in District NOV/13267 response regarding specifically how District intends to improve spill recovery performance.
3. District continues to experience SSOs that reach surface waters (violation of SSS WDRs/ Prohibition C.1).
4. District certified a new SSO on 2/4/2014 of 23,040 gallons with nothing recovered (all reportedly discharged to land and nothing reaching surface water); this new SSO appears to have been caused by a similar problem that caused Violation #2. The District reported in in CIWQS that "Manhole structure moved on hillside which caused the line to crack" (reference CIWQS spill ID #999285 for more information).

SSO VIOLATION #2 (STEP 5): DETERMINATION OF BASE LIABILITY

(See attached .XLS spreadsheet)

SSO Violation #3

Date: 1/13/2014 to 1/29/2014

Alleged Cause of SSO: *Broken sewer line due to manhole structure movement on hillside.*

SSO Event Description: *District alleges that a hillside eroded which caused the manhole structure to shift and caused a crack in main line sewer.*

SSO VIOLATION #3 (STEP 1): POTENTIAL FOR HARM**FACTOR 1: HARM OR POTENTIAL HARM TO BENEFICIAL USES**

- **SCORE = 2 [BELOW MODERATE THREAT]**

1. This spill reached a small drainage channel that was dry. The spill only travelled a few hundred feet and did not reach surface waters.

FACTOR 2: PHYSICAL, CHEMICAL, BIOLOGICAL OR THERMAL CHARACTERISTICS

- **SCORE = 3 [ABOVE-MODERATE THREAT]**

1. Above-moderate risk or direct threat to potential receptors due high levels of suspended solids, pathogenic organisms, toxic pollutants, nutrients, oil, and grease, etc. that are found in sewage.

FACTOR 3: SUSCEPTIBILITY TO CLEANUP OR ABATEMENT

- **SCORE = 1 [<50% SUSCEPTIBLE TO CLEANUP OR ABATEMENT]**

1. Actual amount of sewage recovered by the District was 0%, as indicated in the District's certified CIWQS report.

FINAL SCORE = 6 [2 + 3 + 1]

SSO VIOLATION #3 (STEP 2): ASSESSMENTS FOR DISCHARGE VIOLATIONS**VOLUME AND TOTAL NUMBER OF DAYS DETERMINATION**

- **23,040 GALLONS OVER 17 DAYS**

1. The volume determination of 23,040 gallons was taken from the District certified CIWQS report, certified by the District on March 27, 2014;
2. The District estimated that the spill occurred over 17 days based on interviews with the residents.

DEVIATION FROM REQUIREMENT

- **SCORE = MODERATE**

1. The District indicated during settlement negotiations that this SSO did not reach surface waters;
2. This SSO reached an intermittent drainage channel and therefore is subject to enforcement under Water Code violation of 13350(e)(1).

SSO VIOLATION #3 (STEP 4): ADJUSTMENT FACTORS**CULPABILITY**• **SCORE = 1.0**

1. This SSO does not appear to be caused by negligence;
2. To prevent future SSOs, the District must properly manage, operate, and maintain all parts of its sanitary sewer system and comply with Provision D.8 of the Sanitary Sewer Systems Order (SSS WDRs), Order No. 2006-0003-DWQ. In addition, subsection D.13(iv) of the SSS WDRs requires the District to implement a routine preventative operation and maintenance program, including a rehabilitation and replacement plant to identify and prioritize system deficiencies.
3. For any SSOs that do occur, the District must comply with subsection D.7 of the SSS WDRs that requires taking all feasible steps and necessary remedial actions to control, limit and terminate any discharges.

CLEANUP AND COOPERATION• **SCORE = 1.0**

1. The District failed to recover any sewage for this SSO; no additional information or an explanation has been included in District's certified CIWQS report for this SSO.

HISTORY OF VIOLATIONS• **SCORE = 1.3**

1. District experienced a similar infrastructure problem in 2011 which caused a previous SSO to surface water (see Violation #2).
2. District's existing sewer inspection and rehabilitation program must be improved throughout its service area to prevent similar and repeat infrastructure failures.

SSO VIOLATION #3 (STEP 5): DETERMINATION OF BASE LIABILITY

(See attached .XLS spreadsheet)

For All Violations**ABILITY TO PAY AND ABILITY TO CONTINUE IN BUSINESS (STEP 6):**• **SCORE = 1.0 (neutral)**

- The Santa Cruz County Sanitation District Basic Financial Statements and Independent Auditors' Report for the Fiscal Year Ending June 30, 2012 indicates it has the potential ability to pay an ACL of up to at least \$500,000. The auditors' report shows current assets as \$27,922,190, current liabilities as \$3,774,856, and current net assets as \$24,147,334. Since the recommended penalty is less than this amount, the burden shifts to the Discharger to provide evidence to the Prosecution Team to consider as an affirmative defense.

OTHER FACTORS AS JUSTICE MAY REQUIRE (STEP 7):

- **STAFF COSTS:** As a condition of settlement, staff costs were waived.

ECONOMIC BENEFIT (STEP 8):

- **SCORE = \$71,481**
- State Water Board staff completed an assessment of the appropriate factors required under subsection D.6 of the Sanitary Sewer Systems Waste Discharge Requirements (Water Quality Order No. 2006-0003-DWQ) for these violations.

Violation #1: In assessing factors in subsection D.6(iii) of the SSS WDRs, staff concluded that there was feasible alternatives to this discharge such as the installation of a temporary storage, equalization/retention system within the collection system that could have been used to avoid the overflow. Therefore, the economic benefit realized by the District is estimated to be \$71,481 as follows:

Santa Cruz County Sanitation District ACL

Compliance Action	One-Time Nondepreciable Expenditure		Annual Cost		Date of		Penalty Payment	Benefit of Non- Compliance
	Amount	Date	Amount	Date	Non- Compliance	Compliance		
Delayed Expansion of Equalization Basin	\$800,000	6/2/2014	\$0	1/1/2014	3/1/2011	6/2/2014	6/2/2014	\$71,481
Totals	\$800,000		\$0					\$71,481

Source: USEPA BEN Model: Version 5.3.0

6/4/2014 15:11

Not-for-Profit, which pays no taxes

Cost Index for Inflation: ECI Employment Cost Index

Discount/Compound Rate: 4.6%

Violation #2: No economic benefit was realized by the District for this violation. The District provided historic inspection records showing that this section of pipeline had historically been routinely inspected by the District. The failure of this pipeline was due to an unforeseen landslide.

Violation #3: No economic benefit realized by the District for this violation. The District provided historic inspection records showing that this section of pipeline had historically been routinely inspected by the District. The failure of this pipeline was due to unforeseen movement by the manhole.

MAXIMUM AND MINIMUM LIABILITY (STEP 9):

(See attached .XLS spreadsheet)

FINAL LIABILITY AMOUNT (STEP 10):

(See attached .XLS spreadsheet)

3.0 FINAL SETTLEMENT AMOUNT = \$276,212.22

Attachment B

Instructions

1. Select Potential Harm for Discharge Violations
2. Select Characteristics of the Discharge
3. Select Susceptibility to Cleanup or Abatement
4. Select Deviation from Standard
5. Click "Determine Harm & per Gallon/Day..."
6. Enter Values into the yellow highlighted fields

Select Item 3 = Moderate	Select Item 8
3 = Discharged material poses above moderate risk	Select Item 10.00
< 50% of Discharge Susceptible to Cleanup or Abatement	Select Item 1.00
Moderate	Select Item 253,390.0

Discharger Name/ID: **SANTA CRUZ CSD SSOs**

		Violation 1 - March 26, 2011 SSO	
Discharge Violations	Step 1 Potential Harm Factor (Generated from Button)	7	8
	Step 2 Per Gallon Factor (Generated from Button)	0.2	0.4
	Gallons	88,032	23,339
	Statutory Maximum	10,000	10,000
	High Volume	6,000	
	Total		
	Per Day Factor (Generated from Button)	0.2	0.4
	Days	1	2
	Statutory Max per Day	10,000	10,000
	Total		
Non-Discharge Violations	Step 3 Per Day Factor		
	Total Days		
	Multiple Day Violation Reduction		
	Statutory Max per Day		
Total			
Add'l Factors	Initial Amount of the ACL		
	Step 4 Culpability	0.9	
	Cleanup and Cooperation	1.1	
	History of Violations	1.2	
Maximum for this Violation			
Amount for this Violation	\$ 890,320.00	\$ 127,874.42	\$ 253,390.0
Step 5 Total Base Liability Amount		\$ 276,212.22	
Step 6 Ability to Pay & to Continue in Business	1	\$ 276,212.22	
Step 7 Other Factors as Justice May Require	1	\$ 276,212.22	
Staff Costs		\$ 276,212.22	
Step 8 Economic Benefit		\$ 71,481	
Step 9 Minimum Liability Amount		\$ 78,629.10	
Maximum Liability Amount		\$ 1,226,710,000.00	
Step 10 Final Liability Amount		\$ 276,212.22	

Attachment C

Attachment C

Santa Cruz County Sanitation District ECA Summary Attachment to Settlement Agreement and Stipulation Order R3-2014-0038 Enhanced Compliance Action: Wet Weather Detention Structure

BACKGROUND

Santa Cruz County Sanitation District (SCCSD) collects wastewater from its service area and conveys it to the D.A. Porath pump station facility at 2790 Lode Street in Santa Cruz. At the pump station, the sewage is treated for odor control and pumped to the City of Santa Cruz Regional Wastewater Treatment Plant. According to the 1990 Joint Wastewater Treatment and Disposal Agreement, the SCCSD is allowed to pump a maximum wet weather flow of 30 million gallons per day (MGD) to the City treatment plant. The capacity of the pump station has been estimated to be 31 MGD and based on flow analyses, the peak wet weather flow is predicted to be 42.4 MGD. On March 26, 2011 there was a spill at the D.A. Porath pump station of approximately 86,033 gallons of wastewater due to intense rainfall and infiltration of storm water due to flooding in Capitola.

PROJECT OBJECTIVES

In order to avoid future similar sanitary sewer overflows, the SCCSD has retained an engineer (SRT Consultants) to evaluate the feasibility of constructing a wet weather detention structure near the pump station to temporarily capture excessive wastewater flow prior to flooding the pump station. A draft technical memorandum by SRT Consultants (dated April 4, 2014) has been completed that indicates that a wet weather detention structure is feasible and can be constructed on SCCSD property along the south side of the entrance road to the pump station. A copy of the draft technical memorandum is attached hereto as Exhibit 1. A copy of the draft layout for the project is attached hereto as Exhibit 2.

This project will result in the construction of a passive, underground storage facility that requires minimal maintenance and will capture flows during high intensity wet weather events and slowly allow the wastewater to drain into the pump station wet well after the flows are reduced in the transmission line. This will result in reducing the maximum flow to the treatment plant during wet weather and avoid a sanitary sewer overflow similar to the event on March 26, 2011.

SRT Consultants have provided the SCCSD with a proposal to complete plans and specifications for the project and the SCCSD plans to go to the Board to approve the consulting contract on August 7, 2014. SRT anticipates that 50 percent design plans will be available for review 10 weeks following approval of their contract. In order to

complete construction of the project, a Coastal Development Permit and Environmental Review pursuant to CEQA will need to be completed. During the preliminary design phase of the project, environmental studies can be completed of the proposed construction area. Approval of the coastal and environmental permits is anticipated to take up to 6 months and can be initiated once the 50 percent plans are completed. This area is known to be a monarch butterfly roosting site and there could be construction restrictions between October and March. All construction and re-vegetation will be conducted in accordance with the Management Plan for the Monarch Butterfly Habitat at the East Cliff Facility.

Based on the site constraints and estimated timelines, the SCCSD proposes the following schedule and budget for the various activities required to complete the project.

ACTIVITY/TASK	DESCRIPTION	DATE	BUDGET/COST
SRT Contract Approved	Board Approval	8/7/14	\$88,980
Entomologist/Biologist	Open Purchase Order	8/1/14	\$15,000-\$30,000
50% Plans, Specs & Cost Estimate (PS&E)	SRT to provide	October 2014	
Environmental Field Work Complete	Requirements for butterflies and birds	Mid Oct. 2014	
Initiate Coastal Permit & CEQA Process	County Planning Department Application	Nov. 2014	\$10,000 - \$20,000
100% PS&E	SRT to Include CEQA Mitigations in Plans	March 2015	
Advertise for Bids	Board Approval	Apr. 16, 2015	\$2,000
Bid Opening		May 16, 2015	
Award Construction Contract	Board Approval	June 11, 2015	\$820,000
Notice to Proceed		July 11, 2015	
Complete Construction		Oct. 15, 2015	
Total Estimated Cost			\$935,980-\$960,980

Exhibit 1

DRAFT Technical Memorandum



DATE: April 4, 2014

TO: Rachél Lather, P.E.
Senior Civil Engineer
Santa Cruz County Sanitation District

FROM: Tim Monahan, P.E.
Jeff Fidelin, P.E.
SRT Consultants

THRU: Tanya Yurovsky, P.E.
SRT Consultants

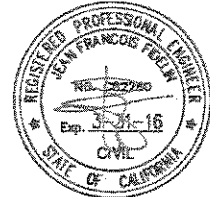
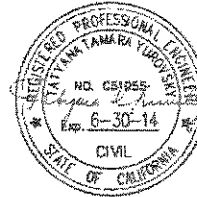
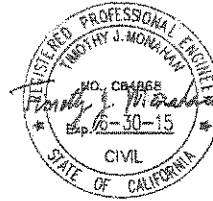

SUBJECT: Feasibility Study for a Wet Weather Detention Structure at the DA Porath Facility

SUMMARY

Constructing a Wet Weather Detention Structure (WWDS) is feasible on the property next to the DA Porath Facility, south of Lode Street. To be passive, the WWDS needs to be fairly shallow, about four feet of height. The estimated budget-level engineer's opinion of construction cost for a 100,000-gallon WWDS is \$820,000.

SRT recommends SCCSD evaluate the proposed capacity and height of the new WWDS prior to moving forward with its permitting process and design. Using the recently calibrated hydraulic model, the proposed 100,000-gallon capacity could be compared to the detention capacity that would eliminate the risk of sanitary sewer overflows during a 10-year, 2-hour design storm. Also, the expected frequency at which the system might overflow with a new 100,000-gallon detention structure could be estimated. Regarding the height, the spill elevation assumed at 36.40' should be confirmed and the dry weather maximum water level in the 48-inch influent sewer should be determined in the vicinity of the new structure.

PURPOSE

Santa Cruz County Department Sanitation District (SCCSD) collects wastewater from its service area and conveys it to the DA Porath Wastewater Facility, where it is pretreated and pumped to the City of Santa Cruz wastewater treatment plant (WWTP). On March 26, 2011, the facility was inundated with exceptionally high wastewater flow during a heavy rain event and a significant Sewer System Overflow (SSO) occurred at the bar racks and influent manholes. The SSO prompted SCCSD to evaluate options to avoid future similar SSOs. One option was to install a Wet Weather Detention Structure (WWDS) near the facility to temporarily capture excessive wastewater flow before it is released to the environment.

SCCSD retained SRT Consultants (SRT) to study the feasibility of constructing a WWDS at the DA Porath Facility. This *Draft* Technical Memorandum (TM) documents the Feasibility Study findings and lists the resulting recommendations.

SITING

SCCSD owns property on both sides of Lode Street, the access road to the DA Porath Facility (see Figure 1). The new structure could be sited in either of these two lots as depicted below.



Figure 1 Site Aerial View

The lot on the north side of the access road, although larger in area, is not a viable option for constructing the WWDS. The inlet/outlet pipe to the WWSF cannot be connected to the 48-inch diameter gravity sewer since the 36-inch force main is installed on the north side of the gravity sewer and its alignment is parallel and at the same depth. Therefore the lot on the south side of

the access road was selected for the purpose of this Study.

CONCEPTUAL ENGINEERING

Capacity

SCCSD staff has estimated the March 26, 2011 spill at between 74,000 and 104,000 gallons¹. Based on discussions with SCCSD Staff, SRT has considered this storm as the design scenario and proposes a WWDS capacity of 100,000 gallons for the purpose of this Study.

SCCSD recently hired ARCADIS to evaluate the hydraulic capacity of the entire collection system, using the system's hydraulic model. In that study, ARCADIS used a 10-year, 2-hour design storm². In an effort to further document the most suitable capacity for the new structure, SRT recommends that SCCSD evaluate:

1. The storage capacity that would eliminate the risk of SSO during a 10-year, 2-hour design storm.
2. The expected frequency at which the system might overflow with a 100,000-gallon detention structure.

Elevation

The top of the new structure needs to be located below the spill elevation. SRT reviewed the DA Porath Facility drawings and found the spill elevation at 36.40' (grade elevation at Manhole No. 8 in the Facility's parking lot).

The bottom of the new structure needs to be located above the dry weather maximum water level in the 48-inch influent sewer, so that:

- The structure does not fill during dry weather, which would result in stagnant sewage and odor issues; and
- The structure drains without pumping during dry weather.

Figure 2 shows the sewer elevation in the vicinity of the proposed WWDS. The dry weather water level in the 48-inch influent sewer is not known. It is assumed for the purpose of this Study that the dry weather maximum water level is at 32.77' (spring line elevation). This value is of critical importance since the lower it is, the larger the structure capacity will be for the same construction cost.

If the dry weather maximum water level is higher than assumed, a horizontally mounted, motor actuated, knife gate valve could be installed at the connection point and programed to open only during storm events and not during dry weather daily peak flows.

¹ Refer to Exhibit 5 - March 26, 2011 Spill at DA Porath Facility (Table)

² Refer to Exhibit 2 - Arcadis, Hydraulic Model Support, System Capacity Evaluation Report, Draft, October 2013

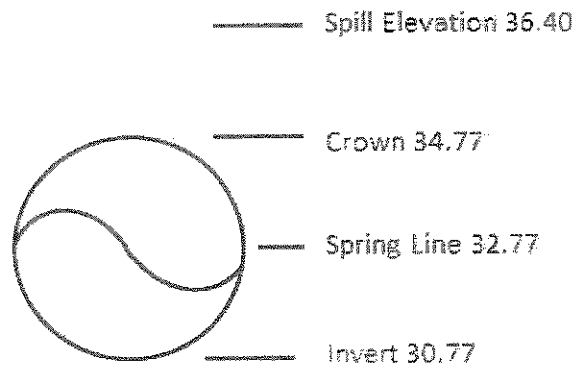

Figure 2 48-inch Influent Sewer Elevation

The WWDS elevation is then between 32.77' and 36.40', which corresponds to a maximum useful height of 3.63 feet.

SRT recommends SCCSD monitor and calculate the dry weather maximum water level in the 48-inch influent sewer using the water level measurements in the wet well.

Preliminary Design

The preliminary layout of the WWDS is presented in Attachment B. The layout shows a five-compartment precast concrete storage facility. The proposed individual chambers are 4 feet deep, 10 feet wide and 80 feet long. The ultimate storage capacity of each chamber is approximately 24,000 gallons, however not all of this volume would be available due to grout fill used to slope the floors and approximately 4 inches of headspace provided above the spill elevation of 36.40'.

The structure is made out of precast reinforced concrete boxes that are readily available from several precast concrete manufacturers. Concrete shall be suitable for periodic exposure to domestic wastewater.

Construction of a new manhole under Lode Street is proposed to connect the new WWDS to the existing 48-inch gravity sewer.

The estimated weight of the boxes filled with water is 500 pounds per square foot. This is four times lower than the allowable soil bearing pressure determined for construction of a residential property near the proposed WWDS³. Extended base slabs and other provisions may be required to counteract buoyance of the empty boxes, assuming the groundwater elevation is at the ground surface.

Visual impact will be minimal as the entire WWDS would be buried and grass surface would be re-established following construction completion. Black fiberglass manhole covers would be the only visible feature at the surface. Figures 3 and 4 present conceptual 3D renderings of the proposed WWDS.

³ Refer to Geotechnical Investigation – Design Phase prepared for 2664 Place Street, Santa Cruz, CA 95062

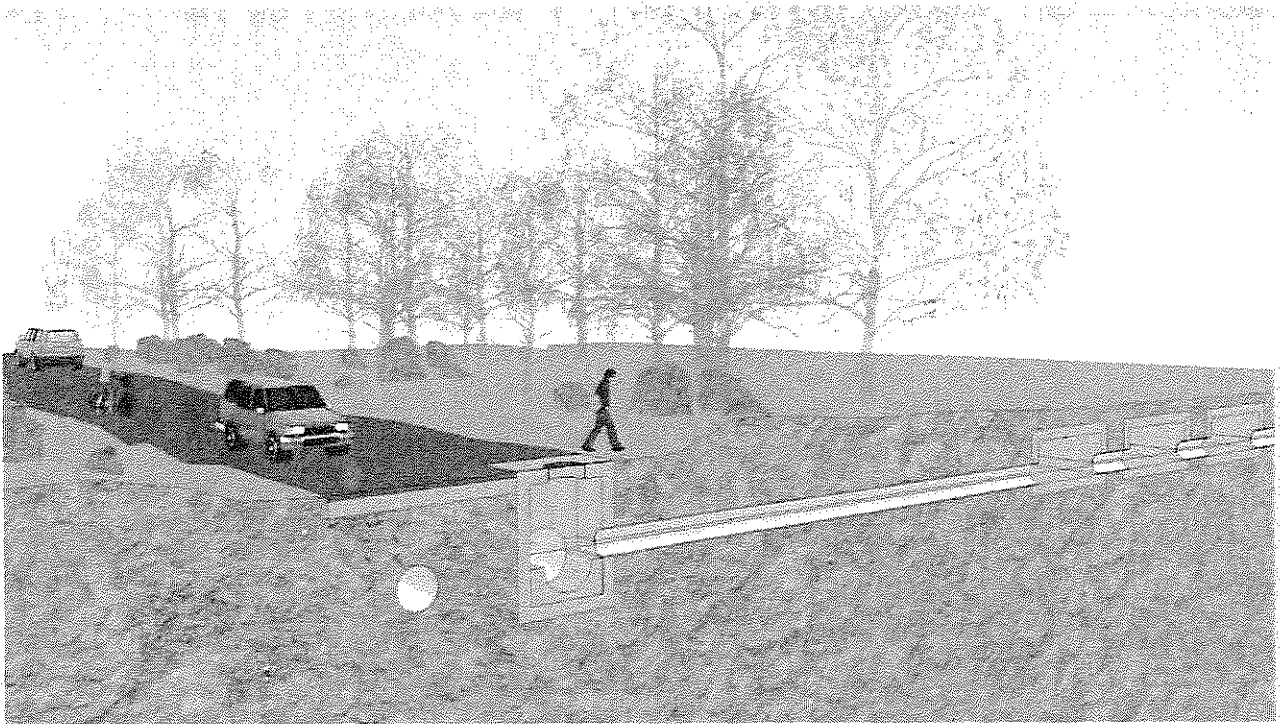

Figure 3 Conceptual 3D Rendering of the WWDS 1/2



Figure 4 Conceptual 3D Rendering of the WWDS 2/2

Constructability

SRT recommends performing a geotechnical investigation prior to designing the WWDS to

determine if rock or unsuitable materials are present.

Construction may require local groundwater dewatering. It is recommended that the construction work be done during the dry season in order to mitigate this problem. The use of sheeting for trench wall support is not anticipated to be needed due to the relatively shallow excavations needed to construct the proposed facility. The contractor may choose to bench the sides of the excavation in the deeper areas. Attachment C shows a similar, albeit much larger, detention facility under construction. Similar scope of construction is anticipated. Sewage will need to be temporarily bypassed when constructing the WWDS connection manhole.

OPERATIONS/MAINTENANCE

The WWDS maintenance would likely consist of periodic (annual) cleaning of the chambers to remove solids/grease that may have accumulated during heavy rain events. This can be accomplished with high-pressure water. Solids and wash water can be directed to the 48-inch gravity sewer or removed by a Vactor truck. The amount of solids cannot be predicted, but is expected to be minimal due to the infrequent use of the WWDS and the favorable slope of the chambers.

Maintenance crews would be able to access the new structure through the three-foot diameter, Fiberglass Reinforced Plastic (FRP) manhole covers located at each end of the five chambers.

Manhole covers would be ventilated. Flow would enter and displace the headspace air only during significant storm events. When the structure is filling, slight odors may be detectable at the manhole vents, however it is anticipated that it would not be detectable at the fence line and would not affect the residence adjacent to the proposed facility.

As an option, a level sensor could be installed at the WWDS and an alarm signal sent back to the DA Porath Facility in the event of flooding. Hydrogen sulfide (H₂S) sensors could also be installed to monitor corrosion potential and fugitive odors emitted from the WWDS.

PERMITTING

It is anticipated that Environmental Review pursuant to the California Environmental Quality Act (CEQA) will be required. Since the proposed facility would be installed completely underground and the site returned to its original vegetation following construction completion, a Negative Declaration or Mitigated Negative Declaration level CEQA review is anticipated for this project.

OPINION OF CONSTRUCTION COST AND DURATION

The construction duration for a project of this size is estimated at four to six months.

The engineer's opinion of budget-level construction cost for a 100,000-gallon WWDS is approximately \$820,000. Table 1 provides the cost breakdown.

Table 1 Opinion of Probable Construction Cost

Item	Description	Cost (\$)
1	Precast concrete vaults (Refer to Attachment E)	330,000
2	Earthwork	100,000
3	Vault installation	100,000
4	Piping	20,000
5	Connection to 48-inch Sewer	30,000
6	Site restoration	50,000
	<i>Subtotal 1</i>	<i>630,000</i>
	Contingency at 20% (rounded up to \$10k)	130,000
	<i>Subtotal 2</i>	<i>760,000</i>
	Motor operated isolation valve (optional)	60,000
	Total	\$820,000

RECOMMENDATIONS

SRT recommends SCCSD evaluate the assumptions made during the feasibility study regarding the capacity and height of the proposed WWDS prior to moving forward with its permitting process and design, as follows:

- Capacity: using the recently calibrated hydraulic model, determine the detention capacity that would eliminate the risk of SSO during a 10-year, 2-hour design storm and the expected frequency at which the system might overflow with a 100,000-gallon detention structure.
- Height: confirm the spill elevation is at 36.40' and determine the dry weather maximum water level in the 48-inch influent sewer in the vicinity of the new structure.

LIST OF ATTACHMENTS

Attachment A – Documents Consulted During the Study

Attachment B – Preliminary Layout of the Wet Weather Detention System

Attachment C – Photos of a Similar Detention System Under Construction

Attachment D – Cut Sheet And Quote From Old Castle, One Precast Concrete Manufacturer

Attachment A

Documents Consulted During the Study

The following is a list of documents provided by SCCSD and used in this feasibility study:

- Exhibit 1 – Map of SCCSD Predicted Pipe Surge Areas, Completed Projects, And Capital Improvement Projects
- Exhibit 2 – Arcadis, Hydraulic Model Support, System Capacity Evaluation Report, Draft, October 2013
- Exhibit 3 – SCCSD, East Cliff Pump Building and Chlorination Channel Grade Slab and Plan Sections, October 2013
- Exhibit 4 – March 26, 2011 DA Porath Wet Well Level And Volume (Graphs)
- Exhibit 5 – March 26, 2011 Spill at DA Porath Facility (Table)
- Exhibit 6 – Capitola Village Impact Area
- Exhibit 7 – Table 5.2 from ASCE Manual of Engineering Practice No. 92, Detailed Criteria of I/I Rate Given for Each Defect
- Exhibit 8 – Soquel, Corralitos, and San Lorenzo Stream Flow Gage Data
- Exhibit 9 – Capitola Weather Net, Gage KCACAPIT1, December 28th & 29th, 2010 Storm
- Exhibit 10 – December 2012 Storm Data
- Exhibit 11 – Nobel, Arana, and Rodeo Gulch Impact Basin Maps
- Exhibit 12 – City of San Diego, Manhole Overflow Flow Rate Guide, October 11, 2011
- Exhibit 13 – D.A. Porath Facility, Overflow Diagram, Revised October 18, 2013
- Exhibit 14 – County of Santa Cruz, March 2011 Storm Damage Information Package prepared in pursuit of California Disaster Assistance Act (CDAA) funding
- Site map
- AutoCAD topographical survey file of project area
- Geotechnical Investigation – Design Phase prepared for 2664 Placer Street, Santa Cruz, CA 95062, 2/17/2011
- Santa Cruz County Sanitation District, East Cliff Transmission Facilities (as Record Drawings), 1974

Attachment B

Preliminary Layout of the Wet Weather Detention System

Attachment C

Photos of a Similar Detention System Under Construction

The following photos were taken in El Granada, CA during the construction of a similar passive Wet Weather Detention System that SCCSD Staff visited after construction in 2013. These pictures are communicated for illustration purposes. The intent is to show major construction steps and typical construction details.

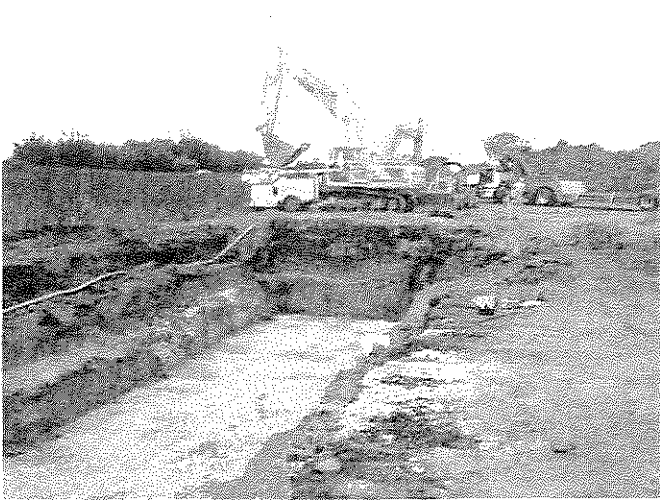

Fig. C-1: Excavation and subbase preparation

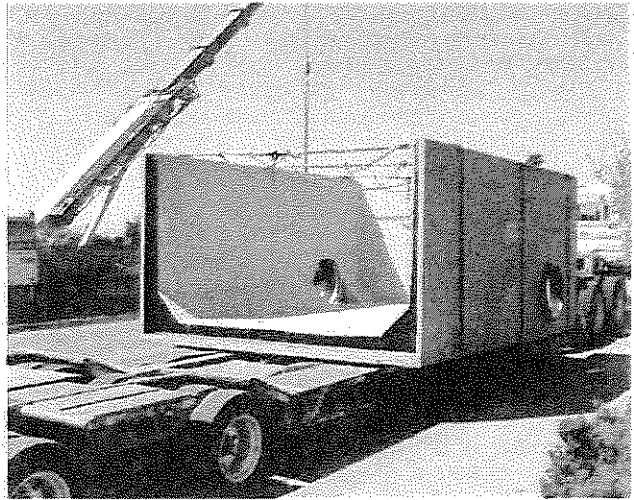

Fig. C-2: Vault sections arriving at project site



Fig. C-3: Installing precast concrete vault sections

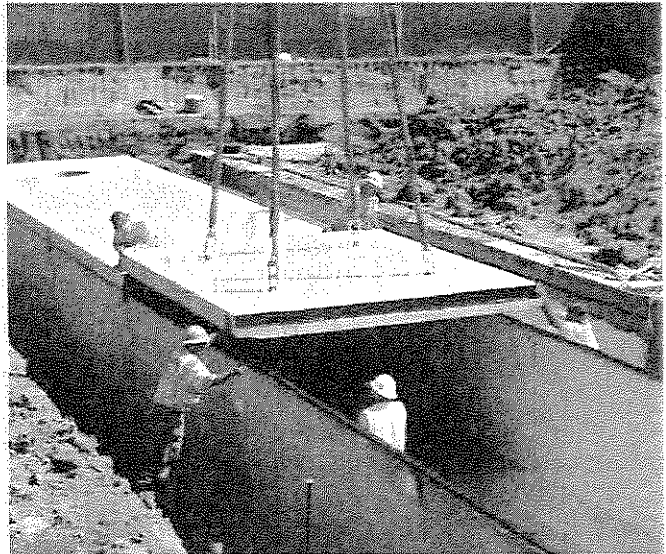

Fig. C-4: Installing precast roof slab

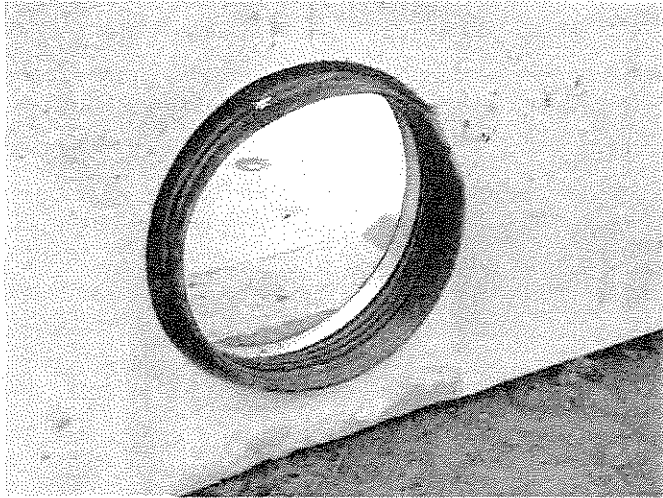

Fig. C-5: Sewer pipe boot at pipe connection

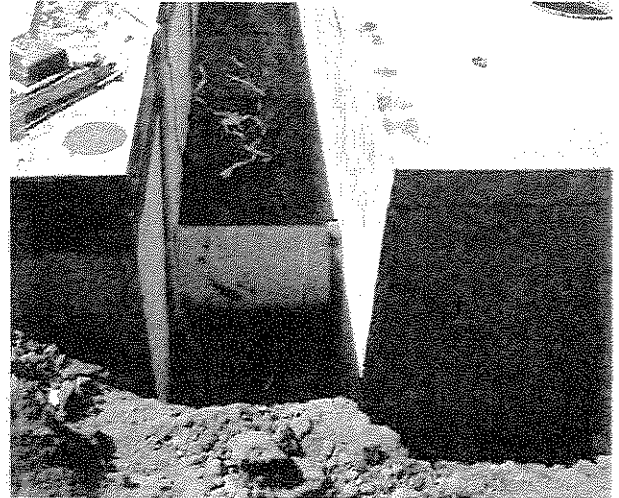

Fig. C-6: Piping connection between chambers

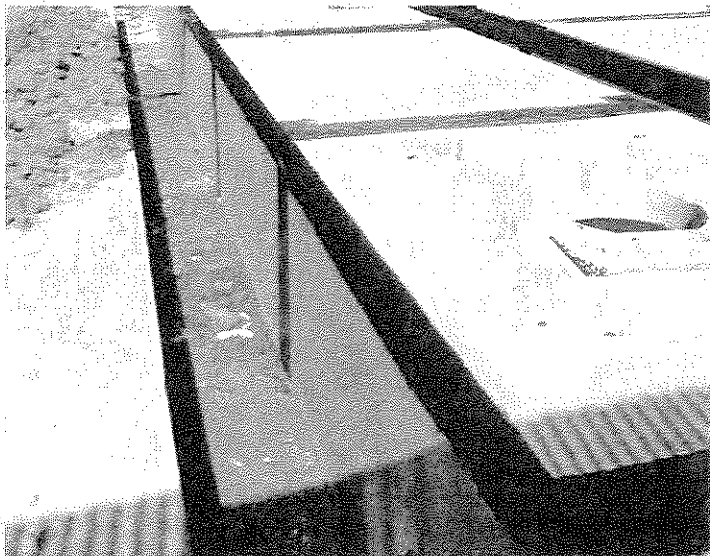

Fig. C-7: Sealants to assure water tightness of vaults

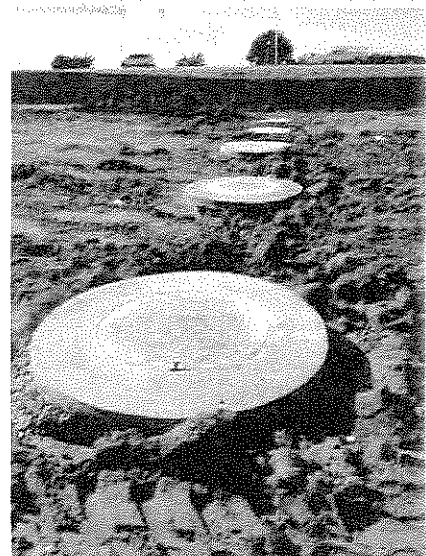
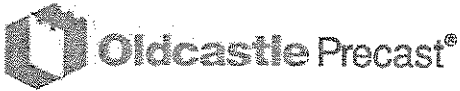

Fig. C-8: Fiberglass manhole frame and cover with concrete ring

Attachment D

Cut Sheet And Quote From Old Castle, One Precast Concrete Manufacturer



Contract & Proposal

Quote No.: S176393-1

3786 Valley Avenue
Pleasanton, CA 94566

Telephone : 925- 846-8183
Fax: 925-846-4904

www.oldcastleprecast.com

Quote To: SRT Consultants

Ship To: SANTA CRUZ
TBD
Santa Cruz, CA 95060

Reference : JEFF 415-776-5800

Contact:

Phone:

Order No	Date	Customer No	Terms	Cash discount	Delivery terms	Quote valid for:
S176393	3/26/2014		Cash on Delivery		FOB Job Site	30 days

Qty	Unit	Item	Description	Mark	Unit price	Amount
1.00	Ea	0000001	PRICES ARE GOOD FOR THE DESCRIPTIONS LISTED, ANY CHANGES MAY RESULT IN PRICE CHANGE. PRICE INCLUDES DELIVERY TO SITE CONTRACTOR TO PROVIDE CRANE AND RIGGING TO OFFLOAD AND SET, HEAVIEST PIECE IS AREX 20,124 LBS.			

Group: A

Qty	Unit	Item	Description	Mark	Unit price	Amount
70.00	Ea	4724000	10' X 4' X 5' BOX CULVERT WITH 10" WALLS AND WELD PLATES.		4,369.50	305,865.00
10.00	Ea	4724000	10' X 4' X 5' BOX CULVERT END PIECES WITH 10" WALLS, 24" DIA KEYED ACCESS AND WELD PLATES. WE CAN LEAVE EXPOSED REBAR FOR CONTRACTOR TO TIE INTO TO POUR CLOSE END PIECES AT SITE.			
40.00	EA	99923310	24 Grade Ring 12in Tall			
21.00	BOX	99958815	ConSeal Butyl Sealant 1in Width 8 Rolls/Box CS102			
10.00	Ea	4040305	D&L A-1024 F & C Closed Pick / Gasketed -Sanitary Sewer			

Group: B

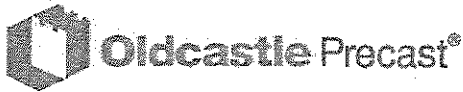

Contract & Proposal

Quote No.: S176393-1

3786 Valley Avenue
Pleasanton, CA 94566

Telephone : 925- 846-8183
Fax: 925-846-4904

www.oldcastleprecast.com

Quote To: SRT Consultants

Ship To: SANTA CRUZ
TBD
Santa Cruz, CA 95060

Reference : JEFF 415-776-5800

Contact:

Phone:

Order No	Date	Customer No	Terms	Cash discount	Delivery terms	Quote valid for:
S176393	3/26/2014		Cash on Delivery		FOB Job Site	30 days

Qty	Unit	Item	Description	Mark	Unit price	Amount
1.00	Ea	0000001	Price assumes acceptance of Oldcastle Precast's standard terms and conditions, material sources, manufacturing processes and standard methods of delivery. End user / Contractor is responsible for any testing and contract compliance issues.			

Group: C

Qty	Unit	Item	Description	Mark	Unit price	Amount
1.00	Ea	0000003	Quote Provisions: - 1 hr. allowed for unloading. Extra time charged at \$100 per hour flat bed and \$175 per hour for boom truck. Assessed or applicable fuel surcharges on freight will be invoiced to customer at cost only. - Oldcastle Precast will store special and/or custom ordered material for 30 days after			

Contract & Proposal

Quote No.: S176393-1

 3786 Valley Avenue
 Pleasanton, CA 94566

 Telephone : 925-846-8183
 Fax: 925-846-4904

www.oldcastleprecast.com

Quote To: SRT Consultants

 Ship To: SANTA CRUZ
 TBD
 Santa Cruz, CA 95060

Reference : JEFF 415-776-5800

Contact:

Phone:

Order No	Date	Customer No	Terms	Cash discount	Delivery terms	Quote valid for:
S176393	3/26/2014		Cash on Delivery		FOB Job Site	30 days

production. After 30 days storage the material will be invoiced and payment due per our standard terms and conditions. Material not delivered 90 days after invoicing will be subject to storage fees (1% of the remaining/stored order value).

- Freight is quoted for full truck load quantities. Short load quantities beyond our control will be subject to additional freight to cover cost of delivery.

- Oldcastle Precast requires a minimum of 24 hours notice prior to delivery for cancellation. Cancellations with less than 24 hours notice are subject to full freight charges (in addition to the rescheduled delivery charges).

All products and services listed on this Quotation are provided under the Standard Terms and Conditions located at www.oldcastleprecast.com/company/pages/credit.aspx.

QUOTATION TOTAL US 305,865.00

IMPORTANT: This proposal is based on standard terms and conditions. Items and quantities shown are the basis for the quotation, and we are not responsible for any discrepancies between this list and actual items or quantities.

 (Accepted by)

Sales Person: Deanna Green Telephone: 925-846-8183

 (Position)

 (Date)

By: _____

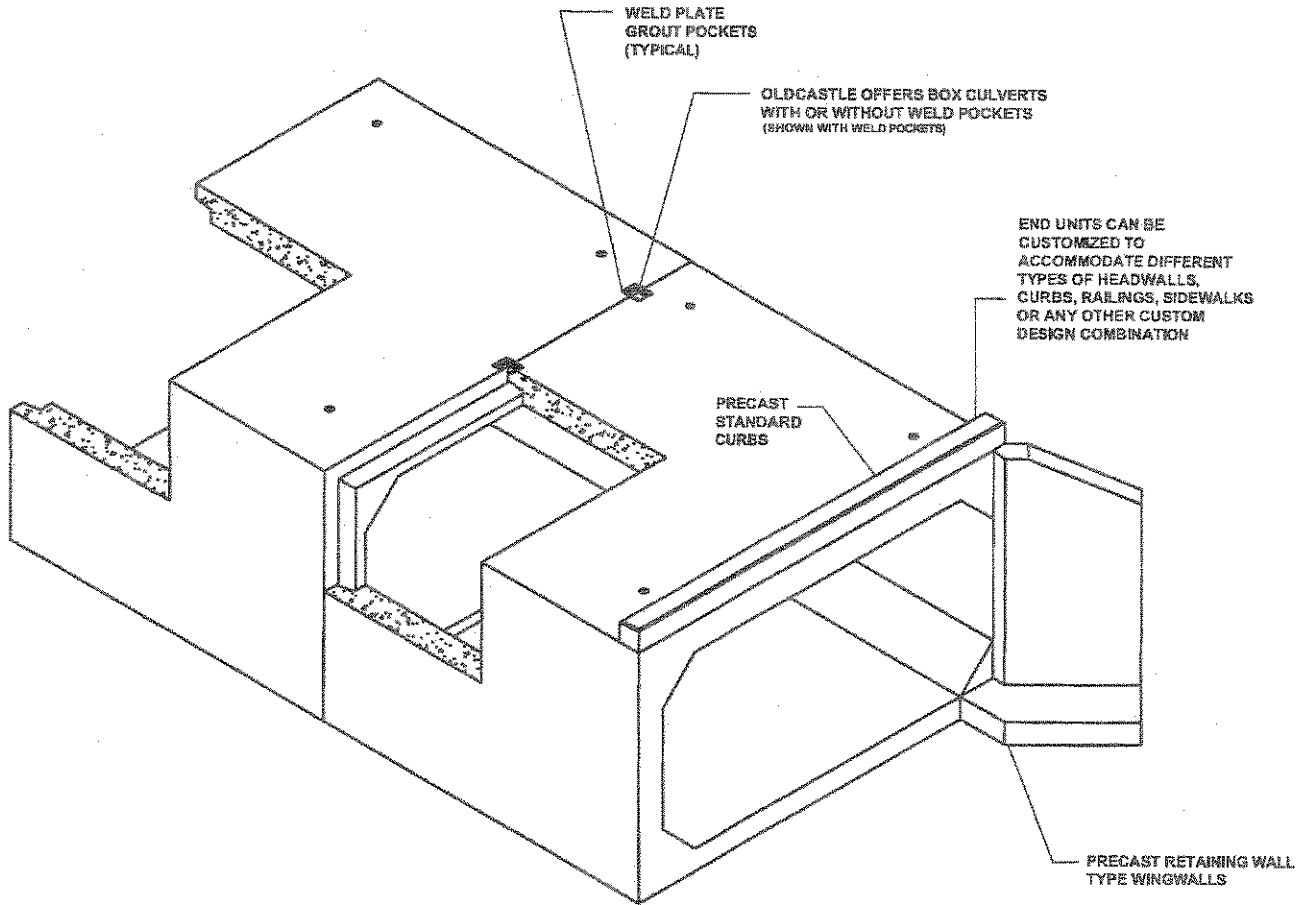

**TYPICAL
ISOMETRIC BOX CULVERT LAYOUT**

**SHOWING BOX CULVERTS SECTIONS
CURBS & WINGWALL
(Retaining Wall Type Wingwall)**

Exhibit 2

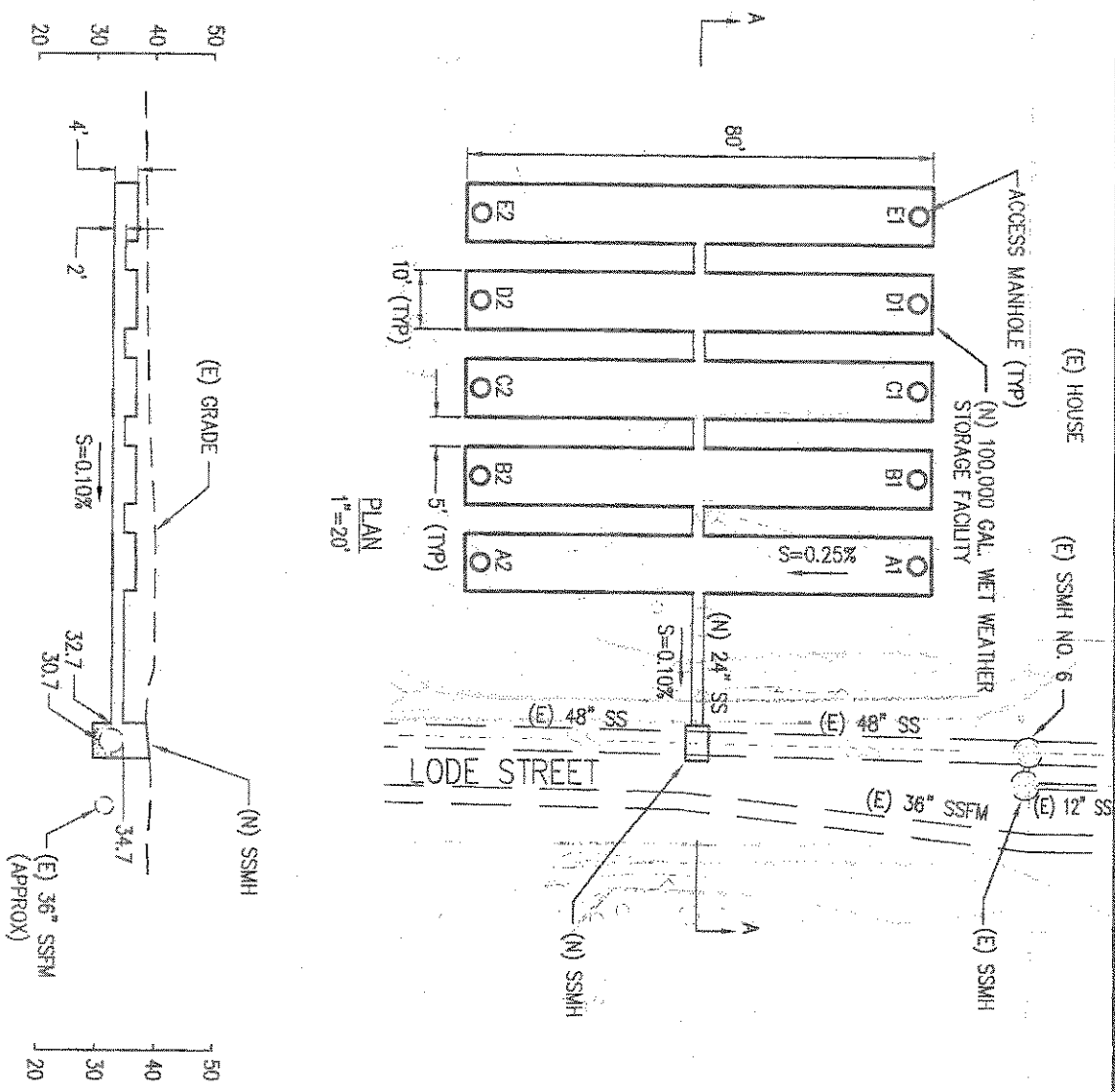
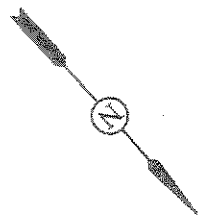

SECTION A-A
1" = 20'

G001	DATE: 02/26/14 TIME: 10:00 AM DRAWN BY: J. FORNBERG CHECKED BY: J. FORNBERG IN CHARGE: J. FORNBERG	D.A. FORNBERG FACILITY-WET WEATHER STORAGE FACILITY PRELIMINARY LAYOUT	SANTA CRUZ COUNTY SANITARY DISTRICT 701 OCEAN STREET, SUITE 410 SANTA CRUZ, CA 95060-4073	S R T consultants <small>732 Bay Street San Francisco, CA 94109 Ph 415.778.5902 Fx 415.778.5200</small>	NOT FOR CONSTRUCTION	<table border="1"> <tr> <th>NO.</th> <th>DESCRIPTION</th> <th>DATE</th> <th>BY</th> </tr> <tr> <td>0</td> <td>PRELIMINARY STUDY</td> <td>02/26/14</td> <td>JF</td> </tr> </table>	NO.	DESCRIPTION	DATE	BY	0	PRELIMINARY STUDY	02/26/14	JF
	NO.	DESCRIPTION	DATE	BY										
0	PRELIMINARY STUDY	02/26/14	JF											
REVISIONS														