

A large, light gray watermark graphic of a clipboard with a checklist and a pencil is centered in the background. The clipboard has a circular hole at the top, a checklist with several horizontal lines, and a pencil pointing downwards. The pencil is colored in shades of yellow and orange. The entire graphic is set against a white background with a teal header and a green footer.

# Appendix A

SCM Fact Sheets

## School CAPTURE Guidance

### Runoff Capture Practices

Aboveground Storage .....	AGS-1
Bioretention Planter .....	BP-1
Constructed Wetland.....	CW-1
Detention Basin.....	DB-1
Drain Inlet Insert.....	DII-1
Dry Well.....	DW-1
Green Roof.....	GR-1
Hydrodynamic Separator .....	HS-1
Infiltration Basin .....	IB-1
Infiltration Gallery .....	IG-1
Infiltration Trench.....	IT-1
Media Filter.....	MF-1
Oil Water Separator .....	OWS-1
Porous Pavement.....	PP-1
Underground Storage Vault .....	USV-1
Vegetated Buffer Strip .....	VBS-1
Vegetated Swale.....	VSW-1
Wet Pond.....	WP-1

# Aboveground Storage Factsheet

## 1.0 GENERAL DESCRIPTION



Figure 1. Aboveground storage (Porter County IN)

Potential Treatment Mechanisms								
I	ET	FA	B	RH	S	F	P	T
				✓	✓			
Legend: I = Infiltration			S = Sedimentation					
ET = Evapotranspiration			F = Flootation					
FA = Filtration and/or Adsorption			P = Plant Uptake					
B = Biochemical Transformation			T = Trash Capture					
RH = Rainfall and Runoff Harvest								

Aboveground storage can consist of rain barrels, cisterns, or other containers—usually made of either metal or plastic—that receive roof stormwater runoff from a downspout for temporary storage. These containers can have either an open outlet or a valve from which the water can more slowly infiltrate the ground below or be used as a non-potable water source. Some may also have a bypass valve or other form of filtration to help filter out grit and other contaminants. In addition, most have either a screen and/or tight seals to keep out mosquitos or other vectors and pests. A schematic of one type of container is shown in Figure 2.

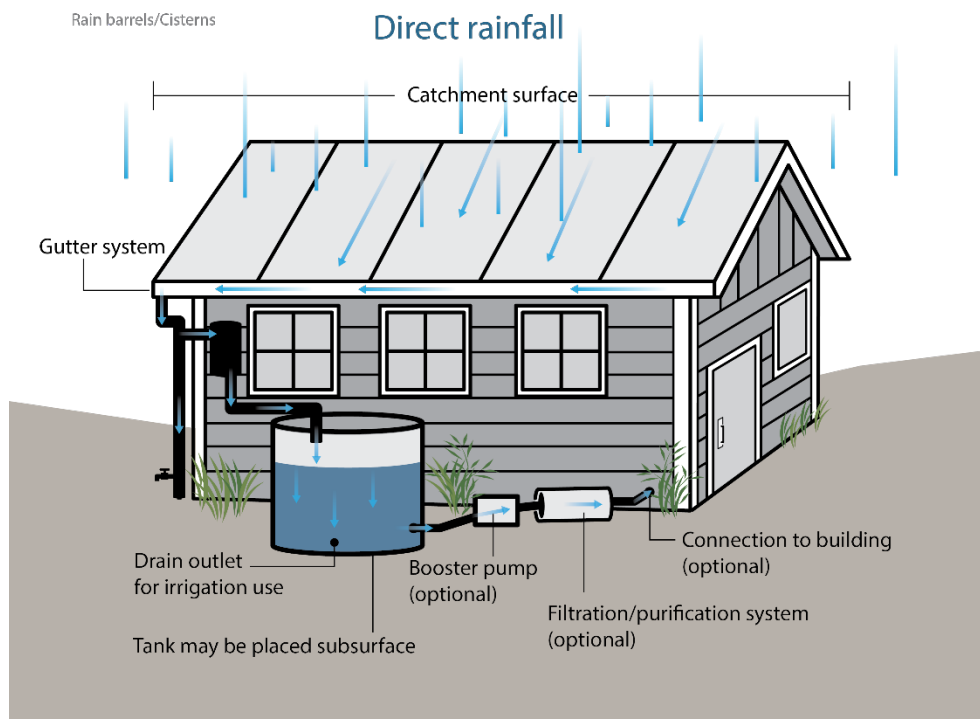

Figure 2. Basic schematic of aboveground storage

### 1.1 Variations and Alternative Names

- Harvest and (Re)Use (Practices)
- Aboveground cisterns
- Rain barrels

## 2.0 ADVANTAGES & LIMITATIONS

### 2.1 Advantages

- ✓ Can be used in areas where space is limited

## Aboveground Storage Factsheet

- ✓ Provides an alternative non-potable water source
- ✓ Can easily be added to existing buildings

### 2.2 Limitations

- ✗ Limited storage capacity
- ✗ If not properly installed or maintained, odors and mosquito habitat may develop
- ✗ May require permitting or be subject to plumbing code regulations
- ✗ May require pumps

### 3.0 SITING

Aboveground storage should be located in a shaded area to help limit algal growth and on stable flat ground or pavement for stability.

### 4.0 DESIGN CONSIDERATIONS

When adding aboveground storage, the following design parameters should be considered:

- Volume
- Space available
- Existing gutters
- Tank opacity
- Piping
- Screening
- Overflow
- Pump size (optional)

### 5.0 CONSTRUCTION CONSIDERATIONS

- Level area where the aboveground storage is to be placed

### 6.0 MAINTENANCE

- Checks of seals and screens to prevent entry by mosquitos and other pests
- Inspections of all components for leaks
- Pump maintenance, if required
- Removal of sediment, if required

### 7.0 REFERENCES

California Stormwater Quality Association (CASQA 2003). *Stormwater Best Management Practice Handbook: New Development and Redevelopment*. January 2003.

County of Placer, City of Roseville, City of Auburn, City of Lincoln, and Town of Loomis (County of Placer et al. 2016). *West Placer Storm Water Quality Design Manual*. April 2016.

# Bioretention Planter Factsheet

## 1.0 GENERAL DESCRIPTION



Figure 1. Bioretention planter

Bioretention planters are depressed landscapes into which runoff is directed and allowed to collect, filter, and sometimes infiltrate. These planters come in a variety of configurations. All include a few inches of ponding depth (often 4 to 6 inches). A raised inlet allows a means of bypass in case of overflows. Under the ponding zone is the planting zone. The planting zone is constructed using various media blends that support growth and filter and retain pollutants. Mulch is sometimes applied over the planting zone for plant health and weed management. The ponding zone temporarily stores runoff and promotes percolation into the planting mix and bioretention mix below. In addition to storing the runoff in its pore structure, the bioretention mix filters and biotreats the runoff. In some configurations, water drains into a subsurface storage layer (typically gravel or porous road base) below the bioretention mix. These systems are preferably unlined to allow infiltration into the underlying native soils. A perforated underdrain can be located at the top of the storage component to reduce the amount of untreated overflows that can occur where the soil type or available area limit infiltration. A schematic of this configuration is shown in Figure 2.

Topsoil may or may not be used within the planters. Some practitioners argue topsoil is necessary for plant growth in some climates, while others believe it is not needed and hinders infiltration. Some use a geotextile fabric placed below the bioretention mix in configurations with gravel storage to prevent the smaller-sized bioretention mix particles from migrating into the storage zone and possibly escaping via the underdrain. Alternatively, to avoid possible fabric clogging, some practitioners use a transitional-sized aggregate or a porous base with smaller pore spaces than gravel.

Potential Treatment Mechanisms								
I	ET	FA	B	RH	S	F	P	T
✓*	✓	✓	✓		✓		✓	✓

Legend: I = Infiltration  
 ET = Evapotranspiration  
 FA = Filtration and/or Adsorption  
 B = Biochemical Transformation  
 RH = Rainfall and Runoff Harvest  
 S = Sedimentation  
 F = Flootation  
 P = Plant Uptake  
 T = Trash Capture

\*For unlined systems

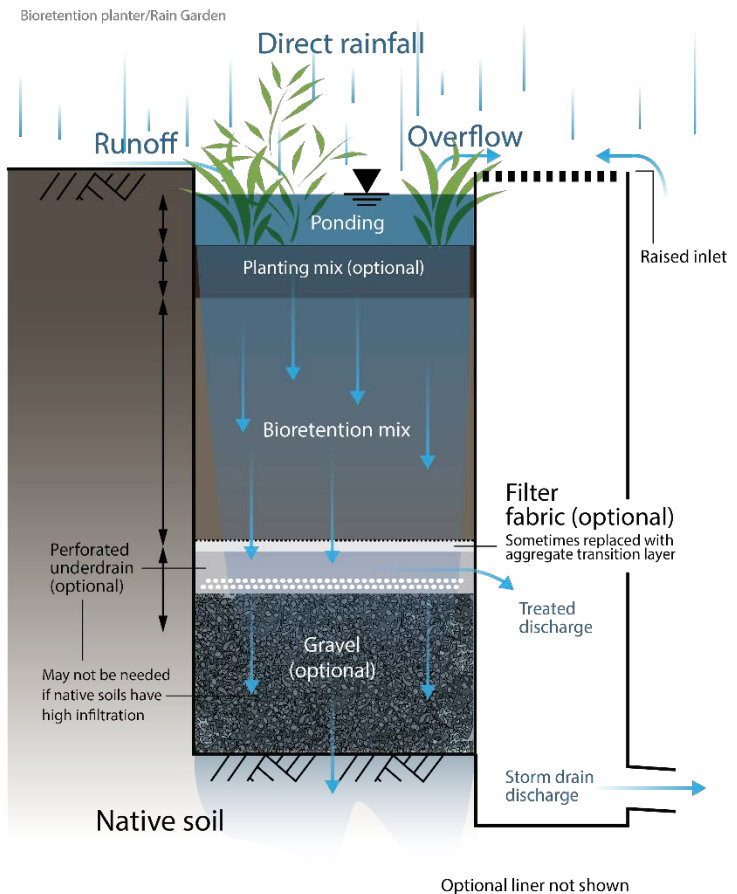

Figure 2. Schematic of a basic bioretention planter

A schematic of this configuration is shown in Figure 2.

# Bioretention Planter Factsheet

## 1.1 Variations and Alternative Names

- Rain gardens
- Lined bioretention planters
- Infiltrating stormwater planters
- Bioretention cells
- Vegetated filters
- Biotreatment

## 2.0 ADVANTAGES & LIMITATIONS

### 2.1 Advantages

- ✓ When done well, rain gardens can be both inexpensive and add aesthetic appeal
- ✓ Can create habitat
- ✓ Can be used in areas with limited space
- ✓ Can optimize load reduction by allowing both infiltration and filtration (treat and discharge) components

### 2.2 Limitations

- ✗ Requires terracing for steeper slopes
- ✗ Limited to a small contributing drainage area

## 3.0 SITING

The site should be relatively flat and, in some climates, irrigation should be available during the dry season.

## 4.0 DESIGN CONSIDERATIONS

When designing a bioretention planter or rain garden, the following parameters should be considered:

- Contributing drainage area
- Flat layers (no slope)
- Design volume
- Drawdown time
- Transitional side slopes
- Surcharge depth
- Soil types and media
- Layer depths (ponding, planting, and subsurface storage)
- Area
- Underdrain
- Overflow
- Containment curb/curb cuts (optional)
- Precise inlet, overflow, and media depth elevations
- Hydraulic soil group of existing subsurface material at final excavation depth
- Planting mix design
- Storage layer:
  - Usually when underdrain is used
  - Media type
  - Media depth
- Liners for high groundwater or contaminated soils
- Soils testing of delivered fill material

## 5.0 CONSTRUCTION CONSIDERATIONS

- Stabilize drainage area or divert any flows to prevent sediment loading and/or erosion during construction

## Bioretention Planter Factsheet

- Replace plants damaged during construction
- Provide temporary irrigation until plants are established
- Ensure correct elevation before and during concrete work

### 6.0 MAINTENANCE

- Plant management
  - Identification and promotion of desired species
  - Removal of unwanted species (not all volunteer species are undesirable)
  - Increased plant density can decrease weeds
- Litter removal (for areas prone to litter)
- Inspections for standing water to prevent mosquitos and other vector breeding
  - Top layer of the planter may need to be replaced if standing water becomes a chronic issue

### 7.0 REFERENCES

California Stormwater Quality Association (CASQA 2003). *Stormwater Best Management Practice Handbook: New Development and Redevelopment*. January 2003.

California Stormwater Quality Association (CASQA 2017). *Draft Stormwater Best Management Practice Handbook: New Development and Redevelopment*. April 2017.

County of Placer, City of Roseville, City of Auburn, City of Lincoln, and Town of Loomis (County of Placer et al. 2016). *West Placer Storm Water Quality Design Manual*. April 2016.

Sacramento Stormwater Quality Partnership (SSQP 2018). *Stormwater Quality Design Manual*. July 2018.

# Constructed Wetland Factsheet

## 1.0 GENERAL DESCRIPTION



Figure 1. Constructed wetland (EPA)

Constructed wetlands are vegetated basins with shallow pools of water that allow stormwater to slowly infiltrate and receive treatment from the plant roots. The shallow pool may only exist through the wet season though some exist year-round, depending on location and climate. The wetland may or may not discharge back into a downstream water body. A schematic of a wetland is shown in Figure 2.

Potential Treatment Mechanisms								
I <sup>1</sup>	ET	FA	B	RH	S	F	P	T
✓	✓	✓	✓		✓		✓	
Legend: I = Infiltration			S = Sedimentation					
ET = Evapotranspiration			F = Floatation					
FA = Filtration and/or Adsorption			P = Plant Uptake					
B = Biochemical Transformation			T = Trash Capture					
RH = Rainfall and Runoff Harvest								

<sup>1</sup> For unlined systems only; these systems are sometimes constructed with a liner

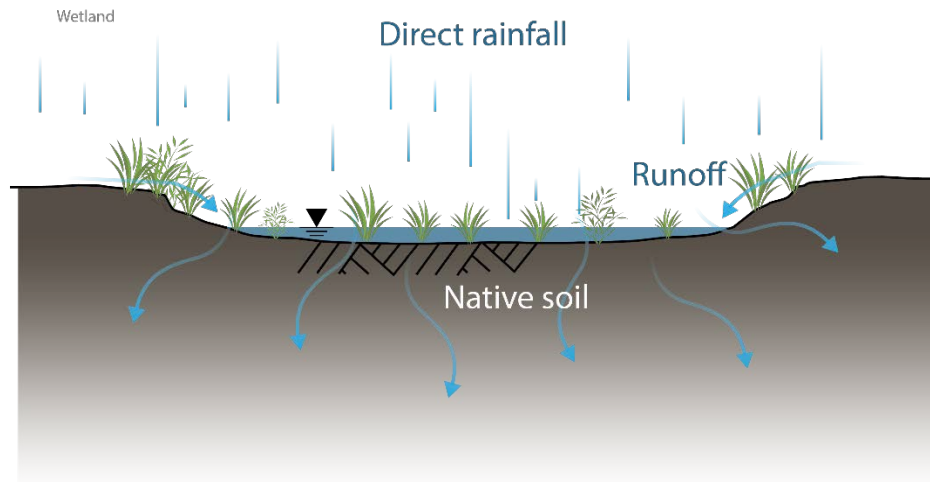

Figure 2. Schematic of a basic constructed wetland

## 2.0 ADVANTAGES & LIMITATIONS

### 2.1 Advantages

- ✓ Can provide habitat for wetland wildlife and add aesthetic appeal
- ✓ If designed and constructed well, constructed wetlands can provide significant reduction in contaminants/pollutants

### 2.2 Limitations

- ✗ Typically take years to establish
- ✗ Will require irrigation/supplemental water at first
- ✗ Public access safety concerns may require security fencing around the area
- ✗ Requires a significant amount of land



## Constructed Wetland Factsheet

### 3.0 SITING

Constructed wetlands are not suitable for areas with steep/unstable slopes. They are also not suited for cold water systems because the relatively deep still water in the pool will be much warmer than the cold water stream and so may warm the stream if it is discharged.

If the site has significantly porous soil, an impermeable liner along the bottom may be required.

### 4.0 DESIGN CONSIDERATIONS

When designing a constructed wetland, the following parameters should be considered:

- Contributing drainage area
- Design volume
- Drawdown time
- Permanent pool volume/depth
- Liner (optional)
- Inlet/outlet erosion control
- Forebay
- Open-water, wetland, and outlet zones
- Surcharge depth
- Length to width ratio
- Freeboard
- Bottom slope
- Embankment slope
- Side slopes
- Maintenance access ramp
- Vegetation
- Vector control animals (e.g., mosquito fish)

### 5.0 CONSTRUCTION CONSIDERATIONS

- Do not allow heavy machinery, vehicles, and other traffic to enter the basin
- Stabilize drainage area or divert any flows to prevent sediment loading and/or erosion during construction
- Ensure that the bottom is graded to be level and relatively flat
- Install seepage collars on outlet piping to prevent water from seeping out and causing damage

### 6.0 MAINTENANCE

- Maintain permanent pool of water (if designed to)
  - may require water to be pumped in
- Replace plants damaged during construction as well as any that do not establish
- Inspections for:
  - leaks in the outlet
  - trash and debris accumulation
- Inspections and treatment for mosquitos and other vectors

### 7.0 REFERENCES

California Stormwater Quality Association (CASQA 2003). *Stormwater Best Management Practice Handbook: New Development and Redevelopment*. January 2003.

California Stormwater Quality Association (CASQA 2017). *Draft Stormwater Best Management Practice Handbook: New Development and Redevelopment*. April 2017.

Sacramento Stormwater Quality Partnership (SSQP 2018). *Stormwater Quality Design Manual*. July 2018.

# Detention Basin Factsheet

## 1.0 GENERAL DESCRIPTION

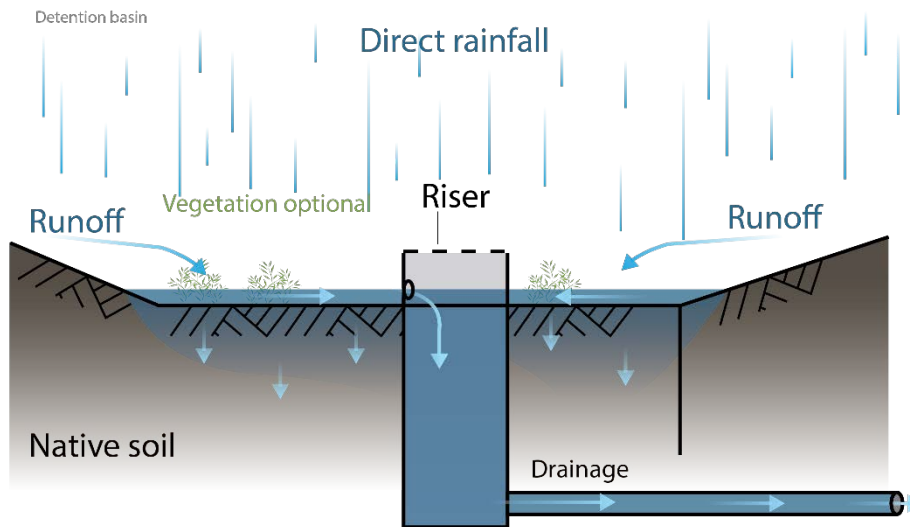

**Figure 1. Detention basin (Stormwater Partners SW Washington)**

Potential Treatment Mechanisms								
I <sup>1</sup>	ET	FA	B	RH	S	F	P	T
✓					✓			✓
Legend: I = Infiltration ET = Evapotranspiration FA = Filtration and/or Adsorption B = Biochemical Transformation RH = Rainfall and Runoff Harvest S = Sedimentation F = Flootation P = Plant Uptake T = Trash Capture								

<sup>1</sup> For unlined systems only; these systems are sometimes constructed with a liner

Detention basins are designed to capture rainfall and runoff and hold it for a maximum time (e.g., up to 72 hours), after which the basin fully drains and returns to being a dry basin. The maximum drain time (via orifice drain and infiltration) is specified to prevent mosquito breeding and to restore capacity for subsequent storm events. A minimum drain time is sometimes specified to encourage quiescent conditions for particle sedimentation. An orifice on the outlet riser typically meters out treated water. A riser or overflow weir is typically provided to route flood flows. A schematic of a basic detention basin is shown in Figure 2.



**Figure 2. Schematic of a basic detention basin**

### 1.1 Variations and Alternative Names

- Detention ponds
- Extended detention basins
- Dry extended detention basins or ponds
- Dry ponds

## 2.0 ADVANTAGES & LIMITATIONS

### 2.1 Advantages

- ✓ Provides flood control as well as stormwater runoff treatment, in some cases
- ✓ Can be inexpensive
- ✓ Can have relatively low maintenance

## Detention Basin Factsheet

- ✓ Can be integrated into an aesthetically appealing landscape design, though access restriction may be required for public safety

### 2.2 Limitations

- ✗ Moderate pollutant removal
- ✗ May not be suited for areas where the water table is close to the ground surface
- ✗ Requires elevation change between inlet and outlet

### 3.0 SITING

To avoid direct connection to groundwater, reduce mosquito breeding habitat, and avoid wetland habitat conditions, the bottom of the basin should be located sufficiently above the wet season water table. If the water table is high, an impermeable liner may be required.

According to the California Stormwater Quality Association, detention basins should not be used for contributing drainage areas (CDA) of less than 5 acres because such a small CDA may require an orifice size so small that it will clog easily (CASQA 2003).

### 4.0 DESIGN CONSIDERATIONS

When designing a detention basin, the following parameters should be considered:

- Contributing drainage area
- Design volume
- Drawdown time
- Side slopes
- Length to width ratio (distance between inlet and outlet)
- Orifice diameter
- Slope stability
- Energy dissipation at inlet
- Maintenance and inspection areas
- Basin area and infiltration capacity
- Seepage collar (to prevent piping/internal erosion on bermed systems)
- Utility conflicts
- Buried manmade materials and past disposal practices

### 5.0 CONSTRUCTION CONSIDERATIONS

- Potholing is recommended to verify locations of buried infrastructure.

### 6.0 MAINTENANCE

- Identify and remediate clogging issues at the orifice or outlet screens (may require special training)
- Plant management
- Litter removal (for areas prone to litter)
- Inspect for standing water to prevent mosquitos and other vector breeding

### 7.0 REFERENCES

California Stormwater Quality Association (CASQA 2003). *Stormwater Best Management Practice Handbook: New Development and Redevelopment*. January 2003.

California Stormwater Quality Association (CASQA 2017). *Draft Stormwater Best Management Practice Handbook: New Development and Redevelopment*. April 2017.

Sacramento Stormwater Quality Partnership (SSQP 2018). *Stormwater Quality Design Manual*. July 2018.

# Drain Inlet Insert Factsheet

## 1.0 GENERAL DESCRIPTION



Figure 1. Drain inlet insert (Grainger)

Potential Treatment Mechanisms								
I	ET	FA	B	RH	S	F	P	T
		✓						
Legend: I = Infiltration					S = Sedimentation			
ET = Evapotranspiration					F = Floatation			
FA = Filtration and/or Adsorption					P = Plant Uptake			
B = Biochemical Transformation					T = Trash Capture			
RH = Rainfall and Runoff Harvest								

Drain inlet inserts are placed into drop inlets to provide sediment and debris removal. Most inserts employ a fabric or media filter. Some also use baffles to enhance sedimentation or isolate coalesced oil droplets. Others are constructed with coarse screens to target trash removal. The inlet typically requires little to no modification. Inlets are generally easily removed, although excessive sediment accumulation may increase the difficulty of removal. Removal mechanisms vary. Figure 2 shows a schematic of a basic drain inlet insert.

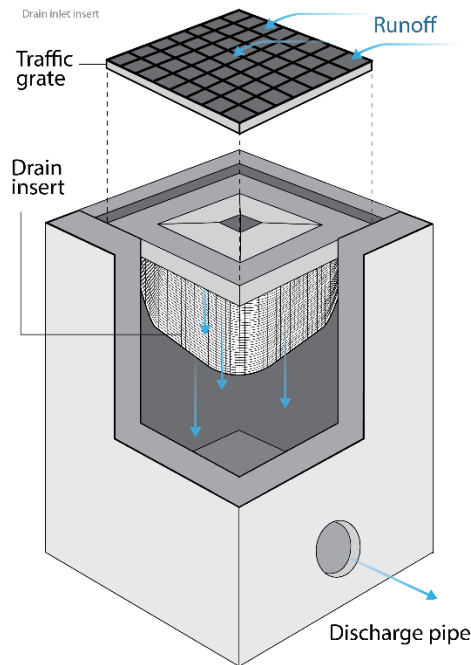

Figure 2. Schematic of a basic drain inlet insert

## 2.0 ADVANTAGES & LIMITATIONS

### 2.1 Advantages

- ✓ Does not require additional space/land
- ✓ Can be relatively inexpensive
- ✓ Easy to install and maintain

### 2.2 Limitations

- ✗ Less effective than other stormwater control measures
- ✗ Many models clog easily, especially if leafy debris is present

## **Drain Inlet Insert Factsheet**

### **3.0 SITING**

The California Stormwater Quality Association recommends that “inserts be used only for retrofit situations or as pretreatment where other treatment BMPs ... are used” (CASQA 2003, 2018).

### **4.0 DESIGN CONSIDERATIONS**

When designing a drain inlet insert, the following parameters should be considered:

- Contributing drainage area
- Filter media type
- Pretreatment needs of downstream stormwater control measures (e.g., trash removal)
- Litter/debris loading and storage capacity

### **5.0 CONSTRUCTION CONSIDERATIONS**

- Careful installation of insert to ensure there are no areas around the insert where stormwater may leak and bypass the filter

### **6.0 MAINTENANCE**

- Removal of trash and debris to avoid clogging of the inlet

### **7.0 REFERENCES**

California Stormwater Quality Association (CASQA 2003). *Stormwater Best Management Practice Handbook: New Development and Redevelopment*. January 2003.

California Stormwater Quality Association (CASQA 2017). *Stormwater Best Management Practice Handbook: New Development and Redevelopment*. April 2017.

# Dry Well Factsheet

## 1.0 GENERAL DESCRIPTION



Figure 1. Dry well (Torrent Resources)

Potential Treatment Mechanisms								
I	ET	FA	B	RH	S	F	P	T
✓		✓			✓	✓		
Legend: I = Infiltration			S = Sedimentation					
ET = Evapotranspiration			F = Flootation					
FA = Filtration and/or Adsorption			P = Plant Uptake					
B = Biochemical Transformation			T = Trash Capture					
RH = Rainfall and Runoff Harvest								

Dry wells are stormwater infiltration devices typically constructed with a vertical pipe that extends deep into the subsurface without contacting the groundwater table. A typical installation has a 3-foot diameter with a depth of 20–50 feet. The EPA defines dry wells as infiltration facilities that are deeper than they are wide. Perforations are located along the length of the pipe and/or at the bottom to permit stormwater to flow from various parts of the well into the surrounding soils (Figure 2). There are many varieties in construction and design practices that affect the placement of perforations, use of geotextiles, and use of internal gravel or rocks. Dry wells can be used in a variety of situations, but have unique advantages in areas with shallow clay or hardpan soils because they facilitate the movement of stormwater runoff below these types of constricting layers to facilitate infiltration. Multiple dry wells can be installed to create treatment trains for large drainage areas.

Typically, runoff is initially directed to a pretreatment facility—such as a bioretention planter, bioswale, proprietary device, or sedimentation chamber (sometimes with screens or hydrophobic sponges or pillows)—to remove sediment and other pollutants that could clog the well or subsurface soils, or pose risks to groundwater. Pretreatment can also accommodate spill response. After pretreatment, a conveyance pipe directs treated runoff into the system’s primary chamber, the dry well. The dry well may be constructed of concrete or other material. The lower section includes a pervious shaft which may be an open shaft with or within aggregate backfill or it may be comprised of perforations within the casing material. Before reaching groundwater, it is beneficial for runoff to pass through layers of silt or clay to help sequester contaminants before they reach groundwater (OWP et al 2018).

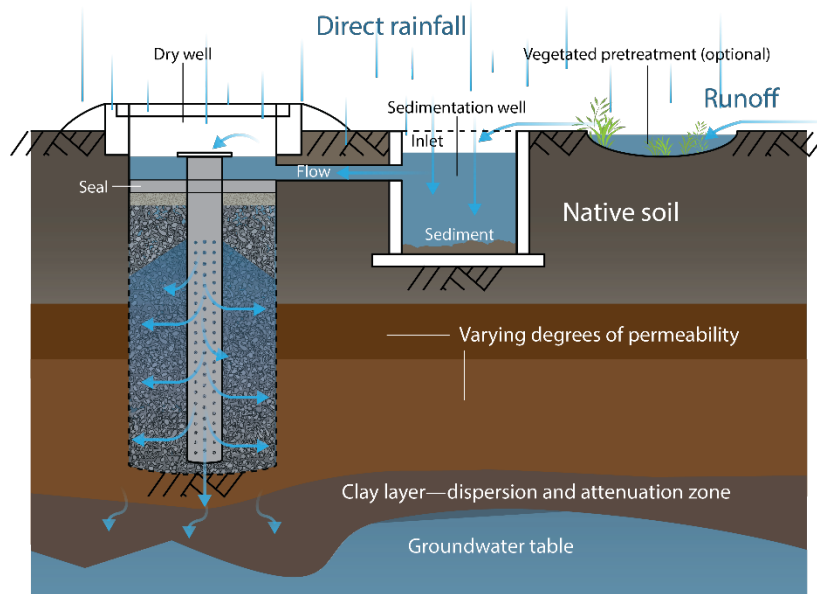

Figure 2. Basic schematic of a dry well

# Dry Well Factsheet

## 1.1 Variations and Alternative Names

- Underground injection control (UIC)

## 2.0 ADVANTAGES & LIMITATIONS

### 2.1 Advantages

- ✓ Well suited for areas where near-surface infiltration is restricted
- ✓ Minimal area requirements
- ✓ Can be used for groundwater recharge
- ✓ Reduces runoff flow rates and volumes
- ✓ Can be relatively easy to maintain

### 2.2 Limitations

- ✗ Not yet efficient at treating some water soluble contaminants and non-aqueous phase liquids that may be present in stormwater
- ✗ Not suitable for areas with steep slopes, a water table that is near the ground surface, or soil or groundwater that has been contaminated
- ✗ Unclear local regulations in some areas

## 3.0 SITING

Dry wells should not be installed too close to drinking water wells to minimize the risk of contamination or in areas where soil or groundwater has been contaminated to avoid flushing contamination into groundwater. They should also not be installed in or near sites where contamination by dissolved pollutants is likely (e.g., auto repair shops).

The soil composition should be inspected prior to installation to ensure that the dry well is well past any impermeable layers or layers in which the water will not infiltrate adequately.

Dry wells should be set back from buildings and other foundations and should not be installed in areas with steep slopes.

All dry well locations should be registered with USEPA.

## 4.0 DESIGN CONSIDERATIONS

When designing a dry well, the following parameters should be considered:

- Contributing drainage area
- Depth
- Volume
- Sedimentation chamber/well
- Pretreatment (may be necessary in some areas)

## 5.0 CONSTRUCTION CONSIDERATIONS

- Erosion control around the hole to prevent contamination and clogging during installation
- Watch for any unexpected fluid, colors, or odors coming from the drill site to avoid installing the dry well in an unknown contaminated area

## 6.0 MAINTENANCE

- Inspections and cleaning of sedimentation chamber to prevent buildup and/or clogging
- Inspections of dry well for clogged filter screens or other issues that may arise
- Street sweeping for dry wells that are set into a roadway to prevent excess loading of sediment and debris

# Dry Well Factsheet

## 7.0 REFERENCES

Office of Water Programs at California State University, Sacramento; Booth D.; Ellison-Lloyd D.; Washburn B.; Werder C. (OWP et al. 2018). *The American River Basin Stormwater Resource Plan, Appendix L - Design Guidance for Drywell Implementation in the ARB Region*. 2018.



# Green Roof Factsheet

## 1.0 GENERAL DESCRIPTION



Figure 1. Green roof (Center for Neighborhood Technology)

Potential Treatment Mechanisms								
I	ET	FA	B	RH	S	F	P	T
	✓	✓	✓		✓		✓	
Legend: I = Infiltration ET = Evapotranspiration FA = Filtration and/or Adsorption B = Biochemical Transformation RH = Rainfall and Runoff Harvest S = Sedimentation F = Flootation P = Plant Uptake T = Trash Capture								

Green roofs are layered stormwater management systems with a well-insulated and structurally sound roof for the first layer. On top of the roof is a waterproof layer and root barrier. Next is a drainage layer made of varying materials, such as a drainage mat or rock aggregate, to convey excess water off of the roof. Above this layer is a filter layer, which can also be made of varying materials (e.g., filter fleece), that assists in filtering out pollutants and some sediment. The top and final layers are the growing medium and plants that reduce runoff by storing and using the incidental stormwater. A schematic showing these layers is given in Figure 2.

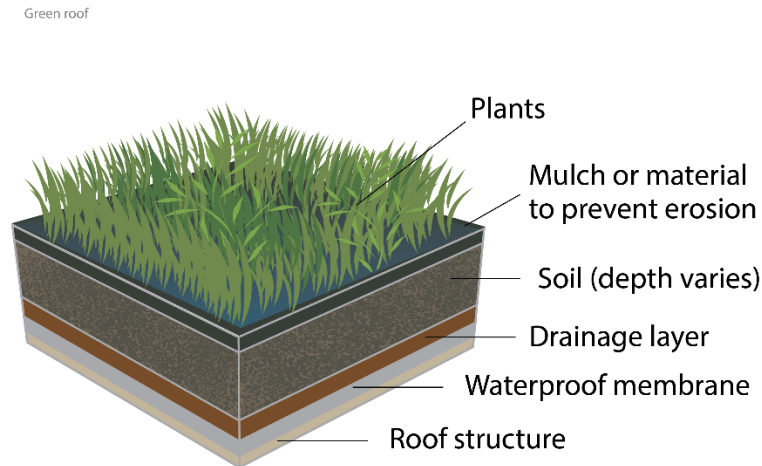

Figure 2. Schematic of basic green roof

### 1.1 Variations and Alternative Names

- Rooftop garden
- Eco-roof

## 2.0 ADVANTAGES & LIMITATIONS

### 2.1 Advantages

- ✓ Does not need any additional land
- ✓ Decreases runoff temperature (SSWP 2018)
- ✓ Can provide usable green space as well as wildlife habitat

### 2.2 Limitations

- ✗ Requires specific structural support
- ✗ Requires irrigation which can lead to structural issues if the roof is not properly protected
- ✗ Not suitable for wooden structures

# Green Roof Factsheet

## 3.0 SITING

Due to the moisture and load, installing green roofs on wooden structures may be infeasible.

## 4.0 DESIGN CONSIDERATIONS

When designing a green roof, the following parameters should be considered:

- Roof structure materials and design
- Building load capacity, including seismic loads during saturated conditions
- Vegetation
  - planting material and water holding capacity
  - mulch
- Drawdown time
- Roof slope
- Access
- Irrigation
- Lining
- Outlet drainage
- Overflow drainage

## 5.0 CONSTRUCTION CONSIDERATIONS

- Highly specialized construction may require a specialist to oversee the construction process
- Protection of vegetation during establishment from
  - construction damage
  - public access
  - heat exposure
- Covering the area with mulch or another erosion control method before vegetation is added can help prevent erosion, especially during vegetation establishment.

## 6.0 MAINTENANCE

- Plant management
  - mowing of grass
  - pruning of non-grasses
  - weed removal
  - identification and promotion of desired species (may require special training)
- Inspections for standing water after major rainfall events to prevent vector breeding

## 7.0 REFERENCES

Sacramento Stormwater Quality Partnership (SSQP 2018). *Stormwater Quality Design Manual*. July 2018.

# Hydrodynamic Separator Factsheet

## 1.0 GENERAL DESCRIPTION



Figure 1. Hydrodynamic separator (EPA)

Potential Treatment Mechanisms								
I	ET	FA	B	RH	S	F	P	T
					✓	✓		
Legend: I = Infiltration			S = Sedimentation					
ET = Evapotranspiration			F = Floatation					
FA = Filtration and/or Adsorption			P = Plant Uptake					
B = Biochemical Transformation			T = Trash Capture					
RH = Rainfall and Runoff Harvest								

Hydrodynamic separators are underground systems located in wet vaults designed to remove large sediment by gravity settling. Some use screens to remove trash. Screens or baffles can also be designed to enhance settling. A schematic of one type of hydrodynamic separator is shown in Figure 2.

Hydrodynamic separator

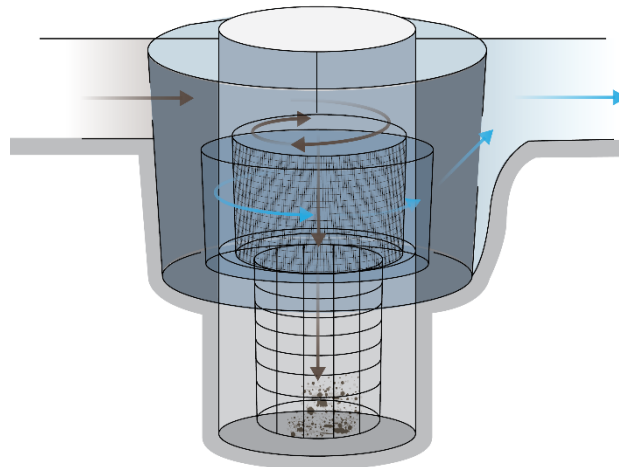

Figure 2. Schematic of a basic hydrodynamic separator

### 1.1 Variations and Alternative Names

- Vortex separators
- Swirl separators
- Gravity separators
- Flow-through separators

## 2.0 ADVANTAGES & LIMITATIONS

### 2.1 Advantages

- ✓ Located underground
- ✓ May be used for spill containment
- ✓ Works for a large range of flow velocities
- ✓ Can be inexpensive to install

# Hydrodynamic Separator Factsheet

## 2.2 Limitations

- ✘ Due to permanent pools or stagnant water, regular treatment for mosquito control may be necessary
- ✘ Moderate pollutant removal
- ✘ May not be able to remove fine sediments
- ✘ Does not remove dissolved pollutants (CASQA 2003, 2018)
- ✘ Some models store vegetation debris in standing water, which can increase nutrient and sediment loading by decomposition

## 3.0 SITING

Because wet vaults are sealed underground systems, underground utilities must first be located to avoid utility conflicts.

## 4.0 DESIGN CONSIDERATIONS

When designing a hydrodynamic separator, the following parameters should be considered:

- Contributing drainage area
- Design volume
- Maintenance access
- Flow rate
- Hydraulic residence time

## 5.0 CONSTRUCTION CONSIDERATIONS

The usual construction considerations apply.

## 6.0 MAINTENANCE

- Mosquito breeding abatement (if standing water)
- Removal of trash and debris
- Sediment control

## 7.0 REFERENCES

California Stormwater Quality Association (CASQA 2003). *Stormwater Best Management Practice Handbook: New Development and Redevelopment*. January 2003.

California Stormwater Quality Association (CASQA 2017). *Draft Stormwater Best Management Practice Handbook: New Development and Redevelopment*. April 2017.

# Infiltration Basin Factsheet

## 1.0 GENERAL DESCRIPTION



Figure 1. Infiltration basin (UC Santa Cruz)

Potential Treatment Mechanisms								
I	ET	FA	B	RH	S	F	P	T
✓	✓	✓			✓			✓
Legend: I = Infiltration			S = Sedimentation					
ET = Evapotranspiration			F = Floatation					
FA = Filtration and/or Adsorption			P = Plant Uptake					
B = Biochemical Transformation			T = Trash Capture					
RH = Rainfall and Runoff Harvest								

Infiltration basins are shallow basins designed to infiltrate stormwater runoff into the underlying soil. These basins are typically sized to infiltrate collected water within 48 hours. The maximum drain time (via infiltration) is specified to prevent mosquito breeding and to restore capacity for subsequent storm events. A minimum drain time is sometimes specified to encourage quiescent conditions for particle sedimentation. A riser or overflow weir is typically provided to route flood flows. A schematic of a basic infiltration basin is shown in Figure 2.

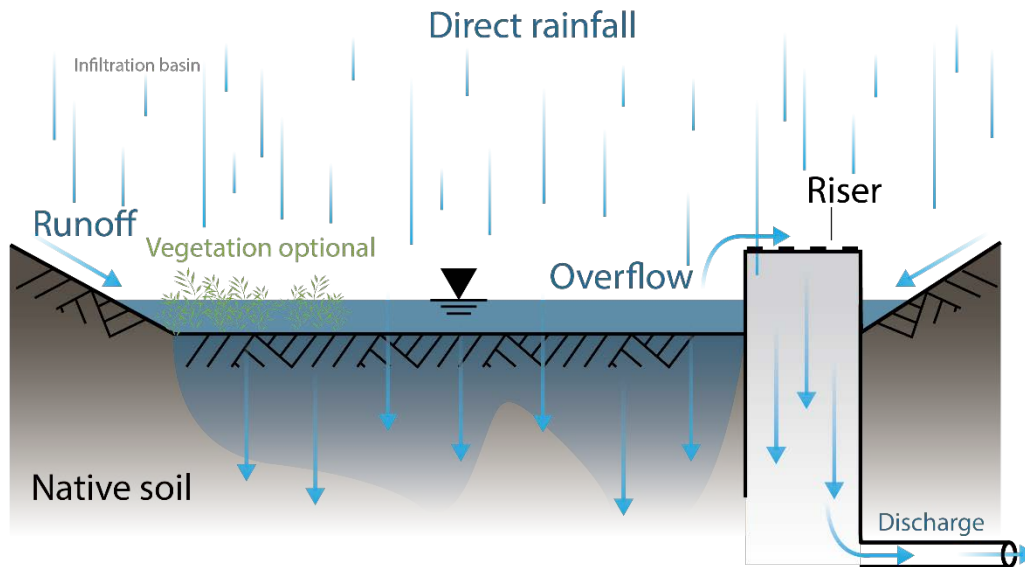

Figure 2. Schematic of a basic infiltration basin (not to scale)

### 1.1 Variations and Alternative Names

- Retention basins
- Spreading grounds

## 2.0 ADVANTAGES & LIMITATIONS

### 2.1 Advantages

- ✓ Provides substantial reduction of pollutant load discharged to surface waters
- ✓ Infiltration basins can be integrated into an aesthetically appealing landscape design, though access restriction may be required for public safety

### 2.2 Limitations

- ✗ Not suitable for:
  - areas where the water table is near the ground surface

## Infiltration Basin Factsheet

- areas where the groundwater is already contaminated
- areas with low infiltration rates (slowly permeable soils)
- industrial sites where spills of dissolved pollutants are likely to occur and escape pretreatment infrastructure
- ✖ If the basin ever becomes clogged with sediment, heavy equipment may be required to restore infiltration rates to an acceptable level

### 3.0 SITING

The site should not have the potential for spills nor can the groundwater level be too high or have previous contamination. The site also should not have soils throughout the vadose zone that infiltrate too quickly (i.e. have little pollutant removal capacity). However, if the infiltration rate is too fast, pretreatment (e.g., soil amendments or filter layers) may be used to protect groundwater.

Infiltration basins must be set back from buildings, slopes, highway pavement, and bridges that are not designed for sustained soil saturation.

### 4.0 DESIGN CONSIDERATIONS

When designing an infiltration basin, the following parameters should be considered:

- Contributing drainage area
- Soil type/infiltration rate
- Location in relation to foundations/pavement
- Base flow
- Drawdown time
- Groundwater depth
- Freeboard
- Setbacks
- Inlet and overflow spillway (if existing) erosion control
- Side slope
- Access ramp
- Maintenance drain (optional)
- Vegetation type
- Seepage collar (to prevent piping/internal erosion on bermed systems)

### 5.0 CONSTRUCTION CONSIDERATIONS

- Stabilize the drainage area before establishment of final grade
  - If stabilization is not possible, flows should be diverted from the basin
- Completely remove excavated material from the site to avoid any soil washing back into the basin
- Prohibit any non-tracked heavy equipment from driving over the infiltrating surface to avoid excess compaction

### 6.0 MAINTENANCE

- Measure the drawdown time
- Check for sediment & particulate buildup
- Plant maintenance
  - Removal of woody vegetation
  - Vegetation managed to aesthetic standards

### 7.0 REFERENCES

California Stormwater Quality Association (CASQA 2003). *Stormwater Best Management Practice Handbook: New Development and Redevelopment*. January 2003.

## **Infiltration Basin Factsheet**

California Stormwater Quality Association (CASQA 2017). *Draft Stormwater Best Management Practice Handbook: New Development and Redevelopment*. April 2017.

Sacramento Stormwater Quality Partnership (SSQP 2018). *Stormwater Quality Design Manual*. July 2018.

# Infiltration Gallery Factsheet

## 1.0 GENERAL DESCRIPTION



Potential Treatment Mechanisms								
I	ET	FA	B	RH	S	F	P	T
✓				✓	✓			
Legend: I = Infiltration			S = Sedimentation					
ET = Evapotranspiration			F = Floatation					
FA = Filtration and/or Adsorption			P = Plant Uptake					
B = Biochemical Transformation			T = Trash Capture					
RH = Rainfall and Runoff Harvest								

**Figure 1. Infiltration gallery (Brentwood Industries)**

Infiltration galleries are underground void spaces consisting of one or more perforated containers such as large pipes, vaults, or archways. Galleries are engineered to support cover and aboveground land use. A schematic of a basic infiltration gallery is shown in Figure 2.

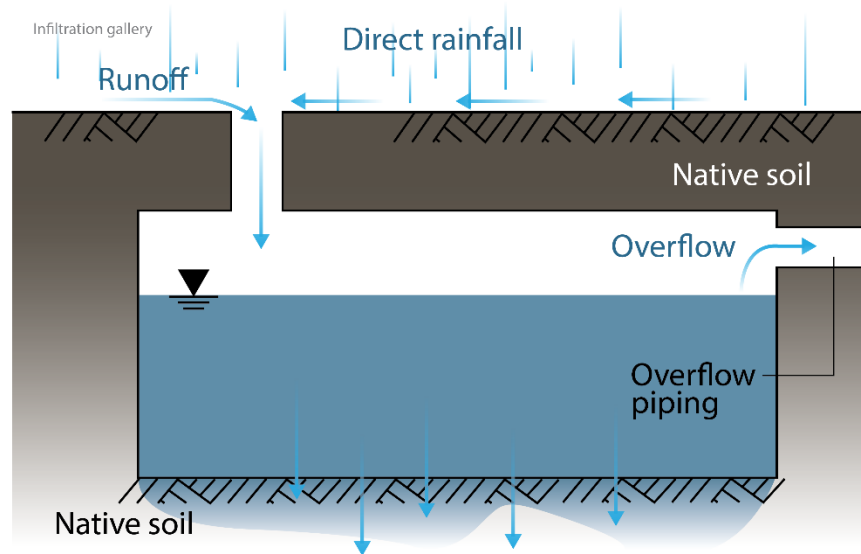

**Figure 2. Basic schematic of an infiltration gallery**

## 2.0 ADVANTAGES & LIMITATIONS

### 2.1 Advantages

- ✓ Recharge groundwater
- ✓ Located underground
- ✓ Provides substantial reduction of pollutant load discharged to surface water

### 2.2 Limitations

- ✗ Not suitable for:
  - areas where the water table is near the ground surface
  - areas where the groundwater is already contaminated
  - areas with low infiltration rates (slowly permeable soils)
  - industrial sites where spills of dissolved pollutants are likely to occur and escape pretreatment infrastructure
- ✗ If the basin ever becomes clogged with sediment, heavy equipment may be required to restore infiltration rates to an acceptable level



# Infiltration Gallery Factsheet

## 3.0 SITING

The site should not have the potential for spills nor can the groundwater level be too high or have previous contamination. The site also should not have soils throughout the vadose zone that infiltrate too quickly (i.e. have little pollutant removal capacity). However, if the infiltration rate is too fast, pretreatment (e.g., soil amendments or filter layers) may be used to protect groundwater.

Infiltration basins must be set back from buildings, slopes, highway pavement, and bridges that are not designed for sustained soil saturation.

## 4.0 DESIGN CONSIDERATIONS

When designing an infiltration gallery, the following parameters should be considered:

- Minimum cover
- Contributing drainage area (CDA)
- Volume
- Drawdown time
- Dead and live loading
- Maintenance access
- Setbacks

## 5.0 CONSTRUCTION CONSIDERATIONS

- Stabilization of the CDA or diversion of flows during construction to prevent sediment loading

## 6.0 MAINTENANCE

- Inspections for trash and debris removal

# Infiltration Trench Factsheet

## 1.0 GENERAL DESCRIPTION



Potential Treatment Mechanisms								
I	ET	FA	B	RH	S	F	P	T
✓		✓		✓				✓
Legend: I = Infiltration ET = Evapotranspiration FA = Filtration and/or Adsorption B = Biochemical Transformation RH = Rainfall and Runoff Harvest S = Sedimentation F = Floatation P = Plant Uptake T = Trash Capture								

Figure 1. Infiltration trench (Richland Soil and Water Conservation)

Infiltration trenches are long, narrow trenches typically filled with sand, rocks, and gravel into which stormwater runoff collects in pore spaces and infiltrates into surrounding soils. Their primary function is to provide infiltration within a smaller, more flexible footprint than infiltration basins. The depth or bottom surface area must be sufficiently large enough to allow the trench to drain within 72 hours. A schematic of a basic infiltration trench is shown in Figure 2.

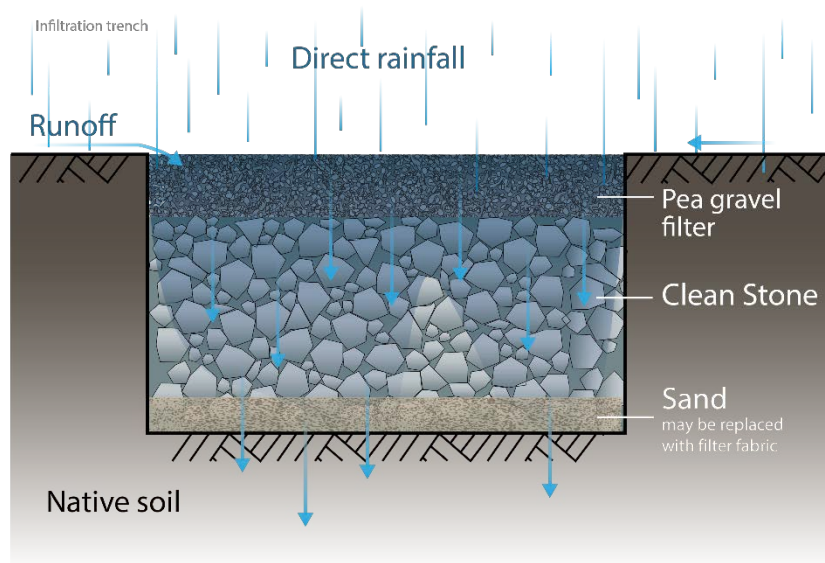

Figure 2. Basic schematic of an infiltration trench

### 1.1 Variations and Alternative Names

- Rock swales

## 2.0 ADVANTAGES & LIMITATIONS

### 2.1 Advantages

- ✓ Infiltration trenches can be integrated into an aesthetically appealing landscape design
- ✓ Provides substantial reduction of pollutant load discharged to surface waters

### 2.2 Limitations

- ✗ May not be suitable for:
  - areas with low infiltration rates (slowly permeable soils)
  - areas with steep slopes

## Infiltration Trench Factsheet

- areas where the water table is near the ground surface and/or there is existing groundwater contamination
- industrial sites where spills may occur
- ✖ If the trench becomes clogged with sediment, reconstruction will likely be required to restore infiltration rates to an acceptable level

### 3.0 SITING

The site should not have the potential for spills nor can the groundwater level be too high or have previous contamination. The site also should not have soils throughout the vadose zone that infiltrate too quickly (i.e. have little pollutant removal capacity). However, if the infiltration rate is too fast, pretreatment (e.g., soil amendments or filter layers) may be used to protect groundwater.

Infiltration trenches must be set back from buildings, slopes, highway pavement, and bridges that are not designed for sustained soil saturation, as well as septic fields and water supply wells.

### 4.0 DESIGN CONSIDERATIONS

When designing an infiltration trench, the following parameters should be considered:

- Contributing drainage area (CDA)
- Groundwater depth
- Soil type/infiltration rate
- Drawdown time
- Trench depth
- Trench lining
- Trench media
- Observation well size
- Underdrain (optional)
- Setbacks

### 5.0 CONSTRUCTION CONSIDERATIONS

- Stabilization of the CDA or diversion of flows during construction to prevent sediment loading

### 6.0 MAINTENANCE

- Inspections for ponding that is not draining adequately
  - If trench becomes clogged, the rock will need to be removed and replaced

### 7.0 REFERENCES

California Stormwater Quality Association (CASQA 2003). *Stormwater Best Management Practice Handbook: New Development and Redevelopment*. January 2003.

California Stormwater Quality Association (CASQA 2017). *Draft Stormwater Best Management Practice Handbook: New Development and Redevelopment*. April 2017.

Sacramento Stormwater Quality Partnership (SSQP 2018). *Stormwater Quality Design Manual*. July 2018.

# Media Filters Factsheet

## 1.0 GENERAL DESCRIPTION



Figure 1. Media filter (City of Portland OR)

Potential Treatment Mechanisms									
S	I	ET	FA	B	RH	S	F	P	T
			✓						✓
Legend: I = Infiltration					S = Sedimentation				
ET = Evapotranspiration					F = Flootation				
FA = Filtration and/or Adsorption					P = Plant Uptake				
B = Biochemical Transformation					T = Trash Capture				
RH = Rainfall and Runoff Harvest									

Media filters are usually in open bed or vault arrangements. Open bed filters generally have a settling area followed by the filter bed. The filter area typically has one or multiple perforated underdrains. Media filters can be made with one or multiple filtering media including, but not limited to, some mixture of two or more of the following: limestone, activated alumina, perlite, zeolites, sand, peat, biochar, and granular activated carbon. A schematic of a basic open bed, surface media filter is shown in Figure 2 and a schematic of a subsurface media filter is shown in Figure 3.

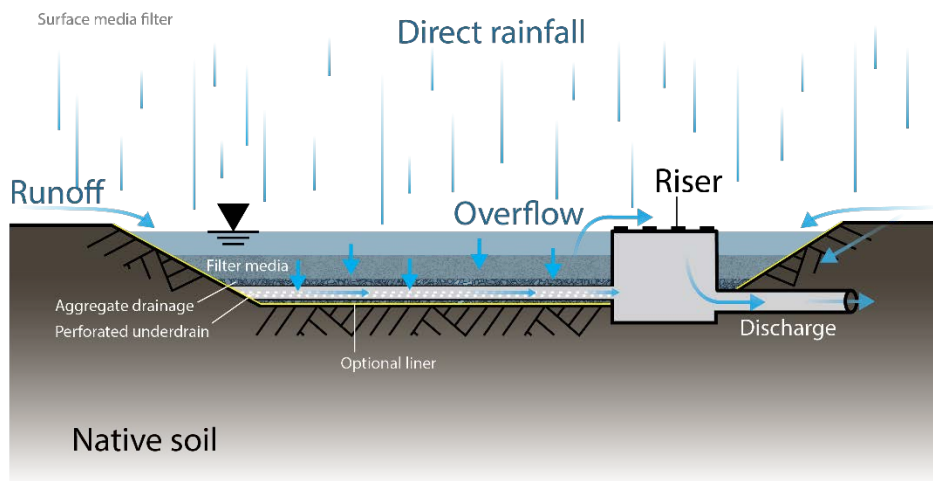

Figure 2. General schematic of a surface media filter

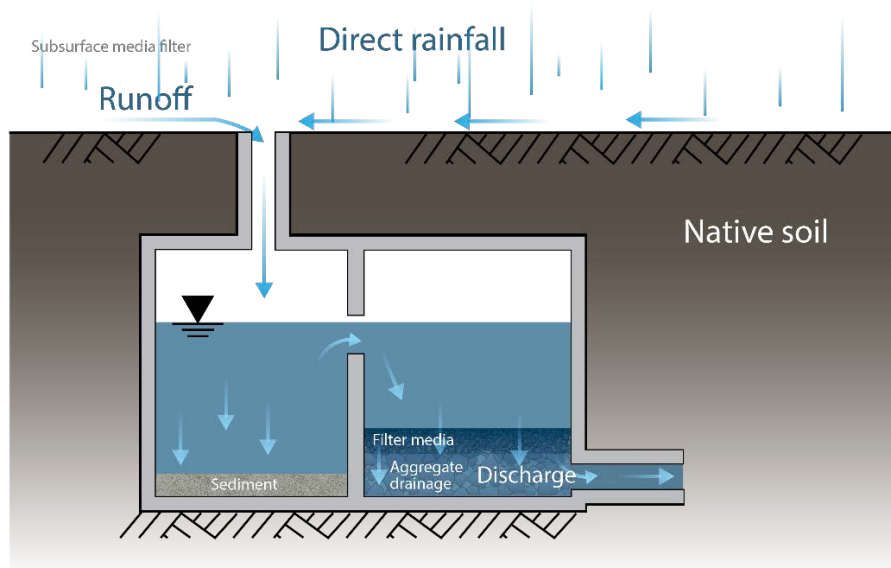

Figure 3. Schematic of a basic subsurface media filter

# Media Filters Factsheet

## 1.1 Variations and Alternative Names

- Sand filters
- Austin sand filters
- Delaware sand filters
- DC sand filters
- Canister filters
- Alternative media filters

## 2.0 ADVANTAGES & LIMITATIONS

### 2.1 Advantages

- ✓ Typically provide high solids removal
- ✓ Can be used where space is limited
- ✓ Can be used where the water table is high
- ✓ Does not require vegetation management/irrigation
- ✓ Can be augmented with absorptive media to increase pollutant removal

### 2.2 Limitations

- ✗ If the design includes a constant pool of water (e.g., Delaware sand filter), vector issues may arise.

## 3.0 SITING

Media filters require maintenance access and an elevation change from drainage surface to storm drainage systems.

## 4.0 DESIGN CONSIDERATIONS

When designing a media filter, the following parameters should be considered:

- Contributing drainage area (CDA)
- Filter media
- Filter bed size
- Hydraulic residence time (for sorptive media)
- Unlined underdrain (optional, to allow infiltration)

## 5.0 CONSTRUCTION CONSIDERATIONS

- Stabilization of the CDA or diversion of flows during construction to prevent sediment loading

## 6.0 MAINTENANCE

- Inspections for adequate drainage to avoid vector breeding
- Removal of sediment and debris

## 7.0 REFERENCES

California Stormwater Quality Association (CASQA 2003). *Stormwater Best Management Practice Handbook: New Development and Redevelopment*. January 2003.

California Stormwater Quality Association (CASQA 2017). *Stormwater Best Management Practice Handbook: New Development and Redevelopment*. April 2017.

Sacramento Stormwater Quality Partnership (SSQP 2018). *Stormwater Quality Design Manual*. July 2018.

County of Placer, City of Roseville, City of Auburn, City of Lincoln, and Town of Loomis (County of Placer et al. 2016). *West Placer Storm Water Quality Design Manual*. April 2016.

# Oil-Water Separator Factsheet

## 1.0 GENERAL DESCRIPTION

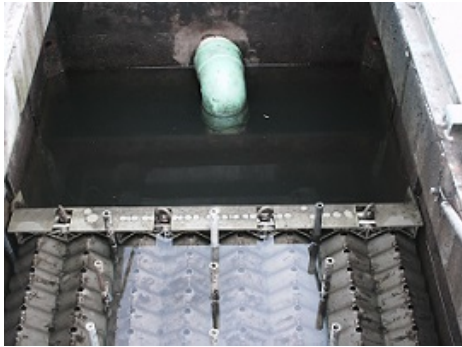

Potential Treatment Mechanisms								
I	ET	FA	B	RH	S	F	P	T
					✓	✓		
Legend: I = Infiltration			S = Sedimentation					
ET = Evapotranspiration			F = Floatation					
FA = Filtration and/or Adsorption			P = Plant Uptake					
B = Biochemical Transformation			T = Trash Capture					
RH = Rainfall and Runoff Harvest								

Figure 1. Oil-water separator (Stormwater Partners SW Washington)

Sediment-oil-water separators are typically made up of three chambers. Sediment settles out in the first chamber while the rest flows through an outlet toward the middle or top of the separating wall. The second chamber allows the free oils (oils that are not emulsified or dissolved) to separate to the top of the water and a pipe at the bottom of the chamber conveys the now separated water out. A schematic of a basic sediment-oil-water separator is shown in Figure 2.

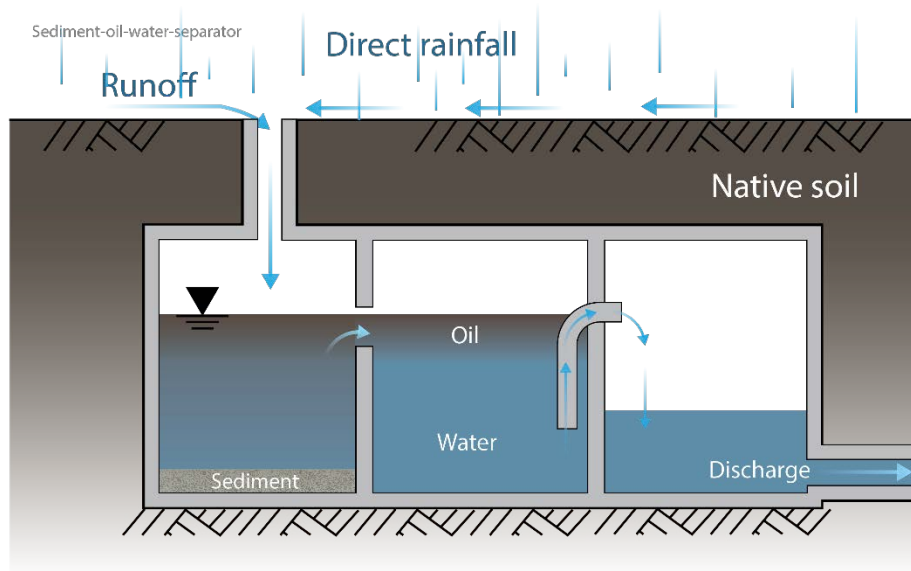

Figure 2. Schematic of an basic oil-water separator

### 1.1 Variations and Alternative Names

- Water quality inlets
- Trapping catch basins
- Oil-grit separators
- Flow-through separators

## 2.0 ADVANTAGES & LIMITATIONS

### 2.1 Advantages

- ✓ Suitable for industrial areas and/or areas where spills may occur

### 2.2 Limitations

- ✗ Moderate pollutant removal due to low hydraulic residence time
- ✗ Due to permanent pools or long standing water, regular treatment for mosquito control may be necessary

# Oil-Water Separator Factsheet

## 3.0 SITING

Oil-water separators are well suited for industrial sites or areas where spills may occur.

## 4.0 DESIGN CONSIDERATIONS

When designing a sediment-oil-water separator, the following parameters should be considered:

- Design volume or rate
- Maintenance access

## 5.0 CONSTRUCTION CONSIDERATIONS

There are no unusual considerations for construction.

## 6.0 MAINTENANCE

- Mosquito breeding abatement (if standing water)
- Removal of trash and debris
- Sediment control

## 7.0 REFERENCES

California Stormwater Quality Association (CASQA 2003). *Stormwater Best Management Practice Handbook: New Development and Redevelopment*. January 2003.

California Stormwater Quality Association (CASQA 2017). *Draft Stormwater Best Management Practice Handbook: New Development and Redevelopment*. April 2017.



# Porous/Pervious Pavement Factsheet

## 1.0 GENERAL DESCRIPTION



Potential Treatment Mechanisms								
I	ET	FA	B	RH	S	F	P	T
✓	✓	✓						
Legend: I = Infiltration					S = Sedimentation			
ET = Evapotranspiration					F = Flootation			
FA = Filtration and/or Adsorption					P = Plant Uptake			
B = Biochemical Transformation					T = Trash Capture			
RH = Rainfall and Runoff Harvest								

Figure 1. Porous pavement (EPA)

Porous or pervious pavement refers to trafficked or parking surfaces in which the top layer is comprised either entirely of a permeable material (e.g., gravel or porous concrete) or impermeable material broken up with permeable seams, spaces, or joints (e.g., pavers). Underneath the top layer is a layer (or layers) of porous material that holds water while it infiltrates into surrounding soils. An example schematic of a porous pavement is shown in Figure 2.

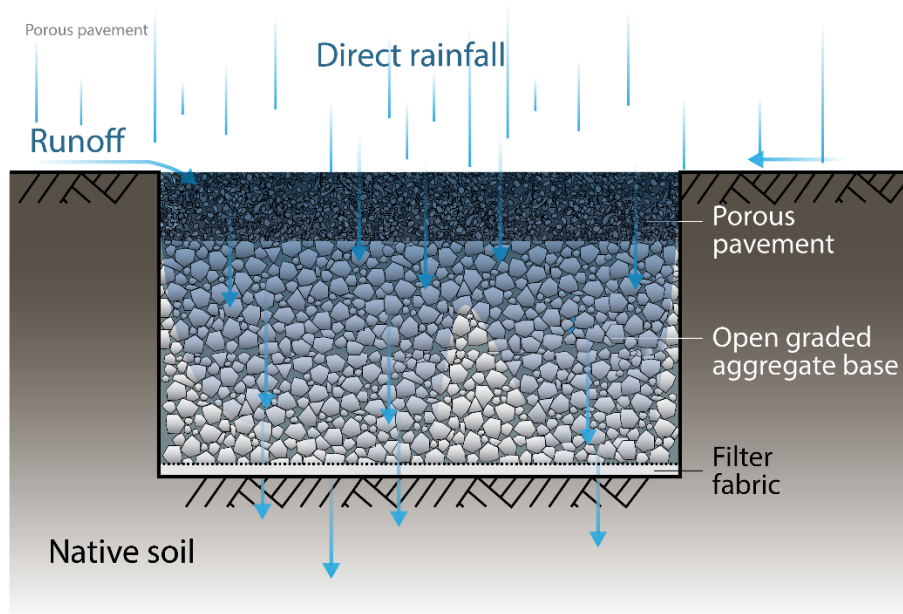

Figure 2. Basic schematic of porous pavement

### 1.1 Variations and Alternative Names

- Permeable pavers
- Porous pavers
- Porous/permeable asphalt
- Porous/permeable concrete

## 2.0 ADVANTAGES & LIMITATIONS

### 2.1 Advantages

- ✓ Does not require any additional land/space and can be a more aesthetically appealing option than the pavement it replaces
- ✓ Can enhance driving safety by reducing the amount of water pooling on the pavement surface



# Porous/Pervious Pavement Factsheet

## 2.2 Limitations

- ✘ If not properly installed or regularly maintained/cleaned, the pavement/pavers can become clogged with sediment and debris
- ✘ Not suitable for areas with:
  - heavy traffic
  - high speeds
  - unstable slopes
  - possibility of spills
  - heavy vegetation debris

## 3.0 SITING

The area should be flat or only have a slight slope and be set back from buildings.

The site should not have heavy traffic, heavy debris loading, or the possibility of spills (e.g., industrial sites).

## 4.0 DESIGN CONSIDERATIONS

When planning to install an area of pervious pavement, the following design parameters should be considered:

- Contributing drainage area
- Potential traffic load, speed, and volume
- Location/setback from buildings
- Existing soil type
- Existing slope
- Pavement type
- Underdrain (optional)

## 5.0 CONSTRUCTION CONSIDERATIONS

- Care must be taken to lay the storage layer as level as possible and terrace or berm it to keep water from flowing out through the top of downstream pavement section
- If pavers are used, sufficient space must be left so that the joints do not clog easily

## 6.0 MAINTENANCE

- No storage of equipment on the pavement.
- Many types of porous pavement require cleaning in some way to avoid becoming clogged with sediment and debris

## 7.0 REFERENCES

California Stormwater Quality Association (CASQA 2003). *Stormwater Best Management Practice Handbook: New Development and Redevelopment*. January 2003.

California Stormwater Quality Association (CASQA 2017). *Draft Stormwater Best Management Practice Handbook: New Development and Redevelopment*. April 2017.

County of Placer, City of Roseville, City of Auburn, City of Lincoln, and Town of Loomis (County of Placer et al. 2016). *West Placer Storm Water Quality Design Manual*. April 2016.

Sacramento Stormwater Quality Partnership (SSQP 2018). *Stormwater Quality Design Manual*. July 2018.

# Underground Storage Vault Factsheet

## 1.0 GENERAL DESCRIPTION



Potential Treatment Mechanisms								
I	ET	FA	B	RH	S	F	P	T
				✓	✓			
Legend: I = Infiltration			S = Sedimentation					
ET = Evapotranspiration			F = Floatation					
FA = Filtration and/or Adsorption			P = Plant Uptake					
B = Biochemical Transformation			T = Trash Capture					
RH = Rainfall and Runoff Harvest								

Figure 1. Underground Storage Vault (Colorado State University, Fort Collins)

Underground storage vaults are engineered, subsurface void spaces consisting of one or more containers, such as large pipes or concrete vaults, with a permanent pool of water. Stormwater enters a vault through a surface inlet and is temporarily stored, allowing sediments and particles to settle. If the water level reaches a certain height, it is discharged as overflow. A schematic of an underground storage vault is shown in Figure 2.

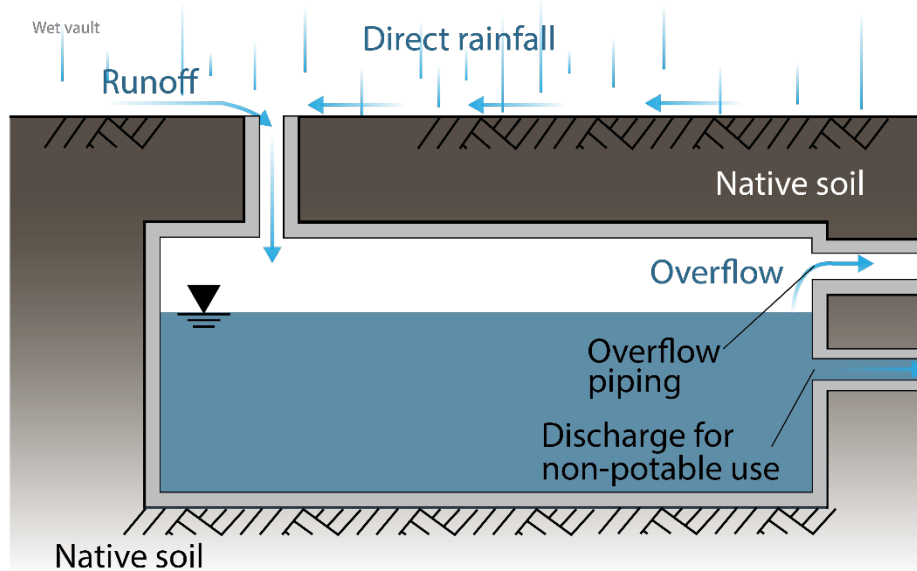

Figure 2. Schematic of a basic underground storage vault

### 1.1 Variations and Alternative Names

- Wet vault
- Underground cistern

## 2.0 ADVANTAGES & LIMITATIONS

### 2.1 Advantages

- ✓ Located underground
- ✓ Can be used where the water table is high

### 2.2 Limitations

- ✗ Due to the designed permanent pool of water or stagnant water, vector breeding can become an issue

# Underground Storage Vault Factsheet

## 3.0 SITING

Because underground storage vaults are sealed underground systems, subsurface utilities must first be located to avoid utility conflicts.

## 4.0 DESIGN CONSIDERATIONS

When designing an underground storage vault, the following parameters should be considered:

- Contributing drainage area
- Vault volume
- Dead and live loading capacity
- Maintenance drain
- Mosquito access prevention

## 5.0 CONSTRUCTION CONSIDERATIONS

Each manufacturer will have construction guidelines for each specific vault (CASQA 2003, 2018).

## 6.0 MAINTENANCE

- Inspections for trash and debris removal

## 7.0 REFERENCES

California Stormwater Quality Association (CASQA 2003). *Stormwater Best Management Practice Handbook: New Development and Redevelopment*. January 2003.

California Stormwater Quality Association (CASQA 2017). *Draft Stormwater Best Management Practice Handbook: New Development and Redevelopment*. April 2017.

# Vegetated Buffer Strip Factsheet

## 1.0 GENERAL DESCRIPTION



**Figure 1. Vegetated Buffer Strip (Caltrans)**

Potential Treatment Mechanisms								
I	ET	FA	B	RH	S	F	P	T
✓	✓	✓	✓		✓		✓	
Legend: I = Infiltration				S = Sedimentation				
ET = Evapotranspiration				F = Floatation				
FA = Filtration and/or Adsorption				P = Plant Uptake				
B = Biochemical Transformation				T = Trash Capture				
RH = Rainfall and Runoff Harvest								

Vegetated buffer strips are gently sloped, relatively flat vegetated surfaces over which runoff is treated as sheet flow. In conventional vegetated buffer strips, the plants slow the flow, which enhances sedimentation, filtration, and infiltration. In some cases, the soil underlying the strip is amended with compost or replaced with a permeable soil/compost mix. This allows more runoff to infiltrate into the ground, thus reducing runoff volumes. A schematic of a basic vegetated buffer strip is shown in Figure 2.

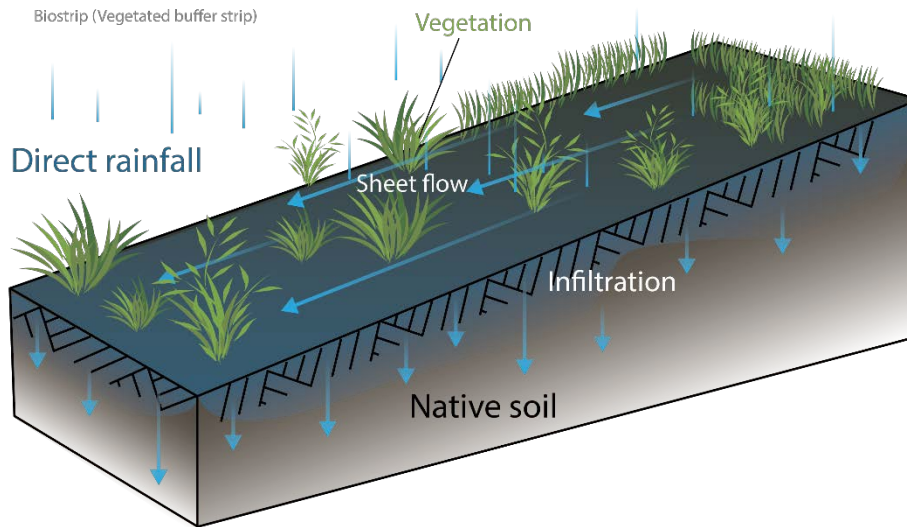

**Figure 2. Schematic of a basic vegetated buffer strip**

### 1.1 Variations and Alternative Names

- Strips
- Buffers
- Buffer strips
- Biostrips

## 2.0 ADVANTAGES & LIMITATIONS

### 2.1 Advantages

- ✓ Usually vegetated with grasses or other low maintenance plants, these strips often require little maintenance.
- ✓ When done well, strips can be both inexpensive and add aesthetic appeal.
- ✓ If sized correctly, strips provide adequate drainage and removal of particulate pollutants.

# Vegetated Buffer Strip Factsheet

## 2.2 Limitations

- ✘ Prone to erosion and channelization if vegetative cover is not properly established.
- ✘ One strip is not suitable for large treatment areas or areas with concentrated runoff.

## 3.0 SITING

According to the California Stormwater Quality Association and the Sacramento Stormwater Quality Partnership, one strip is limited to treating only a few acres of contributing drainage area (CASQA 2003, SSQP 2018).

## 4.0 DESIGN CONSIDERATIONS

When designing a vegetated buffer strip, the following parameters should be considered:

- Contributing drainage area
- Hydraulic residence time
- Slope in flow direction (longitudinal slope)
- Flat perpendicular to flow direction (no lateral slope)
- Flow depth (less than plant height)
- Length and width of strip (for estimating infiltration)
- Vegetation type and height (cool season grasses can reduce dry season watering needs)

## 5.0 CONSTRUCTION CONSIDERATIONS

- Install during a time of year when it is likely that the vegetation will receive sufficient watering from rainfall to become established without irrigation
  - Irrigation should only be applied if incidental rainfall is insufficient for plant establishment
- Divert runoff until plants are established

## 6.0 MAINTENANCE

- Plant management
  - mowing grass
  - pruning non-grasses
  - removing woody vegetation
  - removing weeds (if desired for aesthetics)
- Inspections for erosion with additional inspections after major rainfall events
- Litter removal (for areas prone to litter)
- Inspections for standing water to prevent mosquitos and other vector breeding

## 7.0 REFERENCES

California Stormwater Quality Association (CASQA 2003). *Stormwater Best Management Practice Handbook: New Development and Redevelopment*. January 2003.

California Stormwater Quality Association (CASQA 2017). *Draft Stormwater Best Management Practice Handbook: New Development and Redevelopment*. April 2017.

County of Placer, City of Roseville, City of Auburn, City of Lincoln, and Town of Loomis (County of Placer et al. 2016). *West Placer Storm Water Quality Design Manual*. April 2016.

Sacramento Stormwater Quality Partnership (SSQP 2018). *Stormwater Quality Design Manual*. July 2018.

# Vegetated Swale Factsheet

## 1.0 GENERAL DESCRIPTION



Figure 1. Vegetated swale (SSQP 2018)

Potential Treatment Mechanisms								
I	ET	FA	B	RH	S	F	P	T
✓	✓	✓	✓		✓		✓	
Legend: I = Infiltration			S = Sedimentation					
ET = Evapotranspiration			F = Floatation					
FA = Filtration and/or Adsorption			P = Plant Uptake					
B = Biochemical Transformation			T = Trash Capture					
RH = Rainfall and Runoff Harvest								

Vegetated swales are gently sloped vegetated channels. Plants slow the flow, which enhances settling, filtration, and infiltration. In some cases, the soil underlying the swale is amended with compost or replaced with a permeable soil/compost mix. This allows more runoff to infiltrate into the ground, thus reducing runoff volumes. An example schematic of a vegetated swale is shown in Figure 2.

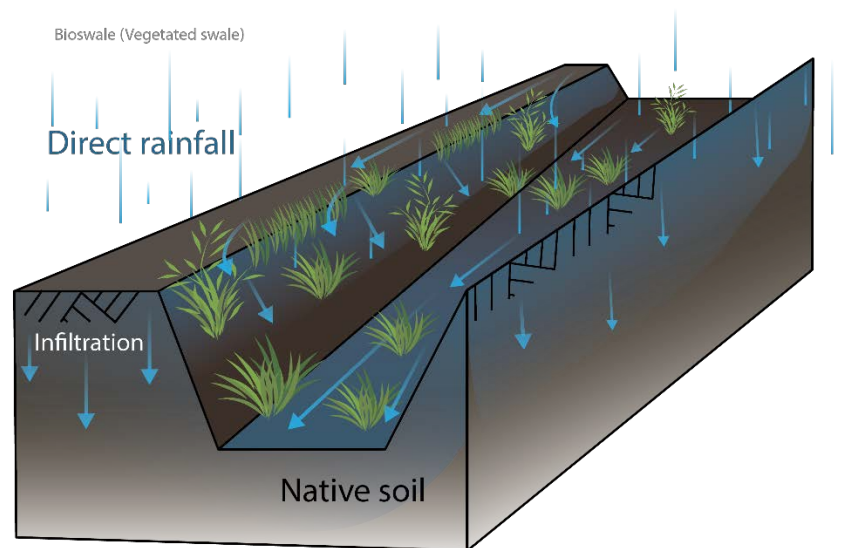

Figure 2. Schematic of an example vegetated swale

### 1.1 Variations and Alternative Names

- Swales
- Bioswales

## 2.0 ADVANTAGES & LIMITATIONS

### 2.1 Advantages

- ✓ Usually vegetated with grasses or other low maintenance plants, swales often require little maintenance.
- ✓ When done well, swales can both be inexpensive and add an aesthetic appeal.
- ✓ If sized correctly, provides adequate drainage and removal of particulate pollutants.
- ✓ Requires minimal elevation change



# Vegetated Swale Factsheet

## 2.2 Limitations

- ✘ Prone to erosion and channelization if vegetative cover is not properly maintained.
- ✘ One swale is not suitable for large treatment areas or areas with high velocity flows.

## 3.0 SITING

According to the California Stormwater Quality Association and the Sacramento Stormwater Quality Partnership, one vegetated swale is limited to treating up to 10 acres of contributing drainage area (CASQA 2003, SSQP 2018).

## 4.0 DESIGN CONSIDERATIONS

When designing a vegetated swale, the following parameters should be considered:

- Contributing drainage area
- Total inundated area (for estimating infiltration)
- Hydraulic residence time
- Bottom width
- Slope in flow direction (longitudinal slope)
- Side slopes
- Slope of invert perpendicular to flow
- Flow depth
- Vegetation type and height
- Underdrains
- Design volume (depth)
- Design rate (intensity)

## 5.0 CONSTRUCTION CONSIDERATIONS

- Install when vegetation will receive sufficient watering from rainfall to become established without irrigation. Only apply irrigation when incidental rainfall is insufficient for vegetation establishment.
- Divert runoff until plants are established

## 6.0 MAINTENANCE

- Plant management
  - mowing grass
  - pruning non-grasses
  - removing woody vegetation
  - removing weeds (if desired for aesthetics)
- Inspections for erosion
- Litter removal (for areas prone to litter)
- Inspections for standing water to prevent mosquitos and other vector breeding

## 7.0 REFERENCES

California Department of Transportation (Caltrans 2017). *Project Planning and Design Guide (PPDG)*. July 2017.

California Stormwater Quality Association (CASQA 2003). *Stormwater Best Management Practice Handbook: New Development and Redevelopment*. January 2003.

California Stormwater Quality Association (CASQA 2017). *Draft Stormwater Best Management Practice Handbook: New Development and Redevelopment*. April 2017.

County of Placer, City of Roseville, City of Auburn, City of Lincoln, and Town of Loomis (County of Placer et al. 2016). *West Placer Storm Water Quality Design Manual*. April 2016.

Sacramento Stormwater Quality Partnership (SSQP 2018). *Stormwater Quality Design Manual*. July 2018.

# Wet Pond Factsheet

## 1.0 GENERAL DESCRIPTION



Figure 1. Wet pond (MN Pollution Control Agency)

Potential Treatment Mechanisms								
I <sup>1</sup>	ET	FA	B	RH	S	F	P	T
✓	✓				✓		✓	
Legend: I = Infiltration					S = Sedimentation			
ET = Evapotranspiration					F = Flootation			
FA = Filtration and/or Adsorption					P = Plant Uptake			
B = Biochemical Transformation					T = Trash Capture			
RH = Rainfall and Runoff Harvest								

<sup>1</sup> For unlined systems only; these systems are sometimes constructed with a liner

Wet ponds are similar to constructed wetlands in that they are vegetated basins with a pool of water year-round or, depending on location/climate, at least during the wet season, but they differ in that wet ponds are much deeper than wetlands. The constant pool of water allows stormwater to slowly infiltrate and receive treatment from the plant roots. A schematic of a basic wet pond is shown in Figure 2.

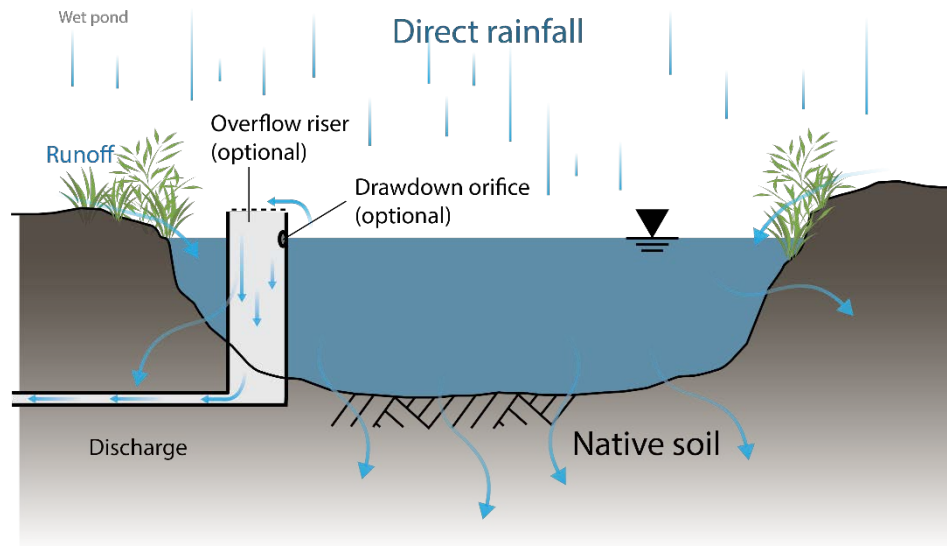

Figure 2. Schematic of a basic wet pond

### 1.1 Variations and Alternative Names

- Stormwater ponds
- Retention ponds
- Wet extended detention ponds
- Detention ponds

## 2.0 ADVANTAGES & LIMITATIONS

### 2.1 Advantages

- ✓ Can provide habitat for wetland wildlife and add aesthetic appeal
- ✓ Can provide significant reduction in contaminants/pollutants

### 2.2 Limitations

- ✗ Vector breeding often becomes an issue
- ✗ Public access safety concerns may require security fencing around the area



## Wet Pond Factsheet

- ✘ Relatively high land area requirement

### 3.0 SITING

Wet ponds are not suitable for areas with steep/unstable slopes. Also, they may not be appropriate for discharges into cold water streams due to warm water from the pond possibly increasing stream temperatures.

If the site has significantly porous soil, an impermeable liner along the bottom may be required to maintain the permanent pool.

### 4.0 DESIGN CONSIDERATIONS

When designing a wet pond, the following parameters should be considered:

- Design volume
- Drawdown time
- Permanent pool volume/depth
- Liner (optional)
- Inlet/outlet erosion control
- Forebay
- Surcharge depth
- Side slopes
- Seepage collar (to prevent piping/internal erosion on bermed systems)
- Vegetation
- Vector control animals (e.g., mosquito fish)

### 5.0 CONSTRUCTION CONSIDERATIONS

- Install seepage collars on outlet piping to prevent water from seeping out and causing damage

### 6.0 MAINTENANCE

- Maintain permanent pool of water
  - may require water to be pumped in during dry weather
- Inspections:
  - of vegetation while pond is establishing, replanting vegetation as needed
  - of outlet
  - for trash and debris accumulation
  - for mosquitos and other vectors
- Vegetation and fish management may be required

### 7.0 REFERENCES

California Stormwater Quality Association (CASQA 2003). *Stormwater Best Management Practice Handbook: New Development and Redevelopment*. January 2003.

California Stormwater Quality Association (CASQA 2017). *Draft Stormwater Best Management Practice Handbook: New Development and Redevelopment*. April 2017.

Sacramento Stormwater Quality Partnership (SSQP 2018). *Stormwater Quality Design Manual*. July 2018.