

1991

United States
Environmental Protection
Agency

Office of
Research and Development
Washington, DC 20460

EPA/600/6-91/003
February 1991



Methods for Aquatic Toxicity Identification Evaluations



Phase I Toxicity Characterization Procedures

Second Edition

A decorative graphic at the bottom of the page consisting of a series of parallel, slanted lines that create a sense of depth and movement, resembling a stylized arrow or a series of steps.

REPRODUCED BY
U.S. DEPARTMENT OF COMMERCE
NATIONAL TECHNICAL
INFORMATION SERVICE
SPRINGFIELD, VA 22161

18741

TECHNICAL REPORT DATA (Please read instructions on the reverse before completing)		
1. REPORT NO. EPA/600/6-91/003	2.	3. REC. PIEN'T'S ACCESSION NO. PB92-100 072
4. TITLE AND SUBTITLE Methods for Aquatic Toxicity Identification Evaluation: Phase I Toxicity Characterization Procedures (Second Edition)		5. REPORT DATE February 1991
7. AUTHOR(S) Norberg-King, T.J. ¹ , Mount, D. ² , Durhan, E. ¹ , Ankley, G.T. ¹ , Burkhard, L. ¹ , Amato, J. ² , Lukasewycz, M. ²		6. PERFORMING ORGANIZATION CODE
9. PERFORMING ORGANIZATION NAME AND ADDRESS ¹ United States Environmental Protection Agency, Environmental Research Laboratory, 6201 Congdon Blvd. Duluth, MN 55804; ² ASCI Corp, Duluth, MN 55804; ³ U.S.		8. PERFORMING ORGANIZATION REPORT NO.
12. SPONSORING AGENCY NAME AND ADDRESS Environmental Research Laboratory Office of Research and Development U.S. Environmental Protection Agency Duluth, MN 55804		10. PROGRAM ELEMENT NO.
		11. CONTRACT/GRANT NO.
		13. TYPE OF REPORT AND PERIOD COVERED
		14. SPONSORING AGENCY CODE EPA-600/03
15. SUPPLEMENTARY NOTES EPA Series Research Report		
16. ABSTRACT <p style="text-align: center;">ABSTRACT</p> <p>In 1988, the first edition "Methods for Aquatic Toxicity Identification Evaluations: Phase I Toxicity Characterization Procedures" was published (EPA, 1988A). This second edition provides more details and more insight into the techniques described in the 1988 document. The manual describes procedures for characterizing the physical/chemical nature of toxicants in acutely toxic effluent samples, with applications to other types of samples such as receiving water samples, sediment pore water or elutriate samples, and hazardous wastes.</p>		
17. KEY WORDS AND DOCUMENT ANALYSIS		
a. DESCRIPTORS	b. IDENTIFIERS/OPEN ENDED TERMS	c. COSATI Field/Group
Author(s) Continued: Anderson-Carnahan, L. ³ Performing Org. Name and Address Continued: Environmental Protection Agency, Region IV-Policy Planning and Evaluation Branch, 345 Courtland, Atlanta, GA 30365.		
18. DISTRIBUTION STATEMENT Release to public	19. SECURITY CLASS (This Report) Unclassified	21. NO. OF PAGES 84
	20. SECURITY CLASS (This page) Unclassified	22. PRICE

EPA/600/6-91/003
February 1991

Methods for Aquatic Toxicity Identification Evaluations

Phase I Toxicity Characterization Procedures

(Second Edition)

Edited by

T.J. Norberg-King
D.I. Mount
E.J. Durhan
G.T. Ankley
L.P. Burkhard
Environmental Research Laboratory
Duluth, MN 55804

J.R. Amato
M.T. Lukasewycz
M.K. Schubauer-Berigan
ASCI Corporation
6201 Congdon Boulevard
Duluth, MN 55804

L. Anderson-Carnahan
Region IV - Policy Planning & Evaluation Branch
Atlanta, GA 30365

National Effluent Toxicity
Assessment Center
Technical Report 18-90

Environmental Research Laboratory
Office of Research and Development
U.S. Environmental Protection Agency
Duluth, MN 55804



Printed on Recycled Paper

Notice

This document has been reviewed in accordance with U.S. Environmental Protection Agency Policy and approved for publication. Mention of trade names or commercial products does not constitute endorsement or recommendation for use.

Foreword

This document is one in a series of guidance documents intended to aid dischargers and their consultants in conducting aquatic organism Toxicity Identification Evaluations (TIEs) as part of Toxicity Reduction Evaluations (TREs). Such effluent evaluations may be required as the result of an enforcement action or as a condition of a National Pollutant Discharge Elimination System (NPDES) permit. This document will also help to provide U.S. Environmental Protection Agency (EPA) and State Pollution Control Agency staff with the background necessary to oversee and determine the adequacy of effluent TIEs proposed and performed by NPDES permittees. While this TIE approach was developed for effluents, the methods and techniques have direct applicability to other types of aqueous samples, such as ambient waters, sediment pore waters, sediment elutriates, and hazardous waste leachates.

The TIE approach is divided into three phases. Phase I (this document) contains methods to characterize the physical/chemical nature of the constituents which cause toxicity. Such characteristics as solubility, volatility and filterability are determined without specifically identifying the toxicants. Phase I results are intended as a first step in specifically identifying the toxicants but the data generated can also be used to develop treatment methods to remove toxicity without specific identification of the toxicants. Two EPA TRE manuals (EPA, 1989A; 1989B) use parts of Phase I in developing those approaches.

Phase II (EPA, 1989C) describes methods to specifically identify toxicants if they are non-polar organics, ammonia, or metals. This Phase is incomplete because methods for other specific groups, such as polar organics, have not yet been developed. As additional methods are developed, they will be added.

Phase III (EPA, 1989D) describes methods to confirm the suspected toxicants. It is applicable whether or not the identification of the toxicants was made using Phases I and II. Complete Phase III confirmations have been limited to date, but avoiding Phase III may invite disaster because the suspected toxicant(s) was not the actual toxicant(s).

Phases I and II are intended for acutely toxic effluents. However, that limitation does not mean that effluents having chronic limits cannot be evaluated using these methods. TIE methods to evaluate the cause of chronic toxicity in effluents are being developed (EPA, 1991A).

These methods are not mandatory but are intended to aid those who need to characterize, identify or confirm the cause of toxicity in effluents or other aqueous samples such as ambient waters, sediments, and leachates. Where we lack experience, we have indicated this and have suggested avenues to follow. All tests need not be done on every sample; the tests are, in general, independent. However, experience has taught us that skipping tests may result in wasted time, especially during the early stages of Phase I. An exception to this is when one wants to know if only a specific substance, for example ammonia, is causing the toxicity or if toxicants other than ammonia are involved. Otherwise, we urge the use of the whole battery of tests.

We welcome comments from users of these manuals so that future editions can be improved. Comments can be sent to NETAC, ERL-Duluth, 6201 Congdon Boulevard, Duluth, MN 55804.

Abstract

In 1988, the first edition "Methods for Aquatic Toxicity Identification Evaluations: Phase I Toxicity Characterization Procedures" was published (EPA, 1988A). This second edition provides more details and more insight into the techniques described in the 1988 document. The manual describes procedures for characterizing the physical/chemical nature of toxicants in acutely toxic effluent samples, with applications to other types of samples such as receiving water samples, sediment pore water or elutriate samples, and hazardous wastes. The presence and the potency of the toxicants in the samples are detected by performing various manipulations on the sample and by using aquatic organisms to track the changes in the toxicity. This toxicity tracking step is the basis of the toxicity identification evaluation (TIE). The final step is to separate the toxicants from the other constituents in the sample in order to simplify the analytical process. Many toxicants must be concentrated for analysis.

The Phase I manipulations include pH changes along with aeration, filtration, sparging, solid phase extraction, and the addition of chelating (i.e., ethylenediaminetetraacetate ligand (EDTA)) and reducing (i.e., sodium thiosulfate) agents. The physical/chemical characteristics of the toxicants are indicated by the results of the toxicity tests conducted on the manipulated samples.

Since the first document was developed, additional options or new procedures have been developed. For example, additional options are provided in the EDTA and sodium thiosulfate addition tests, and in the graduated pH test. Also a discussion has been added for testing the effluent sample over time (weekly) to measure the rate of decay of toxicity which is used to detect the presence of degradable substances, particularly chlorine or surfactants. Guidance for characterizing whether a toxicant(s) removed by aeration is sublutable is described, and techniques for characterizing filterable toxicity and a discussion of C_{18} solid phase extraction elutable toxicity has been added. Use of multiple manipulations is discussed and example interpretations of the results of the Phase I manipulations are provided.

Additional manuals describe the methods used to specifically identify the toxicants (EPA, 1989C) and to confirm whether or not the suspect toxicant(s) is the actual toxicant(s) (EPA, 1989D).

Contents

	Page
Foreword	iii
Abstract	iv
Contents	v
Figures	vii
Tables	viii
Acknowledgments	ix
1. Introduction	1-1
1.1 Background	1-1
1.2 Conventional Approach to TIEs	1-1
1.3 Toxicity Based Approach	1-3
2. Health and Safety	2-1
3. Quality Assurance	3-1
3.1 TIE Quality Control Plans	3-1
3.2 Cost Considerations/Concessions	3-1
3.3 Variability	3-2
3.4 Intra-Laboratory Communication	3-2
3.5 Record Keeping	3-2
3.6 Phase I Considerations	3-2
3.7 Phase II Considerations	3-3
3.8 Phase III Considerations	3-3
4. Facilities and Equipment	4-1
5. Dilution Water	5-1
6. Effluent Sampling and Handling	6-1
6.1 Sample Shipment and Collection in Plastic versus Glass	6-3
7. Toxicity Tests	7-1
7.1 Principles	7-1
7.2 Test Species	7-1
7.3 Toxicity Test Procedures	7-2
7.4 Test Endpoints	7-3
7.5 Feeding	7-5
7.6 Multiple Species	7-5
8. Phase I Toxicity Characterization Tests	8-1
8.1 Initial Effluent Toxicity Test	8-4
8.2 Baseline Effluent Toxicity Test	8-5
8.3 pH Adjustment Test	8-8
8.4 pH Adjustment/Filtration Test	8-15
8.5 pH Adjustment/Aeration Test	8-21

Contents (continued)

	Page
8.6 pH Adjustment/C ₁₈ Solid Phase Extraction Test	8-27
8.7 Oxidant Reduction Test	8-33
8.8 EDTA Chelation Test	8-38
8.9 Graduated pH Test	8-44
9. Time Frame and Additional Tests	9-1
9.1 Time Frame for Phase I Studies	9-1
9.2 When Phase I Tests are Inadequate	9-1
9.3 Interpreting Phase I Results	9-2
9.4 Interpretation Examples	9-3
10. References	10-1

Figures

Number		Page
1-1.	Conventional approach to TIEs	1-2
1-2.	Flow chart for toxicity reduction evaluations	1-5
6-1.	Example data sheet for logging in samples	6-2
7-1.	Schematic for preparing effluent test concentrations using simple dilution techniques	7-4
8-1.	Overview of Phase I effluent characterization tests	8-2
8-2.	Example data sheet for initial effluent toxicity test	8-6
8-3.	Example data sheet for baseline effluent toxicity test	8-7
8-4.	pE -pH diagrams for the CO ₂ , H ₂ O, and Mn-CO ₂ systems (25°C)	8-9
8-5.	Flow chart for pH adjustment tests	8-11
8-6.	Example data sheet for pH adjustment test	8-13
8-7.	Overview of steps needed in preparing the filter and dilution water blanks for the filtration and/or the C ₁₈ SPE column tests	8-17
8-8.	Overview of steps needed in preparing the effluent for the filtration and/or C ₁₈ SPE column tests	8-18
8-9.	Example data sheet for filtration test	8-20
8-10.	Diagram for preparing pH adjustment/aeration test samples	8-23
8-11.	Example data sheet for aeration test	8-24
8-12.	Closed loop schematic for volatile chemicals	8-26
8-13.	Step-wise diagram for preparing the C ₁₈ SPE column samples	8-29
8-14.	Example data sheet for effluent SPE test with and without pH adjustment	8-31
8-15.	Example data sheet for the oxidant reduction test when using a gradient of sodium thiosulfate concentrations	8-36
8-16.	Example data sheet for the oxidant reduction test when effluent dilutions are used	8-37
8-17.	Example data sheet for EDTA chelation test when using a gradient of EDTA concentrations	8-41
8-18.	Example data sheet for the EDTA chelation test when effluent dilutions are used	8-42
8-19.	Example of data sheet for the graduated pH test when effluent dilutions are used	8-46

Tables

Number		Page
6-1.	Volumes needed for Phase I tests	6-3
8-1.	Outline of Phase I effluent manipulations	8-3
8-2.	Acute toxicity of sodium chloride to selected aquatic organisms	8-14
8-3.	Toxicity of methanol to several freshwater species	8-32
8-4.	Toxicity of sodium thiosulfate to <i>Ceriodaphnia dubia</i> , <i>Daphnia magna</i> , and fathead minnows	8-34
8-5.	Toxicity of EDTA to <i>Ceriodaphnia dubia</i> and fathead minnows in water of various hardnesses and salinities	8-39
8-6.	The toxicity of the Mes, Mops, and Popso buffers to <i>Ceriodaphnia dubia</i> and fathead minnows	8-48

Acknowledgments

We wish to acknowledge the assistance of many people from the Environmental Research Laboratory-Duluth (ERL-D) for their help and advice in preparing the manual. The experience referred to throughout the document is the collective experience of the individuals in the National Effluent Toxicity Assessment Center (NETAC). During the development of this document and the first edition, that group has consisted of Don Mount, Teresa Norberg-King, Larry Burkhard, Liz Durhan, Gary Ankley, Shaneen Murphy (all ERL-D staff), Linda Anderson-Carnahan, (EPA, Region IV), Joe Amato, Marta Lukasewycz, Greg Peterson, Jim Taraldsen, Jim Jenson, Mary Schubauer-Berigan, Art Fenstad, Doug Jensen, Steve Baker, Liz Makynen, Jo Thompson, Correne Jenson, Lara Andersen, Linda Eisenschenk, Nola Englehorn, and Eric Robert, (all currently or formerly with AScl Corporation, Duluth).

For this revision, several individuals were assigned sections to write or re-write. This group consisted of Don Mount, Teresa Norberg-King, Larry Burkhard, Liz Durhan, Gary Ankley, Marta Lukasewycz, Joe Amato, and Mary Schubauer-Berigan. Teresa synthesized all the rewrites into similar styles, added additional sections, and updated the entire document. The assistance Debra Williams (AScl) provided to produce the graphics, to prepare the document, and assist in all aspects is greatly appreciated. Without her input the production of the document would have been slowed tremendously. Much of the data have been developed by a few people: Joe Amato generated much of the laboratory data that is discussed in this document, and others also generated the data for the tables (Jim Jenson, Doug Jensen, Shaneen Murphy, Greg Peterson, Gary Ankley, Mary Schubauer-Berigan, and Jo Thompson).

We also want to express our appreciation to Russ Hockett and Dave Mount (ENSR, Fort Collins, CO) for their data on sodium thiosulfate and W. Tom Waller (University of North Texas, Denton, TX) for his data and his technique for sulfur dioxide dechlorination.

As stated in the first edition of the TIE characterization document, the effluent group would not have been able to complete the work that is summarized in this report without the support and backing of Nelson Thomas, Senior Advisor for National Programs (ERL-D). In addition, Rick Brandes (EPA, Permits Division, Washington, D.C.) has been a strong voice in support of all the work upon which the manual is based. The support provided from the Office of Water through his impetus has enabled NETAC to become a well-established and well-staffed center.

This manual is truly the result of the effort of many people. We welcome your suggestions for improvement so that any future revision can make the methods more useful.

Section 1 Introduction

1.1 Background

The Clean Water Act (CWA, 1972) provides the basis for control of toxic substances discharged to waters of the United States. The Declaration of Goals and Policy of the Federal Water Pollution Control Act of 1972 states that "...it is the national policy that the discharge of toxic pollutants in toxic amounts be prohibited." This policy statement has been maintained in all subsequent versions of the CWA.

It is the goal of the CWA that zero discharge of pollutants to waters of the U.S. be achieved. Because this goal is not immediately attainable, the CWA allows for National Pollutant Discharge Elimination System (NPDES) permits for wastewater discharges. The five year NPDES permits contain technology-based effluent limits reflecting the best controls available. Where these technology-based permit limits do not protect water quality, additional water quality-based limits are included in the NPDES permit in order to meet the CWA policy of "no toxic pollutants in toxic amounts." State narrative and numerical water quality standards are used in conjunction with EPA criteria and other toxicity databases to determine the adequacy of technology-based permit limits and the need for additional water quality-based controls.

To insure that the CWA's prohibitions on toxic discharges are met, EPA has issued a "Policy for the Development of Water Quality-Based Permit Limitations for Toxic Pollutants" (Federal Register, 1984). This national policy recommends an integrated approach for controlling toxic pollutants that uses whole effluent toxicity testing to complement chemical-specific analyses. The use of whole effluent toxicity testing is necessitated by several factors including a) the limitations presented by chemical analysis methods, b) inadequate chemical-specific aquatic toxicity data, and c) inability to predict the aggregate toxicity of chemicals in an effluent.

To determine the toxicity of effluents to aquatic life, standardized methods for measuring acute and chronic toxicity have been developed by EPA (EPA, 1985A; EPA, 1988B; EPA, 1989E). These cost-effective methods facilitate the inclusion of whole effluent toxicity limits and biomonitoring conditions in NPDES permits for facilities suspected of causing violations of state water quality toxicity standards.

As a result of the increasing use of aquatic organism toxicity limits and biomonitoring conditions in per-

mits, a substantial number of unacceptably toxic effluents have been and continue to be identified. To rectify these problems, permittees are being required, through permit conditions and administrative orders or other enforcement actions, to perform effluent toxicity reduction evaluations (TREs). The object of the TRE is to determine which measures are necessary to maintain the effluent's toxicity at acceptable levels. Such evaluations, however, have often proven to be very complicated.

The goal of the TRE will be set by either the state regulatory agency or EPA and will be dependent on state standards that define acceptable levels of toxicity in the receiving water and effluent. Because of this, and because specific TRE actions may also be required, communication between the regulators and TRE investigators is crucial.

This document provides NPDES permittees with procedures to assess the nature of effluent toxicity to aquatic organisms. It is intended for use by those permittees having difficulty meeting their permit for whole effluent aquatic organism toxicity limits or permittees required, through special conditions, to reduce or eliminate effluent toxicity. This document does not address human health toxicity concerns such as those from bioconcentration, water supplies and recreational uses. The methods are applicable to identifying the cause of toxicity for samples other than effluents which display acute toxicity, such as ambient water samples, elutriates and pore waters from sediments, and possibly leachates. While we generally refer to effluents, the application of the techniques for any aqueous sample is implied. These methods may have applicability to effluents and other types of samples that exhibit chronic toxicity as well.

1.2 Conventional Approach to TIEs

In order to appreciate the complexities involved in a typical effluent toxicity identification evaluation (TIE), one must first understand the drawbacks in what can be considered the conventional approach to the problem of controlling toxics. The following discussion is meant to exemplify the need for a logical approach which builds on the effluent data as they are being collected.

Traditionally, when an effluent has been identified as toxic or is suspected of being toxic to aquatic organisms, a sample of the wastewater is analyzed for the 126 "priority pollutants." The concentration of each pri-

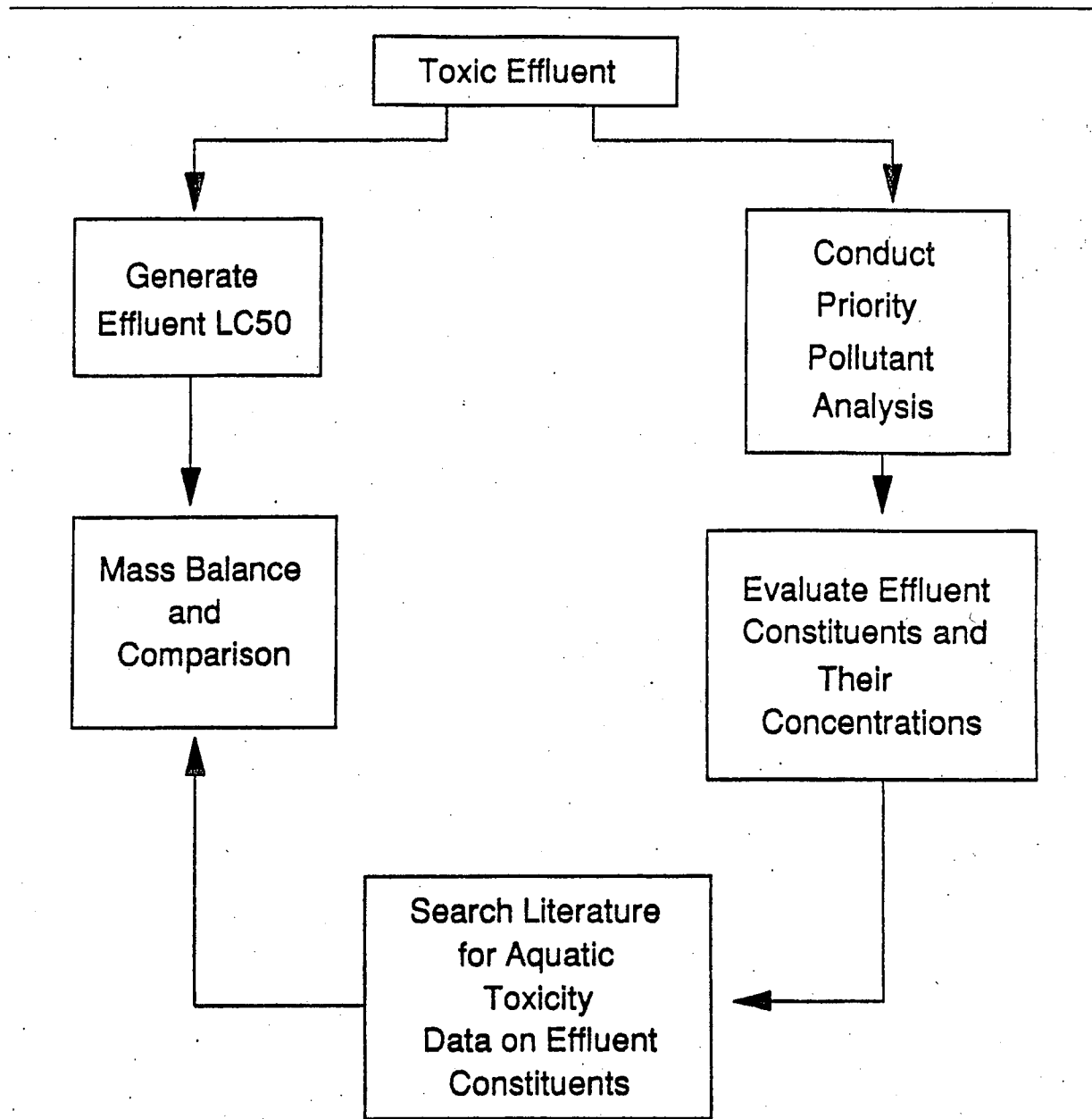

Figure 1-1. Conventional approach to TIEs.

ority pollutant present in the sample is subsequently compared to literature toxicity data for the pollutant, or is compared to EPA's Ambient Water Quality Criteria or state standards for aquatic life protection for that compound. The goal of this exercise is to determine which pollutants in the wastewater sample are responsible for effluent toxicity (Figure 1-1). Unfortunately, determining the source of an effluent's toxicity is rarely this straightforward.

The first problem encountered in this course is one of effluent variability. Because toxicity is a generic response, there is no way to determine whether the

toxicity observed over time is consistently caused by a single constituent or a combination of constituents or a number of different constituents, each acting periodically to cause effluent toxicity. Experience has shown that the latter may be a frequent occurrence especially in publicly owned treatment works (POTW) effluents. To further complicate the problem, the variability in conventional effluent monitoring parameters may not coincide with variability in the effluent toxicant(s). Monitoring methods for conventional parameters such as biological oxygen demand (BOD) frequently are not responsive to shifts in the toxicants because they are at relatively low concentrations in the effluent or simply

because the toxicants are not amenable to analysis by these procedures. For the conventional TIE approach to be successful, it is crucial that the same sample be analyzed using both chemical and biological techniques, and that a number of samples over time be studied to assess the variability in the toxicant(s).

A second problem with the conventional approach involves the focus on the priority pollutants. These have become known as the "toxic pollutants," conveying an implication that they constitute the universe of toxic chemicals but the priority pollutants are only a tiny fraction of all chemicals. Limiting the search to these 126 compounds will result in failure to identify the cause of toxicity in most cases.

On the surface, solving this difficulty may seem inconsequential; the effluent analysis must include monitoring techniques for "non-priority" as well as priority pollutants. To analyze an effluent for every chemical would cost tens of thousands of dollars and there would be no assurance that the detection levels would be low enough. Determination of the composition of an effluent is limited to the analyses used. For instance gas chromatography/mass spectrometry (GC/MS) will not identify cadmium and Inductively Coupled Emission Spectroscopy (ICP) may not detect it when the concentration is low. The absence of a measurable quantity of any substance at the method detection level is often interpreted as meaning that it is not present in the effluent at all or not at toxic levels.

The toxicants may be present at low concentrations because only small concentrations of highly toxic chemicals are needed to produce toxicity. If this is true, then low concentrations must be measured. Such chemicals are not easily found by examining system loadings. For example, if a chemical has an LC50 of 1 µg/L, 380 g (less than a pound per day) of the compound must be present to cause lethality in the effluent of a 100 million gallons per day (mgd) treatment plant. With a removal efficiency of 99%, a loading of only 100 pounds per day would be needed to produce a toxic effluent. Clearly then, large loadings cannot be used to guide selection of analytical techniques, and loads of a few pounds in a collection system producing 100 mgd may be next to impossible to identify by the usual methods of establishing loadings.

Many analytical methods are relatively limited in their applicability. Even GC/MS, an instrument heavily relied upon in typical wastewater analyses, is incapable of detecting about 80% of all synthetic organic compounds (G. Veith, personal communication, ERL-Duluth). This limitation is related to selection and efficiency of solvent extraction techniques, analyte volatility and thermal stability, detector specificity and sensitivity, and analytical interferences and artifacts. The percentage of organics detected can be improved by derivatization but the results are much more difficult to interpret. In general, the broader spectrum methods are less sensitive and require higher concentrations of analytes for detection and are costly. To detect lower concentra-

tions, more specific methods are usually more sensitive. To choose specific methods one must have knowledge of the toxicants--knowledge which does not exist, since that is the purpose of the analyses.

Surprisingly, even with these limitations, one usually sees lengthy lists of effluent constituents when analyses are performed on wastewater. In the case of GC/MS chromatograms, large peaks of non-toxic effluent constituents can overlap and hide smaller peaks that may represent the toxicants of concern. When many chemicals are present, the number of peaks that can be identified may be small. Failure to identify a component does not mean that the chemical is not toxic. By using reference spectra, many peaks may be tentatively identified as several different compounds which serves only to increase, not decrease, the number of possibilities. No aquatic toxicity data will be available for most of these compounds, so toxicity data must be generated during the study. Compounds may need to be synthesized in order to test them because they are not available commercially. For those compounds for which aquatic toxicity data are available, the data may not include the species used for the TIE. Even if all this work is done, trying to pinpoint the cause of toxicity in such a complex mixture is likely to fail because this approach does not include matrix effects and toxicant bioavailability. For example, several metals may be present in an effluent sample at concentrations well above the toxic threshold. These metals may not be the source of the effluent's toxicity, however, because they are not biologically available. Characteristics such as total organic carbon (TOC), total suspended solids (TSS), ionic strength, pH, hardness and alkalinity can change toxicity. The inability to quantitate the effects these parameters have on toxicity further decreases the chances for a successful TIE.

1.3 Toxicity Based Approach

The approach described in this manual uses the responses of organisms to detect the presence of the toxicant during the first stages of the TIE. In this way, the number of constituents associated with the toxicants can be reduced before analyses begin and some knowledge of physical/chemical characteristics is gained. This approach simplifies the analytical problems and reduces cost. Some of the problems limiting the conventional approach can be used to enhance the success of this alternate approach.

There are two main objectives in the first step of this approach. First, characteristics of the toxicants (e.g., solubility, volatility) must be established. This allows them to be separated from other non-toxic constituents to simplify analyses and enhance interpretation of analytical data. Secondly, throughout the TIE, one must establish whether or not the toxicity is consistently caused by the same substances. Failing to establish the variability related to the toxicants could lead to control choices that do not correct the problem.

Knowledge of the physical/chemical characteristics of the toxicants aids in choosing the appropriate ana-

lytical method. Such information also may be useful in selecting an effluent treatment method.

Figure 1-2 is a flowchart representation of a TRE. This document details the toxicity characterization procedures (Phase I). Phase II (toxicant identification) and Phase III (toxicant confirmation) usually follow Phase I. Two other EPA manuals (EPA, 1989A; 1989B) can be consulted for more information on bench scale and pilot plant effluent toxicity treatability studies and source control options.

Phase I tests characterize the physical/chemical properties of the effluent toxicant(s) using effluent manipulations and accompanying toxicity tests. Each characterization test in the Phase I series is designed to alter or render biologically unavailable a group of toxicants such as oxidants, cationic metals, volatiles, non-polar organics or chelatable metals. Aquatic toxicity tests, performed on the effluent before and after the individual characterization treatment, indicate the effectiveness of the treatment and provide information on the nature of the toxicant(s). By repeating the toxicity characterization tests using samples of a particular effluent collected over time, these screening tests will provide information on whether the characteristics of the compounds causing toxicity remain consistent. These tests will not provide information on the variability of toxicants within a characterization group. Knowing that the toxicants have similar physical/chemical properties means that they can be identified in Phase II using similar techniques. With successful completion of Phase I, the toxicants can be tentatively categorized as cationic metals, non-polar organics, oxidants, substances whose toxicity is pH dependent, and others. Information on physical/chemical characteristics of the toxicants will indicate filterability, degradability, volatility, and solubility. Either of two choices is available in the second phase of testing, i.e., toxicant treatability or toxicant identification studies.

Toxicant identification is described in Phase II (EPA, 1989C). Phase II involves several steps, all of which rely on tracking the toxicity of the effluent throughout the analytical procedure. Although effluent toxicants are partially isolated in the first phase of the study, further separation from other compounds present in the effluent is usually necessary. Techniques are available to reduce the number of compounds associated with the toxicants. Unlike Phase I procedures, Phase II methods will be toxicant-specific. Currently available techniques in Phase II are for identifying non-polar organics, EDTA chelatable metals, and ammonia. Enough information exists now to add a section for

surfactants. Additional procedures for other toxicants will be added as they are developed. Once the toxicants have been adequately isolated from other compounds in the effluent and tentatively identified as the causative agents, final confirmation (Phase III) can begin.

Like Phase I, Phase III (EPA, 1989D) contains methods generic to all toxicants. No single test provides irrefutable proof that a certain chemical is causing effluent toxicity. Rather, the combined results of the confirmation tests are used to provide the "weight of evidence" that the toxicant has been identified.

Once the toxicant has been identified, it can be tracked through the process collection system using chemical analyses. Toxicity cannot be used to find the source for untreated wastes because toxicity from other constituents that are toxic in untreated waste but removed by treatment, will confuse the results. Of course, using bench- or pilot-scale systems and measuring toxicity on treated waste, is feasible.

TIEs require that toxicity be present frequently enough and endure storage (that is, the toxicity is not rapidly degrading) so that repeated testing can characterize and subsequently identify and confirm the toxicants in Phases II and III. Therefore, enough testing should be done to assure consistent presence of toxicity before TIEs are initiated. This is done not to validate a given test but to establish the sufficient and frequent presence of toxicity.

The methods described herein are applicable primarily to acute toxicity. Chronic toxicity identification methods are being developed (EPA, 1991A). In some special cases in which toxicity can be concentrated (as in the non-polar organic section of Phase II) one may be able to "convert" chronic toxicity to acute toxicity by concentration and successfully identify what is causing the chronic toxicity.

To be successful, TIEs must be conducted by multidisciplinary teams whose members must interact daily so that toxicologists and chemists are aware of the many concerns that affect test results. Speed is usually important because effluents may decay during storage. Often subsequent tests cannot be designed until the results of the previous ones are known. Obviously then, waiting a week for analytical or toxicological results may preclude more work while the effluent sample undergoes changes during the waiting period. If this happens, one must begin again on a new sample in which case resources are not being used effectively.

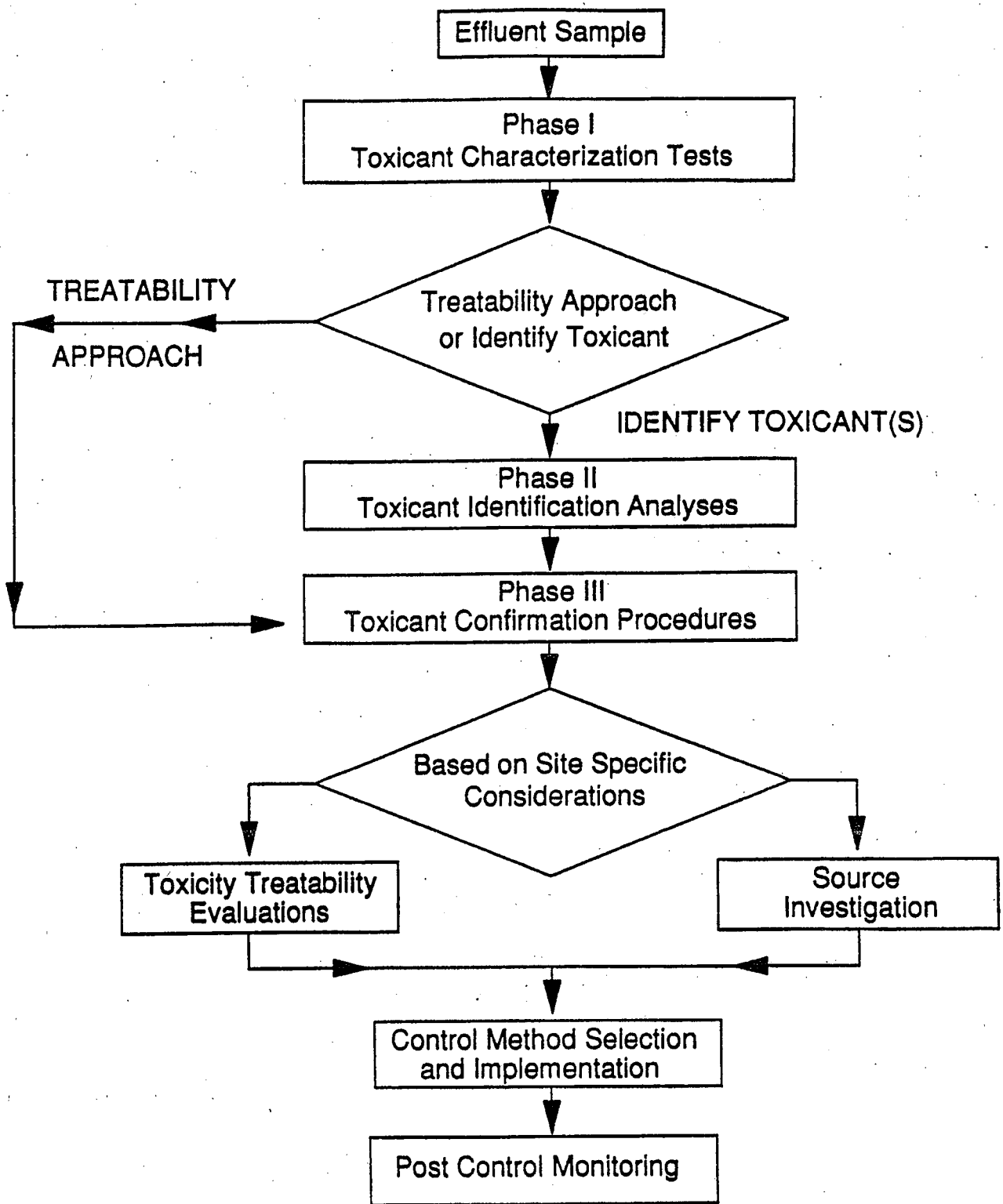

Figure 1-2. Flow chart for toxicity reduction evaluations.

Section 2 Health and Safety

Working with effluents of unknown composition is the nature of toxicity identification evaluations. Therefore safety measures must be adequate for a wide spectrum of chemicals as well as biological agents. From the type of treatment used one may be able to judge probable concerns. For example, extended aeration is likely to minimize the presence of volatile chemicals and chlorinated effluents are less likely to contain viable pathogens.

Exposure to the wastewater during collection and its use in the laboratory should be kept at a minimum. Inhalation and dermal adsorption can be reduced by wearing rubber gloves, laboratory aprons or coats, safety

glasses, and respirators, and by using laboratory hoods. Further guidance on health and safety for toxicity testing is described in Walters and Jameson (1984).

In addition to taking precautions with effluent samples, a number of the reagents that might be used during Phase II toxicant identification and Phase III toxicant confirmation studies are known or suspected to be very toxic to humans. Analysts should familiarize themselves with safe handling procedures for these chemicals (DHEW, 1977; OSHA, 1976). Use of these compounds may also necessitate specific waste disposal practices.

Section 3

Quality Assurance

Quality assurance is composed of two aspects, quality verification and quality control. Quality verification entails a demonstration that the proposed study plan was followed as detailed and that work carried out was properly documented. Some of the aspects of quality verification include chain of custody procedures, statements on the objective of the study and what is known about the problem at its outset, instrumental log books, and work assignments. This aspect of quality assurance ensures that a "paper trail" is created to prove that the work plan has been covered completely. The quality control aspect of quality assurance involves the procedures which take place such as the number of samples to be taken and the mode of collection, standard operating procedures for analyses, and spiking protocols.

No set quality assurance program can be dictated for a TIE; the formula to a successful study will be unique to each situation. However, adherence to some general guidelines in formulating a Quality Assurance Plan (QAP) may increase the probability of success.

In preparing a QAP, enough detail should be included so that any investigator with an appropriate background could take over the study at any time. Cross checking of results and procedures should be built into the program to the extent possible. Records should be of a quality that can be offered as evidence in court. Generally, the QAP should be provided in a narrative form that encourages users to think about quality assurance. To be effective, the QAP must be more than a paper exercise simply restating standard operating procedures (SOPs). It must increase communication between clients, program planners, field and laboratory personnel and data analysts. The QAP must make clear the specific responsibilities of each individual. The larger the staff, the more important this becomes. While QAPs may seem to be an inconvenience, the amount of effort they require is commensurate with the benefits derived.

3.1 TIE Quality Control Plans

A successful TIE is dependent upon a strong quality control program. Obtaining quality TIE data is more difficult because the constituents are unknown in contrast to quality control procedures for a standard analytical method for a specific chemical. In such an analysis, one knows the characteristics of the analyte and the implications of the analytical procedure being utilized. Without knowledge of the physical/chemical char-

acteristics of the analyte, however, the impact of various analytical procedures on the compound in question is not known. Further, quality control procedures are specific to each compound; quality control procedures appropriate to one analyte may be completely inappropriate to another.

The problem of quality control is further exaggerated because quality control procedures for aquatic toxicity tests may be radically different from those required for individual chemical analyses. This additional dimension to quality control requires a unique framework of checks and controls to be successful. The impacts of chemical analytical procedures on sample toxicity must be included. Likewise, procedures used to insure quality toxicity test results should not impact chemical analyses. For example, in performing standard aquatic toxicity tests, samples with low dissolved oxygen (DO) are usually aerated. This practice may, however, result in a loss of toxicity if the toxicant is volatile or subject to oxidation.

3.2 Cost Considerations/Concessions

The quality control practices required in any given experiment must be weighed against the importance of the data and decisions to be based upon it. The crucial nature of certain data will demand stringent controls, while quality control can be lessened in other experiments having less impact on the overall outcome.

Effluent toxicant identification evaluations require a large number of aquatic toxicity tests. The decision to use the standard toxicity test methods described in EPA (1985A; 1991B) (involving a relatively high degree of quality control), must be weighed against the degree of complexity involved, the time required and the number of tests performed; all of these affect the cost of testing. For this reason, toxicity tests used in the early phases of the evaluation generally do not follow this protocol, nor do they require exacting quality controls because the data are only preliminary. Phase I, and to a lesser extent, Phase II results are more tentative in nature as compared to the tests performed for the confirmation of the effluent toxicant(s) in Phase III.

The progression towards increasingly definitive results is also reflected in the use of a single species in the initial evaluation studies and multiple species in the later stages. The use of several species of aquatic organisms to assure that effluent toxicity has been reduced to acceptable levels is necessary because species have different sensitivities to the same pollut-

ant. Quality control must relate to the ultimate goal of attaining and maintaining the designated uses of the receiving water. For this reason, final effluent test results must be of sufficient quality to ensure ecosystem protection. The use of dilution water for the toxicity tests which mimics receiving water characteristics (in hardness and pH) will help to ensure that the effluent will remain non-toxic after being discharged into the environment. In the instances where the effluent dominates the receiving water, the dilution water should mimic the water chemistry characteristics of the effluent. This is discussed in Section 5, Dilution Water. In addition, it is essential that the variability in the cause of effluent toxicity be defined during the course of the TIE so that appropriate control actions provide a final effluent safe for discharge.

3.3 Variability

The opportunities to retest any effluent to confirm the quality of initial TIE results will be limited at best. In addition to the shifting chemical and toxicological nature of the discharge over time, individual effluent samples stored in the laboratory change. Effluent constituents degrade at unknown rates, as each compound has its own rate of change. The change in a sample's toxicity over time represents the cumulative change in all of the constituents, plus that variation resulting from experimental error. Some guidelines for assessing and minimizing changes in sample chemistry and toxicity are discussed in Sections 6 and 8. Regardless of the precautions taken to minimize sample changes, a sample cannot be retested with certainty that it has not changed.

3.4 Intra-Laboratory Communication

Quality control procedures in chemistry and biology can be quite different. For example, phthalates are a frequent analytical contaminant requiring special precautions that are not of toxicological concern. The toxicological problem presented by the zinc levels typically associated with new glassware are of no concern to those performing organic analyses. The difference in glassware cleanup procedures is an example of many differences that must be resolved. Cleaning procedures must be established to cover the requirements of both. Time schedules for analyses must be detailed in advance. One cannot assume compound stability; therefore, time delays between the biological and chemical analysis of a sample cannot be tolerated.

3.5 Record Keeping

Throughout the TIE, record keeping is an important aspect of quality verification. All observations, including organism symptoms, should be documented. Details that may seem unimportant during testing may be crucial in later stages of the evaluation. Investigators must record test results in a manner such that preconceived notions about the effluent toxicants are not unintentionally reflected in the data. TIEs required by state or federal pollution control agencies may require that some or all records be reviewed.

3.6 Phase I Considerations

Effluent toxicity is "tracked" through Phases I, II and III using aquatic organisms. Such tracking is the only way to detect where the toxicants are until their identity is known. The organism's response must be considered as the foundation and therefore, the toxicity test results must be dependable. System blanks (blank samples carried through procedures and analyses identical to those performed on the effluent sample) are used extensively throughout the TIE in order to detect toxic artifacts added during the effluent characterization manipulations. With the exception of tests intended to make the effluent more toxic, or situations in which a known amount of artifactual toxicity has been intentionally added, sample manipulation should not cause the effluent toxicity to change.

There are many sources of toxicity artifacts in Phase I. These include: excessive ionic strength resulting from the addition of acid and base during pH adjustment, formation of toxic products by acids and bases, contaminated air or nitrogen sources, inadequate mixing of test solutions, contaminants leached from filters, pH probes, solid phase extraction (SPE) columns, and the reagents added and their contaminants. The appropriate toxicity data for the reagent chemicals used in Phase I and common aquatic test organisms are provided as needed in subsequent sections of this document.

Frequently toxic artifacts are unknowingly introduced. For example, pH meters with refillable electrodes can act as a source of silver which can reach toxic levels in the solutions being measured for pH. This is especially a problem where there is a need to carefully maintain or track solution pH. Using pH electrodes without membranes avoids the silver problem (which can only be detected by profuse use of blanks).

Oil in air lines or from compressors is a source of contamination. Simple aeration devices, such as those sold for use with aquaria are better as long as caution is taken to prevent contamination of the laboratory air which is taken in by the pump.

Worst case blanks should be used to better ensure that toxicity artifacts will be recognized. Test chambers should be covered to prevent contamination by dust and to minimize evaporation. Since small volumes are often used, evaporation must be controlled. Plastic disposable test chambers are recommended to avoid problems related to the reuse of test chambers. Cups from the same lot should be spot-checked for toxicity.

Glassware used in various tests and analyses must be cleaned not only for the chemical analyses but so that toxicity is not introduced either by other contaminants or by residues of cleaning agents. Since the organisms are sensitive to all chemicals at some concentrations, all toxic concentrations must be removed and not just those for which analyses are being made.

Randomization techniques, careful observance of organism exposure times and the use of organisms of

approximately the same age ensure quality data. Standard reference toxicant tests should be performed with the aquatic test species on a regular basis and control charts should be developed (EPA, 1985A; 1991B). During Phase I it will not be known how much the toxicity of the reference toxicant varies over time compared to the toxicant(s). When the toxicants are known, they should be used as the reference toxicant. Reference toxicant tests should be performed to coincide with the TIE testing schedule.

3.7 Phase II Considerations

In Phase II, a more detailed quality control program is required. Interferences in toxicant analysis are for the most part unknown initially but as toxicant identifications are made, interferences can be determined. Likewise instrumental response, degree of toxicant separation, and detector sensitivity can be determined as identifications proceed.

3.8 Phase III Considerations

In Phase III of a TIE, the detail paid to quality control and verification is at the maximum. This phase of the study responds to the compromises made to data quality in Phases I and II. For this reason, confidence intervals for toxicity and chemical measurements

must be calculated. These measurements allow the correlation between the concentration of the toxicants and effluent toxicity to be checked for significance based on test variability. Effluent manipulations prior to chemical analysis and toxicity testing are minimized in this phase in an effort to decrease the chance for production of artifacts. Field replicates to validate the precision of the sampling techniques and laboratory replicates to validate the precision of analyses must be included in the Phase III quality control program. System blanks must be provided. Calibration standards and spiked samples must also be included in the laboratory quality control program. Because an attempt will be made to correlate effluent toxicity to toxicant concentration, spiking experiments are important in determining recovery for the toxicant(s). These procedures are feasible in this phase of the study because the identities of the substances being measured are known.

The toxicants being analyzed can be tested using pure compounds, thereby alleviating the need for a general reference toxicant. Because the test organism also acts as an analytical detector in the correlation of effluent toxicity with toxicant(s) concentration, changes in the sensitivity of the test organisms must be known. This is best achieved by using the same chemicals identified for the reference toxicants.

Section 4 Facilities and Equipment

The facilities, equipment and reagents needed to perform an effluent TIE will depend on the phase of the study and the characteristics of the toxicant(s). The equipment required for Phase I characterization tests is described throughout Section 8. The facility and equipment needs in Phase II of the TIE will be site-specific and will depend both on the physical/chemical characteristics of the toxicants and on the choice of the Phase II approach.

Phase I requires only basic analytical and toxicity testing equipment which would be available in most laboratories where toxicity tests and the usual water chemistry analyses are performed. Phase III requirements are largely limited by equipment found in a typical toxicity testing lab and equipment necessary for the analysis of the toxicant(s).

Because of the equipment needs and time required to conduct the evaluations, complete on-site effluent

TIEs using a mobile laboratory are generally not feasible. Measurement of the loss of toxicity over time in several effluent samples will provide information upon which to base acceptable storage times. Usually, with modern rapid sample shipment methods, off-site work is practical. The cost of shipment is usually far less than the cost of on-site work.

Large numbers of organisms and many tests are needed for TIEs. Ready availability of test organisms is important because often the test(s) needed are not predictable. Only after the results of one experiment are known can the next test be planned. It is probably more economical to culture many of the test species that might be used in TIEs than it is to purchase them. A delay in testing caused by shipment time or lack of availability of test organisms could cost far more in work loss than it would cost to maintain cultures for many weeks.

Section 5 Dilution Water

The choice of dilution water will change with the purpose of the tests and therefore the choice will often be more varied in Phases I and II than in Phase III. Particularly for some toxicant groups in Phase II, some very unusual dilution water is recommended in order to achieve the desired chemical conditions. Sometimes the water may in itself be toxic! Such concepts are foreign to conventional toxicology and rightly so, but this is not conventional toxicology.

Much of Phase I and parts of Phase II utilize organism tolerance and relative toxicity to accomplish the objectives of the study. Methanol, hydrogen ion concentration, and osmotic pressure may sometimes be near lethal levels in order to test necessary conditions. In some cases, the dilution medium may cause complete mortality in 48 h, but the point of interest is whether treatment causes more rapid mortality. If so, one can say that one condition is more toxic than another and obtain important information from the test. The key is to run sufficient numbers of system blanks so that the relative contribution to mortality is known and toxicity is not attributed to an incorrect cause. These are examples of the previous statement that these methods "utilize tolerance and relative toxicity." In reality, this approach is very much like the comparison of the toxicity of two chemicals, A and B. If one determines LC50s for A and B and concludes that A is twice as toxic as B, lethal conditions are being compared in order to say this. Controls are not involved in the LC50 calculation and high control survival does not change the data interpretation. The same concept of relative toxicity is used here. Chemical "A" is the blank and chemical "B" is the treated sample and the question is, "which is more toxic?"

As these methods are built on tolerance (i.e., survival), chronic toxicity endpoints cannot be used and that is why these methods are primarily intended for acute toxicity. Obviously, if one wants to measure chronic effects, the test organisms must be able to live long enough to display chronic effects. Many of the pH changes and other manipulations used in these methods do not allow sufficient survival time or health for reproduction or growth. For chronic TIEs, more attention has to be given to acclimation, feeding and general living conditions (EPA, 1991A).

Many of the additives used in the Phase I manipulations change the mixture of the effluent much more than the dilution water. In general, for Phase I, any water which is of a consistent quality and which will support growth and reproduction of the test species is suitable. We have found the use of a dilution water that has a hardness similar to that of the effluent or the receiving water to be beneficial. A variety of dilution water choices are provided by EPA (1985A; 1989E) and any of these may be used for TIEs.

In Phase III, where the objective is to confirm the true cause of toxicity, where artifacts are to be excluded to the extent possible and where absolute toxicity is more important than relative toxicity, practices including choice of dilution water, must follow conventional toxicological methodology. Tolerance to additives must not be necessary in order to provide the desired response. Attention must be given to simulation of the dilution water into which the effluent is discharged. Some toxicant dose response relationships may be totally different as the water quality characteristics change. These factors must be incorporated into Phase III where absolute toxicity is of the utmost concern. In Phases I and II, only relative differences are being considered.

Perhaps a cautionary note is warranted regarding the effects of dilution water on effluent toxicity. If high concentrations of effluent are being tested (e.g., 80%) the physical/chemical characteristics will resemble those of the effluent. If low concentrations are tested (e.g., 5%) then characteristics will resemble those of the dilution water.

Little specific information can be given about the selection of dilution water in Phases I and II except that the desired tested conditions will often dictate its characteristics. For example, in Section 8.6, the same column used for the blank may not be usable for the effluent sample if receiving water is used as the dilution water. Secondly, sufficient numbers of blanks must be included to interpret the results. In Phase III, the choice of the appropriate dilution water should be based on the characteristics of the receiving water where the discharge occurs.

Section 6

Effluent Sampling and Handling

A wastewater sample may be representative only of the discharge at the time of sampling. In effect, each sample is a "snapshot" of the effluent's toxicological and chemical quality over time. To determine whether any effluent sample is typical of the wastewater may require the collection of a large population of samples. Further, what constitutes a "representative" sample is a function of the parameter of concern. Because effluents vary in composition, sampling must be extensive enough that one is confident that the groups of samples represent the discharge over time. Guidelines for determining the number and frequency of samples required to represent effluent quality are contained in the "Handbook for Sampling and Sample Preservation of Water and Wastewater" (Berg, 1982). However, since this guidance is not based on toxicity, it should be used with caution.

Both quantitative (change in concentration) and qualitative (change in toxicants) variability commonly occur in effluents and both may affect toxicity. Changes in effluent toxicity are the result of varying concentrations of individual toxicants, different toxicants, changing water quality characteristics (affecting compound toxicity) and analytical and toxicological error. Even if the toxicity of an effluent to an aquatic organism is relatively stable, this does not mean that there is only a single toxicant causing toxicity in any given sample or among several samples.

Determining whether a sample is typically toxic is not as simple as comparing the conventional pollutants of the sample to long-term effluent averages. Effluent toxicants often do not follow the same trends as BOD, TOC and TSS. The toxicant(s) may be present at such a low level that it does not significantly affect the quantity of the conventional pollutant, even though it is present in toxic concentrations.

Conventional parameters, BOD, TSS, and other pollutants limited in the facility's NPDES permit, will provide an indication of the operational status of the treatment system on the day of sampling. For industrial discharges, information on production levels and types of operating processes may be helpful. The condition of the facility's treatment system at the time of sampling should be determined by the individual collecting the sample. The type of sample, time of collection, and other general information on the facility should be recorded. An example of a page of a log book is given in Figure 6-1.

Upon the arrival of the sample in the laboratory, temperature, pH, toxicity, hardness, conductivity, total residual chlorine (TRC), total ammonia, alkalinity, and DO should be measured. Toxicity should be measured periodically during storage to document any changes (cf., Section 8).

Investigators should not be surprised to find that well operated municipal and industrial treatment systems discharge unacceptably toxic wastewaters. Effluent guideline-based limits which reflect best achievable technology, do not prescribe limits for more than a few chemicals. Many compounds present in effluents are not regulated because the discharger is not required to report their presence in permit applications or they cannot be detected using typical methods for wastewater analysis.

For chlorinated effluents, whether sampling should be done before chlorination depends on the question to be answered. Sometimes the question may be whether or not there are toxicants other than chlorine present. Dechlorination prior to toxicity characterization may be needed in order to distinguish toxicity from causes other than chlorine. Usual methods of dechlorination may remove more than toxicity from chlorine alone and careful data interpretation is needed to understand the results. Toxicity from more than one cause is often not additive in effluents, so relative contributions from two or more causes can be very hard to decipher.

The choice of grab or composite samples will depend on the specific discharge situation, (e.g., plant retention time) questions to be answered by the TIE and the stage of the TIE. In Phase I testing, samples that are very different from one another give results that are difficult to interpret; therefore composite samples are more similar and are easier to use. In Phase III, effluent variability is used to advantage; therefore, grab samples are often best. If toxicity is low or intermittently present, grab samples may be best during all phases. The additional difficulty of getting flow proportional samples should be balanced against their advantage in each situation. While grab sampling may provide maximum effluent toxicity, it is more difficult to catch peaks in toxicity and Phase I sampling may require more time. EPA (1985A; 1991B) discusses the advantages and disadvantages of grab and composite sampling and have also detailed methods for sampling intermittent discharges.

Figure 6-1. Example data sheet for logging in samples.

Sample Log No.: _____

Date of Arrival: _____

Date and Time
of Sample Collection: _____

Facility: _____

Location: _____

NPDES No: _____

Contact: _____

Phone Number: _____

Sampler: _____

Sample Type: Grab Composite

Glass Plastic

Prechlorinated

Chlorinated

Dechlorinated

Sample Conditions Upon Arrival:

Temperature _____

pH _____

Total Alkalinity _____

Total Hardness _____

Conductivity/Salinity _____

Total Residual Chlorine _____

Total Ammonia _____

Condition of treatment system at time of sampling:

Status of process operations/production (if applicable):

Comments:

If the TIE analyses are not conducted on-site, samples must be shipped on ice to the testing location. Effluent samples should not be filtered prior to testing unless it is necessary to remove other organisms. Sample filtration could affect the results of the characterization tests, one of which entails filtering the effluent. Sample aeration should also be minimized during collection and transfer. Initial sample analysis should begin as soon as practical after effluent sampling. Phase II and especially Phase III may require specific types of sample containers or the addition of preservative to aliquots of sample designated for chemical analyses. For a single Phase I test series, 3 L of effluent are needed for analysis if test organisms such as daphnids or newly hatched fathead minnows are used. The exact volume required depends on the toxicity of the effluent and to a lesser extent, the test options chosen (cf., Section 8). For other species different volumes may be necessary. Volumes frequently used in each characterization test are supplied in Table 6-1.

The extent of the analyses carried out on any individual sample must be weighed against the cost of

additional sampling, the stability of the sample, sample representativeness and the need to have samples of different toxicity. Clearly, the resources required for such TIEs are too great to expend on a single sample or on a few samples which do not represent the effluent. Likewise, there is not a set number of samples which should be analyzed in Phases I, II or III before going on to subsequent phases of the study or taking final measures to control effluent toxicity. The number of samples analyzed in each phase will be a function of the apparent variability in the effluent, the number of toxicants, how persuasive the data are, the cost of the remedial action, regulatory deadlines and finally, the success of each study phase.

6.1 Sample Shipment and Collection in Plastic versus Glass

Effluent samples often have been collected, shipped and stored in various types of plastic (e.g., polyethylene) containers rather than glass. However, with a few effluents, we have noted that samples shipped and stored in glass were more toxic and retained their toxicity longer than split samples shipped and stored in plastic. This effect appeared to be due to adsorption of certain types of toxicants (e.g., surfactants) to the plastic. For these instances the samples in glass were more representative of the effluent, and thus for TIE purposes were preferable to the samples in plastic.

An easy way to check whether or not there is a difference in the toxicity of samples shipped and stored in glass containers versus those shipped and stored in plastic containers, is to test two or three sets of effluent samples. Effluent should be collected in glass or stainless steel, then a portion shipped in glass and another portion shipped in plastic. Baseline toxicity tests (cf., Section 8) are conducted on each, perhaps on days 4 and 7 after receipt. If the initial toxicity of the sample is similar for both the plastic and the glass containers, and the toxicity for samples from the two containers is similar over time (i.e., over storage time), it is appropriate to have the effluent samples shipped and stored in plastic containers. However, if effluent shipped and stored in glass appears to be more toxic, and retains the toxicity longer than the effluent sample shipped and stored in plastic, glass containers should be used for all shipments and storage for that particular effluent. These same considerations also apply to the sampling/collecting equipment. Collection, shipment, and storage of effluent samples in glass may involve more effort than plastic containers. The use of glass containers for samples that retain their toxicity longer might result in more rapid and cost effective progress through the TIE because fewer samples might be required for identification of effluent(s). Since only certain classes of compounds are expected to adsorb to plastic containers (e.g., surfactants), if the effluent is more toxic in glass, this can be a useful piece of information for characterizing the toxicants.

Table 6-1. Volumes needed for Phase I tests

Characterization Step	Volume for Each Step ¹	Total Volumes ² (mL)
Chemical analyses ³	--	<500
pH 3 Adjustment	30	~300
filtration	235	
solid phase extraction	200	
aeration	35	
pH 11 Adjustment	30	~300
filtration	235	
solid phase extraction ⁴	200	
aeration	35	
Unadjusted pH effluent (pH <i>i</i>) ⁵		~590
initial test	40	
baseline test	80	
filtration	235	
solid phase extraction	200	
aeration	35	
EDTA additions	100	
sodium thiosulfate additions	100	
Graduated pH		~120-1000
pH 6	40-500	
pH 7	40-500	
pH 8	40-500	

¹ Amount is dependent on effluent characteristics.

² Total volume is ~3 L; this is maximum needed, does not include subsequent testing.

³ These include temperature, pH, hardness, conductivity, TRC, total ammonia, alkalinity, and DO.

⁴ The pH is readjusted to pH 9 before it is put through the C₁₈ SPE column.

⁵ The pH *i* of the effluent is the initial pH of the effluent sample. It may be important to know the pH at the point of discharge as well as the receiving water pH and to know the pH of the effluent at air equilibrium.

Section 7 Toxicity Tests

7.1 Principles

Acute lethality tests with aquatic organisms are utilized throughout the toxicity characterization procedures described in this manual as well as in Phases II and III. Using toxicity for such evaluations is logical since toxicity triggers the TIE requirement. In these tests the organism acts as the "detector" for chemicals causing effluent toxicity. As such, they provide the true response regardless of the outcome of other analyses. The toxicity test is the only analytical procedure that can be used to measure toxicity. Until the cause of toxicity is known, chemical methods cannot be used to identify and quantify the toxicants.

There are a number of consequences associated with this reliance on toxicity. The organism responds to every constituent, provided that it is present above a threshold level either individually or collectively if the constituents are additive. While this general response to any compound presents an advantage as a broad spectrum test for toxicants, it requires considerable effort to determine the primary cause of toxicity because it is not specific. This non-specific response necessitates a generic chemical/physical characterization of toxicants during Phase I testing before Phase II identification is begun.

A further repercussion of this universal response is the probability of artifactual toxicity. Because the analyst is reliant upon the organism's ability to track toxicity throughout the effluent characterization steps, sample manipulations are constrained. While characterizing the effluent, no manipulation should change the toxicity of the sample in an unpredictable manner. "Toxicity-blanks and controls" are helpful but the difficulties associated with them are far greater than those connected with chemical analyses because of their non-specificity. As a result many more blanks are employed in TIE testing than in chemical analyses or standard toxicity testing. Negative blank toxicity cannot be assumed regardless of past results. Quite unexpected sources of artifactual toxicity will occur in the course of conducting an evaluation.

For some Phase I tests the corresponding blanks (treatments on the dilution water) do not provide completely relevant information concerning the effect of the manipulation on the effluent. For example, blanks of the graduated pH test (Section 8.9) are not particularly useful whether the pH is adjusted with acids, bases, or CO₂. The amount of the acid or CO₂ used to adjust and

maintain the same pH for an effluent sample and a blank are often radically different due to the differences in the buffering capacity of each of the solutions. Since the matrix of the effluent and dilution water are different, the pH in each solution will change at different rates during the toxicity tests. Therefore the blanks are not representative of what is occurring in the effluent test and the controls exposure does not provide information on the manipulation effect on the test organisms. The use of blanks for the other manipulation steps is relevant, and they provide information on cleanliness of the acids and bases added, the air system, filter apparatus, and SPE columns.

7.2 Test Species

Just as different analytical methods have different detection levels for the same chemical, different species have different sensitivities to the same toxicants. The major difference is that the toxicity measurement is non-specific to chemicals and so for an unknown mixture (effluent, sediment pore water) one must determine whether a different toxicity value for the sample is caused by the organisms different sensitivity to the same toxicant or to different toxicants.

The choice of species to use for the toxicity test can change the conclusion reached. In addition to the obvious need to use species of an appropriate size, age, availability, and adaptability to test conditions, there are other important considerations. An effluent toxic to two species, having equal or different LC50s may be toxic because of different toxicants. Differences of 1,000x in sensitivity are common and differences of 10,000x occur among species exposed to a single chemical. Anyone involved in identifying the cause of toxicity of an effluent will be concerned because someone has found the effluent toxic to some organism. If that is not the case, before a TIE is begun, one should determine to which organisms the toxicity concern is directed.

Many effluents will be received for TIEs because they have been found toxic to the cladocerans, *Ceriodaphnia* or *Daphnia*-species well suited to TIE methods. TIE test species selection is obvious in these instances. Where toxicity concern is based on species (trout or mysid shrimp), that are not going to be the TIE test species, one must demonstrate that the toxicity of concern has the same cause as the toxicity manifested by the species to be used in the TIE. The difficulty depends on the effluent characteristics (especially tox-

icity variability), the number of TIE steps which affect toxicity and the difference in sensitivity between the species being compared. Since this problem has not been one we have experienced frequently, our suggestions are certainly not all-inclusive. The final confirmation (Phase III) methods are designed to show whether the wrong toxicant was identified. However, many resources may be consumed before reaching that stage and earlier assurances should be obtained if reasonable, to save time and cost.

One approach is to compare the LC50 values of whole, unaltered effluent samples for the species originally raising the toxicity concern and the selected species for the TIE. If the acute toxicity varies similarly for each species among samples then there is evidence that the two species are responding to the same toxicant(s). If the LC50 values vary differently for the two species, there is evidence that the toxicants are different. If the LC50 values among samples do not vary more than the precision of the test method this approach is useless for that effluent. Successful application of this approach does not require equal sensitivity of the two species or the greatest toxicity of the TIE organism, but rather sensitivity of the species to the same toxicant.

If in Phase I, several steps (e.g., pH decrease, aeration, solid phase extraction) all changed toxicity, and if the direction and relative magnitude of change was the same for both test species, then there is evidence that both are sensitive to the same toxicant. If one or more parameters are different, the evidence is strong that the toxicants are different. This is not to say that if a Phase I technique completely removes toxicity to one species, it will remove it to the same extent for the other species. Because different species have dissimilar sensitivities to the same chemical, removal of 90% of a compound in an effluent sample may lead to a non-toxic concentration to one species while only reducing the toxicity to another species. If the Phase I procedures that successfully remove or reduce effluent toxicity differ by test species, it is unlikely that toxicity is caused by the same chemical(s).

Symptom comparisons are useful, especially if one is comparing similar organisms. Comparing fish symptoms to *Daphnia* symptoms could be very misleading but comparing symptoms of *Daphnia magna* to those of *Ceriodaphnia dubia* should be relatively safe. If one finds comparable symptoms, the evidence is not convincing because many toxicants cause specific symptoms but if symptoms are distinctly different, the evidence is strong that the toxicants are different. This is true only when symptoms are compared at effluent concentrations that are the same multiple of the LC50 for each species. For example, if two species have LC50 values of 10% and 90%, comparing symptoms at 100% concentrations could be misleading. At 100% effluent, the species with an LC50 of 10% might experience the symptoms so fast that their sensitivity would appear completely different from those of the less sen-

sitive species. Experience will reveal additional techniques that can be used.

Freshwater discharges to saline receiving water require separate considerations. Sea salts can be added to raise the salinity of the effluent (EPA, 1991B) enough so that marine species can be used in the TIE. However, the tolerances of marine organisms to the additives and effluent manipulations have not been determined. To do so is costly and time consuming and a more efficient method may be to use a freshwater species in Phase I and II. If this is done, data must be gathered to show that the freshwater species chosen is sufficiently sensitive and is responding to the same toxicant(s) as the marine species. The principles of doing this are the same as described above for different freshwater species. When Phase III is reached, marine species should be used, but in that phase, manipulations and additives are minimal and little ancillary data are needed in order to use marine species.

For discharges with conductivities comparable to brackish or marine water, caution is in order. Most methods for measuring "salinity" (conductivity or refraction) are non-specific for NaCl, which is the principal component of sea water. Marine organisms accomplish osmotic regulation by regulating sodium and chloride. If salinity of an effluent is not caused by NaCl, marine species may be stressed as much as freshwater species by high concentrations of other dissolved salts. Unless the "salinity" of an effluent is known to be caused by NaCl, marine species cannot be used to avoid the salinity effects.

7.3 Toxicity Test Procedures

The purpose of the toxicity test in Phase I is the same as that of any analytical method--to measure (detect) the presence of the toxicants. This use is quite different than conventional toxicity testing where the objective is to accurately and quantitatively measure the sensitivity of the organism to known concentrations of a chemical or effluent. For this latter purpose, removing stress (e.g., low DO) or other contaminants, and lack of space is important because such stresses may change the sensitivity of the organism to the contaminant of concern. In Phase I, relative sensitivity is used; that is, we compare whether one condition is more or less toxic than another but both may be toxic. Therefore, concern of documenting and/or removing other stresses is not very important. It is important to be sure that these other stresses are similar for each condition being compared, each time the manipulation and subsequent toxicity tests are performed.

The reason for this discussion under test methods is that effort must be made to make the tests used in Phase I as inexpensive as possible, because for some effluents, large numbers of tests may be needed. For example, we have used more than 100 tests on some effluents in Phase I. If the effort usually expended in measuring all the required water chemistries for a whole effluent test (EPA, 1985A) had been done for these

tests, the cost would have been prohibitive. The reader may wonder whether data collected from such tests can be trusted. Confidence in the data hinges on careful assurance that the stresses are similar among comparisons. For example, it does not matter if the test organisms are acclimated to a pH change. It does matter that stress from lack of acclimation to pH change occurs in each treatment compared.

Sometimes, in order to achieve desired chemical conditions, the stress from pH change cannot be made uniform. In these situations, only gross differences in response may be dependable. In some cases, erroneous conclusions will be reached. While these may cause wasted effort, the error should be found in Phase III. That is why, in Phase III, careful quality control must be exercised and cost saving shortcuts are not acceptable because one of the purposes of Phase III is to catch errors or artifacts that may occur in Phases I and II.

One need not use the standard acute methods (EPA, 1985A; 1991A) in Phase I for these reasons. The following mechanics of performing an acute test with cladocerans and newly hatched fathead minnows have been found by experience to be very cost effective and are offered as an aid to those doing Phase I testing. Specific volumes and sizes are used in this example for simplicity, but of course, these are varied depending on each test purpose.

For example, arrange a set of 12 plastic cups into six pairs. Fill 10 cups with 10 mL of dilution water using a disposable pipette. Add 10 mL of effluent to the two empty cups to make the high concentration, (e.g., 100%). Add 10 mL of effluent to the next pair of test cups (duplicates labeled A and B) already containing 10 mL each of the dilution water (Figure 7-1). The resulting concentration is 50%. From each cup of the 50% solution, transfer 10 mL to the third pair of test cups to produce the 25% concentration. Continue this process until sufficient exposure concentrations have been prepared. One pair of cups in the series contains only dilution water and serves as the control. Mixing the solutions prior to the transfer of each aliquot is very important. This can be accomplished by drawing the solution into the pipette and discharging it back into the cup several times prior to transfer. Additional mixing of test solutions should be done for experiments in which reagents such as sodium thiosulfate ($\text{Na}_2\text{S}_2\text{O}_3$) and EDTA (Phase I), or effluent methanol eluate concentrates (Phase I and II) are added to effluent or dilution water.

The need for duplicates will depend on the accuracy and precision required of the test results. Tests requiring a measure of accuracy in the form of confidence intervals (CIs) should be run in duplicate. Tests designed to provide only an indication of positive or

negative toxicity need not be run in duplicate. Beyond the initial and baseline effluent toxicity tests (Sections 8.1 and 8.2) which are designed to define effluent toxicity upon arrival in the laboratory and periodically during the TIE with each effluent sample testing, respectively, Phase I toxicity tests usually do not require duplicates.

The test organisms of uniform age should be placed at random in each test cup to insure valid results. Because the volume of test solution may be small, care must be taken to minimize the volume added during test organism transfer. If the volume of water transferred with the organism is reduced to a drop (50 μL), only five organisms are added to the test chamber and a 10 mL test volume is used, the resulting change in test solution volume will be 2.5%. Minimizing the change in volume is more critical as test solution volume is reduced. This is particularly important in the Phase II experiments, when limited volumes of effluent fraction concentrates are available. Care should also be taken to avoid chemical contamination between concentrations when test animals are being added.

We have stressed a relaxation of the usual water chemistry requirements in these Phase I tests because they are not as necessary here as they are in Phase III. However, sometimes, in order to maintain the desired conditions in the test (such as maintaining a specific pH) frequent specific repetitive measurements of those items will be necessary. The distinction drawn here is to avoid measurements you don't need (e.g., sample hardness) and concentrate on those that are important (e.g., pH). Effluents are often well buffered and pH sometimes will change quickly if equilibrium is not already established. POTW effluents are not in air equilibrium when discharged and as soon as they are exposed to air, the pH will rise. A typical POTW effluent pH is 7.2-7.4 when discharged but it will equilibrate after contact with air and may stabilize at 8.2-8.5. If pH is important to test interpretation, pH must be monitored throughout the test. It will also be important to decide what the initial pH (pH *i*) of the effluent is since the pH at the discharge and/or the initial pH may be different from the pH of the effluent at air equilibrium.

7.4 Test Endpoints

Little effort should be expended in calculating LC50 values for Phase I toxicity tests. There is no need to apply sophisticated and complex programs to the test results. Several methods for estimating the LC50 from the acute toxicity data are described in EPA (1985A), however a method which is most easily and quickly applied to the data should be used. In many cases, the graphical method entailing interpolation may prove to be the most convenient. Differences resulting from the choice of data analysis method should not impair the outcome of Phase I studies. Phase III tests may require more sophisticated analyses.

Toxic units (TU) have a special utility in some parts of a TIE. The TU of whole effluent is 100% divided by the LC50 of the effluent. For specific chemicals the TU

Figure 7-1. Schematic for preparing effluent test concentrations using simple dilution techniques. Two replicates are used for initial and baseline whole effluent toxicity test.

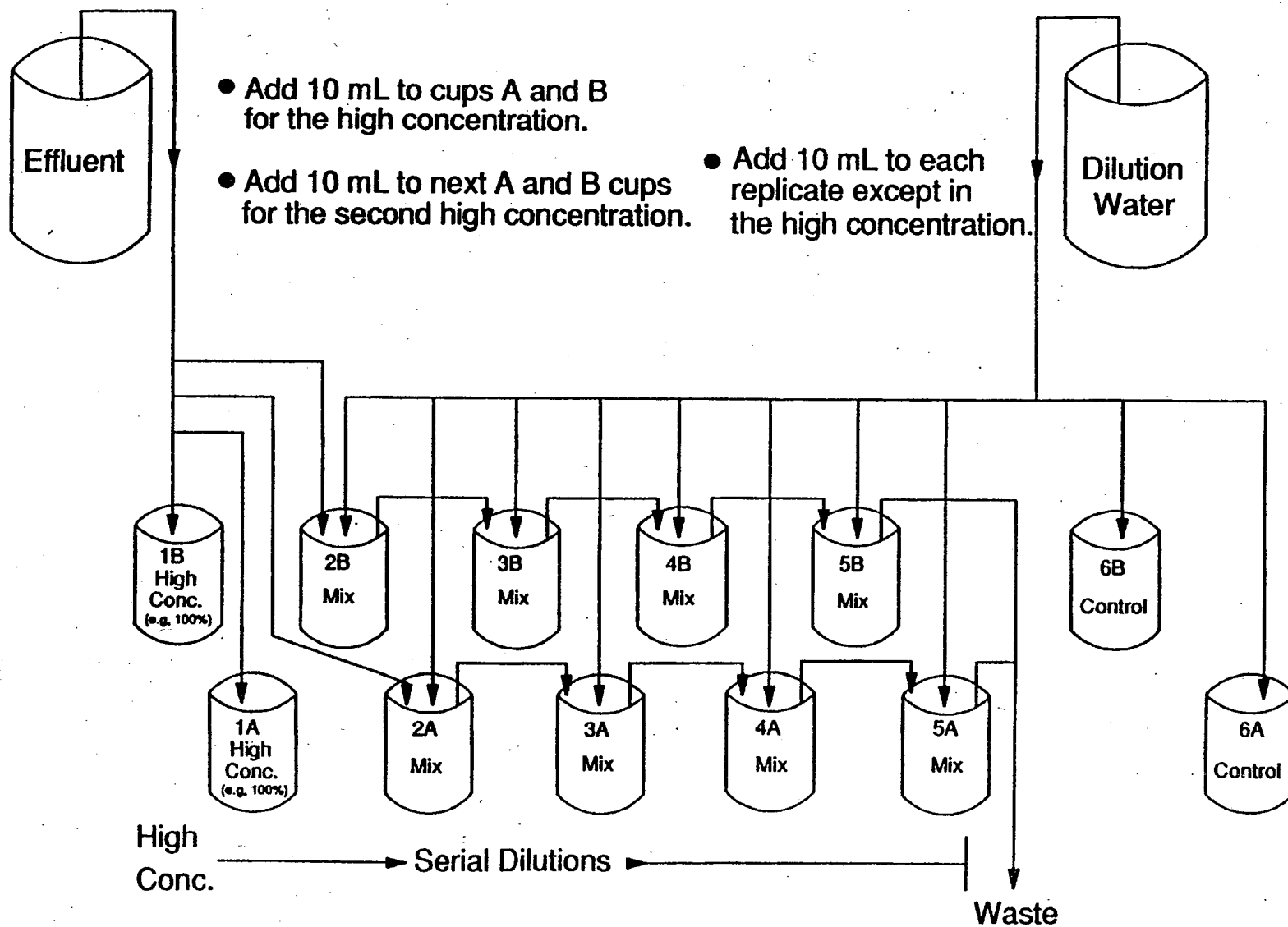

7-4

18778

is equal to the concentration of the compound present in the effluent divided by the LC50 of the compound (EPA, 1991B). For example, if the LC50 of an effluent is 25%, the effluent contains 4 TU (100/25). If the 48-h LC50 of compound A is 3 mg/L, a solution of 1 mg/L of this compound contains 0.33 TU. By normalizing the concentration term (such as the LC50) to a unit of toxicity, the TU allows the toxicity of effluents and/or chemicals to be "summed," provided that the test length and species used are the same in every test. This cannot be done using LC50s because chemicals and effluents each have different toxicity, and different concentrations each equal one LC50. Phase III contains more discussion about adding TUs; however one must be cautious in summing them. Unless it is known that the toxicants are strictly additive, simple summation of TUs will be incorrect.

7.5 Feeding

Most species used in acute tests are not fed during the test. However, the acute effluent manual (EPA, 1991B) has modified the effluent tests to allow cladocerans to be fed before test initiation. We routinely add food to all test waters (this includes the 100% effluent) for all *Ceriodaphnia* and *Daphnia* tests but only at the initiation of each test. This practice is standard in Phases I, II, and III. However, the decision to feed will be

species specific and dependent on the characteristics of the effluent. Consistency throughout each phase of the TIE is most important. All tolerance data for *Ceriodaphnia* given in Section 8 are based on tests in which animals were fed the yeast-cerophyll-trout food (YCT) mixture (EPA, 1989E; EPA, 1991C). The amount of YCT added was 66 μ L of YCT per 10 mL and 5 animals.

7.6 Multiple Species

A useful technique is to test two species together in the same test chamber (e.g., 1 oz. plastic cup). This is very beneficial in the initial toxicity test in order to select the most sensitive species for the Phase I tests or in situations where two species appear to be responding to toxicity of the effluent differently. This type of test also can be useful when conditions in tests with different organisms vary independently. For example, testing *C. dubia* and fathead minnows \leq 48 h old) together under the same pH conditions is very helpful in evaluating the role of ammonia in an effluent's toxicity. By testing the species together, the experimental conditions may change but both species experience identical fluctuations. We have tested the following sets of species together: *C. dubia* and fathead minnows, *C. dubia* and *D. magna*, and *C. dubia* and *D. pulex*.

Section 8

Phase I Toxicity Characterization Tests

The first phase of a TIE involves characterization of the toxic effluent. The characterization information gathered in Phase I forms the basis and direction for Phase II identification of the specific toxicants or may be useful for treatability evaluations. In Phase I, simple manipulations for toxicity removal or alteration are performed on the whole effluent. Acute toxicity tests utilizing aquatic organisms are used to determine whether the toxic chemicals have certain physical or chemical characteristics. Two objectives are accomplished during the toxicity characterization phase: a) the physical and chemical characteristics of the toxicant(s) are broadly defined and b) some information is gathered to indicate whether the toxicants are similar in effluent samples taken over time. Several patterns of Phase I results are indicative of certain toxicants (See Section 9.4) but otherwise Phase I only provides evidence of characteristics of groups of chemicals that may be the toxicants. This information can subsequently be used in the second phase of the study, either in the development of bench-scale wastewater treatment processes (EPA, 1989A; 1989B) or in choosing separation and analytical procedures for toxicant identification as described in Phase II.

The tests described in this section are designed primarily for acutely toxic effluents. Methods for chronic toxicity are being developed (EPA, 1991A). The methods in this section are based on the use of small test organisms such as daphnids (*Ceriodaphnia*, *Daphnia*) and newly hatched fish (fathead minnows). If larger species are used, modifications to these methods will have to be made.

Analysis of samples should begin as soon as practical following collection. Until experience is gained with the effluent, there is no way to predict how long samples can be stored before substantial changes in toxicity occur. In transit and in the laboratory, the bulk effluent should be held below 4°C and kept headspace free. Minimizing the headspace for samples shipped in glass is not practical. Once in the laboratory, testing on individual samples of each effluent may continue indefinitely, provided that whole effluent toxicity stabilizes. The degree of toxicity can remain similar, while the cause of toxicity may change with age. Especially in the early stages of the TIE, fresh samples should be used regardless of toxicant stability. The degree to which any single sample is analyzed should be weighed against the cost of the analyses and the probability that the sample is an adequate representation of typical

effluent. Obviously, when several samples show that a single class of compounds is responsible for effluent toxicity, Phase II procedures should be initiated.

Each of the characterization tests described in Section 8 is designed to change the toxicity of groups of constituents (Figure 8-1). Toxicity before and after the characterization treatment will indicate for which groups the toxicity was changed. All but one (initial toxicity test) of the characterization tests is performed at the same time in order to minimize confounding effects resulting from degradation of sample toxicity over time. While it is not critical that each characterization manipulation be performed at exactly the same time, the toxicity tests should be initiated at approximately the same time. If more than one species is used, the Phase I results must be interpreted separately for each because at this stage one cannot tell whether the same toxicant(s) is involved for all species.

Following receipt of the effluent sample, various steps to initiate Phase I are done (Table 8-1). Day 1 is when the sample arrives in the laboratory. On day 1, initial routine chemical measurements are taken for the effluent sample and an initial toxicity test is started on an aliquot of the sample. This LC50 is used to set the desired exposure concentrations for subsequent Phase I toxicity tests and is referred to as the "initial" toxicity test to distinguish it from the "baseline" toxicity test described below. Other aliquots of the sample are adjusted to pH 3 and 11, filtered, aerated and/or chromatographed using a C₁₈ SPE column. Following these manipulations, each effluent aliquot is readjusted to the initial pH (pH *i*) of the effluent. By pH *i*, we generally refer to the pH of the effluent at arrival in the laboratory, which may or may not be the pH of the effluent at air equilibrium. These aliquots and the remainder of the effluent are then covered to minimize evaporation and held at 4°C overnight. However, upon warming the solutions, supersaturation from dissolved gases might occur. If the test organism to be used is sensitive to supersaturation, then the supersaturation must be removed. Generally, *Ceriodaphnia* are not very "sensitive" to such situations, unlike newly hatched fathead minnows.

Delaying the majority of the toxicity testing until the next day (day 2) allows the test exposures to be set at concentrations bracketing the 24-h LC50 of the day 1 initial toxicity test. This procedure also allows pH adjusted effluent aliquots more time to stabilize, and additional pH adjustments can be made as necessary.

Figure 8-1. Overview of Phase I effluent characterization tests. (Note: pH *i* stands for Initial pH.)

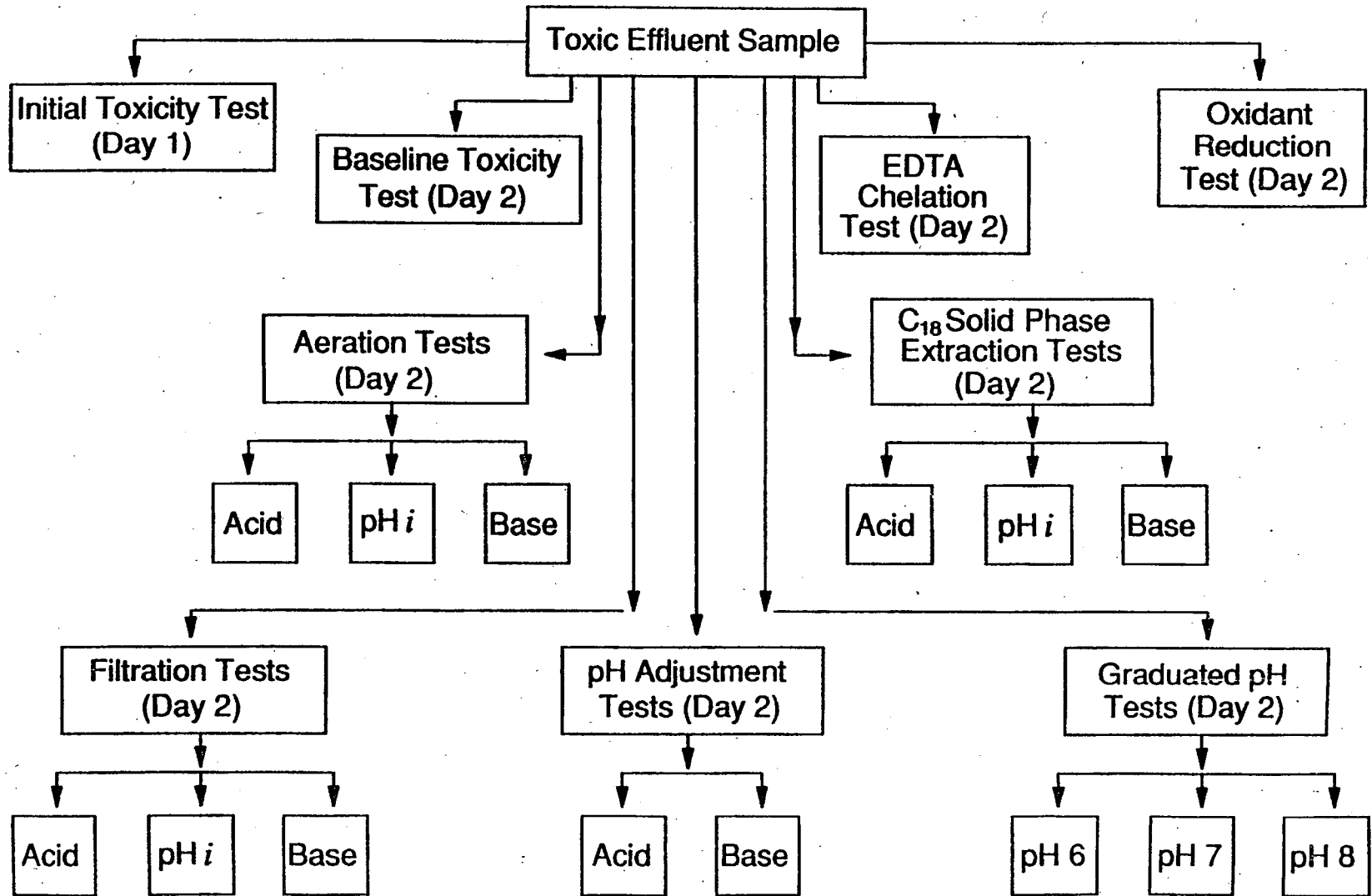

8-2

18782

Table 8-1. Outline of Phase I effluent manipulations

Description	Section
DAY 1 SAMPLE ARRIVAL:	
Chemical analyses	6.0
• pH	
• conductivity	
• total residual chlorine (TRC)	
• hardness	
• temperature	
• total ammonia	
• dissolved oxygen (DO)	
• alkalinity	
Initial toxicity test	8.1
Sample Manipulations ¹ :	8.3-8.9
• pH adjustment (pH 3, pH <i>i</i> , pH 11)	8.3
• pH adjustment/filtration	8.4
• pH adjustment/aeration	8.5
• pH adjustment/C ₁₈ solid phase extraction	8.6
DAY 2 TOXICITY TESTING:	
Warm effluent samples from day 1 and set-up toxicity tests ¹	
• baseline toxicity	8.2
• pH adjustment samples	8.3
• filtration samples	8.4
• aeration samples	8.5
• C ₁₈ solid phase extraction samples	8.6
• sodium thiosulfate addition samples	8.7
• EDTA addition samples	8.8
• graduated pH samples	8.9
Read 24-h mortality on initial toxicity test	8.1
DAYS 3 AND 4 MONITORING TESTS:	
Read 48 h mortality initial toxicity test	8.1
Read 24 h and 48 h mortality on tests from day 2	8.2-8.9

¹ These manipulations and toxicity tests can be performed on day 2 after the presence of toxicity has been confirmed; see text for details.

However, the manipulations can be performed and the test initiated the next day (day 2) rather than on sample arrival. This is useful when the toxicity of the effluent is unknown, and prevents conducting a Phase I on non-toxic samples. It is important that sufficient time is allowed so that the pH adjusted samples can stabilize at the pH *i*. The following sections assume the manipulations were made on day 1.

On the second day the aliquots of whole and manipulated effluent prepared on day 1 are diluted to 4x-, 2x-, 1x-, and 0.5x the 24-h LC50 of the effluent and subsequently tested for toxicity. This dilution series is used so that for highly toxic effluents, smaller changes in toxicity can be detected than would be the case if 100% effluent was used. (See Section 9 regarding multiple toxicants and this dilution series.) A whole effluent toxicity test is begun using unaltered effluent, now 24 h old. The result of this test (and subsequent whole effluent tests) is referred to as the "baseline" effluent LC50. Other toxicity tests involving the addition

of chelating or reducing agents and less severe pH adjustments are also conducted. For the EDTA addition test, the time needed for the EDTA to complex any metals present may be a function of the matrix of the effluent. Therefore, the addition of EDTA should be made first on day 2 and the sample held until all other manipulations are complete before introducing the test organisms (see Section 8.8 for details on EDTA test).

For one complete "Phase I" of a TIE as described in this section, there are nine categories of toxicity tests that are conducted. These are as follows: initial toxicity test, baseline test, pH adjustment test, pH adjustment/filtration test, pH adjustment/aeration tests, pH adjustment/C₁₈ SPE test, EDTA addition test, sodium thiosulfate addition test, and graduated pH test. Toxicity test results are read on subsequent testing days and depending on the outcome of the Phase I test series, additional toxicity tests designed to further define or confirm the nature of the toxicants are conducted.

For an experienced analyst the amount of time required to conduct the sample manipulation tasks scheduled for day 1 is about half of one day. If at 24 h, less than 50% mortality of test organisms exposed to the 100% day 1 effluent has occurred, the sample can be discarded and a new sample collected with relatively little loss of resources or time. For this reason, waiting to perform the manipulations on day 2 is useful. Alternatively, the test can be continued to 48, 72 or 96 h at which time the effluent may produce an LC50. In such cases, the baseline toxicity tests prepared on the second day (day 2) following sample arrival are set up at exposure levels of 100%, 50%, 25%, 12.5%, 6.25% effluent.

For a highly toxic effluent sample with rapidly degradable toxicants, it may be prudent to override the use of 4x-24-h LC50 treatment level and opt for conducting the Phase I using 100% effluent. These rapidly degradable compounds will be discovered only through periodic testing as the sample ages.

Several Phase I characterization tests are relatively broad in scope, intended to include more than one class of toxicant. Therefore, if a significant change in effluent toxicity is seen following these characterization procedures, additional tests are needed to further delineate the nature of the toxicity. The amount of testing beyond the initial characterization of the sample will depend on the stability of effluent toxicity, the nature of the toxicity, and previous Phase I results for the effluent (i.e., observed trends in the nature of the toxicity). A "significant reduction" in toxicity between aliquots of the day 2 whole effluent (baseline LC50) and treated effluent must be decided based upon the laboratory's test precision. Usually a change in the LC50 equal to one concentration interval can be considered significant but when precision is good smaller differences can be used. This suggestion is arbitrary and should not replace good judgement and experience. None of these tests by themselves are conclusive, so the danger of type I or type II errors is not great. Experience has

shown that for many effluents, at least one Phase I characterization test will be successful in substantially altering effluent toxicity. If not all toxicity is removed, other groups of toxicants (not addressed by Phase I procedures) may be present in the effluent or a single toxicant may be present in the effluent at such high concentrations that only partial toxicity removal is achieved. Additional testing to resolve these findings involves applying the successful Phase I test at a higher level (i.e., increased degradation time, increased aeration, larger C_{10} , SPE column volume, increased reagent concentrations).

Another outcome of the Phase I characterization test series may be that several tests succeed in partially removing effluent toxicity. In this situation, one may be dealing with several toxicants, each with different physical/chemical characteristics, or a single toxicant of such a nature as to be removed by more than one Phase I test. These results may be resolved by treating a single aliquot of the sample with all of the characterization tests that significantly reduced the baseline toxicity of the effluent. If effluent toxicity removal is enhanced as compared to the reduction provided by individual characterization tests, the sample may contain more than one type of toxicant. If the final toxicity removal at the end of the series of characterization tests is approximately the same as that provided by the most efficient single Phase I test, then it is likely that all of the test methods involved are successful in reducing the same toxicant to varying extents. This outcome is also suggested when one or more Phase I tests completely remove toxicity while some number of other tests partially reduce toxicity. Phase I tests overlap somewhat in their abilities to remove groups of toxicants. For example, increasing pH may cause a metal to precipitate and toxicity removed and EDTA may also remove toxicity. In any case, results of this nature are useful in selecting Phase II options. Use of multiple manipulations (Section 9.2) builds upon these principles. When several treatments are applied to the same sample, tests must be designed to ensure that toxicity does not result from the additives used (e.g., acid, base, EDTA) rather than from the effluent's toxicant(s).

The assumption must not be made that toxicants are either additive or synergistic. Our experience shows that independent action (one or more of multiple toxicants acting independently of the rest, as though the others were not present) is not uncommon in effluents. Experience also shows that one should not use selected tests to confirm a suspicion that a certain toxicant is the cause of toxicity. Time and again, this leads to wasted effort. There are so many possible causes of toxicity that such guesses are rarely helpful and more often channel one's thinking and delay the final solution. On the other hand, if one wants only to know whether a certain chemical is the toxicant, these tests can be selected to accomplish that goal. Frequently one needs to know whether the toxicity is due to ammonia or whether there are toxicants present other than salt. These questions are quite different from the

former case where one is playing the "I'll bet you the toxicant is..." game.

No Phase I characterization test should be dropped from use on the basis that the toxicants it is designed to address are not likely to be present in the effluent. In excluding any Phase I test, the analyst may be limiting the information that can be gained on effluent toxicants. The investigator should approach effluent characterization without a preconceived notion as to the cause of toxicity.

There are two types of checks that can be used to detect artifact toxicity. A "toxicity blank" consists of performing the same (Phase I) test on dilution water and measuring to determine whether any toxicity is added by the test procedure. However, a toxicity blank does poorly in identifying artifact toxicity if toxicity is affected by the effluents' matrix (cf., Section 7.1). For example, the toxicity of the Phase I reagent, EDTA, may be completely different in dilution water and in effluent. If so, a toxicity blank is inappropriate for the chelation test. A "toxicity control", for many Phase I steps involves a comparison of the toxicity of the manipulated test solution and the baseline effluent toxicity. In this case, the comparison must demonstrate that the manipulated effluent test solution has not become more toxic than the unaltered effluent (baseline test). If it has, the test procedure has produced artifactual toxicity. The "toxicity control" for the pH adjustment/ C_{10} test is the filtered effluent sample at the respective pH. For some treatments, valid toxicity blanks or toxicity controls cannot be made. The use of toxicity blanks and toxicity controls still requires the use of "regular" controls, which are always included to determine the performance of the test organism and dilution water. Dilution water blanks for the EDTA addition test, sodium thiosulfate addition test, and the graduated pH test are not relevant (see Section 7.1 for more information).

No procedure should be assumed to be free of artifactual toxicity. Many of the Phase I toxicity tests involve relatively severe or unorthodox effluent manipulations. Toxicity blanks and toxicity controls must be used consistently and conscientiously to detect the introduction of toxic artifacts or other changes to the effluent that increase sample toxicity.

For the following sections, the guidance for the volumes required, apparatus, and test organisms is based on test conditions using *Ceriodaphnia*, *Daphnia* and/or larval fathead minnows exposed in 10 mL test volumes.

8.1 Initial Effluent Toxicity Test

Principles/General Discussion:

The major purpose of the "initial" effluent test is to provide an estimate of the 24-h LC50 for purposes of setting exposure concentrations in Phase I tests.

Volume Required:

Initial toxicity test is performed in duplicate using 40 mL of effluent.

Apparatus:

Disposable 1 oz plastic cups or 30 mL glass beakers, automatic pipette, disposable pipette tips, eye dropper or wide bore pipette, light box and/or microscope (optional).

Test Organisms:

Test organisms, 60 or more, of the same age and species.

Procedure:

Day 1: A concentration series using 10 mL in duplicate of 100%, 50%, 25%, 12.5%, 6.25% effluent, and a control will suffice for most effluents. Obviously more toxic effluents will require a lower range. If nothing is known about the toxicity, more concentrations should be included. A sample data sheet for the initial test is shown in Figure 8-2.

8.2 Baseline Effluent Toxicity Test

Principles/General Discussion:

In order to determine the effects that the various Phase I characterization tests have on effluent toxicity, the toxicity of the effluent sample, prior to any treatment in the laboratory, must be determined. The portion of the effluent sample, tested for toxicity the day after it arrives in the laboratory (day 2), will be referred to as the "baseline test". The baseline effluent test LC50 will be compared to results of toxicity tests initiated on day 2 on aliquots of the effluent carried through the characterization tests. Such a comparison will demonstrate whether the removal or alteration of various groups of toxicants changes the effluent toxicity. By comparing these results, an indication of the physical/chemical nature of the toxicants can be obtained. If the baseline effluent test LC50 is substantially different from the toxicity of the effluent when it arrived in the laboratory (initial toxicity), one must decide whether the schedule suggested in these methods should be revised to reduce a delay in testing.

When Phase I testing is extended to additional days, baseline tests must be done each time on succeeding days, and used for comparison to these additional manipulation tests.

Volume Required:

The baseline toxicity test is performed in duplicate. The total volume necessary will depend on the 24-h LC50 of the day 1 initial effluent test, but 80 mL should be adequate.

Apparatus:

Disposable 1 oz plastic cups or 30 mL glass beakers, automatic pipette, disposable pipette tips, eye dropper or wide bore pipette, light box and/or microscope (optional).

Test Organisms:

Test organisms, 60 or more, of the same age and species.

Procedure:

Day 2: Two concentration series will be used in duplicate for the static acute toxicity test. In preparing the test solutions for the day 2 baseline test, any obvious physical changes (e.g., formation of precipitates, odors), which occurred during storage, should be noted.

The first test series will have exposure levels based on the 24-h LC50 of the initial (day 1) toxicity and will include day 2 effluent concentrations at 4x-, 2x-, 1x, and 0.5x- the 24-h LC50. In this case, the method for making dilutions described earlier may need to be changed slightly. Most of the toxicity tests with the characterization solutions will also be performed using these same exposure concentrations. If the 24-h LC50 of the initial effluent is greater than 25%, the series obviously begins at 100%, and includes four exposure concentrations. Of course, if the 24-h LC50 of the day 1 initial effluent is greater than or equal to 25%, the second series will be unnecessary because this test fulfills the requirements for comparison to the initial effluent test and characterization solution toxicity test results.

The second test series will provide exposures at effluent dilutions of 100%, 50%, 25%, 12.5% and 6.25% (and lower dilutions as appropriate if the effluent is more toxic). This series will enable a comparison of the results of the baseline (day 2) test to the initial effluent LC50 (cf., Section 8.1).

A sample data sheet is shown in Figure 8-3. In order to compare the baseline toxicity and the toxicity of the effluent aliquots subjected to characterization tests, all of the day 2 toxicity tests should have the test organisms added to test solutions at approximately the same time.

The baseline toxicity test (toxicity control) must be repeated each time additional characterization tests are performed on the sample after the initial Phase I battery of tests. The baseline test will serve as the basis for determining the effects produced by the additional characterization tests, and will also provide information on the degradation of sample toxicity. For effluents whose initial toxicity is low (i.e., LC50 ~60-70%) and where the baseline toxicity is greatly changed compared to the initial toxicity of the sample, it may be advisable to discard the remaining sample and collect a fresh one.

Interferences/Controls and Blanks:

The control treatment of animals in unaltered dilution water in this test is used for comparison to several subsequent tests and provides an important reference for diluent water and organism acceptability. Mortality in these controls will negate other work.

Results/Subsequent Tests:

Baseline LC50's should be generated for as long as the effluent sample is being used and a baseline test (toxicity control) should be started every time the

Figure 8-2. Example data sheet for Initial effluent toxicity test.

Test Type: <i>Initial Effluent</i> Test Initiation (Date & Time): _____ Investigator: _____ Sample Log No., Name: _____ Date of Collection: _____	Species/Age: _____ No. Animals/No. Reps: _____ Source of Animals: _____ Dilution Water/Control: _____ Test Volume: _____ Other Info: _____
---	---

Conc. (% Effluent)	0 h pH	Survival Readings:							
		24 h		48 h		72 h		96 h	
		A	B	A	B	A	B	A	B
		pH DO		pH DO		pH DO		pH DO	
<i>100</i>									
<i>50</i>									
<i>25</i>									
<i>12.5</i>									
<i>6.25</i>									
<i>Control</i>									
		LC50 ____ CI ____	LC50 ____ CI ____	LC50 ____ CI ____	LC50 ____ CI ____	LC50 ____ CI ____	LC50 ____ CI ____	LC50 ____ CI ____	LC50 ____ CI ____

Comments:

Figure 8-3. Example data sheet for baseline effluent toxicity test.

Test Type: Baseline Effluent Test Initiation (Date & Time): _____ Investigator: _____ Sample Log No., Name: _____ Date of Collection: _____	Species/Age: _____ No. Animals/No. Reps: _____ Source of Animals: _____ Dilution Water/Control: _____ Test Volume: _____ Other Info: _____
--	---

	Conc. (% Effluent)	0 h pH	Survival Readings:											
			24 h			48 h			72 h			96 h		
			A	B	DO	A	B	DO	A	B	DO	A	B	DO
(Series One)	4x-LC50/													
	2x-LC50/													
	1x-LC50/													
	0.5x-LC50/													
	Control													
	100													
	50													
(Series Two)	25													
	12.5													
	6.25													
			LC50	____	LC50	____	LC50	____	LC50	____	LC50	____	LC50	____
			CI	____	CI	____	CI	____	CI	____	CI	____	CI	____

Comments:

effluent sample is put through any characterization steps. (Note: similar procedures should be followed in Phases II and III.)

8.3 pH Adjustment Test

Principles/General Discussion:

The pH has a substantial effect on the toxicity of many compounds found in effluents. Therefore pH adjustment is used throughout Phase I to provide more information on the nature of the toxicants. Changes in pH can affect the solubility, polarity, volatility, stability and speciation of a compound, thereby affecting its bioavailability as well as its toxicity. Before describing the pH adjustment test, some discussion on the effect of pH on various groups of compounds is warranted.

Two major groups of compounds significantly impacted by solution pH are acids and bases. To understand how organic and inorganic compounds of this type are affected by pH changes, one must have a basic understanding of the thermodynamic equilibrium acidity constant, K_a , for the proton transfer reaction:

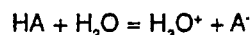

$$K_a = \frac{[A^-][H^+]}{[HA]}$$

H⁺: H₃O⁺

HA: protonated acid

K_a : thermodynamic equilibrium constant for the acid

For example:

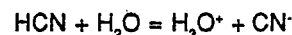

$$K_a = \frac{[CN^-][H^+]}{[HCN]} = 6.0 \times 10^{-10}$$

The stronger the acid (i.e., the more it tends to dissociate into its ionic state), the greater the value of K_a , and the smaller the $-\log_{10} K_a$ or pK_a . In effect, the above reaction is shifted to the right for acidic compounds. For acids in water, when the pH of the solution equals the pK_a of the compound, equivalent amounts of the compound will exist in the ionized (A⁻) and un-ionized (HA) forms. At a pH one unit lower than the pK_a of the acid, approximately 90% of the compound will be in the un-ionized form with the remainder in the ionized form. A solution pH two units below the acid's pK_a will result in 99% in the un-ionized form and 1% in the ionized form. Likewise, at one pH unit above the pK_a , 90% of the acid will be present in the dissociated (ionized) form and 10% present in the un-ionized form; at two pH units above the pK_a , 99% of the acid is in the dissociated form while, 1% is present in the un-ionized form. For example, at pH 4.2, the pK_a of benzoic acid, 50% of the compound is present as C₆H₅COOH and 50% is present as C₆H₅COO⁻, H⁺. At pH 3.2, this ratio shifts to roughly 90% C₆H₅COOH:10% C₆H₅COO⁻, H⁺ while at 5.2 the ratio nears 10% C₆H₅COOH to 90% C₆H₅COO⁻, H⁺.

This relationship generally holds for diprotic and triprotic acids (i.e., acids with two and three H atoms, respectively, that can dissociate from the molecule). This trend is not followed by multiprotic acids with pK_a 's less than three units apart (e.g., H₃BO₃ with pK_{a1} =13.8 and pK_{a2} =12.74). The amount of each dissociated species in such cases will not always follow the 90/10, 99/1 rule stated above. For example, H₃BO₃, H₂BO₃⁻, and HBO₃²⁻ will be present at pH 13.5.

Basic compounds function in a similar fashion.

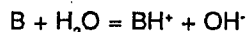

$$K_b = \frac{[BH^+][OH^-]}{[B]}$$

B: unprotonated base

K_b : thermodynamic equilibrium constant for the base

For example:

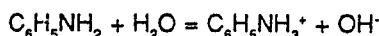

$$K_b = \frac{[C_6H_5NH_3^+][OH^-]}{[C_6H_5NH_2]} = 4.2 \times 10^{-10}$$

In the above reaction, BH⁺ can be considered the "conjugate acid of the base", that is, the protonated form of the base. Thus, the same reaction can be expressed as follows:

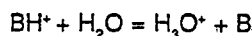

$$K_b = \frac{[H^+][B]}{[BH^+]}$$

Note: $pK_a + pK_b = 14$

For example:

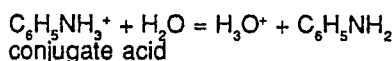

$$K_a = \frac{[H^+][C_6H_5NH_2]}{[C_6H_5NH_3^+]} = 2.34 \times 10^{-5}$$

This convention can be used to simplify dealing with equilibrium constants for acids and bases.

As with acids, when the solution pH is equal to the pK_a of the conjugate acid of a base, equal amounts of the base will exist in the ionized and un-ionized forms. For example, ammonia in an aqueous solution at pH 9.25 (the pK_a of ammonia) will be found as 50% NH₄⁺ and 50% NH₃. At one pH unit above the pK_a (i.e., 10.25) roughly 90% of the ammonia will be in the un-ionized form (NH₃) and the remainder will be in the NH₄⁺ form. At pH 8.25, one unit below the pK_a of ammonia, approximately 90% of the ammonia will be in the NH₄⁺ form, and approximately 10% will be in the NH₃ form.

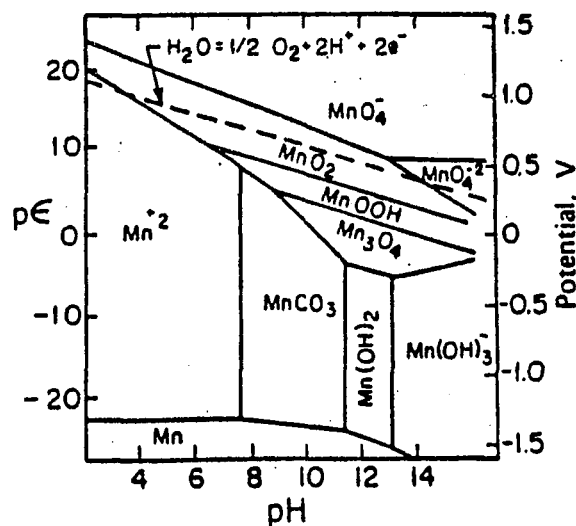

Figure 8-4. pE-pH diagram for the CO_2 , H_2O , and Mn-CO_2 systems (25°C). Solid phases considered: Mn(OH)_2 (s) (pyrochroite), MnCO_3 (s) (rhodochrosite), Mn_3O_4 (s) (hausmannite), $\gamma\text{-MnOOH}$ (manganite), $\gamma\text{-MnO}_2$ (nsutite). (Reprinted with permission from Stumm & Morgan, 1981.)

The above can be summarized by the following:

	Predominant Species	
	Organic	Inorganic
pH > pK, acid	RCOO^- , RCO^-	A^-
base	RNH_2	B
pH < pK, acid	RCOOH , RCOH	HA
base	RNH_3^+	BH^+

R = aliphatic or aromatic group

The effect of pH on the ratio of the ionized and un-ionized forms of acids and bases has a number of impacts on Phase I results. First, compounds may be more toxic in the un-ionized form as compared to the ionized form. For example, un-ionized ammonia (NH_3) is generally recognized as the toxic form of ammonia while total ammonia (NH_4^+) is of far less concern (EPA, 1985B). A second implication of this effect relates to toxicant solubility. Un-ionized forms of acids and bases can be considered less polar than their ionized forms, which interact to a greater extent with water molecules. Consequently, un-ionized forms of acids and bases can be more easily stripped from water using aeration (Section 8.5) or extraction with non-polar solvents or solid

phase column techniques (Section 8.6). Likewise, changes in compound solubility with pH change may mediate removal through filtration (Section 8.4).

Another implication of the pH effect involves metal ion complexes. An example of how pH can alter the form of a metal in a natural water system is shown in Figure 8-4. Given a pE (the equilibrium electron activity—in a simple sense, whether the system is aerobic or anaerobic), one can see how various forms of manganese are created and eliminated as pH shifts.

Each of the different forms of a metal will be manifested differently in aquatic organism effects. Some forms of the metal will be relatively insoluble; these forms may not affect toxicity. Likewise, as with acids and bases, the toxicity of the soluble forms of the metal will be a function of the actual species present (e.g., the LC50 of Mn^{2+} as compared to the LC50 of MnO_4^{2-}). The actual species formed will depend, in addition to pH and pE on the other chemical constituents present in the water. The hydrolysis rate of organics is greatly affected by pH, and pH changes may also alter organic toxicity.

Regardless of the speciation effect on toxicity, changes in solution pH may affect the toxicity of any given compound. The pH of the test solution may affect

membrane permeability at the cell membrane as well as the chemistry of the toxicant. One might expect that changing the pH, only to return it to its original pH in a short time, would not alter toxicity. Experience shows that this is not the case and that this adjustment sometimes results in reduction, loss or increase in toxicity. If the kinetics of the pH driven reaction (on return to the original effluent pH) are slow or irreversible, pH adjustment alone may be effective in evidencing toxicants affected by pH change. Some organics may also degrade due to pH change.

Another purpose of the pH adjustment test is to provide blanks (with both dilution water and effluent) for subsequent Phase I pH adjustment tests performed in combination with other operations. This test will demonstrate whether toxic concentrations of ions have been reached as a result of the addition of acid and base or whether the reagent solutions are contaminated.

Comparable results for toxicity blanks are not obtained when the same volumes and same strengths of acids and bases are added to the effluent. Effluents already contain substantial concentrations of major anions and cations that are not found in dilution water. Further, the volumes and strengths of the acid and base necessary, for example, to lower an effluent with a pH_i of 7.6 to pH 3 and raise it back to pH 7.6, are not likely to result in the same final pH when added to dilution water. However, it is necessary to conduct pH adjustment blanks to determine the cleanliness of the acid and base solutions used for the pH manipulations.

Volume Required:

To make pH adjustments, 680 mL of whole effluent is needed to have enough effluent for the four exposure concentrations at each of the three pH's. A 300 mL aliquot of the day 1 effluent sample is raised to pH 11, and the second 300 mL sample is lowered to pH 3. An aliquot of the pH_i effluent (used for the baseline test; 80 mL) is set aside for the duration of the manipulation (Figure 8-5). Approximately 30 mL will be needed for the pH adjustment test but the actual amount depends on the 24-h LC50 of the initial effluent test. The remaining 270 mL of each of these solutions is reserved for the "pH adjustment/filtration", "pH adjustment/aeration" and "pH adjustment/ C_{18} SPE" Phase I tests.

These pH adjustments must also be done using dilution water for toxicity blanks for each test. To make these adjustments, approximately 295 mL of dilution water will provide enough (and an excess) to test the blanks with one exposure level and one replicate. One aliquot of 105 mL is adjusted to pH 3 and another 105 mL is adjusted to pH 11. Only 10 mL is needed for the pH adjustment blanks but excess (~10 mL) is included. The pH_i dilution water blank is the control of the baseline test. The remaining 85 mL of pH adjusted and 85 mL of pH_i dilution water are used for the "pH adjustment/filtration", "pH adjustment/aeration" and "pH adjustment/ C_{18} SPE" toxicity blanks.

Apparatus:

Six glass stoppered bottles for acid and base solutions, pH meter and probe, 2-500 mL beakers, 2-500 mL graduated cylinders, 30 mL beakers or 1 oz plastic cups, stir plate, and stir bars (perfluorocarbon), automatic pipette, disposable pipette tips, eye dropper or wide bore pipette, light box and/or microscope (optional).

Reagents:

1.0, 0.1 and 0.01 N NaOH, 1.0, 0.1 and 0.01 N HCL (ACS grade in high purity water) and buffers for pH meter calibration.

Test Organisms:

Test organisms, 40 or more, of the same age and species.

Procedure:

Day 1: The general procedure for the pH adjustment test is shown in Figure 8-5.

Blank Preparation: The first step is to prepare the dilution blanks. These blanks are used as the controls for the other dilution water pH adjustment tests of aeration, filtration, and C_{18} SPE separation as well as to determine whether the acid or base solutions are contaminated. The pH_i blank is the control while the pH 3 or pH 11 adjustment blanks are treated in the manner described below under sample preparation.

Sample Preparation: Stirring constantly, 1.0 N NaOH is added dropwise to a 300 mL aliquot day 1 effluent until the solution pH nears 11. (Note: overshooting results in the addition of more salts and a volume change and should be avoided.) In order to minimize any over-adjustment of the pH, 0.1 N NaOH is added dropwise in the latter stages to bring the effluent aliquot to pH 11. The solution should be allowed to equilibrate after each incremental addition of base. The amount of time necessary for pH equilibration will depend on the buffering capacity of the effluent. Caution should be taken to prevent any solution pH of greater than 11. If pH 11 is exceeded, 0.1 N HCl must be used to lower the pH to 11. The goal of the pH adjustment step is to reach pH 11, while minimizing both the change in aliquot volume and the increase in ionic strength. Volumes and strengths of base (and any acid added) should be recorded. A 30 mL volume of effluent and dilution water is held for the same length of time it takes to complete other Phase I manipulations with pH 11 effluent.

Once other manipulation work has been completed with the total volume of the pH 11 effluent, the 30 mL volume at pH 11 is returned to the initial pH (pH_i) of the day 1 effluent. (The other aliquots of pH 11 effluent are also returned to pH_i at this time.) This is accomplished by the slow, dropwise addition of 0.1 N HCl first and later 0.01 N HCL as the pH of the stirred solution nears pH_i . If pH_i is exceeded, the pH must be appropriately increased with 0.01 N NaOH. Again, the

Figure 8-5. Flow chart for pH adjustment tests.

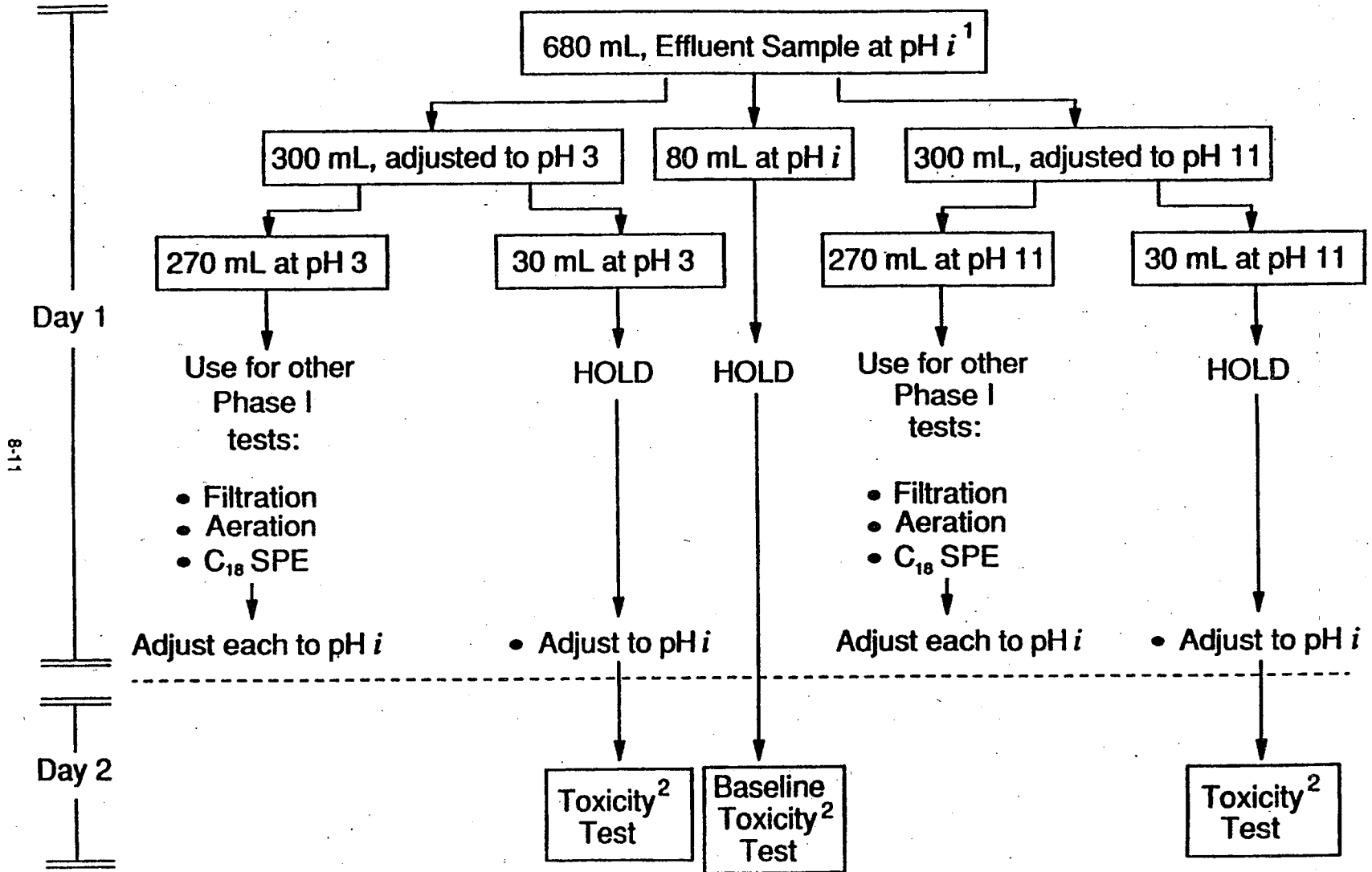

¹ All steps are conducted on dilution water to prepare toxicity blanks for testing but less volume is needed.

² Same test as depicted in Figure 8-10.

volumes and strengths of acid and any base added should be recorded.

The pH of the solution should be checked periodically throughout the remainder of the work day and readjusted as necessary. Changes in the total volume of acids and bases added should be recorded.

This procedure is repeated, except the pH is lowered to pH 3 using the second 300 mL aliquot of effluent, and 1.0 N and 0.1 N HCl. As with the pH 11 effluent, 270 mL of the pH 3 effluent is used for the pH adjustment/aeration, pH adjustment/filtration, and pH adjustment/C₁₈ SPE tests. The remaining 30 mL of the pH 3 effluent is held until all of the work on all of the pH 3 effluent has been completed. At this point, the pH of the 30 mL volume of pH 3 effluent is readjusted to pH *i* by the dropwise addition of 0.1 N and 0.01 N NaOH. Maintenance of pH *i* must be assured through checking and readjusting the sample periodically throughout the work day. All volumes and strengths of acid and base added should be recorded.

Day 2: At the beginning of the work day (the day after the arrival of the effluent in the laboratory), the pH of both of the 30 mL volumes is again checked to ensure that pH *i* has been maintained. Any additional pH adjustments are made and the volumes of the acid and/or base added are recorded. The acute toxicity of each pH-adjusted solution is tested at 4x-, 2x-, 1x-, 0.5x-LC50 (the 24-h initial LC50) as described in Section 7. Test solution pH should be measured, in all exposure concentrations and recorded at least every 24 h. A sample data sheet is shown in Figure 8-6.

Interferences/Controls and Blanks:

Controls prepared for the baseline toxicity test also act as a check on the organisms, dilution water, and test chambers for this test.

The baseline effluent test acts as a control for the pH adjustment test, indicating whether the addition of NaCl in the form of the acid and base has increased effluent toxicity. This pH adjustment test acts as the control for other Phase I tests entailing pH adjustment. In addition to serving as a control for other pH adjustment tests, increased toxicity following pH adjustment, not as a result of NaCl concentration, indicates a pH effect on toxicity or contamination of acids or bases (see below).

Results/Subsequent Tests:

If either the pH 3 or pH 11 adjustment effluent tests have significantly greater toxicity than the baseline effluent test, two possible sources of toxicity exist: 1) the ions (Na⁺, Cl⁻) added by the acid and base have resulted in a solution with an ionic strength intolerable to the test organism; or 2) chemical reactions driven by the pH change have not reversed upon readjusting to pH *i*. Neither of these phenomena would be detected through the use of a blank (dilution water). To help resolve this situation, the NaCl LC50 values for common test organisms are provided in Table 8-2. The minimum concentration of NaCl in the test solution (i.e.,

not including the concentration of NaCl originally present in the effluent) can be calculated from the volumes and strengths of the acid and base added and final solution volume. The data in the table can be used only as a rough guide, however, because the toxicity of sodium chloride depends on the other anions and cations as well as the total osmotic pressure exerted by the dissolved substances. The toxicity of the added NaCl is best determined by adding that amount of NaCl directly to the effluent and to see if the addition increased effluent toxicity.

If either the pH 3 and/or pH 11 adjustment tests indicate a significant decrease in effluent toxicity, it could result from volume changes by acid and base additions or from chemical reactions driven by the pH change that may not have been re-established or are irreversible. To determine if the addition of acid or base diluted the sample due to their volume addition, add a volume of dilution water equivalent to the total volume of acid and base originally added to the effluent volume. If a similar loss of toxicity in the diluted wastewater occurs, the pH adjustment test should be repeated using more concentrated acid and base solutions.

A reduction or loss of toxicity may also be the result of the degradation of toxicant at the altered pH values. In some cases, the toxicity could also be increased if the degradation product is more toxic than the original compound. Both organics and inorganics can be so changed with a probable loss in toxicity. Inorganic and organic substances may precipitate during the process of pH adjustment. The precipitated chemical may or may not be the toxicant. The precipitated chemical (which most often forms with the pH 11 adjustment) removes from solution via the flocculation process, suspended solids, microbial growth, and colloids, and via the adsorption process, metals and organics. If the process of precipitation seems to remove toxicity, it is important to realize that the precipitating chemical might not be the toxicant, but rather that the toxicant(s) may have been removed by the flocculation and/or adsorption processes. In some cases, the precipitate may dissolve with the adjustment of the effluent back to pH *i*. The removal of toxicity when dissolution of the precipitate occurs should be evaluated carefully since the toxicant(s) might be unavailable and/or not completely dissolved.

For most of the Phase I combination pH adjustment tests (i.e., pH adjustment/filtration), the pH adjustment test will act as an equivalent or "worst case" toxicity control for changes in test solution ionic strength and volume. In effect, most of the operations applied to the pH adjusted effluent in the following Sections (8.4-8.6) will either not affect pH or will drive it closer to the pH *i*. This may not be the case for the pH adjustment/aeration test, however. Because pH 3 and pH 11 must be maintained throughout the aeration process and because the loss of volatiles may result in pH shifts towards pH *i*, more acid and/or base may be added to these test solutions as compared to the pH adjustment only solutions.

Figure 8-6. Example data sheet for pH adjustment test.

Test Type: <i>pH Adjustment</i> Test Initiation (Date & Time): _____ Investigator: _____ Sample Log No., Name: _____ Date of Collection: _____	Species/Age: _____ No. Animals/No. Reps: _____ Source of Animals: _____ Dilution Water/Control: _____ Test Volume: _____ Other Info: _____
---	---

pH/Concentration (% pH adjusted effluent)	0 h pH	Survival Readings:									
		24 h		48 h		72 h		96 h			
		A	DO	A	DO	A	DO	A	DO		
<i>3/4x-LC50</i>											
<i>3/2x-LC50</i>											
<i>3/1x-LC50</i>											
<i>3/0.5x-LC50</i>											
<i>3/blank</i>											
<i>pH i/blank</i>											
<i>11/4x-LC50</i>											
<i>11/2x-LC50</i>											
<i>11/1x-LC50</i>											
<i>11/0.5x-LC50</i>											
<i>11/blank</i>											
		LC50	___	LC50	___	LC50	___	LC50	___		

Note: See baseline data sheet for control data.

Volumes and Strength of Solutions Added:
 HCl NaOH

300 mL pH 3		
300 mL pH 11		
30 mL pH 3		
30 mL pH 11		

Comments:

Table 8-2. Acute toxicity of sodium chloride to selected aquatic organisms

Species	Water Type	Life-stage	LC50 (g/L) (95% CI)			
			24 h	48 h	72 h	96 h
<i>Ceriodaphnia dubia</i>	SRW ^{1,2}	≤24 h	4.2 (—)	2.3 (2.0-2.6)		
	SRW ^{1,2}	≤24 h	3.3 (—)	2.7 (—)		
	SRW ^{1,2}	≤24 h	3.0 (—)	2.1 (—)		
	SRW ^{1,2}	≤24 h	2.3 (2.0-2.6)	2.3 (2.0-2.6)		
	VHRW ^{1,2}	≤24 h	2.8 (—)	2.8 (—)		
<i>Daphnia magna</i>	LSW ^{2,3}	NR	3.3 (NR)	3.1 (NR)		
	RW ^{2,3}	NR	6.4 (NR)	5.9 (NR)		
<i>Pimephales promelas</i>	SRW ^{2,4}	≤24 h	7.9 (7.0-9.0)	7.9 (7.0-9.0)	6.9 (5.5-8.7)	4.6 (3.3-6.2)
	SRW ^{2,4}	≤24 h	5.3 (4.8-5.8)	4.9 (4.3-5.6)	4.6 (4.0-5.3)	3.5 (2.8-4.3)
	SRW ^{2,5}	11 wk	7.9 (NR)	NR	NR	7.7 (7.4-7.9)
	VHRW ^{2,4}	≤24 h	8.0 (—)	5.2 (4.2-6.6)	4.2 (3.3-5.2)	3.7 (2.9-4.7)
<i>Lepomis macrochirus</i>	SRW ⁶	1-9 g	NR	NR	NR	12.9 (NR)

¹ Data generated at ERL-Duluth. *C. dubia* were ≤24 h old at test initiation and fed. Water used was soft reconstituted water (diluted mineral water (DMW)).

² Static, unmeasured test.

³ Dowden and Bennett, 1965.

⁴ Data generated at ERL-Duluth and values represent those from 7-d fathead minnow growth and survival tests and daily renewals.

⁵ Adelman et al., 1976.

⁶ Patrick et al., 1968.

Note: (—) = Confidence interval cannot be calculated as no partial mortality occurred. NR = Not reported; SRW = soft reconstituted water; VHRW = very hard reconstituted water; RW = reconstituted water; LSW = Lake Superior water.

There is another factor which must be considered when carrying out pH adjustment tests. In those manipulations where the pH is changed to pH 3 or pH 11 and then readjusted to pH *i*, the pH may tend to drift over the course of the 48-h or 96-h toxicity tests. The drift can be very dissimilar among test manipulations. This is likely to occur even though the starting pH's (of samples readjusted to pH *i*) may be similar. This can lead to confusion in interpreting Phase I results if a compound whose toxicity is pH dependent is present in the sample. An example of a manipulation in which this effect is encountered routinely is the pH 3 adjustment/aeration test (Section 8.5). For instance, an aliquot of an effluent with a pH *i* of 7.5 is adjusted to pH 3 and is kept at that pH while the other manipulations are conducted. This pH 3 adjusted sample serves as a control for the pH 3 adjustments. Another portion of the pH 3 adjusted effluent is aerated (Section 8.5). Both aliquots are then readjusted to pH *i* (7.5) prior to toxicity testing. The pH of the pH 3 adjustment/aeration test solution will probably not behave in a similar manner to the baseline or pH 3 adjustment test. We have observed the pH in this test to go unchanged or drift downward after adjustment up to pH *i* of 7.5 over the course of the

toxicity test. However, the pH of the effluent in the baseline test and the pH 11 adjustment test may drift upwards over the course of the toxicity test, from pH *i* (7.5) to as high as pH 8.5. By the end of the test, the analyst may be confronted with interpreting the results of tests conducted at different pH values. If a compound whose toxicity is dependent upon pH (e.g., ammonia) is present in the sample (cf., Section 8.9 for a discussion of the effects of pH on ammonia toxicity), the fact that pH either did not change, or even drifted down in the pH 3 adjustment/aeration test sample (relative to the baseline and/or pH 3 adjustment test), can complicate interpreting the test results. If ammonia were present (which is less toxic at a low pH), the sample would appear to have lost toxicity in the pH 3 adjustment/aeration test, when the loss in toxicity may have been the result only of the differences in pH drift during the toxicity tests.

The pH 3 adjustment/aeration test is not the only manipulation that may cause differential pH drift over the course of the toxicity test. Virtually all the manipulations in Phase I have the potential to cause this effect. For example, with some effluents any pH 3 manipulation (i.e., pH adjustment, aeration, or filtration) followed

by readjustment to pH *i*, will cause pH to behave differently than the pH of the baseline test. Similarly, the pH 11 manipulations (i.e., pH adjustment, aeration, or filtration) can cause similar fluctuations, but they do not seem to occur as frequently as with the pH 3 manipulations. Another manipulation that causes this differential pH drift is passing effluent over the C₁₈ SPE column at pH *i*, pH 3 or pH 9 (Section 8.6). Although not as drastic as some of the effects observed with the pH 3 adjustment/aeration tests, the sample collected after passing the effluent over the C₁₈ SPE column may have a slightly lower pH by the end of the toxicity test than the pH of the baseline test (e.g., pH 8.2 as opposed to pH 8.5). A final manipulation that has the potential to cause acidic pH drift is the addition of EDTA; details of this pH fluctuation are elaborated in Section 8.8.

Although ammonia is a commonly encountered sample toxicant whose toxicity is pH dependent, it is not the only compound whose toxicity can be affected by different test pH's (cf., Phase II). We have observed pH dependence with several metals and the effects of differential pH drift after various Phase I manipulations should be considered. pH should always be monitored and recorded whenever mortality readings are made (e.g., 2 h, 24 h) as well as at the end of the test. It is particularly important to record pH of the concentrations that determine the LC50, especially if greater than 5 mg/L of total ammonia is present in the sample. Differential pH drift after manipulations can be overcome by closely monitoring the test pH, and adjusting the pH in the manipulated samples to match the pH of the baseline toxicity test. These adjustments are done before animals are introduced.

8.4 pH Adjustment/Filtration Test

Principles/General Discussion:

The filtration experiment provides information on effluent toxicants associated with filterable material. Toxic pollutants associated with particles may be less biologically available. However, aquatic organisms can be exposed to these pollutants through ingestion of the particles. This route of exposure may be significant for cladocerans and other filter feeders ingesting bacterial cells and other solids with sorbed toxicants. The degree to which any compound exists sorbed or in solution depends on a number of factors including particle surface charge (or lack thereof), surface area, compound polarity and charge, solubility and the effluent matrix. By filtering particles from the effluent, an immediate cause or a sink of toxic chemicals may be removed.

In addition to determining the effect of filtration on the toxicity of the whole effluent, the effects of pH adjustment in combination with filtration are also assessed with this manipulation. As discussed in Section 8.3, changes in solution pH can result in the formation of insoluble complexes of metals (Figure 8-4). Similarly, organic acids and bases existing in ionic form can be transformed into the non-ionic form by pH adjustment.

Shifts in effluent pH can also act to drive dissolved toxicants onto particles in the effluent (e.g., shifting the dissolved/sorbed equilibrium away from the free form). Changes in toxicant polarity resulting from solution pH change can make some particle/toxicant interactions stronger. In other cases, the increase in effluent ionic strength resulting from the shift in pH may force non-polar organic compounds onto uncharged surfaces to a greater extent.

By filtering pH adjusted aliquots of effluents, those compounds typically in solution at unadjusted pH but *insoluble or associated with particles to a greater extent* at more extreme pH's, are removed. By removing the toxicant-contaminated particles or precipitated compounds prior to readjustment of the sample to pH *i*, these toxicants are no longer available for dissolution in the effluent. *The pH change may also destroy or dissolve the particles, thereby removing the sorption surfaces or driving the dissolved/sorbed equilibrium in the opposite direction.*

Positive pressure filtration is recommended. Use of a vacuum to draw the effluent sample through the filter may result in a loss of volatile compounds by degassing the solution during filtration. This problem is potentially worsened in pH adjusted effluents if toxicants become more volatile as a result of pH changes. If vacuum filtration is used and effluent toxicity is reduced, subsequent tests must be performed to define the nature of the toxicity loss. In this filtration step, whether pressure or vacuum filtering is done, it is important to avoid stainless steel housings for either the pH 3 or pH 11 adjustment tests. Teflon, plastic or glass equipment does not have the associated toxicity that the stainless steel has under acidic or basic conditions.

The pH adjustment/C₁₈ SPE test (Section 8.6) requires the use of filtered effluent. Without knowledge of the effect of filtering on the effluent toxicity, it is not possible to tell whether or not the SPE column or the filtration removed the toxicity. Filtering may also be useful in connection with other Phase I tests.

Volume Required:

A 235 mL aliquot of pH *i* effluent is filtered. Also, 235 mL each of pH 3 and pH 11 effluent aliquots (Section 8.3) are filtered. The remaining 35 mL of each solution is reserved for the pH adjustment/aeration tests. A maximum volume of 30 mL of each of these three solutions is needed to perform the filtration toxicity tests. The exact effluent volume required for the toxicity test will be a function of the effluent toxicity (Section 7). Each test (pH 3, pH *i*, pH 11) requires four exposure concentrations (10 mL each). The remaining filtered effluent volumes (+200 mL) of pH 3, pH 11, and the pH *i* solutions are each reserved for the C₁₈ SPE tests (Section 8.6). Excess volume has been included to cover losses occurring during the filtration operation.

For the blanks, 85 mL of dilution water is needed for each pH test, of which 50 mL will be used in the pH adjustment/SPE test.

Apparatus:

Six 250 mL graduate cylinders, six 250 mL beakers, six 50 mL beakers, pump with sample reservoir, teflon tubing, in-line filter housing, ring stands, clamps. Alternatively, vacuum flask, filter stand, clamp, vacuum tubing, water aspirator or vacuum pump. Glass-fiber filters (nominal size of 1.0 μm , without organic binder), stainless steel forceps, glass stoppered bottles for acid and base solutions, pH meter and probe, stir plate, perfluorocarbon stir bars, automatic pipette, disposable pipette tips, eye dropper or wide bore pipette, 30 mL beakers or 1 oz plastic cups, light box and/or microscope (optional).

Reagents:

Solvents and high purity water for cleaning pump reservoir and filter, 1.0, 0.1, and 0.01 N NaOH, 1.0, 0.1, and 0.01 N HCl (ACS grade in high purity water), buffers for pH meter calibration.

Test Organisms:

Test organisms, 75 or more, of the same age and species.

Procedure:

Day 1: First, the filters must be prepared. These steps are outlined in Figure 8-7. After the filters are prepared, the dilution water at the appropriate pH is filtered and collected for the toxicity blanks. Finally the effluent samples at each of the three pH's are filtered (Figure 8-8). Use of glass-fiber rather than cellulose-based filters should minimize the adsorption and loss of dissolved non-polar organic compounds from the effluent sample. Adsorption of toxic dissolved compounds onto the filter or onto particles retained by the filter can lead to spurious results.

Filter Preparation: To prepare the 1.0 μm glass-fiber filter for use, wash two 25 mL volumes of high purity water through the filter. For the pH 3 effluent filtration test, the filter must be washed with high purity water adjusted to pH 3 using HCl. Likewise, the filter used with the pH 11 effluent sample must first be washed with high purity water adjusted to pH 11 using a concentrated NaOH solution. Washing the filters with water adjusted to the same pH as the effluent should prevent sample contamination with water soluble toxicants contained on the filters.

Blank Preparation: The next step is to prepare filter blanks using dilution water (Figure 8-7). These blanks are used to detect the presence of any water soluble toxicants which may remain on the filter following the washing process. The pH *i* filtration blank is simply prepared by passing 50 mL of dilution water (where the pH is unadjusted) through a washed filter. The filtered dilution water is collected and 30 mL of this volume is reserved for the post- C_{10} SPE column toxicity blank (Section 8.6). The remaining 20 mL is used as a filtration toxicity blank. Again, excess is included to cover any possible loss during rinses.

To prepare the pH 3 filtration blank, 105 mL of dilution water is adjusted to pH 3 with HCl, caution being taken to minimize the increase in dilution water ionic strength. Of the pH 3 adjusted dilution water, 20 mL is for the pH adjustment only test, 35 mL is reserved for use as a toxicity blank in the aeration test (Section 8.5), and 50 mL of pH 3 dilution water is passed through a filter previously washed with pH 3 rinse water. The filtered pH 3 dilution water is collected and 30 mL of this volume is reserved for the pH 3 filtration/ C_{10} SPE toxicity test blank. The remaining 20 mL is readjusted to the initial pH of the dilution water using NaOH, again taking care not to exceed the initial pH of the dilution water during the readjustment process. This solution is used in a single exposure toxicity test as the filtered pH adjustment toxicity blank.

The pH 11 toxicity blank sample is prepared in a similar fashion using 105 mL of dilution water adjusted to pH 11 with NaOH. Of the pH 11 dilution water, 20 mL is reserved for use in the pH adjustment only test and 35 mL for the aeration test. The remaining volume (50 mL) is filtered using the filter previously washed with pH 11 rinse water and 30 mL of the filtered pH 11 dilution water is collected for use as the pH 11 filtration/ C_{10} SPE blank. The remaining 20 mL is readjusted to the initial pH of the dilution water with HCl and used as the pH 11 filtered toxicity blank using a single exposure.

Sample Preparation: The same filter(s) used to prepare the pH *i* (or pH 3 or pH 11) dilution water filtration blank(s) is now used to filter the pH *i* (or pH 3 or pH 11) effluent. First, a 235 mL aliquot of the pH *i* effluent is passed through the pH *i* prepared filter and collected; of which 200 mL is reserved for the C_{10} SPE test. The remaining volume (approximately 30 mL) is held for the pH adjustment/filtration toxicity tests.

Now, using the same filter used to prepare the pH 3 filtration blank, 235 mL of pH 3 effluent (see Section 8.3) is filtered and collected. The filtered pH 3 effluent is split into two aliquots (200 mL and approximately 30 mL). The 200 mL aliquot is used in the pH 3 adjustment/ C_{10} SPE test. The 35 mL filtered aliquot is readjusted to pH *i* using NaOH. Care must be taken to minimize both an increase in aliquot volume and ionic strength. The pH readjusted 35 mL aliquot is held for the toxicity testing.

Finally, the filtration step is repeated using 235 mL of the pH 11 effluent (Section 8.3) and the filter originally used to filter pH 11 dilution water. Again, 200 mL of the pH 11 filtered effluent is used in the pH adjustment/ C_{10} SPE test and the filtered sample (approximately 30-35 mL) is readjusted to the pH *i* of the effluent with HCl and used to conduct a toxicity test on day 2.

In filtering effluent samples with high solids content, it may be necessary to use more than one filter for the 235 mL of effluent. If so, the filter preparation step must

Figure 8-7. Overview of steps needed in preparing the filter and the dilution water blanks for the filtration and/or the C_{18} solid phase extraction column tests.

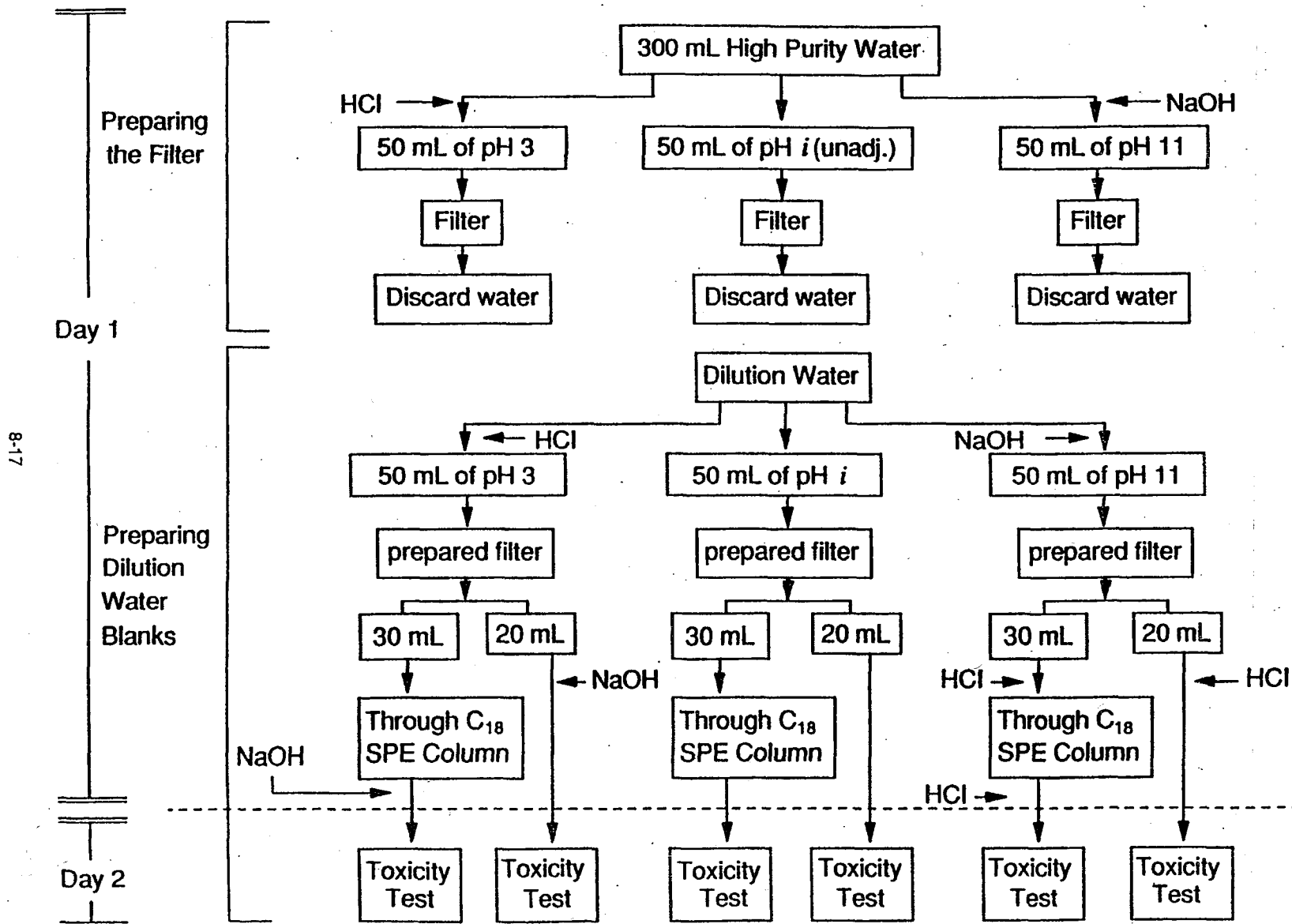
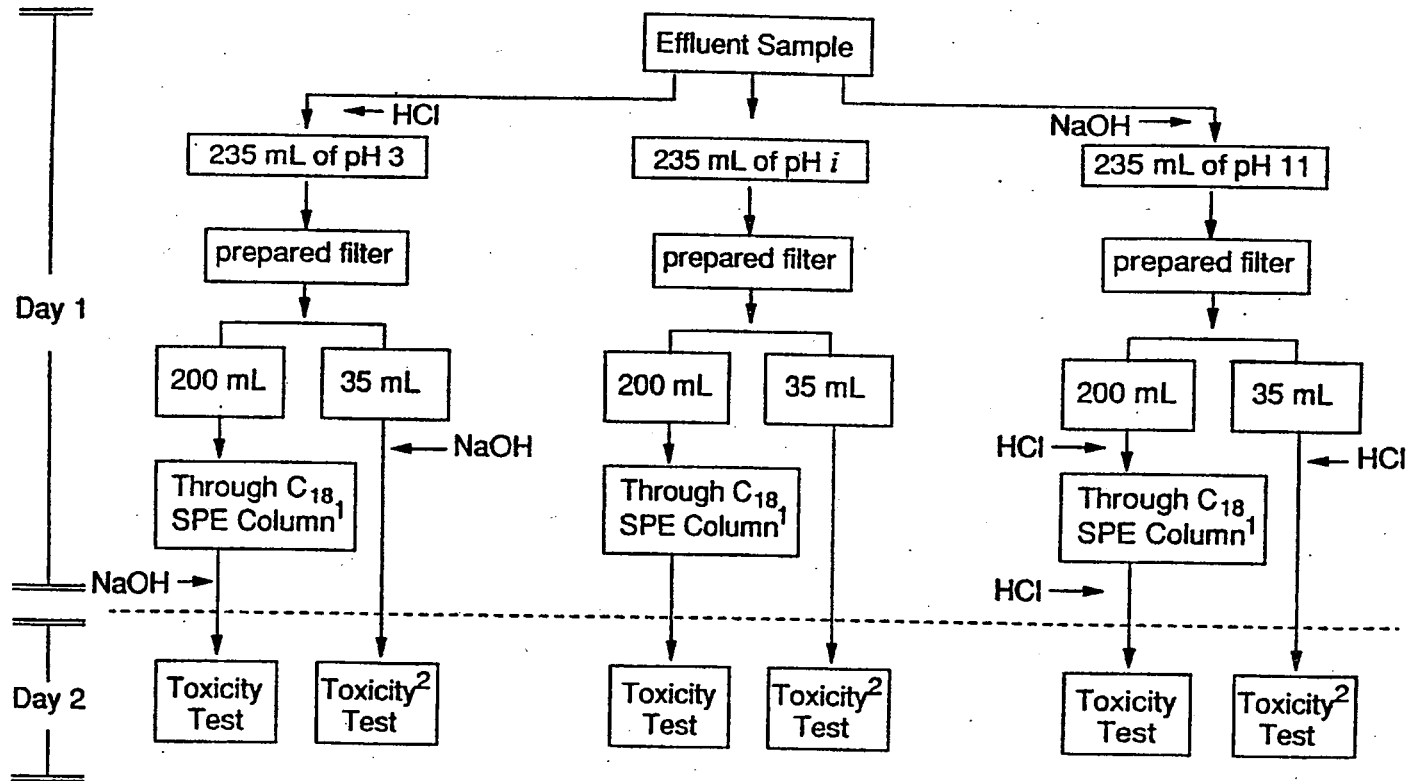

Figure 8-8. Overview of steps needed in preparing the effluent for the filtration and/or C₁₈ solid phase extraction column tests.



8-18

¹ See Figure 8-13 and Section 8.6 for details.

² Same test as depicted in Figure 8-13.

be repeated to provide additional filtration blanks or several filters can be prepared at one time by stacking them together in the filter housing. Alternatively, it may be possible to centrifuge samples high in suspended solids and filter the supernatant through a single filter. If this option is taken, the toxicity of the supernatant must be tested and compared to the toxicity in the baseline effluent test.

In the above procedures, either separate effluent filtration systems should be used or the filtration system must be cleaned between pH adjusted aliquots to prevent any carry-over of toxicity or particles. This means all equipment should be thoroughly rinsed with 10% HNO₃, acetone, and high purity water between aliquots of effluent with the exception of stainless steel equipment where dilute solutions should be used.

The pH of the pH adjusted blanks and effluent aliquots, designated for day 2 toxicity tests, should be checked periodically throughout the work day. Adjustments should be made as necessary in order to maintain the pH *i* of these solutions.

Day 2: Prior to initiating the toxicity tests, the pH of the pH 3 and 11 blanks and filtered effluent aliquots should be measured and readjusted to pH *i*. Toxicity tests performed on all three (pH 3, pH *i*, and pH 11) filtration blanks involve testing without dilution. Based on the 24-h initial LC50 of the day 1 effluent, toxicity tests performed on the effluent aliquots filtered at pH 3, pH 11, and pH *i* are set up at 4x-, 2x-, 1x-, and 0.5x-LC50 as described in Section 8.2. Measurement of exposure pH should be made daily on concentrations around the mortality and the highest tested concentration, concurrently with survival readings. A sample data sheet for the filtration tests is shown in Figure 8-9.

Interferences/Controls and Blanks:

Controls prepared for the baseline toxicity test serve as a check on the quality of organisms, dilution water and test conditions. Results of the pH adjustment test (Section 8.3) will indicate whether or not toxic levels of NaCl have been produced through pH adjustment only.

Results of the effluent filtration tests at each pH should be compared with the filtration dilution water toxicity blank performed at the corresponding pH to determine the validity of the toxicity test outcome. No significant mortality should occur in any of the filtration blanks. If unacceptable mortality of organisms occurs in either the pH 3 or pH 11 adjusted filtration blanks, further investigation will be necessary to determine whether lethality resulted from toxicants leached from the filter at pH 3 and/or pH 11, or whether the increase in dilution water ionic strength (via acid and base addition) is responsible for the problem. Additionally, if the pH 3 and/or 11 filtration, aeration (Section 8.5) and C₁₈ SPE (Section 8.6) dilution water blanks have approximately the same final concentration of acid and base, any ionic strength related toxicity should also be detected in them.

If a filtration toxicity blank shows unacceptable acute toxicity but the corresponding filtered effluent is equally or less toxic than the baseline toxicity test, it is possible that the dilution water toxicity blank removed the final traces of toxic filter artifacts. In some cases, the effluent matrix may have also prevented the artifacts from leaving the filter or masked their presence. Alternatively the observed filtered effluent toxicity may represent the net effect of toxicant removal via filtration plus contamination by filter artifacts.

Results/Subsequent Tests:

The LC50s for the aliquots of pH 3, pH *i* and pH 11 filtered effluent are compared to the baseline effluent LC50 to determine whether any of these processes resulted in a significant change in effluent toxicity.

If toxicity can be removed by filtration, either with or without pH change, one has a method for separating the toxicants from other material in the effluent. This knowledge itself provides an important advance because further characterization and analyses will be less confused by non-toxic constituents. Usually further characterization will be the next step. Tests must be designed to determine whether the mechanisms causing removal are precipitation, sorption, change in equilibrium or volatilization. One necessary step is to recover the toxicity from the filter. If this cannot be done and the loss is not by volatilization, then the whole experiment may have little utility. Comparisons of pressure and vacuum filtration may reveal if volatilization is involved. If characterization of the toxicant is also achieved through other tests, filtration can be used to remove the toxicants. Then if the suspected toxicant is the true one, its concentration should be lower or zero after toxicity is removed by filtration.

If any or all of these pH/filtration combinations result in less effluent toxicity (not attributable to the effects of pH adjustment alone), it may be possible to confirm the findings of the test. A transfer of the solids contained on the filter back into the filtrate at pH *i* can be attempted by reversing the flow of the filtrate through the filter or by rinsing the solids off the filter with filtrate. The toxicity exhibited by this solution should be similar to that of the original effluent, provided that the final concentration of solids in the test solution approximates the solids level in the sample that was filtered. For precipitates formed as a result of pH changes or for contamination of suspended solids facilitated by pH adjustment, time must be allowed for the precipitate to redissolve in the pH *i* filtrate or for a new equilibrium to be set up between the contaminants on the solids and in solution. The results of this test are not likely to be quantitative due to the recovery problems inherent in the process.

In order to determine whether the effluent matrix affects the toxicity of filterable particles (e.g., its ionic strength, dissolved organic carbon content), the filtered material can also be added to a volume of pH *i* dilution water equal to the volume of effluent that was passed

Figure 8-9. Example data sheet for filtration test.

Test Type: <i>Filtration</i> Test Initiation (Date & Time): _____ Investigator: _____ Sample Log No., Name: _____ Date of Collection: _____	Species/Age: _____ No. Animals/No. Repts: _____ Source of Animals: _____ Dilution Water/Control: _____ Test Volume: _____ Other Info: _____
--	--

pH/Conc. (% Effluent)	0 h pH	Survival Readings:			
		24 h	48 h	72 h	96 h
		A pH DO	A pH DO	A pH DO	A pH DO
<i>3/4x-LC50</i>					
<i>3/2x-LC50</i>					
<i>3/1x-LC50</i>					
<i>3/0.5x-LC50</i>					
<i>3/blank</i>					
<i>pH i/4x-LC50</i>					
<i>pH i/2x-LC50</i>					
<i>pH i/1x-LC50</i>					
<i>pH i/0.5x-LC50</i>					
<i>pH i/blank</i>					
<i>11/4x-LC50</i>					
<i>11/2x-LC50</i>					
<i>11/1x-LC50</i>					
<i>11/0.5x-LC50</i>					
<i>11/blank</i>					
		LC50 ____	LC50 ____	LC50 ____	LC50 ____

Note: See baseline data sheet for control data.

Volumes and Strength of Solutions Added:

	HCl	NaOH
pH 3	_____	_____
pH i	_____	_____
pH 11	_____	_____

Comments:

through the filter. The toxicity of this dilution water, spiked with effluent solids, can be compared to the toxicity of the unfiltered (baseline) effluent and the filtrate spiked with its own solids.

We have had limited experience with effluents in which acute toxicity could be removed by filtration at a normal pH (7-8). The additional tests suggested herein may or may not provide the relevant information.

Another technique to recover the toxicant(s) from the filter is to sonicate the filter(s) with a solvent (e.g., methanol or pH-adjusted water). For some effluents, the toxicity can be removed by the pH 11 adjustment/filtration test. These results may cause one to suspect either cationic metals or surfactants as the toxicant(s) (see Section 9.4). We have had success in recovering toxicity from the glass fiber filter when the filter was sonicated for 1 h in pH 3 adjusted dilution water. Typically, 300 mL of effluent is filtered and the filter is sonicated in 75 mL of pH 3 dilution water, this concentrates the toxicity 4x (theoretically). The pH of the concentrate is then readjusted to pH *i* before use in the toxicity test. For some effluents the amount of a cationic metal was reduced after filtration and the toxicity in the effluent removed after filtration. Toxicity was recovered in the pH 3 dilution water extract of the filter. If methanol is used, after sonication the methanol must be concentrated before use in toxicity tests (see Section 8.6 for methanol tolerances). Additional solvents can be used to recover toxicity off the filters (Schubauer-Berigan and Ankley, 1991).

8.5 pH Adjustment/Aeration Test

Principles/General Discussion:

The aeration test is designed to determine how much effluent toxicity can be attributed to volatile, sublutable, or oxidizable compounds. The test is performed with pH-adjusted and unadjusted (i.e., pH *i*) effluent. By comparing the toxicity test results for acidic, pH *i* and basic aerated samples, the toxicity may vary and this knowledge can be used for further characterization. Some compounds can be removed or oxidized most easily at one pH, whereas others are most easily removed or oxidized at a different pH. Thus, the aeration is performed at several pH values.

Whether a constituent is completely removed, or sufficiently removed to reduce toxicity, depends on many chemical/physical conditions. At a minimum, one must be certain that the geometry of the sparging process is always the same for a given effluent sample and that the duration is constant, otherwise the test is of little value. The pH of many effluents will change, sometimes rapidly (cf., Section 8.3), during sparging and so pH must be frequently checked and maintained during the entire aeration period.

Oxidation can change the constituents in many ways and one must determine if oxidation or sparging is the mechanism before additional tests can be designed. Water soluble constituents such as ammonia

and possibly cyanide are not readily stripped using techniques described in the *Procedure* below, and one should not assume that they will be removed. Under both air and nitrogen sparging, a removal process, in addition to volatilization, may occur. Sparging can remove surface active agents from solution by the process of sublation (lifting up, carrying away). Surface active agents have a molecular structure that includes a polar end (either ionic or nonionic) and a relatively large non-polar, hydrocarbon end. Some examples of surface active agents are resin acids, soaps, detergents, charged stabilization polymers and coagulation polymers used in chemical manufacturing processes. The process of sublation occurs because during sparging, surface active agents congregate at the liquid/gas interface of the air or nitrogen bubbles and are carried along with the gas bubbles to the surface of the sparged liquid. As the bubbles break up, they are deposited and concentrated with continuous sparging at the surface of the sparged liquid, and the sides of the aeration vessel. After sparging, a faint deposit may or may not be visible on the sides of the aeration vessel.

Air is used for sparging so that oxidation is included. Subsequent tests with nitrogen may be used to separate sparging from oxidation and tests described under *Results/Subsequent Tests* can be used for sublutable compounds. We have grouped the tests to avoid many tests initially.

Volume Required:

Thirty-five mL volumes of each pH 3, pH 11 (see Section 8.3) and pH *i* effluent are needed for this test. A maximum volume of 30 mL of each of these solutions is required for the toxicity tests on aerated solutions. An excess volume has been provided to allow for losses through aeration. Each toxicity test utilizes four exposure concentrations (10 mL each) without replication. The exact volume required for the toxicity test on each pH adjusted or unadjusted aerated solution will depend on the toxicity of the effluent (the 24-h initial LC50).

The amount of dilution water that was used for the toxicity blanks (35 mL) is kept the same as the effluent for each pH. An excess volume has been provided to allow for any volume loss through aeration (cf., Section 8.3).

Apparatus:

Aeration device or compressed air system with a 0.22 μ m filter, six air flow regulators, six glass diffusers, six 50 mL graduated cylinders with ground glass stoppers, glass stoppered bottles for acid and base solutions, pH meter and probe, stir plate(s), perfluorocarbon stir bars, automatic pipette, disposable pipette tips, eye dropper or wide bore pipette, 30 mL beakers or 1 oz plastic cups, light box and/or a microscope (optional).

Reagents:

1.0, 0.1, and 0.01 N NaOH, 1.0, 0.1, and 0.01 HCl (ACS grade in high purity water), buffers for pH meter calibration.

Test Organisms:

Test organisms, 75 or more, of the same age and species.

Procedure :

Day 1: Six different solutions are aerated in this test; pH 3, pH *i*, and pH 11 effluent, and pH 3, pH *i*, and pH 11 dilution water, (cf., Sections 8.3 and 8.4, respectively for preparation of pH adjusted effluent and dilution water). A flow chart for the effluent samples of the pH adjustment/aeration test is shown in Figure 8-10. Each sample is transferred to a 50 mL cylinder containing a small perfluorocarbon stir bar. The diameter and length of the pH probe must be such that it can be placed into the solution during aeration. The taller the water column and the smaller the bubbles, the better the stripping will be. Each solution should be moderately aerated (approximately 500 mL air/min) for a standard time, such as 60 min. Formation of precipitates may or not be important and should be noted.

The pH of the acidic and basic effluent and dilution water aliquots should be checked every 5 min during the first 30 min of aeration and every 10 min thereafter. If the pH of any pH 3 or pH 11 solution drifts more than 0.2 pH units, it must be readjusted back to the nominal value. The volume and concentration of additional acid and/or base added to the solutions should be recorded so that the final concentration of Na⁺ and Cl⁻ in each solution can be calculated following final pH readjustment. Solutions should be stirred slowly during any pH readjustment. Again, precautions must be taken in order to minimize the amount of acid and base added. Note that the aeration time does not include the time intervals during which aeration is temporarily discontinued to readjust pH. A constant pH is not maintained in the "pH *i*" effluent because this solution represents the generalized effects of aeration on the effluent without regard to pH. Only slight changes in the pH of the dilution water at its initial pH are expected since such water is usually at air equilibrium before the start of the manipulation.

The sparged sample must be removed from the graduated cylinder for toxicity testing so that any toxicant that may have been sublated is not redissolved in the sparged sample. This may happen if the sample is simply poured from the cylinder, and sublation would never be suspected. Therefore, one way to transfer the effluent sample is by pipetting it out of the cylinder, exercising care to prevent any sample from contacting the sides of the cylinder above the liquid level. For example, when using a 100 mL graduated cylinder for the aeration vessel, a 50 mL pipette can be used to remove the 30 mL sample. At this point it may be possible to recover a sublated toxicant from the sides of the cylinder. This must be done at the end of the aeration step; see *Results/Subsequent Tests* section below for details.

Sparging air contaminated with oil (droplets or vapor) or any other substance is unacceptable. Contami-

nated air is probable from air lines containing oil or in cases where the source of the air is contaminated (e.g., boiler room). Small air pumps, sold for home aquaria are adequate, but only if the room air is free of chemicals or contaminants. Chemistry laboratories where concentrated chemicals and solvents are used often might not have suitable air quality.

Following aeration, the pH of each solution (including the 35 mL portions of pH unadjusted effluent (pH *i*) and dilution water) is returned to the pH of the initial effluent or dilution water using the necessary volumes of NaOH and HCl. Returning all effluent solutions to the initial pH of the wastewater will ensure that a valid comparison can be made with the baseline LC50. The pH of each sample must be checked periodically throughout the remaining work day and readjusted as necessary. If stable pH can be attained prior to toxicity test initiation, the pH during the test is likely to change less.

Day 2: Before initiating the toxicity tests, the pH of all of the aerated effluent and blank solutions should be checked and adjusted to pH *i*. Toxicity tests are performed on a single 100% concentration of all three dilution water blanks (pH 3, pH *i* and pH 11). These dilution water blanks will provide information on toxic artifacts resulting from aeration.

Based on the 24-h initial LC50 of the day 1 effluent, toxicity tests are performed on each aerated effluent solution at concentrations of 4x- (or 100%), 2x-, 1x-, and 0.5x-LC50 (cf., Section 8.2). The pH of each test concentration should be measured and recorded daily. An example of the data sheet for the aeration test is given in Figure 8-11.

Interferences/Controls and Blanks:

Dilution water controls prepared for the baseline toxicity test also act as controls on organisms, dilution water and test conditions for this test. Results of the pH adjustment test (Section 8.3) will suggest whether or not toxic levels of NaCl may have been reached as a result of the addition of acids and bases to the effluent.

No significant mortality should occur in any of the three aeration blanks. If there is significant mortality, the cause must be found and corrected before the test can be meaningful. To determine which factor(s) caused blank toxicity, the toxicity of pH adjusted aerated dilution water can be compared to that in the same pH adjusted, unaerated dilution water. Approximately the same quantities and concentrations of acid and base should be added to both of these samples of dilution water to make them comparable. Blank toxicity in the pH adjusted and unadjusted aerated dilution water suggests contaminated air. Other possible causes include contaminated equipment, such as electrodes or glassware (especially where low or high pH solutions were in contact), or the addition of too much acid or base. Another approach to this blank question involves evaluating the pH adjustment/filtration and pH adjustment/C₁₈ SPE blanks (Sections 8.4 and 8.6). Assuming the

Figure 8-10. Diagram for preparing pH adjustment/aeration test samples.

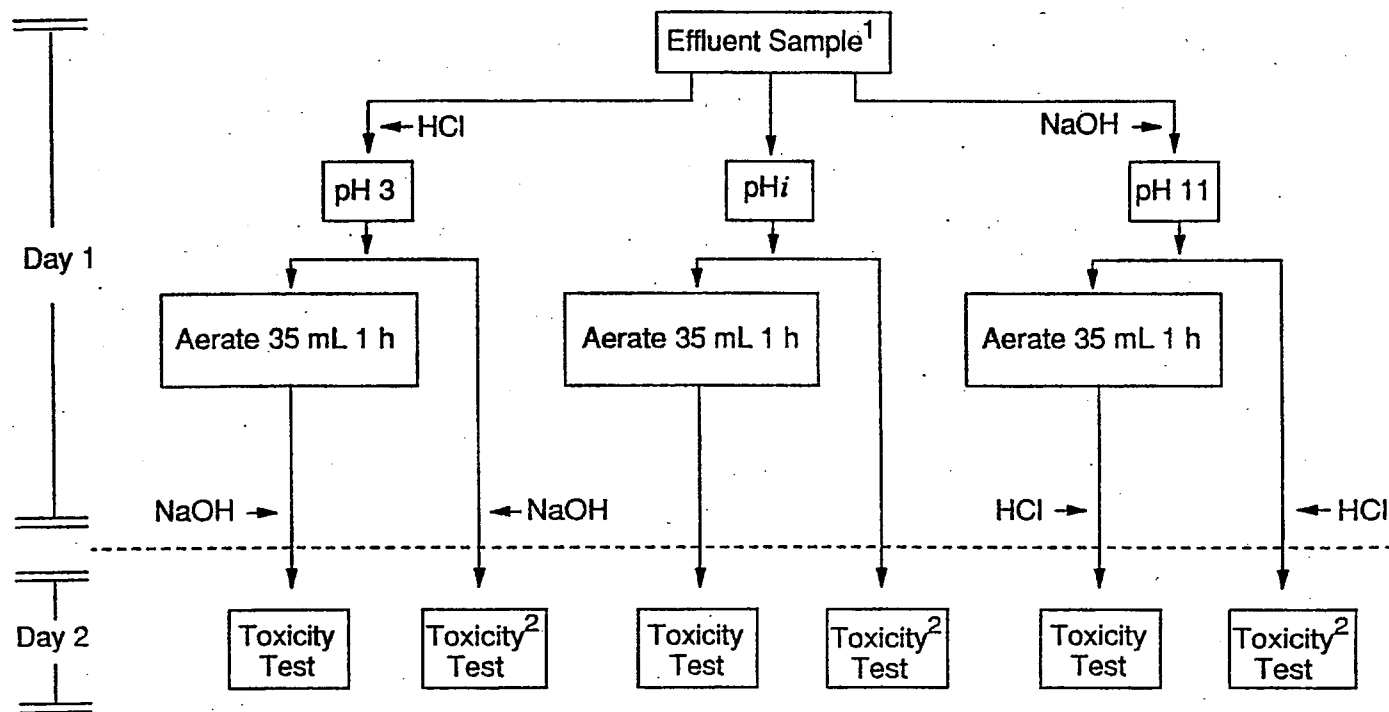

¹ All steps are conducted on dilution water to prepare blanks for testing.
² Same test as depicted in Figure 8-5.

8-23

Figure 8-11. Example data sheet for aeration test.

Test Type: <i>Aeration</i> Test Initiation (Date & Time): _____ Investigator: _____ Sample Log No., Name: _____ Date of Collection: _____	Species/Age: _____ No. Animals/No. Repts: _____ Source of Animals: _____ Dilution Water/Control: _____ Test Volume: _____ Other Info: _____
--	--

pH/Conc. (% effluent)	0 h pH	Survival Readings:							
		24 h		48 h		72 h		96 h	
		A	DO	A	DO	A	DO	A	DO
<i>3/4x-LC50</i>									
<i>3/2x-LC50</i>									
<i>3/1x-LC50</i>									
<i>3/0.5x-LC50</i>									
<i>3/blank</i>									
<i>pH i/4x-LC50</i>									
<i>pH i/2x-LC50</i>									
<i>pH i/1x-LC50</i>									
<i>pH i/0.5x-LC50</i>									
<i>pH i/blank</i>									
<i>11/4x-LC50</i>									
<i>11/2x-LC50</i>									
<i>11/1x-LC50</i>									
<i>11/0.5x-LC50</i>									
<i>11/blank</i>									

Note: See baseline data sheet for control data.

Volumes and Strength of Solutions Added:

HCl

NaOH

pH 3

pH i

pH 11

Comments:

concentration of acid and base in the final blank solution is approximately the same in all dilution waters for the three tests, toxicity in the aeration blanks but not in the filtration or C₁₈ SPE blanks suggests that aeration rather than pH adjustment has led to contamination. Compare the toxicity from the effluent baseline test to the toxicity of all three aerated effluent samples. When the baseline toxicity is significantly less than that of any one of the aerated samples, toxicity was added or created during effluent manipulations. This check is especially important because pH adjustment of aerated effluent may have required larger quantities of acid and base as compared to the pH adjustment test (Section 8.3).

If nitrogen was used for stripping, DO depletion is likely to have occurred. If a relatively large surface-to-volume ratio is used (such as the 10 mL volume in a 1 oz plastic cup) during the overnight holding period, DO should not be a problem.

Results/Subsequent Tests:

The LC50s for the aliquots of pH 3, pH *i*, and pH 11 aerated effluent are compared to the baseline effluent LC50 to determine whether any of these processes resulted in a significant change in effluent toxicity. If a substantial reduction in toxicity is seen for any or all of the three aerated effluent solutions, one must next determine whether the separation of effects was caused by sparging, oxidation, or sublation. This is done by repeating those tests in which toxicity was reduced, substituting nitrogen for air in the stripping process. Use of nitrogen eliminates oxidation as a removal process. If side-by-side effluent stripping tests with air and nitrogen provide the same results, toxicant removal is probably caused by the sparging process. If only the test(s) conducted with air succeeds in reducing or removing effluent toxicity, oxidation is a probable cause. An effluent sample may contain toxicants removed through sparging and oxidation. An example of this is where aeration at pH 3 and pH *i* reduces toxicity, but nitrogen stripping removes the toxicity only in the pH 3 effluent. Using the *Procedure* described above ammonia should not be air-stripped; however, if different aeration vessels are used and greater surface area is used, ammonia can be reduced/stripped. If toxicity is reduced at pH 11 compared to pH *i* aerated, pH 3 aerated samples, or the baseline test, measuring the ammonia concentration after aeration can be informative.

To determine if toxicity is due to sublutable compounds, toxicant recovery can be attempted by adding dilution water to the emptied cylinder used for sparging (preferably graduated cylinders with ground glass stoppers), stoppering it and shaking it vigorously, making sure that the sides of the cylinder are thoroughly rinsed with the dilution water. This dilution water is then tested for toxicity. Recovery of the sublabeled material provides further evidence that a surface active compound was present. A more concentrated solution of the sublabeled material can be obtained by using a larger sample

volume for sparging, such as 90 mL, and less dilution water (i.e., 30 mL) to recover the toxicant(s). This would result in a nominal concentration of 3x the whole effluent concentration of the toxicant(s). To avoid spurious results in cases where sublabeled toxicity is recovered, a dilution water blank should be run. A dilution water sample should be subjected to the sparging step and to the toxicant recovery step. In that way, if toxicity is inadvertently being added to samples during the manipulation (from contaminated glassware or contaminated air or nitrogen supply) it should occur in the blank sample. As some sublabeled compounds are difficult to recover from the glass surface, a solvent rinse with methanol may result in more efficient recovery. If solvents are used and because of the low concentration factor involved, most of the solvent will have to be aired down in order to have an adequate water concentration to perform the toxicity test. If solvents are needed, one is wise to scale up the volumes to obtain higher concentrations for testing. However, not all kinds of surface active agents are removed to the same degree, and some are not removed at all (Ankley et al., 1990). This is probably due to factors such as matrix effects and solubility. Recovery of a sublabeled toxicant can be difficult. Consequently, reduction of toxicity by sparging with air and nitrogen can be an indication of a toxicant which is a surface active agent, but a lack of toxicity removal does not rule out the presence of these compounds.

In the pH adjustment/aeration test, removal of toxicants by precipitation resulting from pH change alone should also be detected by the pH adjustment/filtration test. Oxidation of compounds can cause precipitation. If oxidation is the cause, the pH adjustment/filtration test will not change toxicity. If nitrogen sparging has removed the toxicant, the "volatile toxicant transfer" experiment described below may provide separation of the volatile toxicant from other constituents. Our experience with this technique is limited to a few effluents. To perform the "volatile toxicant transfer" experiment, a closed loop stripping/trapping apparatus is used (Figure 8-12). This apparatus consists of a pump which can circulate air or nitrogen gas, two airtight fluid reservoirs, perfluorocarbon tubing, and diffusers. The arrangement should be such that air or nitrogen can be passed through the effluent in one reservoir and then through the dilution water in the second reservoir before cycling back to the first reservoir. The reservoir of the dilution water serves as a trap that will collect the volatilized toxicant(s). Of utmost importance to this experiment is an air tight system. The time to equilibrium of the volatile toxicant will be dependent upon the efficiency of the sparging process and the rate of volatilization of the toxicant which may be affected by pH. For example, using a glass or plastic pipette to aerate the samples may not effectively sparge the entire volume of sample. To optimize the toxicant recovery, use of gas washing bottles (for example, 125 mL and 500 mL bottles from Kontes Glass Co., Vineland, NJ) fitted with glass frit diffusers is suggested because they sparge the sample volumes more effectively.

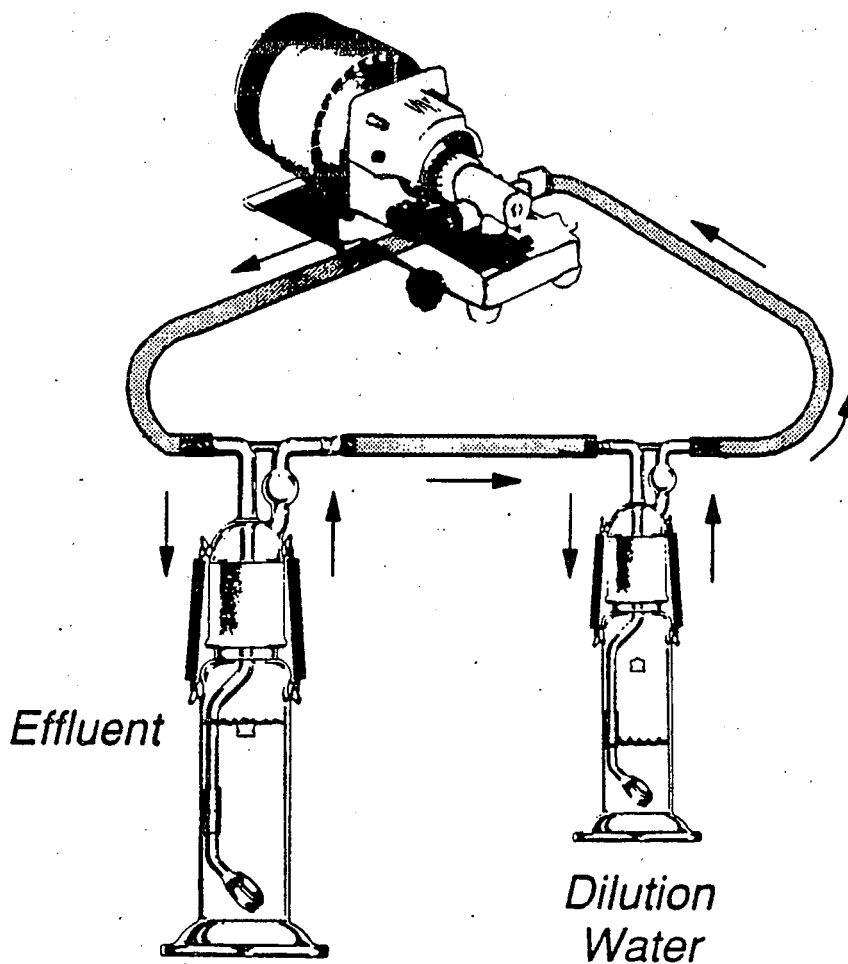

Figure 8-12. Closed loop schematic for volatile chemicals.

Numerous operating conditions can be selected, each providing different information. This system should not be operated as a conventional purge and trap system. The reason is that since one does not know the identity of the toxicant(s), the conditions for trapping are not known. Initially, the objective should be to get measurable toxicity moved into the dilution water medium in the trap. This will establish that there are at least some volatile toxicants present. At this stage the goal is not to move all the toxicant(s) to the dilution water as exists in the unaltered effluent, the data are easiest to interpret. For this purpose the volume of sparged effluent should be large and the dilution water volume in the trap small. The nitrogen gas is recirculated

so that if the trap is inefficient in removing the toxicant(s) from the nitrogen, the toxicant(s) will not be lost from the sample. Because conditions to optimize transfer cannot be selected until the chemical identity is known, longer sparging times should be chosen.

The first experiments should involve no pH changes if any measurable change in toxicity occurred in the earlier tests without the pH 3 or pH 11 adjustments. The reason for this selection is that drastic changes in pH can cause many unknown effluent changes, and artifacts are more likely to occur. Of course if pH changes are required to change toxicity, then pH will have to be altered. When pH is altered, then equilibrium objectives, mentioned above, are not possible and the entire process takes on characteristics of more conventional

purge and trap experiments. The usual resin traps described in EPA methods are not suitable because the trap cannot be tested for toxicity. The trapping medium must be, or be able to be, made into a toxicity testable water.

In those instances when sparging affects toxicity only when accompanied by a pH change (pH 3 or pH 11), the method to be used to operate it as a conventional purge and trap is as follows. The trap's dilution water volume should be small relative to the sample volume and its pH should be opposite that of the sample pH (e.g., if the sample pH is 3, then the trap pH should be 11). One can no longer conclude anything about the original effluent equilibrium, and the procedure is one of separation. Toxicity in the trap may or may not be caused by the same substance as that which causes the original effluent toxicity. Obviously, all the precautions mentioned above regarding NaCl addition and other adjustments must be tracked with blanks just as in any other experiment. We have not found many effluents where the transfer technique is useful, but for those effluents where it works, it is a powerful tool. We have found the volatile toxicant transfer experiment to be useful with some samples (i.e., sediment pore water), where two pH dependent toxicants (e.g., ammonia and hydrogen sulfide) are suspect. There is sometimes an appreciable loss of toxicity after the pH 3 aeration step in samples with ammonia toxicity, yet it is unknown whether the toxicity loss is due to volatilization of hydrogen sulfide (or some other pH dependent toxicant) at low pH, or is an artifactual decrease of ammonia toxicity due to a downward pH drift in the test (cf., Section 8.3). In this case, a trap such as the one described previously for transferring a volatile toxicant(s) at altered pH is useful. Water in the trap that volumetrically concentrates the toxicant at two or more times its whole sample concentration may be successfully tested for toxicity. We suggest, in the case of suspected hydrogen sulfide toxicity, testing the trap water at pH 6, as the toxicity of hydrogen sulfide is enhanced at that pH. One caution in this setup is that the volatility of some pH dependent toxicants such as hydrogen sulfide makes it imperative that the experiment be initiated immediately after adjusting the pH to minimize their loss.

8.6 pH Adjustment/ C_{18} Solid Phase Extraction Test

Principles/General Discussion:

The SPE test is designed to determine the extent of effluent toxicity caused by those organic compounds and metal chelates that are relatively non-polar. The effluent is passed through a small column packed with an octadecyl (C_{18}) sorbent. Compounds in the effluent interact through solubility and polarity with the sorbent, and are extracted from the effluent onto the sorbent. This type of chromatography in which the mobile phase (the effluent) is polar and the solid phase (C_{18} sorbent) is non-polar, is referred to as reversed phase SPE. Any organic compound present in water can be considered "soluble" by virtue of its presence in the water. Obvi-

ously, relative degrees of water solubility exist. Many highly toxic pollutants found in effluents at very low concentrations are not considered to be water soluble despite the fact that they are present at toxic concentrations.

Compounds extracted by the C_{18} sorbent from a pH neutral aqueous solution are usually soluble in hexane or chloroform. The C_{18} sorbent can also be used to extract organic acids and bases; organic acids and bases can be made less polar by shifting the equilibrium to the un-ionized species. By adjusting the effluent to a low pH and a high pH, some of these compounds will exist predominately in the un-ionized form and will sorb to the C_{18} SPE column. Because of C_{18} SPE column degradation, pH's above 9 and below 3 are not used. To ensure column integrity, the pH of the effluent to be used on the SPE columns will be either pH 3 and/or pH 9 (lowered from pH 11) in this manipulation. Manufacturer's data should be consulted for tolerable column pH ranges and for exact column conditioning procedures that must be done to get proper performance.

Volume Required:

Of the 235 mL of effluent (at each pH) filtered in a previous step (Section 8.4), 35 mL of the sample (at each pH) is held for the pH adjustment/filtration toxicity test. Now, the additional 200 mL volume is pumped through the C_{18} column. Each toxicity test (pH 3, pH *i*, and pH 11 test solutions) is conducted on four exposure concentrations (10 mL each) without replicates. The exact volume required for the toxicity test on each pH adjusted or pH *i* post-column effluent will depend on the toxicity of the effluent (the 24-h initial LC50).

For the blanks, 30 mL of pH adjusted (pH 3 or pH 11) and/or filtered (pH *i*) dilution water is needed. The last 10 mL of the post-column water should be used for blank toxicity tests.

Apparatus:

Six 250 mL graduated cylinders, eight 25 mL graduated cylinders, glass stoppered bottles for acid and base solutions, pH meter and probe, stir plate, perfluorocarbon stir bars, pump with sample reservoir, perfluorocarbon tubing, ring stands, clamps, three 3 mL C_{18} SPE columns (200 mg sorbent), automatic pipette (10 mL), disposable pipette tips (10 mL), eye dropper or wide bore pipette, 30 mL glass beakers or 1 oz plastic cups, light box and/or microscope (optional).

Reagents:

HPLC grade methanol, high purity water, 1.0, 0.1, and 0.01 N NaOH, 1.0, 0.1, and 0.01 N HCl (ACS grade in high purity water), buffers for pH meter calibration, acetone and methanol for cleaning the pump and reservoir, and vials to collect methanol eluate.

Test Organisms:

Test organisms, 135 or more, of the same age and species.

Procedure:

Day 1: This procedure is performed with effluent samples adjusted to the various pH's; however, the manipulations have three distinct steps (Figure 8-13) which are generally the same for each pH. Prior to attaching a new column to the apparatus, the reservoir and pump must be cleaned with acetone, methanol, and high purity water.

Step 1 involves conditioning the solid phase extraction columns for each pH. Column conditioning procedures may vary with the manufacturer of the column. The procedures described below are modifications of the conditioning steps used with Baker® C₁₈ SPE columns (J.T. Baker Chemical Company, Phillipsburg, NJ).

Using a flow-rate of 5 mL/min, 15 mL of HPLC grade methanol is pumped through the column and discarded. Next 15 mL of high purity water, adjusted to pH 3 with HCl, is placed in the sample reservoir. Care must be taken in timing the addition of solutions after the methanol has passed through the column. While the mixing of methanol with subsequent solutions must be minimized, the column must also be prevented from going dry following the methanol wash and dilution water or sample application. The amount of time needed between introduction of solutions to prevent any column drying will be unique to each investigator's apparatus. This timing should be determined before performing this procedure with actual effluent samples. If the column dries at any time after introduction of the methanol during conditioning, the column must be re-conditioned (with methanol).

As the last volume of pH 3 high purity water is entering the column (Step 1), the pH 3 adjusted, filtered dilution water is placed into the reservoir (Step 2). Again, the column must not be allowed to dry before the pH 3 dilution water enters the column. The pH 3 high purity water passing from the column should be measured to determine the point at which the dilution water begins to leave the column. This pH 3 high purity water used to condition the column is discarded. Next, 30 mL of the filtered pH 3 dilution water is collected, and the last 10 mL aliquot collected is used for the toxicity blank to detect toxicity leached from the column. This aliquot will have to be pH re-adjusted to the initial pH of the dilution water using NaOH, and it is reserved for day 2 toxicity testing. Care should be taken to minimize changes in sample volume and ionic strength during pH readjustment.

As the last several mL of filtered pH 3 dilution water are entering the column, the 200 mL volume of filtered pH 3 effluent is placed in the sample reservoir (Step 3). Again, the column sorbent must not be allowed to dry between the dilution water blank and the effluent. Collect a 30 mL aliquot of post-column effluent after 25 mL of the sample passes through the system. A second post-column 30 mL aliquot is collected after a total of 150 mL of the sample passes through the column. Collection of the first post-column sample after 25 mL of sample has passed the column ensures that any

dilution water left in the system will not be present in the post-column sample. The second subsample of post-column solution provides information on column overloading and toxicant breakthrough. Both of these 30 mL aliquots are readjusted to the pH *i* using the drop-wise addition of NaOH. The total volume of NaOH necessary for pH adjustment should be recorded. These aliquots are reserved for day 2 toxicity testing. Columns are not re-used but should be saved for subsequent elution (see the *Results/Subsequent Tests* section).

Receiving water should not be used as the dilution water because trace organic and metal contaminants or organics (such as humic acid) may be present. If for any reason, such a water is needed, the same column should not be used for concentrating the toxic sample. Rather, a new column should be conditioned and in place of the 30 mL dilution water blank, 30 mL of a synthetic dilution water should be used. It should also be checked for toxicity. The pH should be adjusted to the same value as that of the effluent sample. It is best to avoid receiving water for the diluent at this stage of Phase I.

For pH *i*, the above procedure is repeated using a clean reservoir and pump and a new conditioned 3 mL C₁₈ SPE column for the filtered pH *i* effluent (Figure 8-13). The pH of the post-column dilution water and post-column effluent should be measured.

In the final C₁₈ SPE manipulation, pH 9 (readjusted from pH 11) dilution water and effluent are processed as described above. While use of pH 11 effluent offers the likely advantage of shifting a larger number of basic organic compounds farther towards the predominately un-ionized form, and therefore removal, the C₁₈ SPE column cannot withstand a pH above 10. For this reason, the pH 11 filtered dilution water and sample aliquots prepared in Sections 8.3 and 8.4 are readjusted to pH 9 with HCl before they are put through the column. The 15 mL of high purity water used to rinse the column following methanol conditioning must also be readjusted to pH 9 with NaOH. The 10 mL aliquot of post-column pH 9 dilution water and both 30 mL aliquots of post-column pH 9 effluent are further adjusted to their pH *i*'s respectively, prior to toxicity testing. The total volume of acid added for pH readjustment is recorded. The pH of all aliquots of the chromatographed dilution water and effluent should be checked and readjusted as appropriate throughout the remainder of the work day.

Day 2: The pH of all of the post-column dilution water and effluent aliquots should be checked and readjusted if pH has drifted overnight. Toxicity tests are performed on a single 100% concentration of all three of the dilution water blanks. These blanks will provide information on the presence of toxicity leached from the C₁₈ column at different pH's.

The six 30 mL post-column effluent aliquots are tested for toxicity using an exposure series based on the 24-h LC50 of the original effluent. Chromatographed effluent aliquots are tested at concentrations of 4x-

Figure 8-13. Step-wise diagram for preparing the C₁₈ solid phase extraction column samples.

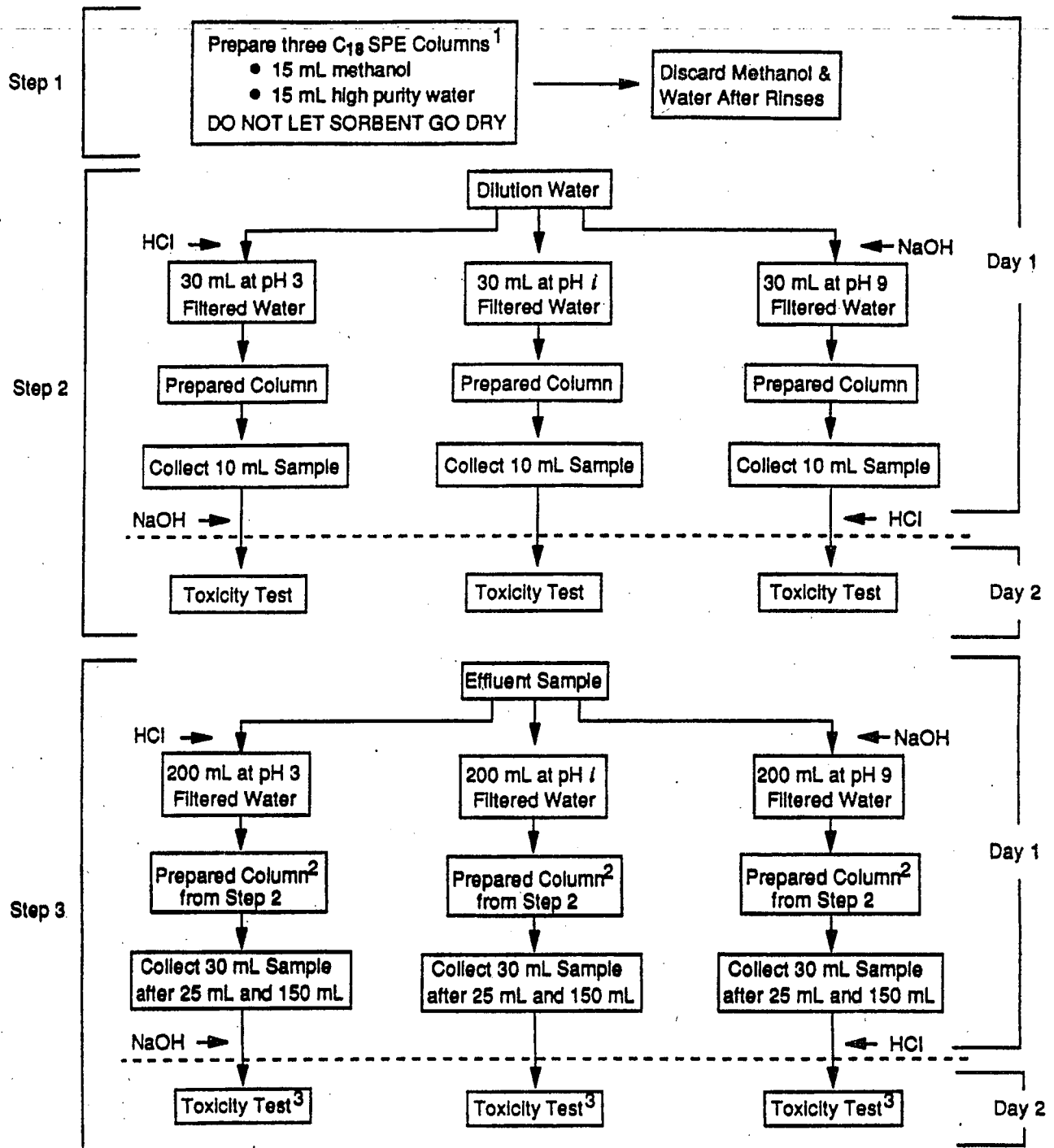

¹ If column will be eluted with 1 mL methanol (c.f., *Results/Subsequent Tests*), collect methanol column blank before dilution water is passed over column. Column should go to dryness and will have to be re-conditioned (Step 1) before proceeding to Step 2.

² Use same column used with the dilution water unless receiving water is used (see text for details).

³ Same test as depicted in Figure 8-8.

2x-, 1x-, 0.5x-LC50 (cf., Section 8.2). The pH of each solution tested should be measured daily and recorded along with organism survival. A sample data sheet for the C_{18} SPE test is shown in Figure 8-14.

Interferences/Controls and Blanks:

Controls on test organism performance, dilution water quality, and test conditions are provided by the control from the baseline toxicity test. The pH adjustment and filtration tests (Sections 8.3 and 8.4) provide information on the effects of pH adjustment and filtration on effluent toxicity apart from any additional changes caused by C_{18} SPE. Effluent and blank test results from these two tests must be evaluated prior to interpreting the results of the C_{18} SPE test, both in terms of identifying any toxic artifacts added during filtration and pH adjustment and in allocating toxicity reduction to the three components potentially impacting effluent toxicants in the C_{18} SPE test.

Of those methods discussed so far, the C_{18} technique requires the greatest manipulation. More problems are likely to be encountered with toxic blanks because in addition to those factors associated with pH adjustment and filtering, the C_{18} method also involves use of resin and methanol. Blanks for toxicity must be checked in the same manner as before for acid and base addition, filter artifact toxicity, pH drift, as well as toxicity from the C_{18} column. In addition to these, some effluents behave in a peculiar way after passing through the SPE column (cf., discussion below).

Results/Subsequent Tests:

The above unique properties of some effluents and the potential for column blank toxicity problems make interpretation of the test results more subjective.

If toxicity is not reduced in post-column effluent, not too much credence should be placed on the results. One needs to go back and sort through the possible causes.

If none of the Phase I treatments reduced toxicity (including the C_{18} SPE column) or if the toxicity was reduced by the C_{18} column, it is useful to elute the column with 100% methanol. Of course, a column blank must also be evaluated; this is a methanol elution following the column conditioning with methanol and high purity water. The column must go to dryness before collecting the blank of methanol. After the methanol blank is collected, the column must be reconditioned as described in Step 1 in Figure 8-13 and the column must not go to dryness before starting the dilution water over the column. If a 1 mL volume of methanol is used (for 200 mL of effluent on a 3 mL SPE column) and the sorption and elution efficiency are 100%, any substances retained by the columns will be concentrated 200x. To test the eluate, 150 μ L of the methanol fraction is diluted to 10 mL with dilution water. The resultant methanol concentration is 1.5%, which is below the 48-h or 96-h LC50 for all species given in Table 8-3. This provides a concentration of effluent constituents 3x whole effluent concentration. This small

amount of concentration over whole effluent allows detection even if some loss occurred either in sorption or elution.

If the post-column effluent is not toxic or less toxic, and the methanol eluate is toxic, the next step is to proceed with the Phase II C_{18} SPE procedure to identify the toxicant(s) removed by the column. At this point it should not be assumed that toxicity removed by the C_{18} SPE column is due to non-polar organic compounds. While metals are not non-polar organic chemicals, they can be removed from some effluents using the C_{18} SPE column. However, metals generally are not eluted with methanol and therefore the fractions are not toxic. Metals may be eluted with dilution water adjusted to pH 3 or pH 11. Surfactants can be sorbed by the C_{18} SPE column just as other non-polar organics, and some elute with methanol.

If neither the post-column effluent nor the methanol fraction is toxic, the toxicant is probably retained by the C_{18} SPE column but is not covered by the methanol elution. When interpreting these results it is important to consider that when a sample is passed over the C_{18} column there can be other mechanisms besides reverse phase SPE by which a toxicant(s) can be removed. For example, the C_{18} column packing may remove toxic compounds by filtering them out of solution, e.g., the toxicant may be associated with solids in the effluent, and the 40 μ m C_{18} packing material may remove the solids. The toxic compounds could also be physically adsorbed or ionically bound onto the surface of the column packing and the methanol elution cannot recover the toxicant from the column. Perhaps the toxicant(s) has been removed by the reversed phase SPE mechanism but the methanol does not recover the toxicant(s) because either methanol is too polar a solvent or the toxicants have too low a solubility in methanol. In this case a different solvent system may be needed to remove the toxicants, e.g., methylene chloride, hexane or pH adjusted water. Both hexane and methylene chloride are much more toxic than methanol, and if hexane or any other "toxic" solvent is used, solvent exchange or some other method must be used to remove the solvent in order to effectively track toxicity throughout the procedure. Another possibility that should be considered is that the toxicant has decomposed. Whatever the mechanism of toxicant removal, the interpretation of the loss of toxicity should be evaluated carefully.

After passage through the C_{18} column, some effluents exhibit artifactual toxicity which is not observed in the post-column dilution water blanks. Artifactual toxicity can arise from two sources: a) pH drift and/or b) biological growth in the post-column effluent. (Problems with pH drift are discussed in Section 8.3; consult that section for further information.) Artifactual toxicity from biological growth in the post-column effluent can be a major problem for some effluents, particularly municipal effluents. This growth has not been observed in all effluents, but for the effluents where it did occur, it was present in nearly every post-column sample. The post-

Figure 8-14. Example data sheet for effluent solid phase extraction test with and without pH adjustment.

Test Type: <i>C₁₀ SPE</i> Test Initiation (Date & Time): _____ Investigator: _____ Sample Log No., Name: _____ Date of Collection: _____	Species/Age: _____ No. Animals/No. Reps: _____ Source of Animals: _____ Dilution Water/Control: _____ Test Volume: _____ Other Info: _____
---	---

% Eff. conc.	Survival Readings:																	
	pH 3						pH i						pH 11					
	0 h pH	Post-column vol*	24 h A pH	48 h A pH	72 h A pH	96 h A pH	0 h pH	Post-Column vol*	24 h A pH	48 h A pH	72 h A pH	96 h A pH	0 h pH	Post-Column vol*	24 h A pH	48 h A pH	72 h A pH	96 h A pH
4x-LC50		25						25						25				
2x-LC50		25						25						25				
1x-LC50		25						25						25				
0.5x-LC50		25						25						25				
4x-LC50		150						150						150				
2x-LC50		150						150						150				
1x-LC50		150						150						150				
0.5x-LC50		150						150						150				
0		blank						blank						blank				

Note: See baseline data sheet for control data.

Volumes and Strength of Solutions Added:

	HCL	NaOH		HCL	NaOH	
Post-Column	_____	_____	Post-Column	_____	_____	Comments: _____
25 mL pH 3	_____	_____	150 mL pH 3	_____	_____	
25 mL pH i	_____	_____	150 mL pH i	_____	_____	
25 mL pH 9	_____	_____	150 mL pH 9	_____	_____	

* Volume through column.

8-31

18811

Table 8-3. Toxicity of methanol to several freshwater species

Species	Lifestage	LC50 (% v/v (95% CI))			
		24 h	48 h	72 h	96 h
<i>Ceriodaphnia dubia</i>	≤6 h ¹	>3.0 (—)	>3.0 (—)		
	≤24 h ¹	2.7 (2.6 - 2.9)	2.7 (2.6 - 2.9)		
	≤48 h ¹	2.4 (2.2-2.6)	2.0 (1.9-2.2)		
<i>Daphnia magna</i>	≤24 h ²	NR	3.2 ³ (2.5-3.7)		
<i>Daphnia pulex</i>	≤14 h ⁴	2.5 ⁵ (2.3-2.8)	NR		
<i>Hyalella azteca</i>	juvenile ⁴	2.5 ⁵ (1.9-2.8)	NR	NR	NR
<i>Salmo gairdneri</i>	juvenile ⁴	2.5 (2.5-2.7)	2.5 (2.5-2.7)	NR	2.5 (2.5-2.7)
<i>Pimephales promelas</i>	≤24 h ¹	4.0 (—)	4.0 (—)	3.7 (3.2-4.2)	3.7 (3.2-4.2)
	28-32 d ⁶	3.8 (3.7-3.9)	3.8 (3.7-3.9)	NR	3.7 (3.6-3.9)
<i>Lepomis macrochirus</i>	juvenile ⁴	2.4 (2.2-2.7)	2.4 (2.2-2.7)	NR	1.9 (1.8-2.3)

¹ Data generated at ERL-Duluth. *C. dubia* were ≤24 h old at test initiation and fed. (Tested in soft reconstituted water (DMW); static and unmeasured.)

² Randall and Knopp, 1980. (Tested in spring water; static and unmeasured.)

³ 48-h EC50.

⁴ Bowman et al., 1981. (Tested in well-water; static and unmeasured.)

⁵ 18-h LC50.

⁶ Poirier et al., 1986. (Tested in Lake Superior water; flow-through and concentrations measured.)

Note: (—) = Confidence interval cannot be calculated as no partial mortality occurred; NR = Not reported.

column samples exhibited a turbid, often filamentous growth and sometimes, lower than normal DO levels in the toxicity tests. In one effluent, this growth was caused by methylotrophic bacteria. Methanol occurs in post-column effluent samples because the methanol used in conditioning (activating) the C₁₈ SPE column is slowly leached out of the column and into the effluent as it passes through the column.

Methods for eliminating or controlling this type of artifactual toxicity problem are currently limited. For some effluents, the most promising method appears to be additional filtering of the post-column effluent through a 0.2 µm filter to remove bacteria prior to testing. Whole effluent filtered through a 0.2 µm filter serves as a control for the toxicity test with the post column/filtration manipulation. Filtration is easy to perform and allows useful post-column toxicity data to be obtained, provided it does not alter or reduce toxicity in the post-column effluent. If toxicity is removed in the 0.2 µm filtered post-column effluent, but not in the 0.2 µm filtered whole effluent, repeat the experiment filtering the whole effluent with 0.2 µm filter and testing the post-C₁₈ 0.2 µm filtered effluent. The post-column (0.2 µm filtered effluent) may need to be filtered (0.2 µm) again. If toxicity is removed by filtration, see Section 8.4 Results/Subsequent Tests. If this growth in the post-column cannot be eliminated but toxicity occurs in

the methanol eluate, then proceed with Phase II identification. If growth is not eliminated and no toxicity occurs in methanol eluate, then use of different solvents to condition the C₁₈ column may reduce growth (e.g., acetonitrile). Control of the turbid growth may also be possible by performing daily renewals with post-column effluent. Initially, more post-column sample would have to be collected (60 mL rather than 30 mL), and a portion should be refrigerated. If control of the artifactual toxicity caused by the turbid growth cannot be achieved, other sorbents (e.g., XADs, activated carbon) may have to be used. Another possible method of controlling the growth may be by the use of antibiotics but we have not investigated this approach.

Observation and judgement must be used to detect problems occurring from artifactual toxicity and only through experience can one recognize when they occur. Failure to recognize them will result in the conclusion that the C₁₈ SPE column did not remove toxicity when it in fact may have done so.

If toxicity occurred in the methanol eluate from a POTW effluent, and the *C. dubia* were more sensitive than fathead minnows, it might be cost-effective to try adding a metabolic blocker, piperonyl butoxide (PBO), to the effluent and eluate. We have frequently found non-polar organics in POTW effluents and have identified organophosphate pesticides (OP's) as the toxicant(s)

to *C. dubia* (Amato et al., 1992; Norberg-King et al., 1991). Most metabolic blockers used in aquatic toxicology have been used with fish; however, OP's are generally less acutely toxic to most fish than to cladocerans. PBO is a synthetic methylenedioxyphenyl that can block the toxicity of various chemicals that need to be metabolized in the cytochrome P450 cycle to be toxic. In tests with cladocerans, sublethal additions of PBO to the whole effluent and/or the methanol eluate test have been useful for implicating some metabolically activated OP's as the toxicant(s) (Ankley et al., 1991). Experiments showed that for *C. dubia*, *D. magna*, and *D. pulex*, PBO blocked the acute toxicity of parathion, methyl parathion, diazinon, and malathion, but not dichlorvos, chlorfenvinphos, and mevinphos. For those OP's where PBO reduced the toxicity, the reduction was greater in the first 24 h; the toxicity of the OP's in an effluent may be expressed after 24 h.

To perform the PBO addition test for cladocerans, a PBO water stock is prepared and microliter quantities are added at various sublethal concentrations (final concentrations of PBO are 500, 250, and 125 µg/L). (Note: the 48-h LC50's for *C. dubia*, *D. magna*, and *D. pulex* are 1,000, 2,830, and 1,620 µg/L, respectively). The PBO additions can be set up in a similar manner to the EDTA and oxidant reduction tests (Section 8.7 and 8.8) using a 3 x 3 matrix of PBO and effluent concentrations. Toxicity reduction with the addition of PBO would suggest the presence of toxic levels of metabolically-activated compounds such as OP's. However if toxicity was not changed, it does not mean those types of compounds (i.e., OP's) will not be present. Further tests with PBO will be described in the second edition of Phase II.

8.7 Oxidant Reduction Test

Principles/General Discussion:

This test is designed to determine to what extent constituents reduced by the addition of sodium thiosulfate ($\text{Na}_2\text{S}_2\text{O}_3$) are responsible for effluent toxicity. Chlorine, a commonly used biocide and oxidant, is frequently found at acutely toxic concentrations in municipal effluents. Chlorine is unstable in aqueous solutions and decomposition is more rapid in solutions when chlorine is present at low concentrations. Phase I initial aeration tests will provide information on chlorine toxicity as will the oxidant reduction test. However, this oxidant reduction test does not simply affect chlorine toxicity. Also neutralized in this test are other chemicals used in disinfection (such as ozone, and chlorine dioxide), chemicals formed during chlorination (such as mono and dichloramines), bromine, iodine, manganous ions, and some electrophile organic chemicals. Frequently, the reduced form of the toxicant has a much lower toxicity.

Although the thiosulfate addition test was initially designed to determine if oxidants (such as chlorine) are responsible for effluent toxicity, thiosulfate can also be a chelating agent for some cationic metals. Consequently, reductions in effluent toxicity observed with this test may be due to the formation of metal com-

plexes with the thiosulfate anion (Giles and Danell, 1983). Cationic metals that appear to have this potential for complexation (based upon their equilibrium stability constants) include cadmium (Cd^{2+}), copper (Cu^{2+}), silver (Ag^+), and mercury (Hg^{2+}) (Smith and Martell, 1981). However, the rate of formation of the complex is specific for various metals and some cationic metals may not be rendered non-toxic in the 48-h or 96-h period used for the toxicity test due to a slow complexation rate.

Recent work using *C. dubia* has shown that sodium thiosulfate (and EDTA) can remove the toxicity of several cationic metals (Hockett and Mount, in preparation) from dilution water and effluents. The toxicity of copper, cadmium, mercury, silver and selenium (as selenate) at 4x the 24-h LC50 of each in moderately hard reconstituted water was removed by the levels of thiosulfate typically added in this test. Mercury toxicity was removed with the addition of thiosulfate for 24 h but not 48 h, indicating it may not have been completely complexed by the thiosulfate. In addition, tests with zinc, manganese, lead, and nickel and thiosulfate, indicated that the metal toxicity was not removed by thiosulfate. However, with these metals and the addition of EDTA, the toxicity to *C. dubia* was complexed (cf., Section 8.8, EDTA Test). Knowing which metals are bound by both thiosulfate and EDTA, and which metals are complexed with only one or the other additives can be very helpful in narrowing down the possible toxicant.

Data on the toxicity of sodium thiosulfate to *Ceriodaphnia dubia*, *Daphnia magna* and fathead minnows are given in Table 8-4. Data generated at ERL-D show that for *Ceriodaphnia*, both feeding and lower hardness waters results in greater thiosulfate toxicity, and this trend appears to be the same for fathead minnows (Table 8-4). In effluents, some of the added thiosulfate will combine with certain oxidants present, thereby lowering the concentration of the reactive and toxic thiosulfate. Therefore, the LC50 values indicate that less toxicity due to thiosulfate (Table 8-4) might be expected in effluents than in dilution water (i.e., reconstituted water) where no oxidants are present to react with the thiosulfate. More importantly, when an effluent concentration of 4x the LC50 is tested, toxic oxidant levels should not be excessively high. As a result there should not be a need to add very large amounts of thiosulfate to neutralize toxic oxidants in the test solution.

Additions of sodium thiosulfate for this test can be approached in either of two ways; a gradient of thiosulfate concentration can be added to several test chambers containing the same effluent concentration or as a dilution test where a 3 by 3 matrix of effluent concentrations and thiosulfate concentrations are used.

For the gradient approach, concentrations of sodium thiosulfate equal to and lower than the thiosulfate LC50 for the test species being used are added to several containers with effluent at the 4x-LC50 (or 100%) concentration (cf., Figure 8-15). If the test species is not listed in Table 8-4, the thiosulfate LC50 will have to

be determined. Time to mortality may also be useful in addition to observing mortality at a fixed time (i.e., 24, 48 or 96 h). Time to mortality measurements are important when no dilutions of the effluent are used.

The dilution approach has the advantage in that LC50s can be calculated to see how much the toxicity was reduced. For this test a matrix of three effluent concentrations and three levels of thiosulfate concentrations are used. The choice of the thiosulfate concentrations to add to the effluent is based on the thiosulfate LC50 for the test species being used in an appropriate dilution water (Table 8-4). Three sets of effluent solutions (i.e., 4x-LC50, 2x-LC50, 1x-LC50 or 100%, 50%, 25%) are prepared. To the first set, thiosulfate is added to each test solution at one-half the thiosulfate LC50; to the second set, thiosulfate is added at one-fourth (0.25x)

the LC50; and to the third set, thiosulfate is added at 0.125x the LC50. In this approach the concentration of thiosulfate remains constant over each effluent dilution series. The test results are compared to the baseline test result to determine the amount of toxicity removal.

For cases where oxidants account for only part of the toxicity, sodium thiosulfate may only reduce, not eliminate the toxicity. The thiosulfate addition test is useful even when chlorine appears to be absent in the effluent. As discussed above, oxidants other than chlorine occur in effluents and this test should not be omitted just because the effluent is not chlorinated. Likewise, removal of toxicity by thiosulfate does not prove that chlorine was the cause of effluent sample toxicity. Refer to the *Results/Subsequent Tests* section below for additional options.

Table 8-4. Toxicity of sodium thiosulfate to *Ceriodaphnia dubia*, *Daphnia magna*, and fathead minnows

Species	Water Type	Life Stage	LC50 (µ/L) (95% CI)			
			24 h	48 h	72 h	96 h
<i>Ceriodaphnia dubia</i> ¹	SRW	≤24 h	2.5	0.85		
			(—)	(0.72-1.0)		
	SRW	≤24 h	1.3	0.88		
			(1.0-1.7)	(0.72-1.1)		
	SRW	≤24 h	1.5	0.95		
			(1.2-2.0)	(0.83-1.1)		
	SRW	≤24 h	2.0	0.84		
			(1.5-2.7)	(0.71-0.99)		
	MHRW	≤24 h	1.7	0.98		
			(1.2-2.2)	(0.62-1.6)		
HRW	≤24 h	6.6	1.6			
		(5.8-7.5)	(—)			
VHRW	≤24 h	5.0	3.3			
		(3.8-6.5)	(2.5-4.3)			
VHRW	≤24 h	6.6	1.8			
		(5.8-7.6)	(1.4-2.3)			
VHRW	≤24 h	5.0	1.2			
		(3.9-6.4)	(0.91-1.6)			
<i>Daphnia magna</i> ²	SRW	NR	2.2	1.3		
			(NR)	(NR)		
<i>Pimephales promelas</i> ³	SRW ³	≤24 h	8.4	8.4	7.9	7.3
			(7.6-9.3)	(7.6-9.3)	(7.4-8.5)	(6.4-8.3)
	SRW ¹	≤24 h	7.4	7.1	7.1	5.9
			(6.3-8.9)	(5.9-8.4)	(5.9-8.4)	(4.3-7.9)
	MHRW ³	≤24 h	9.5	8.9	8.2	4.7
			(—)	(8.1-9.7)	(7.3-9.2)	(3.9-5.6)
	MHRW ¹	≤24 h	9.8	9.8	9.8	9.8
			(—)	(—)	(—)	(—)
	HRW ³	≤24 h	11.6	8.5	7.9	7.9
			(9.7-13.9)	(7.2-10.0)	(6.9-9.1)	(6.9-9.0)
	HRW ¹	≤24 h	12.9	12.9	12.5	11.7
			(11.8-14.1)	(11.8-14.1)	(11.3-13.8)	(10.4-13.0)
VHRW ³	≤24 h	13.3	7.8	6.7	6.1	
		(11.8-15.7)	(6.5-9.2)	(5.5-8.2)	(4.8-7.9)	
VHRW ¹	≤24 h	13.4	12.1	12.1	12.1	
		(11.8-15.3)	(10.8-13.4)	(10.8-13.4)	(10.8-13.4)	

¹ Data generated at ERL-Duluth; both species were ≤24 h old at test initiation and *C. dubia* were fed.

² Dowden and Bennett, 1965.

³ Data generated at ERL-Duluth and values represent those from 7-d growth and survival tests and daily renewals.

Note: (—) = Confidence interval cannot be calculated as no partial mortality occurred; NR = Not reported; VSRW = very soft reconstituted water; SRW = soft reconstituted water; MHRW = moderately hard reconstituted water; HRW = hard reconstituted water; VHRW = very hard reconstituted water.

Volume Required:

A maximum volume of 100 mL effluent is required for the oxidant reduction test. The exact volume required will depend on the 24-h initial LC50. For the gradient addition, six effluent aliquots at 4x-LC50 or (100%) are required, each having different thiosulfate concentrations. For the dilution test, three sets of three effluent solutions are prepared (i.e., 4x-, 2x-, 1x- 24-h LC50) and three different concentrations of sodium thiosulfate (e.g., 0.25, 0.5, and 1.0 g/L) are each added to a set of dilutions.

Apparatus:

Glass stirring rods, glass volumetric flask for sodium thiosulfate, 1 mL glass pipettes, automatic pipette, disposable pipette tips, 10 - 1000 μ L pipettes, eye dropper or wide bore pipette, 30 mL beakers or 1 oz plastic cups, light box and/or microscope (optional), pH meter and probe.

Reagents:

Regardless of whether the 1 x 6 gradient addition test or the dilution test is to be done, the sodium thiosulfate stock concentration should be 10x the sodium thiosulfate LC50 concentration for the test species being used.

Test Organisms:

Test organisms, 50 or more, of the same age and species.

Procedure:

Day 2: To perform the gradient thiosulfate addition test, transfer six 10 mL aliquots of effluent diluted to 4x-LC50 (or 100%) into six test chambers. Add 1.0, 0.8, 0.6, 0.4, and 0.2 mL of the appropriate concentration of the thiosulfate stock to five aliquots and mix. Do not add any to the sixth. The container receiving 1 mL of thiosulfate should now contain the approximate concentration of sodium thiosulfate equal to the LC50 of the test species. Figure 8-15 contains an example form for recording the data. A suggested schedule for observing time to mortality is shown on the data form.

To perform the thiosulfate dilution addition test, prepare three sets of effluent dilutions (i.e., 4x-LC50, 2x-LC50, 1x-LC50) and add the appropriate amount of thiosulfate (i.e., 0.5x, 0.25x, and 0.125x thiosulfate LC50) for the test species to each set of dilutions. Figure 8-16 is an example data sheet for the thiosulfate addition test using this effluent dilution approach. The baseline test conducted at the same time will provide information on effluent toxicity without thiosulfate added.

Interferences/Controls and Blanks:

Controls prepared for the baseline toxicity test act as a check on the general health of test organisms, dilution water quality and test conditions.

When the time to mortality in the various thiosulfate exposure concentrations in the gradient addition test is compared to the treatment without thiosulfate, one can

determine whether the addition of thiosulfate increased the time to mortality at some thiosulfate concentration. If, in all of the effluent exposures, the time to mortality decreases, then thiosulfate is affecting toxicity. If all test solutions cause mortality in the thiosulfate effluent dilution test, but this trend does not occur in the baseline test, the thiosulfate may be causing the toxicity. In either case, the test should be repeated with weaker sodium thiosulfate additions. If the toxicity is unchanged, perhaps not enough sodium thiosulfate was added, and the test can be repeated using a higher range of the thiosulfate additions.

If a significant loss in effluent toxicity is apparent over the first 24-h period after sample arrival in the laboratory (i.e., initial LC50 < baseline LC50), it may be necessary to conduct future oxidant reduction tests for Phase I immediately upon arrival of the sample in the laboratory.

Results/Subsequent Tests:

If oxidants are causing toxicity, time to mortality should increase somewhere in the range of tested thiosulfate additions or the toxicity should be reduced from the baseline LC50. No change in toxicity suggests either no oxidant toxicity or not enough thiosulfate was added. The experiment should be repeated, increasing the concentration of thiosulfate added.

When the LC50s from the sodium thiosulfate addition dilution test indicate toxicity was reduced when compared to the baseline LC50, thiosulfate has either reduced or complexed the toxicant(s). If the highest addition of thiosulfate increases the toxicity of the sample, the thiosulfate itself may be at a toxic concentration. However, if the LC50 for the next lower addition of thiosulfate of the effluent dilutions reduced and/or removed toxicity, then more tests for oxidants or metals should be explored.

If oxidant toxicity is evident, a measurement of free chlorine should be made and the concentration compared to the chlorine toxicity value for the test species used. For identification it may be necessary to measure mono and dichloramine since they have different toxicities than free chlorine (see Phase III for confirming mixtures as toxicants). A comparison of the aeration and C_{18} SPE test results to the oxidant reduction test results may provide even more information on the physical/chemical nature of the oxidants.

For those effluents where chlorine is measurable, dechlorination may be achieved by the use of sulfur dioxide (SO_2) gas. This technique used was developed by T. Waller (personal communication, University of North Texas, Denton, TX). (Note: Caution in handling the SO_2 should be exercised because it is an extreme irritant.) As with thiosulfate, SO_2 may also reduce compounds other than chlorine. This information can be useful when one needs to know if substances other than chlorine are causing the toxicity.

To dechlorinate using SO_2 , the following procedure is used. Place 10 mL of high quality distilled water into

Figure 8-15. Example data sheet for the oxidant reduction test when using a gradient of sodium thiosulfate concentrations.

Test Type: <i>Oxidant Reduction</i>	Species/Age: _____
Test Initiation (Date & Time): _____	No. Animals/No. Reps: _____
Investigator: _____	Source of Animals: _____
Sample Log No., Name: _____	Dilution Water/Control: _____
Date of Collection: _____	Test Volume: _____
	Other Info: _____
	4x-LC50: _____ or 100% _____
	TRC: _____

mL Stock Added to ____% Effluent	0 h pH	Survival Readings:						
		2 h A pH DO	4 h A pH DO	8 h A pH DO	24 h A pH DO	48 h A pH DO	72 h A pH DO	96 h A pH DO
1.0								
0.8								
0.6								
0.4								
0.2								
0.0								

Note: See baseline data sheet for control data.

Stock Concentration = _____ g/L $\text{Na}_2\text{S}_2\text{O}_3$

Comments:

Figure 8-16. Example data sheet for the oxidant reduction test when effluent dilutions are used.

Test Type: Oxidant Reduction	Species/Age: _____
Test Initiation (Date & Time): _____	No. Animals/No. Reps: _____
Investigator: _____	Source of Animals: _____
Sample Log No., Name: _____	Dilution Water/Control: _____
Date of Collection: _____	Test Volume: _____
	Other Info: _____
	4x-LC50: _____ or 100% _____
	TRC: _____

% Effluent	Conc. Thiosulfate	mL Stock Used	0 h pH	Survival Readings:							
				24 h		48 h		72 h		96 h	
				A	DO	A	DO	A	DO	A	DO
4x-LC50	0.5x LC50										
2x-LC50	0.5x LC50										
1x-LC50	0.5x LC50										
4x-LC50	0.25x LC50										
2x-LC50	0.25x LC50										
1x-LC50	0.25x LC50										
4x-LC50	0.125x LC50										
2x-LC50	0.125x LC50										
1x-LC50	0.125x LC50										

Note: See baseline data sheet for control data. Baseline test also serves as toxicity blank for this additive test.

Stock Concentration = _____ g/L Na₂S₂O₃

Comments:

a graduated cylinder. Bubble the SO_2 gas directly into the water for about 5 min to prepare SO_2 -saturated water. (Caution: This saturation procedure must be done in a hood!) For a first attempt at the amount of SO_2 to add without the TRC measured we use 2 μL of the SO_2 -saturated water per 100 mL of effluent with TRC values of 0-5 mg/L. This amount of SO_2 is not acutely toxic and is effective at removing most commonly encountered TRC concentrations. For measured chlorine concentrations, proportional amounts of SO_2 -saturated water have been used as follows: for 0.02 mg/L TRC add 3.6 μL SO_2 -saturated water to 1 L of sample; for 0.16 mg/L TRC, add 12 μL SO_2 -saturated water; for 1.3 mg/L TRC add 39 μL SO_2 -saturated water; and for 2.1 mg/L TRC add 64 μL SO_2 -saturated water (T. Waller, personal communication). Another technique to remove the chlorine is being explored at present. The use of sodium bisulfite solutions added in the same way as sodium thiosulfate solutions are added is being explored.

In cases where both the oxidant reduction test and EDTA chelation test reduce the toxicity in the effluent sample, there is a strong possibility that the toxicant(s) may be a cationic metal(s). For example, thiosulfate and EDTA both reduce the toxicity of copper, cadmium, and mercury. At this point, the Phase II methods for identification for cationic metal(s) toxicants should be investigated.

8.8 EDTA Chelation Test

Principles/General Discussion:

To determine the extent to which effluent toxicity is caused by certain cationic metals, increasing amounts of a chelating agent (EDTA; ethylenediaminetetraacetate ligand) are added to aliquots of the effluent sample. The form of the metal (e.g., the aquo ion, insoluble complex) has a major effect on its toxicity to aquatic organisms (Magnuson et al., 1979) and specific metal forms are more important in aquatic toxicity than the total quantity of the metal.

EDTA is a strong chelating agent, and its addition to water solutions produces relatively non-toxic complexes with many metals. The success of EDTA in removing metal toxicity is a function of solution pH, the type and speciation of the metal, other ligands in the solution, and the binding affinity of EDTA for the metal versus the affinity of the metal for the tissues of the organism (Stumm and Morgan, 1981). Because of its complexing strength, EDTA-metal complexes will often displace other soluble forms such as chlorides and oxides of many metals. Among the cations typically chelated by EDTA are aluminum, barium, cadmium, cobalt, copper, iron, lead, manganese (2^+), nickel, strontium, and zinc (Stumm and Morgan, 1981). EDTA will not complex anionic forms of metals such as selenides, chromates and hydrochromates, and forms relatively weak chelates with arsenic and mercury. For those metals with which it forms relatively strong complexes, the toxicity of the metal to aquatic organisms is frequently reduced. EDTA has been shown to chelate the

toxicity to *C. dubia* due to copper, cadmium, zinc, manganese, lead, and nickel (Hockett and Mount, In Preparation) in both dilution water and effluents. However, it was also found that EDTA did not complex the toxicity of silver, selenium (either as sodium selenite or sodium selenate), aluminum ($\text{Al}(\text{OH})_3$), chromium (either as chromium chloride or potassium dichromate), or arsenic (either sodium m-arsenite or sodium arsenate) when tested using moderately hard water and *C. dubia*.

Since EDTA chelates calcium and magnesium (albeit weakly) the choice of the level of EDTA to add was originally (EPA, 1988A) based on the premise that calcium and magnesium had to be chelated before toxic metals would be. However, recent work has shown that the toxicity due to cationic metals was reduced regardless of water hardness. Therefore the mass of chelating agent required should be approximated because excess EDTA becomes toxic when present above a certain concentration. The range of EDTA concentrations that will adequately bind the metals but is not toxic appears to be smaller than that for sodium thiosulfate and oxidants.

Table 8-5 contains LC50s of EDTA for *Ceriodaphnia* and fathead minnows at various hardness and salinity values. Note that the concentration of EDTA tolerated by organisms increases directly with both water hardness and salinity. By measuring the hardness and salinity of the effluent, the range of EDTA concentrations that should not be toxic in an effluent sample can be estimated. "Salinity" not due strictly to NaCl will have different effects on toxicity. This calculation, for prediction of the EDTA concentration, is more involved than is at first apparent. The data in Table 8-5 indicate that over the physiological range of hardness and salinity, hardness affects the toxicity of EDTA more than NaCl. The usual methods for measurement of salinity (conductivity meter, salinometer or refractometer) do not specifically measure sodium chloride. The choice of EDTA concentrations should always be based first on hardness and secondly on salinity when the salinity is known. The particular combination of hardness and salinity present in an effluent sample may have to be tested to get an accurate EDTA LC50. If the salinity is composed of ions other than sodium and chloride, the hardness of the dilution water should be made equal to the effluent hardness and the additional "salinity" added in the form of other major cations and anions such as potassium, sulfate and carbonate.

An EDTA LC50 value derived in a standard dilution test water (such as reconstituted water) is likely to be much lower than the LC50 of EDTA added to an effluent. For example, the values contained in Table 8-5 represent worst case conditions presented by EDTA in dilution water. Likewise, the toxic concentration of EDTA in one effluent will probably not be the same as the concentration causing toxicity in a different effluent or even a different sample of the same effluent. For this reason the concentrations of EDTA added to the effluent should bracket the expected LC50 based on clean water with a similar hardness and salinity value as per

Table 8-5. Toxicity of EDTA to *Ceriodaphnia dubia* and fathead minnows in water of various hardnesses and salinities

Species	Water Type	Hardness (mg/L as CaCO ₃)	Salinity ¹ (ppt)	LC50 (µg/L) (95% CI)			
				24 h	48 h	72 h	96 h
<i>Ceriodaphnia dubia</i>	VSRW	10-13	0	0.04 (0.03-0.04)	0.03 (—)		
	SRW	40-48	0	0.12 (0.10-0.13)	0.11 (—)		
	MHRW	80-100	0	0.23 (0.21-0.27)	0.22 (—)		
	HRW	160-180	0	0.50 (0.42-0.60)	0.44 (—)		
	VHRW	280-320	0	0.71 (0.58-0.87)	0.41 (0.36-0.47)		
	SRW	40-48	0.5	0.05 (—)	0.05 (—)		
	SRW	40-48	1	0.12 (0.10-0.13)	0.11 (—)		
	SRW	40-48	2	0.33 (0.27-0.41)	0.23 (0.21-0.27)		
	SRW	40-48	3	0.44 (—)	0.32 (0.23-0.45)		
	<i>Pimephales promelas</i>	VSRW	10-13	0	0.04 (0.03-0.04)	0.03 (0.03-0.04)	0.03 (0.03-0.04)
SRW		40-48	0	0.14 (0.12-0.18)	0.14 (0.12-0.18)	0.11 (0.08-0.14)	0.08 (0.07-0.09)
MHRW		80-100	0	0.29 (0.23-0.35)	0.27 (0.22-0.33)	0.27 (0.22-0.33)	0.25 (0.20-0.31)
HRW		160-180	0	0.54 (0.43-0.66)	0.50 (0.40-0.62)	0.47 (0.36-0.60)	0.44 (0.34-0.56)
VHRW		280-320	0	0.81 (0.68-0.97)	0.81 (0.68-0.97)	0.81 (0.68-0.97)	0.81 (0.52-0.83)
SRW		40-48	0.5				0.11 (—)
SRW		40-48	1				0.17 (0.13-0.21)
SRW		40-48	2				0.23 (0.17-0.32)
SRW		40-48	3				0.37 (0.28-0.48)

¹ Brine from evaporated seawater used as source of salinity. All data generated at EPA ERL-Duluth. All *C. dubia* were ≤24 h old and the fathead minnows were all ≤36 h old at test initiation. *Ceriodaphnia* were fed; see section on toxicity tests for details.

Note: (—) = Confidence interval cannot be calculated as no partial mortality occurred; NR = Not reported; VSRW = very soft reconstituted water; SRW = soft reconstituted water; MHRW = moderately hard reconstituted water; HRW = hard reconstituted water; VHRW = very hard reconstituted water.

the above discussion. The complexation of metals with EDTA may not be immediate after the addition of EDTA. Therefore, it is recommended that the EDTA test solutions be set up first and these solutions allowed to sit for the duration of pH adjustments and other manipulations before the introduction of test organisms. This is at least 2 h.

As with the oxidant reduction test, the EDTA can be added in two ways; a gradient of EDTA can be added to replicate of one effluent concentration or three concentrations of EDTA can be added to three sets of effluent dilutions. The effluent itself is used as a control rather than a blank based on dilution water as in the pH adjustment test. The gradient addition test is done by adding increasing concentrations of EDTA to several aliquots of the effluent (4x-LC50 or 100%). The goal of this test is to add enough EDTA to reduce metal toxicity. At some EDTA addition the metals will be chelated

and the EDTA will not be present at toxic concentrations. At lower EDTA additions the metal toxicity is not removed; in the midrange of the EDTA additions the metals will be rendered non-toxic by the EDTA, and at the high end of the range of EDTA additions, the unreacted EDTA is itself toxic. By using an effluent concentration of 4x-LC50 (or 100% if the LC50 is greater than 25%) the potential for exceeding the binding capability of the added EDTA is lessened, especially for very toxic effluents (LC50 <10%).

To conduct the EDTA test using effluent dilutions, three addition levels of EDTA (using one stock) are selected (based on the LC50 of EDTA for the species of choice). Each of these three EDTA levels are then added to effluent dilution tests in a 3 x 3 matrix. The EDTA is added to the 4x-, 2x-, and 1x-LC50 test cups after the effluent solutions are prepared so that the three EDTA concentrations are constant across each

set of effluent dilutions. For example, 0.2 mL of an EDTA stock solution is added to test cups containing effluent at 4x-LC50, 2x-LC50, 1x-LC50 or 100%, 50%, and 25%. To the next set of test cups of same effluent dilution sequence, 0.05 mL of the EDTA stock solution is added and likewise 0.0125 mL is added to the third set of test cups.

To determine the amount of EDTA to add, one can use the hardness titration, the measurement of calcium and magnesium concentrations, or the concentration of EDTA at the EDTA LC50 for the species of interest. These are described in the *Procedure* below.

Volume Required:

A volume of 100 mL effluent usually is required for the EDTA chelation test. The exact volume needed will depend on the 24-h initial LC50 and the particular option chosen to determine the EDTA addition.

Apparatus:

Glass stirring rods, glass volumetric for EDTA stock solution, automatic pipette, disposable pipette tips, 10, 100, and 1000 μ L pipettes, eye dropper or wide bore pipette, 30 mL beakers or 1 oz plastic cups, light box and/or microscope (optional).

Reagents:

EDTA (disodium salt, Na_2 EDTA) stock solution (see discussion under *Procedure*), reagents for determination of effluent hardness and salinity (APHA, 1980; Methods 314 and 210).

Test Organisms:

Test organisms, 50 or more, of the same age and species.

Procedure:

Day 2: There are three ways to determine the concentration of EDTA stock to prepare.

The first and the most accurate approach (when it can be used) is to measure the hardness of the 4x-24-h LC50 effluent concentration (or 100% when the LC50 is >25%) using the standard method for measuring hardness (APHA, 1980). The concentration of EDTA that produced the endpoint in the hardness titration of the effluent sample is the concentration of EDTA needed at the 0.2 mL addition for either the EDTA gradient test or the effluent dilution test. An example illustrates this calculation. In a 36% effluent sample (4x-LC50), 5 mL of 0.01 M EDTA was needed to titrate the hardness (100 mL sample size). For the gradient test, 7 EDTA concentrations will be added to several test chambers, all containing one concentration of effluent (4x-LC50). The concentration of EDTA required for the hardness titration is the highest additive concentration. For a 10 mL test volume of 36% effluent, when 0.5 mL of 0.01 M EDTA stock was added the resultant EDTA concentration is that which is desired at the 0.2 mL addition. To provide this EDTA concentration at the 0.2 mL addition (minimizing the volume addition), increase the 0.01 M

EDTA concentration (concentration of EDTA used in titration) by $0.5/0.2$ or $2.5 \times = 0.025$ M EDTA stock. (Note: Molecular weight (MW) of Na_2 EDTA is 372.3 g.)

The second approach is used when the hardness measurement endpoint cannot be discerned because of interferences. If the hardness cannot be titrated, measure the calcium (Ca^{2+}) and magnesium (Mg^{2+}) of the sample using atomic absorption procedures, and calculate the amount of EDTA needed to chelate the calcium and magnesium. EDTA binds with both Ca^{2+} and Mg^{2+} on a 1:1 molar basis. The combined number of moles of Ca^{2+} (MW=40.1 g) and Mg^{2+} (MW=24.3 g) in 10 mL of effluent at 4x-LC50 equals the number of moles of EDTA needed for the 0.2 mL addition for a 10 mL sample. This calculated concentration should be added at the 0.2 mL addition for either the gradient or dilution test. The calcium and magnesium should be measured at 100% effluent if the LC50 is greater than 25%.

The third approach, and the one we use most frequently, is to use the EDTA LC50 concentration to select addition levels. This approach allows for either a gradient of EDTA additions to 100% (4x-LC50) solutions or EDTA additions to effluent dilution tests. Choice of the EDTA LC50 must be based on effluent hardness (and salinity). It may be necessary to determine the EDTA LC50 for the particular combination of effluent hardness and salinity and test organism used.

After the concentration for the stock solution of EDTA has been determined, the EDTA gradient test can be set up. The EDTA LC50 is generally set at the 0.2 mL addition. To perform the gradient EDTA addition test, 7 aliquots of the effluent are prepared at a concentration equal to 4x-LC50, or 100% effluent where the initial 24-h LC50 is greater than 25%. Next, 0.4 mL of the appropriate EDTA stock is added to the first 10 mL aliquot of the effluent, 0.2 mL is added to the second 10 mL sample of effluent, 0.1 mL to the third, and so on until the sixth 10 mL effluent sample has received 0.0125 mL. The seventh is an effluent blank used to compare treatment effects on time to mortality (see Figure 8-17). A microliter syringe will be needed for the smaller additions. If the effluent has a low toxicity (LC50 = 50-100%) a series of dilution blanks may be necessary to check for the dilution effect of the EDTA stock addition. No more than 10% dilution of the effluent aliquots should be allowed unless a dilution blank series is included.

To perform the EDTA additions using the effluent dilution test, three sets of three effluent concentrations are prepared (100%, 50%, 25%, or 4x-, 2x-, 1x-LC50), while the baseline test serves as the toxicity blank. After the concentration of stock solution of EDTA has been established, add the EDTA using a 3 x 3 matrix. This means that the 0.2 mL addition is added to the 100%, 50%, 25%, 0.05 mL is added to another set, and 0.0125 mL is added to the third effluent set (see Figure 8-18). The EDTA is added after all the dilutions are prepared. To allow the EDTA time to complex the

Figure 8-17. Example data sheet for EDTA chelation test when using a gradient of EDTA concentrations.

Test Type: EDTA Chelation Test Initiation (Date & Time): _____ Investigator: _____ Sample Log No., Name: _____ Date of Collection: _____	Species/Age: _____ No. Animals/No. Reps: _____ Source of Animals: _____ Dilution Water/Control: _____ Test Volume: _____ Other Info: _____ 4x-LC50: _____ or 100% _____
---	---

mL Stock Added	0 h pH	Survival Readings:						
		2 h A pH DO	4 h A pH DO	8 h A pH DO	24 h A pH DO	48 h A pH DO	72 h A pH DO	96 h A pH DO
0.4								
0.2								
0.1								
0.05								
0.025								
0.0125								
0.0								

Note: See baseline data sheet for control data.

Stock Concentration = _____ g/L EDTA

Comments:

Figure 8-18. Example data sheet for the EDTA chelation test when effluent dilutions are used.

Test Type: EDTA Chelation	Species/Age: _____
Test Initiation (Date & Time): _____	No. Animals/No. Reps: _____
Investigator: _____	Source of Animals: _____
Sample Log No., Name: _____	Dilution Water/Control: _____
Date of Collection: _____	Test Volume: _____
	Other Info: _____
	4x-LC50: _____ or 100% _____
	TRC: _____

% Effluent	Conc. EDTA	mL Stock Used	0 h pH	Survival Readings:							
				24 h		48 h		72 h		96 h	
				A	DO	A	DO	A	DO	A	DO
4x-LC50		0.2									
2x-LC50		0.2									
1x-LC50		0.2									
4x-LC50		0.05									
2x-LC50		0.05									
1x-LC50		0.05									
4x-LC50		0.0125									
2x-LC50		0.0125									
1x-LC50		0.0125									

Note: See baseline data sheet for control data. Baseline test also serves as toxicity blank for this additive test.

Stock Concentration = _____ g/L EDTA

Comments:

metals, these samples should be prepared first. The test solutions should not have test organisms added until all other manipulations are performed.

The complexation of metals by EDTA proceeds at a rate which may vary according to the sample matrix. In studies of some aqueous samples containing metal toxicity, better success in demonstrating chelation of metals by EDTA may occur if samples spiked with EDTA remain refrigerated overnight. The next day they are warmed to the test temperature and the pH is adjusted to pH *i* before placing test organisms in the chambers. This allows time for the EDTA to chelate any metals which may be in the sample. The solutions should be mixed thoroughly after spiking with EDTA and before adding the test organisms.

For both the gradient EDTA addition and EDTA dilution tests, the pH of the effluent after addition of EDTA should be checked. Since EDTA is an acid, additions of this reagent will lower the pH of the effluent. The amount of change in solution pH will depend upon the buffering capacity of the effluent and the amount of reagent added. If the pH of the effluent has changed, readjustment of the test solution pH to pH *i* should be performed. When stable pHs are obtained and all other manipulations have been completed, test organisms are added to the test chambers.

Interferences/Controls and Blanks:

Controls prepared for the baseline toxicity test provide quality control for test organisms, dilution water and test conditions. Either the zero mL EDTA addition in the gradient test or the baseline effluent test serves as a blank for use in determining the presence of EDTA toxicity.

For the EDTA gradient test, time to mortality may be recorded at each EDTA addition and then compared to the untreated effluent. If time to mortality is shorter in all treatments than in the untreated effluent, repeat the test using lower EDTA concentrations. If the baseline test has less toxicity than the EDTA additions in the dilution test, then the EDTA may be causing toxicity. If time to mortality or toxicity is not reduced in any treatment, it may be wise to repeat the additions using a higher range of EDTA concentrations. Erratic patterns in mortality cannot be used, and when this occurs it suggests that this test is not appropriate for the particular effluent being studied.

The addition of EDTA to the sample often lowers the pH of the test solution to as low as pH 4.0. If the presence of a pH-dependent toxicant such as ammonia is suspected, then the results of this test must be interpreted cautiously before attributing losses of toxicity to chelation of metals. For instance, a sample which contains ammonia toxicity and an undetermined amount of metal toxicity (perhaps none) may show a loss of toxicity at some EDTA concentrations. A closer look may reveal that pH drifted in these samples to 7.5 or lower, rendering ammonia non-toxic in the sample, and

that metal chelation may have had no role in reducing toxicity. In the same way, the presence of compounds whose toxicity is exacerbated at low pH (e.g., hydrogen sulfide) may confound interpretations of this test. In such a sample, metal toxicity may indeed be reduced by chelation at some EDTA additions; however, the increased toxicity of hydrogen sulfide at the lower pH could mask the metal toxicity loss. In cases such as these, we have returned pH to the initial value, and successfully employed a simple method of pH control (e.g., closing the test vessel) to avoid misleading pH-dependent toxicant interferences. This strategy may need to be attempted to ferret out interferences and obtain useful information from the EDTA addition test.

In certain effluents, EDTA may reduce the toxicity of cationic surfactants. This reduction may appear as a delay in time to mortality. If the EDTA test result is not likely caused by cationic metals, other Phase I procedures, such as sublation during the aeration step, may also indicate surfactant toxicity (cf., Section 8.3 aeration test).

Results/Subsequent Tests:

For the EDTA gradient test, if the appropriate EDTA concentration range is utilized, the time to mortality will not change from that seen in the exposure 4x-24-h LC50 of unaltered effluent at low additions of EDTA. In the 0.2 mL addition, toxicity should be reduced and at higher additions of EDTA, toxicity will be as high or higher than the whole effluent itself due to unbound EDTA toxicity and effluent toxicants other than chelatable metals if present. Time to mortality must be used to detect partial toxicity removal. Toxicity may be removed at all exposures if the lowest addition of EDTA removes metal toxicity and the highest addition does not cause EDTA toxicity. If toxicity is not reduced in any treatment, either the effluent has no chelatable metal toxicity or not enough EDTA was added. Increased toxicity over the toxicity of untreated effluent suggests EDTA toxicity and a lower EDTA range should be tested.

For the EDTA dilution test, if the effluent is less toxic (i.e., LC50 is greater than baseline LC50) in any of the three EDTA addition dilution tests, then the indication is that EDTA removed or reduced the toxicity and therefore metal toxicity is present. If in all three tests the effluent is more toxic (i.e., treatment LC50s are lower than baseline LC50), then the possibility exists that EDTA itself is causing toxicity and the test should be repeated using lower EDTA addition concentrations. If no LC50 of any of the three additions indicates less toxicity than in the baseline test, the possibility of the presence of cationic metals causing toxicity in the effluent is low, but additions of EDTA at higher levels may need to be explored.

If toxicity is reduced in a systematic manner, proceed to Phase II methods for specific identification of the metal(s).

8.9 Graduated pH Test

Principles/General Discussion:

This test is designed to determine whether effluent toxicity can be attributed to compounds whose toxicity is pH dependent. The pH dependent compounds of concern are those with a pK_a that allow sufficient differences in dissociation to occur in a physiologically tolerable pH range (pH 6-9). Also, the two forms of the compound (ionized versus un-ionized) must have detectable toxicity differences to the TIE organism. The ionizable compounds commonly found in municipal and industrial discharges include ammonia, hydrogen sulfide, cyanide, and some organic compounds (e.g., pentachlorophenol). In addition, pH differences can affect metal toxicity through changes in solubility and speciation. The effect of pH on ammonia toxicity might be more readily observed than the effect of pH on the levels of toxicity of metals, hydrogen sulfide, cyanide, and ionizable organics.

Ammonia is frequently present in effluents at concentrations of 5 mg/L to 40 mg/L (and higher). (The ammonia is measured upon arrival of the sample (Section 6) and this information will be helpful for the graduated pH test.) Levels of 5 mg/L to 40 mg/L are likely to cause toxicity when several other effluent conditions occur. Effluent parameters to consider are pH, temperature, DO, CO_2 content, and TDS. Of these parameters, pH has the largest effect on ammonia toxicity, and for many effluents (especially with POTW effluents) the pH of a sample rises upon contact with air. Typically, the pH at air equilibrium ranges from 8.0 to 8.5. Literature data on ammonia toxicity (EPA, 1985B) can be used only as a general guide because of the large effect of very slight pH changes. The pH values for most ammonia toxicity tests are usually not measured or reported fully enough to be useful.

One might expect ammonia to be removed during the pH 11 adjustment/aeration test. Based on our experience, however, ammonia is not substantially removed by the method described in Section 8.5. Other techniques which can be used to remove ammonia related toxicity may also displace metals or other toxicants with completely different physical and chemical characteristics. For example, ion exchange resins (e.g., zeolite) removes ammonia, cationic metals, and possibly organic compounds through adsorption. For these reasons, the graduated pH test is most effective in differentiating toxicity related to ammonia from other causes of toxicity, if it is the dominant toxicant.

Ammonia acts as a basic compound in water. The un-ionized, more toxic form (NH_3) predominates above pH 9.3 and the ionized, essentially non-toxic form (NH_4^+) is most abundant below pH 9.3 at 25°C. Through the pH range of 6-8.5, the percent of ammonia in the toxic form increases 250x over this range. Importantly, as pH increases, the percentage of the toxic form becomes greater but the toxicity of the toxic form is less, and conversely, as pH decreases, the percentage of ammonia (NH_3) decreases, but the toxicity of the NH_3 increases (EPA, 1985B). However, the increase in the

concentration of ammonia occurring in the toxic form with increasing pH is greater than the decrease in its toxicity. The net result is an increased toxicity of a given total ammonia concentration with increased pH. Temperature also affects the dissociation of ammonia, but since the temperature is held constant in these toxicity tests for Phase I, it can be ignored.

Effluent toxicity related to metals may also be detected by the graduated pH test, although these effects are less well documented in effluents than those associated with ammonia toxicity. Acidification of a sample may increase the bioavailable portion of a metal, and in some cases (i.e., cadmium, copper, and zinc) this is countered by a decreasing toxicity of the metal as the test pH decreases. It is known, however, that aluminum toxicity increases as pH diverges from neutral. In experiments in the pH range of 5 to 7 (Campbell and Stokes, 1985), the toxicities of cadmium, copper and zinc were shown to increase with increasing pH while the toxicity of lead decreased with increasing pH. We have found lead and copper to be more toxic to *C. dubia* at pH 6.5 than at pH 8.0 or 8.5, (in very hard reconstituted water) and nickel, zinc, and cadmium were more toxic at pH 8.5 than at 6.5. Since these compounds are also chelatable by EDTA, the results of both tests (the graduated pH test and the EDTA addition test) can give information about whether it is an ionizable compound or a pH sensitive cationic metal. Other metals have exhibited some degree of pH dependence, but these are not as well defined. Results of the graduated pH test should be considered in conjunction with the EDTA addition test (Section 8.8). Whether the metal toxicity can be discerned will depend in large part on the concentration of other pH dependent toxicants in the sample. In order to detect metal toxicity, one must be cautious when selecting a dilution water when the test solutions are at low effluent dilutions because artifactually enhanced toxicity due to metals may be created if the hardness of the dilution water is much different than that of the effluent. This effect may be magnified for metals when coupled with the pH change. A dilution water similar in hardness to the effluent must be used for this test to reveal metal-caused toxicity. If more than one pH dependent toxicant is present, the pH effects may either cancel or enhance one another.

Hydrogen sulfide (H_2S) occurs in wastewaters, and its toxicity can be detected by the graduated pH test. Dissolved sulfide exists in two forms, H_2S and HS^- . The predominant form depends on both pH and temperature, but since temperature is held constant in these Phase I toxicity tests it essentially can be ignored. The un-ionized form (H_2S) is more toxic to aquatic organisms, and at pH 6 it comprises over 90% of the dissolved sulfide, while at pH 7, 50% is un-ionized. At a pH of 8.5, less than 5% of the dissolved sulfide is present in the un-ionized form. Since H_2S is the more toxic form, one would expect to observe an increase in toxicity relative to a decrease in solution pH. When considering results of this type it is wise to check toxicity alteration by the pH adjustment/aeration tests

(Section 8.5). H_2S is readily oxidized and also removed through volatilization; therefore if H_2S is the predominant toxicant, a significant reduction of toxicity should be observed in the pH adjustment/aeration tests.

The effects of pH on toxicity can be used to detect the presence of these pH dependent toxicants. By conducting three effluent tests, each at a different pH, the effluent toxicity can be enhanced, reduced or eliminated. For a typical example (at 25°C) where ammonia is the primary toxicant, when the pH is 6.5, 0.180% of the total ammonia in solution is present in the toxic form (NH_3). At pH 7.5, 1.77% of the total ammonia is present as NH_3 , and at pH 8.5, 15.2% is present as NH_3 . Similar changes in the percent ammonia as NH_3 for pH's 6.5, 7.5 and 8.5 occur at other temperatures, for example, the percentages of un-ionized ammonia at 20°C for pH's 6.5, 7.5, and 8.5 are 0.130%, 1.24% and 11.2%, respectively (EPA, 1979). This difference in the percentages of un-ionized ammonia is enough to make the same amount of total ammonia about three times more toxic at pH 8.5 as at pH 6.5. Whether or not toxicity will be eliminated at pH 6.5 and the extent to which toxicity will increase at pH 8.5 will depend on the total ammonia concentration. If the graduated pH tests are done at dilutions symmetrical about the LC50, one should see toxicity differences between pH 6.5 and 8.5 (cf., Phase II discussion on equitoxic test). The effluent LC50 (expressed as percent effluent) should be lower at pH 8.5 than pH 6.5 if ammonia is the dominant toxicant.

The most desirable pH values to choose will depend upon the characteristics of the particular effluent being tested. For example, if the air equilibrium pH of the effluent at 4x the 24-h LC50 is 8.0 it may be more appropriate to use pH's 6.0, 7.0, and 8.0. The graduation scheme that includes the air equilibrium (the pH the effluent naturally drifts to) will allow a comparison of treatments to unaltered effluent (i.e., baseline test). The pH's of many POTW effluents rise to 8.5 or higher, so a gradient of pH's such as 6.5, 7.5 and 8.5 is more appropriate. In any case, it will be necessary to conduct the test at more than one effluent concentration (4x-, 2x-, 1x-, 24-h LC50) or with a different graduated pH scheme to determine what role, if any, the pH dependent compounds play in toxicity.

Perhaps the greatest challenge faced in this graduated pH test is that of maintaining a constant pH in the test solution. This is a necessity if the ratio of ionized to the un-ionized form is to remain constant and the test results are to be valid. In conducting toxicity tests on effluents, it is not unusual to see the pH of the test solutions with effluent concentrations of $\geq 12\%$ drift 1 to 2 units over a 48 to 96-h period (see Procedure for suggestions on pH control).

Volume Required:

The volume needed is dependent on the test design chosen to conduct this test. The test chamber size, number of dilutions, and the toxicity of the effluent will dictate this; however, 200 mL of test volume should suffice for all three pH's.

Apparatus:

Test chambers such as 78 mm L x 50 mm W x 50 mm H or 1 oz plastic cups; Hamilton 1 L gas syringe (Model S-1000, Reno, NV); 35 mm x 14 mm H Corning plastic petri dish bottoms, rubber stoppers, eye droppers or wide bore pipette, 30 mL beakers or 1 oz plastic cups, light box, and/or microscope (optional).

Reagents:

Cylinder tank of CO_2 , 1.0, 0.1, and 0.01 N, HCl, 1.0, 0.1, and 0.01 N NaOH (ACS grade in high purity water), buffers for pH meter calibration.

Test Organisms:

Use 5 for each of three dilutions of the whole effluent (4x-, 2x-, 1x-, 24-h LC50 or 100%, 50%, and 25%) and for each test pH (e.g., pH 6, 7, 8) (Figure 8-19), as well as a control.

Procedure:

Day 2: Either CO_2 or HCl (or the combination of both) can be used to lower the pH of the sample. The pH of most natural waters and some effluents is controlled by the bicarbonate buffering system. Surface waters normally contain <10 mg/L of free CO_2 .

For the CO_2 pH controlled tests, the pH is adjusted with CO_2 by varying CO_2 content of the gas phase over the water or effluent sample. It is necessary to maintain constant pH's in the static acute test throughout the 48 or 96-h tests. By using closed headspace test chambers, the CO_2 content of the gas phase can be controlled. The amount of CO_2 needed to adjust the pH of the solution is dependent upon sample volume, the test container volume, the desired pH, the temperature, and the effluent constituents (e.g., dissolved solids). When dilutions of an effluent have the same hardness and initial pH as the effluent, the same amount of CO_2 will usually be needed for each dilution, but sometimes more is needed in the higher effluent concentrations. Use of a dilution water of similar hardness as the effluent makes the CO_2 volume adjustments easier.

In our laboratory, a rectangular chamber (measuring 78 mm L x 50 mm W x 50 mm H) with a small diameter hole (approximately 20 mm) on one end has worked well for the CO_2 graduated pH test. The test solution volume should be about 10% of the headspace volume to maintain a large surface to volume ratio should be maintained. For a 20 mL test volume, with the CO_2 gas flushed into air space of the test chamber, pH's have reached equilibrium in about 1 h. In most instances, the amount of CO_2 produced by the invertebrates has not caused further pH shifts, but with larval fathead minnows, the pH can drop from the amount of CO_2 they respire as well as decomposition of food. Therefore, in fish tests, the headspace must be refilled daily.

The exact amount of CO_2 to inject for pH's 6.0, 7.0 and 8.0 must be determined through experimentation with each effluent before the graduated pH test begins.

Figure 8-19. Example of data sheet for the graduated pH test when effluent dilutions are used.

Test Type: Graduated pH Test Initiation (Date & Time): _____ Investigator: _____ Sample Log No., Name: _____ Date of Collection: _____	Species/Age: _____ No. Animals/No. Reps: _____ Source of Animals: _____ Dilution Water/Control: _____ Test Volume: _____ Other Info: _____ 4x-LC50: _____ or 100% _____ TRC: _____
---	---

% Effluent	pH	0 h pH	Survival Readings:							
			24 h		48 h		72 h		96 h	
			A	DO	A	DO	A	DO	A	DO
4x-LC50	6.0									
2x-LC50	6.0									
1x-LC50	6.0									
4x-LC50	7.0									
2x-LC50	7.0									
1x-LC50	7.0									
4x-LC50	8.0									
2x-LC50	8.0									
1x-LC50	8.0									

Note: See baseline data sheet for control data.

Comments:

The amount of CO₂ added to the chamber assumes that the liquid volume to gas volume ratio remains the same. Generally, as the alkalinity increases, the concentration of CO₂ that is needed to maintain the pH also increases. Inject the CO₂ using a gas tight syringe and quickly close the test chamber tightly. Place the test chamber in a position that maximizes the surface to volume ratio. To prepare the test solutions, use a dilution water of a similar hardness to the effluent and transfer the effluent solutions to the test container and randomly add the test organisms. Then add the predetermined amount of CO₂ to obtain the desired pH's and close the container. For pH values from pH 8.5 to 6, 0-10% CO₂ has been needed. If more than 10% CO₂ is needed, adjust the solutions with acids and bases (described below) and flush the headspace with CO₂. Again, the necessary concentration of CO₂ to use must first be determined experimentally with effluent test solutions already adjusted to the appropriate pH. This may require the test to be set up one day later than the other Phase I tests.

For some effluents adequate pH control can be obtained by adjusting the pH with acid or base and tightly covering the test container (no headspace pH test). A technique that we use has the 1 oz plastic cups covered with plastic tissue culture dishes (see *Apparatus* for details). This technique works well with effluents that have adequate DO content, and where the BOD is not high. The procedure for using plastic cups with tissue culture dish covers is as follows. Adjust three aliquots of the effluent and the dilution water to the appropriate pHs. Next, prepare the appropriate dilutions for testing (i.e., 4x-, 2x-, 1x-24-h LC50, or 10%, 50%, 25%) and check the pH in one-half hour. If the pH's have drifted, readjust them with the appropriate acid or base. Transfer about 35 mL of each into the 1 oz plastic cups, and randomly add the test organisms. Carefully place the cover onto the cup; care must be exercised because some test water will be displaced by the lid, and organisms can be lost. Ensure that no air is trapped under the lid during the sealing process. If air is trapped, remove the cover, count the number of organisms, and add an additional small amount of the appropriate pH adjusted test solution. The test organisms can readily be observed through the clear cover or the sides of the plastic cup. The cover should be removed only when all the animals have died as the tight seal cannot be obtained after initially setting up the test without adding more test water. Once animals have died or the test is over, remove the cover and measure the pH and DO. It is important to measure the DO because toxicants such as ammonia have different toxicities when DO is low (EPA, 1985B). Keep in mind that if all of the test animals have been dead for a while, the pH and/or DO of the test water could have changed.

Methods that use continuous flow of a CO₂/air mixture, such as tissue cell incubators, may be preferable and give better pH control. At this time we have not attempted to use a continuous flow of CO₂ and cannot recommend a system to use.

Maintaining pH above the air equilibrium pH (generally above 8.3) is difficult to achieve. The pH control in this high range is much more difficult because the concentration of CO₂ must be very low and the microbial respiration can increase the CO₂ levels in the test chamber. Use of CO₂-free air in the headspace may work or bubbling a mix of CO₂-free air and normal air through the headspace or test solution may be needed. Because such small CO₂ concentrations are needed and because CO₂ evolution by microorganisms or test organisms can significantly alter the CO₂ concentration, more frequent flushing of the headspace in static tests will be needed.

Since many plastics are permeable to CO₂, glass containers may need to be used. Measurements of pH must be made rapidly to minimize the CO₂ exchange between the sample and the atmosphere. Avoid vigorous stirring of unsealed samples because at lower pH values, the CO₂ loss during the measurement can cause a substantial pH rise.

For the CO₂ pH controlled tests, the pH should be measured at 24, 48, 72, and 96 h and at each reading, one may need to re-flush the headspace with CO₂. A small amount of experimentation will determine the amount of CO₂ needed for this step. For the no headspace pH tests conducted in cups with covers, air bubbles may start to appear after 12 h, and this can cause the pH to change. An excess of each test solution may need to be prepared to be added to the test cup at each 24 h interval to prevent the formation of air pockets which contribute to pH drift.

We also have been exploring the use of hydrogen ion buffers to maintain the pH of effluent test solutions. Efforts to use phosphate buffers were unsuccessful due to the toxicity of the phosphates themselves. Three hydrogen ion buffers were used by Neilson et al. (1990) to control pH in toxicity tests in concentrations ranging from 2.5 to 4.0 mM. These buffers were chosen based on the work done by Ferguson et al. (1980). The buffers are: 2-(N-morpholino) ethane-sulfonic acid (Mes) (pK_a = 6.15), 3-(N-morpholino) propane-sulfonic acid (Mops) (pK_a = 7.15), and piperazine-N,N'-bis (2-hydroxypropane) sulfonic acid (Popso) (pK_a = 7.8).

The acute toxicity of these buffers is low to both *C. dubia* and fathead minnows (Table 8-6) and sublethal levels can be added to hold the pH of test solutions. For example, 6.25 mM (1.2 g/L) of the Mes buffer has been adequate to maintain the pH of one effluent to within ±0.1 pH units. However when used in a sediment pore water, more buffer was needed (i.e., 25 mM or 4.9 g/L) but these levels are still below the acute toxicity for the buffer. Likewise for the Mops buffer, 6.25 mM (1.3 g/L) held the pH of the effluent at ±0.1 pH units, but 50 mM (10.5 g/L) was needed for the pore water. The Popso buffer held the pH at 8.2 or 8.5 using 6.25 or 12.5 mM (2.3 or 4.5 g/L, respectively) of buffer for both the effluent or pore water. The addition of these buffers did not change the toxicity of a non-toxic effluent or change the toxicity of a toxic effluent and sediment pore water.

Table 8-6. The toxicity of the Mes, Mops, and Popso buffers to *Ceriodaphnia dubia* and fathead minnows

Buffer	Species	Water Type	LC50 (g/L)			
			24 h	48 h	72 h	96 h
Mes	<i>C. dubia</i>	LSW	15.0	7.4		
Mes	<i>C. dubia</i>	VHRW	17.4	12.1		
Mops	<i>C. dubia</i>	LSW	16.1	13.0		
Mops	<i>C. dubia</i>	VHRW	>20.9	11.9		
Popso	<i>C. dubia</i>	LSW	>2.3	>2.3		
Popso	<i>C. dubia</i>	VHRW	12.7	8.3		
Mes	<i>P. promelas</i>	LSW	13.9	13.9	13.9	13.9
Mes	<i>P. promelas</i>	VHRW	>19.5	>19.5	>19.5	>19.5
Mops	<i>P. promelas</i>	LSW	>20.9	17.2	16.1	16.1
Mops	<i>P. promelas</i>	VHRW	>20.9	>20.9	>20.9	>20.9
Popso	<i>P. promelas</i>	LSW	32.3	32.3	27.9	27.9
Popso	<i>P. promelas</i>	VHRW	>36.2	>36.2	>36.2	>36.2

Note: The pH was held to at least ± 0.1 pH unit of desired pH for all tests. Mes buffer tests were at pH 6.2, Mops buffer tests were at pH 7.2, and Popso buffer tests were at pH 8.2. LSW = Lake Superior water; VHRW = very hard reconstituted water.

While these buffers serve to prevent the pH from drifting, their addition alone does not actually adjust the pH value to the desired pH. The buffers are weighed out and added to the aliquots of whole effluent and dilution water and both are then pH adjusted with base to the appropriate values. Serial dilutions are made, and test organisms are added. While our experience with the buffers is limited, we have found the amount of any buffer needed to hold any pH is effluent specific. Experiments will need to be done to determine the lowest concentration of buffer needed to maintain the desired pH. The test solutions need not be covered tightly to maintain pH; however, pH should be measured at each survival reading at all dilutions.

In all graduated pH tests, the pH should be measured at least in the chambers that bracket the LC50 concentration as soon as all the animals die. If the pH drifts more than 0.2 pH units, the results may not be usable and better pH control must be achieved.

Interferences/Controls and Blanks:

The controls in the CO₂ chamber or closed cup, and the baseline test act as checks on the general health of the test organisms, the dilution water and most test conditions. If the effluent pH in the baseline test (at the LC50) is close to the pH of the pH adjusted test solutions (at their respective LC50's), the toxicity

expressed in the two tests should be similar. Significantly greater toxicity may suggest interference from other factors such as the ionic strength related toxicity if the pH was adjusted with either HCL or NaOH (cf., Section 8.3), or CO₂ toxicity. Dilution water blanks at the various pH's are not used because such blanks are not appropriate since the effluent matrix may differ from that of the dilution water. The cleanliness of the acids and bases is checked in the blanks of the pH adjustment test. Other compounds with toxicities that increase directly with pH may lead to confounding results or may give results similar to ammonia. Phase II contains a suggested test (called the equitoxic test) to identify ammonia as the cause of toxicity. Monitoring the acid and base additions may be useful to determine if artifactual toxicity resulted from the addition of the salts. Monitoring conductivity of the effluent solutions after the addition of the acids and bases may also be helpful in determining artifactual toxicity.

Results/Subsequent Tests:

For the graduated pH test, the pHs selected must be within the physiological tolerance range for the test species used (which generally is a pH range of 6 to 9). In this pH range, the amount of acid or base added is negligible, and therefore the likelihood of toxicity due to increased salinity levels is low.

When ammonia is the dominant toxicant, the effluent LC50 of the pH 6.5 test solution should be higher than in the pH 7.5 test, which in turn, should be higher than the pH 8.5 test. However, ammonia is not the only possible cause of toxicity. Using the pH at the baseline effluent LC50, the relative toxicity of each pH adjusted solution can be predicted if ammonia is the sole cause of toxicity. For example, if in the baseline effluent toxicity test, the average pH was 8.0 in the 100% concentration in which no organisms survived and the average pH for the 50% concentration was 7.5 and all organisms survived, the estimated pH at the LC50 (71%) could be approximated at 7.7. One would expect greater

than 50% mortality in the pH 8 test solution and significantly less in the pH 7 solution. Therefore, if this occurs one should proceed to Phase II to identify the pH sensitive toxicant.

If ammonia is one of several toxicants in an effluent, this procedure may pose problems. For this reason, if effluent total ammonia levels are greater than 20 mg/L, it may be appropriate to include a pH 6 effluent treatment interfaced with other Phase I tests (cf., Section 9). Methods for further identifying and confirming ammonia as the toxicant can be found in Phases II and III.

Section 9

Time Frame and Additional Tests

9.1 Time Frame for Phase I Studies

The amount of time necessary to adequately characterize the physical/chemical nature of, and variability in, an effluent's toxicant(s) will be discharge specific. Among the factors affecting the length of Phase I studies for a given discharge is the appropriateness of Phase I tests to the toxicants, the existence of long- or short-term periodicity in individual toxicants and to a lesser extent, the variability in the magnitude of toxicity. An effluent which consistently contains toxic levels of a single compound that can be neutralized by more than one characterization test, should be moved into Phase II more quickly than an ephemerally toxic effluent with highly variable constituents, none of which are impacted by any of the Phase I tests. The decision as to when to go beyond Phase I should be based in part on the regulatory implications and resources involved in subsequent actions. Where a great amount of resources is involved, it is crucial that Phase I results be adequate.

There are no clearly defined boundaries between Phase I and Phase II. The section Results/Subsequent Tests of the characterization tests in Section 8 provide further tests to conduct and may be thought of as intermediate studies between Phases I and II. In terms of guidance for the time frame of the TIE, several samples should be subjected to the Phase I characterization test battery but not all manipulations have to be done on all subsequent samples. The decision to do subsequent tests on these samples to confirm or further delineate initial results is a judgement call and will depend on whether or not the results of Phase I are clear-cut. The time required to perform a complete Phase I battery on a sample will depend on many circumstances, not the least of which is how well organized and experienced the performing lab is at doing TIEs.

If the Phase I characterization tests needed to remove or neutralize effluent toxicity vary by the sample, the number of tested samples must be increased and the frequency of testing should be sufficient to include all major variability. We cannot provide a time frame or the number of samples to evaluate. Again, judgement will have to be used but the differences seen among samples can be used to decide when further differences are not being found. Phase I characterization testing should continue until there is reasonable certainty that new types of toxicants are not appearing. No guidance can be given as to how many weeks or

months this may take--each problem for every discharger is unique. The LC50 of samples can be very different but the same screening tests must be successful in removing and/or neutralizing effluent toxicity.

The individual Phase I tests which were previously successful in changing toxicity should be used as a starting point for Phase II identification. The first step in Phase II will often be to reduce the number of constituents accompanying the toxicants. These efforts may reveal more toxicants than suggested by Phase I testing. In Phase II one may discover that toxicants of quite a different nature are also present but were not in evidence in Phase I. More Phase I characterization may then be needed.

Phase I results will not usually provide information on the specific toxicants. Therefore, if effluent toxicity is consistently reduced, for example through the use of C_{18} SPE, this does not prove the existence of a single toxicant. In fact, several non-polar organic compounds may be causing the toxicity in the effluent over time, but use of the C_{18} SPE technique in Phase I detects the presence of these compounds as a group. Recognizing this lack of specificity is very important for subsequent Phase II toxicant identification.

9.2 When Phase I Tests are Inadequate

For some effluents, the Phase I tests described above will provide few or no clues as to the characteristics of the toxicants. For such effluents, other approaches must be tried. Some additional approaches are given below in much less detail than tests in Section 8 because our experience with them is limited. In addition to these, one should not hesitate to use originality and innovation to develop other approaches. As long as toxicity is used to track the changes, any approach may be helpful.

Use of Multiple Phase I Manipulations

Our experience suggests that independent action and less than additive action are much more common than we realize, at least in effluents. When these interactions occur, interpreting Phase I data may be difficult and in some instances (especially with independent action) no apparent effect on toxicity will be seen unless Phase I tests are clustered or used in a series. These steps do not begin until all Phase I manipulations have been completed and the results evaluated. Tests are continued to further separate and concentrate the toxicant(s).

The pH of effluents plays an amazingly powerful role in how it affects both the form of toxicants and their toxicity. Including pH adjustments to different values than is suggested in Phase I may be helpful. For example, if the C₁₈ SPE column has partially removed the toxicity, then Phase I manipulations with the post-column sample may be possible (cf., Section 8.6 pH adjustment/solid phase extraction test). For this multiple manipulation, the post-C₁₈ SPE column effluent can be treated as whole effluent, and several of the Phase I steps conducted on the post-column effluent have been found to be useful in further characterizing additional effluent toxicants. These include the EDTA addition test, the thiosulfate addition test, and the graduated pH test. Another combined test is to test the post-column effluent that has been spiked with the 100% methanol eluate to see if the toxicity is equal to that of the whole effluent. However, this can be a tricky manipulation as the post-column effluent is not the same as the original effluent, and spiking methanol into the sample may lower the DO as well as cause quick bacterial growths, which may result in erratic mortalities.

We have used aeration/filtration/pH adjustment/C₁₈ SPE in various combinations to decipher the changes that occur. The presence of more than one toxicant may often require such combinations. For instances where there are multiple toxicants and aeration and EDTA have both removed some toxicity, the addition of EDTA in the post-aeration sample may help characterize whether a metal(s) is causing the toxicity that is not removed through aeration.

If the C₁₈ SPE column has partially removed toxicity, it may be possible to pass the post-column effluent over an ion exchange column to determine the characteristics of the remaining toxicity. If a non-polar toxicant and ammonia are suspected, then passing the sample over the C₁₈ SPE column and then over zeolite (cf., Phase II), may assist in accounting for all of the toxicity. Likewise, passing the effluent over zeolite and then over the C₁₈ SPE column may provide additional insight. To gain this knowledge it is essential that toxicity tests be performed after each manipulation and not just on the multiple manipulated sample.

A special effect occurs when an effluent, which contains two toxicants at very different concentrations, is diluted. Suppose that toxicant A would produce an LC50 at 50% effluent and toxicant B causes an effluent LC50 at 5%. In most cases, only toxicant B will materially affect toxicity because the effect of A will be "diluted out" long before the LC50 of B is reached. Unless the toxicity degrades rapidly, the Phase I tests for such an effluent would be performed near the LC50 of B (20% is 4x-LC50) in which case the toxicity of A will not be noticed. If one finds toxicity at effluent concentrations in the very low range (such as 10%) additional Phase I testing at higher effluent concentrations should subsequently be done. Cases such as these should be caught in Phase III, but earlier detection will be more cost-effective.

The two objectives which usually move the TIE along more rapidly are to separate and concentrate the toxicant(s). Anything that can be done in Phase I to achieve these goals will speed the process.

Activated Carbon

The use of carbon has been limited because it is much less selective than ion exchange or C₁₈ SPE columns, and extraction is less precise and more difficult. However, carbon's non-selectivity can be an advantage in some situations. When a rather wide array of more specific methods have failed and the Phase I tests above have not changed toxicity, a "chemical sponge" may be useful. In order to start, one must be able to alter toxicity somehow in order to tell what changes are occurring. A second objective in early work is a way to remove the toxicants from the sample (i.e., to concentrate them). Carbon has a high capability to do both. Furthermore, the knowledge about carbon sorption and extraction is extensive and help can be found in the literature. While it is true that carbon may alter some chemicals, many are not affected by it. We must recognize that other conventional methods such as ion exchange are also not specific. Ion exchange columns can sorb non-polar organics and C₁₈ SPE columns can sorb metals.

Other Specific Ion Columns

Many other types of resin columns are available through commercial sources. Many of these have "insurmountable" blank toxicity problems but some show promise. Mixed bed ion exchange columns appear promising because pH is not drastically altered as the sample passes through the resin bed and the blanks appear to be acceptable. Of course with any of these lesser used methods, the organism's tolerance to dilution water passed over the resins and the eluate(s) must be determined.

Other Ligands

EDTA reduces toxicity for only some of the cationic metals, and other ligands may help.

9.3 Interpreting Phase I Results

After the suite of Phase I tests has been completed, the results will usually show that some manipulations increased toxicity, some decreased it, and others effected no change. Rarely is there no effect from any manipulation. Frequently more than one manipulation affects toxicity. Even if toxicity is affected by only one manipulation, one still does not know whether or not there are multiple toxicants. When several manipulations affect toxicity, it still does not ensure that there are multiple toxicants. There is also no way to tell at this stage if there are multiple toxicants, whether or not they are additive, partially additive or independent. In our experience with about 80 different effluents, we have not found synergism but independent action has commonly been found. Some toxicants identified in effluents have been additive, but more often these have been only partially additive. In regard to multiple toxicants, refer to the above section Use of Multiple

Phase I Manipulations, regarding complications of determining toxicant interactions in effluents.

After Phase I is completed on a sample, the investigator must carefully evaluate the data, draw conclusions, and make decisions about the next steps that are needed. Sometimes the next step is obvious, at other times the outcome will be confusing and the next step will not be obvious. Several general suggestions, based on our experience to date, may provide some help.

As a matter of principle, where multiple toxicants are involved, experience shows that once one toxicant is identified, identification of subsequent toxicants becomes easier because:

1. The toxicity contribution of the identified toxicant can be established for each sample.
2. The number of Phase I manipulations that will affect the toxicity of the known toxicant can be determined.
3. One can determine whether the identified and the unidentified toxicant(s) are additive.
4. If some manipulations affect the toxicity due only to the unidentified toxicants, some of their characteristics can be inferred.
5. One can determine if the relative toxicity contributions of identified and unidentified toxicants varies by sample. Such information can be used to design tests to elucidate additional physical/chemical characteristics.

Another suggestion, is that when some Phase I outcomes are understandable and others are not, concentrate on the one or the few that seem to be the most clear-cut and which have a major effect on toxicity. For example, if an effluent has 10 TU and 2 TU are removed by the addition of EDTA, 1 TU is removed by the C_{18} column and 5 TU are removed by the aeration manipulation, begin identification on the toxicity removed by aeration. In another example, suppose the filtration manipulation reduced the toxicity by 1 TU, both pH 3 and pH 11 adjustment tests showed that the toxicity increased by 2 TU, the graduated pH test at pH 7 decreased toxicity by 2 TU and the post- C_{18} SPE column effluent (at pH 7) had 2.5 TU less toxicity than the whole effluent. Of the 2.5 TU removed by the column, 1.7 TU could be eluted with the 100% methanol. The next step then is to begin the Phase II identification on the SPE extractable toxicity because:

1. Widely accepted methods are available for analyses of many non-polar organic compounds.
2. The method exists for both separating and concentrating such toxicants (cf., Phase II).
3. This C_{18} extractable toxicity manipulation behaved as expected.
4. Many effluents have non-polar toxicity, and based on those probabilities, that non-polar toxicity is likely to be real.

In the latter example, the unexplainable pH and filtration effects might be a result of the behavior of the non-polar toxicant(s) or could be caused by some associated artifact. If the non-polar toxicity is identified, then the results of the pH adjustment and filtration steps may be explainable.

The third suggestion is to concentrate on those manipulations affecting toxicity in which the toxicant is removed from other effluent constituents. In the above example, the SPE column separated the toxicant(s) from other non-sorbable constituents. Other examples of where the toxicant is removed from the other constituents are the filtration and the aeration manipulations.

Separating the toxicant(s) from non-toxicant(s), and concentrating the toxicant are usually the most productive efforts to pursue before identification (analyses) begins. Attempts to begin analysis for suspect toxicant(s) without this step is frequently a mistake, and can be costly.

9.4 Interpretation Examples

In this section, various examples of Phase I results are given with interpretation suggestions. These should be used only as guides to thinking and not as definitive diagnostic characteristics. Since almost any toxicant can be present in effluents, clear-cut logic is not totally dependable in interpreting results. Rather, one must use the weight of evidence to proceed, and be aware that artifacts cannot at this point always be identified.

One should avoid making categorical assumptions to every extent possible. For example, to assume that the toxicity is due to a non-polar toxicant(s) because the toxicity in the post- C_{18} SPE column effluent was removed often is an error. Metals may also be the toxicant adsorbed by the SPE column. However, as in the example in Section 9.3, if the toxicity can be recovered in the methanol fraction (see Section 8.6, *Results/Subsequent Tests* for elution and Phase II for more details), then the theory that a non-polar toxicant(s) is causing the toxicity is better substantiated. Metals do not elute with methanol and therefore do not produce toxicity in the methanol fraction toxicity test (cf., Phase II).

Example 1. Non-polar toxicant(s). The Phase I results implicating non-polar toxicants are:

1. All toxicity in the post- C_{18} SPE column effluent was removed.
2. The toxicity removed was recovered in the methanol elution of the SPE column.

The above discussion (cf., Section 9.3) has provided most of the interpretative rationale for these Phase I results which are typical of non-polar organics. As stated above, toxicants other than non-polar compounds may be retained by the SPE column but they are less likely to be eluted sharply. Also, as discussed

in Section 8.6, artifactual post-column toxicity can occur. However, the non-polar toxicity can be distinguished from the artifactual toxicity if the eluate is checked for toxicity. Some toxicants (metals, some surfactants) may not elute from the SPE column with methanol and so failure to recover the toxicity in the eluate does not exclude the possibility of a non-polar toxicant. Recovery of toxicity in the eluate at pH *i* is less likely to be an artifact than recovery only at pH 3 or pH 9.

Example II. Total dissolved solids (TDS). TDS consist of a group of common cations and anions (Ca^{2+} , Mg^{2+} , Na^+ , K^+ , SO_4^- , NO_3^- , Cl^- , CO_3^-) and in parts of the United States, this group is called "salinity." TDS is usually measured by conductivity, density or refraction, none of which measure specific compounds or ions. The toxicity of any given amount of TDS will depend on the specific composition. TDS behave as a mixture of toxicants, which do not cause toxicity through osmotic stress. Evidence of this is that the LC50s of the individual salts expressed in moles, are quite different. If osmotic stress were the mode of action, the concentration in moles at the LC50s would be similar.

One cannot use marine organisms to circumvent TDS unless NaCl is by far the dominant TDS. Marine organisms regulate Na^+ and Cl^- but like freshwater organisms, they too are sensitive to non-NaCl TDS.

For these reasons, only very general relationships exist between toxicity and TDS. Because of their varied nature, they do not sort out clearly in Phase I. Rather, unless conductivity is very high (e.g., 10,000 $\mu\text{mhos/cm}$), one suspects TDS when nothing else is indicated. For example, if high TDS were present and caused by calcium sulfate (CaSO_4), toxicity is likely to be removed by the adjustment to pH 11 or certainly by the pH 11 adjustment/filtration manipulation, whereas if the TDS were due to NaCl, toxicity would likely not be affected.

As a general guide, when conductivity exceeds 3,000 and 6,000 $\mu\text{mhos/cm}$ at the LC50 for *Ceriodaphnia* and fathead minnows, respectively, TDS toxicity should be considered. The conductivity of 100% effluent is not the relevant reading, but rather the conductivity at the concentrations bracketing the effluent LC50.

Following are some Phase I general indicators that TDS is a toxicant follow:

1. No pH adjustments changed the toxicity, unless a visible precipitate occurs upon pH adjustment, pH adjustment/filtration and pH adjustment/aeration.
2. No loss of toxicity in the post C_{18} column effluent, or a partial loss of toxicity with no change in conductivity reading.
3. No change in toxicity with EDTA additions, thiosulfate additions or in the graduated pH test.

In addition, there are two tests that can be used that are not included in Phase I but are discussed earlier in Section 9. These tests are:

1. Use of an acid/base ion exchange resin. If toxicity is removed or reduced, the toxicity could be due to TDS.
2. Use of activated carbon to remove toxicity. If no toxicity is removed by passing the effluent over carbon, TDS could be responsible for toxicity.

An additional caution is that where TDS is marginally high, the addition of NaCl from pH manipulations can increase TDS enough to produce artifactual TDS toxicity. The conductivity of the solutions before and after the pH adjustments should be monitored closely to avoid this.

Example III. Surfactants. There are three main groups of surfactants and/or flocculents (anionic, cationic and nonionic) that may occur in effluents. The Phase I behavior of these types of compounds may vary depending on which particular groups are present.

The general Phase I results implicating a surfactant(s) as the toxicant(s) are:

1. The toxicity is reduced or removed by filtration.
2. Toxicity is reduced or removed by the aeration. In some cases, the toxicity is recoverable from the walls of the aeration vessel after removing the aerated effluent sample (cf., Section 8.5).
3. Removal or reduction of toxicity by the C_{18} SPE column. The toxicity may or may not be recovered in the methanol eluate.
4. Toxicity degrades over time as the effluent sample is kept in cold storage. The degradation is slower when effluent is stored in glass rather than plastic. (See Section 6 for a discussion of the toxicity comparisons of sample in both glass and plastic containers.)

Example IV. Cationic Metals. This group of metals has varied chemical/physical behaviors which result in less definitive Phase I results. The following characteristics can be used only in a general way to point to metals as the cause of the toxicity. No single characteristic is definitive, with the possible exception of EDTA.

1. The toxicity is removed or reduced by the addition of EDTA.
2. The toxicity is removed or reduced by the C_{18} SPE column.
3. The toxicity is removed or reduced by filtration, especially combined with the pH adjustments.
4. The addition of sodium thiosulfate reduced or removed the toxicity.
5. Erratic dose response curve was observed.

In addition, toxicity may be pH sensitive in the range at which the graduated pH test is performed but may become more or less toxic at low or high pH depending on the particular metals involved.

Example V. Ammonia. Ammonia concentrations can be measured easily, and because it is such a common effluent constituent, determining the total ammonia concentration in the whole effluent is a good first step (see Section 6). If more than 5 mg/L of total ammonia is present, additional evaluations should be done. Sole dependence on analyses is not advisable because there is little or no additivity between ammonia and some other toxicants (e.g., such as surfactants). Even though the ammonia concentration is sufficient to cause toxicity, other chemicals may be present to cause toxicity if the ammonia is removed.

Three indicators of ammonia toxicity are:

1. The concentration of total ammonia is 5 mg/L or greater.
2. Toxicity increases as the pH increases.
3. The effluent is more toxic to fathead minnows than to *Ceriodaphnia* or *Daphnia*.

Example VI. Oxidants. In effluents, oxidants other than chlorine may be present. Measurement of a chlo-

rine residual (TRC) is not enough to conclude that the toxicity is due to an oxidant.

In general, oxidants are indicated by the following:

1. The addition of sodium thiosulfate to the effluent reduced or removed the toxicity.
2. Aeration without any pH adjustment removed or reduced toxicity.
3. The sample is less toxic over time when held at 4°C (type of container is not an issue here).
4. *Ceriodaphnia* are more sensitive than fathead minnows.

Of course, TRC greater than 0.1 mg/L at the effluent LC50 concentration (and depending on test species) would indicate chlorine as the oxidant causing the toxicity. In addition, the dechlorination with SO₂ provides evidence of chlorine toxicity in the same manner as the sodium thiosulfate addition test.

Section 10

References

- Adelman, I.R., L.L. Smith Jr., and G.D. Siesennop. 1976. Acute Toxicity of Sodium Chloride, Pentachlorophenol, Guthion®, and Hexavalent Chromium to Fathead Minnows (*Pimephales promelas*) and Goldfish (*Carassius auratus*). *J. Fish. Res. Board Can.* 33:203-208.
- Amato, J.R., D.I. Mount, E.J. Durhan, M.T. Lukasewycz, G.T. Ankley and E.D. Robert. 1992. An Example of the Identification of Diazinon as a Primary Toxicant in an Effluent. *Environ. Tox. and Chem.* In Press.
- Ankley, G.T., J.R. Dierkes, D.A. Jensen and G.S. Peterson. 1991. Piperonyl Butoxide as a Tool in Aquatic Toxicological Research With Organophosphate Insecticides. *Ecotoxicol. Environ. Safety.* 21:266-274.
- Ankley, G.T., M.T. Lukasewycz, G.S. Peterson and D.A. Jensen. 1990. Behavior of Surfactants in Toxicity Identification Evaluations. *Chemosphere.* 21:3-12.
- APHA. 1980. Standard Methods for the Examination of Water and Wastewater. 15th Edition. American Public Health Association, American Water Works Association Water Pollution Control Federation, Washington, D.C.
- Berg, E. 1982. Handbook for Sampling and Sample Presentation of Water and Wastewater. EPA-600/4-82-019. Cincinnati, Ohio.
- Bowman, M.C., W.L. Oller, T. Cairns, A.B. Gosnell and K.H. Oliver. 1981. Stressed Bioassay Systems for Rapid Screening of Pesticide Residues. Part I: Evaluation of Bioassay Systems. *Arch. Environ. Contam. Toxicol.* 10:9-24.
- Campbell, P.G.C. and P.M. Stokes. 1985. Acidification and Toxicity of Metals to Aquatic Biota. *Can. J. Fish Aquat. Sci.* 42:2034-2039.
- DHEW. 1977. Carcinogens - Working With Carcinogens. Public Health Service, Center for Disease Control, National Institute of Occupational Safety and Health. Department of Health, Education and Welfare. Publication No. 77-206.
- Dowden, B.F. and H.J. Bennett. 1965. Toxicity of Selected Chemicals to Certain Animals. *J. Water Pollut. Control Fed.* 37(9):1308-1316.
- EPA. 1979. Aqueous Ammonia Equilibrium - Tabulation of Percent Un-ionized Ammonia. EPA-600/3-79/091. Environmental Research Laboratory, Duluth, MN.
- EPA. 1985A. Methods for Measuring the Acute Toxicity of Effluents to Freshwater and Marine Organisms. Third Edition. EPA-600/4-85/013. Environmental Monitoring and Support Laboratory, Cincinnati, OH.
- EPA. 1985B. Ambient Water Quality Criteria for Ammonia. EPA-440/5-85-001. Environmental Research Laboratory-Duluth, MN, and the Criteria and Standards Division, Washington, D.C.
- EPA. 1988A. Methods for Aquatic Toxicity Identification Evaluations: Phase I Toxicity Characterization Procedures. EPA-600/3-88-034. Environmental Research Laboratory-Duluth, MN.
- EPA. 1988B. Short-Term Methods for Estimating the Chronic Toxicity of Effluents and Receiving Waters to Marine and Estuarine Organisms. EPA-600/4-87-028. Environmental Monitoring and Support Laboratory, Cincinnati, OH.
- EPA. 1989A. Toxicity Reduction Evaluation Protocol for Municipal Wastewater Treatment Plants. EPA/600/2-88/062. Water Engineering Research Laboratory, Cincinnati, OH.
- EPA. 1989B. Generalized Methodology for Conducting Industrial Toxicity Reduction Evaluations (TREs). EPA/600/2-88/070. Water Engineering Research Laboratory, Cincinnati, OH.
- EPA. 1989C. Methods for Aquatic Toxicity Identification Evaluations: Phase II Toxicity Identification Procedures. EPA/600/3-88/035. Environmental Research Laboratory, Duluth, MN.
- EPA. 1989D. Methods for Aquatic Toxicity Identification Evaluations: Phase III Toxicity Confirmation Procedures. EPA/600/3-88/036. Environmental Research Laboratory, Duluth, MN.
- EPA. 1989E. Short-Term Methods for Estimating the Chronic Toxicity of Effluents and Receiving Waters to Freshwater Organisms. Second Edition, EPA/600/4-89/001 and Supplement EPA/600/4-89/001A. Environmental Monitoring and Support Laboratory, Cincinnati, OH.
- EPA. 1991A. Toxicity Identification Evaluation: Characterization of Chronically Toxic Effluents, Phase I. EPA/600/6-91/005. Environmental Research Laboratory, Duluth, MN.
- EPA. 1991B. Methods for Measuring the Acute Toxicity of Effluents to Freshwater and Marine Organisms. Fourth Edition. EPA-600/4-90/027. Environmental Monitoring and Support Laboratory, Cincinnati, OH.
- EPA. 1991C. Short-term Methods for Estimating the Chronic Toxicity of Effluents and Receiving Waters to Freshwater Organisms. Third Edition. EPA/600/4-91/002. Environmental Monitoring and Support Laboratory, Cincinnati, OH.

- Federal Register. 1984. U.S. EPA: Development of Water Quality Based Permit Limitations for Toxic Pollutants; National Policy. EPA, Volume 49, No. 48, Friday, March 9, 1984.
- Ferguson, W.J., K.I. Braunschweiler, W.R. Braunschweiler, J.R. Smith, J.J. McCormick, C.C. Wasmann, N.P. Jarvis, D.H. Bell, and N.E. Good. 1980. Hydrogen ion buffers for biological research. *Anal. Biochem.* 104: 300-310.
- Giles, M.A. and R. Danell, 1983. Water Dechlorination by Activated Carbon, Ultraviolet Radiation and Sodium Sulphite. *Water Res.* 17(6): 667-676.
- Hockett, J.R. and D.R. Mount. In Preparation. Use of Metal Chelating Agent to Differentiate Among Sources of Toxicity. Manuscript.
- Magnuson, V.R., D.K. Harriss, M.S. Sun, D.K. Taylor, G.E. Glass. 1979. Relationships of Activities of Metal-Ligand Species to Aquatic Toxicity. ACS Symposium Series, No. 93. Chemical Modeling in Aqueous Systems, E.A. Jenne, Editor. pp. 635-656.
- Neilson, A.J., A.S. Allard, S. Fischer, M. Malmberg, and T. Viktor. 1990. Incorporation of a Subacute Test with Zebra Fish into a Hierarchical System for Evaluating the effect of Toxicants in the Aquatic Environment. *Ecotox. and Environ. Safety* 20:82-97.
- Norberg-King, T.J., E.J. Durhan, G.T. Ankley and E. Robert. 1991. Application of Toxicity Identification Evaluation Procedures to the Ambient Waters of the Colusa Basin Drain. *Environ. Tox. and Chem.* 10(7):891-900.
- OSHA. 1976. Occupational Safety and Health Administration. OSHA Safety and Health Standards, General Industry. 29 CFR 1910. OSHA 2206 (Revised).
- Patrick, R., J. Cairns Jr., and A. Scheier. 1968. The Relative Sensitivity of Diatoms, Snails, and Fish to Twenty Common Constituents of Industrial Wastes. *Prog. Fish-Cult.*:137-140.
- Poirier, S.H., M.L. Knuth, C.D. Anderson-Buchou, L.T. Brooke, A.R. Lima, and P.J. Shubat. 1986. Comparative Toxicity of Methanol and N,N-Dimethylformamide to Freshwater Fish and Invertebrates. *Bull. Environ. Contam. Toxicol.* 37(4):615-621.
- Randall, T.L. and P.V. Knopp. 1980. Detoxification of Specific Organic Substances by Wet Oxidation. *J. Water Pollut. Control Fed.* 52(8):2117-2130.
- Schubauer-Berigan, M.K. and G.T. Ankley. 1991. The Contribution of Ammonia, Metals and Non-polar Organic Compounds to the Toxicity of Sediment Interstitial Water from an Illinois River Tributary. *Environ. Toxicol. and Chem.* 10(7):925-939.
- Smith, R.M. and A.E. Martell. 1981. Critical Stability Constants. Volume 4: Inorganic Complexes. Plenum Press, NY.
- Stumm, W. and J.J. Morgan. 1981. Aquatic Chemistry - An Introduction Emphasizing Chemical Equilibria in Natural Waters. John Wiley & Sons, Inc., New York, NY.
- Walters, C.I. and C.W. Jameson. 1984. Health and Safety for Toxicity Testing. Butterworth Publ., Woburn, MA.

SATISFACTION GUARANTEED

NTIS strives to provide quality products, reliable service, and fast delivery. Please contact us for a replacement within 30 days if the item you receive is defective or if we have made an error in filling your order.

▲ **E-mail: info@ntis.gov**

▲ **Phone: 1-888-584-8332 or (703)605-6050**

Reproduced by NTIS

National Technical Information Service
Springfield, VA 22161

This report was printed specifically for your order from nearly 3 million titles available in our collection.

For economy and efficiency, NTIS does not maintain stock of its vast collection of technical reports. Rather, most documents are custom reproduced for each order. Documents that are not in electronic format are reproduced from master archival copies and are the best possible reproductions available. If you have questions concerning this document or any order you have placed with NTIS, please call our Customer Service Department at (703) 605-6050.

About NTIS

NTIS collects scientific, technical, engineering, and related business information – then organizes, maintains, and disseminates that information in a variety of formats – including electronic download, online access, CD-ROM, magnetic tape, diskette, multimedia, microfiche and paper.

The NTIS collection of nearly 3 million titles includes reports describing research conducted or sponsored by federal agencies and their contractors; statistical and business information; U.S. military publications; multimedia training products; computer software and electronic databases developed by federal agencies; and technical reports prepared by research organizations worldwide.

For more information about NTIS, call 1-800-553-6847 or 703-605-6000 and request a free copy of the NTIS Catalog, PR-827LPG, or visit the NTIS Website at <http://www.ntis.gov>.

NTIS

**Ensuring Permanent, Easy Access to
U.S. Government Information Assets**



PB92100072



PC

BIN: M2 08-22-03
INVOICE: 1287871
SHIP TO: 1*685304
PAYMENT: CSH*V

18840