

**VIA ELECTRONIC MAIL**

January 4, 2007

Tam Doduc  
Chair  
State Water Resources Control Board  
1001 I St.  
Sacramento, CA 95814

**Re: Southern Delta Salinity Workshop**

Dear Chairwoman Doduc:

Please accept the attached comments of the San Joaquin River Group Authority on the Southern Delta Salinity Workshop, scheduled for January 16 and 19, 2007. Please contact me if you have any questions.

Very truly yours,  
O'LAUGHLIN & PARIS LLP

By:

  
KENNETH PETRUZZELLI

Enclosures

## I. INTRODUCTION.

Under the Clean Water Act (33 USCA §1251 et seq.), water quality control plans must include a program of implementation for water quality objectives contained therein. To that end, the State Water Resources Control Board (“State Board”) should use the most accurate, current science and land use data available in implementing the southern Delta salinity objectives, measured as electrical conductivity (“EC”), at Interagency Station Nos. C-6 (Brandt Bridge), C-8 (Old River near Middle River), P-12 (Old River at Tracy Road Bridge), and C-10 (Airport Way Bridge near Vernalis).<sup>1</sup> (See Figure 1, below.)

**Figure 1. South Delta Compliance Locations.**

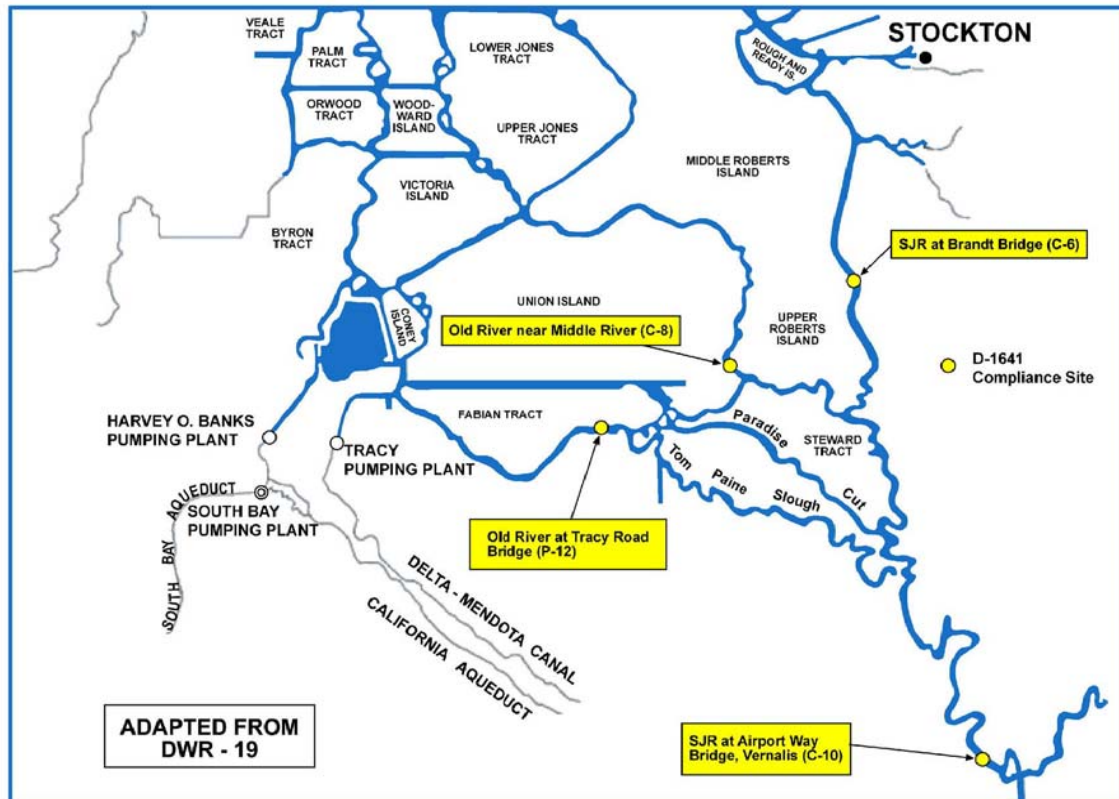

<sup>1</sup> Stations C-6, C-8, and P-12 also are referred to herein as the “Interior South Delta Stations” and station C-10 as the “Vernalis” station.

## II. BACKGROUND.

The Southern Delta EC Objectives for Agricultural Beneficial Uses were adopted in the 1991 Bay-Delta Plan and then re-adopted in the 1995 Bay-Delta Plan to reasonably protect crops grown in the southern Delta using beans and alfalfa as representative salt-sensitive crops. (1991 Bay-Delta Plan, p[5-9]; State Board Resolution No. 95-24, p2.) The objective of 0.7 mmhos/cm EC in the summer would protect beans and the objective of 1.0 mmhos/cm in the winter would protect alfalfa. (Id.) The compliance locations were Brandt Bridge, Old River near Middle River, Old River at Tracy Road Bridge, and Airport Way Bridge near Vernalis (“Vernalis”).

In Water Rights Decision 1641 (D-1641), the water rights phase that was part of the program of implementation for the 1995 Bay-Delta Plan, the State Board concluded that:

“[T]he actions of the CVP are the principal cause of the salinity concentrations exceeding the objectives at Vernalis. The salinity problem at Vernalis is the result of saline discharges to the river, principally from irrigated agriculture, combined with low flows in the river due to upstream water development. The source of much of the saline discharge to the San Joaquin River is from lands on the west side of the San Joaquin Valley which are irrigated with water provided from the Delta by the CVP, primarily through the Delta-Mendota Canal and the San Luis Unit. The capacity of the lower San Joaquin River to assimilate the agricultural drainage has been significantly reduced through the diversion of high quality flows from the upper San Joaquin River by the CVP at Friant. The USBR, through its activities associated with operating the CVP in the San Joaquin River basin, is responsible for significant deterioration of water quality in the southern Delta.”

(D-1641, p83.)

The State Board thereby held the United States Bureau of Reclamation (“USBR”) solely responsible for maintaining the Vernalis EC Objective and ordered the USBR to:

“[M]eet the Vernalis water quality objectives for agricultural beneficial uses at Vernalis. Licensee/Permittee may meet these objectives through flows or other measures.”

(D-1641, p161.)

No diversion for consumptive use under New Melones permits was authorized unless the USBR met both the Vernalis EC Objective and the Stanislaus River Dissolved Oxygen Objective. (D-1641, p162.) However, such terms were absent from the permits and licenses for the State Water Project (“SWP”) and neither agency was specifically deemed the “principal cause of the salinity concentrations exceeding EC objectives elsewhere in the South Delta. (D-1641, p83.) In modifying its operations to comply with D-1641, the USBR developed the New Melones Interim Plan of Operations (“IPO”) and has maintained the Vernalis EC Objective, without a single exceedance, since 1995. (State Board Resolution No. 2005-0087 “Approving An Amendment To The Water Quality Control Plan For The Central Valley Region To Incorporate A Total Maximum Daily Load (TMDL) For The Control Of Salt And Boron Discharges Into The Lower San Joaquin River”, Response to Written Public Comments On The November 2003 Public Review Draft Staff Report For The Control Of Salt And Boron Discharges Into The Lower San Joaquin River – Prepared July 2004, p12 (available at <http://www.waterboards.ca.gov/centralvalley/programs/tmdl/vernalissaltboron/responsetocoms.pdf>); see also Central Delta Water Agency v. Bureau of Reclamation (“CDWA v USBR”) (2006) 452 F.3d 1021, 1025.)

### III. ANALYSIS.

#### A. Salinity at Vernalis Significantly Impacts Downstream Salinity.

##### 1. When the Temporary Barriers are Operating, EC at Vernalis Only Significantly Affects EC at Brant Bridge.

Once operations of the Head of Old River Barrier (“HORB”), Grant Line Canal Barrier (“GLCB”), Middle River Barrier (“MRB”), Old River Barrier at Tracy (“ORB”), and Delta Cross Channel Barrier (“DXC”) begin in April, and until they end in December, almost 100% of the water from the San Joaquin River remains in the San Joaquin River. (Bay-Delta SJRG-EXH-04, “Evaluation of Revised Salinity Standard at Vernalis,” p4 and 12 (available at <http://www.waterrights.ca.gov/baydelta/docs/exhibits/SJRG-EXH-04.pdf>); see Figure 2 and Figure 3.)

**Figure 2. Flow split at confluence of Old and San Joaquin Rivers with standard HORB schedule.<sup>2</sup>**

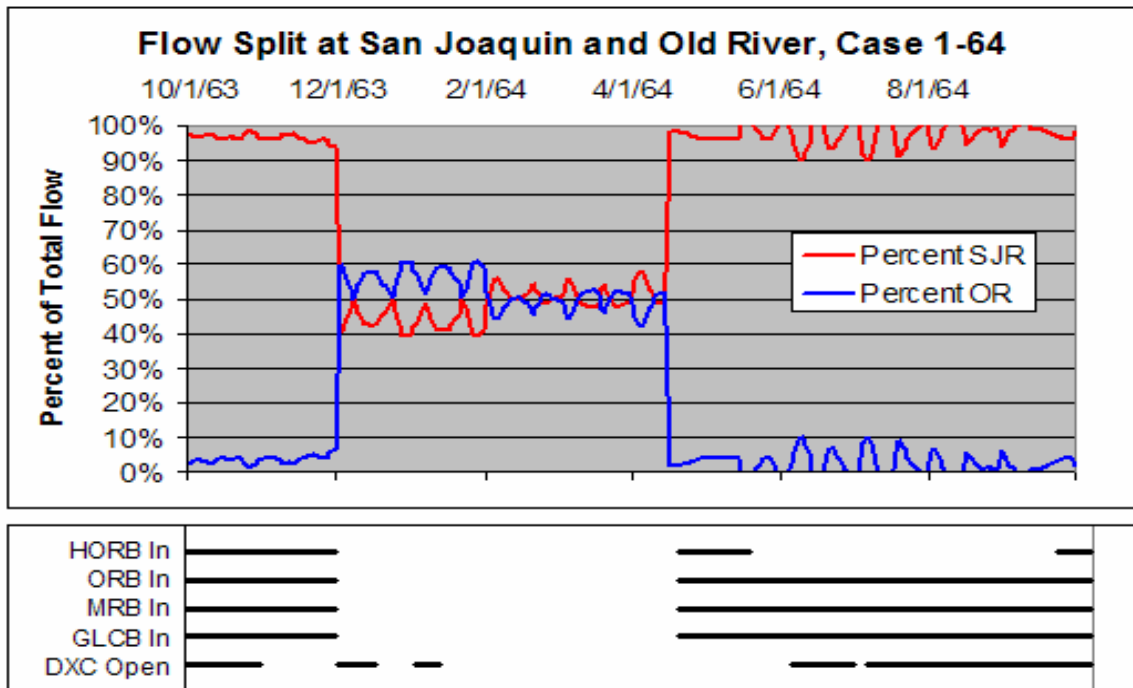

<sup>2</sup> See Bay-Delta SJRG-EXH-04, p12.

**Figure 3. Flow split at confluence of Old and San Joaquin Rivers with modified HORB schedule.<sup>3</sup>**

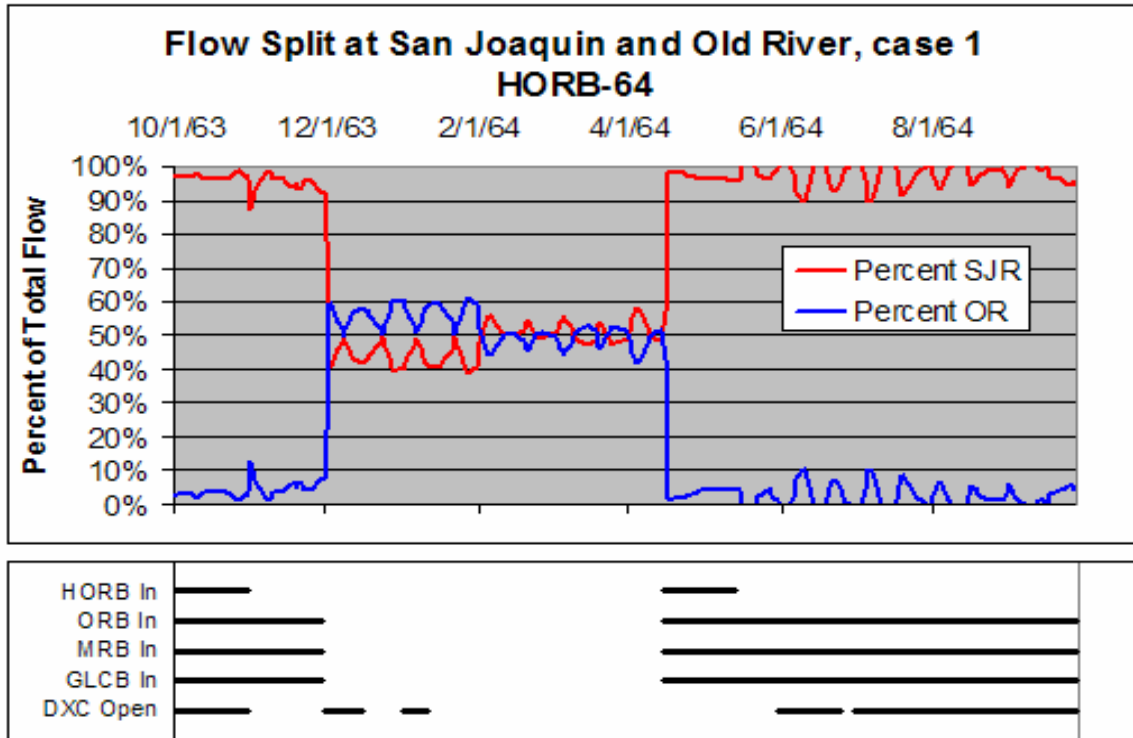

In addition, Ms. Paulsen analyzed the effects of exports. In a Dry year, only 21% of San Joaquin River water remains in the Delta.<sup>4</sup> (Id., p4, 11; see Figure 4.) The rest of the water is exported. (Id.) In a Critical year, only 37% of San Joaquin River water remains in the Delta.<sup>5</sup> (Id.) As in Dry years, the remaining water is exported. (Id.)

<sup>3</sup> See Bay-Delta SJRG-EXH-04, p12.

<sup>4</sup> Ms. Paulsen modeled water year 1964 as the Dry year. (Bay-Delta SJRG Exh-04.)

<sup>5</sup> Ms. Paulsen modeled water year 1988 as the Critical year. (Bay-Delta SJRG-EXH-04.)

**Figure 4. Fate of San Joaquin River Water in Water Years 1964 and 1988.<sup>6</sup>**

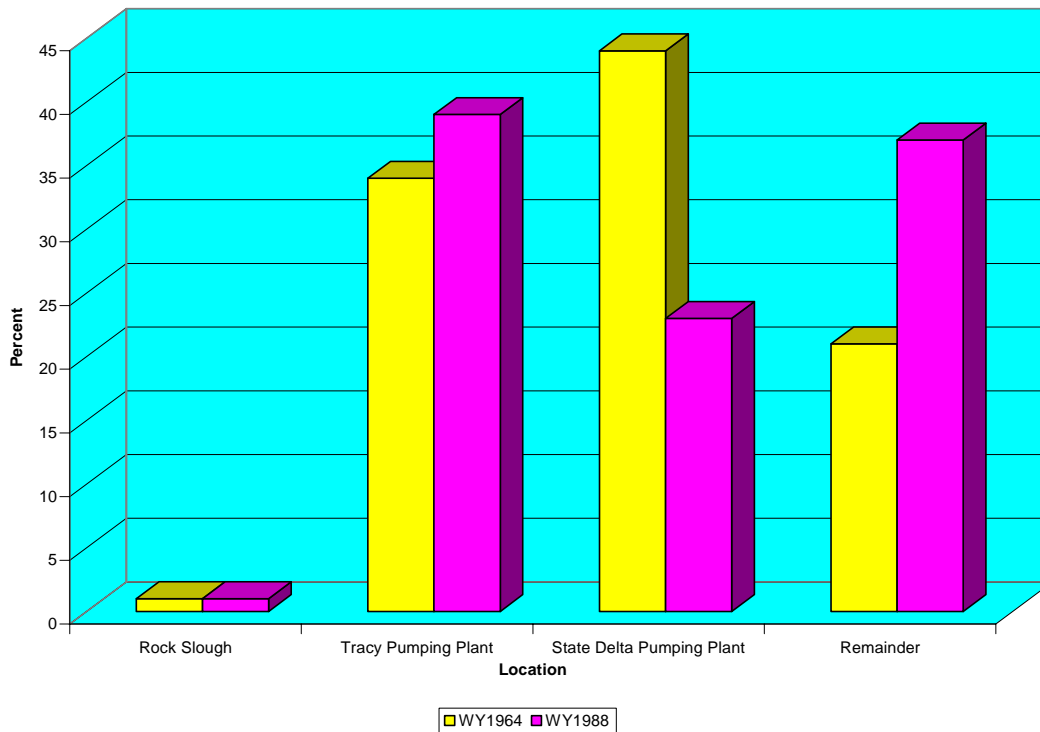

Ms. Paulsen also added a tracer to further isolate fate of San Joaquin River water. She determined that in an Above Normal year, no more than 18.5% of San Joaquin River water flowed into Turner Cut.<sup>7</sup> (Bay-Delta SJRG-EXH-24, “Fischer Delta Model Study, Fate of a Conservative Tracer During Water Years 2000-2001,” p13-14 (June 2, 2005) (available at <http://www.waterrights.ca.gov/baydelta/docs/exhibits/SJRG-EXH-24.pdf>.) Even in a Dry year, when a greater proportion of water remains in the Delta, no more than 23% of San Joaquin River water enters Turner Cut.<sup>8</sup> (Id.) These simulated percentages, as low as they may appear, actually overestimate the amount of San Joaquin River water flowing into Turner Cut, because the FDM sometimes counts tracers multiple

<sup>6</sup> See Bay Delta SJRG-EXH-04, p4.

<sup>7</sup> Water year 2000 was used to simulate the Above Normal year. (Bay-Delta SJRG-EXH-24.)

<sup>8</sup> Water Year 2001 was used to simulate the Above Normal year. (Bay-Delta SJRG-EXH-24, p3.)

times.<sup>9</sup> Therefore, the amount of San Joaquin River water entering Turner Cut is less than that predicted by the simulation. (Id.)

Together, the barriers and exports prevent almost all of the San Joaquin River's water from entering Old River and effectively eliminate any significant hydrologic relationship between Vernalis and the Interior South Delta during the summer irrigation season and thwart any significant influence EC at Vernalis can have on EC on Old River near Middle River, Old River at Tracy Road Bridge, or other locations in the Interior South Delta. Once the San Joaquin River reaches the Stockton Deep Water Ship Channel, water from San Joaquin River joins the Sacramento River. (Environmental Impact Report ("EIR") for the 1995 Bay-Delta Plan, p[III-104], p[III-106] (available at <http://www.waterrights.ca.gov/baydelta/eir/FEIRVol1.pdf>.) Very little of the water in Turner Cut, Paine Slough, the Grant Line Canal, and other areas in the Interior South Delta comes from the San Joaquin River. (Id.) Instead, most water comes from the Sacramento River. (Id.) As a result, the Interior South Delta is irrigated primarily with Sacramento River water, and effects of EC at Vernalis are limited to crops irrigated with water from the San Joaquin River between Vernalis and the Stockton Deep Water Ship Channel. Furthermore, the Sacramento River, due to its far larger flow, accounts for the majority of salt loading in the Delta and, when the barriers are operating, the Interior South Delta in particular. (Central Valley Regional Water Quality Control Board, "Salinity in the Central Valley: An Overview" (May 2006), p31 Figure 3 (available at

---

<sup>9</sup> On Tables 2 and 3, the CVP, SWP, Los Vaqueros, and Contra Costa export columns, plus the Martinez column should total approximately 100%. (Bay-Delta SJRG-EXH-24, p13-14.) If they total less than 100%, the remaining percentage represents water remaining in the Delta. The sum of the Old River, Stockton Ship Channel, Turner Cut, Columbia Cut, Little Connection Slough, and Middle River columns will exceed 100%, because the tracers are counted multiple times.



<http://www.waterboards.ca.gov/centralvalley/cv-salts/salinity-overview-rpt.pdf>); See Figure 5, below.)

**Figure 5. Mass emissions, salt sources, and Delta exports in the Sacramento-San Joaquin Delta System.**

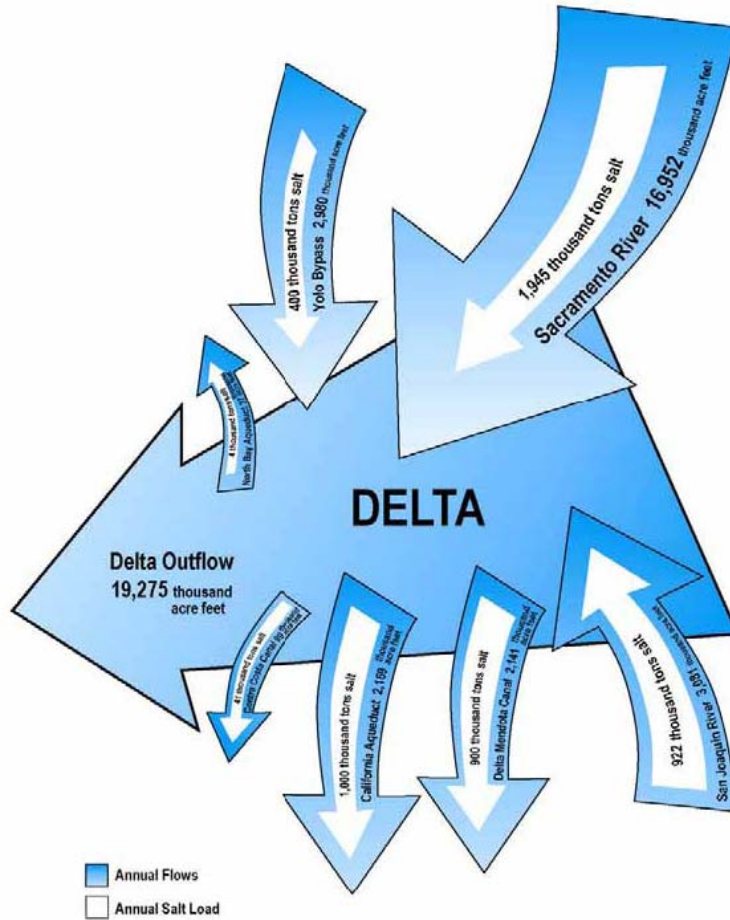

Ms. Paulsen’s analysis is consistent with that performed by the Department of Water Resources (“DWR”) in Cease and Desist Order (“CDO”) Hearing Nos. 262.31-16 and 262.31-17, wherein the DWR submitted extensive testimony detailing the changes in salinity from Vernalis to Brandt Bridge using DSM2 modeling simulations of historical conditions. (CDO 262.31-17 Exhibit DWR-20 (available at [http://www.waterrights.ca.gov/Hearings/docs/usbr/dwr\\_exhibits/dwr20.pdf](http://www.waterrights.ca.gov/Hearings/docs/usbr/dwr_exhibits/dwr20.pdf))).

Brandt Bridge EC is fully dependent upon Vernalis EC and agricultural return flows below Vernalis, unless flows at Brandt Bridge reverse, which occurs in low flow conditions when less than 30% of the flow at Brandt Bridge consists of San Joaquin River Water. (CDO 262.31-17 Exhibit DWR-20, p3.) On average, EC degrades approximately 8% from Vernalis to Brandt Bridge, with a majority of that degradation occurring between Vernalis and Mossdale. (*Id.*, p6.) Absent discharge controls below Vernalis, EC maintained at Vernalis must be substantially lower than 700 uS/cm in order to achieve compliance at Brandt Bridge. (See Table 1.)

**Table 1. Required EC at Vernalis to Ensure EC Compliance at Brandt Bridge.**<sup>10</sup>

Confidence levels	Required Vernalis EC to Ensure	
	Brandt Bridge EC = 700 $\mu$ S/cm	Brandt Bridge EC = 1000 $\mu$ S/cm
95	565	845
90	585	860
85	595	875
80	605	885
75	615	895
70	625	900
65	630	910
60	635	915
55	645	920
50	650	930
45	655	935
40	660	940
35	670	945
30	675	955
25	685	960
20	690	970
15	700	980
10	715	990
5	730	1010

<sup>10</sup> CDO 262.31-17 Exhibit DWR-20, p20-21 Table 2.

From Mossdale to Brandt Bridge, EC only degrades by approximately 1%. (Id.) Consequently, operation of the Head of Old River Barrier has little effect downstream. The barriers do, however, significantly affect EC at Old River near Middle River and Old River at Tracy Road Bridge when operating. When the temporary barriers are not operating, EC at the two stations is strongly influenced by San Joaquin River flow and EC at Vernalis. (Id., p7.)

**2. Prior Estimates and Surveys of South Delta Pumping Capacity and Diversion Requirements.**

**a. D-1641 Estimated the South Delta Diversion Requirement at 902 to 1,400 cfs.**

In D-1641, the State Board estimated the South Delta riparian diversion requirements at 1,400 cfs, based on exhibits provided by the South Delta Water Agency (“SDWA”) and the State Board and on oral testimony by Mr. Alex Hildebrand. (D-1641, p31.) The channel depletion requirement provided by SDWA was based on an analysis performed by Jerry Orlob. (D-1641 SDWA-22, p2; see Table 2, below.)

**Table 2: Channel depletion requirement estimated by SDWA (cfs).**

Month	Inside Barrier	Total SDWA	At Vernalis
January	169	234	573
February	111	154	483
March	151	209	548
April	293	406	745
May	368	519	849
June	566	785	1124
July	765	1051	1400
August	717	995	1334
September	518	718	1057
October	406	363	302
November	303	420	759
December	274	380	719

The SDWA estimate assumed that all lands in the South Delta were riparian and that there were no senior riparian water right holders upstream of Vernalis. (D-1641,

p31.) The former proved incorrect in Water Rights Order No. 2004-0004, wherein the State Board determined that three South Delta licensees, who asserted the use of riparian water rights in defense of allegations that they illegally diverted water when Term 91 was in effect, lacked riparian water rights. (State Board Water Rights Order No. 2004-0004, “In re Administrative Civil Liability Complaints For Violations Of Licenses 13444 and 13274 Of Lloyd L. Phelps, Jr.; License 13194 of Joey P. Ratto, Jr.; License 13315 Of Ronald D. Conn and Ron Silva, et Al.” (2004 WL 367585), p22.) The latter was a very conservative assumption, as other water users upstream of Vernalis held senior water rights. (Id., p31 fn33.)

A later analysis of South Delta diversions by Nigel Quinn and Alice Tulloch estimated the South Delta diversion requirement far lower, at only 300 cfs. (Quinn, Nigel and Tulloch, Alice, San Joaquin River Diversion Data Assimilation (“SJR Diversion Data Assimilation”) (CALFED Project No. ERP-01-N61-02), p45 Figure 27 (September 15, 2002), available at [http://www.watershedportal.org/viewDoc\\_html?did=1172](http://www.watershedportal.org/viewDoc_html?did=1172), accessed June 1, 2006.)

To determine the irrigated acreage, Quinn and Tulloch reviewed county assessor maps of probable riparian properties from Vernalis (River Mile 77) to Channel Point (River Mile 40). (Id. at 44.) Property under Williamson Act contract was assumed to be fully irrigated. (Id.) Non-irrigated land uses, such as urban, school, wastewater ponds, and commercial land uses, were excluded. (Id.) Unclassified properties less of than 10 acres were excluded on the assumption that these represented “small residential holdings.” (Id.)

**Table 3: Estimated irrigated acreage from Airport Way to Channel Point.**<sup>11</sup>

	<b>Land Designation</b>	<b>Gross Acres</b>	<b>Probable % Irrigated</b>	<b>Estimated Irrigated Acres</b>	<b>Average Parcel Size, Ac</b>
Westside	Williamson Act (Ag)	6,653	100%	6,653	158
	Non-Taxable	4,292	0%	0	429
	Unclassified	4,246	75%	3,185	137
		15,191		9,838	
Eastside	Williamson Act (Ag)	4,983	100%	4,983	135
	Non-Taxable	1,663	11.5%	190	43
	Unclassified	3,905	75%	2,929	64
		10,551		8,102	
<b>Total Both Sides</b>		25,742		17,940	

Based on their review, Quinn and Tulloch estimated a total of 17,940 irrigated acres. (Id.; see Table 3, above.) The irrigation requirement was assumed to be 3-4 acre-feet per year per acre, with a four month irrigation season. (Id. at 45.) Four acre-feet per year, applied to 17,940 acres, translates to a 71,760 acre-foot irrigation requirement.

The 4 acre-feet/acre irrigation requirement was then multiplied by 17,940 acres, a conversion of 43,560 applied, and then divided converted to the number of seconds in a four month period.<sup>12</sup> (Id.) This estimate assumed however, that diversion pumps operate continuously throughout the irrigation season. It also assumed that riparian rights were

<sup>11</sup> SJR Diversion Data Assimilation, p45.

<sup>12</sup>  $Q = (17,940 \text{ acres} \times 4 \text{ feet/acre} \times 43,560) / (4 \text{ months} \times 30 \text{d} \times 24 \text{hr} \times 60) = 300 \text{ cfs}$

retained for all of the land throughout all property conveyances, as would be required for legal riparian property rights.<sup>13</sup>

The total pumping capacity, determined by boat survey, was estimated at 1,300 cfs based on the size of the pipes and assuming a flow velocity of 14 fps and a 15-foot head. (*Id.*, see Table 4, below.) Horsepower of the pump, angle of the pipe, and the pipe’s material were not considered. (*Id.*)

**Table 4: Estimated riparian pumping capacity from RM 40 to RM 77 on the San Joaquin River.**

Suction Size	# of Pumps	Estimated Capacity / Pump, cfs	Total Capacity, cfs
6-inch	11	2.8	31
8-inch	10	4.9	49
10-inch	21	7.7	162
12-inch	31	11.1	344
14-inch	24	15.0	360
16-inch	13	19.6	255
18-inch	2	24.8	50
20-inch	3	30.5	92
<b>Total</b>	<b>115</b>		<b>1,342</b>

The pumping capacity estimated by Mr. Quinn is close to the irrigation requirement estimated by the SDWA in D-1641 and confirmed by Mr. Alex Hildebrand in a personal communication with Mr. Quinn, in which Mr. Hildebrand estimated the South Delta diversion requirement at 1,200 to 1,300 cfs in a typical year. (*Id.* at 44.) However, SDWA’s estimate, if based on the pumping capacity, is an estimate of how much the South Delta can divert, not but not necessarily how its water rights allow it to divert.

<sup>13</sup> As a general matter, in order to be considered riparian, a parcel of land must satisfy three criteria. First, the property must be contiguous to a watercourse. (*Rancho Santa Margarita v. Vail* (1938) 11 Cal.2d 501, 528). Second, it must be the smallest tract held under one chain of title. (*Id.* at 529). Thus, a portion of a riparian parcel that is severed, and then reunited under ownership with the original riparian parcel, will not regain riparian status. (*Miller & Lux v. James* (1919) 180 Cal. 38, 51-52; *see Anaheim Union Water Co. v. Fuller* (1907) 150 Cal. 327, 331)). Third, the property must be located within the watershed of the watercourse to which it is contiguous. (*Rancho Santa Margarita, supra*, 11 Cal.2d at 528-529).

**b. Field Surveys of Diversions Have Been Performed as Far Downstream as Mossdale Bridge.**

In 1989, the Regional Board reported the results of a survey of diversion and discharge points along the San Joaquin River, from Mendota Pool to Mossdale Bridge, conducted from 1985 to 1986. (See Appendix B: California Regional Water Quality Control Board, 1989, “Water diversion and discharge points along the San Joaquin River, Mendota Pool Dam to Mossdale Bridge: California,” (“Water Diversion and Discharge Points Along the SJR”) California Regional Water Quality Control Board, Central Valley Region<sup>14</sup>.) The initial river survey was conducted by air in April and May 1985 and additional information was obtained from US Geological Survey topographic maps, Soil Conservation Service records, and Central Valley Regional Water Quality Control Board files. (Id., p2.) Then, inspections were performed, on the ground, of the entire 150-mile reach of the San Joaquin River. (Id.) The on-ground inspections consisted of traveling the length of the 150-mile reach, documenting the location and type of all discharges and diversions, identifying the source of any discharge, and identifying the land being irrigated, the types of crops, and the acres of each crop grown thereon. (Id.)

Between Vernalis and Mossdale Bridge, the Regional Board surveyed 28 points of diversion, irrigating an estimated 18,600 acres, and 18 points of discharge. (Id.; see Table 5, below.) The survey divided the San Joaquin River below Vernalis into three segments, the first extending from Vernalis to the BCID diversion pumps (Segment 18), the second down to Paradise Dam (Segment 19), and the third down to Mossdale Bridge (Segment 20). (Id., p3.)

---

<sup>14</sup> The report was authored by Edward James, Dennis Westcot, and Jeanne Gonzalez. Other Staff persons involved, both in preparing the report and in conducting the field work, were Rudy Schnagl, John Menke, Louis Pratt, Christopher Cooper, Ron Thomasson, and Brenda Grewell.

**Table 5. Surveyed points of diversion and discharge from Airport Way Bridge to Mossdale Bridge.**

<b>Reach</b>	<b>Points</b>	<b>Miles</b>	<b>Diversions</b>	<b>Discharges</b>
18	Vernalis to the BCID Diversion Pumps	8.8	12	10
19	BCID Diversion to Paradise Dam	3.7	8	6
20	Paradise Dam to Mossdale Bridge	3.7	8	2
<b>Total</b>		16.2	28	18

The survey severely underestimated the irrigated acreage, because only irrigated acreage in the reach between the BCID diversion pumps and Paradise Dam (Reach 19) was surveyed. (Id.) Diversion capacities and irrigation requirements were not determined. (Id.)

Two significant discharges were observed in the survey, one from McMullin RD (RD #2075) and another from the New Jerusalem Drainage Outlet, both between the BCID diversion pumps and Paradise Dam (Reach 19). (Id., p 32 and 35 Figure 26)

**i. Vernalis to the BCID Diversion Pumps.**

In the 8.8 miles from Airport Way Bridge to the BCID diversion pumps, there were 12 diversion pumps, 8 on the east side and 4 on the west side. (Water Diversion and Discharge Points Along the SJR, p34 Figure 25; see Figure 6, below.) Of the 10 discharge points, the five on the west side were relatively small compared to those upstream and had little influence on the river’s hydrology. (Id., p32.) The five points of discharge on the east side discharged both storm water and irrigation return flows. (Id.) During the year, the majority of water discharged from the east-side drains consisted of storm water. (Id.)



**Figure 6: Schematic diagram of diversions and discharges from Airport Way to the BCID diversion.**<sup>15</sup>

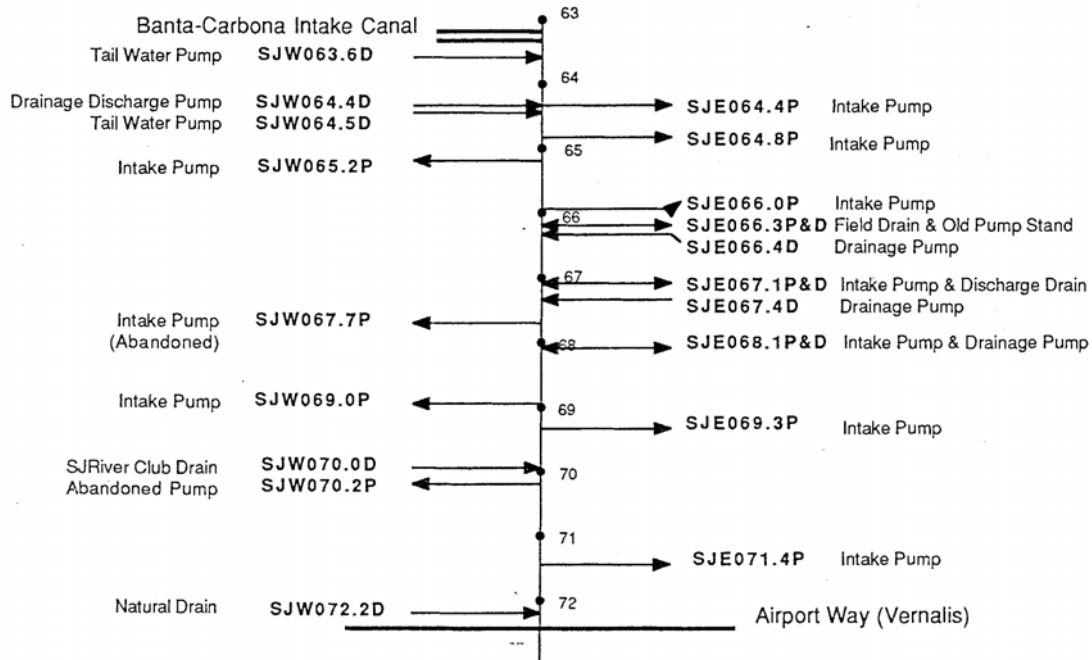

**ii. BCID Diversion to Paradise Dam.**

In the 3.7 miles from the BCID diversion to Paradise Dam, there were 8 diversion pumps and 6 discharge sites. (*Id.*, p 32 and 35 Figure 26; see Figure 7, below.) All of the diversions were smaller than those upstream, serving only 20 to 300 acres, except for the intake canal of the BCID, which served all of the BCID’s 17,800 acres. (*Id.*) The BCID diversion is the most significant diversion below Vernalis. The BCID’s combined water rights, from April through September, are nearly 400 cfs. (Statement of Diversion No. 495; Application No. 1933 (License No. 5404).)

<sup>15</sup> Water Diversion and Discharge Points Along the SJR, p34 Figure 25. The unique site number assigned to each site describes the site location. For example, site #SJW121.1D; the first two letters describe the site as being on the San Joaquin River (SJ) while the next letter describes whether the site is on the west (W) or east (E) side of the river. The four-digit numeric designation (121.1) describes the river miles as defined by the US Army Corps of Engineers (1984). The final letter designation describes whether the site is a discharge (D) to the river or a diversion (P) from the river.

On the east side, there were two discharge pumps. (Id.) The first discharged surface water from McMullin RD (RD #2075), which covers 5,000 acres. The second, the New Jerusalem Drainage Outlet, discharged tile drainage from the 11,000 acre New Jerusalem Drainage District, at rates exceeding 25 cfs throughout most of the year. (Id.)

**Figure 7: Schematic diagram of diversions and discharges from the BCID diversion to Paradise Dam.**<sup>16</sup>

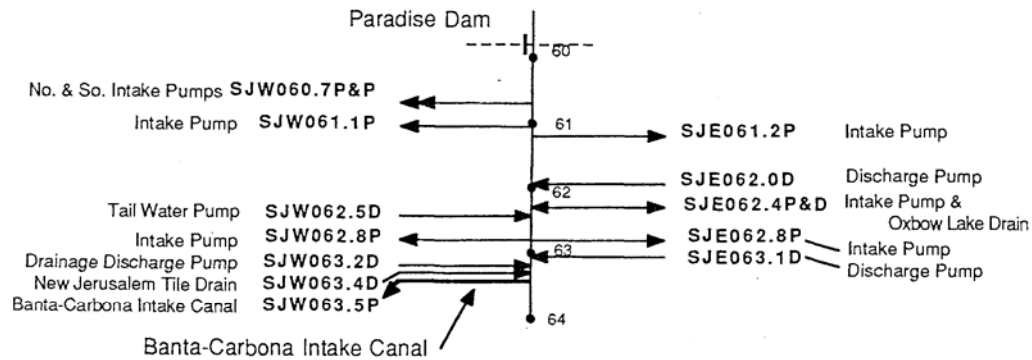

### iii. Paradise Dam to Mossdale Bridge.

The 3.7 miles from Paradise Dam to Mossdale Bridge were highly developed as a water supply reach with few significant discharges. (Id., p36 and p37 Figure 27; see Figure 8, below.) There were eight diversion sites in this reach which, depending upon river flow and upstream diversion operations, could affect flow hydrology at Mossdale Bridge. (Id.) Paradise Cut was a significant diversion, but was rarely used in the irrigation season or low-flow periods.

<sup>16</sup> Water Diversion and Discharge Points Along the SJR, p35 Figure 26.

**Figure 8: Schematic diagram of diversion and discharge points on the SJR from Paradise Dam to Mossdale Bridge.<sup>17</sup>**

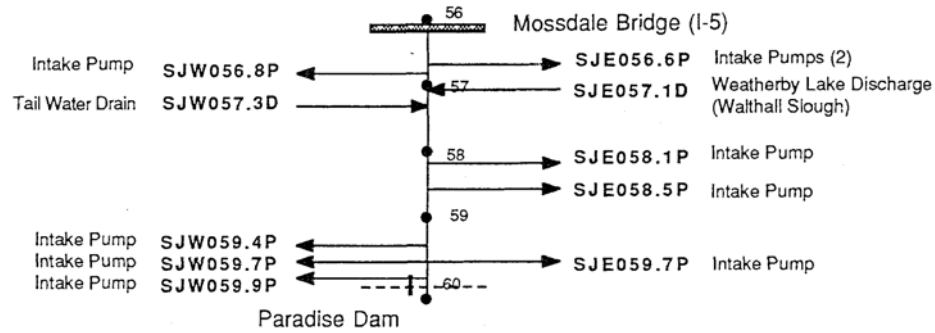

### 3. Almost All of the Beans Grown in the South Delta Are Grown in the Banta Carbona Irrigation District.

A review of the 1996 San Joaquin County Land Use Survey, the most recent conducted, shows that approximately 3,000 acres of beans were irrigated with surface water from the San Joaquin River between Vernalis and the Stockton Deep Water Ship Channel. (DWR, Land Use Survey of San Joaquin County (1996) (available at [http://www.landwateruse.water.ca.gov/basicdata/landuse/counties/survey\\_years/vector\\_queries/96sj.cfm](http://www.landwateruse.water.ca.gov/basicdata/landuse/counties/survey_years/vector_queries/96sj.cfm).)

<sup>17</sup> Water Diversion and Discharge Points Along the SJR, p37 Figure 27.

**Figure 9. South Delta Water Agency, 1996 Land Use Survey, Bean Fields.**



Location Map

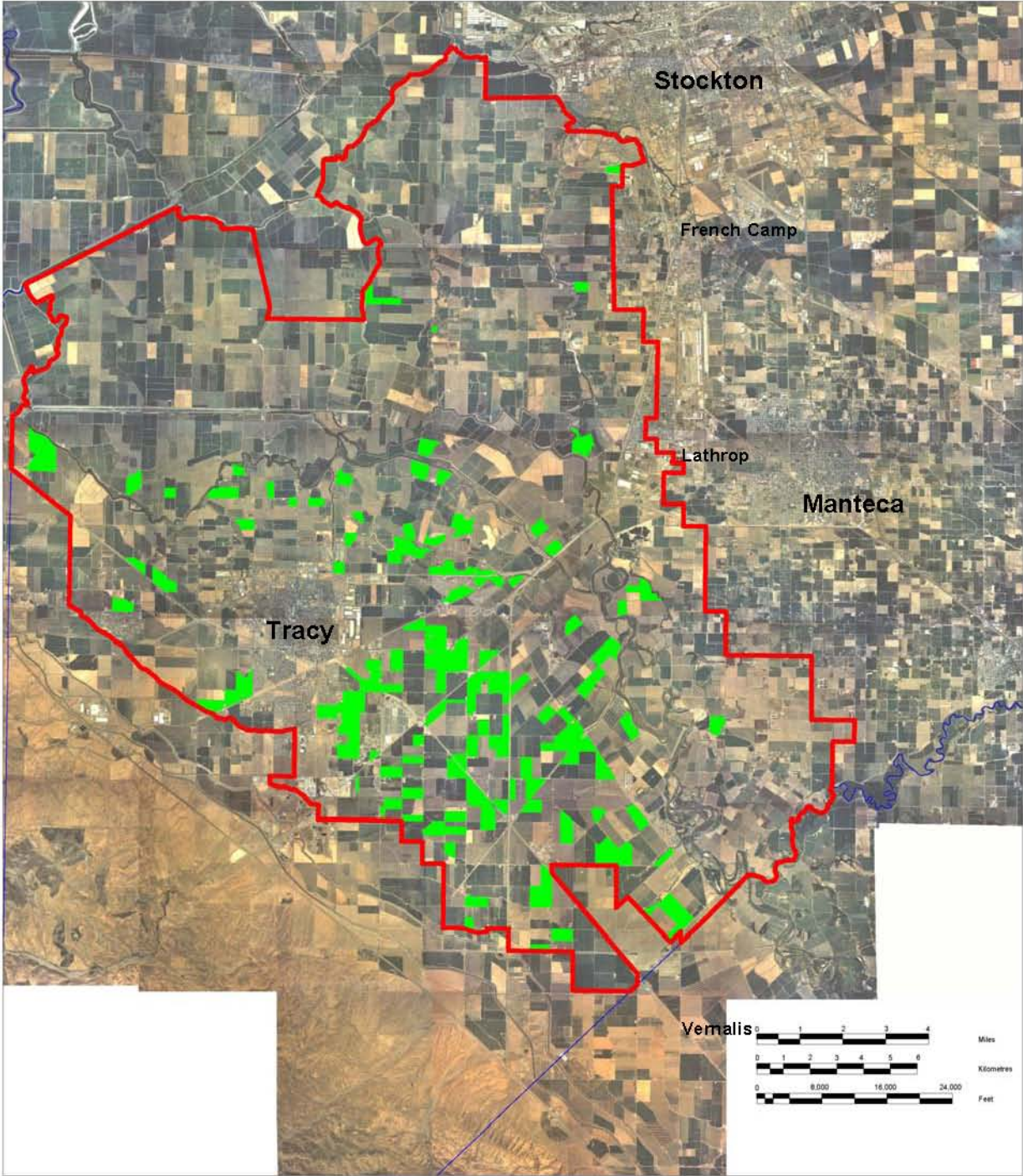

**Legend**

- Beans Mapped in 1996 Land Use Survey of San Joaquin County
- South Delta Water Agency Boundary (DRAFT, Subject to Correction)
- San Joaquin County Boundary

Aerial Photo: June, 1996

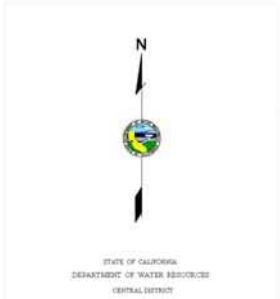

Currently, almost all of the beans grown in the South Delta that are irrigated with San Joaquin River water are grown in the BCID. (US Geological Survey 7.5 Minute Topographic Map, Tracy and Vernalis quadrangles; see Bay-Delta SJRG-EXH-35, “Statement, Appendix A, Terminology”, p21 (available at <http://www.waterrights.ca.gov/baydelta/docs/exhibits/SJRG-EXH-35.pdf>); see Figure 10, below.) In 2003, the bean farmers in the BCID grew 2,301 acres of beans. (Banta Carbona Irrigation District Crop Reports for 2003 and 2004; see Appendix A, p1 Attached.)

Figure 10. Banta Carbona Irrigation District, 1996 Land Use Survey, Bean Fields.

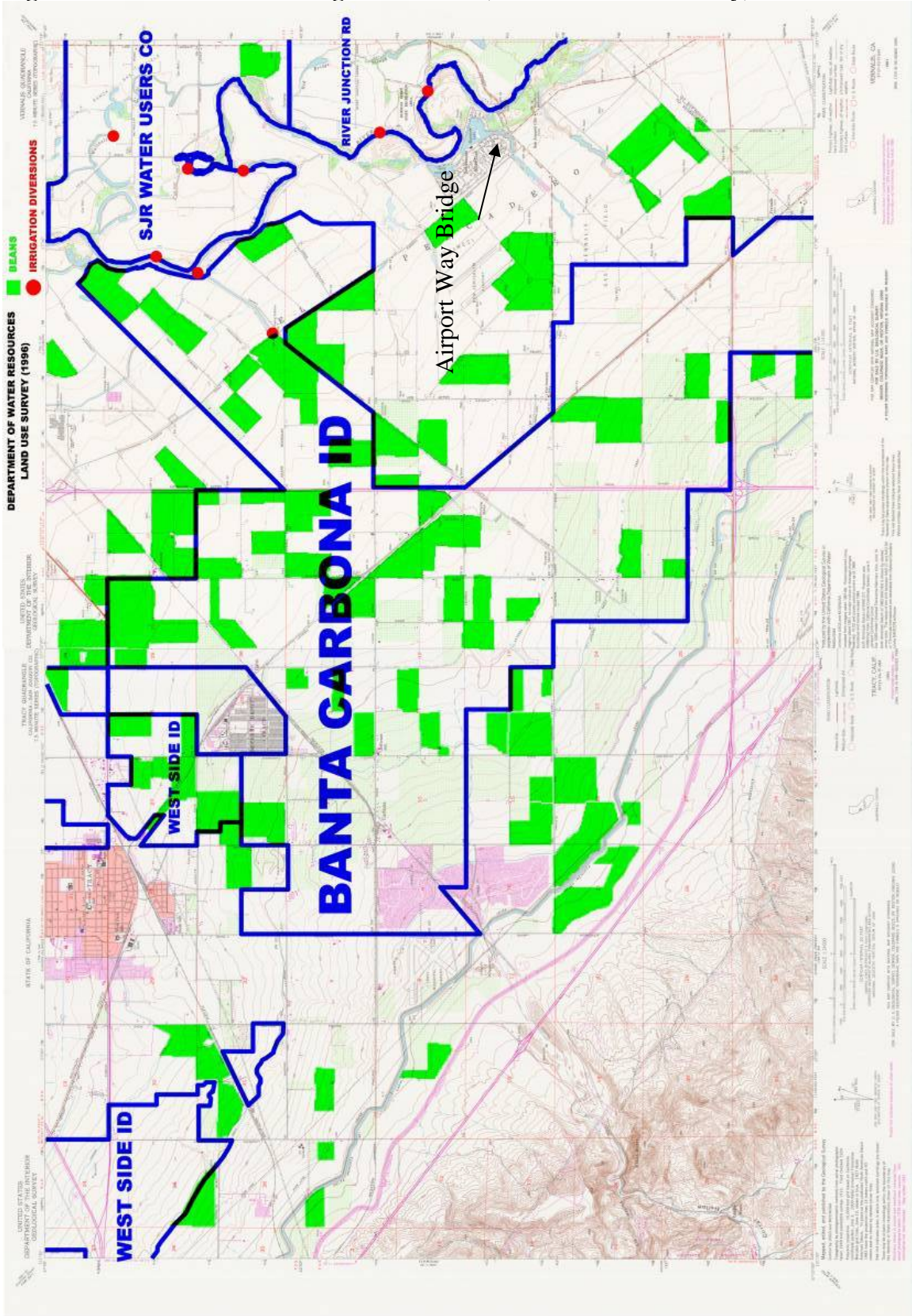

Although beans are grown along the San Joaquin River below BCID, few, if any, are irrigated with San Joaquin River water. Beans are grown in the Pescadero Reclamation District (“RD”) (RD #2058) and Island RD (RD #2062), but neither divert water from the San Joaquin River. (Id., p20; see Figure 11, below.)

**Figure 11. Pescadero Reclamation District (RD #2058) and Island Reclamation District (RD #2062), 1996 Land Use Survey, Bean Fields.**

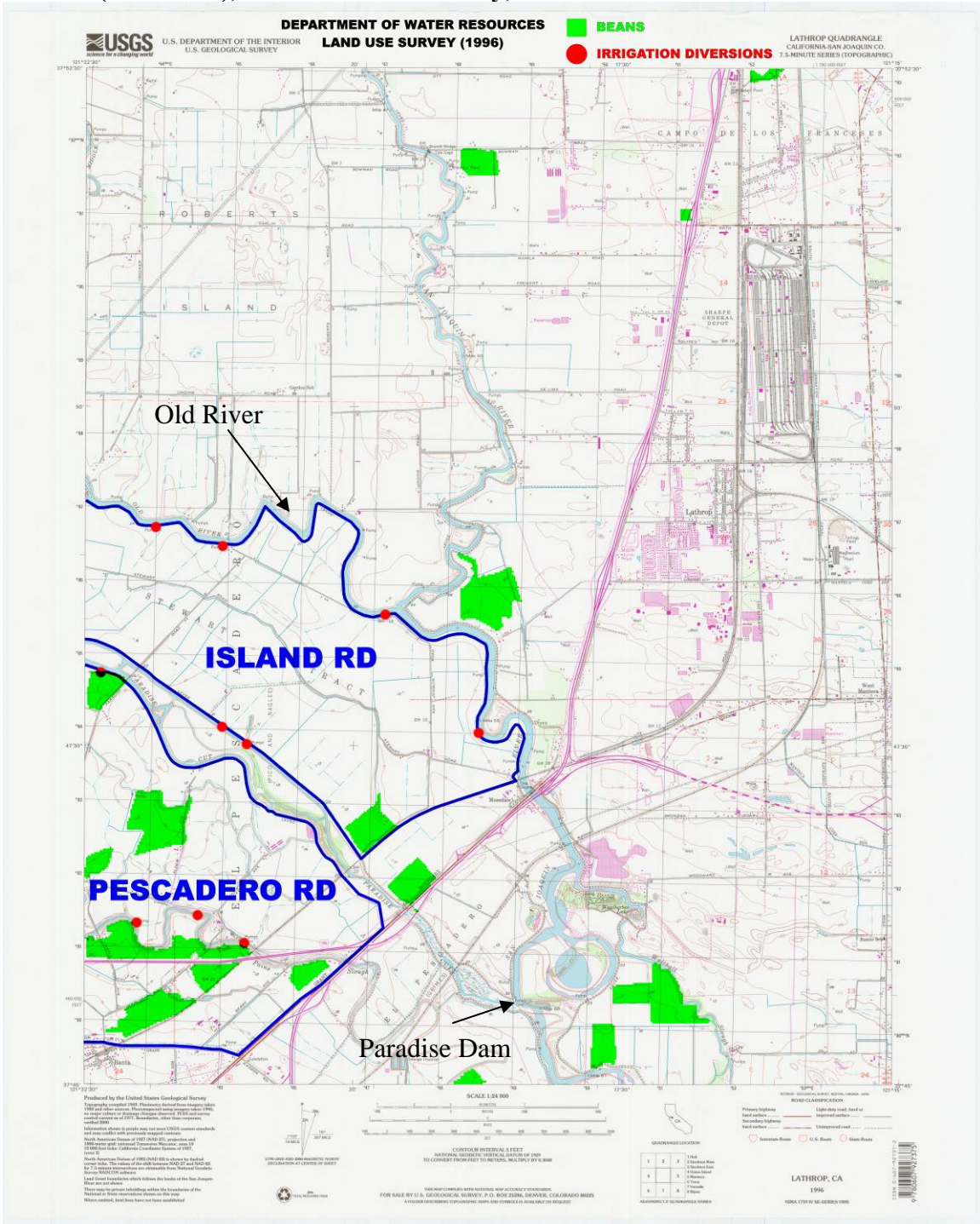



**B. Irrigation Salinity Needs.**

The Water Code defines water quality objectives as “the limits or levels of water quality constituents or characteristics which are established for the reasonable protection of beneficial uses of water or the prevention of nuisance within a specific area.” (Water Code §13050(i).) In formulating water quality control plans, the State Board has broad authority “to attain the highest water quality which is reasonable, considering all demands being made and to be made on those waters and the total values involved, beneficial and detrimental, economic and social, tangible and intangible.” (Water Code §13000.) In fulfilling its statutory imperative, the Board is required to establish water quality objectives that will ensure the reasonable protection of beneficial uses. (Water Code §13241) As the South Delta EC Objectives are based on research conducted by the University of California thirty years ago, one of the issues in the Periodic Review of the 1995 Water Quality Control Plan was whether the State Board should modify the South Delta EC Objectives. (State Board Water Rights Order No. 2006-0006, p8 (available at [http://www.waterrights.ca.gov/Hearings/WaterRightOrders/2006/wro2006\\_0006.pdf](http://www.waterrights.ca.gov/Hearings/WaterRightOrders/2006/wro2006_0006.pdf)); Revised Draft 2006 Bay-Delta Plan Appendix I, p64 (available at [http://www.waterrights.ca.gov/baydelta/docs/rev2006wqcp\\_app1.pdf](http://www.waterrights.ca.gov/baydelta/docs/rev2006wqcp_app1.pdf)).

The SJRGA submitted recent scientific information, in addition to economic and policy information demonstrating that the current South Delta EC Objective was unnecessarily low and not reasonable to protect agricultural beneficial uses in the South Delta. (Revised Draft 2006 Bay-Delta Plan Appendix I, p67.) Analysis by Dr. Jim Brownell of the leaching effects of rainfall concluded that irrigation water with an EC of 1.1 dS/m would adequately protect agricultural beneficial uses in the South Delta. (See

Bay-Delta SJRG-EXH-06, “Statement, Presentation of James R. Brownell, PhD” (March 9, 2005), p12 (available at <http://www.waterrights.ca.gov/baydelta/docs/exhibits/SJRG-EXH-06.doc>.)

Additionally, a site-specific model developed by Drs. Stephen R. Grattan, Maria Jose Berenguer-Merelo, and Daniel Isidoro-Ramirez can determine the maximum irrigation water supply fully protective of crop production, while accounting for annual rainfall and other site-specific conditions. (“UC Davis Site-Specific Irrigation Salinity Model”) (Bay-Delta SJRG-EXH-03, “An Approach to Develop Site-Specific Criteria for Electrical Conductivity to Protect Agricultural Beneficial Uses that Accounts for Rainfall” (July 2004) (available at <http://www.waterrights.ca.gov/baydelta/docs/exhibits/SJRG-EXH-03.pdf>.) The model considers the timing and quantity of applied irrigation water, the quantity and distribution of rainfall, and realistic assumptions related to soil water principles based on soil type. (Id., p1.) Additionally, it can quantify the extent by which an irrigation water supply of a given EC would diminish the yield potential of a given crop under site-specific conditions. (Id.) Grattan et al. applied the UC Davis Site-Specific Irrigation Salinity Model in the Putah Creek area and determined that, over a 53-year rainfall period, an EC threshold of 1.1 dS/m was sufficient to protect beans. (Id., p3.)

After the salinity phase of the Period Review of the 1995 Bay-Delta Plan, Dr. John Letey, who also considered the effects of leaching and rainfall, testified, under oath and cross-examination, in the Cease and Desist Order proceedings for Water Rights Order No. 2006-0006, that “[b]ased on the dynamics of water flow, salt transport, and crop-soil water interactions, an irrigation water with an EC of 1.0 dS/m is sufficiently

protective of salt-sensitive crops and can be used to irrigate these crops without yield reduction.” (CDO 262.31-17 Exhibit DWR-22, p15 (available at [http://www.waterrights.ca.gov/Hearings/docs/usbr/dwr22\\_rev.pdf](http://www.waterrights.ca.gov/Hearings/docs/usbr/dwr22_rev.pdf).) Dr. Letey also noted that in the Imperial and Coachella Valleys of California salt-sensitive crops are successfully irrigated with Colorado River water with an EC of approximately 1.25 dS/m. (Id., p8.)

In the Periodic Review of the 1995 Bay-Delta Plan, the South Delta Water Agency (“SDWA”) argued that South Delta soil types and complicating factors associated with cultural practices, such as soil compaction caused by mowing, variable leach time during the crop season, and root aeration problems that occur when soaking for high leaching fractions, make high leaching fractions, even the 15 percent assumed in establishing the current South Delta EC objectives, unobtainable. (Revised Draft 2006 Bay-Delta Plan Appendix I, p69-70.)

Despite the difficulties described by SDWA, South Delta bean farmers have no problem achieving high leaching fractions. In 2004, nearly all of the beans grown in the South Delta that were irrigated with San Joaquin River water were grown in the BCID and irrigated with approximately 40 inches of water per acre. (Bay-Delta SJRG-EXH-06, p2; See Exhibit A, BCID 2003-2004 Crop Reports.) Since dry beans have an evapotranspiration requirement of 22-23 inches, 40 inches of irrigation water with an EC of 1.0 dS/m would produce a leaching percentage of nearly 75%, far more than the 15 percent assumed necessary for the current South Delta EC Objectives. (See Bay-Delta SJRG-EXH-06, p7.)

**C. Actions to Control Salinity and the Effects of These Actions.**

Many programs that may affect EC at the Interior South Delta stations have been implemented, but many others are under development. Some projects are intended to directly improve EC at Vernalis, which, because EC at Vernalis determines EC at Brandt Bridge, would also improve EC at Brandt Bridge. Other projects, particularly, the South Delta Improvements Program (“SDIP”), will primarily benefit EC at Old River near Middle River and Old River at Tracy Road Bridge. Finally, some projects will indirectly benefit EC in the South Delta as a whole. D-1641 and the SDIP, discussed supra, are among the most significant projects that have been implemented or will be implemented to improve Delta salinity.

**1. Water Rights Decision 1641.**

Modeling used to develop the IPO predicted that strict adherence could result in exceedances in approximately 10 percent of months. (*CDWA v USBR* supra 452 F.3d at 1025.) Newer modeling conducted with the latest version of CALSIM II has demonstrated that the Vernalis EC Objective can be met in all years relying solely on supply from New Melones. (Bay-Delta SJRG-EXH-07, “Presentation of Daniel B. Steiner Concerning San Joaquin River Hydrology and Alternative Flow and Quality Objectives at Vernalis,” p13 (March 2005) (available at <http://www.waterrights.ca.gov/baydelta/docs/exhibits/SJRG-EXH-07.pdf>.) Criticism that exceedances may occur in the future assume that the USBR will continue relying exclusively on dilution flows from New Melones and, as a result, could expend sufficient supply if a prolonged drought occurred. However, the USBR has, in the past, deviated

from the IPO in order to comply with its obligations and will do so in the future in order to comply with its obligations. (CDWA v USBR supra 452 F.3d at 1026-1027.)

**2. Irrigated Lands Conditional Waiver.**

The Central Valley Regional Water Board implemented its Conditional Waiver Program for Irrigated Lands in 2004 to reduce or eliminate discharges of pollutants to surface water bodies from Central Valley agricultural return flows and storm water runoff that currently contribute salt and other pollution to tributaries to the southern Delta. (2006 Bay-Delta Plan Appendix I, p66.) The program was readopted in 2006, pursuant to Regional Board Resolution Nos. R5-2006-0053 and R5-2006-0054.

**3. San Luis Drainage Feature Reevaluation.**

The USBR has released the draft EIR/EIS for the San Luis Unit Drainage Feature Reevaluation Project, which includes seven project alternatives. (2006 Bay-Delta Plan, p31.) The preferred project alternative would reduce discharges into the SJR using a combination of land retirement, on-farm drainage reduction, improved water use efficiency, and treatment of drain water. (Id.) Implementation is expected to significantly reduce saline discharges into the San Joaquin River.

**4. SJR Salt & Boron TMDL.**

The “Amendments for the Water Quality Control Plan for the Sacramento and San Joaquin River Basins for the Control of Salt & Boron Discharges into the Lower San Joaquin River” (“SJR Salt & Boron TMDL”), adopted by Regional Board Resolution No. 2004-0108 and approved by State Board Resolution 2005-0087, established a total maximum daily load (“TMDL”) for the Lower San Joaquin River. The purpose of the SJR Salt & Boron TMDL is to achieve the Vernalis EC Objective by requiring

dischargers of salts to cease discharging, particularly if the discharge exceeds 315 uS/cm, and requiring that dischargers operate under waivers of waste discharge requirements.

(SJR Salt & Boron TMDL Final Staff Report, p1 (available at

<http://www.waterboards.ca.gov/centralvalley/programs/tmdl/vernalissaltboron/StaffRptDec04.pdf>.)

The SJR Salt & Boron TMDL does not address EC downstream of Vernalis, even though the segment of the SJR downstream of Vernalis is the segment whose beneficial uses the Vernalis EC Objective is designated to protect, and the Delta Waterways, which include the segment of the SJR below Vernalis, are listed as water quality limited segments, pursuant to §303(d) of the Clean Water Act. (2006 Bay-Delta Plan, p13 Table 2; 2006 California Clean Water Act §303(d) List of Water Quality Limited Segments; 2006 CWA §303(D) List of Water Quality Limited Segments (Central Valley Region), p9 (available at

[http://www.waterboards.ca.gov/tmdl/docs/303dlists2006/final/r5\\_final303dlist.pdf](http://www.waterboards.ca.gov/tmdl/docs/303dlists2006/final/r5_final303dlist.pdf).) No

TMDL is scheduled for the southern portion of the Delta Waterways until 2019. (2006 California Clean Water Act §303(d) List of Water Quality Limited Segments; 2006 CWA §303(D) List of Water Quality Limited Segments (Central Valley Region), p9 (available at [http://www.waterboards.ca.gov/tmdl/docs/303dlists2006/final/r5\\_final303dlist.pdf](http://www.waterboards.ca.gov/tmdl/docs/303dlists2006/final/r5_final303dlist.pdf).)

## **5. Grasslands Bypass Project.**

The Grasslands Bypass Project manages discharges of agricultural drainage water from 97,000 acres in the Grasslands Watershed. (2006 Bay-Delta Plan, p30.) Although the primary purpose of the project is to control selenium discharges to wildlife refuges and wetlands in the San Joaquin Valley, it has also reduced salt loading by 39 percent,

from 187,000 tons to 113,600 tons, through sump management, recycled tail and tile water programs, on-farm tile and tail water management, and various source control and other measures. (Id.)

#### **6. West Side Regional Drainage Plan.**

The West Side Regional Drainage Plan evolved from the Grasslands Bypass Project as a long-term solution to eliminate discharges to the San Joaquin River of agriculture return flows containing high amounts of selenium, salt and other constituents. (2006 Bay-Delta Plan, p31.) The plan reduces drainage volume through improved source controls and improved water use efficiency, re-circulating tailwater on primary irrigation lands, collecting and reusing tile drainage, installing and pumping groundwater wells to reduce infiltration into groundwater, and treating and disposing of remaining drain water through reverse osmosis, evaporation, and disposal or reuse of salts. (Id.) When fully implemented, the plan will assist in maintaining EC at Vernalis and reduce the frequency of exceedances at Brandt Bridge. (Id.) Full implementation is anticipated by 2010.

#### **D. Reasonableness of Existing Objectives.**

Currently, the USBR and DWR are committed to meeting the EC Objective at Brandt Bridge, although doing so may require reducing EC at Vernalis to slightly below 700 uS/cm to allow for the natural effects of agricultural drainage to the San Joaquin River. (SDIP Final EIR/EIS, p[5-214] (available at [http://sdip.water.ca.gov/documents/final\\_eis\\_eir/vol-1/FEIS/ch05-p5.pdf](http://sdip.water.ca.gov/documents/final_eis_eir/vol-1/FEIS/ch05-p5.pdf).) The SDIP is not expected to improve compliance or otherwise affect at Brandt Bridge. (Id.)

The USBR can use “any measures available” to meet the Vernalis Objectives, but has historically used flow. (D-1641, p79, 89.) In D-1422, the USBR estimated salinity

control at Vernalis would require no more than 70,000 AF. (Id.) In some years however, water quality releases have more than doubled the USBR's 70,000 AF estimate. (Id.) Under the IPO, the USBR allocated up to 250,000 AF for water quality. (Id., p80.) In Dry years, implementing the Vernalis EC Objective at 700 uS/cm, as opposed to 1,000 uS/cm, requires 30,000 acre-feet of water. (Bay-Delta SJRG-EXH-07, p22.) In Critical years, that amount climbs to 57,000 acre-feet. (Id.) Implementing the Brandt Bridge EC Objective by maintaining an EC at Vernalis slightly below the required objectives in order to account for the effects of agricultural drainage would require even more water, even though the South Delta EC Objectives only protect about 3,000 acres of beans.

In such years, Term 91 takes effect, limiting the flow available for appropriators.<sup>18</sup> Term 91 prohibits a permittee or licensee from diverting water if the water to be diverted was appropriated for upstream storage or imported into the watershed by either the CVP or SWP and either the SWP or CVP is releasing that stored or imported water for either in-basin entitlements or export from the basin. (State Board Water Rights Order No. 2004-0004 (2004 WL 367585), p3.) The State Board adds Term

---

<sup>18</sup> Term 91 provides:

"No diversion is authorized by this permit when satisfaction of in-basin entitlements requires release of supplemental Project water by the Central Valley Project or the State Water Project.

"a. In-basin entitlements are defined as all rights to divert water from streams tributary to the Sacramento-San Joaquin Delta or the Delta for use within the respective basins of origin or the Legal Delta, unavoidable natural requirements for riparian habitat and conveyance losses, and flows required by the State Water Resources Control Board for maintenance of water quality and fish and wildlife. Export diversions and Project carriage water are specifically excluded from the definition of in-basin entitlements.

"b. Supplemental Project water is defined as that water imported to the basin by the projects plus water released from Project storage which is in excess of export diversions, Project carriage water, and Project in-basin deliveries.

"The State Water Resources Control Board shall notify permittee of curtailment of diversion under this term after it finds that supplemental Project water has been released or will be released. The Board will advise permittee of the probability of imminent curtailment of diversion as far in advance as practicable based on anticipated requirements for supplemental Project water provided by the Project operators."



91 to new permits. (Id.) A similar term, Term 80, has been added since the 1960's. (Id.) Term 91 thereby prohibits diversion by any permit holder or licensee whose appropriate right if it is included among that party's permit or license terms. South Delta licenses and permits have not been reviewed to determine how much diversion would occur if Term 91 were in effect.

Appropriators with Term 91 may divert water if they have a supplemental supply, such as a riparian water right. (Id.) However, riparian water right holders are limited to diverting natural flow. (Id.) A riparian cannot require that upstream appropriators discharge water into a stream during months in which there would be no flow if a dam had not been built. (State Water Resource Control Board Cases ("Robie") (2006) 136 Cal.App.4th 674, 738.) Lack of natural flow in some months of Dry and Critical years precludes diversion by riparian water right holders. (D-1641, p32 Figure 1.)

The degree to which the South Delta diversion requirement exceeds natural flow is less than that estimated by the State Board, because the estimate, provided by SDWA, assumed all lands in the South Delta have riparian water rights. (Id.) As the State Board determined in Water Rights Order No. 2004-0004 however, not all lands in the South Delta have riparian water rights. (State Board Water Rights Order No. 2004-0004 (2004 WL 367585), p22.)

With diminished diversion for irrigation purposes, using over 30,000 acre-feet in Dry years and 57,000 acre-feet in Critical years for 3,000 acres of beans is not a reasonable use of water.

## **E. RECOMMENDED COURSE OF ACTION.**

The current South Delta EC objectives for agricultural beneficial uses were adopted based on the salinity threshold of the most salt-sensitive crops then grown in the South Delta, under South Delta conditions, and on South Delta soils. (1991 Bay-Delta Plan, p[5-9]; State Board Resolution No. 95-24, p2.) The same premise should continue to apply, but the land use, soil, and science that followed and led to the current objectives is now 30 years old. As the State Board acknowledged in the 2006 Bay-Delta Plan, adopted pursuant to Resolution No. 2006-0098 on December 13, 2006:

There is a need for an updated independent scientific investigation of irrigation salinity needs in the southern Delta (similar to the investigation on which the current objectives are based). The scientific investigation should address whether the agricultural beneficial uses in the southern Delta would be reasonably protected at different salinity levels, whether management practices are available that would allow for protection of the beneficial uses at a higher salinity level in the channels of the southern Delta, and whether such management practices are technically and financially feasible. The investigation could address the feasibility of providing an alternative method of delivering fresh water to agricultural water users in the southern Delta. The scientific investigation must be specific to the southern Delta.

(Revised Draft 2006 Bay-Delta Plan, p33 (available at <http://www.waterrights.ca.gov/baydelta/docs/rev2006wqcp.pdf>.) Before establishing salinity objectives that may apply under low-flow conditions, or in the absence of natural flow, the State Board must first determine whether, and to what extent, agricultural beneficial uses exist under low-flow conditions and in the absence of natural flow.

### **1. Update and Compile Land Use and Diversion Data.**

The most recent DWR land use survey for San Joaquin County was conducted in 1996, but must be updated to obtain a current, accurate picture of South Delta agriculture

and the prevalent salt-sensitive crops. Additionally, the San Joaquin County soil survey, currently only available in must be converted to a GIS format so its data may be integrated with land use data. The EC objectives can then be reevaluated based on the prevalent salt-sensitive crops and soil types.

## **2. Review South Delta Water Rights.**

The field survey of diversion and discharge points on the San Joaquin River reported in “Water diversion and discharge points along the San Joaquin River, Mendota Pool Dam to Mossdale Bridge: California,” was extremely detailed, describing diversion rates, places of use, and crops grown, but it was performed twenty years ago and only as far downstream as Mossdale. (Water Diversion and Discharge Points Along the SJR, p1.) A similar field survey of diversions, the lands irrigated, and the practices used must be performed throughout the South Delta.

Then, as with the Water Diversion and Discharge Points Along the SJR, the field survey data must be compiled with water rights information to determine which pumps belong to appropriators and which pumps do not. Once it is determined which pumps belong to appropriators, the place of use maps on file with water right permits and licenses must be reviewed. In Water Diversion and Discharge Points Along the SJR, all lands not irrigated pursuant to appropriative rights or statements of diversion, were assumed to irrigate pursuant to riparian water rights. As Water Right Order No. 2004-0006 demonstrated however, such an assumption is unsafe. Chain of title searches would have to be performed to determine whether a diverter without an appropriative right has a riparian water right.

All of the foregoing information would then be converted to a GIS format so it can be precisely correlated with land use and soil data. The 28 diversions and 18 discharges surveyed in 1985 and 1986 would provide a starting point for the survey.

The survey would also allow for analysis of diversion practices in the South Delta. For example, the BCID irrigates with water from the San Joaquin River and the Delta Mendota Canal and Island RD (RD #2062), may irrigate the same land and crops with water from Old River and Paradise Cut. (Water Right License No. 5404, Application No. 1933; Statement of Diversion No. 495; Water Right License No. 2637, Application No. 5155.)

### **3. Review Actual Agricultural Beneficial Uses.**

Due to the effect of Term 91 and riparian water right restrictions to natural flow, instream flows may consist of water released for in-basin purposes other than agricultural beneficial uses. If site-specific conditions warrant less stringent effluent limits than those based on promulgated water quality objectives, then a site-specific objective may be appropriate. (State Water Resources Control Board, “Impaired Waters Guidance”, adopted pursuant to Resolution No. 2005-0059, p[1-2] (available at [http://www.swrcb.ca.gov/tmdl/docs/iw\\_guidance.pdf](http://www.swrcb.ca.gov/tmdl/docs/iw_guidance.pdf).)

In the alternative, a use attainability analysis could be performed and the Basin Plan could be amended such that agricultural beneficial uses do not exist when no flow would be available for diversion. A beneficial use that is not an existing use or cannot be attained by implementing effluent limits and cost-effective and reasonable best management practices for non-point source controls may be removed if:

1. Naturally occurring pollutant concentrations prevent the attainment of the use.

2. Natural, ephemeral, intermittent, or low flow conditions or water levels prevent the attainment of the use, unless these conditions may be compensated for by the discharge of sufficient volume of effluent discharges without violating State water conservation requirements to enable uses to be met.
3. Human-caused conditions or sources of pollution prevent the attainment of the use and cannot be remedied or would cause more environmental damage to correct than to leave in place.
4. Dams, diversions, or other types of hydrologic modifications preclude the attainment of the use, and it is not feasible to restore the water body to its original condition or to operate such modification in a way that would result in the attainment of the use.
5. Physical conditions related to the natural features of the water body, such as the lack of a proper substrate, cover, flow, depth, pools, riffles, and the like, unrelated to water quality preclude attainment of aquatic life protection uses.
6. Controls more stringent than those required by §§301(b) and 306 of the Clean Water Act would result in substantial and widespread economic and social impact.

(40 CFR §§131.10(g), (h).)

Low flows, in addition to human-caused effluents, were significant factors driving the decision of the SWRCB to recommend a Basin Plan Amendment de-designating Old Alamo Creek for MUN use. (State Water Board WQO 2002-0015 (2002 WL 31519379), p20 (available at <http://www.waterboards.ca.gov/resdec/wqorders/2002/wqo/wqo2002-0015.doc>.) Old Alamo Creek was originally the downstream portion of Alamo Creek, but, except for the section downstream of the City of Vacaville's Easterly Wastewater Treatment Plant, was left dry much of the year when, in 1966, Alamo Creek was diverted into New Alamo Creek. (Resolution R5-2005-0053, Amendment to the Water Quality Control Plan for the Sacramento River and San Joaquin River Basins to De-designate Four Beneficial Uses for Old Alamo Creek Final Staff Report ("R5-2005-0053 Staff report"), p4 (April 2005), available at

[http://www.waterboards.ca.gov/centralvalley/available\\_documents/basin\\_plans/AlamoFinnalRpt.pdf](http://www.waterboards.ca.gov/centralvalley/available_documents/basin_plans/AlamoFinnalRpt.pdf), accessed June 8, 2006.) The SWRCB, and subsequently the Central Valley Regional Water Quality Control Board (“Regional Board”), found no evidence anyone had ever directly used Old Alamo Creek for drinking water due to very low flows that consisted primarily of discharged from the wastewater treatment plant.<sup>19</sup> (SWRCB WQO 2002-0015 2002 WL 31519379, p20; R5-2005-0015.) Pursuant to the State Board’s recommendation, the Regional Board drafted a staff report and amended the basin plan, de-designating Old Alamo Creek for MUN uses. (Regional Board Resolution No. R5-2005-0053 (available at [http://www.swrcb.ca.gov/rwqcb5/adopted\\_orders/Resolutions/R5-2005-0053.pdf](http://www.swrcb.ca.gov/rwqcb5/adopted_orders/Resolutions/R5-2005-0053.pdf).)

If, based on a review of water rights, no diversion for agricultural beneficial uses could occur, then that particular stream reach should be de-designated for agricultural beneficial uses when such conditions exist.

**4. Apply the Grattan, Berenguer-Merelo, and Isidoro-Ramirez Site-Specific Salinity Model in the South Delta to Determine Site-Specific Irrigation Salinity Requirements.**

The State Board should review the UC Davis Site-Specific Irrigation Salinity Model and, if use of the model deemed appropriate, apply it in various areas of the South Delta to determine site-specific irrigation salinity needs. The UC Davis Site-Specific Irrigation Salinity Model would yield data useful in developing more precise EC objectives for the South Delta. The San Joaquin River Group Authority would share costs for such an effort.

---

<sup>19</sup> The City of Vallejo operated a drinking water intake in Cache Slough until 1992, but such use did not constitute “direct” use from Old Alamo Creek. (*Id.* at 20-21.)

**5. Coordinate with Studies Conducted for the 2006 Bay-Delta Plan and Central Valley Salinity Policy Group Actions.**

The 2006 Bay-Delta Plan recommended many additional actions and studies, some of which were discussed as “Actions to Control Salinity and the Effects of These Actions” (see Section C, *supra*). The 2006 Bay-Delta Plan also recommended “an updated independent scientific investigation of irrigation salinity needs in the southern Delta (similar to the investigation on which the current objectives are based).” (2006 Bay-Delta Plan, p33.) The current South Delta EC Objectives were developed to reasonably protect crops grown in the southern Delta, using beans and alfalfa as representative salt-sensitive crops. (1991 Bay-Delta Plan, p[5-9].) An updated scientific investigation should adopt a similar premise, with updated science and, if land use has changed, different representative salt-sensitive crops. Beans, for example, may no longer be the most representative salt-sensitive crop for South Delta agriculture if only 3,000 acres are irrigated with water from the San Joaquin River.

To avoid duplication and conflict, any revisions of Southern Delta Water Quality Objectives for Salinity should be coordinated with the 2006 Bay-Delta Plan’s updated independent scientific investigation of irrigation salinity needs in the southern Delta and with studies, recommendations, and other projects produced by the Central Valley Salinity Policy Group.

**F. Allocating Responsibility.**

Currently, the permits and licenses for the USBR and DWR require that the agencies “ensure” compliance with the South Delta EC Objectives at the three interior South Delta stations, with a barrier program recommended as a method of achieving compliance. (D-1641, p163.) If an exceedance occurs, the USBR and DWR must report

the exceedance to the Executive Director, who will then evaluate the report and determine whether enforcement action is warranted or the exceedance is due to actions beyond the control of the USBR and DWR. (Id.) Only the USBR's permit for New Melones diversion prohibits diversion for consumptive use if water quality objectives are not met, and, even then, only for the Vernalis EC Objective and the San Joaquin River Dissolved Oxygen Objective. (D-1641, p162.)

With the exception of the Irrigated Lands conditional waiver, no responsibility for controlling EC has been allocated to dischargers, even though the New Jerusalem Drainage Outlet and McMullin RD (RD #2075) discharge significant amounts of saline agriculture drainage. The Delta Waterways are listed as water quality limited segments due to EC and Boron, pursuant to §303(d) of the Clean Water Act, but no TMDL is scheduled until 2019.

#### **IV. CONCLUSION.**

The South Delta EC Objectives were developed and adopted to protect agricultural beneficial uses based on salinity thresholds necessary to prevent diminished yield of salt-sensitive crops. At the time, beans and alfalfa served as representative salt-sensitive crops, but today, only 3,000 acres of beans are irrigated with San Joaquin River water and, and, due to barrier operations, San Joaquin River EC affects EC downstream, but EC at Old River near Middle River or Old River at Tracy Road Bridge.

The most recent land use data for the South Delta is ten over years old and, because the San Joaquin County soil survey is only available in paper form, cannot be combined in a GIS format and precisely evaluated. Diversions and drains have only been surveyed as far downstream as Mossdale Bridge and, even then, only as recent as twenty



years ago. Finally, the science upon which the objectives were based is now thirty years old and, as the State Board acknowledged in the 2006 Bay-Delta Plan, an updated scientific investigation of irrigation salinity need in the South Delta is necessary, and the UC Davis Site-Specific Irrigation Salinity Model should be used this process. In short, all of the information used to develop the current South Delta EC Objectives must be updated.

First and foremost however, the South Delta EC Objectives must be based on actual, existing beneficial uses. If Term 91 and the limitations of riparian water rights to natural flow preclude diversion for agricultural beneficial uses, then agriculture is not an existing beneficial use when Term 91 is in effect. Consequently, the State Board should recommend, and the Regional Board adopt, a basin plan amendment with either a site-specific objective or a use attainability analysis that de-designates applicable portions of the Delta for agricultural beneficial uses when either Term 91 precludes diversion pursuant to appropriative rights or lack of natural flow precludes diversion pursuant to a riparian right.

# **APPENDIX A**

# District Crop Production Report

Year: 2004

**Banta Carbona Irrigation District**  
**3514 West Lehman Road**  
**Tracy CA, 95378-**

<u>Crop Name</u>	<u>Acres</u>	<u>Acre-Feet</u>	<u>Acre-Feet/Acre</u>
Alfalfa Hay	2,939.09 ✓	12,811.63	4.291
Almonds	1,445.40 ✓	4,472.58	3.094
Apples	88.00 ✓	319.05	3.626
Apricots	604.84 ✓	1,469.98	2.430
Beans - Processing	385.99 ✓	1,233.49	3.196
Beans, Dry and Edib	2,573.25 ✓	8,642.89	3.359
Cantaloupe	50.00 ✓	115.78	2.316
Cherries	12.91 ✓	7.85	0.608
Corn	161.00 ✓	706.40	4.388
Fallow	293.38	0.29	0.001
Grapes	233.22 ✓	394.96	1.693
Grapes, other	70.81 ✓	93.09	1.315
Honeyball, Honeyde	43.48 ✓	111.71	2.569
Nectarines	30.00 ✓	180.48	6.016
NON-AG	0.00	0.00	0.000
Non-Assigned	0.00	0.00	0.000
Nothing	60.00 ✓	267.38	4.456
Nursery-total	5.03 ✓	31.70	6.303
Pasture	46.20 ✓	107.91	2.336
Peaches	81.54 ✓	189.59	2.325
Pistachios	17.00 ✓	40.31	2.371
Plums	2.00 ✓	0.00	0.000
Squash	21.02 ✓	8.66	0.412
Tomatoes, canning	3,497.50 ✓	11,726.97	3.353
Walnuts	1,531.66 ✓	3,954.71	2.582
Wheat	382.19 ✓	1,400.73	3.665
<b>Total:</b>	<b>44,575.51</b>	<b>48,088.14</b>	<b>3.299</b>

3W-43  
3W-80A

Nothing Beans 60c ✓  
Nursery-total Tomato 10 #c ✓

14,841

Left  
 Yamasaki - 266 acres  
 Wheat - 98  
 Safflower - 30  
 Beans - 58 ✓  
 Tom - 80 ✓  
 266

does not receive  
 Irrigation water  
 from District

# District Crop Production Report

Year: ~~2004~~ 2003

**Banta Carbona Irrigation District**  
 3514 West Lehman Road  
 Tracy CA, 95378-

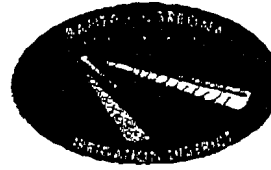

<u>Crop Name</u>	<u>Acres</u>	<u>Acre-Feet</u>	<u>Acre-Feet/Acre</u>
Alfalfa Hay	2,247.50 ✓	0.00	0.000
Almonds	1,384.66 ✓	0.00	0.000
Apples	104.99 ✓	0.00	0.000
Apricots	630.13 ✓	0.00	0.000
Barley - Feed	56.00 ✓	0.00	0.000
Beans, Dry and Edib	2,271.14 ✓	0.00	0.000
Blackeyes	30.00 ✓	0.00	0.000
Cantaloupe	197.63 ✓	0.00	0.000
Cherries	12.91 ✓	0.00	0.000
Corn	403.14 ✓	0.00	0.000
Fallow	367.73 ✓	0.00	0.000
Grapes	233.22 ✓	0.00	0.000
Grapes, other	70.81 ✓	0.00	0.000
Hay - Other	35.00 ✓	0.00	0.000
Nectarines	11.00 ✓	0.00	0.000
NON-AG	0.00	0.00	0.000
Non-Assigned	76.78	0.00	0.000
Nursery-total	5.03 ✓	0.00	0.000
Pasture	52.13 ✓	0.00	0.000
Peaches	91.32 ✓	0.00	0.000
Pistachlos	17.00 ✓	0.00	0.000
Plums	48.00 ✓	0.00	0.000
Safflower	120.00	0.00	0.000
Sugar Beets	68.91 ✓	0.00	0.000
Tomatoes, canning	3,957.89 ✓	0.00	0.000
Tomatoes, fresh	207.00 ✓	0.00	0.000
Vegetables, other	2.00	0.00	0.000
Walnuts	1,686.56 ✓	0.00	0.000
Wheat	302.69 ✓	0.00	0.000
<b>Total:</b>	<b>14,691.17</b> 18,257	<b>0.00</b>	<b>0.000</b>

3700-16  
 Beans 138  
 Almonds 58  
 Tomatoes 70  
 266

does not receive  
 Irrigation water from  
 District



# **APPENDIX B**

**RB5s/SJB/00003**

WATER DIVERSION AND DISCHARGE POINTS  
ALONG THE SAN JOAQUIN RIVER:  
MENDOTA POOL DAM TO MOSSDALE BRIDGE

Volume 1: Main Report

California Regional Water Quality Control Board  
Central Valley Region  
3443 Routier Road  
Sacramento, CA 95827-3098

April 1989

CALIFORNIA REGIONAL WATER QUALITY CONTROL BOARD  
CENTRAL VALLEY REGION

Board Members

Paul E. Simpson, Chair  
Clifford C. Wisdom, Vice Chair  
Karen Vercruse  
John S. Corkins  
Hugh V. Johns  
W. Steve Tompkins  
W. M. "Walt" Winn

William H. Crooks, Executive Officer

The staff involved in the  
preparation of this report are:

Edward W. James, Engineering Geologist  
Dennis W. Westcot, Senior Land and Water Use Analyst  
Jeanne L. Gonzalez, Geology Assistant

Special acknowledgement goes to those staff who spent countless hours doing the field surveys: Rudy J. Schnagl, John L. Menke, Louis F. Pratt, Christopher Cooper, and Ron R. Thomasson and to Brenda Grewell who prepared all the report graphics. Special thanks goes to the land owners, without whose cooperation this program would not have been possible.

TABLE OF CONTENTS

VOLUME 1: MAIN REPORT

	<u>Page</u>
SUMMARY . . . . .	1
INTRODUCTION . . . . .	1
STUDY AREA . . . . .	2
STUDY METHODS . . . . .	2
RESULTS . . . . .	2
River Sections . . . . .	11
Special Channel Surveys . . . . .	36
REFERENCES . . . . .	41

VOLUME 2: APPENDICES

- Appendix A - Detailed Descriptions of Discharge and Diversion Points Along the San Joaquin River from Mendota Dam to Mossdale Bridge at Interstate 5
- Appendix B - San Joaquin River Water Diversions Beneficial Use Survey (Lander Avenue Bridge to Airport Way near Vernalis)

LIST OF FIGURES (VOLUME 1)

<u>Figure</u>	<u>Page</u>
1 Location of River Sections 1 and 2 (Mendota Dam to Sack Dam) on the San Joaquin River Used to Describe Water Diversion and Discharge Points . . . . .	4
2 Location of River Sections 3 and 4 (Sack Dam to Mariposa Bypass (Intake)) on the San Joaquin River Used to Describe Water Diversions and Discharge Points . . . . .	5
3 Location of River Sections 5, 6 and 7 (Mariposa Bypass (Intake) to Bear Creek Inflow) on the San Joaquin River Used to Describe Water Diversions and Discharge Points . . . . .	6
4 Location of River Sections 8, 9, 10, 11 and 12 (Bear Creek Inflow to Hills Ferry Road Bridge) on the San Joaquin River Used to Describe Water Diversions and Discharge Points . . . . .	7



List of Figures (continued)

<u>Figure</u>	<u>Page</u>
5 Location of River Sections 13 and 14 (Hills Ferry Road Bridge to Patterson Bridge) on the San Joaquin River Used to Describe Water Diversions and Discharge Points . . . . .	8
6 Location of River Sections 15 and 16 (Patterson Bridge to Maze Road Bridge (HWY 132)) on the San Joaquin River Used to Describe Water Diversions and Discharge Points . . . . .	9
7 Location of River Sections 17, 18, 19 and 20 (Maze Road Bridge (HWY 132) to Mossdale Bridge (Interstate 5)) on the San Joaquin River Used to Describe Water Diversion and Discharge Points . . . . .	10
8 Schematic Diagram for Water Diversions and Discharges on the San Joaquin River from Mendota Dam to Avenue 7 1/2 (River Section 1) . . . . .	13
9 Schematic Diagram for Water Diversions and Discharges on the San Joaquin River from Avenue 7 1/2 to Sack Dam (River Section 2) . . . . .	15
10 Schematic Diagram for Water Diversions and Discharges on the San Joaquin River from Sack Dam to Santa Rita Bridge - Hwy. 152 (River Section 3) . . . . .	16
11 Schematic Diagram for Water Diversions and Discharges on the San Joaquin River from Santa Rita Bridge - Hwy. 152 to Mariposa Bypass (Intake) (River Section 4) . . . . .	17
12 Schematic Diagram for Water Diversions and Discharges on the San Joaquin River from Mariposa Bypass (Intake) to Turner Island Road (River Section 5) . . . . .	18
13 Schematic Diagram for Water Diversions and Discharges on the San Joaquin River from Turner Island Road to Mariposa Bypass (Outlet) (River Section 6) . . . . .	19
14 Schematic Diagram for Water Diversions and Discharges on the San Joaquin River from Mariposa Bypass (Outlet) to Bear Creek Inflow (River Section 7) . . . . .	21
15 Schematic Diagram for Water Diversions and Discharges on the San Joaquin River from Bear Creek Inflow to Lander Avenue Bridge (Hwy. 165) (River Section 8) . . . . .	22
16 Schematic Diagram for Water Diversions and Discharges on the San Joaquin River from Lander Avenue Bridge (Hwy. 165) to Upstream of Salt Slough (River Section 9) . . . . .	22

List of Figures (continued)

<u>Figure</u>	<u>Page</u>
17 Schematic Diagram for Water Diversions and Discharges on the San Joaquin River from Salt Slough Inflow to Fremont Ford Bridge (Hwy. 140) (River Section 10) . . . . .	23
18 Schematic Diagram for Water Diversions and Discharges on the San Joaquin River from Fremont Ford Bridge (Hwy. 140) to Upstream of Mud Slough (north) (River Section 11) . . . . .	25
19 Schematic Diagram for Water Diversions and Discharges on the San Joaquin River from Mud Slough (north) to Hills Ferry Road Bridge (River Section 12) . . . . .	26
20 Schematic Diagram for Water Diversions and Discharges on the San Joaquin River from Hills Ferry Road Bridge to Crows Landing Road Bridge (River Section 13) . . . . .	27
21 Schematic Diagram for Water Diversions and Discharges on the San Joaquin River from Crows Landing Road Bridge to Patterson Bridge (River Section 14) . . . . .	28
22 Schematic Diagram for Water Diversions and Discharges on the San Joaquin River from Patterson Bridge to Grayson Road Bridge (River Section 15) . . . . .	30
23 Schematic Diagram for Water Diversions and Discharges on the San Joaquin River from Grayson Road Bridge to Maze Road Bridge (Hwy. 132) (River Section 16) . . . . .	31
24 Schematic Diagram for Water Diversions and Discharges on the San Joaquin River from Maze Road Bridge (Hwy. 132) to Airport Way (Vernalis) (River Section 17) . . . . .	33
25 Schematic Diagram for Water Diversions and Discharges on the San Joaquin River from Airport Way (Vernalis) to Upstream of Banta-Carbona Intake Canal (River Section 18) . . . . .	34
26 Schematic Diagram for Water Diversions and Discharges on the San Joaquin River from Banta-Carbona Intake Canal to Paradise Dam (River Section 19) . . . . .	35
27 Schematic Diagram for Water Diversions and Discharges on the San Joaquin River from Paradise Dam to Mossdale Bridge (Interstate 5) (River Section 20) . . . . .	37
28 Schematic Diagram for Special Channel Survey A: Bear Creek from Eastside Bypass Inflow to San Joaquin River . . . . .	38

List of Figures (continued)

<u>Figure</u>	<u>Page</u>
29 Schematic Diagram for Special Channel Survey B: Old Grayson Channel from Origin to San Joaquin River . . . . .	39
30 Schematic Diagram for Special Channel Survey C: West Stanislaus Irrigation District from Pumps to San Joaquin River . . . . .	40

LIST OF TABLES

<u>Table</u>	<u>Page</u>
1 River Sections Used to Evaluate Influences of Water Development on San Joaquin River Hydrology . . . . .	3
2 Hydrologic Influences Within Each San Joaquin River Section . . . . .	12

## SUMMARY

Little information is available on the extent and magnitude of diversions of water from the San Joaquin River. Discharges from agricultural and other nonpoint sources are also poorly documented. To develop the data needed to establish beneficial uses and water quality objectives on the river, a study was conducted in 1985-86 to gain information on the hydrologic influences on it. A 150-mile reach of the San Joaquin River from the Mendota Dam near Mendota to Mossdale Bridge near Tracy was surveyed for water use and discharge points. This section of the river has 193 discharge points with nearly half of them occurring in a 46-mile section from Hills Ferry Road Bridge near Newman to Airport Way near Vernalis.

There are 89 points of water diversion for beneficial use within this same 150-mile reach. The density of diversion sites increases as each east side tributary contributes flow to the river. The predominant beneficial use is for irrigated agriculture. A special survey of irrigation use was conducted for the 48 diversion points that occur in the river between Lander Avenue near Stevinson to Airport Way near Vernalis. This reach of the river is most directly affected by discharges of agricultural subsurface drainage water. These 48 points supply all or a portion of the irrigation supply for over 60,000 irrigated acres which produce a variety of crops.

## INTRODUCTION

The State Water Resources Control Board hearings on the problems at Kesterson Reservoir identified the need to control the discharges of agricultural subsurface drainage into the San Joaquin River. Programs at the federal, State and local levels have been initiated to investigate the impacts this agricultural drainage may be having on the beneficial uses of the river. The Central Valley Regional Water Quality Control Board (Regional Board) has the primary responsibility for regulating the discharge of drainage water. As part of the development of this regulatory program, the Regional Board intensified monitoring of agricultural discharges and gathered data on the geographic distribution of discharge sources and users of San Joaquin River water.

The majority of the subsurface agricultural drainage pollutant load discharged to the San Joaquin River enters via Mud Slough (north) and Salt Slough in Merced County (James et al., 1988a and 1988b). The impact of these discharges, however, is highly modified by numerous diversions and discharges up and down stream of these two sloughs. The importance of these other discharges and diversions is manifested by the finding that the majority of the river in many months of the year is made up entirely of agricultural return flows, both surface and subsurface. Little information is available on the extent and magnitude of these diversion and discharge points. This study was initiated to gain information about the hydrology of the San Joaquin River as it relates to agricultural water use. The objective of the study was to physically characterize the San Joaquin River by identifying the surface hydrologic influences on it. The goals were a) to develop information that could be used in identifying the beneficial uses and appropriate water quality objectives for the San Joaquin River; b) to identify the need for regulatory actions; and c) to provide a data base for the flow model being developed for the San Joaquin River.

## STUDY AREA

The study area consists of the 150-mile reach of the San Joaquin River extending from Mendota Dam at the Mendota Pool near Mendota to the Mossdale Bridge at the point where Interstate 5 crosses the San Joaquin River near Tracy. Due to the extensive length of the river and major differences in the intensity of use along its length, the river was divided into 20 segments for analysis. The river segments chosen are described in Table 1 and shown in Figures 1 to 7. The river miles shown throughout this report are those used by the U.S. Army Corps of Engineers (1984). In addition to the segments of the main channel that were surveyed, special surveys were conducted on Bear Creek, the West Stanislaus Irrigation District Main Intake Channel, and the Grayson Slough Channel which was formerly the main branch of the San Joaquin River. All of these special surveys were conducted as significant inflow and outflow points occur on these channels and the main channels are not monitored as they enter the San Joaquin River.

The flow in the San Joaquin River is highly regulated and different reaches are strongly influenced by discharges or diversions into the river. Flow in the river from Mendota Dam to the Salt Slough inflow (75 river miles) consists exclusively of irrigation water diversions from the Mendota Pool and operational spill waters. Few other discharges occur in this portion of the river. The river is often dry beyond points of diversion for irrigation, thus flow, although highly variable, is dependent upon irrigation operations and localized seepage. Flow in the river from the Salt Slough inflow to the Merced River (11 river miles) is principally irrigation return flows from Mud Slough (north) and Salt Slough. The remainder of the river downstream of the Merced River is influenced by natural flow from the main east side tributaries and numerous diversions and discharges.

## STUDY METHODS

The study was initiated in spring 1985 with all field work completed by end of the summer 1986. The initial river survey was by air in April-May 1985. Additional information was obtained from U.S. Geological Survey Topographical Survey Maps, Soil Conservation Service records, and Regional Board files. This was followed by an on-the-ground inspection of the entire 150-mile reach of the San Joaquin River.

The on-the-ground survey of the San Joaquin River consisted of traveling its length, noting the location and type of all discharges and diversions. In addition, the source of the discharge was identified and the land being irrigated was noted for all diversions. Detailed photographs of each site are available in the Regional Board files.

## RESULTS

The river segment discussion that follows will describe the discharge and diversion data from south to north or upstream to downstream. The river miles are assigned, however, from the lowest miles downstream to the highest values upstream (denotes miles from the river terminus). This discussion will only present a summary of each river segment. More detailed supporting information

Table 1 River Sections Used to Evaluate Influences of Water Development on San Joaquin River Hydrology

<u>River Section</u>	<u>San Joaquin River Section Description</u>	<u>Section Length (miles)</u>
1	Mendota Dam to Avenue 7-1/2	9.6
2	Avenue 7-1/2 to Sack Dam	13.2
3	Sack Dam to Santa Rita Bridge (Highway 152)	8.1
4	Santa Rita Bridge (Highway 152) to Mariposa Bypass (Intake)	5.4
5	Mariposa Bypass (Intake) to Turner Island Road	11.4
6	Turner Island Road to Mariposa Bypass (Outlet)	9.8
7	Mariposa Bypass (Outlet) to Bear Creek Inflow	11.4
8	Bear Creek Inflow to Lander Avenue Bridge (Highway 165)	3.0
9	Lander Avenue Bridge (Highway 165) to Upstream of Salt Slough	3.4
10	Salt Slough Inflow to Fremont Ford Bridge (Highway 140)	4.3
11	Fremont Ford Bridge (Highway 140) to Upstream of Mud Slough (north)	4.1
12	Mud Slough (north) to Hills Ferry Road Bridge	3.0
13	Hills Ferry Road Bridge to Crows Landing Road Bridge	11.0
14	Crows Landing Road Bridge to Patterson Bridge	8.3
15	Patterson Bridge to Grayson Road Bridge	9.7
16	Grayson Road Bridge to Maze Road Bridge (Highway 132)	11.9
17	Maze Road Bridge (Highway 132) to Airport Way (Vernalis)	4.9
18	Airport Way (Vernalis) to Upstream of Banta-Carbona Intake Canal	8.8
19	Banta-Carbona Intake to Paradise Dam	3.7
20	Paradise Dam to Mossdale Bridge (Interstate 5)	3.7
A <sup>1</sup>	Bear Creek-Eastside Bypass (Inflow) to San Joaquin River	4.0 <sup>2</sup>
B <sup>1</sup>	Old Grayson Channel-Origin to San Joaquin River	4.5 <sup>2</sup>
C <sup>1</sup>	West Stanislaus Irrigation District-Pumps to San Joaquin River	<u>2.0<sup>2</sup></u>
	TOTAL RIVER MILES	148.7

<sup>1/</sup> Special side-channel surveys conducted because of significant influence on San Joaquin River hydrology

<sup>2/</sup> Not considered in the total river miles

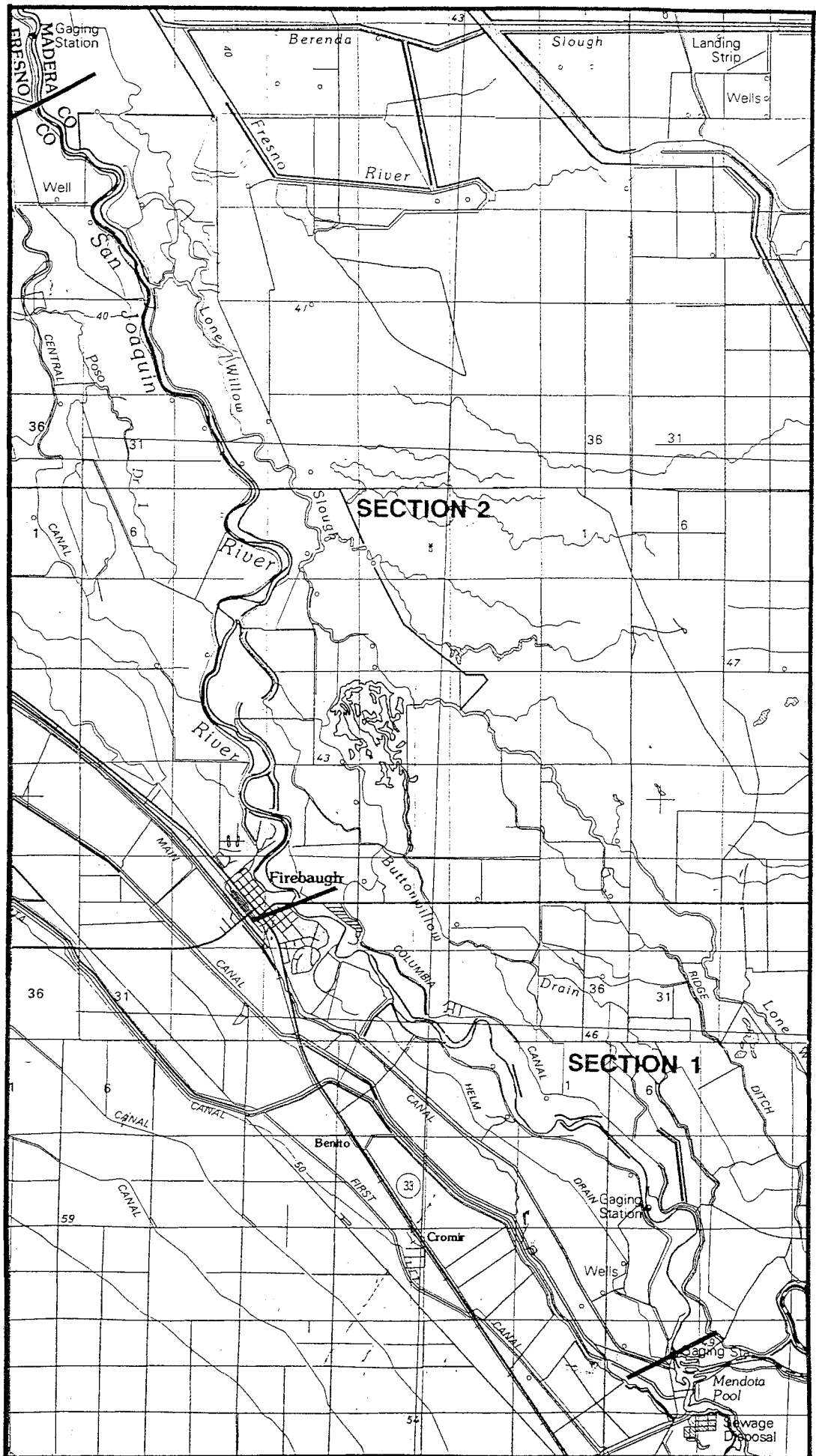

Figure 1. Location of River Sections 1 and 2 (Mendota Dam to Sack Dam) on the San Joaquin River Used to Describe Water

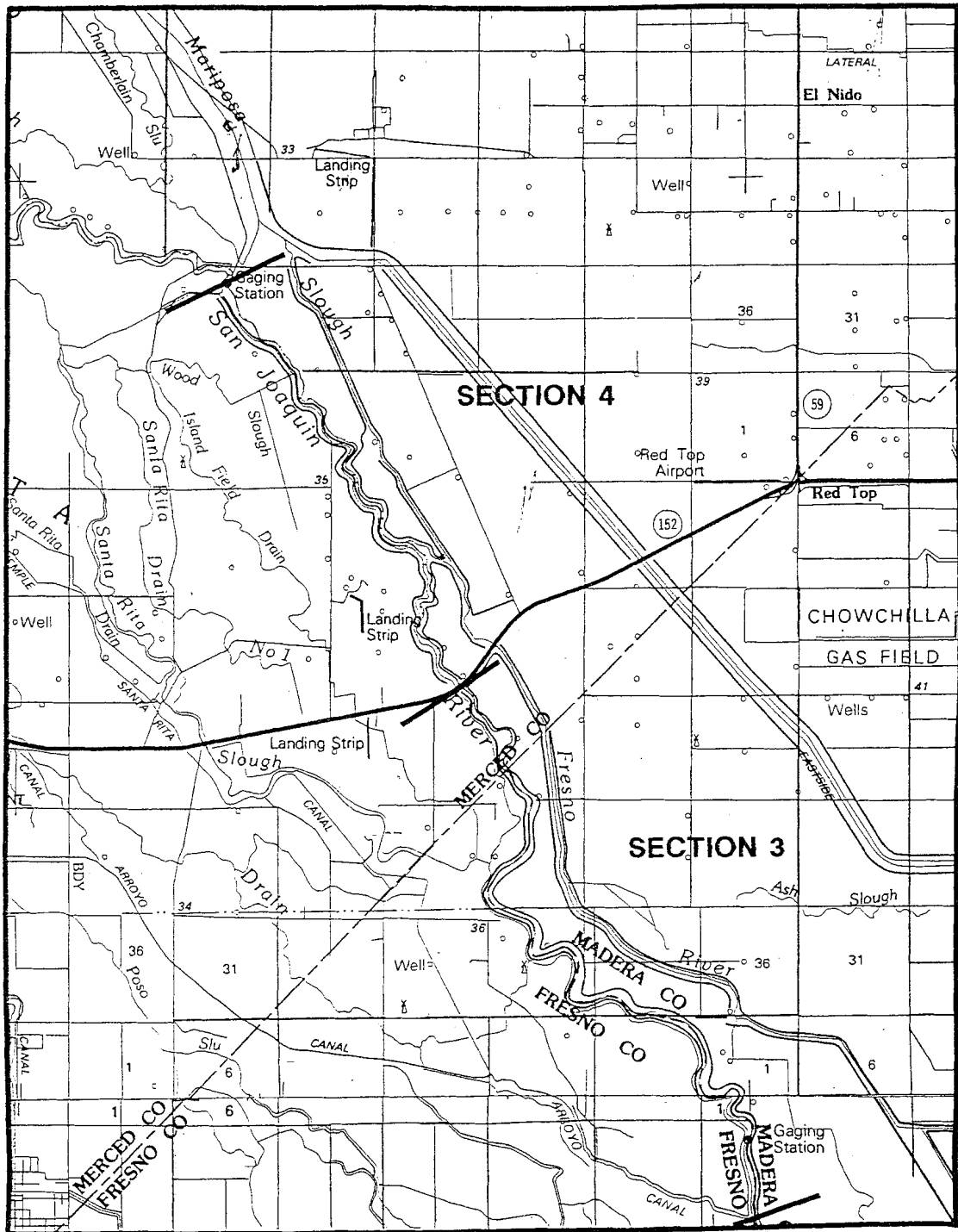

Figure 2. Location of River Sections 3 and 4 (Sack Dam to Mariposa Bypass (Intake)) on the San Joaquin River Used to Describe Water Diversions and Discharge Points.



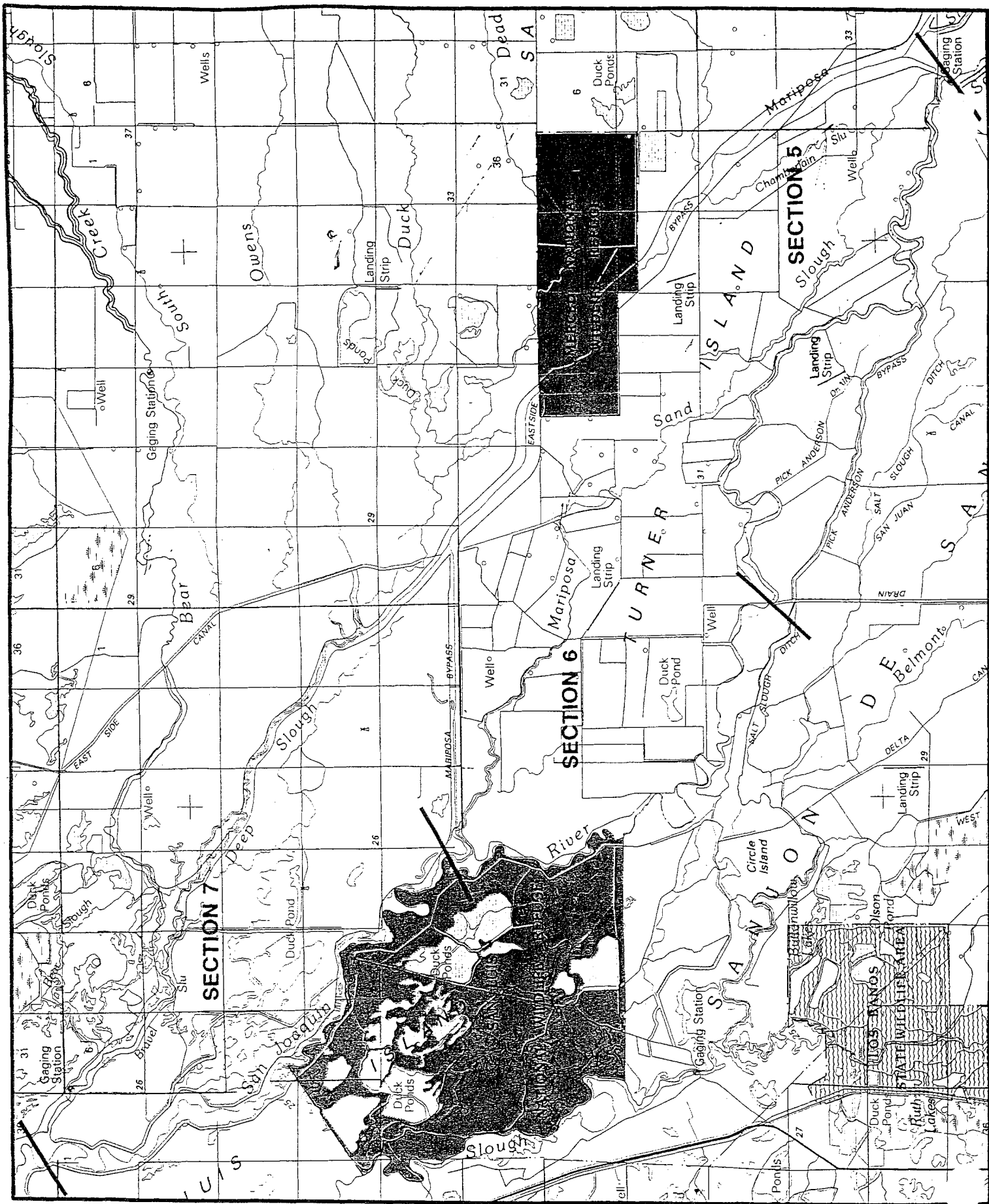

Figure 3. Location of River Sections 5, 6 and 7 (Mariposa Bypass (Intake) to Bear Creek Inflow) on the San Joaquin River Used to Describe Water Diversion and Discharge Points.

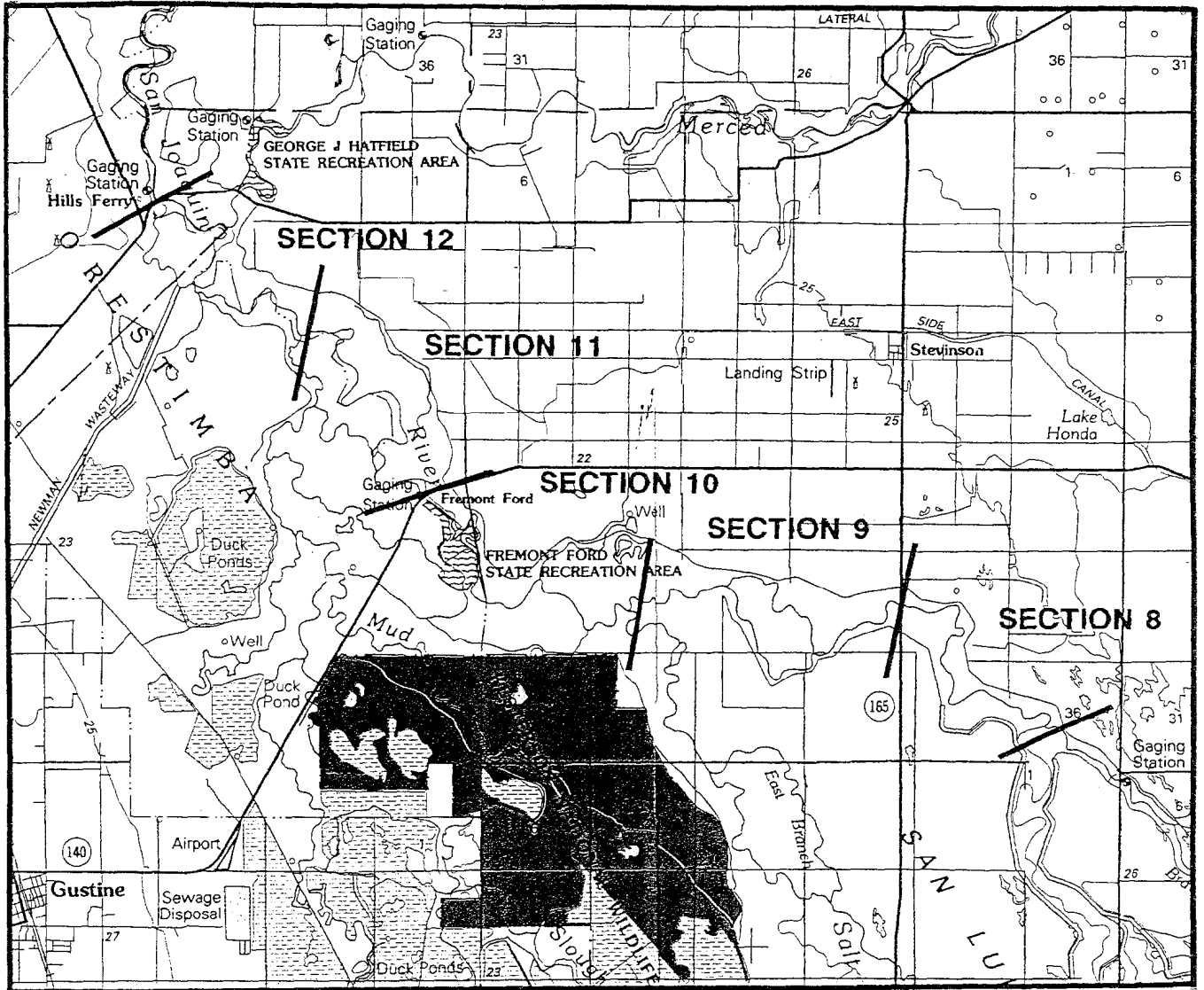

Figure 4. Location of River Sections 8, 9, 10, 11 and 12 (Bear Creek Inflow to Hills Ferry Road Bridge) on the San Joaquin River Used to Describe Water Diversion and Discharge Points.

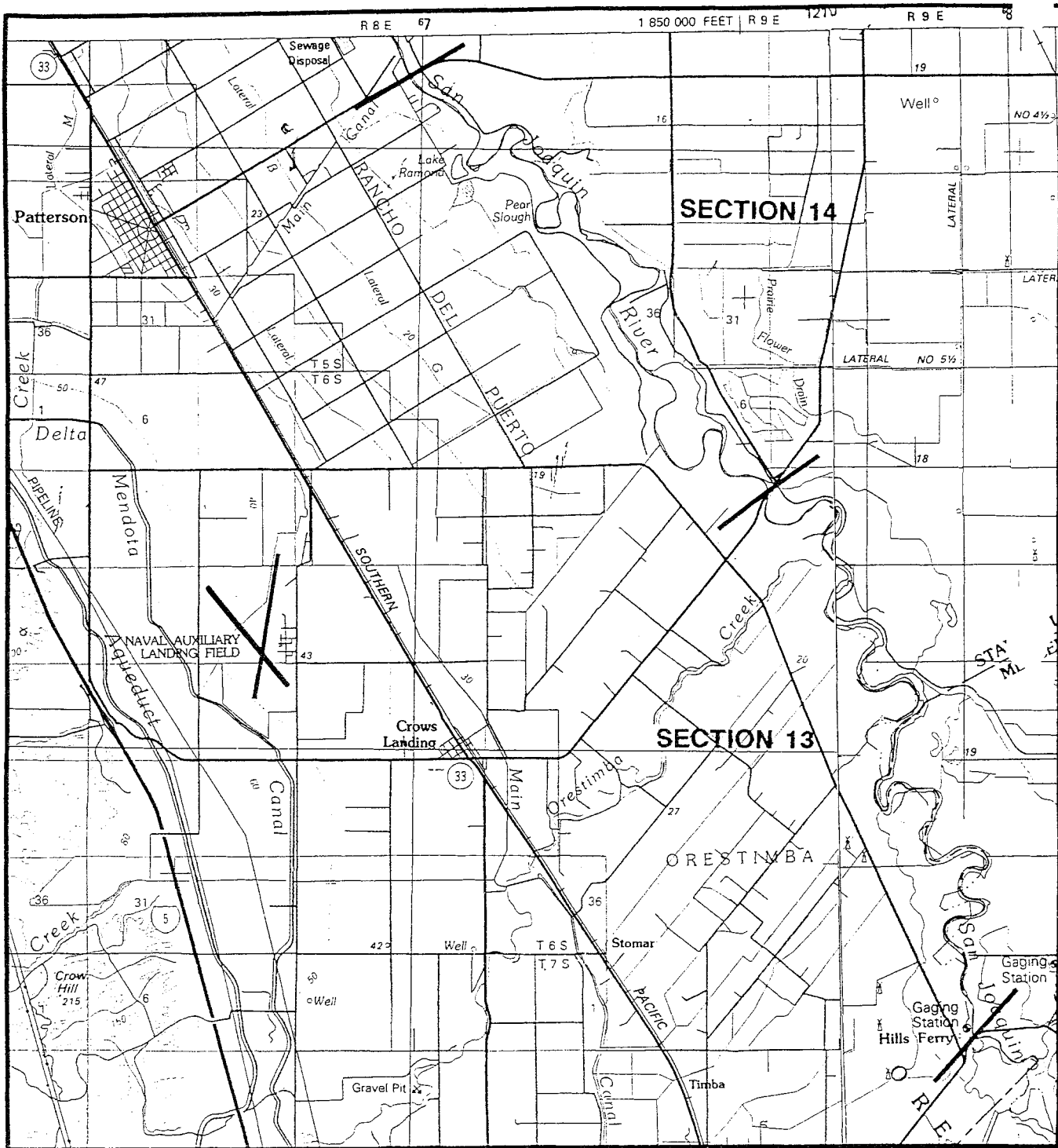

Figure 5. Location of River Sections 13 and 14 (Hills Ferry Road Bridge to Patterson Bridge) on the San Joaquin River Used to Describe Water Diversion and Discharge Points.

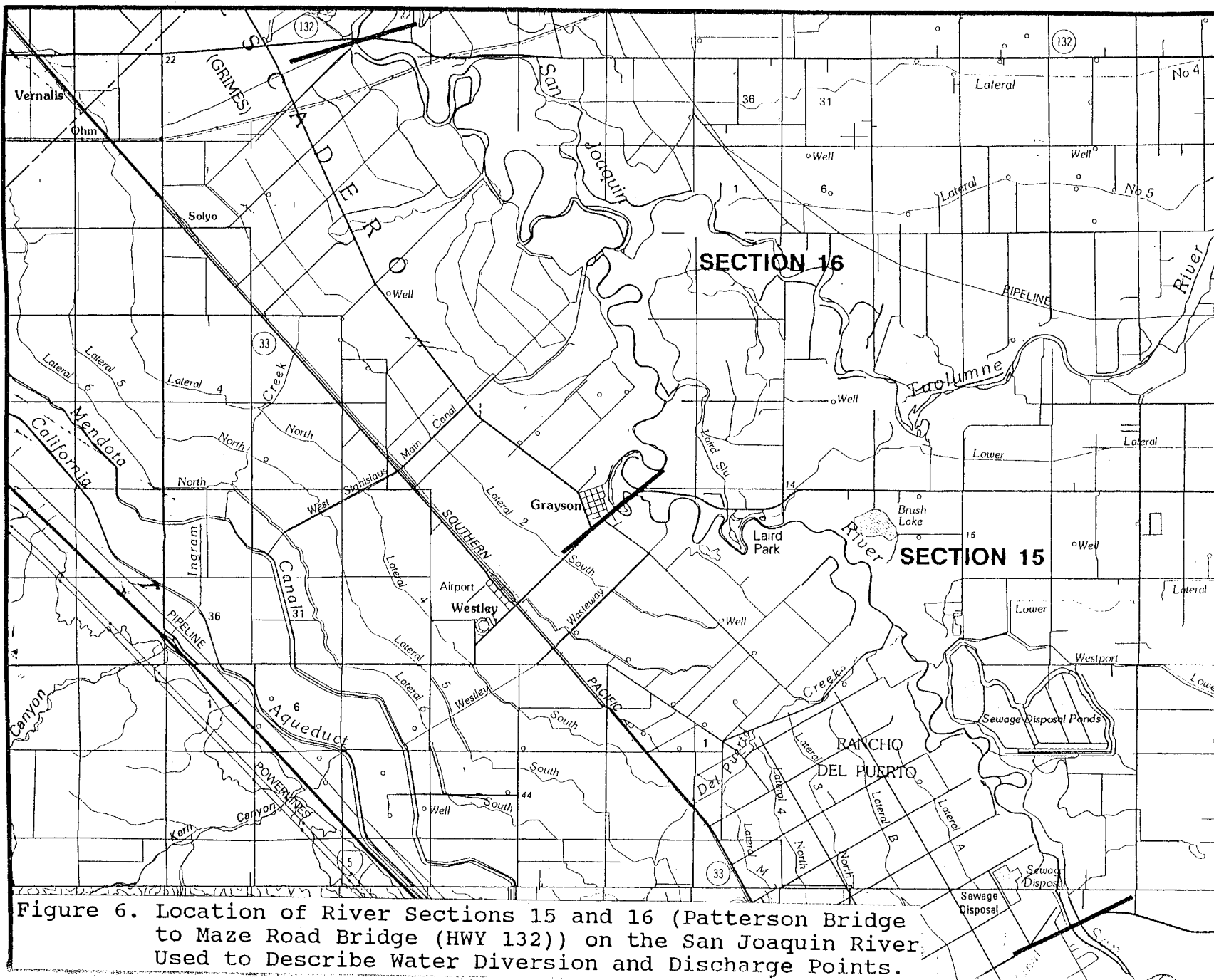

Figure 6. Location of River Sections 15 and 16 (Patterson Bridge to Maze Road Bridge (HWY 132)) on the San Joaquin River. Used to Describe Water Diversion and Discharge Points.

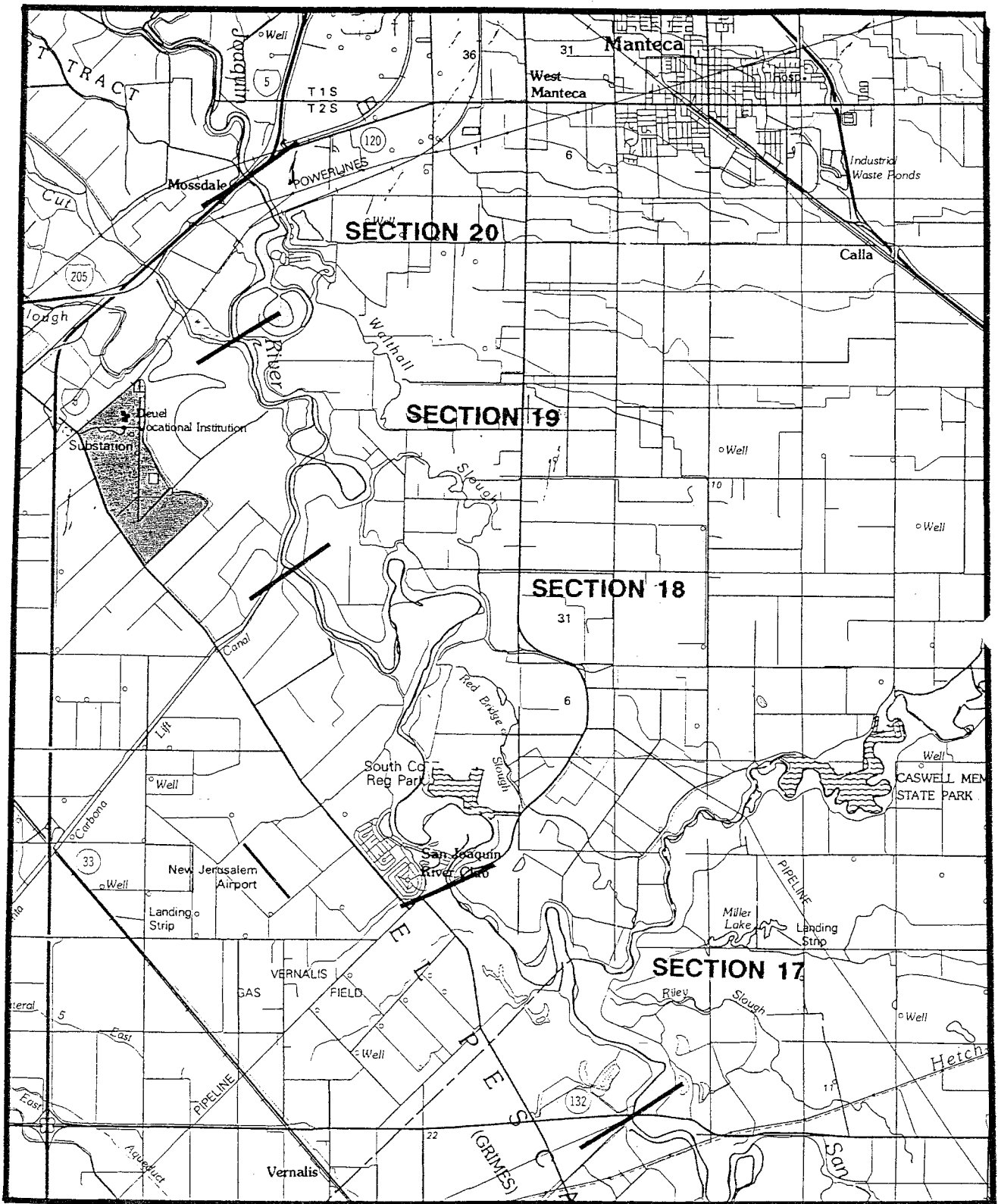

Figure 7. Location of River Sections 17, 18, 19 and 20 (Maze Road Bridge (HWY 132) to Mossdale Bridge (Interstate 5)) on the San Joaquin River Used to Describe Water Diversion and Discharge Points.

is presented in Appendices A and B. The information in the appendices is arranged by river segment for ease of access. The supporting information within each river segment identifies each site by a unique site number, locates the site along the San Joaquin River and provides a brief site description and where useful a site location map. The unique site number assigned to each site describes the site location. For example, site #SJW121.1D; the first two letters describe the site as being on the San Joaquin River (SJ) while the next letter describes whether the site is on the west (W) or east (E) side of the river. The four-digit numeric designation (121.1) describes the river miles as defined by the Corps of Engineers (1984). The final letter designation describes whether the site is a discharge (D) to the river or a diversion (P) from the river. A schematic diagram with site names and number has been compiled for each river section. Detailed information has been compiled on only selected sites. The emphasis has been on detailed information and location maps for sites downstream of Lander Avenue to Vernalis (River Sections 9-17). These are the sites most affected by the discharge of agricultural drainage water.

The 150-mile reach of the San Joaquin River surveyed in this study (Mendota Dam to Mossdale Bridge) has 193 discharge points. The greatest concentration of discharge points occurred from Section 13 (Hills Ferry Bridge) to Section 17 (Vernalis). In these sections 66 discharge points occurred in the 46 river miles, nearly twice the density found in any other river section. This is the section of the river immediately downstream of the subsurface tile drainage entering through Mud Slough (north) and Salt Slough (James et al., 1988a). The number of discharge points for each river section is summarized in Table 2.

The 150-mile reach of the San Joaquin River has 89 points of water diversion for beneficial use. The greatest density occurs in the lower reaches of the river. The density of diversion points increases downstream from the Hills Ferry Bridge (Section 13) as each east side tributary contributes flow to the river. The density per mile doubles in moving from Section 13 to Section 20. The number of diversion points within each river section is summarized in Table 2. Due to the importance of maintaining beneficial use of the water being diverted, a special use survey was conducted of the 48 water diversion points occurring in Sections 9-17. These 48 points supply all or a portion of the irrigation supply for over 60,000 irrigated acres which produce a variety of field, vegetable, orchard and pasture crops. All of the diversion points were putting the water to agricultural beneficial use with almost all using the water for irrigation. A detailed discussion of the results of this survey are given by section in Appendix B.

The discussion that follows will briefly describe the significant surface hydrological influences on the San Joaquin River within each of the river segments. Each segment description is supported by a flow diagram. Where appropriate, a discharge or diversion description is in Appendix A.

## River Sections

### River Section 1 - Mendota Dam to Avenue 7-1/2

This 9.6-mile section of the San Joaquin River is completely influenced by releases from the Mendota Pool for irrigation use downstream (Figure 8). The

Table 2 Hydrologic Influences Within Each San Joaquin River Section

<u>River Section<sup>1</sup></u>	<u>River Section Mileage<sup>2</sup></u>	<u>Diversion Points</u>	<u>Irrigated Acres</u>	<u>Discharge/ Inflow Sites</u>	<u>Flood Gates</u>
1	195.2-204.8	1	<sup>4/</sup>	3	0
2	182.0-195.2	1	<sup>4/5/</sup>	4	0
3	173.9-182.0	1	<sup>4/5/</sup>	0	0
4	168.5-173.9	3	<sup>5/</sup>	2	0
5	157.1-168.5	2	<sup>5/</sup>	1	0
6	147.3-157.1	2	<sup>5/</sup>	2	0
7	135.9-147.3	3	<sup>5/</sup>	14	20
8	132.9-135.9	0	--	4	11
9	129.5-132.9	1	500	0	19
10	125.2-129.5	0	--	4	4
11	121.1-125.2	1	300	0	9
12	118.1-121.1	0	--	5	8
13	107.1-118.1	11	1,850	14	0
14	98.8-107.1	8	7,900	9	0
15	89.1- 98.8	8	15,100	16	0
16	77.2- 89.1	13	33,100	22	0
17	72.3- 77.2	6	1,900	4	0
18	63.5- 72.3	12	<sup>5/</sup>	10	0
19	59.8- 63.5	8	18,600	6	0
20	56.1- 59.8	8	<sup>5/</sup>	2	0
A <sup>3/</sup>	--	2	<sup>5/</sup>	7	0
B <sup>3/</sup>	--	1	<sup>5/</sup>	9	0
C <sup>3/</sup>	--	<u>6</u>	<sup>5/</sup>	<u>1</u>	<u>0</u>
		98	79,250	139	71

<sup>1/</sup> As described in Table 1

<sup>2/</sup> Estimated from Corps of Engineers' Records (1984)

<sup>3/</sup> Special channel surveys were conducted on channels where water development significantly altered hydrology past the upstream stream flow gaging stations

<sup>4/</sup> Not estimated as not potentially affected by discharge of subsurface drainage water

<sup>5/</sup> A multiple use diversion making an estimate impossible

<sup>6/</sup> Not surveyed

SAN JOAQUIN RIVER  
Section 1: Mendota Dam to Avenue 7 1/2

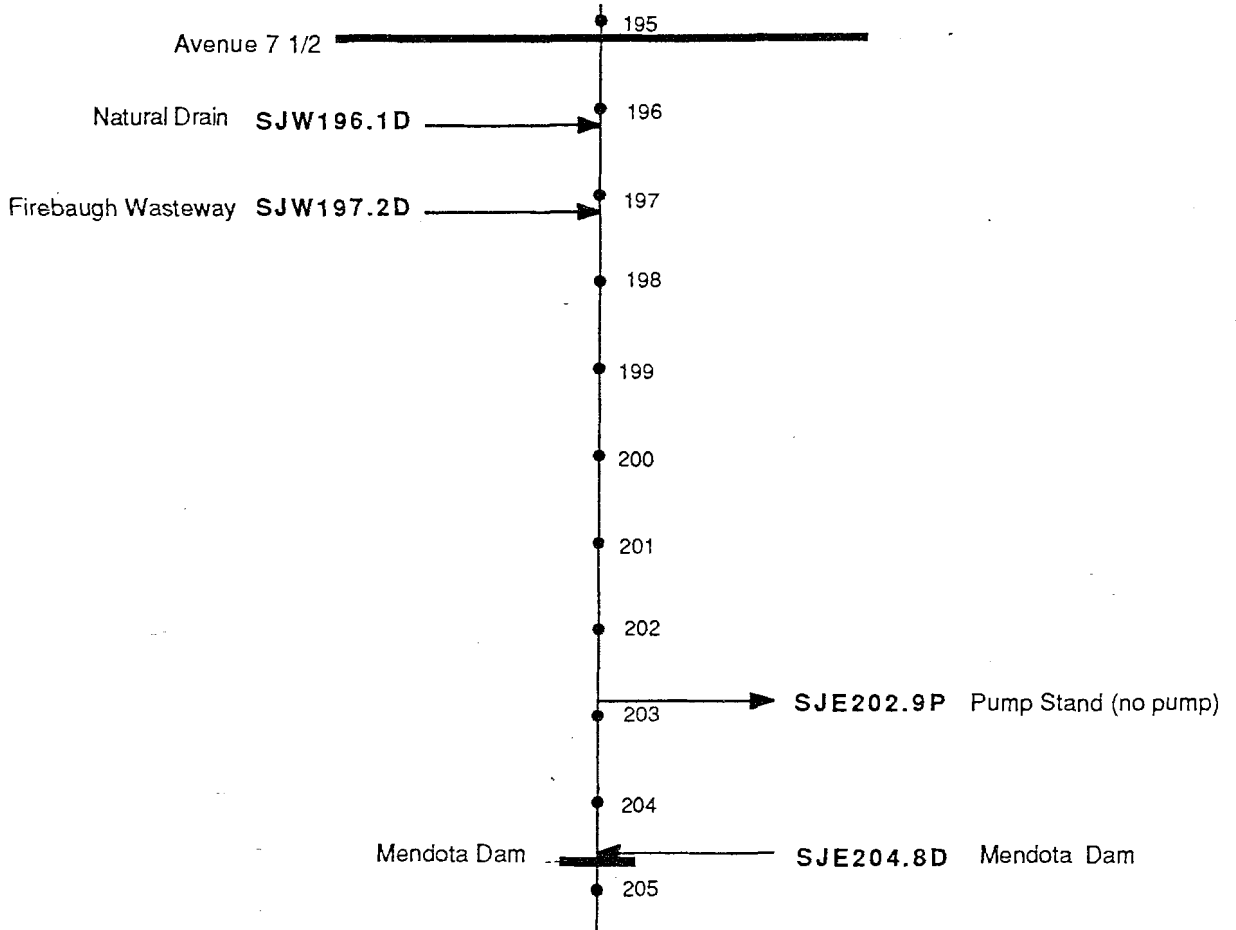

Figure 8. Schematic Diagram for Water Diversions and Discharges on the San Joaquin River from Mendota Dam to Avenue 7 1/2 (River Section 1).



Firebaugh Wasteway (SJW197.2D) also contributes significant inflows from operational spills from the Delta Mendota Canal and tail water from farming operations.

River Section 2 - Avenue 7-1/2 to Sack Dam

This 13.2 mile section of the San Joaquin River receives minor inflows from three surface drains leaving the Columbia Canal Company on the east side of the river (Figure 9). Almost all of the flow in this section of the river is diverted into the Arroyo Canal (SJW182.0P) for irrigation. The only flow going beyond the Sack Dam is seepage in the irrigation season and high flow occurring during floods in the winter period. During certain periods in the irrigation season water is diverted past the Sack Dam for further irrigation diversion downstream. - 2000

River Section 3 - Sack Dam to Santa Rita Bridge at Highway 152

This 8.1 mile section of the San Joaquin River has only one diversion into the Poso Canal (SJW180.8P) (Figure 10). Flow in this section is seepage or occasional releases at the Sack Dam for irrigation diversion into the Poso Canal or further downstream.

River Section 4 - Santa Rita Bridge (Highway 152) to Mariposa Bypass (Intake)

This 5.4 mile section of the San Joaquin River is characterized by low flows consisting mostly of seepage water (Figure 11). Operational spills from upstream irrigation operations often provide sufficient flows for the three diversion pumps within this reach. Although the Fresno River enters in this section, there is almost no flow reaching the San Joaquin River except during periods of flood flows.

River Section 5 - Mariposa Bypass (Intake) to Turner Island Road

This 11.4 mile section of the San Joaquin River has very low flow almost all of which consists of seepage water and operational spills from upstream (Figure 12). Almost all of this available water is utilized for diversion by the two pumping systems within this reach.

River Section 6 - Turner Island Road to Mariposa Bypass (outlet)

This 9.8 mile section of the San Joaquin River has two diversion points within river mile 156 and almost no flow goes beyond this point (Figure 13). Flow beyond this point is entirely seepage into the river. A major surface inflow occurs at the Mariposa Bypass. The majority of the water entering at this point is surface return flows from Turner Island Water District during the irrigation season or during the flood flow in the winter period.

SAN JOAQUIN RIVER  
Section 2: Avenue 7 1/2 to Sack Dam

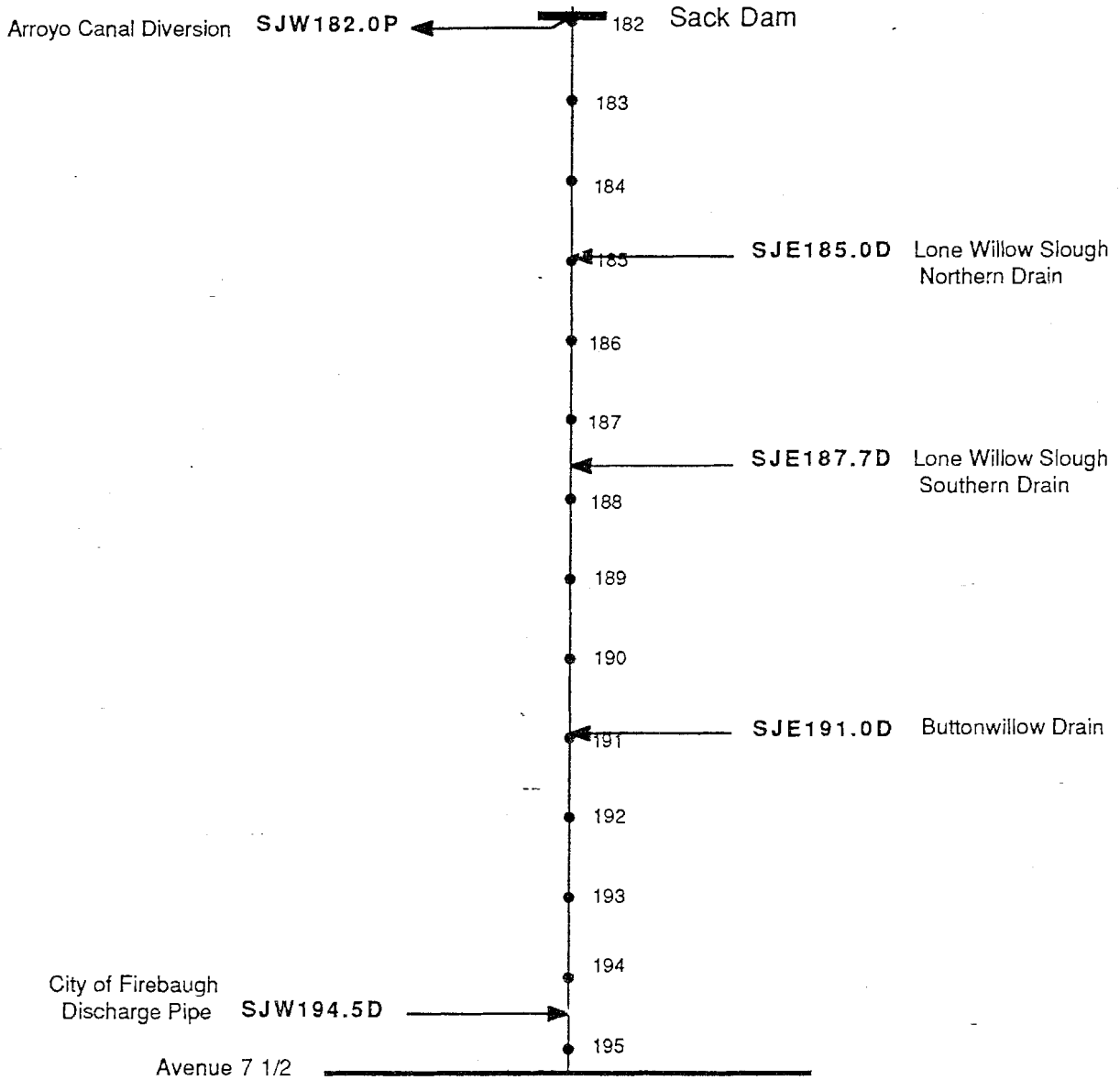

Figure 9. Schematic Diagram for Water Diversions and Discharges on the San Joaquin River from Avenue 7 1/2 to Sack Dam (River Section 2).

SAN JOAQUIN RIVER

Section 3: Sack Dam to Santa Rita Bridge (Hwy. 152)

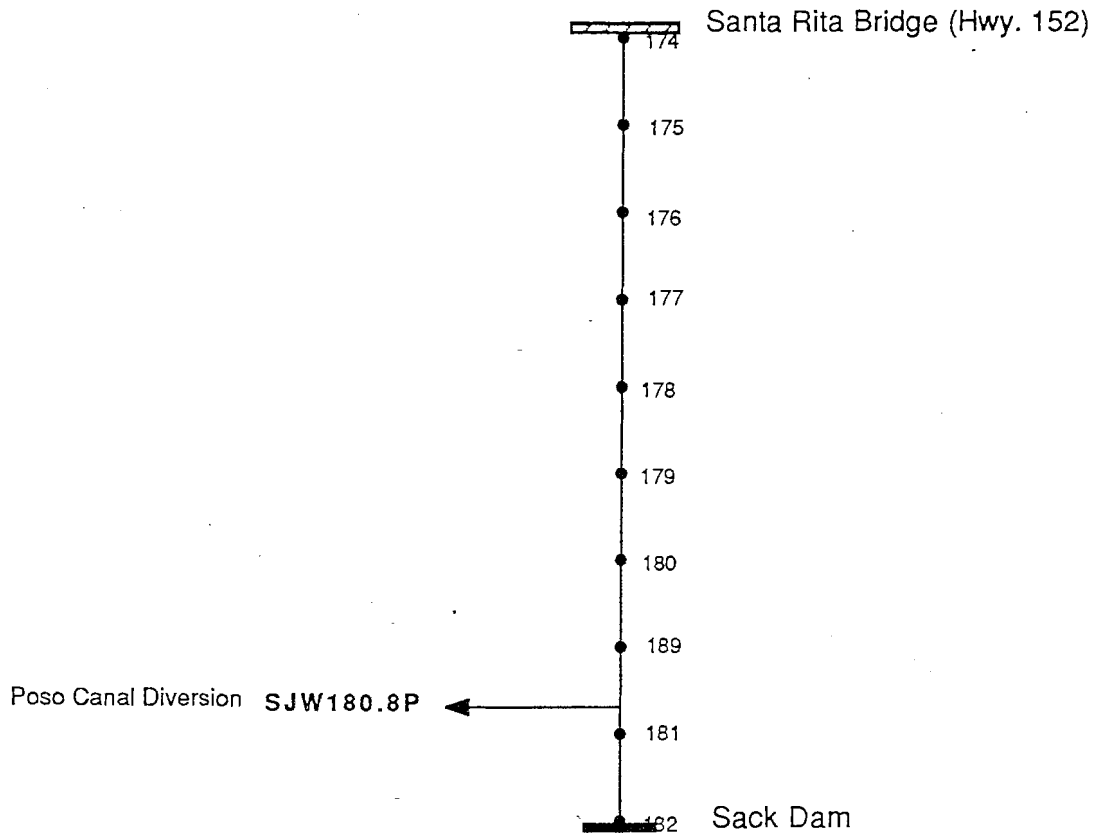

Figure 10. Schematic Diagram for Water Diversions and Discharges on the San Joaquin River from Sack Dam to Santa Rita Bridge - Hwy. 152 (River Section 3).

SAN JOAQUIN RIVER

Section 4: Santa Rita Bridge (Hwy. 152) to Mariposa Bypass (Intake)

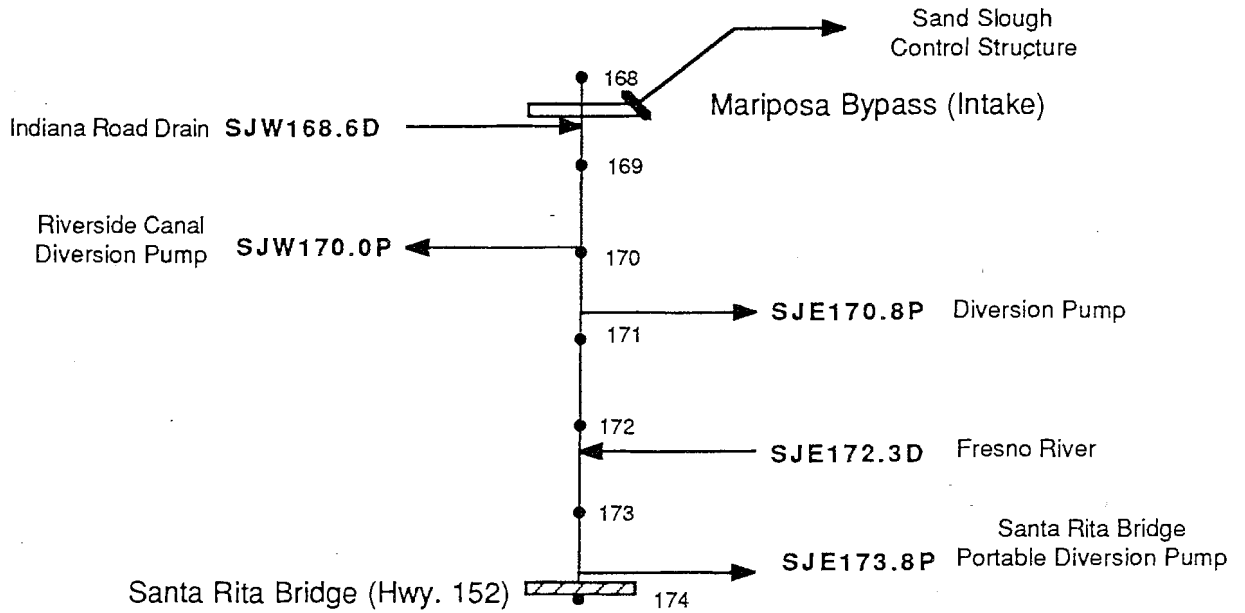

Figure 11. Schematic Diagram for Water Diversions and Discharges on the San Joaquin River from Santa Rita Bridge - Hwy. 152 to Mariposa Bypass (Intake) (River Section 4).

SAN JOAQUIN RIVER

Section 5: Mariposa Bypass (Intake) to Turner Island Road

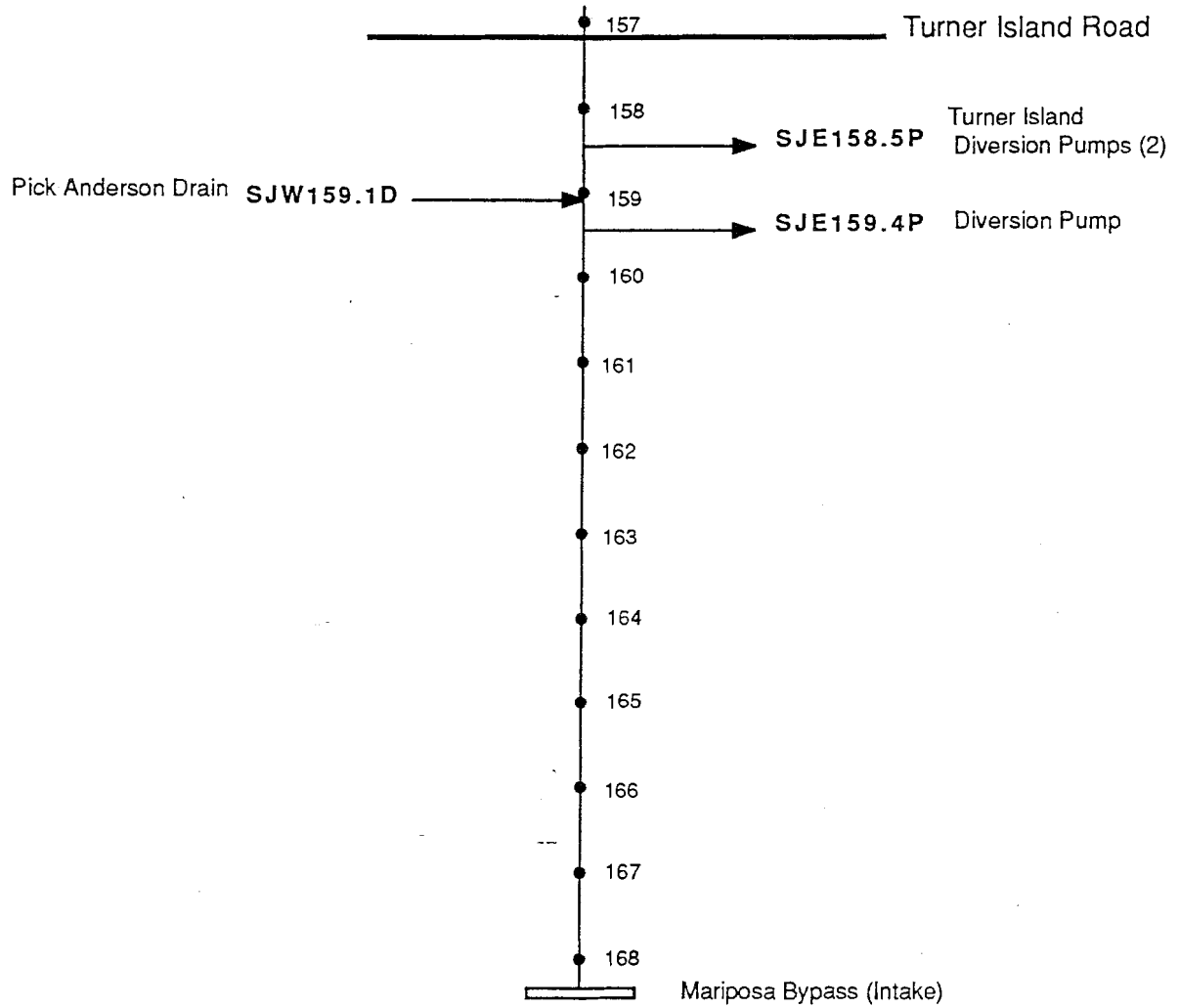

Figure 12. Schematic Diagram for Water Diversions and Discharges on the San Joaquin River from Mariposa Bypass (Intake) to Turner Island Road (River Section 5).

SAN JOAQUIN RIVER

Section 6: Turner Island Road to Mariposa Bypass (Outlet)

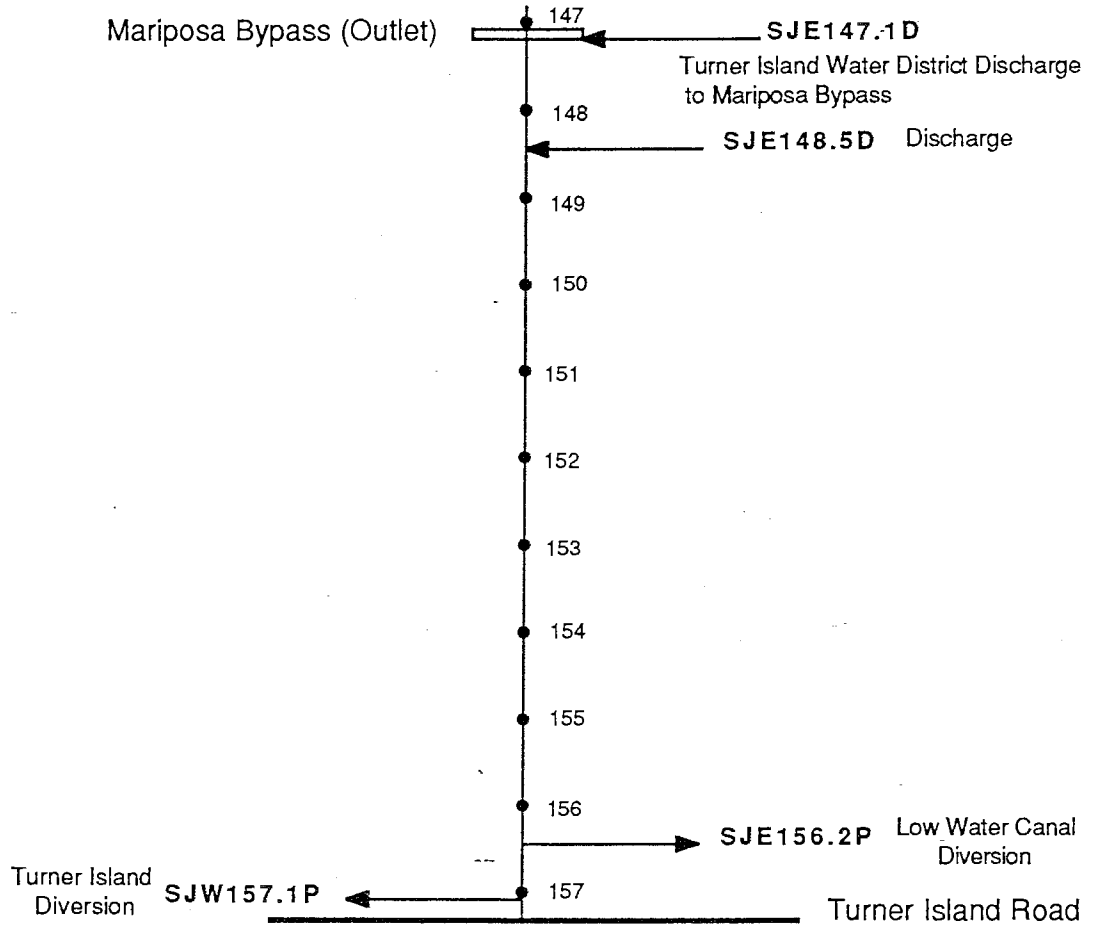

Figure 13. Schematic Diagram for Water Diversions and Discharges on the San Joaquin River from Turner Island Road to Mariposa Bypass (Outlet)(River Section 6).

#### River Section 7 - Mariposa Bypass (outlet) to Bear Creek

This 11.4 mile section of the San Joaquin River has 14 area drains which periodically carry irrigation surface return flows from limited acreage immediately adjacent to the river (Figure 14). The actual flow in these drains is limited to short duration and does not appear to influence the river hydrology. In addition to the area drains, there are 20 flood gates within the river section which can carry either irrigation return flows or flood waters. There are three intake pumps within this reach but the source of water is either seepage to the river or return flow that entered via the Mariposa Bypass. Flows in this river section are very low.

#### River Section 8 - Bear Creek to Lander Avenue Bridge (Highway 165)

This 3 mile section of the San Joaquin River has no diversions and three insignificant and one significant discharge points (Figure 15). In addition there are 11 flood gates within this river section which can carry either irrigation return flows or flood waters. The main inflow comes from Bear Creek. Flow from Bear Creek often exceeds the natural flow in the San Joaquin River upstream of the inflow point. The Bear Creek flow originates from irrigation return flows in Bear Creek and flows entering Bear Creek from the Eastside Bypass which joins Bear Creek only four miles upstream of the Bear Creek confluence with the San Joaquin River. The Lander Avenue Bridge site is often used as the reference site for background water quality in the San Joaquin River prior to significant inflows of subsurface tile drainage entering the river. A special survey of the Bear Creek area was conducted and is reported later under special channel surveys.

#### River Section 9 - Lander Avenue Bridge (Highway 165) to upstream of Salt Slough

This 3.4 mile section of the San Joaquin River has only one diversion point for 500 acres of cropping within the Stevinson Water District (Figure 16). In addition, there are 19 flood gates within this section which can carry either irrigation return flows or flood waters. Flow in this reach of the river is low and influenced by upstream flows and inflow from Salt Slough (in river section 10). During periods of low natural river flow and high discharge rates from Salt Slough, backwater or upstream flow of Salt Slough flow is not uncommon.

#### River Section 10 - Salt Slough to Fremont Ford Bridge (Highway 140)

This 4.3 mile section of the San Joaquin River has no diversions (Figure 17). There are three operational spills from the Stevinson Water District on the east side of the river as well as four flood gates on the east side of the river which can carry either irrigation return flows or flood water. The most significant inflow in this reach is Salt Slough (SJW129.5D) which makes up a major percentage of the river flow at the Fremont Ford Bridge. Flows in Salt Slough can make up greater than 75 percent of the river flow at the Bridge during the irrigation season.

# SAN JOAQUIN RIVER

## Section 7: Mariposa Bypass (Outlet) to Bear Creek Inflow

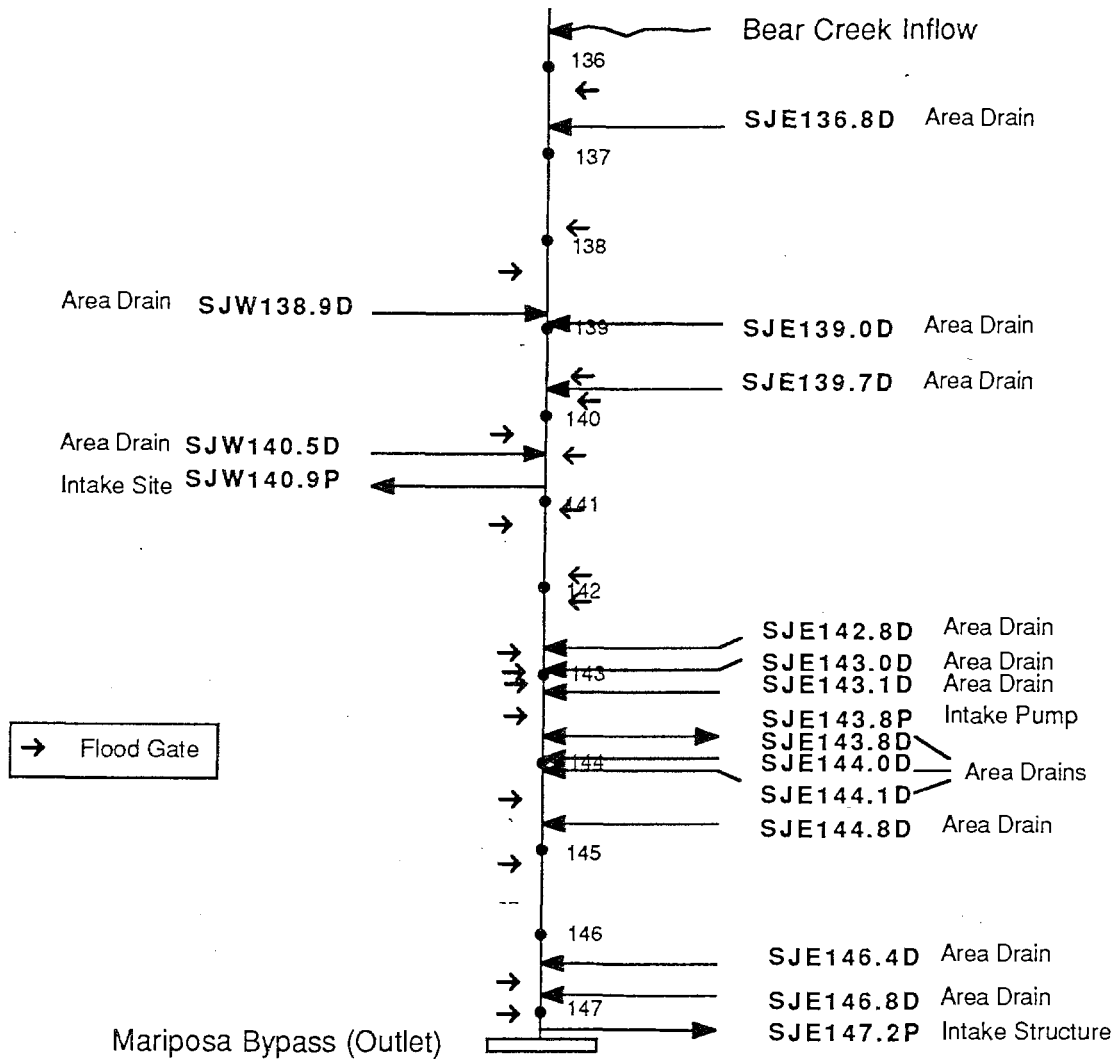

Figure 14. Schematic Diagram for Water Diversions and Discharges on the San Joaquin River from Mariposa Bypass (Outlet) to Bear Creek Inflow (River Section 7).



SAN JOAQUIN RIVER

Section 8: Bear Creek Inflow to Lander Avenue Bridge (Hwy. 165)

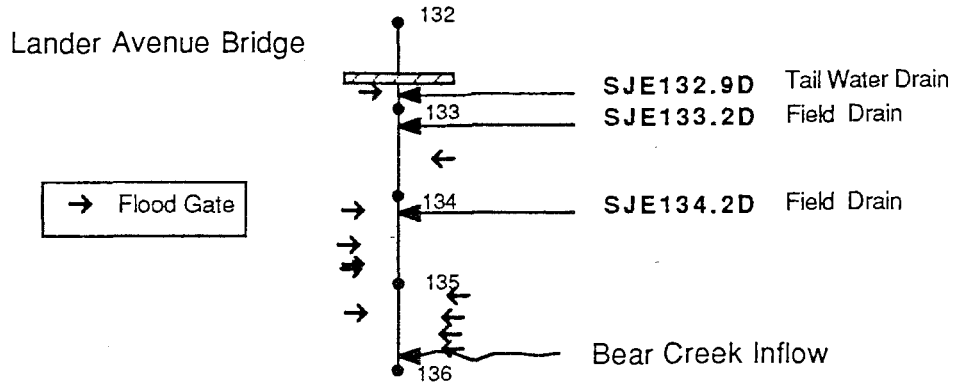

Figure 15. Schematic Diagram for Water Diversions and Discharges on the San Joaquin River from Bear Creek Inflow to Lander Avenue Bridge (Hwy.165) (River Section 8).

SAN JOAQUIN RIVER

Section 9: Lander Avenue Bridge (Hwy. 165) to Upstream of Salt Slough

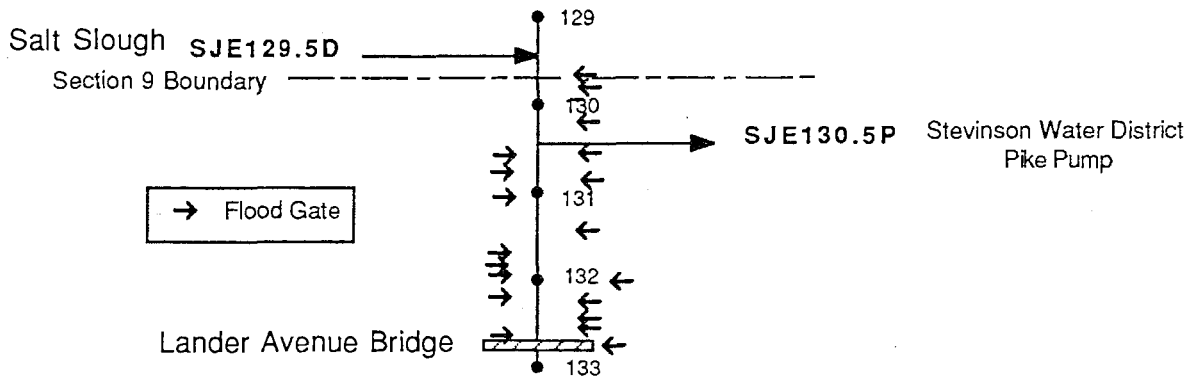

Figure 16. Schematic Diagram for Water Diversions and Discharges on the San Joaquin River from Lander Avenue Bridge (Hwy.165) to Upstream of Salt Slough (River Section 9).

SAN JOAQUIN RIVER

Section 10: Salt Slough Inflow to Fremont Ford Bridge (Hwy. 140)

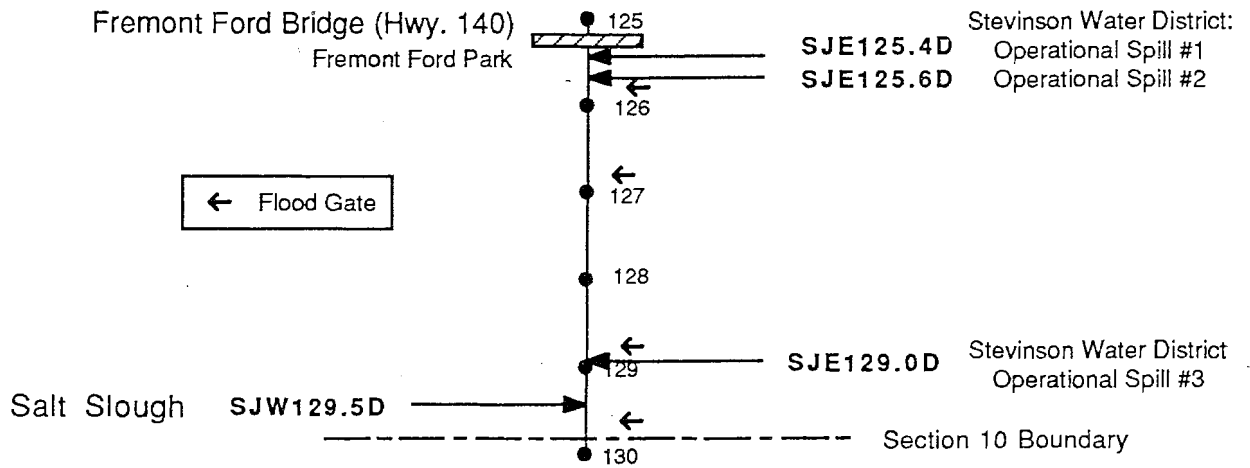

Figure 17. Schematic Diagram for Water Diversions and Discharges on the San Joaquin River from Salt Slough Inflow to Fremont Ford Bridge (Hwy.140) (River Section 10).

River Section 11 - Fremont Ford Bridge (Highway 140) to above Mud Slough (north)

This 4.1 mile section of the San Joaquin River has only one diversion which is used to supply 300 acres of cropland (Figure 18). In addition, there are nine flood gates on the east side of the river which can carry either irrigation return flows or flood waters. Flow in this section is mostly unchanged from those recorded at the Fremont Ford Bridge.

River Section 12 - Mud Slough (north) to Hills Ferry Road Bridge

This 3 mile section of the San Joaquin River is hydrologically influenced by three major inputs and has no diversion points (Figure 19). In addition, there are eight flood gates on the east side of the river which carry either irrigation return flows or flood waters. Each of the three major inflows vary considerably in flow but each has a significant influence. The inflows are Mud Slough (north) (SJW121.1D), Newman Wasteway (SJW119.5D) and the Merced River (SJE118.2D). Mud Slough (north) carries predominately irrigation return flows and return flows from waterfowl management areas. The Newman Wasteway carries operational spill water from the Delta-Mendota Canal and surface return flows from irrigated agriculture. Another significant inflow is the Newman Slough which enters from the west at river mile 119.0. This slough carries flow from an 800-acre tile drainage system as well as surface runoff from 4,500 acres of irrigated land. In addition, the City of Newman wastewater treatment plant occasionally discharges to this slough. The Merced River is the first of three major east side tributaries that enter the San Joaquin River upstream of Vernalis (river mile 72.3).

River Section 13 - Hills Ferry Road Bridge to Crows Landing Road Bridge

This 11 mile section of the San Joaquin River is highly developed (Figure 20). This section has 14 discharge sites and 11 diversions. Eight of the diversion sites are on the east side of the river and serve 1,250 acres of cropland. The remaining 3 pumps on the west side serve 590 acres although one of the pumps has recently (1981) been discontinued. Only three of the discharge sites are on the east side. The nine discharge sites on the west side of the river drain approximately 16,000 acres. The most significant discharge in this reach is Orestimba Creek which receives both operational spill water from the Central California Irrigation District Main Canal and return flows from irrigated land. The other significant discharge is the Newman Drainage District (SJW117.5D) which discharges surface tile drainage water from 2,450 acres of irrigated land.

River Section 14 - Crows Landing Bridge to Patterson Bridge

This 8.3 mile section of the San Joaquin River is highly developed with eight diversions and nine discharge sites (Figure 21). Of the eight diversion pumps, two are quite large and have a significant influence on river hydrology. The Twin Oaks Irrigation Company Pumps (SJW104.OP) serve 6,200 acres of irrigated land on the west side of the river while on the east side, the Hailwood Ranch Southern Pump (SJE100.8P) serves approximately 520 acres. The remaining six pumps serve approximately 1,150 acres on both sides of the river. The five discharge sites on the west side of the river drain approximately 14,300 irrigated acres with the majority occurring in the Ramona Lake (SJW100.0D) and

SAN JOAQUIN RIVER

Section 11: Fremont Ford Bridge (Hwy. 140) to Upstream of Mud Slough (North)

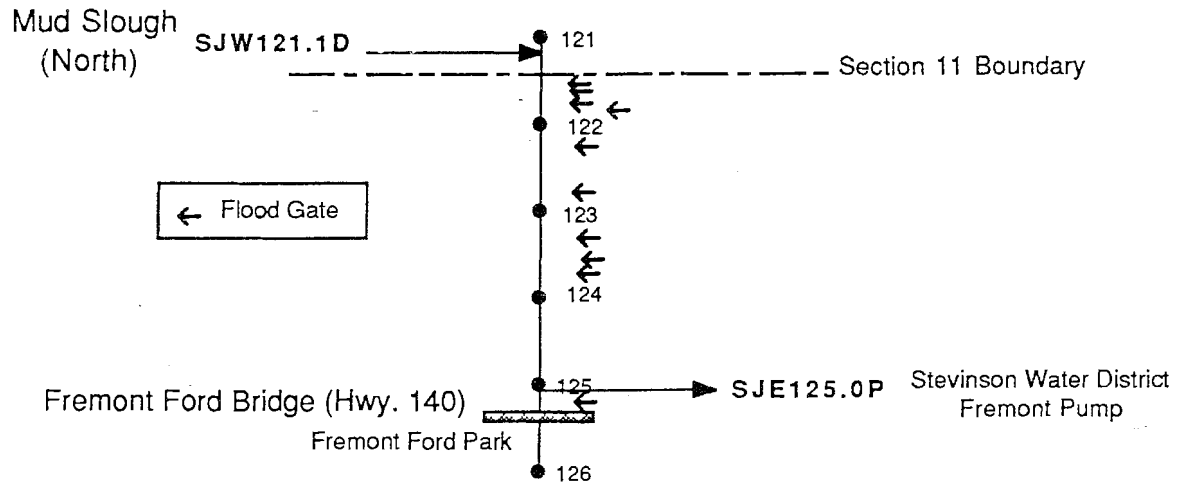

Figure 18. Schematic Diagram for Water Diversions and Discharges on the San Joaquin River from Fremont Ford Bridge (Hwy.140) to Upstream of Mud Slough (North) (River Section 11).

SAN JOAQUIN RIVER

Section 12: Mud Slough (North) to Hills Ferry Road Bridge

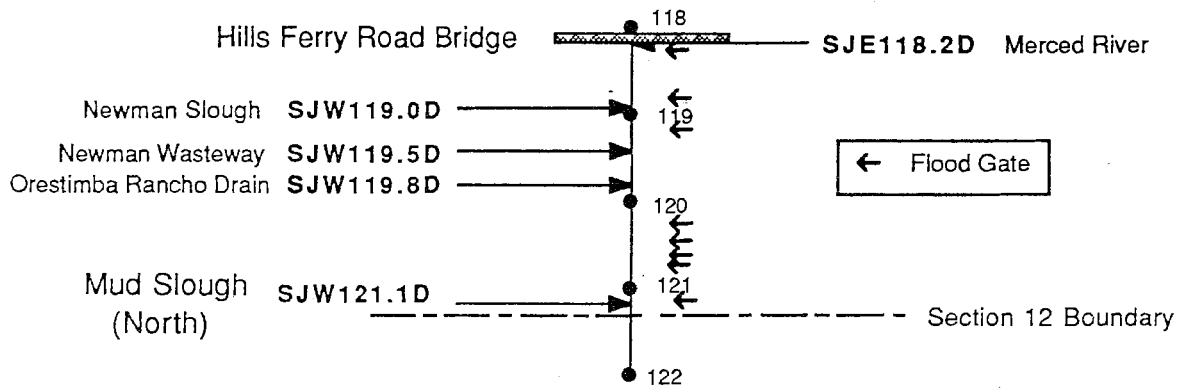

Figure 19. Schematic Diagram for Water Diversions and Discharges on the San Joaquin River from Mud Slough (North) to Hills Ferry Road Bridge (River Section 12).

# SAN JOAQUIN RIVER

## Section 13: Hills Ferry Road Bridge to Crows Landing Road Bridge

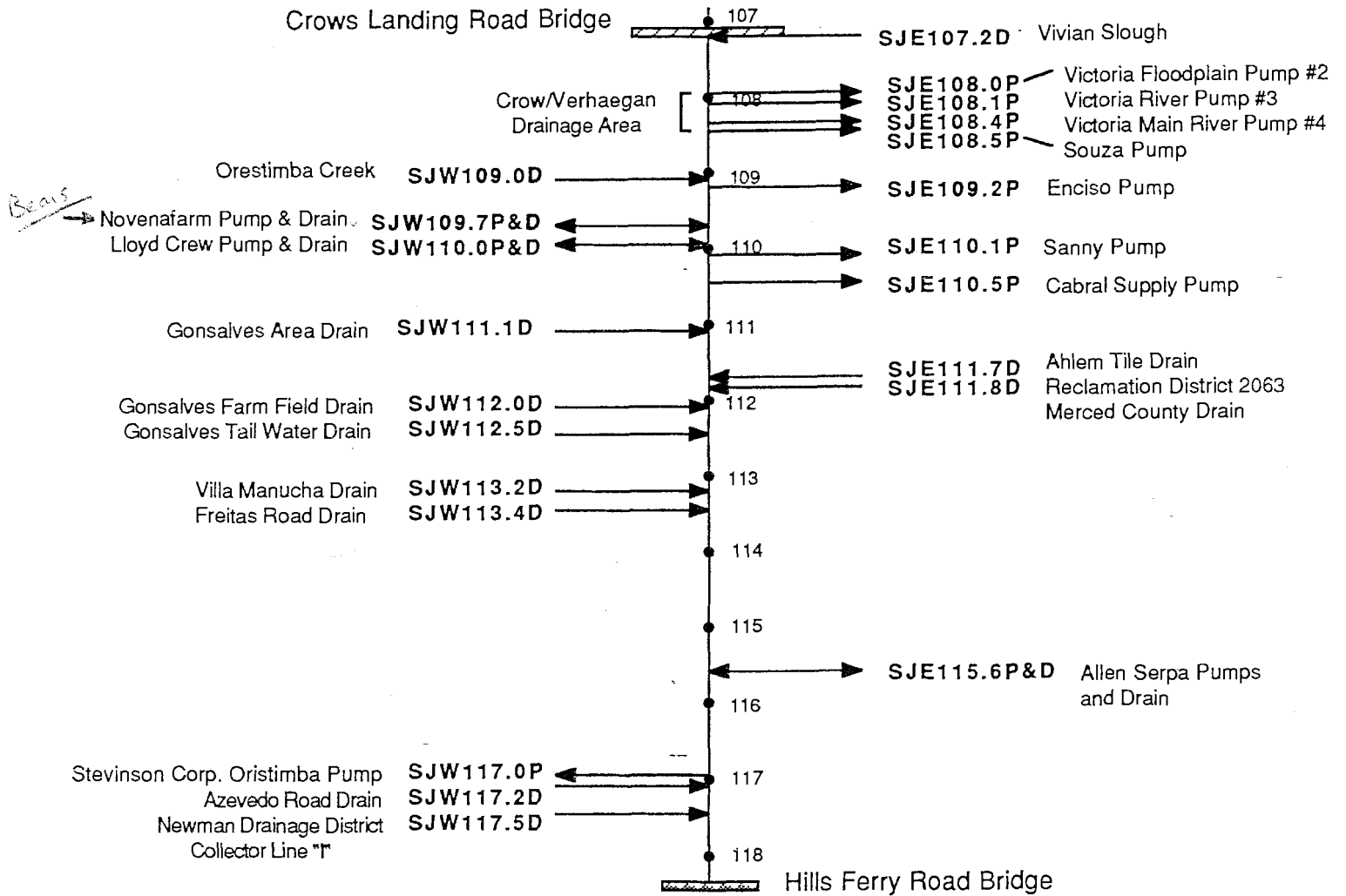

Figure 20. Schematic Diagram for Water Diversions and Discharges on the San Joaquin River from Hills Ferry Road Bridge to Crows Landing Road Bridge (River Section 13).

# SAN JOAQUIN RIVER

## Section 14: Crows Landing Road Bridge to Patterson Bridge

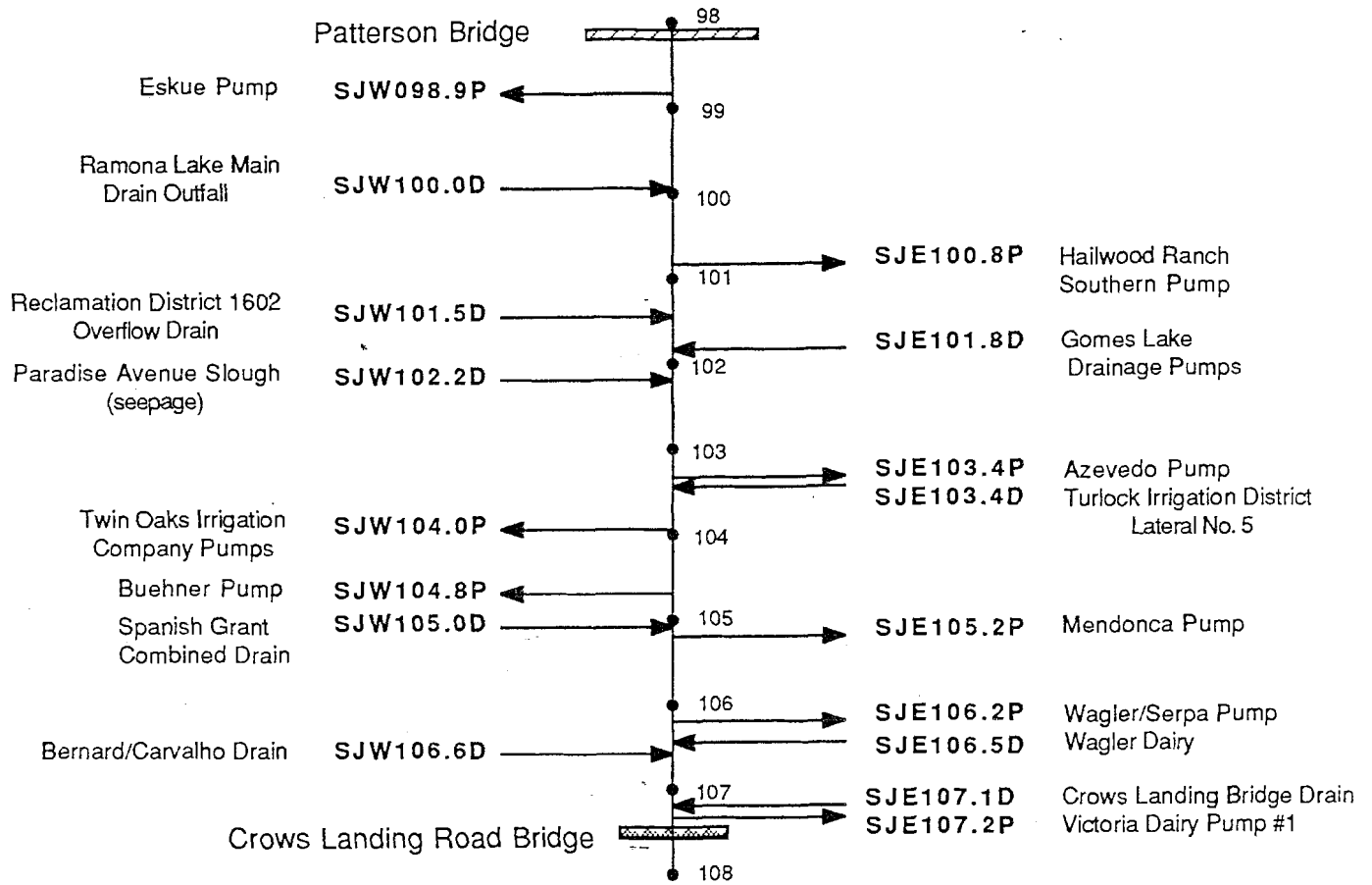

Figure 21. Schematic Diagram for Water Diversions and Discharges on the San Joaquin River from Crows Landing Road Bridge to Patterson Bridge (River Section 14).

Spanish Grant (SJW105.0D) Drain service areas. The largest discharge from the eastside occurs from the Turlock Irrigation District Lateral No. 5 (SJE103.4D). This lateral discharges predominantly operational spill water.

#### River Section 15 - Patterson Bridge to Grayson Road Bridge

This 9.7 mile section of the San Joaquin River is highly developed with eight diversion sites and 16 discharge sites (Figure 22). Of the eight diversion sites, one is dominant in influencing river hydrology. The Patterson Water District Main Lift Pumps (SJW098.5P) supply all or portions of water to their 14,000 acre service area. The remaining seven diversion pumps supply water to approximately 1,100 acres of irrigated land on both the east and west sides of the river. The 13 discharge sites on the west side of the river drain an area of approximately 18,200 acres. The actual drainage area may be larger as this only considers land on the east side of the Delta-Mendota Canal. There are three dominant west side discharges; the Olive Avenue Drain (SJW097.5D), Del Puerto Creek (SJW093.0D) and the Houk Ranch Drain (SJW091.5D). All three carry predominantly surface return flows from irrigated land but can also carry some tile drainage or seepage water. One of the most dominant discharges in this river section is the Modesto Wastewater Treatment Plant (SJE095.3D) which enters the river from the east side. Long term plans however are to cease this discharge and reuse the water for crop production.

#### River Section 16 - Grayson Road Bridge to Maze Road Bridge (Highway 132)

This 11.9 mile section of the San Joaquin River is the most highly developed and subject to the greatest changes in river hydrology due to irrigation development (Figure 23). This section has 13 diversions and 22 discharge points. Of the 13 diversions, four are dominant, three on the west and one on the east side of the river. The main diversion on the eastern side is the three pumps at the Bogetti Farms Pump Site No. 2 (SJE086.2P) which serve approximately 1,100 acres of cropland. The Blewett Mutual Water-Company (SJW077.3P) serves a similar size area on the west side of the river. The other two dominant west side diversions, the West Stanislaus Irrigation District Main Canal (SJW084.0P) and the El Solyo Water District Pumping Station (SJW077.5P) supply water to 28,500 acres. The largest of these is West Stanislaus Irrigation District serving all or portions of water to 24,800 acres.

This section of the San Joaquin River has 15 discharge sites from the west side of the river which drain approximately 28,500 acres of irrigated land that lies to the east of the Delta Mendota Canal. The major drains on the west bank are the Blewett Drain (SJW077.4D), Ingram-Hospital Creek Combined Outfall (SJW079.9D) and the Old Grayson Channel (SJW087.0D). The Blewett Drain and the Ingram-Hospital Creek Combined Outfall drain the majority of the land on the north side of the east-west trending West Stanislaus Irrigation District Main Canal (SJW084.0P). Old Grayson Channel receives drainage from the majority of the area on the south side of this main canal. The most dominant discharge is the Ingram-Hospital Creek Combined Outfall. It receives both surface and subsurface flows from approximately 13,195 acres including 2,300 acres of tile drain flows. Flow originates in both the Ingram and Hospital Creeks in addition to receiving flows from the White Lake Mutual-Hagemann Ranch Main Drain and the Hagemann Ranch Southern Drain Pump.



# SAN JOAQUIN RIVER

## Section 15: Patterson Bridge to Grayson Road Bridge

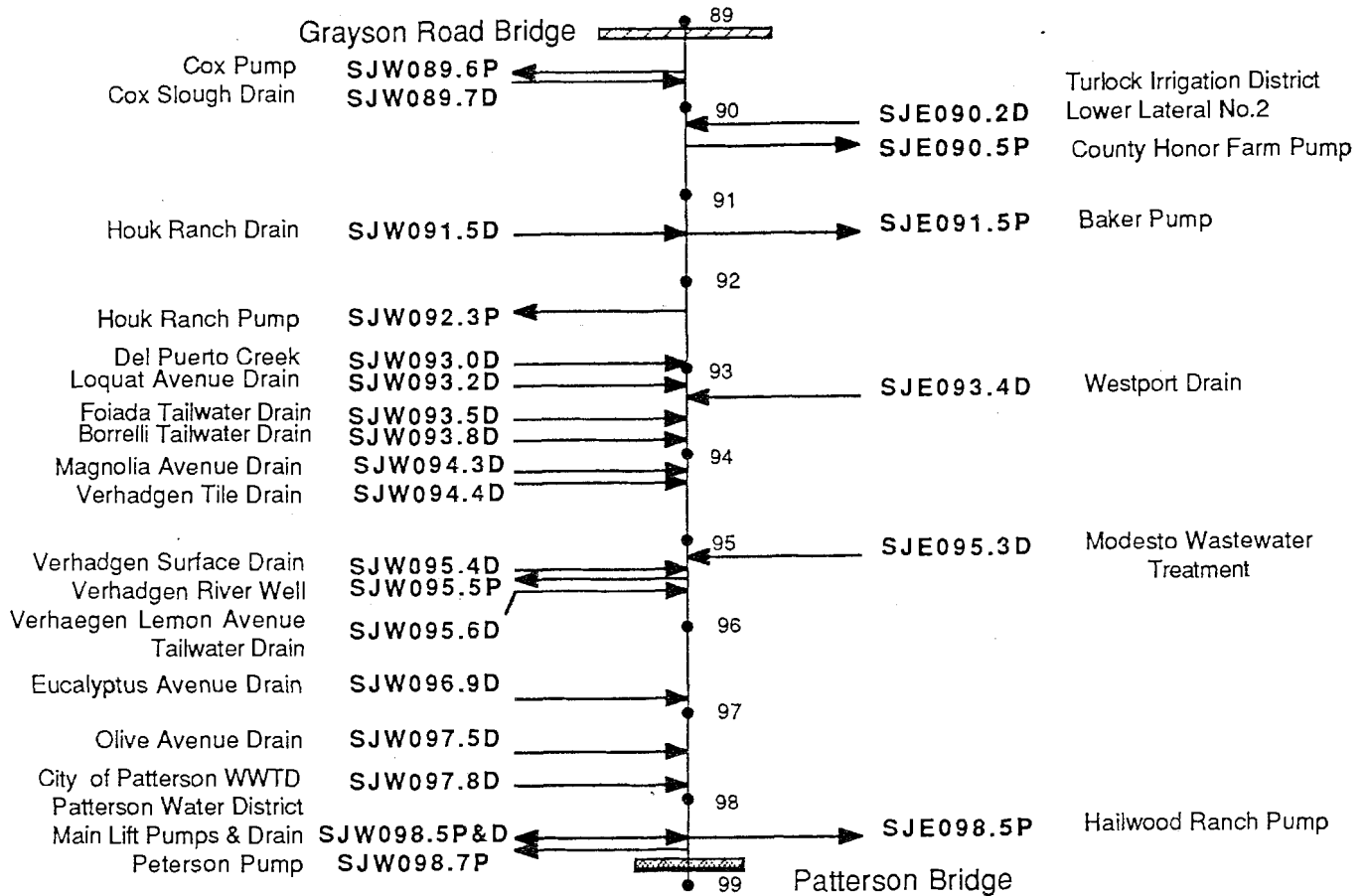

Figure 22. Schematic Diagram for Water Diversions and Discharges on the San Joaquin River from Patterson Bridge to Grayson Road Bridge (River Section 15).

SAN JOAQUIN RIVER

Section 16: Grayson Road Bridge to Maze Road Bridge (Hwy.132)

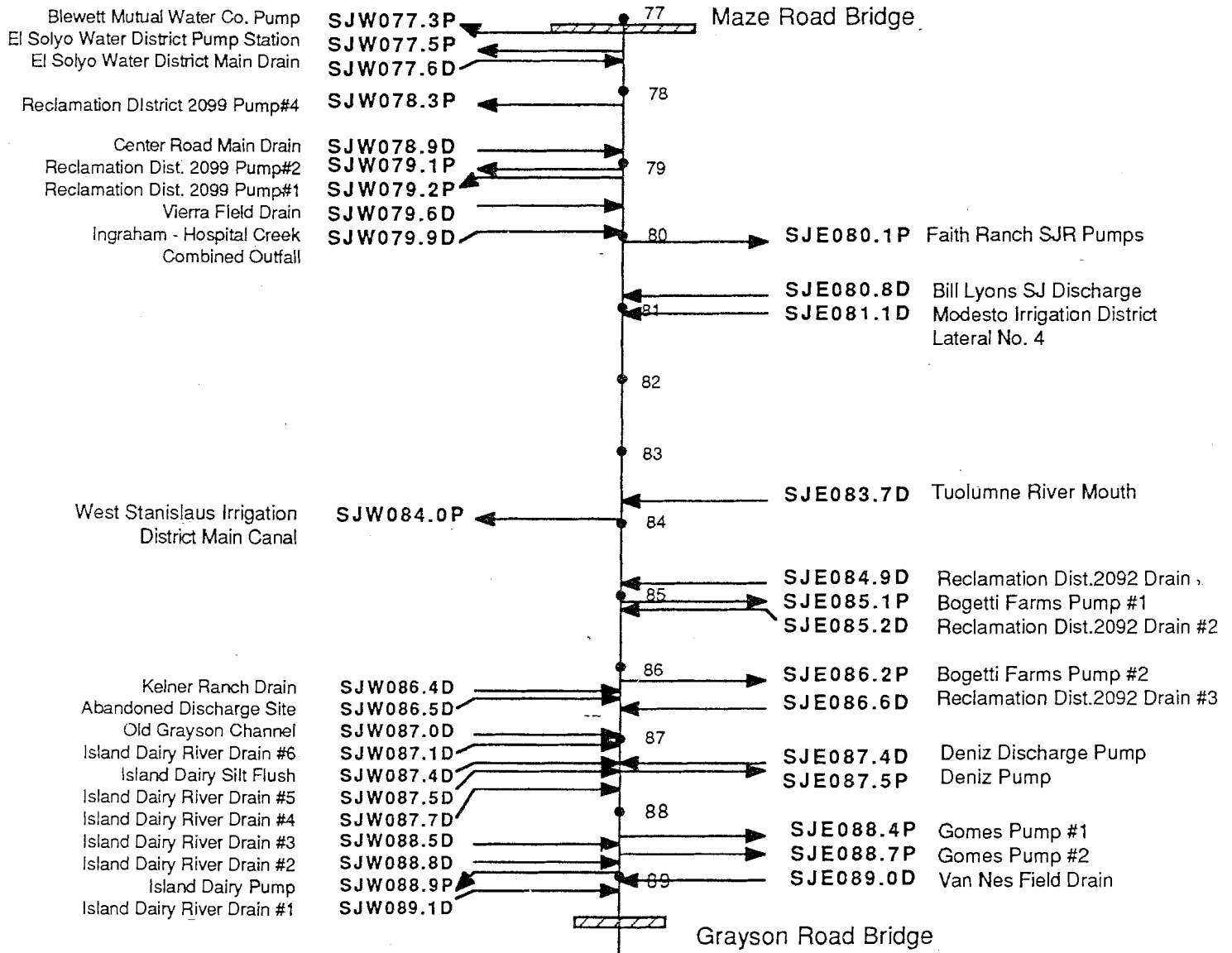

Figure 23. Schematic Diagram for Water Diversions and Discharges on the San Joaquin River from Grayson Road Bridge to Maze Road Bridge (Hwy. 132) (River Section 16).

The Old Grayson Channel also contributes significant discharge flows to the river. These flows however originate from a number of smaller drains that flow into the Channel upstream of the discharge point. Because these drains influence the Channel flow significantly, a special channel survey was conducted and is reported separately as a special side branch of the river. The discussion of the channel follows the individual river section discussions.

The Tuolumne River inflow (SJE083.7P) is the most significant discharge from the east side. The Tuolumne River is the second of the three inflows from east side tributaries. Its flow has a significant impact on hydrology downstream.

#### River Section 17 - Maze Road Bridge (Highway 132) to Airport Way (Vernalis)

This 4.9 mile section of the San Joaquin River has six diversion sites and four discharge or inflow points (Figure 24). The largest diversions occur for Reclamation District 2101 through their two main pumping stations (SJW077.2P) and SJW075.9P). These two pumps serve approximately 1,300 acres of irrigated land. The most significant discharge in this section would be the Stanislaus River inflow from the east side. The Stanislaus River is the third and final east side tributary inflow to the sections of San Joaquin River reviewed in this study. The San Joaquin City Drain is the most significant inflow from the west side of the River. It receives drainage from approximately 4,200 acres that enter through three main drains into the San Joaquin City Drain.

#### River Section 18 - Airport Way (Vernalis) to Upstream of the Banta Carbona Intake Canal

This 8.8 mile section of the San Joaquin River is developed with a number of smaller diversions and discharges (Figure 25). There are 12 diversion pumps, 8 of which are on the east side of the San Joaquin River. In contrast to areas upstream, there are only 5 discharge sites on the west side of the river and each is small in contrast to the ones upstream that had a major influence on river hydrology. The 5 discharge sites on the east side of the river serve for both storm water and irrigation return flow to the river. During the year, the majority of water discharged through these sites is storm flow.

#### River Section 19 - Banta Carbona Intake Canal to Paradise Dam

This 3.7 mile section of the San Joaquin River has 8 diversion pumps and 6 discharge sites (Figure 26). The diversions are all smaller pumps serving 20-300 acres except the Intake Canal for the Banta-Carbona Irrigation District (SJW063.5P) which serves all or a portion of water to 17,800 acres of irrigated land. On the east side of the river there are 2 discharge pumps (SJE063.1D and SJE062.0D) which discharge surface water from Reclamation District No. 2075 which covers 5,000 acres. On the west side of the river a significant discharge of tile drainage water occurs from the New Jerusalem Outlet (SJW063.4D). This discharge carries subsurface drain flows from an 11,000 acre drainage district. Flows often exceed 25 cfs in this discharge throughout most of the year.

SAN JOAQUIN RIVER

Section 17: Maze Road Bridge (Hwy.132) to Airport Way (Vernalis)

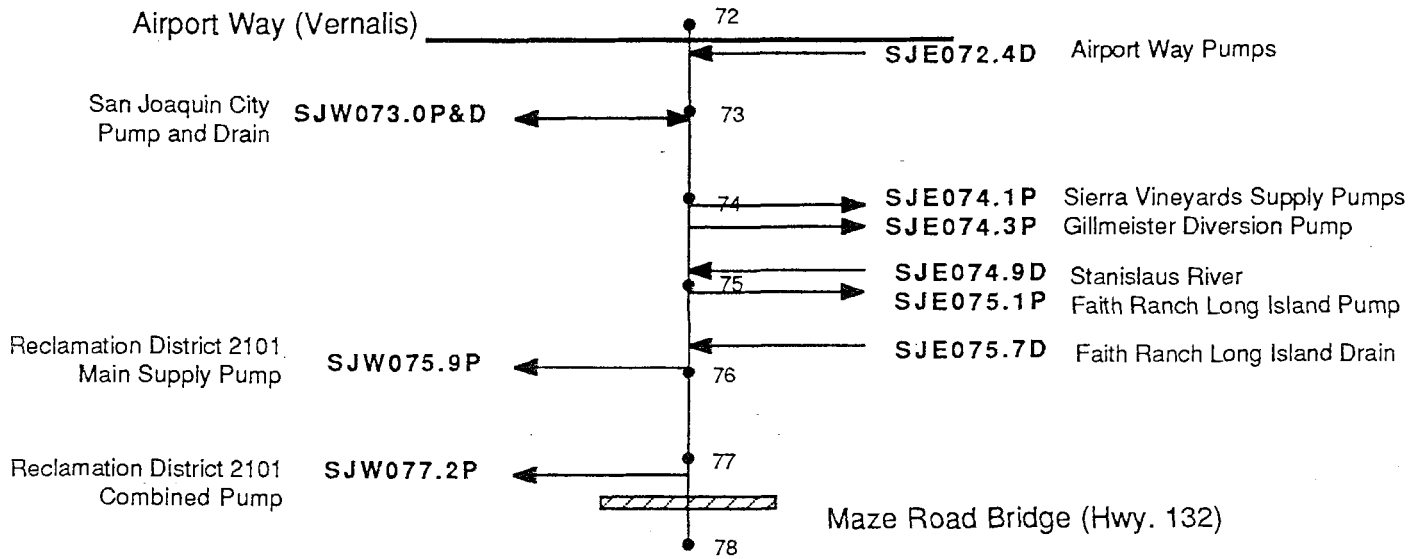

Figure 24. Schematic Diagram for Water Diversions and Discharges on the San Joaquin River from Maze Road Bridge (Hwy. 132) to Airport Way (Vernalis) (River Section 17).

SAN JOAQUIN RIVER

Section 18: Airport Way (Vernalis) to Upstream of Banta-Carbona Intake Canal

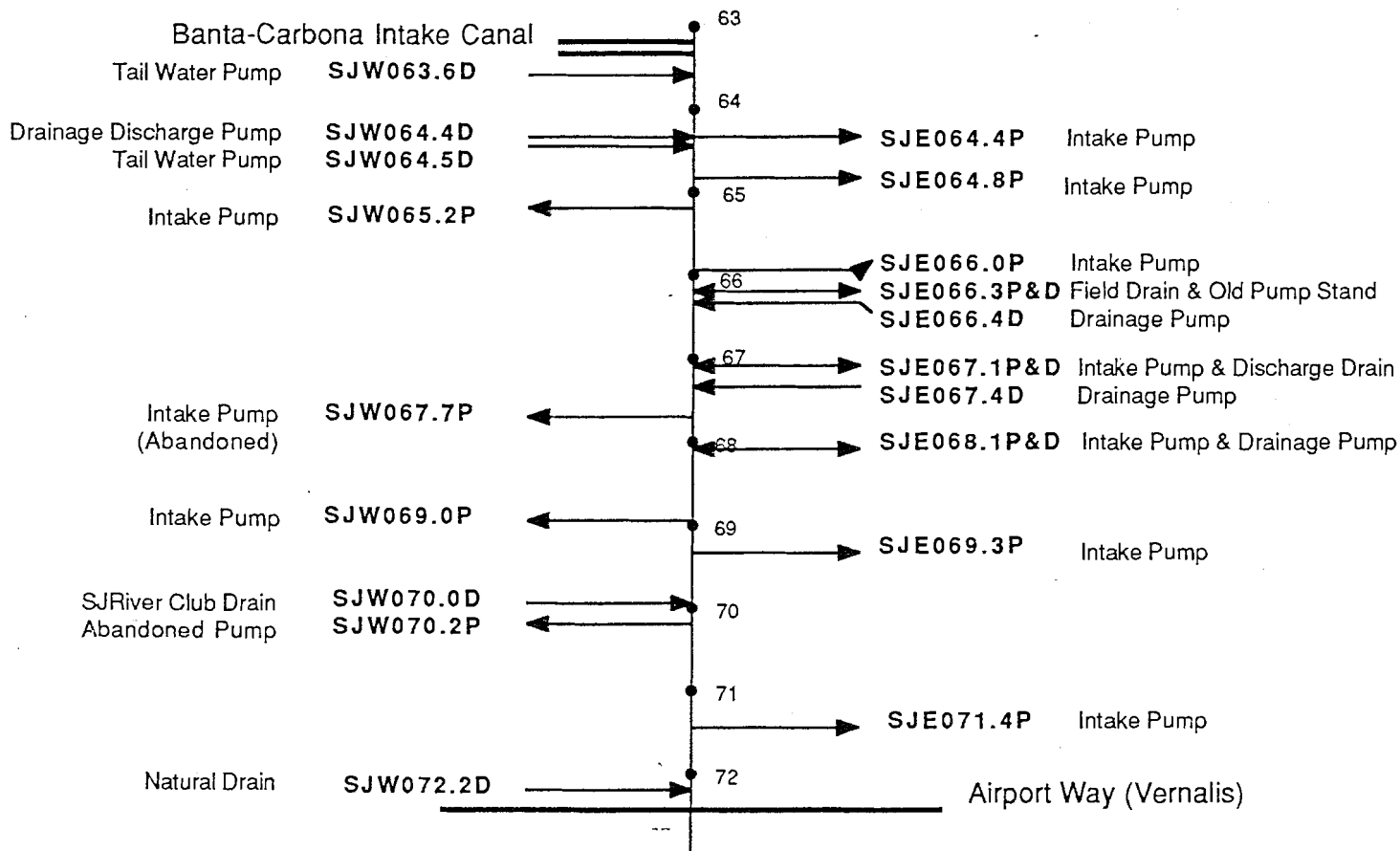

Figure 25. Schematic Diagram for Water Diversions and Discharges on the San Joaquin River from Airport Way (Vernalis) to Upstream of Banta-Carbona Intake Canal (River Section 18).

# SAN JOAQUIN RIVER

## Section 19: Banta-Carbona Intake Canal to Paradise Dam

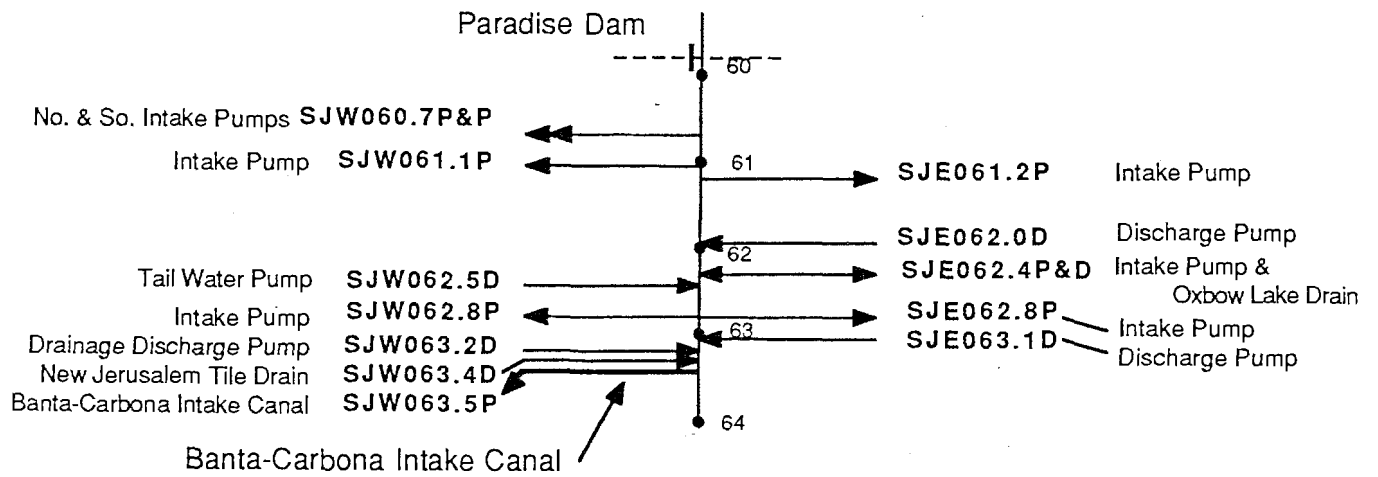

Figure 26. Schematic Diagram for Water Diversions and Discharges on the San Joaquin River from Banta-Carbona Intake Canal to Paradise Dam (River Section 19).

## River Section 20 - Paradise Dam to Mossdale Bridge (Interstate 5)

This 3.7 mile section of the San Joaquin River is developed as a water supply reach but few significant discharges occur in this reach (Figure 27). There are 8 diversion sites within this section and depending upon river flow and pump usage upstream, this reach can affect flow hydrology at the Mossdale Bridge. A significant diversion can be the use of the Paradise Cut Dam (SJW059.9P) although this is rarely used in the irrigation season or low flow period.

### SPECIAL CHANNEL SURVEYS

#### Special Channel Survey A Bear Creek from Eastside Bypass Inflow to San Joaquin River

This 4 mile section of Bear Creek has 7 discharge sites and one diversion site (Figure 28). The discharge sites are area drains that serve farming operations within a few miles of the Creek. The flow in these drains is intermittent and normally is associated with field irrigation.

#### Special Channel Survey B Old Grayson Channel from Origin to San Joaquin River

This 4.5 mile channel is the old main branch of the San Joaquin River near Laird Slough (Figure 29). The river now follows a course through Laird Slough. There are 9 discharge sites along this slough and one diversion pump. The pump is located at the upstream end of the channel in a depression; the depression is replenished during the irrigation season by West Stanislaus Irrigation District drainage water and seepage from the San Joaquin River and the Old Grayson Channel. The nine discharge sites, however, are located on the main channel and their flows move directly to the San Joaquin River at the Old Grayson Channel Outflow (SJW087.0D). Four of the nine discharge sites (Minnie Road Drain-OLDWSJID, Grayson Road Drain-OLDW2.4D, Westley Wasteway-OLDW3.3D and Del Mar Drain OLDW4.2D) contribute the major portion of the flow to the Old Grayson Channel. All carry surface return water from irrigated cropland in the West Stanislaus Irrigation District. The Westley Wasteway also carries a significant flow of operational spill water from the Delta Mendota Canal.

#### Special Channel Survey C - West Stanislaus Irrigation District Main Lift Pumps to the San Joaquin River

This 2 mile channel is the intake canal to the West Stanislaus Irrigation District Main Lift Pumps (Figure 30). There are 6 diversion pumps within the 2-mile section from the river to the main lift pumps. Those diversions irrigate land on both sides of the main canal. There is one discharge site which is located immediately downstream of the trash racks which sit approximately 0.2 miles into the canal. The discharge from this site is small in comparison to other west side discharges.

SAN JOAQUIN RIVER

Section 20: Paradise Dam to Mossdale Bridge (Interstate 5)

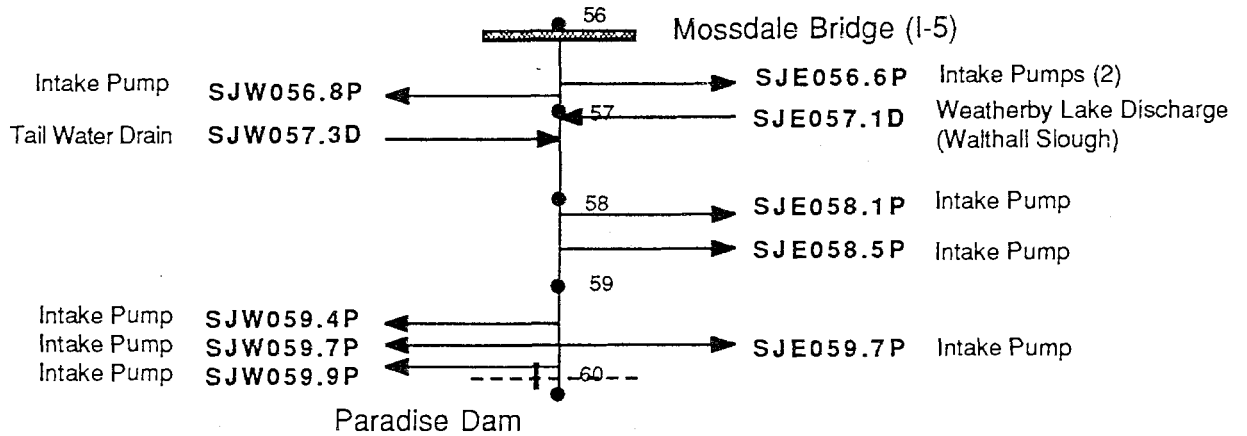

Figure 27. Schematic Diagram for Water Diversions and Discharges on the San Joaquin River from Paradise Dam to Mossdale Bridge (Interstate 5) (River Section 20).



Special Channel Survey A: Bear Creek from Eastside Bypass Inflow to San Joaquin River

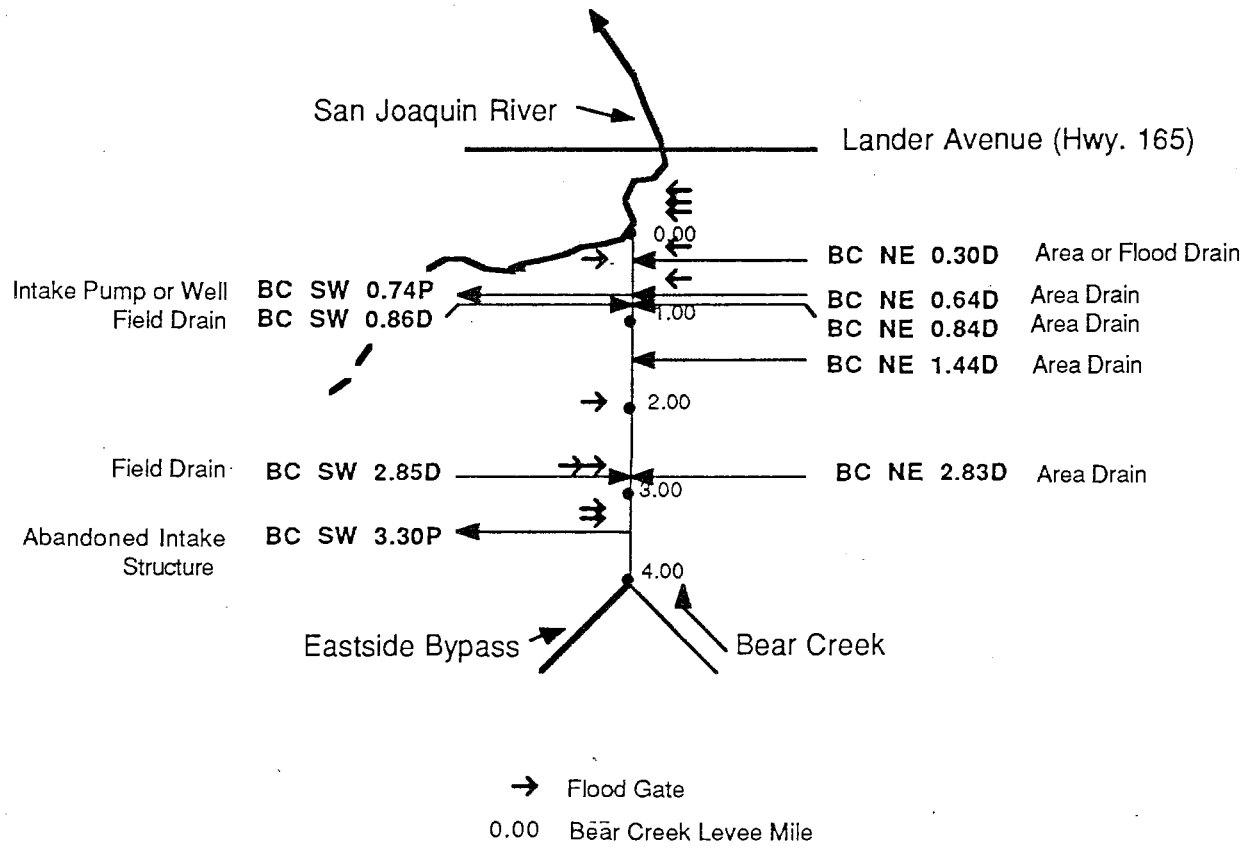

Figure 28. Schematic Diagram for Special Channel Survey A: Bear Creek from Eastside Bypass Inflow to San Joaquin River.

Special Channel Survey B: Old Grayson Channel from Origin to San Joaquin River

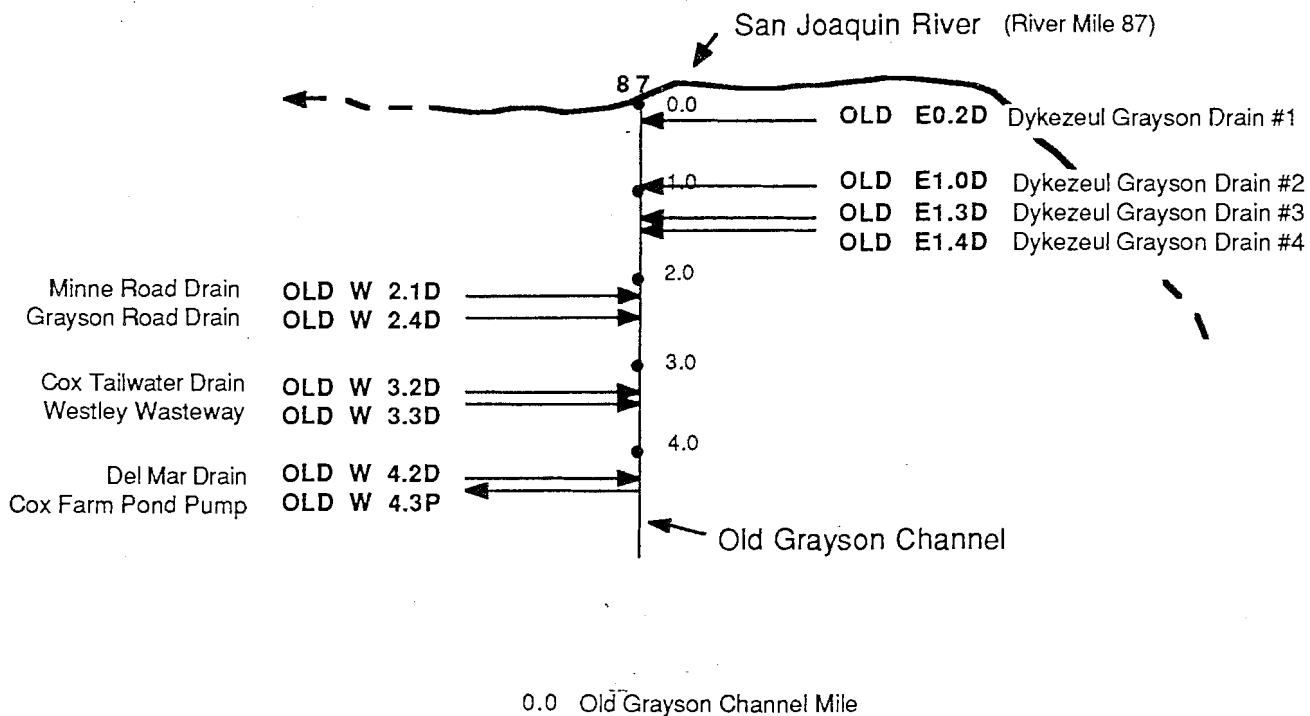
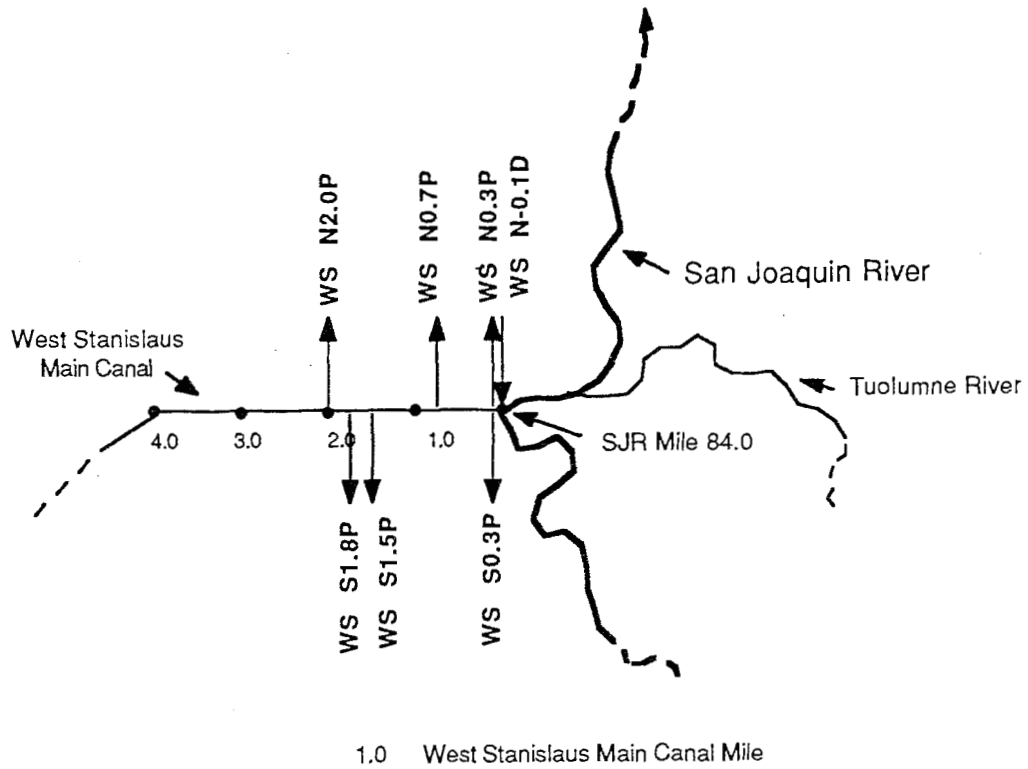

Figure 29. Schematic Diagram for Special Channel Survey B: Old Grayson Channel from Origin to San Joaquin River.

Special Channel Survey C: West Stanislaus Irrigation District  
Pumps to San Joaquin River



<b>WS N-0.1D</b>	Tail Water Discharge Pump	<b>WS S0.3P</b>	Diversion Pump
<b>WS N0.3P</b>	Diversion Pump	<b>WS S1.5P</b>	Diversion Pump
<b>WS N0.7P</b>	Diversion Pump	<b>WS S1.8P</b>	Diversion Pump
<b>WS N2.0P</b>	Diversion Pump		

Figure 30. Schematic Diagram for Special Channel Survey C: West Stanislaus Irrigation District from Pumps to San Joaquin River.

## REFERENCES

- James, E.W., Grewell, B.J., Westcot, D.W., Belden, K.K. and Boyd, T.F., 1988a. Water Quality of the Lower San Joaquin River: Lander Avenue to Vernalis, May 1985 to March 1988. Central Valley Regional Water Quality Control Board Report. 95 pages.
- James, E.W., Westcot, D.W., Grewell, B.J., Belden, K.K., Boyd, T.F., Waters, R.I., and Thomasson, R.R., 1988b. Agricultural Drainage Contribution to Water Quality in the Grassland Area of Western Merced County, California. Central Valley Regional Water Quality Control Board Report, 169 pages.
- U.S. Army Corps of Engineers, 1984 San Joaquin River Aerial Atlas 2 volumes (Stockton to Merced River) (Merced River to Mendota)

**RB5s/SJB/00003.1**

WATER DIVERSION AND DISCHARGE POINTS  
ALONG THE SAN JOAQUIN RIVER:  
MENDOTA POOL DAM TO MOSSDALE BRIDGE

Volume 2-A: Appendix A

Detailed Descriptions of Discharge and  
Diversion Points Along the San Joaquin River  
from Mendota Dam to Mossdale Bridge  
at Interstate 5

California Regional Water Quality Control Board  
Central Valley Region  
3443 Routier Road  
Sacramento, CA 95827-3098

April 1989

CALIFORNIA REGIONAL WATER QUALITY CONTROL BOARD  
CENTRAL VALLEY REGION

Board Members

Paul E. Simpson, Chair  
Clifford C. Wisdom, Vice Chair  
Karen Vercruse  
John S. Corkins  
Hugh V. Johns  
W. Steve Tompkins.  
W. M. "Walt" Winn

William H. Crooks, Executive Officer

The staff involved in the  
preparation of this report are:

Edward W. James, Engineering Geologist  
Dennis W. Westcot, Senior Land and Water Use Analyst  
Jeanne L. Gonzalez, Geology Assistant

Special acknowledgement goes to those staff who spent countless hours doing the field surveys: Rudy J. Schnagl, John L. Menke, Louis F. Pratt, Christopher Cooper, and Ron R. Thomasson and to Brenda Grewell who prepared all the report graphics. Special thanks goes to the land owners, without whose cooperation this program would not have been possible.

APPENDIX A  
TABLE OF CONTENTS

	<u>Page</u>
San Joaquin River Section #1 Mendota Dam to Avenue 7-1/2 . . . . .	A-2
San Joaquin River Section #2 Avenue 7-1/2 to Sack Dam . . . . .	A-4
San Joaquin River Section #3 Sack Dam to Santa Rita Bridge (Highway 152) . . . . .	A-7
San Joaquin River Section #4 Santa Rita Bridge (Highway 152) to Mariposa Bypass (Intake) . . . . .	A-8
San Joaquin River Section #5 Mariposa Bypass (Intake) to Turner Island Road . . . . .	A-10
San Joaquin River Section #6 Turner Island Road to Mariposa Bypass (Outlet) . . . . .	A-12
San Joaquin River Section #7 Mariposa Bypass (Outlet) to Bear Creek Inflow . . . . .	A-14
San Joaquin River Section #8 Bear Creek Inflow to Lander Avenue Bridge (Highway 165) . . . . .	A-16
San Joaquin River Section #9 Lander Avenue Bridge (Highway 165) to Upstream of Salt Slough . . . . .	A-18
San Joaquin River Section #10 Salt Slough Inflow to Fremont Ford Bridge (Highway 165) . . . . .	A-25
San Joaquin River Section #11 Fremont Ford Bridge (Highway 140) to Upstream of Mud Slough (north) . . . . .	A-32
San Joaquin River Section #12 Mud Slough (north) to Hills Ferry Road Bridge . . . . .	A-37
San Joaquin River Section #13 Hills Ferry Road Bridge to Crows Landing Road Bridge . . . . .	A-49
San Joaquin River Section #14 Crows Landing Road Bridge to Patterson Bridge . . . . .	A-78
San Joaquin River Section #15 Patterson Bridge to Grayson Road Bridge . . . . .	A-99

APPENDIX A

TABLE OF CONTENTS (continued)

	<u>Page</u>
San Joaquin River Section #16 Grayson Road Bridge to Maze Road Bridge (Highway 132) . . . . .	A-125
San Joaquin River Section #17 Maze Road Bridge (Highway 132) to Airport Way (Vernalis) . . . . .	A-164
San Joaquin River Section #18 Airport Way (Vernalis) to Upstream of Banta-Carbona Intake Canal . . .	A-177
San Joaquin River Section #19 Banta-Carbona Intake to Paradise Dam . . . . .	A-179
San Joaquin River Section #20 Paradise Dam to Mossdale Bridge (Interstate 5) . . . . .	A-181
San Joaquin River Section A Bear Creek-Eastside Bypass (Inflow) to San Joaquin River . . . . .	A-183
San Joaquin River Section B Old Grayson Channel-Origin to San Joaquin River . . . . .	A-185
San Joaquin River Section C West Stanislaus Irrigation District Pumps to San Joaquin River . . .	A-197



Explanation of the Unique Site Identification Numbers  
Used Throughout the Report and Appendices

SJ W 110.8 P  
1 2 3 4

1. The first two letters designate the river  
SJ = San Joaquin River
2. The third letter designates the bank of the river  
W = west bank  
E = east bank
3. The 4-digit number designates the river mileage as described by the U.S. Army Corps of Engineers (1984)
4. The final letter designates the type of site  
P = water diversion  
D = discharge to the river

San Joaquin River Section #1

Mendota Dam to Avenue 7-1/2

SAN JOAQUIN RIVER  
Section 1: Mendota Dam to Avenue 7 1/2

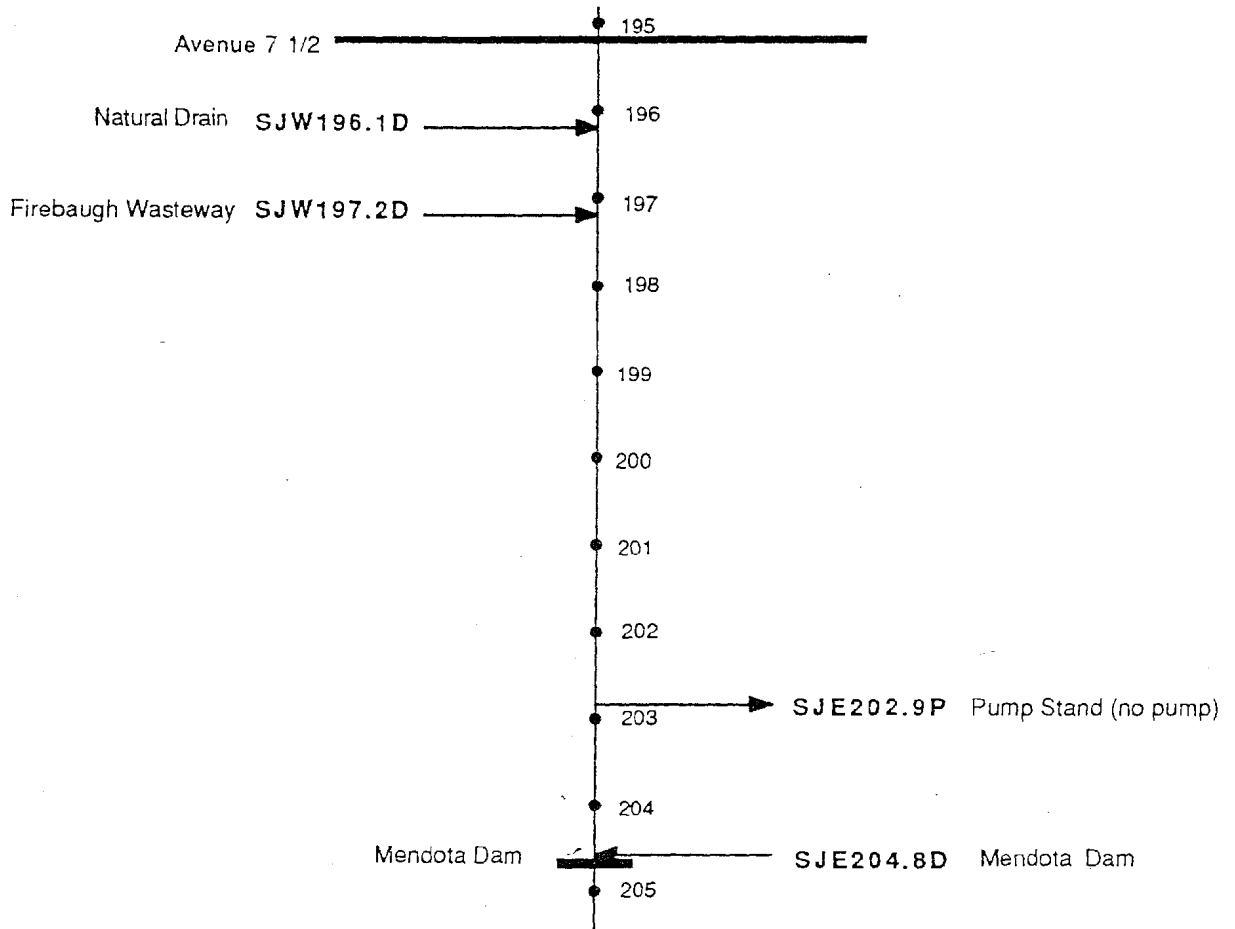

Figure A-1. Schematic Diagram for Water Diversions and Discharges on the San Joaquin River from Mendota Dam to Avenue 7 1/2 (River Section 1).

San Joaquin River Section #2

Avenue 7-1/2 to Sack Dam

SAN JOAQUIN RIVER

Section 2: Avenue 7 1/2 to Sack Dam

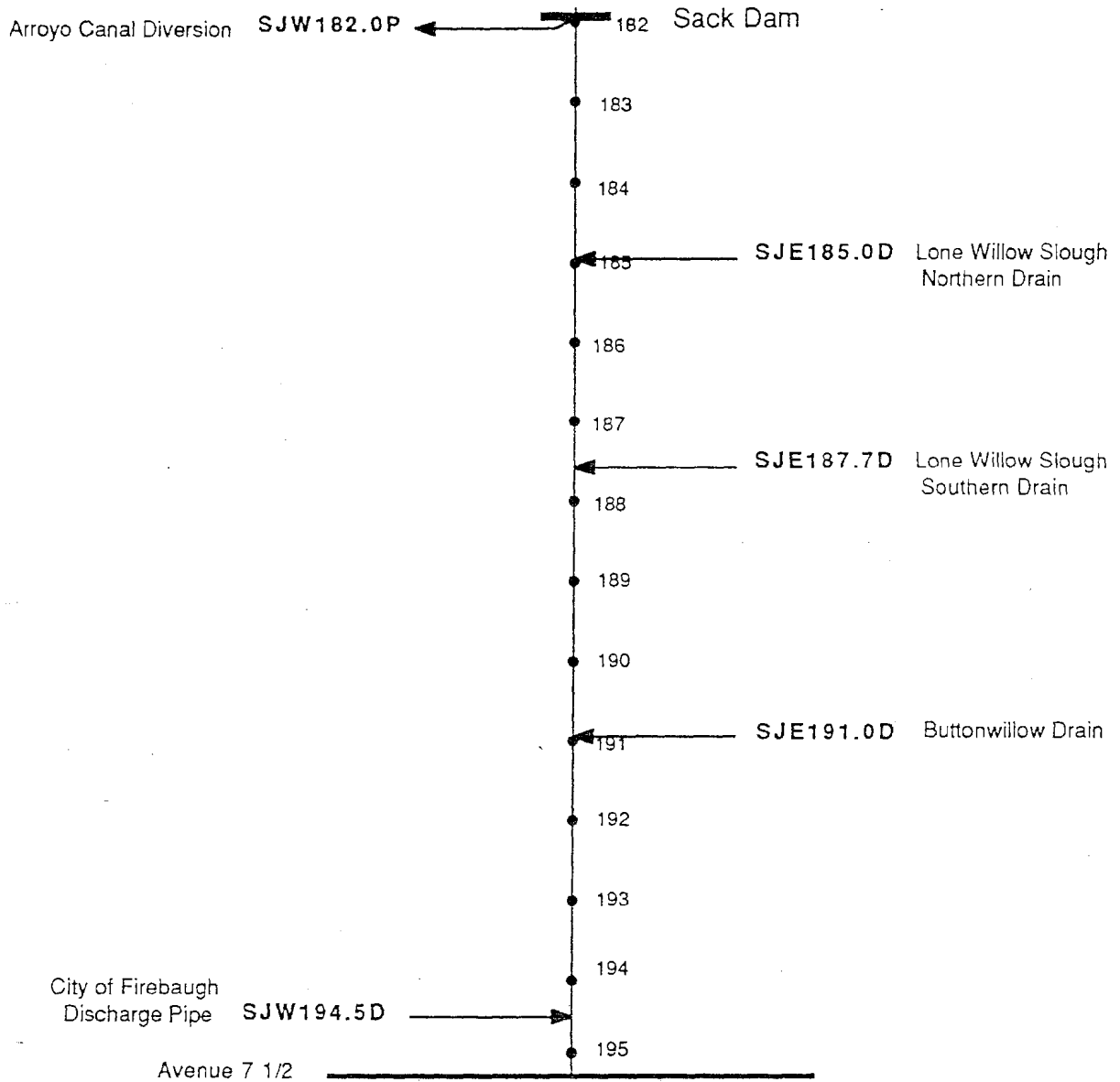

Figure A-2. Schematic Diagram for Water Diversions and Discharges on the San Joaquin River from Avenue 7 1/2 to Sack Dam (River Section 2).

San Joaquin River Section #3

Sack Dam to Santa Rita Bridge (Highway 152)

SAN JOAQUIN RIVER

Section 3: Sack Dam to Santa Rita Bridge (Hwy. 152)

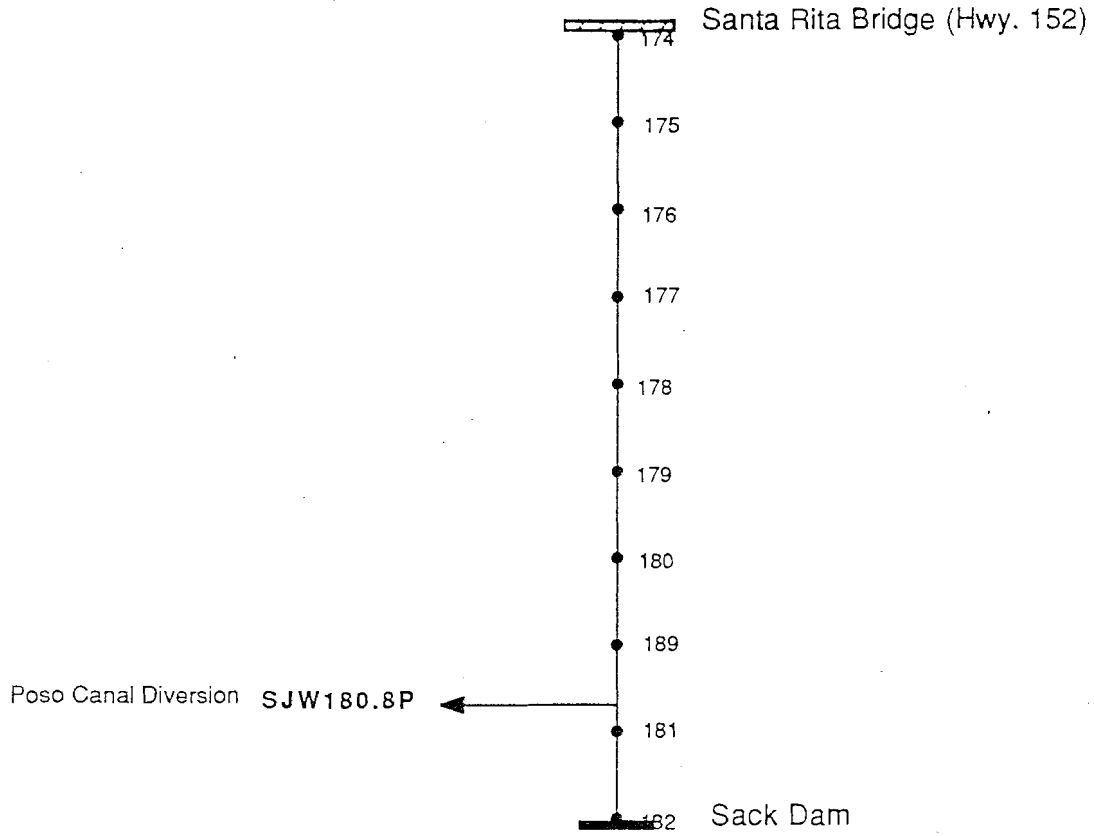

Figure A-3. Schematic Diagram for Water Diversions and Discharges on the San Joaquin River from Sack Dam to Santa Rita Bridge - Hwy. 152 (River Section 3).

San Joaquin River Section #4

Santa Rita Bridge (Highway 152) to Mariposa Bypass (Intake)



SAN JOAQUIN RIVER

Section 4: Santa Rita Bridge (Hwy. 152) to Mariposa Bypass (Intake)

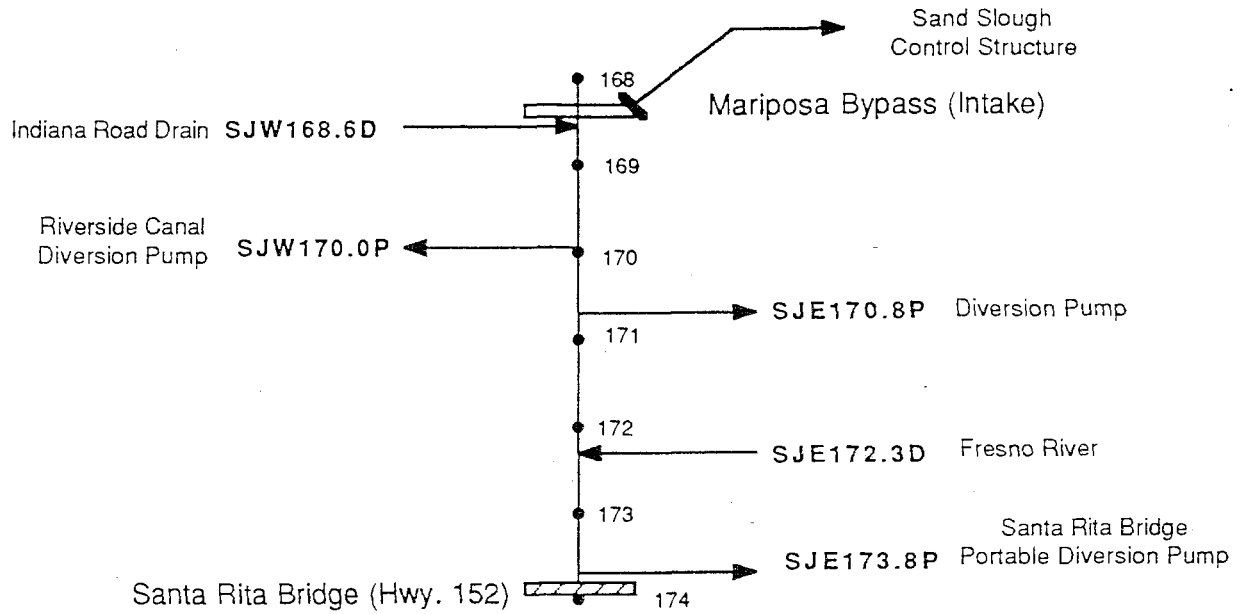

Figure A-4. Schematic Diagram for Water Diversions and Discharges on the San Joaquin River from Santa Rita Bridge - Hwy. 152 to Mariposa Bypass (Intake) (River Section 4).

San Joaquin River Section #5

Mariposa Bypass (Intake) to Turner Island Road

SAN JOAQUIN RIVER

Section 5: Mariposa Bypass (Intake) to Turner Island Road

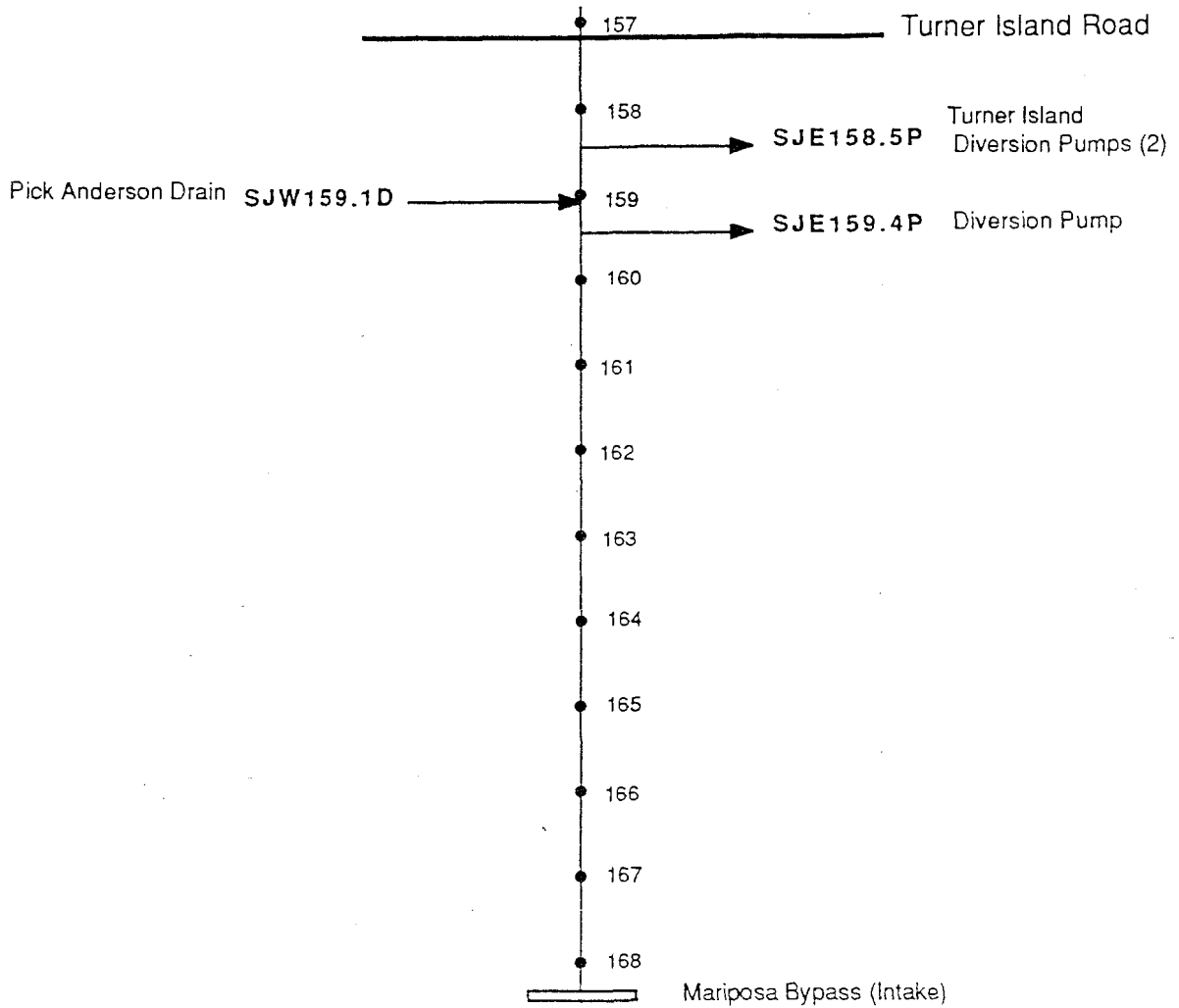

Figure A-5. Schematic Diagram for Water Diversions and Discharges on the San Joaquin River from Mariposa Bypass (Intake) to Turner Island Road (River Section 5).

San Joaquin River Section #6

Turner Island Road to Mariposa Bypass (Outlet)

SAN JOAQUIN RIVER

Section 6: Turner Island Road to Mariposa Bypass (Outlet)

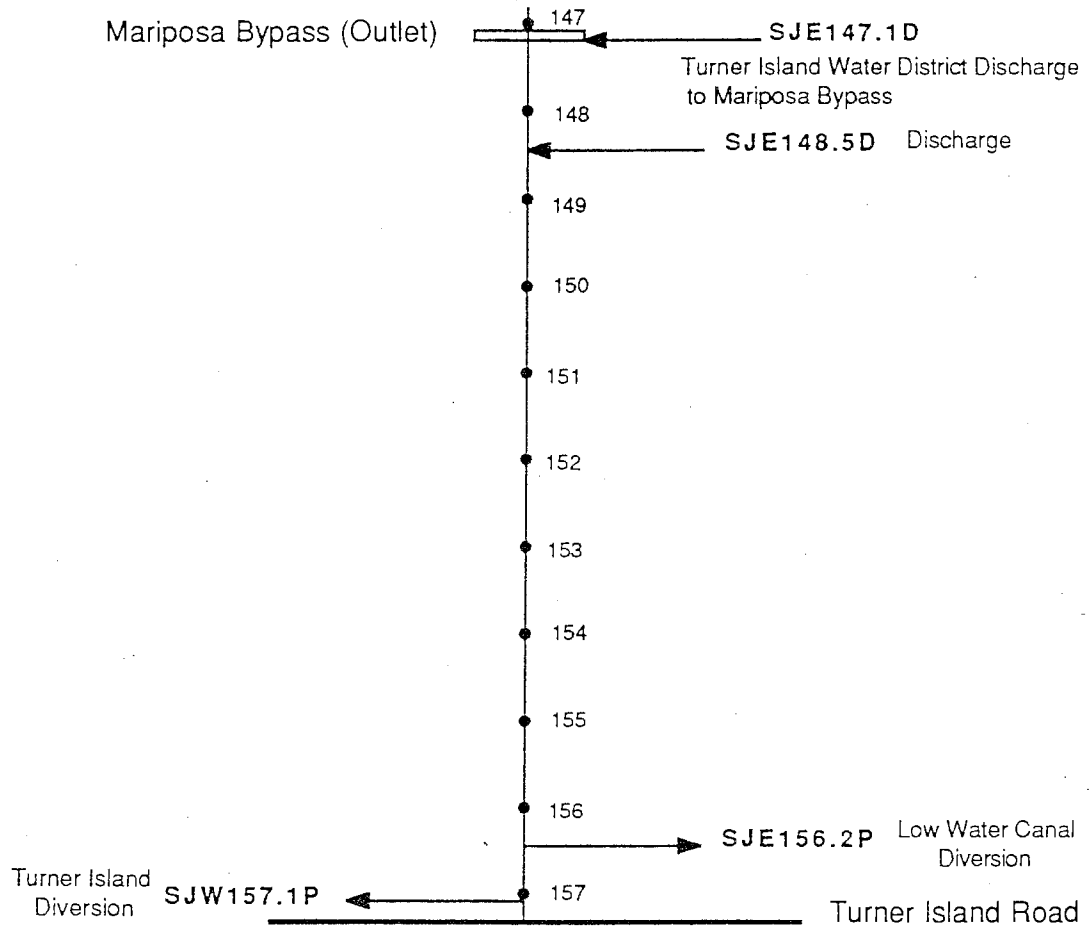

Figure A-6. Schematic Diagram for Water Diversions and Discharges on the San Joaquin River from Turner Island Road to Mariposa Bypass (Outlet)(River Section 6).

San Joaquin River Section #7

Mariposa Bypass (Outlet) to Bear Creek Inflow

SAN JOAQUIN RIVER

Section 7: Mariposa Bypass (Outlet) to Bear Creek Inflow

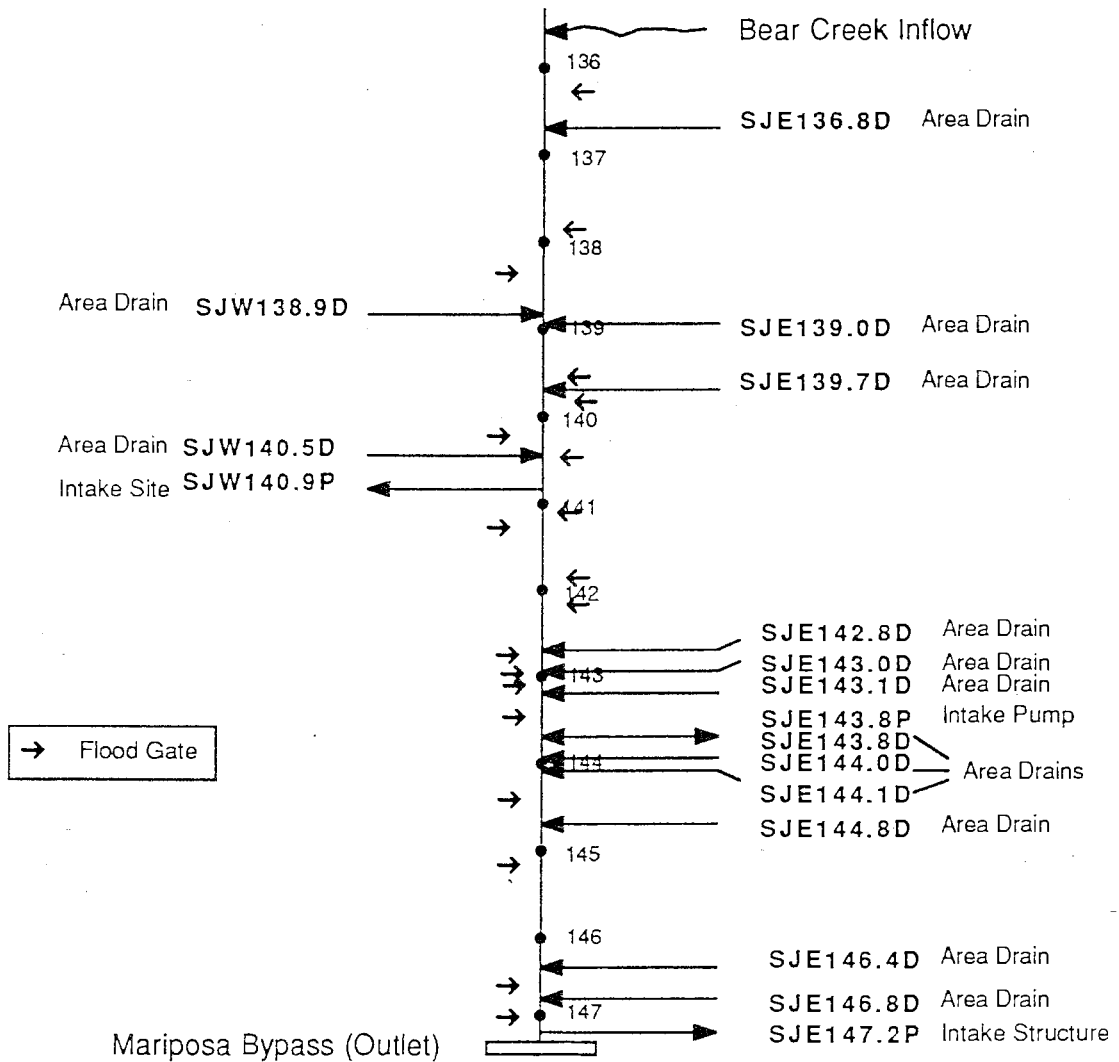

Figure A-7. Schematic Diagram for Water Diversions and Discharges on the San Joaquin River from Mariposa Bypass (Outlet) to Bear Creek Inflow (River Section 7).

San Joaquin River Section #8

Bear Creek Inflow to Lander Avenue Bridge (Highway 165)



SAN JOAQUIN RIVER

Section 8: Bear Creek Inflow to Lander Avenue Bridge (Hwy. 165)

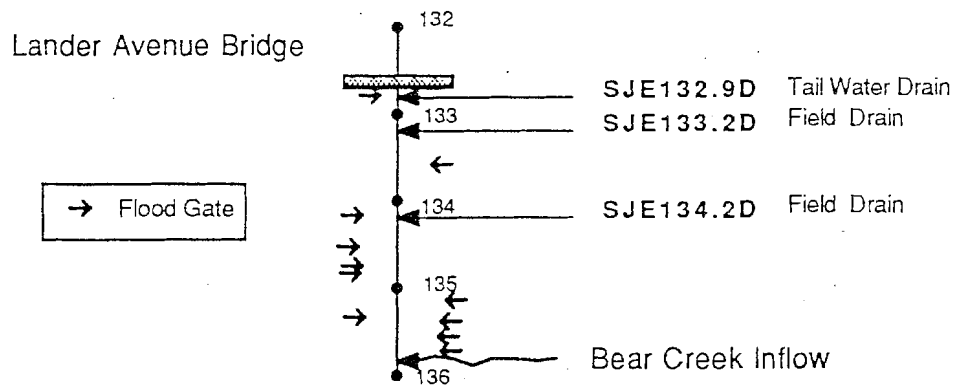

Figure A-8. Schematic Diagram for Water Diversions and Discharges on the San Joaquin River from Bear Creek Inflow to Lander Avenue Bridge (Hwy.165) (River Section 8).

San Joaquin River Section #9

Lander Avenue Bridge (Highway 165) to Upstream of Salt Slough

SAN JOAQUIN RIVER

Section 9: Lander Avenue Bridge (Hwy. 165) to Upstream of Salt Slough

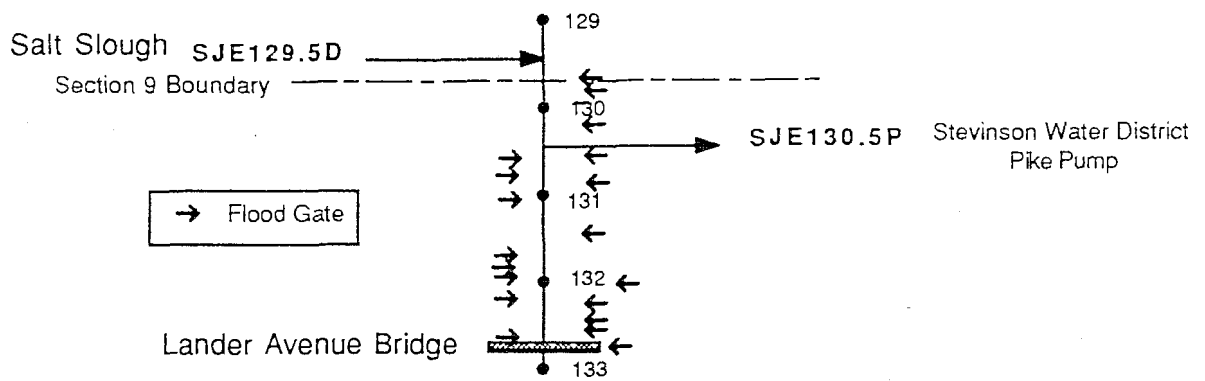

Figure A-9. Schematic Diagram for Water Diversions and Discharges on the San Joaquin River from Lander Avenue Bridge (Hwy.165) to Upstream of Salt Slough (River Section 9).

## SAN JOAQUIN RIVER DISCHARGE SITE

SITE ID# SJE 129.5

Site Name: Flood Gates 23E-33E

River Mileage: 129.5-132.9

**Site description, location and access:** There are 11 flood gates on the right (east) bank of the San Joaquin River in this reach. They are designed to discharge surface runoff into the River during and after flood flows. They have the potential to discharge tail water, but staff inspections have not detected extensive use for this purpose. Access to the sites is via the east levee road north of the east levee and Lander Avenue intersection.

Township/Range/Section: N/A

Latitude/Longitude: N/A

County: Merced

USGS Quad Map: Gustine & Stevinson

### WATER SOURCE

**Type and source of water being discharged (description):** Lower San Joaquin Levee District Unit No. 1 - Right (East) Bank San Joaquin River.

<u>Site#</u>	<u>Miles North of Lander Avenue</u>	<u>Unit No. 1 Levee Mileage</u>	<u>Site Description</u>
23E	2.4	6.65	24-inch CM pipe through the levee, 9.8 feet below the crown. Flap gate on the waterward end.
24E	2.0	6.90	36-inch CM pipe through the levee, 10.3 feet below the crown. Flap gate on the waterward end.
25E	1.8	7.22	24-inch CM pipe through the levee, 5.1 feet below the crown. Flap gate on the waterward end.
26E	1.6	7.46	24-inch CM pipe through the levee, 8.0 feet below the crown. Flap gate on the waterward end.
27E	1.3	7.70	24-inch CM pipe through the levee, 10.0 feet below the crown. Flap gate on the waterward end.
28E	0.9	8.09	24-inch CM pipe through the levee, 8.0 feet below the crown. Flap gate on the waterward end.

**SAN JOAQUIN RIVER DISCHARGE SITE**

SITE ID# SJE 129.5

Site Name: Flood Gates 23E-33E

River Mileage: 129.5-132.9

Site description, location and access: There are 11 flood gates on the right (east) bank of the San Joaquin River in this reach. They are designed to discharge surface runoff into the River during and after flood flows. They have the potential to discharge tail water, but staff inspections have not detected extensive use for this purpose. Access to the sites is via the east levee road north of the east levee and Lander Avenue intersection.

Township/Range/Section: N/A

Latitude/Longitude: N/A

County: Merced

USGS Quad Map: Gustine & Stevinson

WATER SOURCE

Type and source of water being discharged (description): Lower San Joaquin Levee District Unit No. 1 - Right (East) Bank San Joaquin River.

<u>Site#</u>	<u>Miles North of Lander Avenue</u>	<u>Unit No. 1 Levee Mileage</u>	<u>Site Description</u>
23E	2.4	6.65	24-inch CM pipe through the levee, 9.8 feet below the crown. Flap gate on the waterward end.
24E	2.0	6.90	36-inch CM pipe through the levee, 10.3 feet below the crown. Flap gate on the waterward end.
25E	1.8	7.22	24-inch CM pipe through the levee, 5.1 feet below the crown. Flap gate on the waterward end.
26E	1.6	7.46	24-inch CM pipe through the levee, 8.0 feet below the crown. Flap gate on the waterward end.
27E	1.3	7.70	24-inch CM pipe through the levee, 10.0 feet below the crown. Flap gate on the waterward end.
28E	0.9	8.09	24-inch CM pipe through the levee, 8.0 feet below the crown. Flap gate on the waterward end.

<u>Site#</u>	<u>Miles North of Lander Avenue</u>	<u>Unit No. 1 Levee Mileage</u>	<u>Site Description</u>
29E	0.6	8.43	24-inch CM pipe through the levee, 9.5 feet below the crown. Flap gate on the waterward end.
30E	0.4	8.62	24-inch CM pipe through the levee, 9.0 feet below the crown. Flap gate on the waterward end.
31E	0.1	8.95	24-inch CM pipe through the levee, 9.1 feet below the crown. Flap gate on the waterward end.
32E	50 feet	9.01	36-inch CM pipe through the levee, 10.0 feet below the crown. Flap gate on the waterward end.
33E	45 feet	9.01	30-inch concrete drainpipe through the levee, 7.3 feet below the crown. Slide gate on the waterward end. (App. No. 12156 - Merquin Co. Water District).

**Comments on factors affecting water quality and quantity at the site:** Discharge water should be of good quality as normal rainfall runoff.

SAN JOAQUIN RIVER DIVERSION SITE

SITE ID # SJE 130.5 P

Site Name: Stevinson Water District  
Pike Pump

River Mileage: 130.5

Site description, location and access: The pump is located on the east bank of the San Joaquin River and can be accessed via east levee. The pump is 1.7 miles north of Lander Avenue on the east levee. The pump is used to irrigate the landward side of the levee and the water is transported via a 24-inch pipe through the levee, 13.6 feet below the crown. Concrete distribution box on the waterward side. Pump on the riverbank. (App. No. 4425 - Stevinson Corp.)

Township/Range/Section: SW 1/4, SE 1/4, NW 1/4, Section 28, T7S, R10E,  
(DWR# 7S/10E-28F)

Latitude/Longitude: Lat. 37° 17' 53"/Long. 120° 52' 48"

County: Merced

USGS Quad Map: Gustine

Type of diversion and use of the water: The pump has 75 hp. It pumps water from the San Joaquin River to irrigate 500 acres of farm land. Deep wells are occasionally used to supplement water supply. The irrigated farm land alternates in uses between pasture, alfalfa, and corn.

Meter Number: not recorded on field survey

Water Right Permit Number: 4425

## SAN JOAQUIN RIVER DISCHARGE SITE

SITE ID# SJW 130.6

Site Name: Flood Gates 1W-8W

River Mileage: 130.6-132.9

**Site description, location and access:** There are eight flood gates on the left (west) bank of the San Joaquin River in this reach. They are designed to discharge surface runoff into the River during and after flood flows. They have the potential to discharge tail water, but staff inspections have not detected extensive use for this purpose. Access to the sites is via the west levee road north of the west levee and Lander Avenue intersection.

Township/Range/Section: N/A

Latitude/Longitude: N/A

County: Merced

USGS Quad Map: Gustine & Stevinson

### WATER SOURCE

Type and source of water being discharged (description): Lower San Joaquin Levee District Unit No. 2 - Left (West) Bank San Joaquin River.

<u>Site#</u>	<u>Miles North of Lander Avenue</u>	<u>Unit No. 2 Levee Mileage</u>	<u>Site Description</u>
01W	2.1	0.24	24-inch CM pipe through the levee, 11.0 feet below the crown. Flap gate on the waterward end.
02W	1.6	0.69	24-inch CM pipe through the levee, 14.8 feet below the crown. Flap gate on the waterward end.
03W	1.3	1.03	24-inch CM pipe through the levee, 8.6 feet below the crown. Flap gate on the waterward end.
04W	1.1	1.23	24-inch CM pipe through the levee, 7.5 feet below the crown. Flap gate on the waterward end.
05W	1.0	1.36	36-inch CM pipe through the levee, 14.6 feet below the crown. Flap gate on the waterward end.
06W	0.7	1.63	24-inch CM pipe through the levee, 10.2 feet below the crown. Flap gate on the waterward end.



San Joaquin River Discharge Site  
 Flood Gates 1W-8W

<u>Site#</u>	<u>Miles North of Lander Avenue</u>	<u>Unit No. 2 Levee Mileage</u>	<u>Site Description</u>
07W	0.5	1.88	36-inch CM pipe through the levee, 10.7 feet below the crown. Flap gate on the waterward end.
08W	50 feet	2.32	24-inch CM pipe through the levee, 7.0 feet below the crown. Flap gate on the waterward end.
		2.33	Lander Avenue (J14) crosses the levee at crown elevation.

Comments on factors affecting water quality and quantity at the site: Discharge water should be of good quality as normal rainfall runoff.

San Joaquin River Section #10

Salt Slough Inflow to Fremont Ford Bridge (Highway 165)

SAN JOAQUIN RIVER

Section 10: Salt Slough Inflow to Fremont Ford Bridge (Hwy. 140)

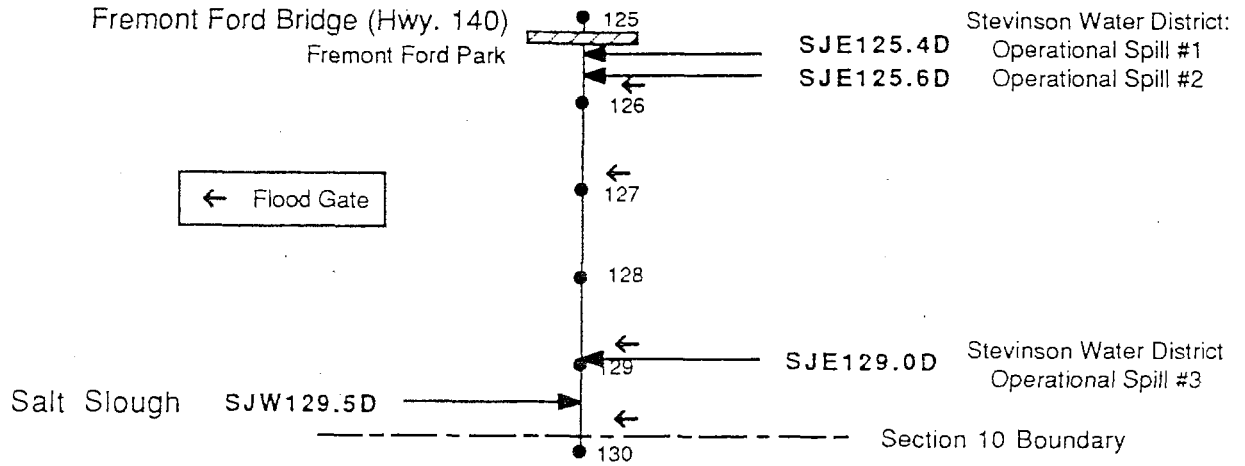

Figure A-10. Schematic Diagram for Water Diversions and Discharges on the San Joaquin River from Salt Slough Inflow to Fremont Ford Bridge (Hwy.140) (River Section 10).

## SAN JOAQUIN RIVER DISCHARGE SITE

SITE ID# SJE 125.4D

Site Name: Stevinson Water District  
Operational Spill #1

River Mileage: 125.4

Site description, location and access: The drain is located 0.2 miles south of Highway 140 on the east levee road and is accessed via the east levee. Water from the landward side of east levee is drained to the river flood plain by a 48-inch CM pipe through the levee, 14.0 feet below the crown. Flap gate on the waterward end.

Township/Range/Section: SW 1/4, NE 1/4, SE 1/4, Section 24, T7S, R9E  
(DWR# 7S/9E-24J)

Latitude/Longitude: Lat. 37° 18' 27"/Long. 120° 55' 28"

County: Merced

USGS Quad Map: Gustine

### WATER SOURCE

Type and source of water being discharged (description): Irrigation tail water from irrigated lands on the west side of the river.

## SAN JOAQUIN RIVER DISCHARGE SITE

SITE ID# SJE 125.6D

Site Name: Stevinson Water District  
Operational Spill #2

River Mileage: 125.6

Site description, location and access: The drain is located 0.3 miles south of Highway 140 on the east levee road and is accessed via the east levee. Water from the landward side of east levee is drained to the river flood plain by a 24-inch CM pipe through the levee, 11.9 feet below the crown. Flap gate on the waterward end.

Township/Range/Section: NE 1/4, SE 1/4, SE 1/4, Section 24, T7S, R9E  
(DWR# 7S/9E-24R)

Latitude/Longitude: Lat. 37° 18' 19"/Long. 120° 55' 19"

County: Merced

USGS Quad Map: Gustine

### WATER SOURCE

Type and source of water being discharged (description): Irrigation tail water during irrigation season and storm flows during the rainy season.

## SAN JOAQUIN RIVER DISCHARGE SITE

SITE ID# SJE 126.1

Site Name: Flood Gates 19E-22E

River Mileage: 126.1-128.8

**Site description, location and access:** There are four flood gates on the right (east) bank of the San Joaquin River in this reach. They are designed to discharge surface runoff into the River during and after flood flows. They have the potential to discharge tail water, but staff inspections have not detected extensive use for this purpose. Access to the sites is via the east levee road south from and Highway 140.

Township/Range/Section: N/A

Latitude/Longitude: N/A

County: Merced

USGS Quad Map: Gustine

### WATER SOURCE

**Type and source of water being discharged (description):** Lower San Joaquin Levee District Unit No. 2 - Left (West) Bank San Joaquin River.

<u>Site#</u>	<u>Miles North of Lander Avenue</u>	<u>Unit No. 1 Levee Mileage</u>	<u>Site Description</u>
19E	0.8	4.73	24-inch CM pipe through the levee, 10.0 feet below the crown. Flap gate on the waterward end.
20E	1.1	5.06	24-inch CM pipe through the levee, 8.0 feet below the crown. Flap gate on the waterward end.
21E	2.0	5.96	24-inch CM pipe through the levee, 8.6 feet below the crown. Flap gate on the waterward end.
22E	2.5	6.44	24-inch CM pipe through the levee, 9.5 feet below the crown. Flap gate on the waterward end. Slide gate on the landward end.

**Comments on factors affecting water quality and quantity at the site:** Discharge water should be of good quality as they normally discharge rainfall runoff.

## SAN JOAQUIN RIVER DISCHARGE SITE

SITE ID# SJE 129.0D

Site Name: Stevinson Water District  
Operational Spill #3

River Mileage: 129.0

Site description, location and access: The drain is located 2.2 miles south of Highway 140 on the east levee road and is accessed via the east levee. Water from the landward side of east levee is drained to the river flood plain by a 48-inch CM pipe through the levee, 13.1 feet below the crown. Flap gate on the waterward end.

Township/Range/Section: SW 1/4, SE 1/4, SW 1/4, Section 20, T7S, R10E  
(DWR# 7S/10E-20P)

Latitude/Longitude: Lat. 37° 18' 22"/Long. 120° 53' 50"

County: Merced

USGS Quad Map: Gustine

### WATER SOURCE

Type and source of water being discharged (description): Irrigation tail water during the irrigation season.

SAN JOAQUIN RIVER DISCHARGE SITE

SITE ID # SJW 129.5D

Site Name: Salt Slough

River Mileage: 129.5

Site description, location and access: Salt Slough enters the San Joaquin River between Highway 140 and Lander Avenue. Access to the site is very difficult and requires considerable driving on levees as well as walking through thick undergrowth. Staff inspections show no surface inflow to Salt Slough downstream of its crossing of Lander Avenue.

Township/Range/Section: NE 1/4, SW 1/4, Section 29, T7S, R10E (DWR# 7S/10E-29N)

Latitude/Longitude: Lat. 37° 17' 39"/Long. 120° 53' 55"

County: Merced

USGS Quad Map: Gustine

Type and source of water being discharged (description): The discharge from Salt Slough contains a mixture of tile drainage water, surface tail water, operational spills from upslope districts as well as natural flow from west side creeks. Another input is from duck ponds that discharge after the hunting season. The water from these ponds is a blend of freshwater and the other sources listed above that have been put in the ponds.

Comments on factors affecting water quality and quantity at the site: Salt Slough receives drainage water from irrigated farm land on the west side of the San Joaquin River. Staff inspection of the slough did not detect any significant surface drainage to Salt Slough below Lander Avenue.

MONITORING

Previous or ongoing monitoring at the site:

<u>Agency</u>	<u>Site ID#</u>	<u>Constituents</u>	<u>Frequency</u>	<u>Period of Record</u>	<u>Data Storage</u>
CVRWQCB	*MER 531	minerals, trace elements, & Se	monthly		CVRWQCB Files

\*Sampled at Lander Avenue



San Joaquin River Section #11

Fremont Ford Bridge (Highway 140) to Upstream of Mud Slough (north)

SAN JOAQUIN RIVER

Section 11: Fremont Ford Bridge (Hwy. 140) to Upstream of Mud Slough (North)

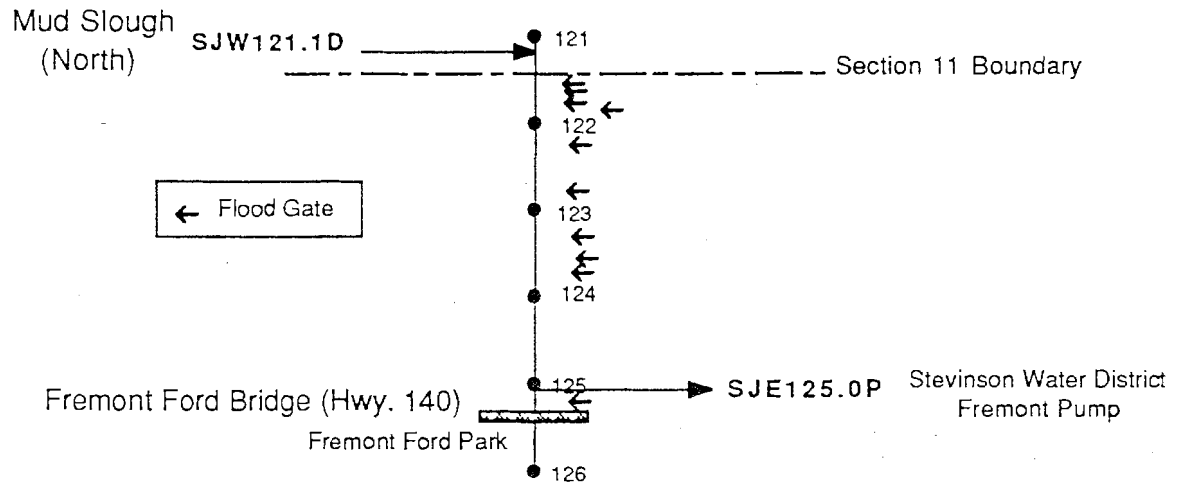

Figure A-11. Schematic Diagram for Water Diversions and Discharges on the San Joaquin River from Fremont Ford Bridge (Hwy.140) to Upstream of Mud Slough (North) (River Section 11).

**SAN JOAQUIN RIVER DIVERSION SITE**

SITE ID # SJE 125.OP

Site Name: Stevinson Water District  
Fremont Pump

River Mileage: 125.0

**Site description, location and access:** The pump is located along the eastern bank levee immediately north of the Fremont Ford Bridge. Access to the site is via the project levee at its intersection with Highway 140. The single pump is used to irrigate land within the flood plain and a 12-inch concrete pipe through the levee, 3.5 feet below the crown also provides access to lands outside the flood plain.

**Township/Range/Section:** SW 1/4, SW 1/4, NE 1/4, Section 24, T7S, R9E,  
(DWR # 7S/9E-24G)

**Latitude/Longitude:** Lat. 37° 18' 47"/Long. 120° 55' 47"

County: Merced

USGS Quad Map: Gustine

**Type of diversion and use of the water:** San Joaquin River water is diverted for use in 300 acres of land. The principle crops being grown are pasture (100 acres), corn and oats on fields located in the flood plain north of the Fremont Ford Bridge and on lands north and south of Highway 140 above the levee.

**Water Right Permit Number:** No#

**Pump Size:** 75hp

**SAN JOAQUIN RIVER DISCHARGE SITE**

SITE ID# SJE 121.2D

Site Name: Flood Gates 9-18

River Mileage: 121.2 - 125.2

**Site description, location and access:** There are 10 flood gates on the right (east) bank levee of the San Joaquin River in this reach; they are designed to discharge surface runoff into the river during and after flood flows. They have the potential to discharge irrigation tail water but staff inspections have not detected extensive use for this purpose. Access to the site is via the project levee at River Road (Highway J18). Location is noted in miles from this entry point.

Township/Range/Section: N/A

Latitude/Longitude: N/A

County: Merced

USGS Quad Map: Gustine

WATER SOURCE

Type and source of water being discharged (description):

LOWER SAN JOAQUIN LEVEE DISTRICT  
UNIT NO. 1 - RIGHT BANK SAN JOAQUIN RIVER

<u>Site #</u>	<u>Levee Mileage (miles south of River Road Highway J18)</u>	<u>Site Description</u>
09	1.70	24-inch CM pipe through the levee, 13.6 feet below the crown. Flap gate on the waterward end.
10	1.84	36-inch CM pipe through the levee, 14.2 feet below the crown. Flap gate on the waterward end.
11	1.98	24-inch CM Pipe through the levee, 9.7 feet below the crown. Flap gate on the waterward end.
12	2.08	24-inch CM Pipe through the levee, 9.8 feet below the crown. Flap gate on the waterward end.
13	2.25	36-inch CM pipe through the levee, 2.6 feet below the crown. Flap gate on the waterward end.

<u>Site #</u>	<u>Levee Mileage (miles south of River Road Highway J18)</u>	<u>Site Description</u>
14	2.53	24-inch CM pipe through the levee, 9.0 feet below the crown. Flap gate on the waterward end.
15	2.71	24-inch CM pipe through the levee, 7.3 feet below the crown. Flap gate on the waterward end.
16	3.17	36-inch CM pipe through the levee, 10.1 feet below the crown. Flap gate on the waterward end.
17	3.50	36-inch CM Pipe, through the levee, 9.7 feet below the crown. Flap gate on the waterward end.
18	3.95	30-inch CM pipe through the levee, 3.5 feet below the crown. Irrigation pipe. Slide gate on the waterward end.

**Comments on factors affecting water quality and quantity at the site:** Discharge water should be of good quality as they normally discharge rainfall runoff.

San Joaquin River Section #12

Mud Slough (north) to Hills Ferry Road Bridge

SAN JOAQUIN RIVER

Section 12: Mud Slough (North) to Hills Ferry Road Bridge

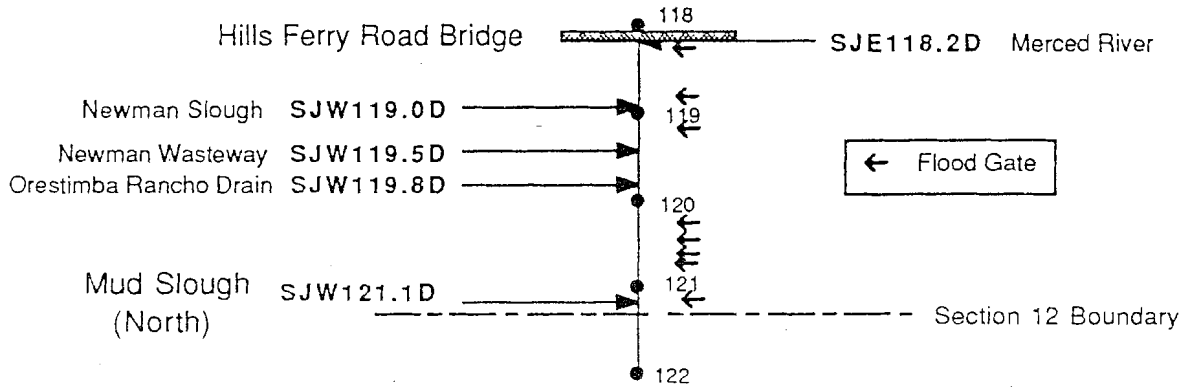

Figure A-12. Schematic Diagram for Water Diversions and Discharges on the San Joaquin River from Mud Slough (North) to Hills Ferry Road Bridge (River Section 12).

## SAN JOAQUIN RIVER DISCHARGE SITE

SITE ID# SJW 121.1D

Site Name: Mud Slough (North)

River Mileage: 121.1

**Site description, location and access:** Mud slough discharges to the San Joaquin River at River Mile 121.1. Access to the actual discharge point is very difficult because of no roads. Major flow and quality samples are normally taken at Highway 140.

**Township/Range/Section:** NW 1/4, NE 1/4, NW 1/4, Section 14, T7S, R9E  
(DWR# 7S/9E-14C)

**Latitude/Longitude:** Lat. 37° 19' 52"/Long. 120° 57' 03"

County: Merced

USGS Quad Map: Gustine

### WATER SOURCE

**Type and source of water being discharged (description):** Mud Slough receives drainage water (both tile drainage and surface tail water) from several hundred square miles of irrigated land and flows that passes through the Grassland Water District. The entire flow of the slough is made up of irrigation return flows during most of the year but in November-March, a considerable portion is made up of discharges from Duck Ponds in the Grassland Area.

**Comments on factors affecting water quality and quantity at the site:** Quality of the Slough is degraded. It contains high salts, boron and trace elements including selenium. It is periodically monitored at Highway 140 by the USBR (site #MSL140) and the DWR (site # B0-0400). Regional Board staff inspections revealed additional input to Mud Slough from Los Banos Creek and other sources downgradient from Highway 140. Hence, the water quality data at Highway 140 indicates a waste discharge to the River from upgradient sources, but may not match the water quality at the discharge of Mud Slough into the SJR.



## SAN JOAQUIN RIVER DISCHARGE SITE

SITE ID# SJW 119.8D

Site Name: Orestimba Rancho Drain

River Mileage: 119.8

**Site description, location and access:** This is an area drain that meanders throughout several hundred acres that lie northeast of the City of Gustine and lying between Mud Slough and the Newman Wasteway. Access to the discharge site is through a number of farm roads many of which are inaccessible during certain times of the year or are blocked by locked gates.

**Township/Range/Section:** SE 1/4, NE 1/4, SW 1/4, Section 10, T7S, R9E  
(DWR# 7S/9E-IOL)

**Latitude/Longitude:** Lat. 37° 20' 13"/Long. 120° 58' 06"

County: Merced

USGS Quad Map: Gustine

### WATER SOURCE

**Type and source of water being discharged (description):** This drain carries both surface supply water and tail water from the surrounding fields. The water is held in the drain and the only discharge is through a 6" plastic pipe as an overflow.

**Comments on factors affecting water quality and quantity at the site:** Quality will be influenced by the amount of supply water entering the drain.

SAN JOAQUIN RIVER DISCHARGE SITE

SITE ID# SJW 119.5D

Site Name: Newman Wasteway

River Mileage: 119.5

Site description, location and access: Newman Wasteway discharges into the San Joaquin River immediately south of the Stanislaus-Merced County line. Access to the Wasteway is through the Newman Wastewater Treatment Plant to the Wasteway levee. Follow the Wasteway levee east to the discharge point.

Township/Range/Section: SE 1/4, NW 1/4, SW 1/4, Section 10, T7S, R9E, (DWR# 7S/9E-10M)

Latitude/Longitude: Lat. 37° 20' 26"/Long. 120° 58' 17"

County: Merced

USGS Quad Map: Gustine

WATER SOURCE

Type and source of water being discharged (description): This wasteway carries primarily operational spill water from the Delta Mendota Canal. In addition, there are numerous tail water discharges that enter this system as well as operational spills from local irrigation districts. On the north bank there are approximately 5500 acres that drain to this wasteway (see map 1a). The acreage that drains from the south bank has not been determined. The Newman Wasteway is monitored as Site# MER544, located at the School Road overcrossing. The sources of irrigation water to this drainage area are the Delta Mendota Canal, Central California Irrigation District, and on-farm irrigation wells.

Comments on factors affecting water quality and quantity at the site: The discharge quality will be dependent upon the proportion of operational spill and tail water that enters the system. As the channel is deeply entrenched, seepage into the wasteway by high ground water is also likely. As the channel has little slope east of Highway 33, sampling east of this point may encounter backwater from the San Joaquin River.

MONITORING

Previous or on-going monitoring at the site:

<u>Agency</u>	<u>Site ID#</u>	<u>Constituents</u>	<u>Frequency</u>	<u>Period of Record</u>	<u>Data Storage</u>
CVRWQCB	MER 544	Standard minerals, trace elements, Se, Suspended Sediments.	Monthly	4/86-Present	CVRWQCB Files

## SAN JOAQUIN RIVER DISCHARGE SITE

SITE ID# SJW 119.0D

Site Name: Newman Slough

River Mileage: 119.0

**Site description, location and access:** This slough enters the San Joaquin River immediately north of the Newman Wasteway and immediately north of the Merced County line. This slough receives surface and subsurface drainage from approximately 4,500 acres (see map 1a). Access to the discharge site is very difficult therefore sampling and sample measurement are carried out on the 3 discharges into the Slough. These three discharges make up the entire discharge to the river. The three discharges are:

1. Newman Drainage District Collector Line "A": This drainage collector was installed in 1978 and as a result has held the water table relatively constant thus there is little projection that on-farm drainage will be installed in the near future within the Newman Drainage District. There are approximately 800 acres that are served by this collection system (see map 1b). Line A discharges into the Newman slough about 200 yards east of the flood levee protecting the City of Newman Wastewater Treatment Plant (WWTP). The discharge occurs 100 feet north of the WWTP discharge into the same slough. Access to the sampling site is through the City's WWTP. This area is often flooded in winter and an alternate sampling site is at a Manhole either at Stuhr Road (south side of Hills Ferry Road) or immediately on the east side of the flood levee. Access to the WWTP is off of Hills Ferry Road.
2. City of Newman Wastewater Treatment Plant: The Newman Wastewater Treatment Plant (WWTP) discharges adjacent to the discharges of the Newman Drainage District Line A and the Hills Ferry Drain. The discharge is from an open channel and is the southern most of the three discharges in the area. All three discharges enter a small slough that enters the San Joaquin River at Mile 119.1. The WWTP discharges infrequently and this is normally in the winter period. The Newman Wastewater Treatment Plant (WWTP) is located on the south side of Hills Ferry Road on the north side of the Newman Wasteway. The discharge point is one of three (2 open channel, 1 pipeline) in the same area. The Newman WWTP is the southern most open channel.
3. Hills Ferry Drain: The Hills Ferry Road Surface Drain discharges into an unnamed slough about 200 yards east of the flood levee protecting the City of Newman Wastewater Treatment Plant (WWTP). The discharge occurs 50-100 feet north of the WWTP discharge into the same slough. The discharge channel runs parallel to the outlet channel for the WWTP discharge. The discharge channel runs through the levee, however, a flap gate exists on the river side of the flood levee. In high water stages, a pump discharge occurs. Access to the site is off Hills Ferry Road through the City's WWTP. As access may be limited and no additional inputs occur after the flood levee, the best sampling site is the drain as it crosses under the levee.

**Township/Range/Section:** SE 1/4, SE 1/4, NE 1/4, Section 9, T7S, R9E  
(DWR# 7S/9E-9H)

**Latitude/Longitude:** Lat. 37° 20' 27"/Long. 120° 58' 34"

**County:** Stanislaus

**USGS Quad Map:** Gustine

**WATER SOURCE**

**Type and source of water being discharged (description):** The discharge from the Newman Drainage District Collector Line A carries only subsurface drainage flow from approximately 800 acres of irrigated land that is located to the north of the Newman Wasteway and east of Highway 33 runs north and south from the towns of Newman to Crows Landing (see map 1b). The irrigated area immediately to the north is also drained therefore little influence would be expected from outlying areas except any subsurface flows that may originate from the Newman Wasteway.

The discharge from the City of Newman Wastewater Treatment Plant is composed entirely of treated municipal wastewater.

The discharge from the Hills Ferry Road Drain carries only surface runoff, operation spills from Central California Irrigation District Canals, and tail water discharges from individual irrigated fields. The area drained by this drain is approximately 4500 acres around the City of Newman and Hills Ferry Road. The majority of the flow during the irrigation season is made up of tail water discharges from irrigated land located on both the north and south side of Hills Ferry Road. There is no subsurface drainage that enters the Hills Ferry Road Drain and none is projected.

The surface water carried by this drain is conveyed along Hills Ferry Road until approximately the City of Newman's wastewater treatment plant. At this point, it turns to the south and runs to an area near the plant where it either flows through the levee into Newman slough or is pumped over the levee (during flood periods) into the same slough. One important input to this system as it flows to the south is that it picks up tail water from the irrigated pasture that the City of Newman uses to dispose of its sewage effluent. While runoff is a rather small portion of the total flow, mismanagement of the wastewater reuse system could result in considerable flow into the drain.

**Comments on factors affecting water quality and quantity at the site:**

1. During river flood stages, the outlet is frequently under water thus backing up water in the collector system.
2. Water quality at this discharge is likely to be similar in characteristics to the Line I discharge which is 1.5 miles downstream. The discharge is composed entirely of subsurface tile drainage water from agricultural lands on the north and south side of Hills Ferry Road. The collection system is entirely closed therefore no other input can enter the system other than those illegally poured down one of the periodic manholes. There are no on-farm drainage systems (subsurface) within this portion of the Newman

Drainage District and none are projected. The quality of the water discharging from the collector line would represent shallow ground water characteristics in the area. During any water quality evaluation, the water quality data from this area could be compared with that from the Newman Drainage District Collector Line I (site # STC 009), however caution should be used as the quality from Line A is likely to be slightly worse than Line 1 as the intensity of the collection system within the Line A area is less than that in the Line 1 area. The discharge from the City of Newman Wastewater Treatment Plant is restricted to not more than 1% of the river flow. The plant is to have no discharge from June to September each year. The design flow for the plant is 1.2 MGD.

The discharge quality and quantity from the Hills Ferry Drain will depend heavily upon the cropping pattern in the area, irrigation intensity and other agricultural practices. The quality is likely to reflect the influence of surface runoff rather than agricultural subsurface drainage water.

#### MONITORING

Several sources of data are available:

1. The West Stanislaus Resource Conservation District, 218 North El Circulo, Patterson, CA has been measuring temperature, flow, and salinity (EC) from Line A since it was installed in 1978. Monthly measurements are taken, however, the data needs to be checked for completeness and accuracy as often the measurements are only taken during the summer irrigation season (June-Sept).
2. The United States Bureau of Reclamation, 2800 Cottage Way, Sacramento, CA sampled this site monthly from August 1982 to October 1983 for standard minerals, trace elements and nutrients. The data is stored in STORET as USBR Site # DSA 03A. The sampling point shown for the USBR site is different from that used by the Regional Board, however, the data can be analyzed together with Regional Board data as the sampling site is less than 1/4 mile from the Regional Board's site and there are no additional inputs between these two points.
2. The United States Geological Survey sampled this site in May 1984 for standard minerals and trace elements. Their results are reported in USGS Report #84-4319 as site 3A. This site is the same as used by the U.S. Bureau of Reclamation and the data should be comparable as described in #2 above.

Previous or ongoing monitoring at the site:

<u>Agency</u>	<u>Site ID#</u>	<u>Constituents</u>	<u>Frequency</u>	<u>Period of Record</u>	<u>Data Storage</u>
USBR	DSA 03A	Standard minerals, trace elements, nutrients	Monthly	8/82- 10/83	STORET
USGS	3A	Standard minerals, trace elements	once	5/84	USGS Report #84-4319
West Stanislaus RCD	7A	EC, temperature, flow	monthly (May-Oct)	9/78, 6/79- Present	WSRCD Files
CVRWQCB	Newman WWTP	BOD, coliform	monthly		CVRWQCB Files
CVRWQCB	Newman WWTP	TDS	annually		CVRWQCB Files
CVRWQCB	STC 010 STC 014 STC 020	standard minerals, trace elements, Se, & suspended sediment	monthly	11/85- Present	CVRWQCB Files

(note that these samples are often taken on the pond effluent and not the discharge)

## SAN JOAQUIN RIVER DISCHARGE SITE

SITE ID# SJE 119.0D

Site Name: Flood Gates 1E-8E

River Mileage: 118.2-121.1

Site description, location and access: There are eight flood gates on the right bank levee of the San Joaquin River in this reach; they are designed to discharge surface runoff into the River during/after storms. They also have the potential to discharge irrigation tail water, but staff inspections have not detected such use.

Township/Range/Section: N/A

Latitude/Longitude: N/A

County: Merced

USGS Quad Map: Gustine

### WATER SOURCE

Type and source of water being discharged (description): Lower San Joaquin Levee District Unit No. 1 - Right Bank San Joaquin River.

<u>Site#</u>	<u>Levee Mileage (Miles South of River Road)</u>	<u>Site Description</u>
01E	0.00	24-inch CM pipe through the levee, 10.5 feet below the crown. Flap gate on the waterward end. Brass cap BM on headwall on the landward side. No. 108, elevation 65.1 feet, USGS Datum.
02E	0.35	36-inch CM pipe through the levee, 18.5 feet below the crown, flap gate on the waterward end.
03E	0.62	24-inch CM pipe through the levee, 8.5 feet below the crown, flap gate on the waterward end.
04E	0.88	24-inch CM pipe through the levee, 8.5 feet below the crown, flap gate on the waterward end.
05E	0.96	24-inch CM pipe through the levee, 9.0 feet below the crown. Flap gate on the waterward end.
06E	1.18	24-inch CM pipe through the levee, 7.5 feet below the crown. Flap gate on the waterward end.

San Joaquin River Discharge Site  
Flood Gates 1E-8E

-2-

<u>Site#</u>	<u>Levee Mileage (Miles South of River Road)</u>	<u>Site Description</u>
07E	1.35	36-inch CM pipe through the levee, 12.8 feet below the crown. Flap gate on the waterward end.
08E	1.48	24-inch CM pipe through the levee, 11.0 feet below the crown. Flap gate on the waterward end.

**Comments on factors affecting water quality and quantity at the site:** Discharge water should be of good quality as normal rainfall runoff.



SAN JOAQUIN RIVER DISCHARGE SITE

SITE ID# SJE 118.2D

Site Name: Merced River

River Mileage: 118.2

Site description, location and access: This site is immediately upstream (south) of the Hills Ferry Bridge. Access to the site is by boat.

Township/Range/Section: NW 1/4, SW 1/4, SW 1/4, Section 3, T7S, R9E  
(DWR# 7S/9E-3N)

Latitude/Longitude: Lat. 37° 20' 57"/Long. 120° 58' 28"

County: Stanislaus

USGS Quad Map: Gustine

WATER SOURCE

Type and source of water being discharged (description): Natural stream flow from the Sierras.

Comments on factors affecting water quality and quantity at the site: Discharge into the river and diversions from the river are likely to affect quality at this site. This river has flow monitoring information since 1940 and some quality measurements from a sampling station near Stevenson (DWR site# BD-5125) approximately 4 miles upgradient from the junction with the San Joaquin River. There are outtake pumps below the DWR site.

San Joaquin River Section #13

Hills Ferry Road Bridge to Crows Landing Road Bridge

# SAN JOAQUIN RIVER

## Section 13: Hills Ferry Road Bridge to Crows Landing Road Bridge

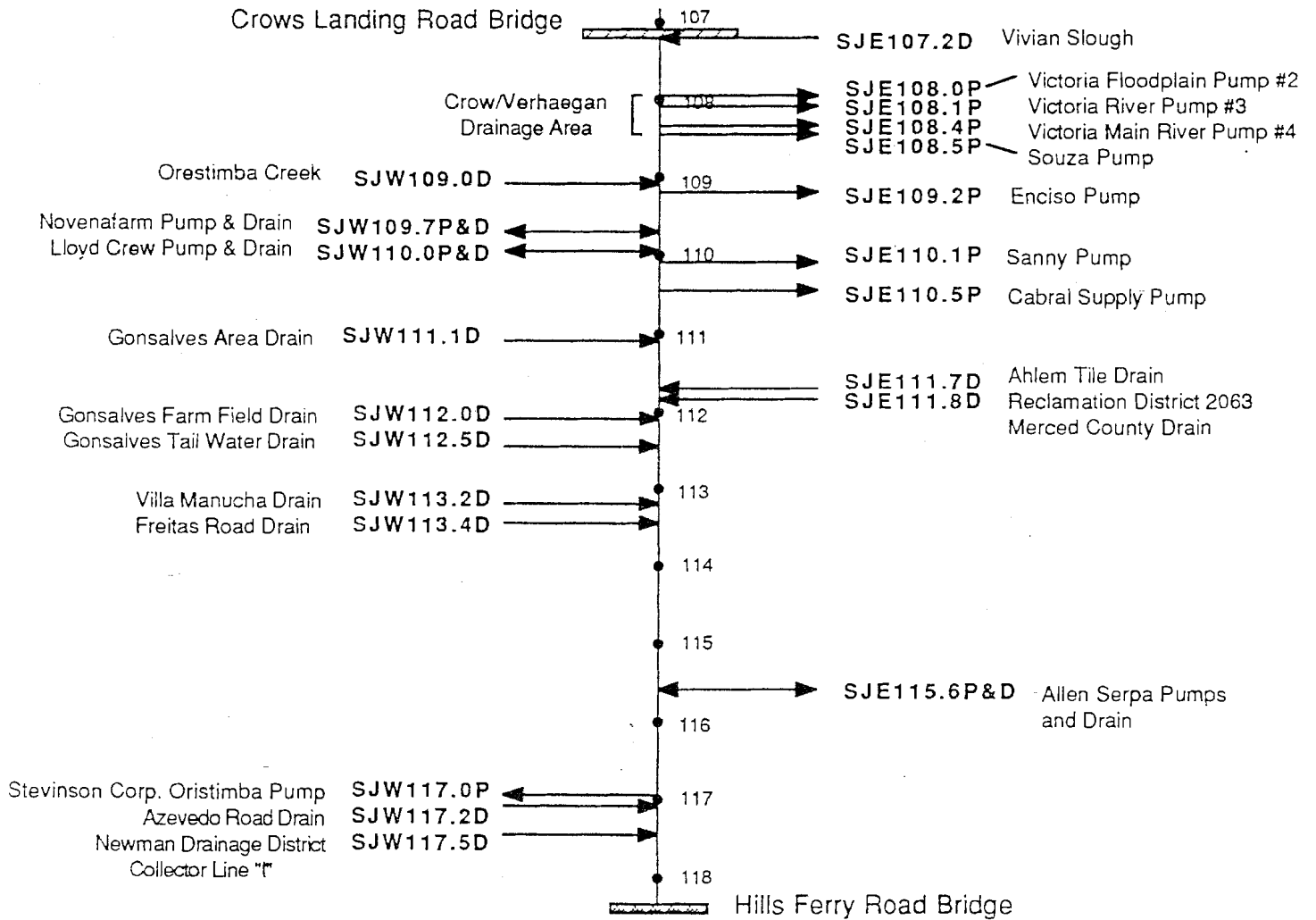

Figure A-13. Schematic Diagram for Water Diversions and Discharges on the San Joaquin River from Hills Ferry Road Bridge to Crows Landing Road Bridge (River Section 13).

## SAN JOAQUIN RIVER DISCHARGE SITE

SITE ID# SJW 117.5D

Site Name: Newman Drainage District  
Collector Line "1"

River Mileage: 117.5

**Site description, location and access:** Newman Drainage District Collector Line "1" discharges directly into the San Joaquin River at Mile 117.5. The discharge is approximately 1/4 mile east of River Road and 0.6 miles north of Hills Ferry Road. Access to the sampling point is through the trailer park on the east side of River Road. Check with the owner to be sure he understands that you need access. The discharge pipe into the river is readily accessible for sampling except during periods of high flow in the San Joaquin River.

**Township/Range/Section:** NE 1/4, SE 1/4, NE 1/4, Section 4, T7S, R9E  
(DWR# 7S/9E-4H)

**Latitude/Longitude:** Lat. 37° 21' 27"/Long. 120° 58' 42"

**County:** Stanislaus

**USGS Quad Map:** Gustine

### WATER SOURCE

**Type and source of water being discharged (description):** The discharge from the Newman Drainage District Collector Line "1" carries only subsurface drainage flow from approximately 2450 acres of irrigated land that is located north of Hills Ferry Road, east of Villa Manucha Road, south of Freitas Road and West of River Road (see attached map). The irrigated area immediately to the south is also drained, therefore little influence would be expected from this outlying area. Some influence from outlying areas may occur around the remainder of the district, but the collection system is so extensive, the greatest influence is still the collection system.

There are 93 acres of on-farm tile drainage within this portion of the Newman Drainage District. It was installed in 1979 and none is projected to be installed because the collection system maintains the ground water table levels. The quality discharging from the collection system would represent shallow ground water quality in the area. During any water quality evaluation, the water quality data from this area could be compared with that from the Newman Drainage District Collector Line A (Site #STC 010).

The quality of the discharge is representative of shallow ground water quality in this entire area up to Orestimba Creek, however, there is little likelihood that subsurface drainage will be installed in the area between Villa Manucha Road and Orestimba Creek as natural drainage to the creek and the San Joaquin River is likely to keep the shallow ground water table low enough to allow economical crop production; this is in part because of the low salt content of the drainage water thus allowing a higher level of tolerance to high ground water conditions that may exist for short periods during the growing season.

**Comments on factors affecting water quality and quantity at the site:** During river flood stages, the outlet is frequently under water thus backing up water into the collection system otherwise freeflow into the river occurs. Water

quality at this discharge is likely to be similar in characteristics to the Line A discharge which is 1.5 miles upstream. The collection system is entirely closed, therefore no other input can enter the system other than those illegally poured down one of the periodic manholes.

**Several sources of data are available:**

1. The West Stanislaus Resource Conservation District, 218 North El Circulo, Patterson, CA has been measuring temperature, flow, and salinity(EC) from Line "I" since it was installed in 1978. Monthly measurements are taken, however, the data needs to be checked for completeness and accuracy as often the measurements are only taken during the summer irrigation season (June-Sept). The data from this site could be combined with the data from Newman Drainage District Line A (Site STC 010) as both drain similar areas with similar agricultural practices.
2. The United States Bureau of Reclamation, 2800 Cottage Way, Sacramento, CA samples this site as part of their continuous monitoring of tile drainage on the West side of the San Joaquin Valley. They have sampled this site monthly since August 1982 for standard minerals, trace elements, the nutrients. The data is stored in STORET as USBR Site # DSA 03B. The data in STORET is current within a year or two while the remainder of the data is stored on a microcomputer at the USBR HQ in Sacramento. The sampling point for the USBR is different from that used by the Regional Board, however, the data can be analyzed together with Regional Board data as the sampling site is less than 1/4 mile upstream from the Regional Board's site and there are no additional inputs between these two points. The USBR site is often used by the Regional Board when river flows prevent access to the discharge pipe into the river.
3. The United States Geological Survey sampled this site in May 1984 for standard minerals and trace elements. Their results are reported for USGS Report #84-4319 as site 3B. This site is the same as used by the U.S. Bureau of Reclamation and the data should be comparable as described in #2 above.

## SAN JOAQUIN RIVER DISCHARGE SITE

SITE ID# SJW 117.2D

Site Name: Azevedo Road Drain

River Mileage: 117.2

**Site description, location and access:** The Azevedo Road Drain flows under River Road immediately south of Azevedo Road and discharges into the San Joaquin River at Mile 117.2. The sampling site is at the River Road Crossing. Access to the drain is off River Road. However it is not possible to reach the point where it discharges to the river. Often the discharge flows into old channels of the river and seeps into the river. The surface water carried by the drain exits the cropped area at or near the boundary of the Newman Drainage District. The drainage then proceeds through a pasture area before exiting the area under River Road.

**Township/Range/Section:** NW 1/4, SW 1/4, SE 1/4, Section 33, T6S, R9E (DWR# 6S/9E-33Q)

**Latitude/Longitude:** Lat. 37° 21' 50"/Long. 120° 58' 48"

County: Stanislaus

USGS Quad Map: Gustine

### WATER SOURCE

**Type and source of water being discharged (description):** The discharge is composed entirely of surface runoff and irrigation tail water from approximately 2830 acres of agricultural lands. No tile drainage or other subsurface drainage enters this system as the entire area is part of the Newman Drainage District. Operation spill water from Central California Irrigation District canals occasionally enters the drain. This drainage area is bounded on the West by the Central California Irrigation District Main Canal and on the south approximately by Stuhr and Hills Ferry Roads (see map 1a). This drain is monitored as Site# 015. The sources of irrigation water to this area are the Central California Irrigation District Main Canal and possible on-farm irrigation wells.

**Comments on factors affecting water quality and quantity at the site:** Flow and quality at this site will depend upon the cropping pattern in the area. The quality is likely to reflect the influence of surface runoff rather than agricultural subsurface drainage water. The surface flows move through an unirrigated area that has considerable pasture lands and this may influence the quality.

### MONITORING

Previous or ongoing monitoring at the site:

<u>Agency</u>	<u>Site ID#</u>	<u>Constituents</u>	<u>Frequency</u>	<u>Period of Record</u>	<u>Data Storage</u>
CVRWQCB	STC 015	trace elements, standard min., selenium, and suspended sediment	monthly	10/85- present	CVRWQCB Files
West Stanislaus RCD	9	Flow, EC, and temp.	monthly (May-Sept)	8/72 present	WSRCD Files

## SAN JOAQUIN RIVER DIVERSION SITE

SITE ID # SJW 117.0 P

Site Name: Stevinson Corporation Orestimba  
Pump

River Mileage: 117.0

**Site description, location and access:** Site is located along the western bank of the San Joaquin River at the southern end of the irrigated area east of River Road. The site is approximately 500 feet east of River Road on the appropriate alignment of Azevedo Road. Access to the site is via a farm Road east off of River Road.

**Township/Range/Section:** NW 1/4, SW 1/4, SE 1/4, Section 33, T6S, R9E,  
(DWR # 6S/9E-33Q)

**Latitude/Longitude:** Lat. 37° 21' 51"/Long. 120° 58' 49"

County: Stanislaus

USGS Quad Map: Gustine

**Type of diversion and use of the water:** San Joaquin River water is diverted for irrigation use on 180 acres of irrigated crops between River Road and the San Joaquin River and north of the alignment of Azevedo Road. Principle crops are corn and alfalfa.

Pump size: 40hp

## SAN JOAQUIN RIVER DISCHARGE SITE

SITE ID# SJE 115.6D

Site Name: Allen Serpa Drain

River Mileage: 115.6

**Site description, location and access:** This is a tailwater drain that is located along the eastern project levee, 0.2 miles north of the intersection of Turner Avenue and Central Avenue and 0.75 miles west of Central Avenue. Access to the site is via a farm road west off of Central Avenue and 0.25 miles north of Turner Road intersection. Proceed 0.75 miles west then turn south along the project levee approximately 0.15 miles (500 feet south of the Allen Serpa Pumps).

**Township/Range/Section:** SE 1/4, NW 1/4, NW 1/4, Section 34, T6S, R9E  
(DWR# 6S/9E-34D)

**Latitude/Longitude:** Lat. 37° 22' 23"/Long. 121 58' 22"

County: Merced

USGS Quad Map: Gustine

### WATER SOURCE

**Type and source of water being discharged (description):** Tailwater from 290 acres of irrigated land along the river. Discharge does not enter the river directly as it ponds in the trees and seeps to the river or by direct overflow.

**Comments on factors affecting water quality and quantity at the site:** May be high in sediment depending on the crops being grown.



**SAN JOAQUIN RIVER DIVERSION SITE**

**SITE ID # SJE 115.6 P**

**Site Name:** Allen Serpa Pumps

**River Mileage:** 115.6

**Site description, location and access:** Two diversion pumps are at one site located along the eastern project levee, 0.2 miles north of the intersection of Turner Avenue and Central Avenue and 0.75 miles west of Central Avenue. Access to the site is via a farm road west off of Central Avenue and 0.25 miles north of Turner Road intersection. Proceed 0.75 miles west then turn 0.1 miles south along the project levee.

**Township/Range/Section:** SE 1/4, NW 1/4, NW 1/4, Section 34, T6S, R9E,  
(DWR # 6S/9E-34D)

**Latitude/Longitude:** Lat. 37° 22' 25"/Long. 121° 58' 22"

**County:** Merced

**USGS Quad Map:** Gustine

**Type of diversion and use of the water:** San Joaquin River Water is diverted for irrigation of 450 acres of alfalfa, corn, oats.

**Water Right Permit Number:** No #  
    **Pump #1 Size:** 20hp  
    **Pump #2 Size:** 40hp

## SAN JOAQUIN RIVER DISCHARGE SITE

SITE ID# SJW 113.4D

Site Name: Freitas Road Drains

River Mileage: 113.4

**Site description, location and access:** There are three drains that flow into a slough and discharge at mile 113.4. Access to the mile 113.4 discharge is not possible. The three drains are:

1. **Freitas Road Drain at River Road:** This tail water drain flows under River Road at Freitas Road and discharges into the San Joaquin River at Mile 113.4. The sampling site is at the River Road crossing. Access to the sampling site is off River Road. Sample on the east side of the Road because of two incoming small drains on the west side of River Road. The Freitas Road drainage area consists of approximately 1930 acres. This area is bounded on the south by Freitas Road, on the north by Villa Manucha Road, and on the west by the Central California Main Canal (see map 1a). This drain is monitored as Site# STC017.
2. **Tail water Drain 1/2 Mile South of Freitas Road at River Road:** This tail water drain flows under River Road 1/2 mile south of Freitas Road and discharges into the San Joaquin River at Mile 113.4. The sampling site is at the River Road Crossing. Access to the sampling site is off River Road. This drainage area consists of approximately 700 acres bounded on the north by Freitas Road, on the west by Villa Manucha Road, and on the south by this drain (see map 1a). This drain is monitored as Site# STC016.
3. **Tail water Drain, Stevinson Corporation:** This drain carries tail water from 400 acres of the Stevinson Corporation Orestimba Ranch. This area is located on the floodplain east of River Road. There are a series of sloughs in this area which may receive a large portion of this area's drainage.

**Township/Range/Section:** NE 1/4, NW 1/4, SW 1/4, Section 28, T6S, R9E  
(DWR# 6S/9E-28M)

**Latitude/Longitude:** Lat. 37° 23' 01"/Long. 120° 59' 33"

**County:** Stanislaus

**USGS Quad Map:** Hatch, CA

### WATER SOURCE

**Type and source of water being discharged (description):** The discharge is composed entirely of surface runoff and irrigation tail water from approximately 3000 acres of agricultural lands north of Lundy Road and north and south of Freitas Road. No tile drainage or other subsurface drainage water enters this system as the entire area is part of the Newman Drainage District. This system carries a substantial portion of operation spill water from the CCID canals. The sources of irrigation water to this area are the Central California Irrigation District Main Canal and possibly on-far# irrigation wells. There is a diversion pump on the San Joaquin River at mile 117.0 which supplies irrigation water to the Stevinson Corporation Orestimba Ranch area.

**Comments on factors affecting water quality and quantity at the site:** The flows in these drains will be influenced by surface runoff and tail water from the irrigated lands and also from the amount of operational spill water that enters the system.

## SAN JOAQUIN RIVER DISCHARGE SITE

SITE ID# SJW 113.2D

Site Name: Villa Manucha Drain

River Mileage: 113.2

**Site description, location and access:** This surface runoff drain flows under River Road at Villa Manucha Road and discharges into a slough that leads to the San Joaquin River. The sampling site is at the River Road crossing because of access. Sample on the east side of the Road because of access and other drains entering the system immediately to the West of River Road.

**Township/Range/Section:** NW 1/4, SW 1/4, NW 1/4, Section 28, T6S, R9E  
(DWR# 6S/9E-28E)

**Latitude/Longitude:** Lat. 37° 23' 12"/Long. 120° 59' 36"

**County:** Stanislaus

**USGS Quad Map:** Hatch, CA

### WATER SOURCE

**Type and source of water being discharged (description):** This discharge is composed entirely of surface runoff from approximately 15 acres adjacent to Villa Manucha Road. There may be some tail water that enters this drain, but none was observed in the field survey. No tile drainage is known to enter this system.

**Comments on factors affecting water quality and quantity at the site:** The flow and quality of this drain is influenced by surface runoff. The ground water would not be expected to influence this site as most ground water seepage would be toward Crestimba Creek and the San Joaquin River. No known areas of high water tables have been recorded in the area. This is a small drain and no known Monitoring of this site has occurred.

## SAN JOAQUIN RIVER DISCHARGE SITE

SITE ID# SJW 112.5D

Site Name: Gonsalves Tail Water Drain

River Mileage: 112.5

**Site description, location and access:** This site receives tail water from a 14-acre area on the Gonsalves Farm. The area is located approximately 1.9 miles south of Orestimba Creek on the east side of River Road. Access to the site is via the same farm road as Site# SJW112.0D. This farm road is located approximately 0.1 miles north of Villa Manucha Road (just north of a blue shop building). Go east on this road toward the river. This drain goes through the levee just before this road goes up onto the levee (see map 1a).

**Township/Range/Section:** SW 1/4, NE 1/4, SW 1/4, Sec. 21, T6S, R9E  
(DWR# 6S/9E-21L)

**Latitude/Longitude:** Lat. 37° 23' 43"/Long. 120° 59' 03"

**County:** Stanislaus

**USGS Quad Map:** Hatch, CA

### WATER SOURCE

**Type and source of water being discharged (description):** Tail water from approximately 14 acres of row crops. No tile drainage. The sources of irrigation water to this area are the Central California Irrigation District Main Canal and on-farm irrigation wells (see map 1b).

**Comments on factors affecting water quality and quantity at the site:** The flow to this drain is dependent on the amount of irrigation to this 14-acre area. This drain may carry a high sediment load.

## SAN JOAQUIN RIVER DISCHARGE SITE

SITE ID# SJW 112.0D

Site Name: Gonsalves Farms Field Drain

River Mileage: 112.0

**Site description, location and access:** This site is located northeast of the Villa Manucha-River Road intersection (see map 1a). The site is accessed via a farm road just north of Villa Manucha Road. There is a blue building on the east side of River Road just north of the Villa Manucha Road. Just north of this building (shop) is the farm road to this drain. Follow the road to the river. This discharge pipe goes through the levee in the middle of the meander (see map 1a).

**Township/Range/Section:** NW 1/4, SW 1/4, NE 1/4, Sec. 21, T6S, R9E  
(DWR# 6S/9E-21G)

**Latitude/Longitude:** Lat. 37° 24' 02"/Long. 120° 59' 03"

County: Stanislaus

USGS Quad Map: Hatch, CA

### WATER SOURCE

**Type and source of water being discharged (description):** Tail water from a 100-acre irrigated field adjacent to the San Joaquin River. There are no known tile drainage systems in this area. The sources of irrigation water to this area are the Central California Irrigation District Main Canal and on-farm irrigation wells (see map 1b).

**Comments on factors affecting water quality and quantity at the site:** The flow to this drain depends on the amount of irrigation to this 100-acre area. The drainage water is expected to carry a high sediment load.

## SAN JOAQUIN RIVER DISCHARGE SITE

SITE ID# SJE 111.8D

Site Name: Reclamation District No. 2063  
Merced County Drain

River Mileage: 111..

**Site description, location and access:** This discharge consists of flow that originates in Turlock Irrigation District including the Stadtler Drain, the Hilmar Drain and several other smaller drains entering from the southeast portion of Turlock Irrigation District. There are two drains that meet at the Stadtler Drain Pumps and then flow north along the levee and discharges to the San Joaquin River at mile 111.8. Access to the site is via the eastern project levee at Crows Landing Road or off of August Road.

**Township/Range/Section:** SW 1/4, NW 1/4, NE 1/4, Section 21, T6S, R9E  
(DWR# 6S/9E-21B)

**Latitude/Longitude:** Lat. 37° 24' 09"/Long. 120° 58' 53"

**County:** Stanislaus

**USGS Quad Map:** Hatch, CA

### WATER SOURCE

**Type and source of water being discharged (description):** The discharge consists of water from 3 principle drainage systems:

1. **Stadtler Drain:** This drain carries tailwater and operational spill water from within Turlock Irrigation District and land immediately adjacent to the river. In addition, the Ahlem Ranch discharges tile drainage from approximately 25 acres of land into this drain. The tile drainage discharge occurs near the pumping station at the levee. The drain gravity flows into the San Joaquin River during low flow periods while at high flows, it is pumped out by 2-30hp pumps. Turlock Irrigation District helps maintain the drain but the pump ownership and operation are those of Reclamation District 2063.
2. **Hilmar Drain:** This drain carries tailwater from that portion of Turlock Irrigation District that lie adjacent to Williams Avenue. There are no known tile drainage discharges within this area. The flow moves along Williams Avenue and then flows on the river side of the levee after it begins near Central Avenue. Operational spill from the Turlock Irrigation District also enters the system.
3. **Southern Drain:** This drain carries tailwater and operational spill water from irrigated areas in the vicinity of Central Avenue and Turner Road.

**Comments on factors affecting water quality and quantity at the site:** Water quality at the site will be dependent upon the proportion of each drainage system that is entering the drains.

## SAN JOAQUIN RIVER DISCHARGE SITE

SITE ID# SJE 111.7D

Site Name: Ahlem Tile Drain

River Mileage: 111.7

**Site description, location and access:** This tile drainage sump is located adjacent to the project levee and the discharge is piped under the levee. This sump receives drainage from 105 acres of irrigated land immediately adjacent to the San Joaquin River. Access to the site is via the project levee from Crows Landing Road. The discharge sump is bright yellow and sits on the north side of a slough which does not discharge to the river.

**Township/Range/Section:** NE 1/4, NE 1/4, NW 1/4, Section 21, T6S, R9E  
(DWR# 6S/9E-21C)

**Latitude/Longitude:** Lat. 37° 24' 13"/Long. 120° 59' 09"

County: Stanislaus

USGS Quad Map: Hatch, CA

### WATER SOURCE

**Type and source of water being discharged (description):** Tile drainage water from 105 acres of irrigated land adjacent to the river.

**Comments on factors affecting water quality and quantity at the site:** Quality is expected to be degraded from that of surface water quality.

## SAN JOAQUIN RIVER DISCHARGE SITE

SITE ID# SJW 111.1D

Site Name: Gonsalves Area Drain

River Mileage: 111.1

**Site description, location and access:** This site is a tail water drain for an area south of Orestimba Creek. This underground pipe line goes through the levee and discharges to the San Joaquin River at River Mile 111.1. The site is located approximately 1.4 miles south of Orestimba Creek and 0.7 miles east of River Road. Access to the site is via a dirt farm road east off of River Road. This farm road is located approximately 0.6 miles north of Villa Manucha Road. There is a large concrete irrigation divider box on the east side of River Road at this River Road-farm road intersection. This concrete structure is a good land mark. Follow this farm road toward the river. The discharge point is approximately 50 yards south of the road at the levee.

**Township/Range/Section:** SE 1/4, NE 1/4, NE 1/4, Sec.20, T6S, R9E  
(DWR#65/9E-20A)

**Latitude/Longitude:** Lat. 37° 24' 09"/Long. 120° 59' 43"

**County:** Stanislaus

**USGS Quad Map:** Hatch, CA

### WATER SOURCE

**Type and source of water being discharged (description):** Tail water from approximately 2190 acres of irrigated farm land and operational spill water from the Central California Irrigation District Main Canal. The sources of irrigation water are the CCID Main Canal and on-farm irrigation wells (see map 1b). Tail water upslope is discharged to supply lateral #31 to be reused downslope.

**Comments on factors affecting water quality and quantity at the site:** The water quality depends on the supply water quality. This drain is expected to carry a heavy sediment load.

**Discharge Ownership and Operation:** Common drain-no ownership

### MONITORING

**Previous or ongoing monitoring at the site:**

<u>Agency</u>	<u>Site ID#</u>	<u>Constituents</u>	<u>Frequency</u>	<u>Period of Record</u>	<u>Data Storage</u>
CVRWQCB	STC 052	trace elements, standard minerals, selenium, and suspended sediments	monthly	11/86- present	CVRWQCB Files



SAN JOAQUIN RIVER DIVERSION SITE

SITE ID # SJE 110.5 P

Site Name: Cabral Supply Pump

River Mileage: 110.5

Site description, location and access: Bright yellow diversion pump located along the eastern project levee, 0.75 miles south of August Road and 1.8 miles west of Central Avenue. Access to the site is via the project levee.

Township/Range/Section: SE 1/4, NW 1/4, SW 1/4, Section 16, T6S, R9E,  
(DWR # 6S/9E-16M)

Latitude/Longitude: Lat. 37° 24' 33"/Long. 120° 59' 29"

County: Stanislaus

USGS Quad Map: Hatch, CA

Type of diversion and use of the water: River water is diverted for use on 159 acres of pasture.

Pump size: 40hp pump

SAN JOAQUIN RIVER DIVERSION SITE

SITE ID # SJE 110.1 P

Site Name: Sanny Pump

River Mileage: 110.1

Site description, location and access: Irrigation diversion pump which sits on interior side of the levee. The small portable diversion pump lays flat on the side of the levee with a discharge pipe through the levee. The pump is located on the eastern bank project levee 0.6 miles south of the intersection of August Road and Hogin Road and 0.25 miles west of the alignment of Hogin Road. Access to the site is via the project levee.

Township/Range/Section: NW 1/4, NE 1/4, SE 1/4, Section 17, T6S, R9E,  
(DWR # 6S/9E-17J)

Latitude/Longitude: Lat. 37° 24' 39"/Long. 120° 59' 49"

County: Stanislaus

USGS Quad Map: Hatch, CA

Type of diversion and use of the water: This 14hp pump is used to divert water for irrigation of 95 acres of corn and oats immediately adjacent to the levee.

Pump size: 14hp pump

**SAN JOAQUIN RIVER DIVERSION SITE**

SITE ID # SJW 110.0 P

Site Name: Lloyd Crow Pump

River Mileage: 110.0

Site description, location and access: Site is located 0.8 miles east of River Road in the approximate alignment of L.B. Crow Road. Access is via a farm road from River Road. Check at the farm house.

Township/Range/Section: SE 1/4, NW 1/4, SE 1/4, Section 17, T6S, R9E,  
(DWR # 6S/9E-17K)

Latitude/Longitude: Lat. 37° 24' 38"/Long. 120° 59' 58"

County: Stanislaus

USGS Quad Map: Hatch, CA

Type of diversion and use of the water: Pump is not presently used because of poor river water quality. Use was discontinued 4 years ago. Originally used to irrigate 200 acres of alfalfa and pasture.

Water Right Permit Number: 6393

1.2 cfs (12 months)

Pump size: 35hp (2300 gpm)

## SAN JOAQUIN RIVER DISCHARGE SITE

SITE ID# SJW 110.0D

Site Name: Lloyd Crow Drain

River Mileage: 110.0

**Site description, location and access:** The site is located south of Orestimba Creek and east of River Road. This tail water drain is approximately 50 feet north of the Lloyd Crow Diversion Pump (Site# SJW 110.OP). Access to the site is via River Road to dirt farm road located approximately 1.1 miles south of Orestimba Creek. This farm road is on the south side of a fence and an open ditch. Follow this road east. The road will make a sharp turn south. This drain is located at this sharp turn on the east side of the road.

**Township/Range/Section:** SE 1/4, NW 1/4, SE 1/4, Section 17, T6S, R9E  
(DWR# 6S/9E-17K)

**Latitude/Longitude:** Lat. 37° 24' 38"/Long. 120° 59' 59"

County: Stanislaus

USGS Quad Map: Hatch, CA

### WATER SOURCE

**Type and source of water being discharged (description):** Irrigation tailwater from approximately 200 acres of irrigated row crops. This drainage area receives irrigation water from the Central California Main Canal and the Lloyd Crow Diversion Pump (see map 1b).

**Comments on factors affecting water quality and quantity at the site:** Discharge is likely to carry high sediment loads.

**SAN JOAQUIN RIVER DIVERSION SITE**

**SITE ID#** SJW 109.7P

**Site Name:** Novenafarm Pump

**River Mileage:** 109.7

**Site description, location and access:** This site is located 0.2 miles east of River Road and 0.2 miles south of Orestimba Creek. The diversion consists of a single pump (yellow) into a closed distribution system. Access to the site is via River Road; turn east on a farm road that meets River Road approximately 0.2 miles south of Orestimba Creek. Site is 0.2 miles east of River Road approximately 250 south of site SJW 109.7D.

**Township/Range/Section:** SW 1/4, SW 1/4, NE 1/4, Section 17, T6S, R9E  
(DWR# 6S/9E-17G)

**Latitude/Longitude:** Lat. 37° 24' 48"/Long. 121° 00' 07"

**County:** Stanislaus

**USGS Quad Map:** Crows Landing, CA

**Type of diversion and use of the water:** San Joaquin River water diverted to use on 210 irrigated acres of row crops including beans, spinach and others.

**Water Right Permit Number:** Oscar & Irene Heard #13555 (4.0 cfs - 11 mos)  
Pump size: 60hp 1090 Carpendes  
(can pump 9cfs) Modesto, CA 95313

## SAN JOAQUIN RIVER DISCHARGE SITE

SITE ID# SJW 109.7D

Site Name: Novenafarm Drain

River Mileage: 109.7

**Site description, location and access:** This site is a tail water drain for an area south of Orestimba Creek and east of Highway 33. The area is long and slender, trending east-west parallel to J.D. Crow Road (see map Ia). The tail water is collected along the eastern boundary of the irrigated area and discharges just north of the Novenafarm Pumps. Access to the site is via River Road; turn east on a farm road that meets River Road approximately 0.2 miles south of Orestimba Creek. Site is 0.2 miles east of River Road.

**Township/Range/Section:** SW 1/4, SW 1/4, NE 1/4, Section 17, T6S, R9E  
(DWR# 6S/9E-17G)

**Latitude/Longitude:** Lat. 37° 24' 51"/Long. 121° 00' 06"

**County:** Stanislaus

**USGS Quad Map:** Crows Landing, CA

### WATER SOURCE

**Type and source of water being discharged (description):** Tail water from approximately 1020 acres of irrigated farmland. There are no known tile drainage systems in this drainage area. The sources of irrigation water are the Central California Irrigation District Main Canal, the Novenafarm Diversion Pump (Site# SJW109.7P), and possibly on-farm irrigation wells (see map Ib). Farms upslope discharge tail water to the supply lateral H-14 to be reused downslope.

**Comments on factors affecting water quality and quantity at the site:** Quality will reflect the irrigation source water but will carry high sediment.

## SAN JOAQUIN RIVER DIVERSION SITE

SITE ID # SJE 109.2 P

Site Name: Enciso Pump

River Mileage: 109.2

Site description, location and access: Irrigation diversion pump which sits on the floodplain of the river. This small diversion pump is located in the floodplain of the eastern bank project levee, 0.25 miles west of the intersection of August Road and Hogin Road. Owner pulls the pump motor if the river comes up.

Township/Range/Section: NW 1/4, NE 1/4, NE 1/4, Section 17, T6S, R9E,  
(DWR # 6S/9E-17A)

Latitude/Longitude: Lat. 37° 25' 09"/Long. 121° 59' 52"

County: Stanislaus

USGS Quad Map: Hatch, CA

Type of diversion and use of the water: River water diverted for irrigation of 90 acres of alfalfa and beans.

Water Right Permit Number:

Pump size is: 30 Hp

## SAN JOAQUIN RIVER DISCHARGE SITE

SITE ID# SJW 109.0D

Site Name: Orestimba Creek

River Mileage: 109.0

**Site description, location and access:** Orestimba Creek discharges into the San Joaquin River 0.9 miles due south of the Crows Landing Bridge. The discharge is by gravity flow. Access to the discharge point is very difficult because of riparian growth. The best access point is at River Road approximately 1.0 miles upstream of its discharge point. Orestimba Creek at River Road gives good access to the creek and represents runoff water quality just prior to its entrance to the San Joaquin River at Mile 109.0. The best sampling point is between the two bridges with vehicle parking available on the old bridge. This monitoring site is Site# STC019.

**Township/Range/Section:** SW 1/4, SW 1/4, SE 1/4, Section 8, T6S, R9E  
(DWR# 6S/9E-8Q)

**Latitude/Longitude:** Lat. 37° 25' 20"/Long. 121° 00' 09"

**County:** Stanislaus

**USGS Quad Map:** Crows Landing, CA

### WATER SOURCE

**Type and source of water being discharged (description):** The water in Orestimba Creek consists of both natural surface flow from Orestimba Creek, Crow Creek and runoff, tail water and operational spills from irrigated lands. The quantity of each in the creek will vary during the year depending upon the intensity of irrigation in the area. There are no known discharges of tile drainage water directly into the creek, however, seepage into the creek is likely. Orestimba Creek receives drainage water from approximately 6560 acres of irrigated land on the east side of the Delta Mendota Canal alone (see map 1a). The sources of irrigation water to this drainage area are the Delta Mendota Canal, the Central California Irrigation District Main Canal, Orestimba Creek, and on-farm irrigation wells (see map 1b).

**Comments on factors affecting water quality and quantity at the site:** Orestimba Creek carries runoff water from both natural runoff and from irrigated agriculture. It is also likely that the deep entrenchment of the creek in its lower reaches near the San Joaquin causes seepage of ground water into the creek in several reaches. The exact contribution from each factor is difficult to determine.

### MONITORING

Previous or on-going monitoring at the site:

<u>Agency</u>	<u>Site ID#</u>	<u>Constituents</u>	<u>Frequency</u>	<u>Period of Record</u>	<u>Data Storage</u>
CVRWQCB	STC 019	metals, minerals, Se, and suspended sediment	monthly	10-85-present	CVRWQCB Files
West Stanislaus RCD	12	EC	monthly (May-Sept)	1978-present	WSRCD Files



## SAN JOAQUIN RIVER DIVERSION SITE

SITE ID # SJE 108.5 P

Site Name: Souza Pump

River Mileage: 108.5

**Site description, location and access:** Irrigation pump located on the eastern levee of the San Joaquin River approximately 0.5 miles north of August Road and 0.25 miles west of Hogin Road. Access to the site is via the eastern project levee at Crows Landing Road or via a farm road off of Hogin Road approximately 0.75 miles south of the intersection of Hogin Road and Ehrlich Road. Pump is a yellow-orange color. There are two pumps at this location.

**Township/Range/Section:** SE 1/4, SW 1/4, NE 1/4, Section 8, T6S, R9E,  
(DWR # 6S/9E-8G)

**Latitude/Longitude:** Lat. 37° 25' 38"/Long. 120° 59' 54"

County: Stanislaus

USGS Quad Map: Hatch, CA

**Type of diversion and use of the water:** Irrigation water diverted for use on 350 acres of corn and oats.

**Water Right Permit Number:** not found

Pump #1 size is: 30 hp

Pump #2 size is: 15 hp

**SAN JOAQUIN RIVER DIVERSION SITE**

SITE ID # SJE 108.4P

Site Name: Victoria Main River Pump #4

River Mileage: 108.4

Site description, location and access: Site is located 0.8 miles upstream from the Crows Landing Bridge along the eastern project levee. Access is via the southeast project levee from the Crows Landing Bridge. Pumped water flows into a concrete distribution box on the interior side of the levee.

Township/Range/Section: NW 1/4, SW 1/4, NE 1/4, Section 8, T6S, R9E,  
(DWR # 6S/8E-8G)

Latitude/Longitude: Lat. 37° 25' 46"/Long. 121° 00' 03"

County: Stanislaus

USGS Quad Map: Crows Landing, CA

Type of diversion and use of the water: River water is diverted for irrigation of 80 acres of corn and oats on the land between the river levee and Vivian Slough.

Water Right Permit Number: 15 hp pump

**SAN JOAQUIN RIVER DIVERSION SITE**

SITE ID # SJE 108.1 P

Site Name: Victoria River Pump #3

River Mileage: 108.1

Site description, location and access: Site is located 0.5 miles south of the Crows Landing Bridge along the eastern project levee. Access is via the project levee from the Crows Landing Bridge. Pump is located 0.1 mile upstream of another small pump (SJE 108.0P).

Township/Range/Section: NE 1/4, SE 1/4, NW 1/4, Section 8, T6S, R9E,  
(DWR # 6S/8E-8F)

Latitude/Longitude: Lat. 37° 25' 45"/Long. 121° 00' 12"

County: Stanislaus

USGS Quad Map: Crows Landing, CA

Type of diversion and use of the water: River water is diverted for irrigation of 22 acres of corn and oats on the landward side of the levee.

**SAN JOAQUIN RIVER DIVERSION SITE**

**SITE ID #** SJE 108.0 P

**Site Name:** Victoria Floodplain Pump #2

**River Mileage:** 108.0

**Site description, location and access:** Site is located 0.4 miles south of the #rows Landing Bridge along the eastern project levee. Access is via the project from Crows Landing Bridge. Pump is located within 500 ft. of another small pump.

**Township/Range/Section:** SW 1/4, SE 1/4, NW 1/4, Section 8, T6S, R9E,  
(DWR # 6S/8E-8F)

**Latitude/Longitude:** Lat. 37° 25' 50"/Long. 121° 00' 20"

**County:** Stanislaus

**USGS Quad Map:** Crows Landing, CA

**Type of diversion and use of the water:** Water is diverted for irrigation of 8 acres of corn and pasture on lands in the immediate flood plain of the river.

**Water Right Permit Number:** 6467

**Rights:** 0.35 cfs (1 Feb-1 Nov)

## SAN JOAQUIN RIVER DISCHARGE SITE

SITE ID# SJW 108.0D

Site Name: Crow/Verhaegan Drainage Area

River Mileage: 108.3-107.7

**Site description, location and access:** This drainage area is bounded on the north by Crows Landing Road, on the west by River Road, and on the south by Orestimba Creek. This area drains into the San Joaquin River between river miles 107.7 and 108.3 (see map Ia). Access to this drainage area is via River Road south from Crows Landing Road to Orestimba Creek. At Orestimba Creek, take the dirt farm road on the north bank toward the river. There are a few farm roads that intersect this road which may take you along the river bank.

Township/Range/Section: Section 8, T6S, R9E

Latitude/Longitude: N/A

County: Stanislaus

USGS Quad Map: Crows Landing, CA

### WATER SOURCE

**Type and source of water being discharged (description):** This drainage area discharges tail water to the San Joaquin River. There are no known tile drainage systems in this area. The area consists of approximately 310 acres of irrigated land. The sources of irrigation water are the Central California Irrigation District Main Canal, on-farm irrigation wells, and possibly Orestimba Creek. an abandoned 80 acre field located immediately south of the Kelner Ranch Drain and on the river flood plain side of the levee.

**Comments on factors affecting water quality and quantity at the site:** The water quality will reflect the irrigation source water.

## SAN JOAQUIN RIVER DISCHARGE SITE

SITE ID# SJE 107.2D

Site Name: Vivian Slough

River Mileage: 107.2

**Site description, location and access:** Discharge is either pumped during high river flows or is gravity during low flow periods. The pumping station consists of 3-30 hp pumps. The site is located 500 feet south of the Crows Landing Bridge along the eastern project levee. Access to the site is via the project levee at Crows Landing Road.

**Township/Range/Section:** SW 1/4, NW 1/4, NW 1/4, Section 8, T6S, R8E  
(DWR# 6S/8E-8D)

**Latitude/Longitude:** Lat. 37° 25' 53"/Long. 121° 00' 41"

**County:** Stanislaus

**USGS Quad Map:** Crows Landing

### WATER SOURCE

**Type and source of water being discharged (description):** Vivian Slough receives surface runoff and irrigation tail water from several thousand acres of irrigated land. In addition several surface drains from within Turlock Irrigation District spill into the Slough.

**Comments on factors affecting water quality and quantity at the site:** Water quality will depend upon the amount of operational spill water and irrigation tail water that finds its way into the system.

San Joaquin River Section #14

Crows Landing Road Bridge to Patterson Bridge

SAN JOAQUIN RIVER

Section 14: Crows Landing Road Bridge to Patterson Bridge

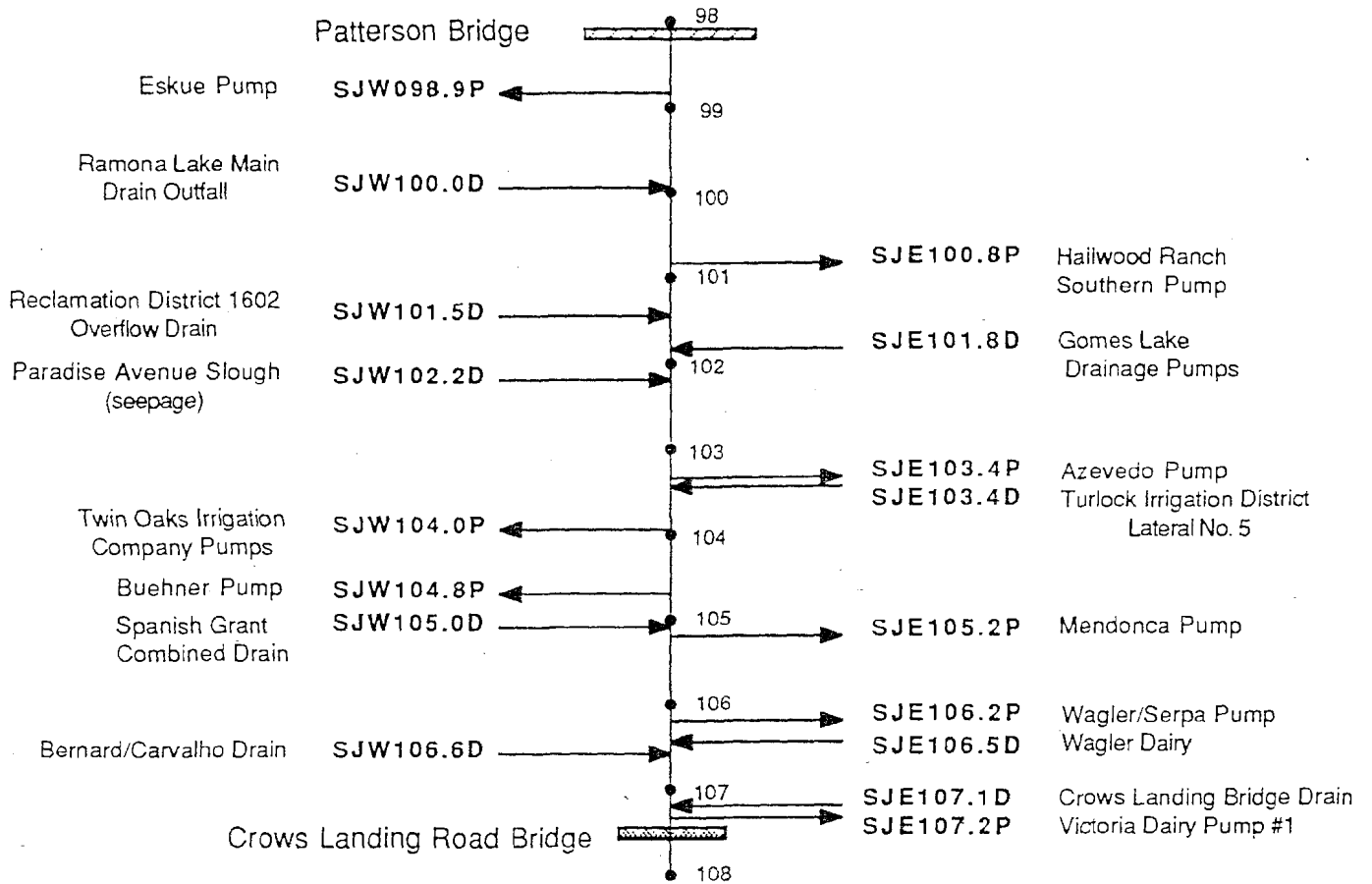

Figure A-14. Schematic Diagram for Water Diversions and Discharges on the San Joaquin River from Crows Landing Road Bridge to Patterson Bridge (River Section 14).



**SAN JOAQUIN RIVER DIVERSION SITE**

**SITE ID #** SJE 107.2 P

**Site Name:** Victoria Dairy Pump #1

**River Mileage:** 107.2

**Site description, location and access:** Pump is located 50 feet north of the Crows Landing Bridge. Access to the site is via the project levee.

**Township/Range/Section:** SE 1/4, NE 1/4, NE 1/4, Section 7, T6S, R9E  
(DWR# 6S/8E-7A)

**Latitude/Longitude:** Lat. 37° 25' 55"/Long. 121° 00' 44"

**County:** Stanislaus

**USGS Quad Map:** Crows Landing, CA

**Type of diversion and use of the water:** River water diverted for use on 210 acres of corn and oats on a field located on the south side of Crows Landing Road between Crows Landing Road and Vivian Slough.

**Meter Number:** not recorded during field survey

**Water Right Permit Number:** no #  
Pump is a 20hp pump

**SAN JOAQUIN RIVER DISCHARGE SITE**

SITE ID# SJE 107.1D

**Site Name:** Crows Landing Bridge Drain

**River Mileage:** 107.1

**Site description, location and access:** This is a flood relief drain in the eastern levee approximately 250 feet north of the Crows Landing Bridge. Access to the site is via the eastern bank project levee at the Crows Landing Bridge.

**Township/Range/Section:** SE 1/4, NE 1/4, NE 1/4, Section 7, T6S, R9E  
(DWR# 6S/8E-7A)

**Latitude/Longitude:** Lat. 37° 25' 57"/Long. 121° 02' 23"

**County:** Stanislaus

**USGS Quad Map:** Crows Landing, CA

**WATER SOURCE**

**Type and source of water being discharged (description):** Storm drainage, flood waters and irrigation tailwater.

SAN JOAQUIN RIVER DISCHARGE SITE

SITE ID# SJW 106.6D

Site Name: Bernard/Carvalho Drain

River Mileage: 106.6

Site description, location and access: This is a tail water gravity pipeline for 250 acres of land near the intersection of Marshall Road and Crows Landing Road. The buried pipeline serves land on both sides of Marshall Road north of Crows Landing Road (see attached schematic map). Access to the discharge site, which is a buried pipe in the river bank, is via Crows Landing Road north along the western levee for approximately 0.4 miles.

Township/Range/Section: NE 1/4, NE 1/4, NW 1/4, Section 7, T6S, R9E  
(DWR# 6S/8E-7C)

Latitude/Longitude: Lat. 37° 26' 00"/Long. 121° 01' 17"

County: Stanislaus

USGS Quad Map: Crows Landing, CA

WATER SOURCE

Type and source of water being discharged (description): Irrigation tailwater from approximately 250 acres of irrigated land. This site is monitored as Site# STC053.

Comments on factors affecting water quality and quantity at the site: Discharge water is likely to carry large quantities of sediment.

MONITORING

Previous or ongoing monitoring at the site:

<u>Agency</u>	<u>Site ID#</u>	<u>Constituents</u>	<u>Frequency</u>	<u>Period of Record</u>	<u>Data Storage</u>
CVRWQCB	STC 053	Standard minerals, trace elements, & selenium	monthly	6/86-present	CVRWQCB Files

**SAN JOAQUIN RIVER DISCHARGE SITE**

**SITE ID#** SJE 106.5D

**Site Name:** Wagler Dairy

**River Mileage:** 106.5

**Site description, location and access:** This is an illegal discharge of dairy waste over the levee through a steel pump under the levee and through a 4 inch plastic pipe over the levee. The discharge ponds on the exterior side of the levee. Access to the site is 0.4 miles north of the Crows Landing Bridge along the Eastern bank project levee.

**Township/Range/Section:** SE 1/4, SW 1/4, SE 1/4, Section 6, T6S, R9E  
(DWR# 6S/8E-6Q)

**Latitude/Longitude:** Lat. 37° 26' 09"/Long. 121° 01' 01"

**County:** Stanislaus

**USGS Quad Map:** Crows Landing, CA

**WATER SOURCE**

**Type and source of water being discharged (description):** Dairy wastewater including wash water and manure are discharged.

**Comments on factors affecting water quality and quantity at the site:** The discharge is likely to contain large amounts of organic matter, animal waste and high salts.

**SAN JOAQUIN RIVER DIVERSION SITE**

**SITE ID #** SJE 106.2 P

**Site Name:** Wagler/Serpa Pump

**River Mileage:** 106.2

**Site description, location and access:** Site is located along the project east bank levee approximately 0.6 miles north of the Crows Landing Bridge at Crows Landing Road. Access to the site is via the project levee on the eastern bank of the river.

**Township/Range/Section:** NE 1/4, SW 1/4, SE 1/4, Section 6, T6S, R9E  
(DWR# 6S/8E-6Q)

**Latitude/Longitude:** Lat. 37° 26' 13"/Long. 121° 01' 04"

**County:** Stanislaus

**USGS Quad Map:** Crows Landing, CA

**Type of diversion and use of the water:** Water from this pump is used to irrigate 250 acres of the Wagler property (130 acres is on the west side of the river and is not yet in irrigation) and 310 acres of the Serpa property. Cropping patterns on these lands are corn, alfalfa and pasture.

**Water Right Permit Number:** There are two pumps at this site. 50hp pump belongs to Manual Serpa and a 30hp pump that belongs to S. Victor Wagler.

**SAN JOAQUIN RIVER DIVERSION SITE**

SITE ID # SJE 105.2 P

Site Name: Mendonca Pump

River Mileage: 105.2

**Site description, location and access:** Site is located on the east bank of the river immediately west of Carpender Road where Turlock Irrigation District Lateral 5 1/2 meets Carpender Road. Access to the site is via Carpender Road along the project levee.

**Township/Range/Section:** SE 1/4, SW 1/4, SW 1/4, Section 31, T5S, R9E  
(DWR# 5S/8E-31N)

**Latitude/Longitude:** Lat. 37° 27' 04"/Long. 121° 01' 38"

County: Stanislaus

USGS Quad Map: Crows Landing, CA

**Type of diversion and use of the water:** Water is diverted for irrigation of field corn and alfalfa being grown on 250 acres.

**Meter Number:** not recorded in field survey

**Water Right Permit Number:** no #

## SAN JOAQUIN RIVER DISCHARGE SITE

SITE ID# SJW 105.0D

Site Name: Spanish Grant Combined Drain

River Mileage: 105.0

**Site description, location and access:** This combined drain outfall has three separate drains discharging into it# Spanish Grant' Marshall Road and Moran Road Drains. The outfall is located on the river side of the levee immediately east of the intersection of Marshal Road and River Road. Access to the site is through the abandoned dairy on River Road immediately south of Marshall Road. The three piped drains form a combined discharge into an open drain that discharges into the San Joaquin River after flowing in an old channel of the river for approximately 3/4 of a mile.

**Township/Range/Section:** NW 1/4, NE 1/4, NE 1/4, Section 1, T6S, R8E  
(DWR# 6S/8E-1A)

**Latitude/Longitude:** Lat. 37° 26' 38"/Long. 121° 02' 3"

**County:** Stanislaus

**USGS Quad Map:** Crows Landing, CA

### WATER SOURCE

**Type and source of water being discharged (description):** The discharge from all three individual piped drains is a combination of tile drainage and tail water/operational spill water. The tile drainage water comes from approximately 2800 acres of on-farm drainage mostly within the Spanish Grant Drainage District. The tailwater comes from drainage districts as far upslope as the California Aqueduct. The drainage area to this drain is approximately 9400 acres on the east side of the Delta Mendota Canal (see map 1a). This site is monitored as Site# STC 021. The sources of irrigation water to this drainage area are the Patterson Water District Laterals G, H, J, and K, the Central California Irrigation District Main Canal, the Delta-Mendota Canal, and on-farm irrigation wells.

**Comments on factors affecting water quality and quantity at the site:** The quality of the discharge will be influenced by the quantity of tile drainage that is entering the system. As the greatest quantity of water comes from tailwater from irrigated fields, there is likely to be a heavy sediment load in the water.

### MONITORING

Previous or ongoing monitoring at the site:

<u>Agency</u>	<u>Site ID#</u>	<u>Constituents</u>	<u>Frequency</u>	<u>Period of Record</u>	<u>Data Storage</u>
CVRWQCB	STC 021	Standard minerals, trace elements, Se, & suspended sediments	monthly	11/85-present	CVRWQCB Files
West Stanislaus RCD	16	EC & temperature	monthly (May-Sept)	6/78-present	WSRCD Files

## SAN JOAQUIN RIVER DIVERSION SITE

SITE ID # SJW 104.8 P

Site Name: Buehner Pump

River Mileage: 104.8

**Site description, location and access:** Site is located on the west bank of the San Joaquin River 500-700 feet downstream of the Spanish Grant Drain Outfall. Access to the site is via Marshall Road north onto the Project Levee. The pump was located here 25 years ago when a decision was made to located a new pump station for Twin Oaks Irrigation Company rather than build a pipeline from the main pumping station (SJW 104.OP).

**Township/Range/Section:** NE 1/4, NW 1/4, NE 1/4, Section 1, T6S, R8E  
(DWR# 6S/8E-1B)

**Latitude/Longitude:** Lat. 37° 26' 56"/Long. 121° 02' 09"

**County:** Stanislaus

**USGS Quad Map:** Crows Landing, CA

**Type of diversion and use of the water:** Irrigation water use for 180 acres of row crops (beans, tomatoes, cantaloupe) and alfalfa. Supply is periodically supplemented with well water from a deep well drilled immediately inside the project levee.

**Water Right Permit Number:** Water right held by Twin Oaks Irrigation Company



**SAN JOAQUIN RIVER DIVERSION SITE**

**SITE ID #** SJW 104.0 P

**Site Name:** Twin Oaks Irrigation Company  
Pumps

**River Mileage:** 104.0

**Site description, location and access:** Site is located 1500 feet east of Paradise Avenue along the project levee. Access to the site is via the project levee through locked gates. The gate keys are available with the manager on Apple Avenue.

**Township/Range/Section:** SW 1/4, SE 1/4, NW 1/4, Section 36, T5S, R8E  
(DWR# 5S/8E-36F)

**Latitude/Longitude:** Lat. 37° 27' 30"/Long. 121° 02' 31"

**County:** Stanislaus

**USGS Quad Map:** Crows Landing, CA

**Type of diversion and use of the water:** San Joaquin River water diverted for irrigation of approximately 6200 acres within Twin Oaks Irrigation Company and Reclamation District No. 1602. The irrigation water is used for sugar beets, tomatoes, melons, wheat, alfalfa, corn, and barley.

**Meter Number:** There are three pumps located at this site and a deep well just inside the project levee.

**Water Right Permit Number:** 4237  
**License Number:** 1064

## SAN JOAQUIN RIVER DISCHARGE SITE

SITE ID# SJE 103.4D

Site Name: Turlock Irrigation District  
Lateral No. 5 (Harding Drain)

River Mileage: 103.4

**Site description, location and access:** Discharge is by gravity (2 discharge pipes 700 feet west of Carpender Road and 2 miles south of West Main Street. Access to the site is via project levee off of Carpender Road. During high river flows when gravity discharge is not possible, Lateral 5 flow moves north through a drain on the interior side of the levee to the USBR pumps at site SJE 101.8D.

**Township/Range/Section:** SE 1/4, SE 1/4, SE 1/4, Section 25, T5S, R8E  
(DWR# 5S/8E-25R)

**Latitude/Longitude:** Lat. 37° 27' 51"/Long. 121° 01' 55"

**County:** Stanislaus

**USGS Quad Map:** Crows Landing, CA

### WATER SOURCE

**Type and source of water being discharged (description):** The Turlock Irrigation District (TID) Lateral No. 5 discharges by gravity to the San Joaquin River. Water entering this lateral comes from operational spills from Laterals No. 4, 4 1/2, 5 and 5 1/2. This lateral is unlined beyond where the City of Turlock discharges municipal wastewater into this lateral. Reuse of water occurs below the City discharge, however, some of the effluent may find its way into the San Joaquin River. The district's discharge is composed mainly of operational spill water.

**Comments on factors affecting water quality and quantity at the site:** Quality will depend upon the amount of City wastewater and tailwater finding their way to the discharge point. Water entering this lateral comes from Laterals No. 4, 4 1/2, 5 and 5 1/2 of the Turlock Irrigation District.

**SAN JOAQUIN RIVER DIVERSION SITE**

**SITE ID #** SJE 103.4 P

**Site Name:** Azevedo Pump

**River Mileage:** 103.4

**Site description, location and access:** The Azevedo Pump is located 50 feet north of the Turlock Irrigation District Lateral No. 5 discharge (700 feet east of Carpender Road). Access to the site is via Carpender Road, 2 miles south of West Main Street.

**Township/Range/Section:** SE 1/4, SE 1/4, SE 1/4, Section 25, T5S, R8E  
(DWR # 5S/8E-25R)

**Latitude/Longitude:** Lat. 37° 27' 52"/Long. 121° 01' 55"

**County:** Stanislaus

**USGS Quad Map:** Crows Landing, CA

**Type of diversion and use of the water:** River water is diverted for irrigation of 75 acres of land immediately adjacent to the river. This pump was removed in July 1985 due to vandalism and there are no immediate plans to replace it (as per land owner on 12/12/85).

**Meter Number:** 15175

**License Number:** 4537

## SAN JOAQUIN RIVER DISCHARGE SITE

SITE ID# SJW 102.2D

Site Name: Paradise Avenue Slough

River Mileage: 102.2

**Site description, location and access:** This slough does not discharge directly to the San Joaquin River, though seepage most probably does occur. This slough is located south of Pear Slough on the east side of Paradise Avenue. Access to the site is via Apricot Avenue to Paradise Avenue. Cross Paradise Avenue and continue due east onto a dirt farm road. This slough is straight ahead on the landward side of the levee.

**Township/Range/Section:** SE 1/4, SE 1/4, SE 1/4, Sec. 26, T5S, R8E  
(DWR# 5S/8E-26R)

**Latitude/Longitude:** Lat. 37° 27' 56"/Long. 121° 03' 00"

**County:** Stanislaus

**USGS Quad Map:** Crows Landing

### WATER SOURCE

**Type and source of water being discharged (description):** This slough receives irrigation tail water from approximately 470 acres on both sides of Paradise Avenue. The sources of irrigation water to this drainage area are the Twin Oaks Irrigation Company Pumps and possibly on-farm irrigation wells on the Ramona Lake Slough.

## SAN JOAQUIN RIVER DISCHARGE SITE

SITE ID# SJE 101.8D

Site Name: Gomes Lake Drainage Pumps

River Mileage: 101.8

**Site description, location and access:** The Gomes Lake (Hailwood Ranch) Drainage Pumps are located 0.7 miles west of Carpender Road and 0.8 miles south of West Main Street. The site consists of three large discharge pumps which are used during flood periods otherwise the outlet is by gravity flow during the irrigation season. Access to the site is via project levee off of Carpender Road.

**Township/Range/Section:** NE 1/4, SW 1/4, SW 1/4, Section 24, T5S, R8E  
(DWR# 5S/8E-24N)

**Latitude/Longitude:** Lat. 37° 28' 54"/Long. 121° 02' 43"

County: Stanislaus

USGS Quad Map: Crows Landing, CA

### WATER SOURCE

**Type and source of water being discharged (description):** Surface runoff tailwater from irrigated land (principally pasture) and operational spill water from Turlock Irrigation District canals including land within Reclamation District 2063.

**Comments on factors affecting water quality and quantity at the site:** It is often reported that dairies are discharging into drains that lead to these pumps.

## SAN JOAQUIN RIVER DISCHARGE SITE

SITE ID# SJW 101.5D

Site Name: Reclamation District 1602  
Overflow Drain

River Mileage: 101.5

**Site description, location and access:** Site is located 0.5 miles south of Reclamation District 1602's main drain outfall at Lake Ramona. The discharge outlet is a gravity screwgate located on the land side of the levee. Access to the site is via the project levee through a locked gate where the levee meets Fig Avenue. The discharge point is 0.9 miles south of this gate.

**Township/Range/Section:** NE 1/4, NE 1/4, NW 1/4, Section 26, T5S, R8E  
(DWR# 5S/8E-26C)

**Latitude/Longitude:** Lat. 37° 29' 09"/Long. 121° 03' 33"

**County:** Stanislaus

**USGS Quad Map:** Crows Landing, CA

### WATER SOURCE

**Type and source of water being discharged (description):** The water being discharged consists of area drainage from portions of RD 1602 and the Patterson Irrigation District. Normally this water would move out through site SJW 100.0D; however, in the event of a backup, this water would spill into this channel. This channel also carries water from field below the main drain.

**Comments on factors affecting water quality and quantity at the site:** Quality at this point will depend upon the amount of tile drainage water that finds its way back into the slough and the quantity of tailwater available to dilute it. Discharge quality should reflect the same quality as site SJW 100.0D.

## SAN JOAQUIN RIVER DIVERSION SITE

SITE ID # SJE 100.8P

Site Name: Hailwood Ranch Southern Pump

River Mileage: 100.8

**Site description, location and access:** Pump is located 1.4 miles south of West Main Street on the eastern bank of the river along the project levee. Pump is located in an old backwater channel of the river that was created during 1982 floods. All maps show the original channel. Access to the site is via the project levee located on the southeast side of the Patterson Bridge. Proceed south along the levee for 1.4 miles. Pump is located adjacent to a large oak tree and a small cattle holding pen.

**Township/Range/Section:** SE 1/4, SE 1/4, NW 1/4, Section 23, T5S, R8E  
(DWR# 5S/8E-23F)

**Latitude/Longitude:** Lat. 37° 29' 10"/Long. 121° 01' 57"

County: Stanislaus

USGS Quad Map: Crows Landing, CA

**Type of diversion and use of the water:** Water is diverted for irrigation and supplemental irrigation adjacent to the river. The pump is used to irrigate 520 acres (80% irrigated corn/winter oats-barley and 20% irrigated pasture).

**Water Right Permit Number:** (2.5 cfs) 40hp (one pump)

## SAN JOAQUIN RIVER DISCHARGE SITE

SITE ID# SJW 100.0D

Site Name: Ramona Lake Main Drain Outfall  
(RD 1602 Main Drain)

River Mileage: 100.0

**Site description, location and access:** The discharge point is located approximately 3/8 miles south of Fig Avenue along the flood levee. The site is a freeflow drain; however, a pump discharge is possible during periods of high river flow. The sampling site is on the river side of the levee as the pipe exits under the levee. Access to the levee is through a locked gate where the levee meets Fig Avenue.

**Township/Range/Section:** NE 1/4, NE 1/4, NE 1/4, Section 23, T5S, R8E  
(DWR# 5S/8E-23A)

**Latitude/Longitude:** Lat. 37° 28' 43"/Long. 121° 04' 04"

**County:** Stanislaus

**USGS Quad Map:** Crows Landing, CA

### WATER SOURCE

**Type and source of water being discharged (description):** The discharge at this location is by gravity; however, a full pump system is available if the river levels are too high. The discharge consists of area drainage from portions of RD 1602 and Patterson Irrigation District. This drain carries a combination of tailwater and subsurface drainage water. Tailwater drainage comes from approximately 3780 acres of irrigated lands located east of the Patterson Water District Lateral G and north of Marshall Road (see map 1a). Tile drainage systems serve an area of approximately 1830 acres (see map 1b). Each tile system serves a number of small farm plots and act much like a collector drain for the area. Each of the drainage systems flows into one of two collector drains which in turn discharge into a slough that eventually leads to the main surface drain outfall at this site. These two collector drains are monitored separately: the Pomelo Avenue Drain (STC005) and the Apricot Avenue Drain (STC006). The Ramona Lake Main Drain Outfall is monitored as Site# STC022. The sources of irrigation water to this area are the Patterson Water District Laterals F and G, the recirculation of slough water at Prune Avenue, and possibly on-farm irrigation wells.

The ponding system on the west side of the levee can feed water into this system, however, the majority of the gravity flow comes directly from field drains. Drainage water is likely to consist of both field tailwater and tile drainage water. An overflow channel can bypass water and discharge at SJW 101.5D. Overflow from Lake Ramona can also enter the discharge channel immediately east of the river levee. The discharge from Lake Ramona, however, is not likely to degrade water quality in the river as it consists primarily of river seepage that was trapped in the Slough or ground water seepage from upslope lands. It is recommended that the lake be monitored in order to assess the significance of its quality.

**Comments on factors affecting water quality and quantity at the site:** Quality at this point will depend upon the amount of tile drainage water that finds its way back into the slough and the quantity of tailwater available to dilute it.



San Joaquin River Discharge Site  
Ramona Lake Main Drain Outfall

-2-

MONITORING

Previous or ongoing monitoring at the site:

<u>Agency</u>	<u>Site ID#</u>	<u>Constituents</u>	<u>Frequency</u>	<u>Period of Record</u>	<u>Data Storage</u>
CVRWQCB	STC 022	Standard minerals, trace elements, Se, & suspended sediments	monthly	1/86- present	CVRWQCB Files
Patterson Water District	Ramona Lake Drain	EC & suspended sediments	monthly (May-Sept)	4/86- present	PWD Files

## SAN JOAQUIN RIVER DISCHARGE SITE

SITE ID# SJW 099.0D

Site Name: Ash Avenue Drainage Area

River Mileage: 98.8-99.5

**Site description, location and access:** There is no one discharge point in this drainage area. This area does not drain to any of the known discharges to the San Joaquin River. What drainage water that does reach the River is from small fields or through seepage. This area is located south of the Patterson Water District Main Canal, adjacent to the San Joaquin River (see map 1a). Access to this area is via Orange Avenue east to Ash Avenue. This drainage area is along Ash Avenue.

Township/Range/Section: Section 22, T5S, R8E

Latitude/Longitude: N/A

County: Stanislaus

USGS Quad Map: Crows Landing, CA

### WATER SOURCE

**Type and source of water being discharged (description):** Surface runoff and irrigation tail water from small irrigated fields. This 240 acre area has no known discharge site. Each field discharges surface runoff.

**SAN JOAQUIN RIVER DIVERSION SITE**

**SITE ID #** SJW 098.9 P

**Site Name:** Eskue Pump

**River Mileage:** 98.9

**Site description, location and access:** Pump is located 600 feet south of the Patterson Bridge along the West Bank. Access to the site is through the second homestead south of Las Palmas Blvd on the east side of Ash Avenue. The pump is located in the northern section of this 8 acre property.

**Township/Range/Section:** SW 1/4, NE 1/4, NW 1/4, Section 22, T5S, R8E  
(DWR# 5S/8E-22C)

**Latitude/Longitude:** Lat. 37° 29' 30"/Long. 121° 04' 41"

**County:** Stanislaus

**USGS Quad Map:** Crows Landing, CA

**Type of diversion and use of the water:** Water is used to irrigate approximately 7 acres of pasture immediately adjacent to the river.

**Meter Number:** This pump is an electrical pump but the lines run along the southern boundary of the property with an underground cable to the site (per owner 12/16/85)

San Joaquin River Section #15

Patterson Bridge to Grayson Road Bridge

# SAN JOAQUIN RIVER

## Section 15: Patterson Bridge to Grayson Road Bridge

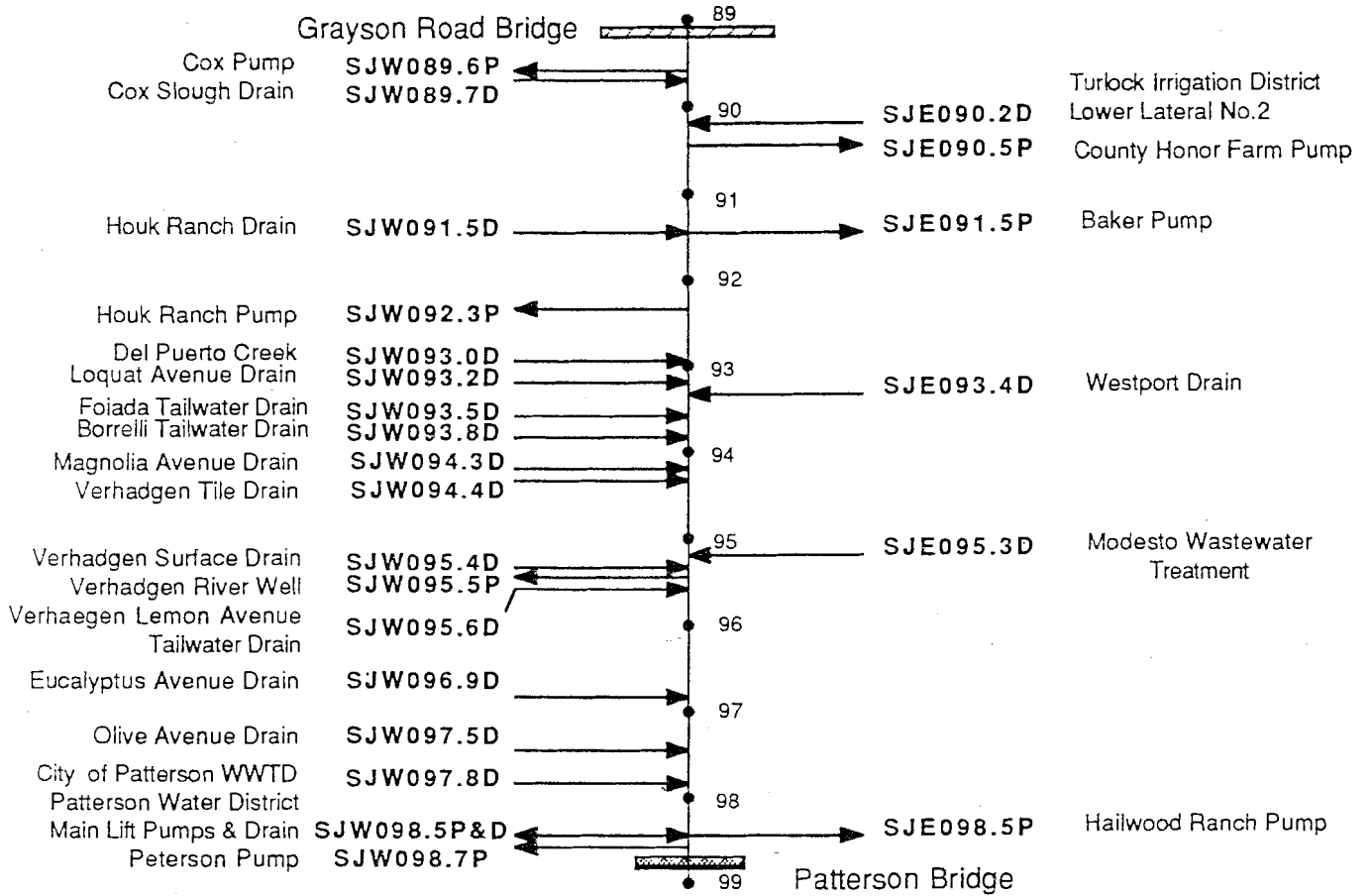

Figure A-15. Schematic Diagram for Water Diversions and Discharges on the San Joaquin River from Patterson Bridge to Grayson Road Bridge (River Section 15).

**SAN JOAQUIN RIVER DIVERSION SITE**

**SITE ID #** SJW 098.7 P

**Site Name:** Peterson Pump

**River Mileage:** 98.7

**Site description, location and access:** This small river pump is located on west bank of San Joaquin River approximately 350 feet north of the Patterson Bridge. Access to the site is via Las Palmas Avenue to Ash Road located 500 feet west of Patterson Bridge.

**Township/Range/Section:** SE 1/4, SW 1/4, SW 1/4, Section 15, T5S, R8E  
(DWR # 5S/8E-15N)

**Latitude/Longitude:** Lat. 37° 29' 40"/Long. 121° 04' 48"

**County:** Stanislaus

**USGS Quad Map:** Crows Landing

**Type of diversion and use of the water:** Irrigation water for the irrigation of approximately 5 acres of pasture.

**Water Right Permit Number:** 16669

**SAN JOAQUIN RIVER DIVERSION SITE**

**SITE ID #** SJE 098.5 P

**Site Name:** Hailwood Ranch North Pump

**River Mileage:** 98.5

**Site description, location and access:** The Hailwood Ranch North Pump is located 0.1 miles north of the Patterson Bridge. The Hailwood Ranch was recently purchased by the City of Modesto as part of their efforts to expand their wastewater treatment plant disposal and irrigation reuse area. Access to the site is via the project levee from its intersection with Las Palmas Avenue (West Main Street).

**Township/Range/Section:** SE 1/4, NW 1/4, SW 1/4, Section 11, T5S, R8E  
(DWR # 5S/8E-11M)

**Latitude/Longitude:** Lat. 37° 29' 51"/Long. 121° 04' 51"

**County:** Stanislaus

**USGS Quad Map:** Crows Landing, CA

**Type of diversion and use of the water:** Water is diverted for irrigation of 180 acres of irrigated pasture immediately adjacent to the river. This pump is only for supplemental supply.

**Meter Number:** not recorded on field survey

**Water Right Permit Number:** 4102

**License Number:** 2883

**SAN JOAQUIN RIVER DIVERSION SITE**

**SITE ID #** SJW 098.5 P

**Site Name:** Patterson Water District Main River Mileage: 98.5  
Lift Pumps

**Site description, location and access:** The main pumping lift for the Patterson Water District consists of two large pumps located 0.1 miles north of the Patterson Bridge. Access to the site is via Las Palmas Avenue out of Patterson for 2.4 miles; turn northeast toward the boat launch and park. The site is located 200 feet south of the Park at the River.

**Township/Range/Section:** NW 1/4, SW 1/4, SW 1/4, Section 15, T5S, R8E  
(DWR # 5S/8E-15M)

**Latitude/Longitude:** Lat. 37° 29' 50"/Long. 121° 04' 54"

**County:** Stanislaus

**USGS Quad Map:** Crows Landing, CA

**Type of diversion and use of the water:** San Joaquin River Water is diverted for irrigation of 14,000 acres. Crops include alfalfa, corn, beans, tomatoes, melons, peas, spinach, apricots, walnuts, almonds, barley, wheat, oats, sudan, sugar beets, bell peppers, cherries, plums, apples, and pistachios.



## SAN JOAQUIN RIVER DISCHARGE SITE

SITE ID# SJW 098.5D

Site Name: Patterson Water District Main  
Drain

River Mileage: 98.5

**Site description, location and access:** The Patterson Main drain as it discharges into the San Joaquin River on the north side of the Patterson Water District Main Lift Canal. Access to the site is by road on the north side of the lift canal as the road leads toward the boat launch at the San Joaquin River.

**Township/Range/Section:** NW 1/4, SW 1/4, SW 1/4, Section 15, T5S, R8E  
(DWR# 5S/8E-15M)

**Latitude/Longitude:** Lat. 37° 29' 50"/Long. 121° 04' 54"

**County:** Stanislaus

**USGS Quad Map:** Crows Landing, CA

### WATER SOURCE

**Type and source of water being discharged (description):** This drain receives a combination of operational spill water from the Patterson Water District Main Lift Canal, tile drainage, tailwater, and surface runoff. The tile drainage systems are shown in map 1a. The total subsurface drainage area is approximately 1580 acres. Tailwater and surface runoff to this drain come from approximately 140 acres (see map 1b) on the north side of this drain. This site is monitored as Site# STC 023. The sources of irrigation water to this area are the Patterson Water District Laterals A, B, G, H, J, K, 3 North, and 4 North and on-farm irrigation wells.

**Comments on factors affecting water quality and quantity at the site:** The quality of water at this site is heavily influenced by the amount of tailwater that is entering the canal and the amount of operational spill water that enters the system.

### MONITORING

Previous or ongoing monitoring at the site:

<u>Agency</u>	<u>Site ID#</u>	<u>Constituents</u>	<u>Frequency</u>	<u>Period of Record</u>	<u>Data Storage</u>
CVRWQCB	STC 023	Standard minerals, trace elements, selenium, and Suspended Sediments	monthly	11/85- present	CVRWQCB Files
Patterson Water District	PWD Main Drain	Flow, EC, & Suspended Sediments	monthly (May-Sept)	4/86- present	PWD Files

## SAN JOAQUIN RIVER DISCHARGE SITE

SITE ID# SJW 097.8D

Site Name: City of Patterson WWTP Slough

River Mileage: 97.8

**Site description, location and access:** The City of Patterson wastewater treatment plant discharges into a slough that enters the river at mile 97.8. During periods of no discharge the plant percolates its wastewater in ponds that are situated on the sandy soils of this slough area. Even though no surface discharge occurs, percolation seeps to the river. Access to the site is via Olive Avenue to the river. The site is located approximately 0.2 miles south of this Olive Avenue-San Joaquin River intersection.

**Township/Range/Section:** SE 1/4, NE 1/4, NE 1/4, Section 16, T5S, R8E  
(DWR# 5S/8E-16A)

**Latitude/Longitude:** Lat. 37° 30' 21"/Long. 121° 05' 10"

**County:** Stanislaus

**USGS Quad Map:** Brush Lake, CA

### WATER SOURCE

**Type and source of water being discharged (description):** This slough receives treated municipal wastewater, surface runoff, and tailwater from approximately 470 acres of irrigated land. The drainage area is bounded on the north by Walnut Avenue, on the south by Las Palmas Avenue, and on the west by the Patterson Water District Lateral B (see map 1a). The sources of irrigation water to this area are the Patterson Water District Laterals A and B, and possibly on-farm irrigation wells.

**Comments on factors affecting water quality and quantity at the site:** Quality will depend upon the level of treatment achieved and on the amount of tailwater discharged to the slough.

## SAN JOAQUIN RIVER DISCHARGE SITE

SITE ID# SJW 097.5D

Site Name: Olive Avenue Drain

River Mileage: 97.5

**Site description, location and access:** This drain is a closed collector drain that flows down Olive Avenue and discharges into the San Joaquin River at Olive Avenue. The discharge is from a pipeline. Access to the site is through a farm road that begins at the end of Olive Avenue. The discharge is in a direct line with the alignment of Olive Avenue, however, the actual discharge is approximately 250 feet north of this direct line.

**Township/Range/Section:** NW 1/4, NE 1/4, NE 1/4, Section 16, T5S, R8E  
(DWR# 5S/8E-16A)

**Latitude/Longitude:** Lat. 37° 30' 27"/Long. 121° 05' 15"

**County:** Stanislaus

**USGS Quad Map:** Brush Lake, CA

### WATER SOURCE

**Type and source of water being discharged (description):** The water in this closed pipeline drain is operational spill water from Patterson Water District and tailwater from irrigated fields as far up slope as the California Aqueduct. In addition, this drain also collects runoff from Salado Creek. This drain receives drainage from approximately 4840 acres of irrigated land on the east side of the Delta-Mendota Canal alone (see map 1a). This site is monitored as Site# STC 024. The sources of irrigation water to this area are West Stanislaus Irrigation District Laterals 5 and 6 South, Patterson Water District Laterals north of Main Canal, and on-farm irrigation wells.

**Comments on factors affecting water quality and quantity at the site:** The quality of this drain will reflect the quality of the tailwater that is discharged into it. No direct discharge of tile drainage water is done into the drain, however, some seepage can be expected due to high water tables in the area. The amount of seepage, however, will not greatly influence the quality.

### MONITORING

Previous or ongoing monitoring at the site:

<u>Agency</u>	<u>Site ID#</u>	<u>Constituents</u>	<u>Frequency</u>	<u>Period of Record</u>	<u>Data Storage</u>
West Stanislaus RCD	37	EC, temperature	monthly (May-Sept)	7/78- present	WSRCD Files
CVRWQCB	STC 024	Standard minerals, trace elements, selenium, and Suspended Sediments	monthly	10/85- present	CVRWQCB Files
Patterson Water District	Olive Ave. Drain	Flow, EC, & Suspended Sediments	monthly (May-Sept)	4/86- present	RWD Files

## SAN JOAQUIN RIVER DISCHARGE SITE

SITE ID# SJW 096.9D

Site Name: Eucalyptus Avenue Drain

River Mileage: 96.9

**Site description, location and access:** The Eucalyptus Avenue Drain is an underground pipeline which discharges directly into the San Joaquin River at the eastern end of Eucalyptus Avenue. Access is via Eucalyptus Avenue east toward the San Joaquin River. There is a trailer on the north side of the road just before reaching the river. Take the farm road on the west side of the trailer toward the north. This road will turn toward the river going behind the trailer. Once at the levee, the drain is over the bank.

**Township/Range/Section:** SE 1/4, NE 1/4, SW 1/4, Section 9, T4S, R8E  
(DWR# 4S/8E-9L)

**Latitude/Longitude:** Lat. 37° 31' 51"/Long. 121° 06' 43"

**County:** Stanislaus

**USGS Quad Map:** Brush Lake, CA

### WATER SOURCE

**Type and source of water being discharged (description):** The water in this closed pipeline drain is tailwater from approximately 430 acres of irrigated fields. No known tile drainage water enters the system. This drainage area is bounded on the west by Sycamore Avenue and it extends east to the San Joaquin River (see map 1a). This site is monitored as Site# STC 025. The sources of irrigation water to this drainage area are the Patterson Water District Laterals 3 North, B, and A and possibly on-farm irrigation wells.

**Comments on factors affecting water quality and quantity at the site:** The quality of this drain will reflect the quality of the tailwater that is discharged into it. No direct discharge of tile drainage water is done into the drain, however, some seepage can be expected due to high water tables in the area. The amount of seepage, however, will not greatly influence the quality.

### MONITORING

Previous or ongoing monitoring at the site:

<u>Agency</u>	<u>Site ID#</u>	<u>Constituents</u>	<u>Frequency</u>	<u>Period of Record</u>	<u>Data Storage</u>
West Stanislaus RCD	38	EC, temperature	monthly (May-Sept)	7/78- present	WSRCD Files
CVRWQCB	STC 025	Standard minerals, trace elements, selenium, and Suspended Sediments	monthly	10/85- present	CVRWQCB Files
Patterson Water District	Eucalyptus Ave. Drain	Flow, EC, & Suspended Sediments	monthly (May-Sept)	4/86- present	RWD Files

## SAN JOAQUIN RIVER DISCHARGE SITE

SITE ID# SJW 095.6D

Site Name: Verhaegen Lemon Avenue  
Tail Water Drain

River Mileage: 95.6

**Site description, location and access:** This site is a tail water drain at the end of Lemon Avenue. Access to this site is via Lemon Avenue to the end and then continue straight ahead on a dirt farm road to the river.

**Township/Range/Section:** SE 1/4, NW 1/4, NW 1/4, Sec. 9, T5S, R8E  
(DWR# 5S/8E-9D)

**Latitude/Longitude:** Lat. 37° 28' 37"/Long. 121° 05' 58"

**County:** Stanislaus

**USGS Quad Map:** Brush Lake, Lake

### WATER SOURCE

**Type and source of water being discharged (description):** Tail water from approximately 130 acres of irrigated land. This area is bounded on the west by the Patterson Water District Lateral A (see map 1a). There is no known tile drainage systems in this area. The sources of irrigation water are the Patterson Water District, Lateral A and the Verhaegen River Well (SJW095.5P).

**Comments on factors affecting water quality and quantity at the site:** The water quality will depend on the source water quality. This drain is expected to carry a heavy sediment load.

**SAN JOAQUIN RIVER DIVERSION SITE**

**SITE ID #** SJW 095.5 P

**Site Name:** Verhaegen River Well

**River Mileage:** 95.5

**Site description, location and access:** This is not a direct river diversion rather it is a well drilled adjacent to the San Joaquin River on the interior side of the levee. The well is located 0.4 miles north of Eucalyptus Avenue along the levee. Access is via Eucalyptus Avenue, turn north along the levee.

**Township/Range/Section:** NE 1/4, SW 1/4, NW 1/4, Section 9, T5S, R8E  
(DWR # 5S/8E-9E)

**Latitude/Longitude:** Lat. 37° 31' 03"/Long. 121° 05' 53"

**County:** Stanislaus

**USGS Quad Map:** Brush Lake, CA

**Type of diversion and use of the water:** This well is used to irrigate 80 acres of land on the west side of the River. No direct river diversion occurs but significant seepage likely occurs from pumpage.

## SAN JOAQUIN RIVER DISCHARGE SITE

SITE ID# SJW 095.4D

Site Name: Verhaegan Surface Drain

River Mileage: 95.4

**Site description, location and access:** This is a tailwater drain which consists of an open pipe through the levee. Tailwater and surface drainage is collected from approximately 100 acres of land along the river southeast of Magnolia Avenue (see map 1a). Access to the site is via Lemon Road to the project levee. This site is approximately 0.1 miles north on the levee road. Pipe is in the levee bank but difficult to see.

**Township/Range/Section:** NE 1/4, NW 1/4, NW 1/4, Section 9, T5S, R8E  
(DWR# 5S/8E-9D)

**Latitude/Longitude:** Lat. 37° 31' 18"/Long. 121° 05' 55"

**County:** Stanislaus

**USGS Quad Map:** Brush Lake, CA

### WATER SOURCE

**Type and source of water being discharged (description):** Tailwater from 100 acres of irrigated land adjacent to the San Joaquin River. This area receives irrigation water from Patterson Water District Lateral A or from an on-farm irrigation well.

## SAN JOAQUIN RIVER DISCHARGE SITE

SITE ID# SJE 095.3D

Site Name: Modesto Wastewater Treatment

River Mileage: 95.3

**Site description, location and access:** The Modesto Wastewater Treatment Plant discharges municipal wastewater at the southern end of the treatment ponds. Access to the site is via Grayson Road to Jennings Road. Jennings Road is located 4 3/4 miles east of Laird Slough. Go south on Jennings Road for 3 1/4 miles to a dirt road on the south side of sewage disposal pond. Follow this dirt road west to levee and then go north 0.4 miles on levee to discharge site.

**Township/Range/Section:** SW 1/4, SE 1/4, SW 1/4, Section 4, T5S, R8E  
(DWR# 5S/8E-4P)

**Latitude/Longitude:** Lat. 37° 31' 22"/Long. 121° 05' 48"

County: Stanislaus

USGS Quad Map: Brush Lake, CA

### WATER SOURCE

**Type and source of water being discharged (description):** The discharge is composed entirely of treated municipal wastewater from the city's ponds.

**Comments on factors affecting water quality and quantity at the site:** Quality will be determined by the treatment level acquired.



## SAN JOAQUIN RIVER DISCHARGE SITE

SITE ID# SJW 094.4D

Site Name: Verhaegen Tile Drain (abandoned)

River Mileage: 94.4

**Site description, location and access:** Tile drainage sump discharging directly into the San Joaquin River. Site is located on the interior levee at the eastern most end of Magnolia Avenue.

**Township/Range/Section:** SE 1/4, SW 1/4, SE 1/4, Section 5, T5S, R8E  
(DWR# 5S/8E-5Q)

**Latitude/Longitude:** Lat. 37° 31' 24"/Long. 121° 07' 24"

County: Stanislaus

USGS Quad Map: Brush Lake, CA

### WATER SOURCE

**Type and source of water being discharged (description):** This discharge contains tile drainage water from 100 acres of irrigated land that lies immediately adjacent to the San Joaquin River.

**Comments on factors affecting water quality and quantity at the site:** Discharges will be related to the water levels in the river.

**SAN JOAQUIN RIVER DISCHARGE SITE**

SITE ID# SJW 094.3D

Site Name: Magnolia Avenue Drain

River Mileage: 94.35

**Site description, location and access:** This drain is an underground pipeline that runs along Magnolia Avenue east of Patterson Water District Lateral B (see map 1a). Access to this site is via Magnolia Avenue to the levee road. Magnolia Avenue turns into a dirt farm road and veers north before reaching the levee road. This drain discharges through the levee approximately 50 feet east of the Magnolia Avenue-levee road intersection before flowing into the San Joaquin River.

**Township/Range/Section:** NE 1/4, SW 1/4, SE 1/4, Section 5, T5S, R8E (DWR# 5S/8E-5Q)

**Latitude/Longitude:** Lat. 37° 31' 31"/Long. 121° 06' 29"

**County:** Stanislaus

**USGS Quad Map:** Bush Lake, CA

**WATER SOURCE**

**Type and source of water being discharged (description):** The water in this closed pipeline drain is operational spill water from Patterson Water District and tailwater from irrigated fields near Elm Avenue. The drainage area of this drain is approximately 760 acres. The Magnolia Drain receives drainage from two unconnected areas (see map 1a). The northern area is around the Magnolia Avenue-Elm Avenue and Lemon Avenue-Elm Avenue intersections and contains approximately 5700 acres. This area is bounded on the west by the Patterson Water District Lateral B. The southern area is located between Eucalyptus and Olive Avenues. It contains approximately 190 acres. The drainage water from this southern area is discharged to the Patterson Water District Lateral A to be reused or spilled to this drain. The Magnolia Drain is monitored as Site# STC 050. The sources of irrigation water to this drainage area are the Patterson Water District Laterals 3 North, B, and A and on-farm irrigation wells (see map 1b).

**Comments on factors affecting water quality and quantity at the site:** The quality of this drain will reflect the quality of the tail water that is discharged into it. No direct discharge of tile drainage water is done into the drain, however, some seepage can be expected due to high water tables in the area. The amount of seepage, however, will not greatly influence the quality.

**MONITORING**

**Previous or ongoing monitoring at the site:**

<u>Agency</u>	<u>Site ID#</u>	<u>Constituents</u>	<u>Frequency</u>	<u>Period of Record</u>	<u>Data Storage</u>
CVRWQCB	STC 050	Cl, SO <sub>4</sub> , Total Alkalinity, EC, B, Cu, Cr, Pb, Hg, Mo, Ni, Zn, Se, & Suspended Sediments	monthly	5/86-present	CVRWQCB Files
Patterson Water District	Magnolia Ave. Drain	Flow, EC, & Suspended Sediments	monthly (May-Sept)	4/86-present	RWD Files

## SAN JOAQUIN RIVER DISCHARGE SITE

SITE ID# SJW 093.8D

Site Name: Borrelli Tail Water Drain

River Mileage: 93.8

**Site description, location and access:** This site is a tail water drain at the end of Fruit Avenue. Access to the discharge site is via Fruit Road to the end and then continue straight ahead toward the river on a dirt farm road. This open ditch will be on the south side of the road once past the tail water pump.

**Township/Range/Section:** NE 1/4, SW 1/4, NE 1/4, Sec. 5, T5S, R8E  
(DWR# 5S/8E-56)

**Latitude/Longitude:** Lat. 37° 31' 54"/Long. 121° 06' 28"

**County:** Stanislaus

**USGS Quad Map:** Brush Lake, CA

### WATER SOURCE

**Type and source of water being discharged (description):** Tail water and surface runoff from approximately 110 acres. This drainage area is south of Fruit Avenue (see map Ia). The major crop grown is sod, but some row crops are grown. The sources of irrigation water to this area are the Patterson Water District Lateral B and possibly an on-farm irrigation well(s).

**Comments on factors affecting water quality and quantity at the site:** The water quality and quantity depends on the amount of row crops being grown during a given growing season. The drain could carry a heavy sediment load.

## SAN JOAQUIN RIVER DISCHARGE SITE

SITE ID# SJW 093.5D

Site Name: Foiada Tail Water Drain

River Mileage: 93.5

**Site description, location and access:** This site is a tail water drain located between Loquat and Fruit Avenues. Access to the discharge site is via Loquat Avenue east to the project levee. The site is approximately 500 feet to the south.

**Township/Range/Section:** NE 1/4, SE 1/4, NW 1/4, Sec. 5, T5S, R8E  
(DWR# 5S/8E-5F)

**Latitude/Longitude:** Lat. 37° 32' 00"/Long. 121° 06' 44"

County: Stanislaus

USGS Quad Map: Brush Lake, CA

### WATER SOURCE

**Type and source of water being discharged (description):** This drain receives tail water from approximately 290 acres. This area has some row crops, but the major crop is sod. The drainage area is bounded on the west by the Patterson Water District Lateral B, on the north by Loquat Avenue, and on the south by Fruit Avenue (see map 1a). The sources of irrigation water to this area are the Patterson Water District Lateral B and on-farm irrigation wells.

**Comments on factors affecting water quality and quantity at the site:** The water quality and quantity will depend on the amount of row crops grown in this drainage area for a given year. The drainage could carry a high sediment load.

## SAN JOAQUIN RIVER DISCHARGE SITE

SITE ID# SJE 093.4D

Site Name: Westport Drain

River Mileage: 93.4

**Site description, location and access:** The Westport Drain discharges immediately north of the Modesto Irrigation Wastewater Treatment Plant Ponds. The discharge carries both tailwater and operational spill water from the Turlock Irrigation District. Access to the site is via Grayson Road to Quisenberry Road, located 3 3/4 miles east of Laird Slough Bridge. Go south on Quisenberry and the drain is about 3/4 of a mile straight ahead.

**Township/Range/Section:** SW 1/4, SW 1/4, SE 1/4, Section 32, T4S, R8E  
(DWR# 4S/8E-32Q)

**Latitude/Longitude:** Lat. 37° 32' 14"/Long. 121° 06' 33"

**County:** Stanislaus

**USGS Quad Map:** Brush Lake, CA

### WATER SOURCE

**Type and source of water being discharged (description):** This discharge consists of tailwater from fields within the Turlock Irrigation District and operational spill water from Turlock Irrigation District Laterals 2 1/2 and 3.

**Comments on factors affecting water quality and quantity at the site:** Water quality will be reflected in the quantity of operational spill waters.

## SAN JOAQUIN RIVER DISCHARGE SITE

SITE ID# SJW 093.0D

Site Name: Del Puerto Creek

River Mileage: 93.0

**Site description, location and access:** Del Puerto Creek at its discharge to the San Joaquin River. Access to the site is off of Loquat Avenue at the end of Cottonwood Road. The Creek is sampled upstream of this point at the end of Cottonwood Avenue (STC 026).

**Township/Range/Section:** SW 1/4, SE 1/4, SE 1/4, Section 31, T4S, R8E  
(DWR# 4S/8E-31R)

**Latitude/Longitude:** Lat. 37° 32' 20"/Long. 121° 07' 22"

County: Stanislaus

USGS Quad Map: Brush Lake, CA

### WATER SOURCE

**Type and source of water being discharged (description):** Del Puerto Creek receives tail water drainage from approximately 9175 acres on the east side of the Delta Mendota Canal and west of the Patterson Water District Lateral B. The creek is also an operational spill for both the West Stanislaus Irrigation and the Patterson Water Districts. In the Patterson Water District, tailwater is discharged to the irrigation laterals downslope to be reused or spilled to Del Puerto Creek. The area of drainage to Del Puerto Creek is divided by the Olive Avenue Drain drainage area because the laterals carry the drainage water north over the Olive Avenue Drain (see map 1a). No tile drainage is known to enter the creek. This site is monitored as Site# STC026. The sources of irrigation water to this drainage area are the Patterson Water District Laterals B, 3 and 4 North, and M; the West Stanislaus Irrigation District Laterals 4, 5, and 6 South. There are also some on-farm irrigation wells that supplement the water sources to this area (see map 1b).

**Comments on factors affecting water quality and quantity at the site:** The quality of the Creek will be related to the operational spill water quality and the quality of the tailwater leaving individual fields.

### MONITORING

Previous or ongoing monitoring at the site:

<u>Agency</u>	<u>Site ID#</u>	<u>Constituents</u>	<u>Frequency</u>	<u>Period of Record</u>	<u>Data Storage</u>
CVRWQCB	STC 026	Cl, SO <sub>4</sub> , Total Alkalinity, EC, B, Cu, Cr, Pb, Hg, Mo, Ni, Zn, Se, & Suspended Sediments	monthly	1/85-present	CVRWQCB Files
West Stanislaus RCD	#41	Flow, EC	monthly (May-Sept)	7/78-present	WSRCD Files
Patterson Water District	Del Puerto Creek	Flow, EC, & Suspended Sediments	monthly (May-Sept)	4/86-present	RWD Files

**SAN JOAQUIN RIVER DIVERSION SITE**

**SITE ID #** SJW 092.3 P

**Site Name:** Houk Ranch Pump

**River Mileage:** 92.3

**Site description, location and access:** San Joaquin River diversion pump immediately south of Ritchie Slough. Access to the site via the road to the Houk Ranch Drain monitoring site (STC 027) then take the project levee to the right (southeast) for 0.8 miles to the pump.

**Township/Range/Section:** SE 1/4, NE 1/4, NE 1/4, Section 31, T4S, R8E, (DWR # 4S/8E-31A)

**Latitude/Longitude:** Lat. 37° 32' 52"/Long. 121° 07' 18"

**County:** Stanislaus

**USGS Quad Map:** Brush Lake

**Type of diversion and use of the water:** San Joaquin River water is diverted for irrigation of 300-400 acres immediately adjacent to the San Joaquin River.

**Meter Number:** not recorded in field survey

<b>Water Right Permit Number:</b>	13552	13553	4507
<b>License Number:</b>	4468	4469	1155

## SAN JOAQUIN RIVER DIVERSION SITE

SITE ID # SJE 091.5 P

Site Name: Baker Pump

River Mileage: 91.5

**Site description, location and access:** This site is located 0.6 miles south of Grayson Road along the eastern San Joaquin River levee at River mile 91.5. The pumps are located immediately opposite the Hoak Ranch Drain discharge (SJW 091.5D). The site is located near Brush Lake and is accessed via farm road off of Grayson Road. The dirt farm road is located approximately 1.3 to 1.5 miles east of the bridge over Laird Slough. Follow dirt road south through field to river and levee. The pump is located 700 feet south of road-levee intersection.

**Township/Range/Section:** NE 1/4, NW 1/4, SE 1/4, Section 30, T4S, R8E,  
(DWR # 4S/8E-30K)

**Latitude/Longitude:** Lat. 37° 33' 27"/Long. 121° 07' 36"

County: Stanislaus

USGS Quad Map: Westley

**Type of diversion and use of the water:** San Joaquin River water is diverted for irrigation of approximately 150-200 acres of land.

**Meter Number:** Turlock Irrigation District 45056

**Water Right Permit Number:** 16662  
**License Number:** 9816



# SAN JOAQUIN RIVER DISCHARGE SITE

SITE ID# SJW 091.5D

Site Name: Houk Ranch Drain

River Mileage: 91.5

**Site description, location and access:** Open drain which carries a blend of surface tailwater and subsurface tile drainage water. The drain discharge is located 1.7 miles east of Cox Road at the Houk Ranch Road. The turnoff from Cox Road is located 0.7 miles north of the intersection of Cox Road and Conduit Road. This discharge site is operated and maintained by the West Stanislaus Irrigation District.

**Township/Range/Section:** SE 1/4, SE 1/4, NW 1/4, Section 23, T5S, R8E  
(DWR# 5S/8E-23F)

**Latitude/Longitude:** Lat. 37° 33' 01"/Long. 121° 08' 09"

County: Stanislaus

USGS Quad Map: Westley

## WATER SOURCE

**Type and source of water being discharged (description):** The water in this drain is both surface tailwater and tile drainage water. The majority of the flow consist of surface tailwater from approximately 1290 acres (see map 1a). The only known discharge of tile drainage water is from approximately 80 acres of land directly adjacent to Richie Slough (see map 1b). This tile drainage discharge is monitored as Site# STC 046. This site is monitored as Site# STC 027. The sources of irrigation water to this area are the West Stanislaus Irrigation District Laterals 3 and 4 South, and on-farm irrigation wells (see map 1c).

**Comments on factors affecting water quality and quantity at the site:** The quality and quantity of water in the slough will be influenced heavily by the amount of tailwater entering the system. At most times, tailwater is the dominant factor. Flow in the irrigation off-season is mostly seepage and represents shallow groundwater quality.

## MONITORING

Previous or ongoing monitoring at the site:

<u>Agency</u>	<u>Site ID#</u>	<u>Constituents</u>	<u>Frequency</u>	<u>Period of Record</u>	<u>Data Storage</u>
CVRWQCB	STC 027	Cl, SO <sub>4</sub> , Total Alkalinity, EC, B, Cu, Cr, Pb, Hg, Mo, Ni, Zn, Se, & Suspended Sediments	monthly	1/86- present	CVRWQCB Files
West Stanislaus Irrigation District	STC 027	EC, Suspended Sediments, & Flow	Monthly (May-Sept)	4/86- present	WSID Files

**SAN JOAQUIN RIVER DIVERSION SITE**

**SITE ID #** SJE 090.5 P

**Site Name:** County Honor Farm Pump

**River Mileage:** 90.5

**Site description, location and access:** The pump is on a well at Laird Park. The well pulls water from the San Joaquin River. Access to the pump is via Grayson Road to the second entrance, east of Laird Slough bridge, into Laird Park. The pump is located in a well house just north of the Turlock Lateral No. 2.

**Township/Range/Section:** NW 1/4, SE 1/4, NE 1/4, Section 25, T4S, R7E,  
(DWR # 4S/7E-25H)

**Latitude/Longitude:** Lat. 37° 33' 41"/Long. 121° 08' 37"

**County:** Stanislaus

**USGS Quad Map:** Westley

**Type of diversion and use of the water:** Water from this well is used to irrigate part of Laird Park as well as for the Honor Farm facilities year round needs.

**Water Right Permit Number:** 16669

SAN JOAQUIN RIVER DISCHARGE SITE

SITE ID# SJE 090.2D

Site Name: Turlock Irrigation District Lateral No. 2. River Mileage: 90.2

Site description, location and access: The discharge site is located 0.25 miles east of the Grayson Road Bridge and 0.1 miles south of Grayson Road. Access to the site is through the Stanislaus County's Laird Park off of Grayson Road.

Township/Range/Section: NE 1/4, SW 1/4, NE 1/4, Section 25, T4S, R7E  
(DWR# 4S/7E-25G)

Latitude/Longitude: Lat. 37° 33' 40"/Long. 121° 08' 42"

County: Stanislaus

USGS Quad Map: Westley

WATER SOURCE

Type and source of water being discharged (description): The discharge is operational spill water from the Turlock Irrigation District system and normally contains excellent quality water.

## SAN JOAQUIN RIVER DISCHARGE SITE

SITE ID# SJW 089.7D

Site Name: Cox Slough Drain

River Mileage: 89.7

**Site description, location and access:** This drain receives drainage water from a series of sloughs on the west bank of the San Joaquin River. The sloughs are located east of Cox Road and northwest of Richie Slough. Access to the site is via Cox Road south from Grayson. On Cox Road 1/4 miles south of Westley Wasteway turn left (east) onto dirt farm road across from the Del Mar processing facility. Follow this dirt road and go right at the old dairy site. Just past the farm pond take an immediate left toward the river. There will be a river pump at the river. From the pump go south. The discharge point is located approximately .3 miles south of the river pump.

**Township/Range/Section:** NW 1/4, SW 1/4, SE 1/4, Section 25, T4S, R7E  
(DWR# 4S/7E-25Q)

**Latitude/Longitude:** Lat. 37° 33' 17"/Long. 121° 08' 50"

County: Stanislaus

USGS Quad Map: Westley

### WATER SOURCE

**Type and source of water being discharged (description):** Area surface drainage that accumulates in the sloughs on west bank of San Joaquin River and tail water from approximately 290 acres of irrigated farm land (see map 1a). The drainage area is east of Cox Road and north of the Houk Ranch. The sources of irrigation water to this area are the West Stanislaus Irrigation District Lateral 2 South and on-farm irrigation well(s) (see map 1b).

## SAN JOAQUIN RIVER DIVERSION SITE

SITE ID # SJW 089.6 P

Site Name: Cox River Pump

River Mileage: 89.6

**Site description, location and access:** Single pump located 0.5 miles upstream of the Grayson Bridge. Access to the site is via Cox Road south of Grayson. Going south on Cox Road, go 1/4 mile south of Westley Wasteway and turn left on dirt farm road. This farm road will turn right at an old dairy site. Follow this road until just passed a farm pond and take an immediate left onto another dirt road. The Cox River Pump is straight down this road.

**Township/Range/Section:** SW 1/4, NW 1/4, SW 1/4, Section 25, T4S, R7E,  
(DWR # 4S/7E-25M)

**Latitude/Longitude:** Lat. 37° 33' 19"/Long. 121° 09' 23"

**County:** Stanislaus

**USGS Quad Map:** Westley

**Type of diversion and use of the water:** Pumped diversion for irrigating a portion of 300 acres of farm land on river flood plain. This is a 30 HP and can pump 2000 gallons per minute. This acreage is supplied with irrigation water from two other sources; 1) 30 HP "Farm Pond Pump" with a 3000 gal/min capacity and 2) 50 HP Well Pump with a 3000 gal/min capacity. All three of these sources are used during the irrigation season. Various crops are grown depending on economy. These include beans, sugar beets, tomatoes, corn, wheat, barley, and alfalfa.

**Meter Number:** not recorded during field survey.

**Water Right Permit Number:** no number

San Joaquin River Section #16

Grayson Road Bridge to Maze Road Bridge (Highway 132)

# SAN JOAQUIN RIVER

## Section 16: Grayson Road Bridge to Maze Road Bridge (Hwy.132)

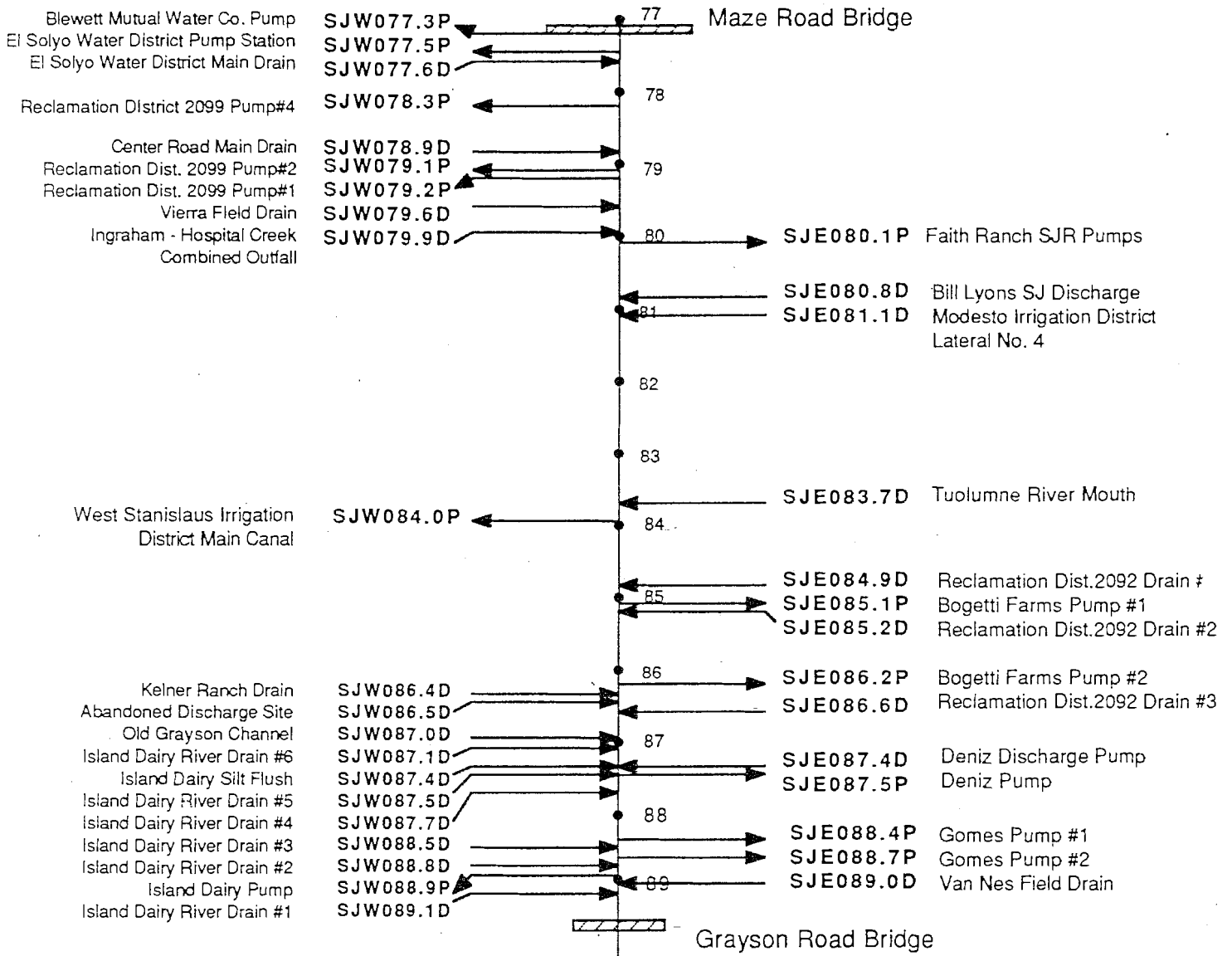

Figure A-16. Schematic Diagram for Water Diversions and Discharges on the San Joaquin River from Grayson Road Bridge to Maze Road Bridge (Hwy. 132) (River Section 16).

**SAN JOAQUIN RIVER DISCHARGE SITE**

**SITE ID#** SJW 089.1D

**Site Name:** Island Dairy River Drain #1

**River Mileage:** 089.1

**Site description, location and access:** A corrugated pipe enters San Joaquin River (Laird Slough) from the west bank and the pipe discharges below the surface of the river. The pipe is located approximately 50 feet north of the Laird Slough Bridge and is accessed via Grayson Road to Island Dairy.

**Township/Range/Section:** SW 1/4, NE 1/4, NW 1/4, Section 25, T4S, R7E  
(DWR# 4S/7E-25C)

**Latitude/Longitude:** Lat. 37° 33' 48"/Long. 121° 09' 05"

**County:** Stanislaus

**USGS Quad Map:** Westley

**WATER SOURCE**

**Type and source of water being discharged (description):** This drain is closed off and no longer in use.



**SAN JOAQUIN RIVER DISCHARGE SITE**

**SITE ID#** SJE 089.0D

**Site Name:** Van Nes Field Drain

**River Mileage:** 89.0

**Site description, location and access:** This field tail water drain is located on the east side of the San Joaquin River (Laird Slough) approximately 200 feet north of the Laird Slough Bridge. The drainage is from a small irrigated field (approximately 25 Acres) located adjacent to the north side of Grayson Road just east of the Laird Slough bridge. Access to the site is via Grayson Road too a dirt chicken ranch road located approximately 0.2 miles east of the Laird Slough.

**Township/Range/Section:** SW 1/4, NE 1/4, NW 1/4, Section 25, T4S, R7E  
(DWR# 4S/7E-25C)

**Latitude/Longitude:** Lat. 37° 33' 46"/Long. 121° 08' 58"

**County:** Stanislaus

**USGS Quad Map:** Westley

**WATER SOURCE**

**Type and source of water being discharged (description):** Irrigation tail water from 25 acre field.

**Comments on factors affecting water quality and quantity at the site:** Water quality but will reflect supply water quality but will carry a high sediment load.

**SAN JOAQUIN RIVER DIVERSION SITE**

**SITE ID#** SJW 088.9P

**Site Name:** Island Dairy Pump

**River Mileage:** 088.9

**Site description, location and access:** The pump is located on the west bank of the San Joaquin River (Laird Slough) approximately 500 feet north of the Laird Slough Bridge on Grayson Road. The pump is accessed via Grayson Road to the Island Dairy just west of the Laird Slough Bridge. There is a dirt road that circles the island along the west bank of the San Joaquin River.

**Township/Range/Section:** SW 1/4, NE 1/4, NW 1/4, Section 25, T4S, R7E  
(DWR# 4S/7E-25C)

**Latitude/Longitude:** Lat. 37° 33' 52"/Long. 121° 09' 06"

**County:** Stanislaus

**USGS Quad Map:** Westley

**Type of diversion and use of the water:** The pump has 50hp with a capacity of 15 feet/sec. This pump in combination with a well (75hp) supply water for the irrigation of corn silage and winter barley. Irrigation of approximately 275AC.

**Meter Number:** Turlock Irrigation District 45356

**Water Right Permit Number:** Not listed

## SAN JOAQUIN RIVER DISCHARGE SITE

SITE ID# SJW 088.8D

Site Name: Island Dairy River Drain #2

River Mileage: 088.8

**Site description, location and access:** The drain is a large concrete pipe which emerges from the west bank of the San Joaquin River. It is located low on the bank approximately 1100 feet (0.2 miles) north of the Grayson Road Bridge over Laird Slough. Access to the site is via Grayson Road to the Island Dairy located on the west side of the Laird Slough Bridge. There is a dirt road which circles the island along the west bank of the river.

**Township/Range/Section:** NW 1/4, NE 1/4, NW 1/4, Section 25, T4S, R7E  
(DWR# 4S/7E-25C)

**Latitude/Longitude:** Lat. 37° 33' 55"/Long. 121° 09' 08"

County: Stanislaus

USGS Quad Map: Westley

### WATER SOURCE

**Type and source of water being discharged (description):** This is not used as a drain, but is used in the spring when the river pump (SJW 088.9P) is first started to flush the silt from the pump site. Once the pumped water is free of silt the drain is closed until the following spring. It is not used as a field drain.

**SAN JOAQUIN RIVER DIVERSION SITE**

**SITE ID#** SJE 088.7P

**Site Name:** Gomes Pump #2

**River Mileage:** 88.7

**Site description, location and access:** The pump is located on the east bank of the San Joaquin River approximately 0.2 miles north of Laird Slough Bridge on Grayson Road. The site is accessed via Grayson Road to a dirt chicken ranch road located on the north side of Grayson Road approximately 0.2 miles east of the Laird Slough Bridge. The pump is at the end of this road as it veers toward the river.

**Township/Range/Section:** SW 1/4, SE 1/4, SW 1/4, Section 24, T4S, R7E  
(DWR# 4S/7E-24P)

**Latitude/Longitude:** Lat. 37° 34' 01"/Long. 121° 09' 06"

**County:** Stanislaus

**USGS Quad Map:** Westley

**Type of diversion and use of the water:** Unable to reach owner for additional information.

**Meter Number:** Turlock Irrigation District 51921

SAN JOAQUIN RIVER DISCHARGE SITE

SITE ID# SJW 088.5D

Site Name: Island Dairy River Drain #3

River Mileage: 088.5

Site description, location and access: Field tail water drain located on the west bank of the San Joaquin River 0.5 miles north of Grayson Road at Laird Slough. Access to the site is via Grayson Road to Island Dairy on the west side of Laird Slough. There is a dirt road that runs along the west bank of the river and the drain is located approximately 0.5 miles north of the Laird Slough bridge on this road.

Township/Range/Section: NE 1/4, SW 1/4, SW 1/4, Section 24, T4S, R9E  
(DWR# 4S/9E-24N)

Latitude/Longitude: Lat. 37° 34' 08"/Long. 121° 08' 45"

County: Stanislaus

USGS Quad Map: Westley

WATER SOURCE

Type and source of water being discharged (description): Tail water drainage from irrigation of silage corn from an 11 acre field. The source of water is from river pump (SJW 088.9P) or farm well. Drain is gravity.

**SAN JOAQUIN RIVER DIVERSION SITE**

**SITE ID#** SJE 088.4P

**Site Name:** Gomes Pump #1

**River Mileage:** 88.4

**Site description, location and access:** This orange pump is located on the east bank of the San Joaquin River 0.6 miles north of Grayson Road. The site is accessed via Grayson Road to Shiloh Road, located .7 miles east of the Laird Slough Bridge. Go north of Shiloh Road for 0.6 miles to Dos Rios Lane and then go west on Dos Rios Lane for 0.4 miles to a dirt road that goes south. Go south and then take the very next road to the right. Continue down this road to the river. The pump is about 200 feet south from the end of this farm road at the river.

**Township/Range/Section:** SE 1/4, NW 1/4, SW 1/4, Section 24, T4S, R9E  
(DWR# 4S/9E-24M)

**Latitude/Longitude:** Lat. 37° 34' 15"/Long. 121° 09' 20"

**County:** Stanislaus

**USGS Quad Map:** Westley

**Type of diversion and use of the water:** Unable to reach owner to get additional information.

**Meter Number:** Turlock Irrigation District 42647

**Water Right Permit Number:** Not listed

SAN JOAQUIN RIVER DISCHARGE SITE

SITE ID# SJW 087.7D

Site Name: Island Dairy River Drain #4

River Mileage: 087.7

**Site description, location and access:** The field tailwater drain is located on the west bank of the San Joaquin River approximately 1 mile north of the Laird Slough bridge. The site is accessed via Grayson Road to the Island Dairy on the west side of the Laird Slough Bridge. A dirt road runs north along the west bank of the river and the site is located on this road.

**Township/Range/Section:** SW 1/4, NW 1/4, NW 1/4, Section 24 T4S, R7E  
(DWR# 4S/7E-24D)

**Latitude/Longitude:** Lat. 37° 34' 42"/Long. 121° 09' 25"

**County:** Stanislaus

**USGS Quad Map:** Westley

WATER SOURCE

**Type and source of water being discharged (description):** Tail water drainage from the irrigation of silage corn on approximately 30 acres. The drain is gravity powered. The source of irrigation water is from the river pump (SJW 088.9P) or the farm well pump.

**Comments on factors affecting water quality and quantity at the site:** Quality at this site will reflect irrigation supply quality but will carry heavy sediment.

## SAN JOAQUIN RIVER DIVERSION SITE

SITE ID# SJE 087.5P

Site Name: Deniz Pump

River Mileage: 87.5

**Site description, location and access:** The irrigation pump is located on the east bank of the San Joaquin River north of Grayson Road. The pump is accessed via Grayson Road to Shiloh Road, located 0.7 miles east of Laird Slough Bridge. Go North on Shiloh Road 0.6 miles to Dos Rios Lane and southwest toward the river. The road will turn into a dirt road at the Deniz Dairy. Check in at dairy to get permission for access. Continue on dirt road (Dos Rios) to river. At river road turns right and becomes levee. The pump is located 0.5 miles north after this right turn onto the levee.

**Township/Range/Section:** SW 1/4, SW 1/4, SW 1/4, Section 13, T4S, R9E  
(DWR# 4S/9E-13N)

**Latitude/Longitude:** Lat. 37° 34' 53"/Long. 121° 09' 20"

County: Stanislaus

USGS Quad Map: Westley

**Type of diversion and use of the water:** This is a 50 H.P. irrigation pump used for the irrigation of approximately 460 acres. The crops grown are determined by the economy and include corn, beans, barley, and others.

**Meter Number:** 34643

**Water Right Permit Number:** Not listed



## SAN JOAQUIN RIVER DISCHARGE SITE

SITE ID# SJW 087.5D

Site Name: Island Dairy River Drain #5

River Mileage: 087.5

**Site description, location and access:** The drain is located approximately 1.5 miles north of Grayson Road bridge over Laird Slough on the west bank of the San Joaquin River. The site is accessed via Grayson Road to Island Dairy located on the west side of the Laird Slough bridge. From the dairy there is a dirt road that runs along the west bank of the river. The site is 1.5 miles north of the bridge, just before the river makes a sharp bend to the left (west). This drain was not noticed in field survey.

**Township/Range/Section:** SW 1/4, SW 1/4, SW 1/4, Section 13, T4S, R7E  
(DWR# 4S/7E-13N)

**Latitude/Longitude:** Lat. 37° 34' 56"/Long. 121° 09' 21"

**County:** Stanislaus

**USGS Quad Map:** Westley

### WATER SOURCE

**Type and source of water being discharged (description):** Tail water drainage from irrigated silage corn. The drainage is from a 20 acre field. This is a gravity drain.

**Comments on factors affecting water quality and quantity at the site:** Water quality will be reflected by the source water quality and will show increased sediment content.

**SAN JOAQUIN RIVER DISCHARGE SITE**

**SITE ID#** SJE 087.4D

**Site Name:** Deniz Discharge Pump

**River Mileage:** 87.4

**Site description, location and access:** The tail water discharge pump is located on the east bank of the San Joaquin River north of Grayson Road. The site is accessed via Grayson Road to Shiloh Road located 3/4 of a mile east of Laird Slough Bridge. Go north on Shiloh Road 0.6 miles to Dos Rios Lane and go west. Dos Rios Lane turns into dirt road at the Deniz Dairy. Stop at dairy to get permission for access. Continue west on dirt road toward river. At the river the road joins levee. The discharge pump is located approximately 0.4 miles north of dairy, on the levee road.

**Township/Range/Section:** NW 1/4, SW 1/4, SW 1/4, Section 13, T4S, R7E  
(DWR# 4S/7E-13N)

**Latitude/Longitude:** Lat. 37° 35' 01"/Long. 121° 09' 27"

**County:** Stanislaus

**USGS Quad Map:** Westley

**WATER SOURCE**

**Type and source of water being discharged (description):** This pump is used to return seepage water back to the river at times of high water. It is a 1 H.P. pump and is only used for flood control.

**Comments on factors affecting water quality and quantity at the site:** Only used for flood control and would not affect water quality.

**Meter Number:** Turlock Irrigation District 54130

SAN JOAQUIN RIVER DISCHARGE SITE

SITE ID# SJW 087.4D

Site Name: Island Dairy Silt Flush

River Mileage: 087.4

**Site description, location and access:** The drain is used to periodically flush silt from pipes. The discharge site is located 0.3 miles upstream from the Old Grayson Channel confluence on the west bank of the San Joaquin River. The site is accessed via Grayson Road to Island Dairy located on the west side of the Laird Slough Bridge. A dirt road runs along the west bank of the river

**Township/Range/Section:** NE 1/4, SE 1/4, SE 1/4, Section 14, T4S, R7E  
(DWR# 4S/7E-14R)

**Latitude/Longitude:** Lat. 37° 34' 59"/Long. 121° 09' 31"

County: Stanislaus

USGS Quad Map: Westley

WATER SOURCE

**Type and source of water being discharged (description):** This drain is used to flush silt from subsurface water lines when flow gets restricted or slowed by the accumulation of silt. It is not used as a field drain.

## SAN JOAQUIN RIVER DISCHARGE SITE

SITE ID# SJW 087.1D

Site Name: Island Dairy River Drain #6

River Mileage: 087.1

**Site description, location and access:** The field drain is on the west bank of the San Joaquin River located approximately 750 feet upstream of the Old Grayson Channel confluence. The site is accessed via Grayson Road to Island Dairy located on the west side of Laird Slough bridge. A dirt road circles the whole island along the west bank of the river.

**Township/Range/Section:** SW 1/4, SE 1/4, SE 1/4, Section 14, T4S, R7E  
(DWR# 4S/7E-14R)

**Latitude/Longitude:** Lat. 37° 34' 52"/Long. 121° 09' 43"

County: Stanislaus

USGS Quad Map: Westley

### WATER SOURCE

**Type and source of water being discharged (description):** Tailwater from irrigation of corn grown for silage. The drained field is approximately 30 acres and the water source is from river pump (SJW 088.9P) or farm well. This is a gravity drain.

## SAN JOAQUIN RIVER DISCHARGE SITE

SITE ID# SJW 087.0D

Site Name: Old Grayson Channel

River Mileage: 87.0

**Site description, location and access:** This is an old Channel of the San Joaquin River. It receives a number of discharges from tail water drains and surface runoff. Each of these individual discharges is described in a separate description for the Old Grayson Channel. Access to the site is via River Road to Minnie Road in Grayson. Minnie Road ends at a gate which can be accessed. Go through the gate and follow the dirt road east. When the road splits, veer right but take the road that continues east. This road will go right by the discharge point.

**Township/Range/Section:** NE 1/4, NW 1/4, NE 1/4, Section 23, T4S, R7E  
(DWR# 4S/7E-23B)

**Latitude/Longitude:** Lat. 37° 34' 51"/Long. 121° 09' 50"

**County:** Stanislaus

**USGS Quad Map:** Westley

### WATER SOURCE

**Type and source of water being discharged (description):** Surface tailwater from West Stanislaus Irrigation District and operational spill waters from West Stanislaus Irrigation District, upslope districts and the Delta Mendota Canal. There are no known tile drainage systems within the drainage area. This old channel receives drainage from approximately 8540 acres on the west side, and approximately 250 acres from Dairy Island on the east side (see map 1a). The sources of irrigation water to this drainage area are the Delta Mendota Canal, the West Stanislaus Irrigation District Laterals 2, 3, 4, 5, and 6 South, and on-farm irrigation wells (see map 1b).

**Comments on factors affecting water quality and quantity at the site:** The quantity of flow from each of the components will determine the effects on water quality.

## SAN JOAQUIN RIVER DISCHARGE SITE

SITE ID# SJE 086.6D

Site Name: Reclamation District No. 2092  
Drain No. 3

River Mileage: 86.6

**Site description, location and access:** This is a field tailwater drain located 0.2 miles upstream from the Kelner Ranch Drain Discharge (SJW 086.4D). This site is a corrugated 15" pipe which gravity flows to the river. Access to the site is via Shiloh Road which is located 0.6 miles east of the Grayson Road Bridge at Laird Slough. Go north on Shiloh Road for 0.4 miles to Dos Rios Road and go left. Follow Dos Rios Road to the end and it runs into the levee road. Go north along the levee for approximately 1 mile to a dirt road to the left down off the levee. Go down this road for 1500 feet to a dirt road too the left. Go left and the drain is located 300 feet ahead on the right.

**Township/Range/Section:** NE 1/4, NE 1/4, SW 1/4, Section 14, T4S, R7E  
(DWR# 4S/7E-14L)

**Latitude/Longitude:** Lat. 37° 35' 13"/Long. 121° 10' 02"

**County:** Stanislaus

**USGS Quad Map:** Westley

### WATER SOURCE

**Type and source of water being discharged (description):** The discharge water is composed of surface tailwater from 80 acres of irrigated land within the river floodplain.

**Comments on factors affecting water quality and quantity at the site:** Discharge quantity and quality will be influenced by amount and type of irrigation on-going.

## SAN JOAQUIN RIVER DISCHARGE SITE

SITE ID# SJW 086.5D

Site Name: Abandoned Discharge Site

River Mileage: 86.5

**Site description, location and access:** This site is an abandoned standpipe which was originally used for the discharge of surface tailwater. The site is located on the river flood plain 0.1 miles south of the Kelner Ranch Drain Discharge. Access to the site is off of River Road approximately 0.3 miles north of Minnie Road in Grayson. This farm road goes east toward the river approximately 0.2 miles and it veers left. The discharge site is straight ahead under the tree.

**Township/Range/Section:** NW 1/4, NE 1/4, SW 1/4, Section 14, T4S, R7E  
(DWR# 4S/7E-14L)

**Latitude/Longitude:** Lat. 37° 35' 12"/Long. 121° 10' 12"

County: Stanislaus

USGS Quad Map: Westley

### WATER SOURCE

**Type and source of water being discharged (description):** Surface tailwater from an abandoned 80 acre field located immediately south of the Kelner Ranch Drain and on the river flood plain side of the levee.

**Comments on factors affecting water quality and quantity at the site:** Field presently abandoned.

SAN JOAQUIN RIVER DISCHARGE SITE

SITE ID# SJW 086.4D

Site Name: Kelner Ranch Drain

River Mileage: 86.4

Site description, location and access: Open surface drain located 1.4 miles east of River Road. Access to the site is off of River Road approximately 0.85 miles north of Minnie Road in Grayson. Check with the Ranch house before entering the farm road that leads to the site. The drain exits under the levee before discharging into the San Joaquin River.

Township/Range/Section: SW 1/4, SE 1/4, NW 1/4, Section 14, T4S, R7E (DWR# 4S/7E-14F)

Latitude/Longitude: Lat. 37° 35' 17"/Long. 121° 10' 15"

County: Stanislaus

USGS Quad Map: Westley

WATER SOURCE

Type and source of water being discharged (description): This drain carries only tailwater and no known source of tile drainage water enters this drain. The tailwater is from 565 acres of irrigated land on the east side of River Road (see map 1a). The Kelner Ranch is the major source of drainage water to this drain. During the summer of 1986, tail water was rerouted away from the Kelner Ranch Drain to the Minnie Road Drain. This rerouting of tail water greatly reduced the quantity of water that flows through this drain. This site is monitored as site# STC034. The sources of irrigation water to the drainage area are the West Stanislaus Irrigation District Lateral 2 South and on-farm irrigation wells (see map 1b).

Comments on factors affecting water quality and quantity at the site: The tailwater in this drain is expected to have a very heavy sediment load.

MONITORING

Previous or ongoing monitoring at the site:

<u>Agency</u>	<u>Site ID#</u>	<u>Constituents</u>	<u>Frequency</u>	<u>Period of Record</u>	<u>Data Storage</u>
CVRWQCB	STC 051	Cl, SO <sub>4</sub> , Total Alkalinity, EC, B, Cu, Cr, Pb, Hg, Mo, Ni, Zn, Se & Suspended Sediments	monthly	4/86-present	CVRWQCB Files



**SAN JOAQUIN RIVER DIVERSION SITE**

**SITE ID #** SJE 086.2 P

**Site Name:** Bogetti Farms Pump No. 2

**River Mileage:** 86.2

**Site description, location and access:** There are three pumps located at this site. The site is located at river mile 86.2 along the east bank levee. Access to the site is via Shiloh Road which is located 0.6 miles east of the Grayson Road Bridge at Laird Slough. Go north on Shiloh Road for 0.4 miles to Dos Rios Road and go east. Dos Rios Road goes to a dairy and then turns into a dirt road. This dirt road goes by the dairy and turns right (north) and becomes the levee road. Go north on the levee road approximately 1.3 miles to a field access road. There are two roads about 1500 feet apart. Take the second one and go toward the river. The pumps are down past the trees about 100 feet.

**Township/Range/Section:** NW 1/4, SE 1/4, NW 1/4, Section 14, T4S, R7E  
(DWR# 4S/7E-14F)

**Latitude/Longitude:** Lat. 37° 35' 26"/Long. 121° 10' 13"

**County:** Stanislaus

**USGS Quad Map:** Westley

**Type of diversion and use of the water:** San Joaquin River water diverted for irrigation of approximately 1100 acres within Reclamation District No. 2092 and Bogetti Farms.

**Meter Number:** 1) 29386 Turlock Irrigation District  
2) 60902  
3) 33778

**Water Right Permit Number:** no #

## SAN JOAQUIN RIVER DISCHARGE SITE

SITE ID# SJE 085.2D

Site Name: Reclamation District 2092  
Drain No. 2 (Main Drain)

River Mileage: 85.2

**Site description, location and access:** Reclamation District 2092 main drain discharge. Flow moves in a slough on the river side of the levee. Access is via Shiloh Road which is located 0.6 miles east of Grayson Road Bridge at Laird Slough. Go north on Shiloh Road, approximately 1.4 miles, to where it takes a 90° turn to the right. Do not turn right, continue going straight ahead onto a dirt road that goes to the Bob Bogetti Ranch house. Stop at ranch house to get permission for access. Continue on dirt road and it will eventually turn into the levee and there will be a pond on the right side of the levee. From the pond continue along the levee approximately 0.4 miles and there will be a dirt road that goes down the side of the levee to the right. This road will put you on the edge of a field. The drain is in the southeastern corner of this field.

**Township/Range/Section:** NE 1/4, SE 1/4, SW 1/4, Section 11, T4S, R7E  
(DWR# 4S/7E-11P)

**Latitude/Longitude:** Lat. 37° 35' 52"/Long. 121° 10' 08"

**County:** Stanislaus

**USGS Quad Map:** Westley

### WATER SOURCE

**Type and source of water being discharged (description):** Discharge consists of a combination of tailwater and tile drainage water. The tile drainage water comes from 200 acres of tile drainage within Reclamation District 2092. Tailwater comes from both Reclamation District 2092 and Turlock Irrigation District.

**Comments on factors affecting water quality and quantity at the site:** Water quality will be affected by the proportion of tailwater and the drainage water.

**SAN JOAQUIN RIVER DIVERSION SITE**

**SITE ID #** SJE 085.1 P

**Site Name:** Bogetti Farms Pump No. 1

**River Mileage:** 85.1

**Site description, location and access:** First river diversion pump south of the Tuolumne River. Access is via Shiloh Road which is located 0.6 miles east of Grayson Road Bridge at Laird Slough. Go north on Shiloh Road until it makes a turn to the right. Do not turn right. Go straight ahead onto a dirt road to Bob Bogetti's ranch house. Stop at the ranch house to O.K. access. Continue on dirt road and it will turn into the levee. There will be a pond on the right side of levee. From the pond continue on the levee road for approximately 0.4 miles and take a dirt road to the right going down the side of the levee. This road will put you on the eastern edge of a field and the pump is located in the southeastern corner of this field on the river.

**Township/Range/Section:** SE 1/4, NE 1/4, SW 1/4, Section 11, T4S, R7E  
(DWR# 4S/7E-11H)

**Latitude/Longitude:** Lat. 37° 35' 54"/Long. 121° 10' 08"

**County:** Stanislaus

**USGS Quad Map:** Westley

**Type of diversion and use of the water:** River Water diverted for irrigation.

**Meter Number:** 60 901

**Water Right Permit Number:** not listed

## SAN JOAQUIN RIVER DISCHARGE SITE

SITE ID# SJE 084.9D

Site Name: Reclamation District 2092  
Drain No. 1

River Mileage: 84.9

**Site description, location and access:** Tailwater drain that discharges surface runoff from 150 acres of river flood plain irrigated land. Access to the site is via Shiloh Road which is located 0.6 miles east of Grayson Road Bridge at Laird Slough. Go north on Shiloh Road for approximately 1.4 miles and then continue straight onto dirt road. This dirt road will veer to the west going past Bob Bogetti's ranch house. Stop at the ranch house to O.K. access. Continue on the dirt road and it will turn into the levee road. There will be a pond on the right side of levee. From pond continue approximately 0.4 miles along levee to another dirt road that veers to the right going down the side of the levee. This will take you to a field and the drain is on the south end of field right next to the river.

**Township/Range/Section:** NE 1/4, NW 1/4, SW 1/4, Section 11, T4S, R7E  
(DWR# 4S/7E-11M)

**Latitude/Longitude:** Lat. 37° 36' 03"/Long. 121° 10' 17"

**County:** Stanislaus

**USGS Quad Map:** Westley

### WATER SOURCE

**Type and source of water being discharged (description):** Surface tailwater from 150 acres of irrigated land.

## SAN JOAQUIN RIVER DIVERSION SITE

SITE ID # SJW 084.0 P

Site Name: West Stanislaus I.D. Main Canal

River Mileage: 84.0

**Site description, location and access:** This is a major pump lift station for diversion of 76,000 acre-feet of water annually for irrigation of 24,800 acres. In addition it is the intake supply canal for RD 2100 (1500 acres), White Lake Mutual Water Company (1200 acres) and RD 2102 (500 acres). Access: Go west on West Stanislaus Road all the way to the end and veer right to levee on north bank of canal. The dike and pumps are approximately 0.2 miles ahead. West Stanislaus Road is located approximately 1.4 miles north of Grayson off of River Road.

**Township/Range/Section:**

SW 1/4, SE 1/4, NE 1/4, Section 10, T4S, R7E (DWR# 4S/7E-10H)

SE 1/4, SW 1/4, NE 1/4, Section 10, T4S, R7E (DWR# 4S/7E-10G)

**Latitude/Longitude:** Lat. 37° 36' 07"/Long. 121° 10' 50"

**County:** Stanislaus

**USGS Quad Map:** Westley

**Type of diversion and use of the water:** San Joaquin River Water is being diverted for irrigation of 24,800 acres. There are three other major diverters from the canal. Crops grown include beans, apricots, walnuts, tomatoes, melons, almonds, onions, cauliflower, peppers, alfalfa, wheat, barley, and cherries.

**Meter Number:** not recorded on field survey

**Water Right Permit Number:** 1987 or 1978

SAN JOAQUIN RIVER DISCHARGE SITE

SITE ID# SJE 083.7D

Site Name: Tuolumne River

River Mileage: 83.7

Site description, location and access: Tuolumne River inflow to the San Joaquin River.

Township/Range/Section: SE 1/4, NW 1/4, NW 1/4, Section 11, T4S, R7E  
(DWR# 4S/7E-11D)

Latitude/Longitude: Lat. 37° 36' 22"/Long. 121° 10' 21"

County: Stanislaus

USGS Quad Map: Westley

WATER SOURCE

Type and source of water being discharged (description): Natural surface runoff from the Tuolumne River Watershed.

Comments on factors affecting water quality and quantity at the site: Quality will vary with flow and the proportion of return flows in the river.

## SAN JOAQUIN RIVER DISCHARGE SITE

SITE ID# SJE 081.1D

Site Name: Modesto Irrigation District  
Lateral No. 4

River Mileage: 81.1D

Site description, location and access: The discharge is located on east bank of the San Joaquin River, 0.5 miles south of Old Fishermans Club off Hwy 132. Old Fishermans Club is located approximately 2.2 miles east of Hwy 132 bridge.

Township/Range/Section: NE 1/4, NE 1/4, SW 1/4, Section 34, T3S, R7E  
(DWR# 3S/7E-34L)

Latitude/Longitude: Lat. 37° 37' 50"/Long. 121° 11' 20"

County: Stanislaus

USGS Quad Map: Ripon, CA

### WATER SOURCE

Type and source of water being discharged (description): Two sources: 1) operational spill from the Modesto Irrigation District Lateral No. 4 and 2) surface drainage from irrigated fields on east bank south of discharge point.

Comments on factors affecting water quality and quantity at the site: Water quality will reflect the proportion of operational spill water from the Modesto Irrigation District (MID) Lateral No. 4 and the surface drainage that enters after the MID boundary.

### MONITORING

Previous or ongoing monitoring at the site:

<u>Agency</u>	<u>Site ID#</u>	<u>Constituents</u>	<u>Frequency</u>	<u>Period of Record</u>	<u>Data Storage</u>
Modesto Irrigation District	MID Lateral No. 4	Flow	monthly	4/86- present	MID Files

## SAN JOAQUIN RIVER DISCHARGE SITE

SITE ID# SJE 080.8D

Site Name: Bill Lyons San Joaquin Discharge

River Mileage: 80.8

**Site description, location and access:** Area drain located on east bank of the San Joaquin River. This gravity drain is located on river side of levee approximately 250 feet south of last skeet pad at the Old Fishermans Club. The road to Old Fishermans Club is located 2.2 miles east of Hwy 132 bridge on the right hand side.

**Township/Range/Section:** NE 1/4, SW 1/4, NW 1/4, Section 34, T3S, R7E  
(DWR# 3S/7E-34E)

**Latitude/Longitude:** Lat. 37° 38' 08"/Long. 121° 11' 26"

**County:** Stanislaus

**USGS Quad Map:** Ripon, CA

### WATER SOURCE

**Type and source of water being discharged (description):** The source is surface drainage water from irrigated fields on landward side of levee. Discharge site is part of the drainage system for Reclamation District 2031.

**Comments on factors affecting water quality and quantity at the site:** Quality will reflect surface irrigation water quality. The source of water in this area is both San Joaquin River and Modesto Irrigation District.



## SAN JOAQUIN RIVER DIVERSION SITE

SITE ID # SJE 080.1P

Site Name: Faith Ranch San Joaquin River  
Pumps

River Mileage: 80.1

Site description, location and access: Two irrigation pumps located on the east bank of the San Joaquin River approximately 1.6 miles east of Hwy 132 bridge on Hwy 132. The water is pumped from the San Joaquin River and piped under Hwy 132 to fields north of Hwy 132. One pump is a 30 Hp pump and the larger orange pump is 75 hp pump.

Township/Range/Section: SW 1/4, SW 1/4, SE 1/4, Section 28, T3S, R7E  
(DWR# 3S/7E-28Q)

Latitude/Longitude: Lat. 37° 38' 17"/Long. 121° 12' 07"

County: Stanislaus

USGS Quad Map: Ripon, CA

Type of diversion and use of the water: Pumped diversion for irrigation within the Faith Ranch and Reclamation District 2031. Water is used on 500-600 acres of irrigated pasture. The ranch attempts to irrigate this each year.

Meter Number: Modesto Irrigation District P418-7

Water Right Permit Number: no #

## SAN JOAQUIN RIVER DISCHARGE SITE

SITE ID# SJW 079.9D

Site Name: Ingram-Hospital Creek Combined  
Outfall

River Mileage: 79.9

**Site description, location and access:** This outfall is a major west side drain that receives surface tailwater, storm water and tile drainage from a large irrigated area upslope. The discharge point is south of Maze Road on the west side of the San Joaquin River. Access to the site is via project and nonproject levees.

**Township/Range/Section:** NE 1/4, NE 1/4, NW 1/4, Section 33, T3S, R7E  
(DWR# 3S/7E-33C)

**Latitude/Longitude:** Lat. 37°38' 11"/Long. 121°12' 14"

**County:** Stanislaus

**USGS Quad Map:** Ripon, CA

### WATER SOURCE

**Type and source of water being discharged (description):** This drain serves as a major area surface drain receiving tile drainage water and surface tailwater from West Stanislaus Irrigation District, RD 2100, RD 2099 and other water districts. Flows of tailwater come from irrigated fields in the West Stanislaus Irrigation District and tile drainage water from scattered tile drains within the area closest to the river (East of Highway 33 and mostly east of River Road). This drain receives surface drainage from approximately 13,195 acres. Within the service area there are approximately 2290 acres of tile drainage systems. The flows come from:

1. **White Lake Mutual-Hagemann Ranch Main Drain:** This is the main drain that discharges all the surface drainage from approximately 2955 acres within White Lake Mutual Water Company and Reclamation District 2100 (Hagemann Ranch) lands (see map 1a). The drain receives subsurface drainage from approximately 1265 acres (see map 1b). The site is located in the north east corner of the ranch. Access is to proceed east off of River Road for 3.7 miles on the Main Canal Road, then proceed north on the levee road for 1.6-1.7 miles to the main pumping station. This drain is monitored as site# STC036. The source of irrigation water is from the West Stanislaus Irrigation District Main Canal and on-farm irrigation wells (see map 1c).
2. **Hagemann Ranch Southern Drain P#mp:** This drain receives surface drainage from approximately 335 acres on the river side of the project levee. The area also has a subsurface drainage system for approximately 185 acres. This drain is monitored as site# STC035. This discharge is to a slough leading to River mile 79.9. Access to the site is through the Hagemann Ranch. Proceed east off of River Road 3.7 miles on the Main Canal Road, then proceed north on the levee road for 0.9 miles to the pumping station. The source of irrigation water to this area is the West Stanislaus Irrigation District Main Canal.
3. **Hospital-Ingram Creek Combined flow at Vierra Dairy:** The water in the combination of Hospital and Ingram Creek is mostly surface tailwater from

approximately 9900 acres (see map 3a). The drain also receives tile drainage from approximately 840 acres of farm land on the east side of Highway 33 (see map 3b). Hospital Creek receives surface drainage from 2950 acres and Ingram Creek from 6950 acres, but does contain tile drainage water from a significant portion of irrigated land. A monitoring site is located on the River Bank Road 1/2 mile east of the Vierra Dairy (STC 037). Site access is east off of River Road on Dairy Road. Proceed past the Vierra Dairy then turn south for 1/4 mile then turn east on the northern levee of the combined Ingram and Hospital Creek. Sampling site is 1/2 mile from the Dairy just prior to the turn in the levee at the large Oak tree. The irrigated land within the drainage areas of Hospital and Ingram Creeks receive supply water from the Delta Mendota Canal, the West Stanislaus Irrigation District Laterals 3, 4, 5, and 6 north, and on-farm irrigation wells (see map 3c).

**Comments on factors affecting water quality and quantity at the site:** Water quality at this site will be reflected in the proportion of tailwater and tile drainage water at these sites.

**MONITORING**

Previous or ongoing monitoring at the site:

<u>Agency</u>	<u>Site ID#</u>	<u>Constituents</u>	<u>Frequency</u>	<u>Period of Record</u>	<u>Data Storage</u>
CVRWQCB	STC 037	Cl, SO <sub>4</sub> , Total Alkalinity, EC, B, Cu, Cr, Pb, Hg, Mo, Ni, Zn, Se & Suspended Sediments	monthly	11/85-present	CVRWQCB Files
West Stanislaus Irrigation District	STC 037	EC, Suspended Sediments, Flow	monthly (May-Sept)	4/86-present	WSID Files

## SAN JOAQUIN RIVER DISCHARGE SITE

SITE ID# SJW 079.6D

Site Name: Vierra Field Drain

River Mileage: 79.6

**Site description, location and access:** The field drain is located on the west bank of the San Joaquin River south of Maze Road. Access is via Dairy Road to the levee. Go north on levee to river and turn right on non-project levee to irrigated field. The drain is on the west side of field.

**Township/Range/Section:** SE 1/4, SW 1/4, NW 1/4, Section 33, T3S, R7E  
(DWR# 3S/7E-33E)

**Latitude/Longitude:** Lat. 37° 37' 55"/Long. 121° 12' 30"

**County:** Stanislaus

**USGS Quad Map:** Ripon, CA

### WATER SOURCE

**Type and source of water being discharged (description):** Field tail water drain that serves irrigated area on river flood plain. The total acreage is 40 acres of irrigated land. The water source for this site is the diversion pump at site SJW 079.2P (Reclamation District No. 2099 Pump No. 1).

**Comments on factors affecting water quality and quantity at the site:** Water quality will reflect diverted river water quality except for increase sediment load.

**SAN JOAQUIN RIVER DIVERSION SITE**

**SITE ID #** SJW 079.2 P

**Site Name:** Reclamation District No. 2099  
Pump No. 1

**River Mileage:** 79.2

**Site description, location and access:** The diversion pump is located on west bank of the San Joaquin River. South of Maze Road. The site is accessed via Dairy Road to the project levee. Site is located 0.1 miles south of site SJW 079.1P.

**Township/Range/Section:** SE 1/4, NW 1/4, SW 1/4, Section 33, T3S, R7E  
(DWR# 3S/7E-33M)

**Latitude/Longitude:** Lat. 37° 37' 39"/Long. 121° 12' 33"

**County:** Stanislaus

**USGS Quad Map:** Ripon, CA

**Type of diversion and use of the water:** Pumped diversion for irrigation of 185 acres of land within Reclamation District No. 2099.

**Meter Number:** 351479

**Water Right Permit Number:** no #

**SAN JOAQUIN RIVER DIVERSION SITE**

**SITE ID #** SJW 079.1 P

**Site Name:** Reclamation District No. 2099  
Pump No. 2

**River Mileage:** 79.1

**Site description, location and access:** The diversion pump is located south of Maze Road on the west bank of the San Joaquin River. The pump diverts water from the San Joaquin River to a irrigation ditch on landward side of levee. The pump supplies water to 134 acres within Reclamation District No. 2099. Access to the site is via River Road, 1.8 miles south from Maze Road. Go east on Center Road (it is a dirt road in this direction) to the levee road. The pump is located approximately 0.5 miles south on the levee road.

**Township/Range/Section:** NW 1/4, SW 1/4, SE 1/4, Section 32, T3S, R7E  
(DWR# 3S/7E-33N)

**Latitude/Longitude:** Lat. 37° 37' 36"/Long. 121° 12' 43"

**County:** Stanislaus

**USGS Quad Map:** Ripon, CA

**Type of diversion and use of the water:** Pumped diversion for irrigation of 134 acres within Reclamation District No. 2099.

**Meter Number:** T92212 (PG&E)

**Water Right Permit Number:** 1476 (El Solyo Water District)  
**License Number:** 1280

SAN JOAQUIN RIVER DISCHARGE SITE

SITE ID# SJW 078.9D

Site Name: Center Road Main Drain

River Mileage: 78.9

Site description, location and access: The discharge pump is located on the west bank of the SJR approximately 1.2. miles south of Maze Road. The pump is accessed by going south on River Road approximately 2 miles to Center Road, turn east. At the end of Center Road veer left to levee. The discharge pump is located on landward side on non-project levee near river 50 feet north of project levee.

Township/Range/Section: SE 1/4, NE 1/4, SE 1/4, Section 32, T3S, R7E (DWR# 3S/7E-32J)

Latitude/Longitude: Lat. 37° 37' 43"/Long. 121° 12' 50"

County: Stanislaus

USGS Quad Map: Ripon, CA

WATER SOURCE

Type and source of water being discharged (description): Tail water and tile drainage water from irrigated land within El Solyo Water District and Reclamation District No. 2099. Inflow consists of tail water from approximately 1220 acres (see map 1a) and tile drainage from approximately 100 acres in Reclamation District No. 2099 only (see map 1b). This site is monitored as site# STC043. The sources of irrigation water to this area are the El Solyo Water District Pump and from Reclamation District No. 2099, pumps 1,2, and 4 (see map 1c).

Meter Number: 2T4588 (PG&E)

Comments on factors affecting water quality and quantity at the site: Water quality will depend on the amount of tailwater being discharged. The pump is an emergency outlet when river levels are high otherwise all discharges are by gravity flow.

MONITORING

Previous or ongoing monitoring at the site:

<u>Agency</u>	<u>Site ID#</u>	<u>Constituents</u>	<u>Frequency</u>	<u>Period of Record</u>	<u>Data Storage</u>
CVRWQCB	STC 043	Ca, SO <sub>4</sub> , Total Alkalinity, EC, B, Cu, Cr, Pb, Hg, Mo, Ni, Zn, & Suspended Sediments	monthly	12/85-present	CVRWQCB Files
West Stanislaus Irrigation District	STC 037	EC, Suspended Sediments	monthly (May-Sept)	4/86-present	WSID Files

**SAN JOAQUIN RIVER DIVERSION SITE**

**SITE ID #** SJW 078.3 P

**Site Name:** Reclamation District No. 2099  
Pump No. 4

**River Mileage:** 78.3

**Site description, location and access:** The diversion pump is located 250 feet north of DWR gaging station on the west bank of the San Joaquin River and 200 feet south of the Hetch Hetchery Aqueduct River crossing south of Maze Road. Pump accessed via dirt road that runs parallel Hetch Hetchery Aqueduct. To reach this dirt road go south on River Road from Maze Road approximately 1.3. miles to Orchard Road, turn east. Continue to the end of Orchard Road and veer left and then right on to the dirt road going toward river. This road ends at the levee and the pump is 300 feet south of intersection.

**Township/Range/Section:** SW 1/4, NE 1/4, NE 1/4, Section 32, T3S, R7E  
(DWR# 3S/7E-32A)

**Latitude/Longitude:** Lat. 37° 38' 08"/Long. 121° 12' 58"

**County:** Stanislaus

**USGS Quad Map:** Ripon, CA

**Type of diversion and use of the water:** Pumped diversion for irrigation of 179 acres within Reclamation District No. 2099.

**Meter Number:** 2T4588 (PG&E)

**Water Right Permit Number:** no #



## SAN JOAQUIN RIVER DISCHARGE SITE

SITE ID# SJW 077.6D

Site Name: El Solyo Water District Main Drain

River Mileage: 77.6

**Site description, location and access:** The discharge pump is located on the west side of the San Joaquin River 900 feet south of Maze Road. The pump is located on the landward side of the levee with a pipe going through the levee. Access: on River Road go .3 miles south of Maze Blvd. and take a left turn on a dirt road. This dirt road turns south at the river. The first turn to the left past the El Solyo Water District will be the levee. The levee will make a 90° turn to the right at the treeline and the discharge is right there. The pump is located 400 feet south of the El Solyo Water District Main Pumping station.

**Township/Range/Section:** NE 1/4, SW 1/4, SW 1/4, Section 29, T3S, R7E  
(DWR# 3S/7E-29N)

**Latitude/Longitude:** Lat. 37° 38' 22"/Long. 121° 13' 40"

**County:** Stanislaus

**USGS Quad Map:** Ripon, CA

**Meter Number:** 2T4588

### WATER SOURCE

**Type and source of water being discharged (description):** This discharge receives tailwater from approximately 690 acres of irrigated land within El Solyo Water District and the Manuel Vierra Dairy during the irrigation season and surface runoff from the same acreage during the wet season. The pump is used during high water in the river. It is gravity flow during low water periods. In addition the discharge point receives tile drainage from approximately 325 acres of land within the El Solyo Water District. This site is monitored as site# STC044. The source of irrigation water to this area is the El Solyo Water District Main Canal.

**Comments on factors affecting water quality and quantity at the site:** Tile drainage from 325 acres of land within the El Solyo Water District also will affect water quality depending upon the amount of tailwater blended in.

### MONITORING

Previous or ongoing monitoring at the site:

<u>Agency</u>	<u>Site ID#</u>	<u>Constituents</u>	<u>Frequency</u>	<u>Period of Record</u>	<u>Data Storage</u>
-CVRWQCB	STC 044	Cl, SO <sub>4</sub> , Total Alkalinity, EC, B, Cu, Cr, Pb, Hg, Mo, Ni, Zn, & Suspended Sediments	monthly	11/85-present	CVRWQCB Files
West Stanislaus Irrigation District	STC 044	EC, Suspended Sediments	monthly (May-Sept)	4/86-present	WSID Files

SAN JOAQUIN RIVER DIVERSION SITE

SITE ID # SJW 077.5 P

Site Name: El Solyo Water District Pumping  
Station

River Mileage: 77.5

Site description, location and access: The pumping station is located on the west bank of San Joaquin River 500 feet south of Maze Road. The pumping station consists of 1-50 hp pump, 1-100 hp pump and 3-75 hp pumps.

Township/Range/Section: NE 1/4, SW 1/4, SW 1/4, Section 29, T3S, R7E  
(DWR# 3S/7E-29N)

Latitude/Longitude: Lat. 37° 38' 23"/Long. 121° 13' 42"

County: Stanislaus

USGS Quad Map: Ripon, CA

Type of diversion and use of the water: Pumped diversion for irrigation of 3700 acres within the El Solyo Water District.

Meter Number: 37T979 (PG&E)

Water Right Permit Number: 1476  
License Number: 1280

## SAN JOAQUIN RIVER DISCHARGE SITE

SITE ID# SJW 077.4D

Site Name: Blewett Drain

River Mileage: 77.4

**Site description, location and access:** This drain discharges to the San Joaquin River from the west bank approximately 300 feet south of Maze Boulevard. This drain runs parallel to and along the north side of the El Solyo canal. The discharge site is located between the El Solyo and Blewett pumping stations.

**Township/Range/Section:** NE 1/4, SW 1/4, SW 1/4, Section 29, T3S, R7E  
(DWR# 3S/7E-29N)

**Latitude/Longitude:** Lat. 37° 38' 26"/Long. 121° 13' 41"

County: Stanislaus

USGS Quad Map: Ripon, Ca

### WATER SOURCE

**Type and source of water being discharged (description):** This drain carries only irrigation tailwater and operational spill water from the West Stanislaus Irrigation District. No tile drainage is known to enter this drain. This drain receives drainage from approximately 3400 acres. The area is bounded on the north by Highway 132 and Blewett Road, and on the south by the El Solyo Canal (see map 1a). This site is monitored as Site# STC 051. The irrigation water supply to this area comes from West Stanislaus Irrigation District Laterals 4, 5, and 6 North.

**Comments on factors affecting water quality and quantity at the site:** The tailwater in this drain is expected to have a high sediment load.

### MONITORING

Previous or ongoing monitoring at the site:

<u>Agency</u>	<u>Site ID#</u>	<u>Constituents</u>	<u>Frequency</u>	<u>Period of Record</u>	<u>Data Storage</u>
CVRWQCB	STC 051	Cl, SO <sub>4</sub> , Total Alkalinity, EC, B, Cu, Cr, Pb, Hg, Mo, Ni, Zn, & Suspended Sediments	monthly	5/86-present	CVRWQCB Files
West Stanislaus Irrigation District	Blewett Drain	EC & Suspended Sediments	Monthly (May-Sept)	4/86-present	WSID Files

**SAN JOAQUIN RIVER DIVERSION SITE**

**SITE ID #** SJW 077.3 P

**Site Name:** Blewett Mutual Water Co. Maze  
Road Pump-South

**River Mileage:** 77.3

**Site description, location and access:** The diversion pump is located on the west bank of San Joaquin River 400 feet south of Maze road. This structure is 100 feet north of the El Solyo pumping station intake and can be accessed via dirt road perpendicular to levee and river.

**Township/Range/Section:** NE 1/4, SW 1/4, SW 1/4, Section 29, T3S, R7E  
(DWR # 3S/7E-29N)

**Latitude/Longitude:** Lat. 37° 38' 27"/Long. 121° 13' 42"

**County:** Stanislaus

**USGS Quad Map:** Ripon, CA

**Type of diversion and use of the water:** Pumped diversion for irrigation of 1100 acres of land located north of the El Solyo Water District main lift canal and south of Maze Road (Highway 132). Crops grown include wheat, tomatoes, alfalfa, sugar beets, and lima beans.

**Meter Number:** Not recorded - this site was missed on field investigation.

**Water Right Permit Number:** 1195

San Joaquin River Section #17

Maze Road Bridge (Highway 132) to Airport Way (Vernalis)

SAN JOAQUIN RIVER

Section 17: Maze Road Bridge (Hwy.132) to Airport Way (Vernalis)

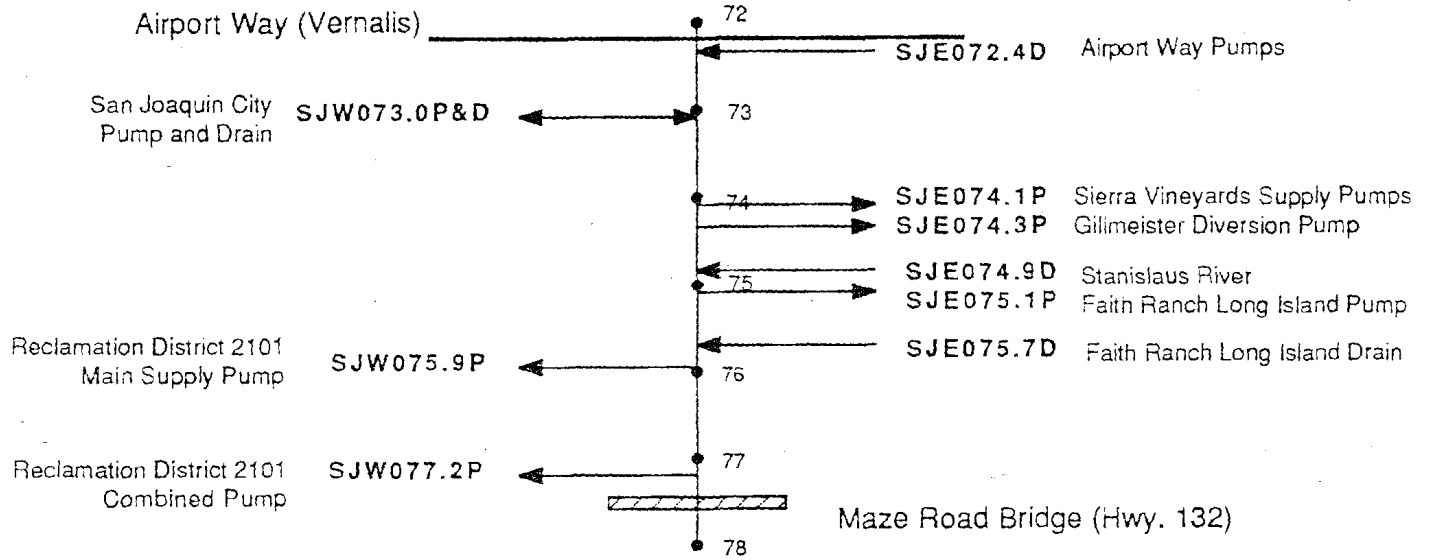

Figure A-17. Schematic Diagram for Water Diversions and Discharges on the San Joaquin River from Maze Road Bridge (Hwy. 132) to Airport Way (Vernalis) (River Section 17).

SAN JOAQUIN RIVER DISCHARGE SITE

SITE ID# SJE 072.4D

Site Name: Airport Way Pumps

River Mileage: 72.4

**Site description, location and access:** Two surface water discharge pumps are located on the east bank of the San Joaquin River approximately 400 feet south of Airport Way. The pumps are on the landward side of the levee with 15"+ diameter discharge lines through the levee to the river. On the day of our inspection one of the pumps was dismantled. At present only a 50hp discharge pump exists. Originally two pumps were located at this site. The two pumps were installed 30 years ago. One pump was converted from diesel to electric 5 years ago. The second pump (diesel) was pulled in the 1982 San Joaquin River Flood. The remaining electric pump operates but is temporarily disconnected.

**Township/Range/Section:** SW 1/4, SE 1/4, NW 1/4, Section 13, T3S, R6E  
(DWR# 3S/6E-13F)

**Latitude/Longitude:** Lat. 37° 40' 33"/Long. 121° 15' 46"

**County:** San Joaquin

**USGS Quad Map:** Vernalis

WATER SOURCE

**Type and source of water being discharged (description):** This discharge is a pumped discharge composed of surface runoff during the rainy season and surface tailwater from irrigated fields during the irrigation season.

**Comments on factors affecting water quality and quantity at the site:** Discharge water likely comes from the 402 acres west of Lake Avenue (as shown on the map supplied by RD 2064). A field determination is needed to assess the significance of ponded water in this area and whether ponded water is discharged through this pump system.

**Pump Meter#:** 7T9121

## SAN JOAQUIN RIVER DISCHARGE SITE

SITE ID# SJW 073.0D

Site Name: San Joaquin City Drain

River Mileage: 73.0

**Site description, location and access:** The actual site is a man made ditch which is used for allowing San Joaquin River water to flow westward to a diversion pump. The diversion pump is used to irrigate land upslope (west of Kasson Road). There are three discharges into this man made ditch. At times of pumping, these discharges are recycled with the irrigation water otherwise they flow or seep to the San Joaquin River. The site is located 300 feet east of Kasson Road, 0.5 miles south of Durham Ferry Road.

**Township/Range/Section:** SW 1/4, SE 1/4, SW 1/4, Section 13, T3S, R6E  
(DWR# 3S/6E-13P)

**Latitude/Longitude:** Lat. 37° 40' 08"/Long. 121° 15' 43"

County: San Joaquin

USGS Quad Map: Vernalis

### WATER SOURCE

**Type and source of water being discharged (description):** The three discharges are:

- a. Greenwood Road Drain; the Greenwood Road Drain carries both tile drainage and surface tailwater. The total drainage area supplying the Greenwood Drain is approximately 1620 acres. The area is bound on the west by the West Stanislaus Irrigation District Lateral 4 North at Vernalis, and on the east by McCracken Road and Greenwood Road (see map 1a). The tile drainage that enters this system comes from the McCracken Road Drain (see map 1b). The McCracken Road Drain was installed in 1967 to drain a 250 acre orchard on the west side of McCracken Road. The Greenwood Avenue Drain also picks up high ground water. The Greenwood Avenue Drain flows under Kasson Road and discharges to a Slough which either flows to the man-made diversion ditch at Mile 73.0 or seeps to the river. The Greenwood Road Drain is monitored at Kasson Road as Site# SJC012. There is a small drainage area of 190 acres in between the Greenwood Road drainage area and Kasson Road (see map 1a). This area drains into the same slough as the Greenwood Road Drain.

The sources for irrigation water to the Greenwood Road drainage area are the West Stanislaus Irrigation District Lateral 4 North and on-farm irrigation wells. The small drainage area east of the Greenwood Road drainage area appears to receive water from irrigation wells and possibly from the San Joaquin River via a diversion pump (SJW073.OP).

- b. Yasui Ranch Surface Drain; This drain carries both tile drain water and surface tailwater. Much of the runoff in the drain is recaptured in tailwater return systems upslope. The flow that does manage to cross Kasson Road flows to the man-made diversion ditch at Mile 73.0



or seeps to the river. The tile drainage comes from about 400-500 acres upslope and to the east of West Stanislaus Irrigation District.

Surface tailwater comes from approximately 900 acres south of Durham Ferry Road (see map 2a). The site is monitored as Site# SJC030. The sources of irrigation water to this drainage area are on-farm irrigation wells, recaptured tailwater systems, and from the West Stanislaus Irrigation District Lateral 4 North.

- c. RD 2101 Main Drain (Coddington Drain); The RD 2101 Main Drain carries only surface return flows (tailwater) and operational spill water from Blewett Reclamation District No. 2101. The drainage area consists of 1420 acres of irrigated land (see map 3a). The area is bound by Highway 132 on the south, McCracken Road on the West, and Greenwood Road on the north. This discharge is through levee (gravity) in low river flow periods and by pumping at other times. The discharge is into the same slough that the Greenwood Road drain discharges into. This slough either flows to the man-made diversion ditch at Mile 73.0 or seeps into the river. This discharge is 1000 feet south of the Greenwood Road discharge. This site is monitored as Site# SJC018. The source of irrigation water to the drainage area on the east side of Kasson Road are two San Joaquin River diversion pumps operated by the Blewett Reclamation District No. 2101. The area on the west side of Kasson Road receives its supply water from the West Stanislaus Irrigation District.

**Comments on factors affecting water quality and quantity at the site:** The source of water for each discharge will vary. The quality will depend upon the amount of surface water, tile drainage water and other inputs. A significant source may be the numerous wells in the area that supply water.

**MONITORING**

Previous or ongoing monitoring at the site:

<u>Agency</u>	<u>Site ID#</u>	<u>Constituents</u>	<u>Frequency</u>	<u>Period of Record</u>	<u>Data Storage</u>
CVRWQCB	STC 027	Ca, SO <sub>4</sub> , Total	monthly	8/86- present	CVRWQCB Files
	STC 030	Alkalinity, EC,	when		
	STC 018	B, Cu, Cr, Pb, Hg, Mo, Ni, Zn, & Suspended Sediments	flowing		

## SAN JOAQUIN RIVER DIVERSION SITE

SITE ID# SJW 073.0 P

Site Name: San Joaquin City Pump

River Mileage: 73:0

**Site description, location and access:** The diversion pump is 300 feet east of Kasson Road, 0.5 miles south of Durham Ferry Road. The diversion pump is located 1000 feet west of the San Joaquin River with a man-made ditch used to allow San Joaquin River water to flow westward to the pumps. Access to the site is via Kasson Road.

**Township/Range/Section:** SW 1/4, SE 1/4, SW 1/4, Section 13, T3S, R6E  
(DWR # 3S/6E-13P)

**Latitude/Longitude:** Lat. 37° 40' 08"/Long. 121° 15' 43"

County: San Joaquin

USGS Quad Map: Vernalis

**Type of diversion and use of the water:** Pumped diversion for irrigation of 220 acres. Crops grown include alfalfa, sugar beets, barley, beans, and tomatoes.

**Meter Number:** 177T39 (PG&E)

**SAN JOAQUIN RIVER DIVERSION SITE**

**SITE ID #** SJE 074.1 P

**Site Name:** Sierra Vineyards Supply Pumps

**River Mileage:** 74.1

**Site description, location and access:** There are 2 diversion pumps at this site; each feeding into a combined supply system. Site is noted by an extensive protection barrier on the upstream side. Site is located on the eastern levee, 0.5 miles north along the levee road from its junction with Two Rivers Road. Pumps are located within River Junction Reclamation District No. 2064.

**Township/Range/Section:** NW 1/4, SE 1/4, SW 1/4, Section 18, T3S, R7E.  
(DWR # 3S/7E-18P)

**Latitude/Longitude:** Lat. 37° 40' 12"/Long. 121° 14' 43"

**County:** San Joaquin

**USGS Quad Map:** Ripon, CA

**Type of diversion and use of the water:** San Joaquin River water diverted for irrigation use within Reclamation District No. 2064.

**Meter Number:** 2488T9 (PG&E)

**Water Right Permit Number:** 4460 (River Junction Reclamation District)  
c/o Stanley Mortensen, Secretary  
1002 Pine Street  
Manteca, CA 95336  
(209) 823-3480

**SAN JOAQUIN RIVER DIVERSION SITE**

**SITE ID #** SJE 074.3 P

**Site Name:** Gillmeister Diversion Pump

**River Mileage:** 74.3

**Site description, location and access:** Single 50hp diversion pump located on the eastern levee 100 ft south of the levee intersection with Two Rivers Road. Pump (8000 gpm rating) is located within the River Junction Reclamation District No. 2064. Actual diversion site is located off the main channel in a side slough of Sturgeon Bend

**Township/Range/Section:** NE 1/4, NE 1/4, SW 1/4, Section 18, T3S, R7E  
(DWR # 3S/7E-18L)

**Latitude/Longitude:** Lat. 37° 40' 22"/Long. 121° 14' 30"

**County:** San Joaquin

**USGS Quad Map:** Ripon, CA

**Type of diversion and use of the water:** San Joaquin River water diverted for irrigation of 165 acres within the River Junction Reclamation District No. 2064. Crops grown include pears, beans, corn, and oats. Diversion channel is dug up to the pumps and is often turbid in appearance. Should be checked for discharges.

**Meter Number:** T63144 (PG&E)

**Water Right Permit Number:** 4460 (River Junction Reclamation District)  
c/o Stanley Mortensen, Secretary  
1002 Pine Street  
Manteca, CA 95336  
(209) 823-3480

## SAN JOAQUIN RIVER DISCHARGE SITE

SITE ID # SJE 074.9D

Site Name: Stanislaus River

River Mileage: 74.9

**Site description, location and access:** The Stanislaus River discharges into the San Joaquin River at mile 74.9. Access to the site is by boat.

**Township/Range/Section:** NW 1/4, NW 1/4, NE 1/4, Section 19, T3S, R7E  
(DWR # 3S/7E-19B)

**Latitude/Longitude:** Lat. 37° 39' 54"/Long. 121° 14' 26"

County: Stanislaus

USGS Quad Map: Ripon, CA

### WATER SOURCE

**Type and source of water being discharged (description):** Natural stream flow from the Sierra Mountains.

**Comments on factors affecting water quality and quantity at the site:** Discharges to the Stanislaus River and diversions from the river are likely to affect water quality and quantity at this site.

**SAN JOAQUIN RIVER DIVERSION SITE**

**SITE ID #** SJE 075.1 P

**Site Name:** Faith Ranch Long Island Pump

**River Mileage:** 75.1

**Site description, location and access:** Single pump located on the San Joaquin River at mile 75.1. Pump serves water to 70 acres of land on the river side of the levee. Access to the pump is via farm roads on the river side of the levee. Access is difficult in the wet season. This pump is located outside the boundaries of Reclamation District No. 2031. The pump is a 50hp pump.

**Township/Range/Section:** NW 1/4, SW 1/4, NE 1/4, Section 19, T3S, R7E  
(DWR # 3S/7E-19G)

**Latitude/Longitude:** Lat. 37° 39' 41"/Long. 121° 14' 19"

**County:** Stanislaus

**USGS Quad Map:** Ripon, CA

**Type of diversion and use of the water:** San Joaquin River water diverted for irrigation use within lands immediately adjacent to the river. The irrigated area is 70 acres of irrigated pasture which is farmed most every year.

**Meter Number:** Z11629 (Modesto Irrigation District)

**Water Right Permit Number:** not found

## SAN JOAQUIN RIVER DISCHARGE SITE

SITE ID # SJE 075.7D

Site Name: Faith Ranch Long Island Drain

River Mileage: 75.7

**Site description, location and access:** This drain carries tailwater from approximately 70 acres of irrigation pasture on the river side of the levee. This drain carries tailwater from lands irrigated by Faith Ranch Long Island Pump (located at SJE 075.1P). Access to the drain is via farm roads on the river side of the levee. This drain is located outside the boundaries of Reclamation District No. 2031.

**Township/Range/Section:** NE 1/4, SW 1/4, SE 1/4, Section 19, T3S, R7E  
(DWR # 3S/7E-19Q)

**Latitude/Longitude:** Lat. 37° 39' 15"/Long. 121° 14' 09"

**County:** Stanislaus

**USGS Quad Map:** Ripon, CA

### WATER SOURCE

**Type and source of water being discharged (description):** Tailwater from irrigation of 70 acres of pasture and forage. Discharge is by gravity flow via a pipe under the access road adjacent to the river.

**Comments on factors affecting water quality and quantity at the site:** Discharge quality should reflect the quality of water diverted from the San Joaquin River for irrigation.

**SAN JOAQUIN RIVER DIVERSION SITE**

SITE ID # SJW 075.9 P

Site Name: RD 2101 Main Supply Pump

River Mileage: 75.9

Site description, location and access: River diversion pump for Blewett Reclamation District No. 2101 which serves as a main supply pump for the district. Water is pumped into a concrete lined ditch which runs parallel north and south to the levee. Access to the site is via the river levee off of Maze Road. Site is located 1.2 miles north of Maze Road along the levee.

Township/Range/Section: NE 1/4, NE 1/4, NE 1/4, Section 30, T3S, R7E  
(DWR # 3S/7E-30A)

Latitude/Longitude: Lat. 37° 39' 08"/Long. 121° 13' 59"

County: Stanislaus

USGS Quad Map: Ripon, CA

Type of diversion and use of the water: Pumped diversion of San Joaquin River water. Irrigation is the intended use within Blewett Reclamation District No. 2101.

Meter Number: T92019

Water Right Permit Number: 1195 (Blewett Mutual Water Co., et al., Coddington, Phillip K. et al., McCombs, W. Wayne et al.)

License Number: 4934



**SAN JOAQUIN RIVER DIVERSION SITE**

**SITE ID#** SJW 077.2 P

**Site Name:** RD 2101 Combined Pump

**River Mileage:** 77.2

**Site description, location and access:** The diversion pump consists of three pumps which feed into a main supply canal that runs parallel to and on the north side of Maze Road. This pumping station serves as source water for RD 2101 and other upslope water users. Access to the site is 250 north of Maze Road via levee road.

**Township/Range/Section:** SW 1/4, NW 1/4, SW 1/4, Section 29, T3S, R7E  
(DWR # 3S/7E-29M)

**Latitude/Longitude:** Lat. 37° 38' 32"/Long. 121° 13' 42"

**County:** Stanislaus

**USGS Quad Map:** Ripon, CA

**Type of diversion and use of the water:** Pumped diversion of San Joaquin River water for irrigation use within RD 2101 and upslope lands.

**Meter Number:** 2T4071 (PG&E)

San Joaquin River Section #18

Airport Way (Vernalis) to Upstream of Banta-Carbona Intake Canal

## SAN JOAQUIN RIVER

### Section 18: Airport Way (Vernalis) to Upstream of Banta-Carbona Intake Canal

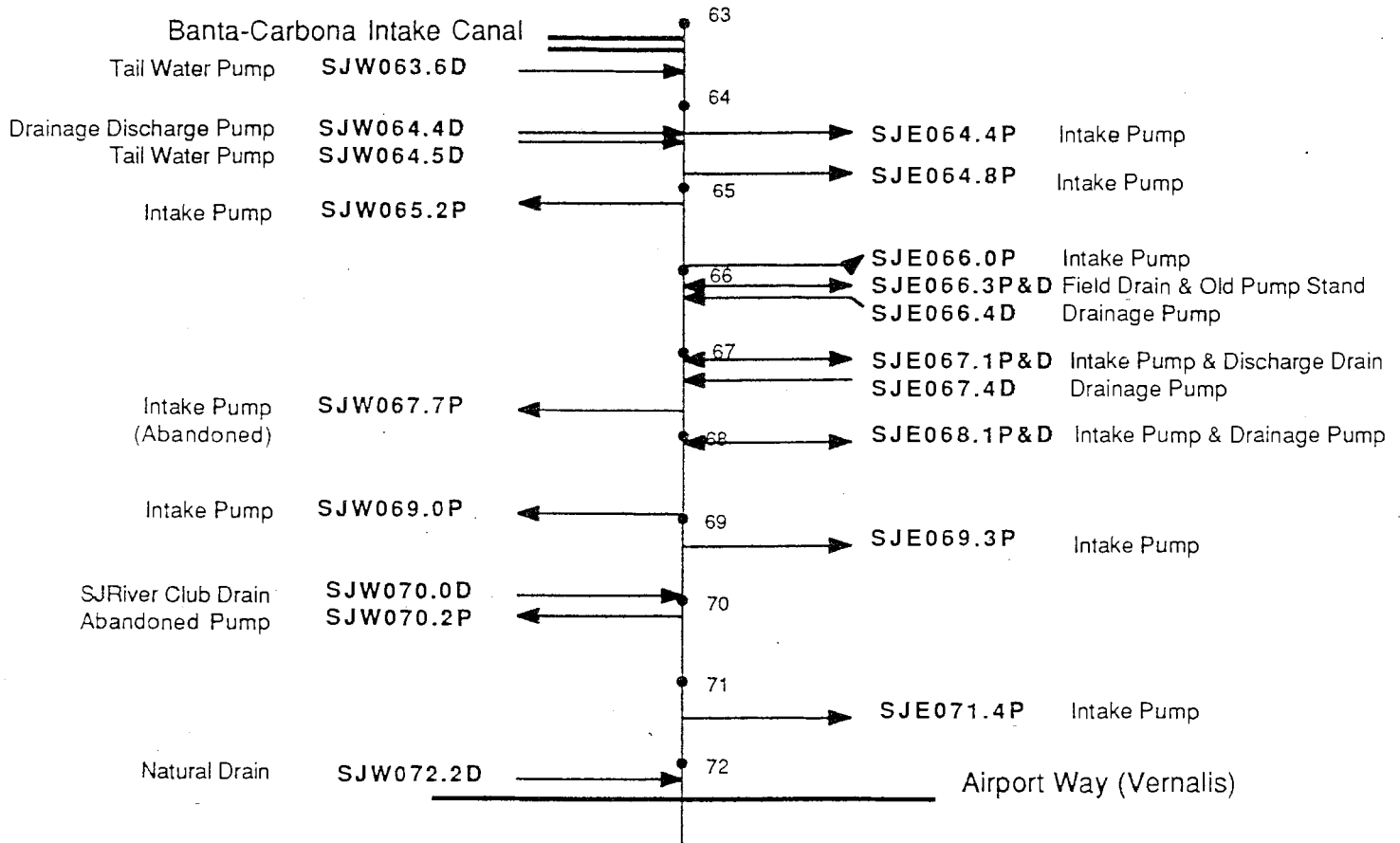

Figure A-18. Schematic Diagram for Water Diversions and Discharges on the San Joaquin River from Airport Way (Vernalis) to Upstream of Banta-Carbona Intake Canal (River Section 18).

San Joaquin River Section #19

Banta-Carbona Intake to Paradise Dam

SAN JOAQUIN RIVER

Section 19: Banta-Carbona Intake Canal to Paradise Dam

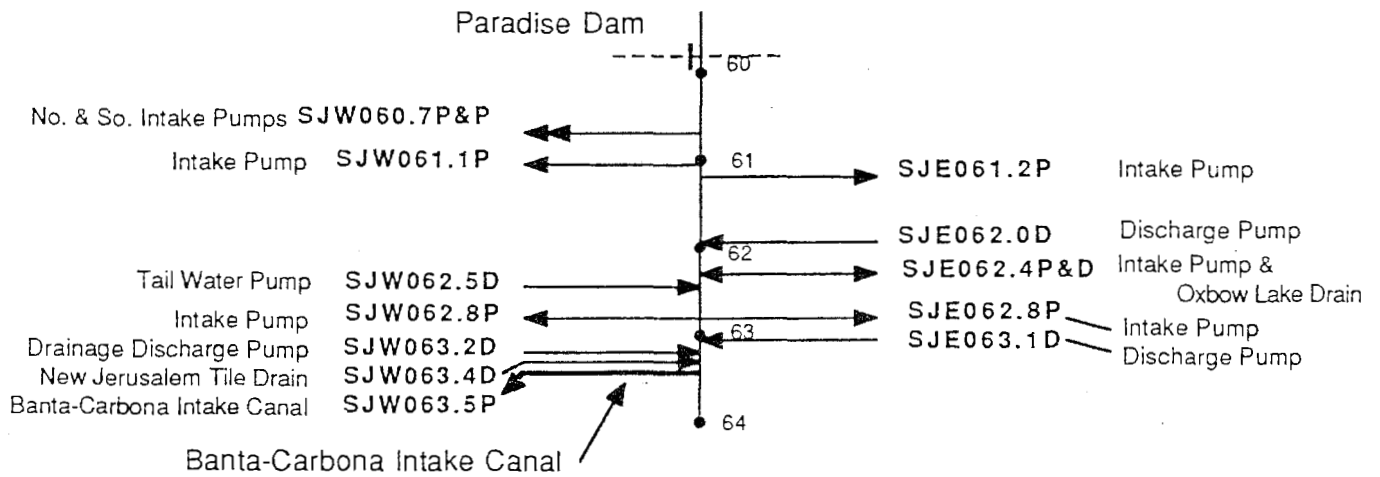

Figure A-19. Schematic Diagram for Water Diversions and Discharges on the San Joaquin River from Banta-Carbona Intake Canal to Paradise Dam (River Section 19).

San Joaquin River Section #20

Paradise Dam to Mossdale Bridge (Interstate 5)

SAN JOAQUIN RIVER

Section 20: Paradise Dam to Mossdale Bridge (Interstate 5)

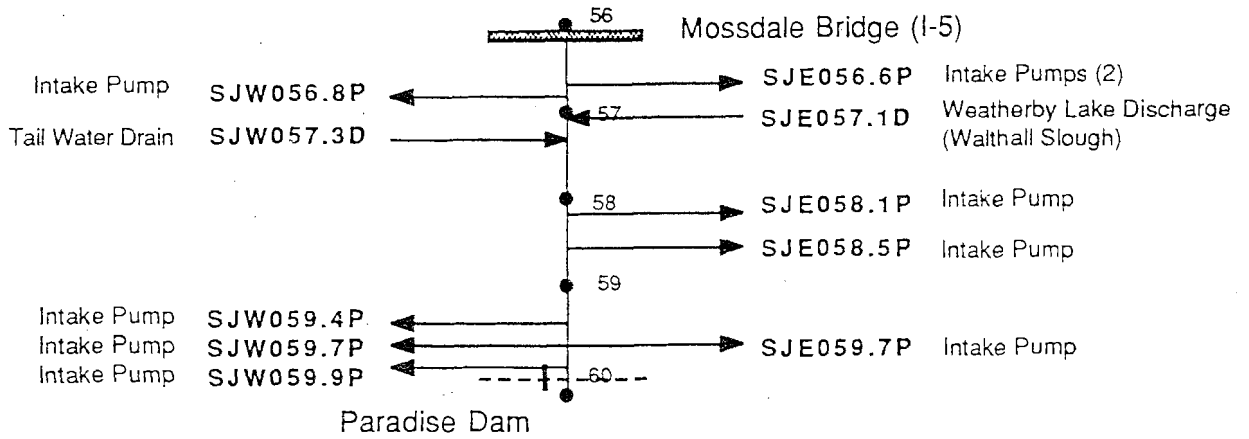

Figure A-20. Schematic Diagram for Water Diversions and Discharges on the San Joaquin River from Paradise Dam to Mossdale Bridge (Interstate 5) (River Section 20).

San Joaquin River Section A

Bear Creek-Eastside Bypass (Inflow) to San Joaquin River



Special Channel Survey A: Bear Creek from Eastside Bypass Inflow to San Joaquin River

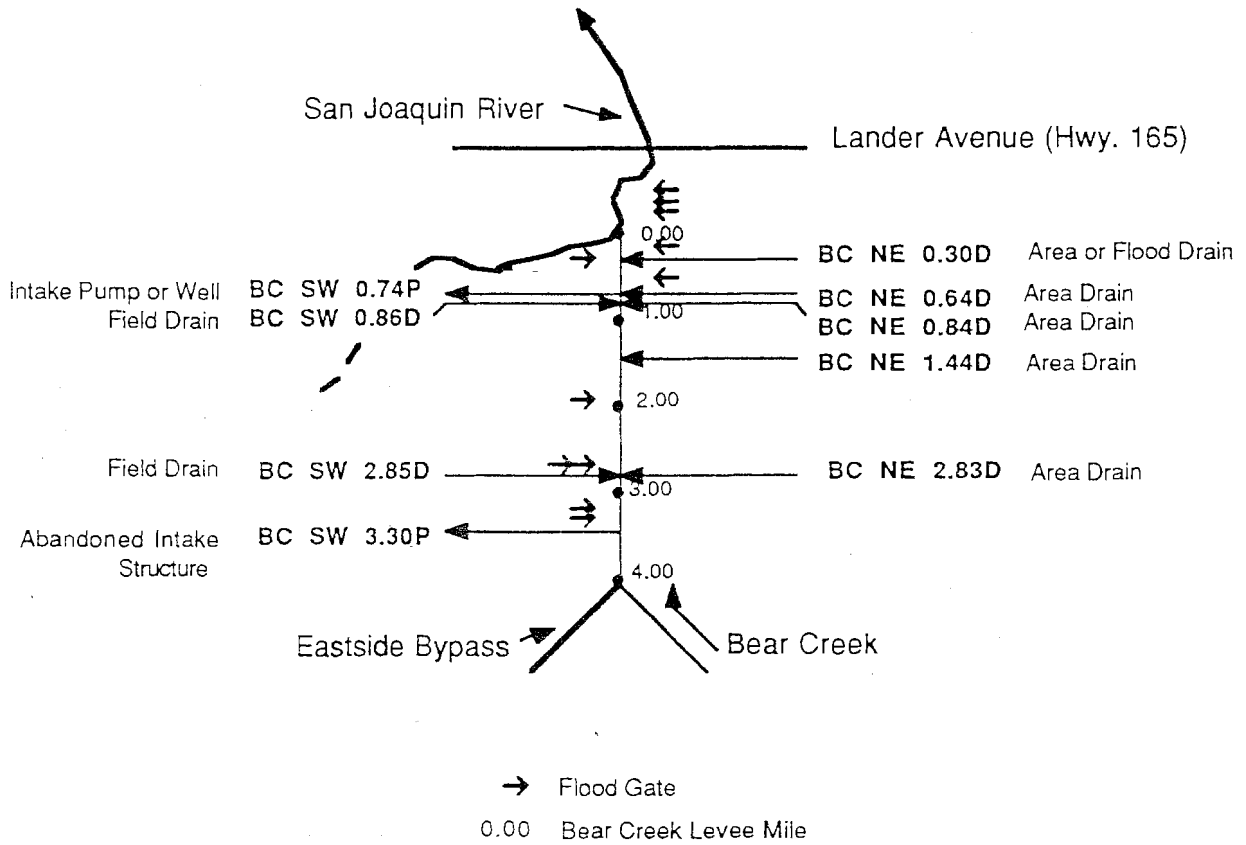

Figure A-21. Schematic Diagram for Special Channel Survey A: Bear Creek from Eastside Bypass Inflow to San Joaquin River.

San Joaquin River Section B

Old Grayson Channel-Origin to San Joaquin River

Special Channel Survey B: Old Grayson Channel from Origin to San Joaquin River

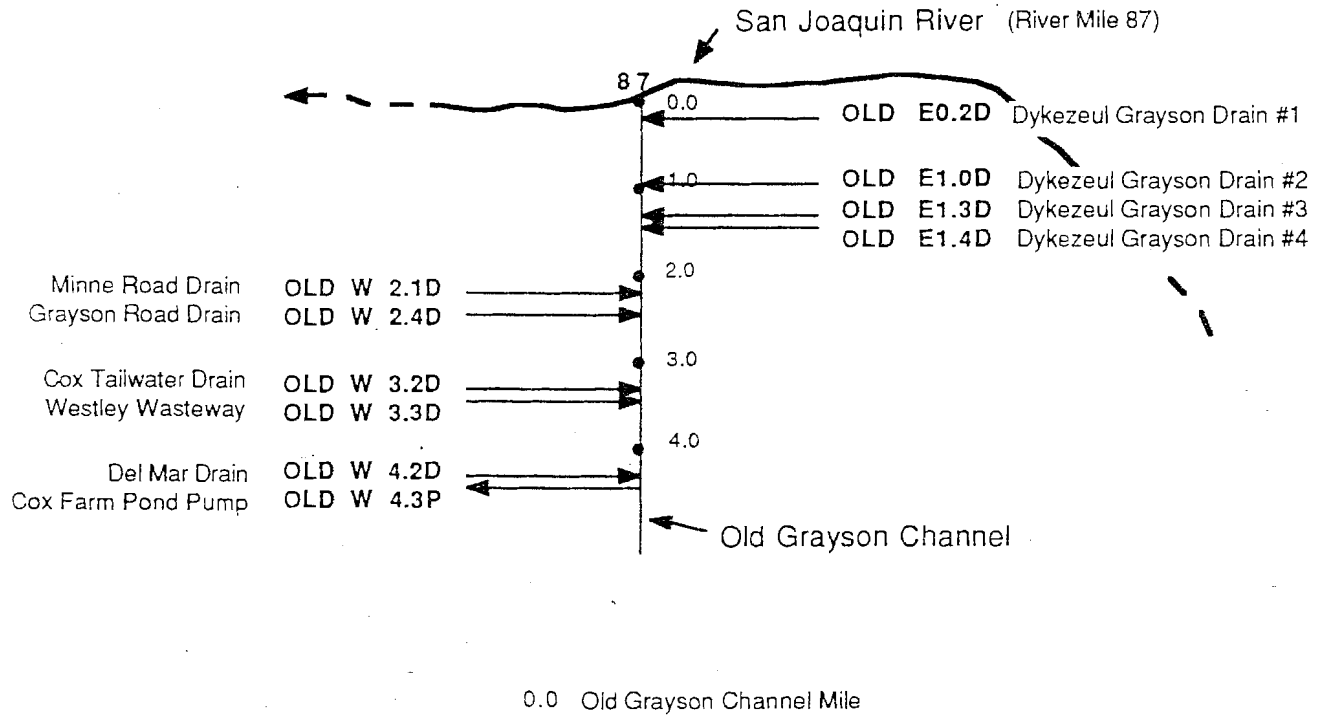

Figure A-22. Schematic Diagram for Special Channel Survey B: Old Grayson Channel from Origin to San Joaquin River.

## SAN JOAQUIN RIVER DIVERSION SITE

SITE ID# OLD W 4.3P

Site Name: Cox Farm Pond Pump

River Mileage: 4.3

**Site description, location and access:** The pump is located on a farm pond near the Old Grayson Channel. The site is accessed via Cox Road south from Grayson. Turn east off of Cox Road onto dirt farm road 0.3 miles south of Westley Wasteway. There is a Del Mar packaging facility on west side of road. Follow this dirt road. It turns south at the old dairy barn and the pump is located approximately 0.2 miles south of the barn.

**Township/Range/Section:** NE 1/4, SW 1/4, SW 1/4, Section 25, T4S, R7E  
(DWR# 4S/7E-25N)

**Latitude/Longitude:** Lat. 37° 33' 15"/Long. 121° 09' 18"

County: Stanislaus

USGS Quad Map: Westley

**Type of diversion and use of the water:** 30hp pump with 3000 gal/min capacity. The pump is located on a pond and this pond is replenished during the irrigation season by West Stanislaus Irrigation District drainage water and seepage from the San Joaquin River and the Old Grayson Channel.

**Meter Number:** not recorded

**Water Right Permit Number:** not listed

**SAN JOAQUIN RIVER DISCHARGE SITE**

SITE ID# OLD W 4.2D

Site Name: Del Mar Drain

Old Channel River Mileage: 4.2

**Site description, location and access:** The Del Mar Drain is so named as there are no other landmarks in the area. The drain is named after the food processing and packing/distribution facility that sits on Cox Road at the turn off to the site. The site is located 0.35 miles east of Cox Road. The turn off from Cox Road is 0.3 miles south of the Westley Wasteway. The access road is a private farm road and the discharge site is in a pasture area on the north side of a mobile home (approximately 1,000 feet north). Site is operated/maintained by West Stanislaus Irrigation District.

**Township/Range/Section:** NE 1/4, NE 1/4, SE 1/4, Section 26, T4S, R7E  
(DWR# 4S/7E-26J)

**Latitude/Longitude:** Lat. 37° 33' 23"/Long. 121° 09' 30"

County: Stanislaus

USGS Quad Map: Westley

WATER SOURCE

**Type and source of water being discharged (description):** For all practical purposes, the flow in this drain is all tail water from irrigated fields upslope in the West Stanislaus Irrigation District. This drainage area is approximately 1,050 acres in size. It is bounded on the north by the Westley Wasteway, and on the west by the West Stanislaus Irrigation District Lateral 3 Sough (see map 1a). This site is monitored as Site# STC028. The sources of irrigation water to this drainage area are the West Stanislaus Irrigation District Laterals 2 and 3 South, and on-farm irrigation wells (see map 1b).

**Comments on factors affecting water quality and quantity at the site:** Water quality at the site will be influenced by the quality of the tail water entering the drain. A small amount of seepage probably enters the system during certain high ground water periods but its influence on water quality is likely to be small.

MONITORING

Previous or on-going monitoring at the site:

<u>Agency</u>	<u>Site ID#</u>	<u>Constituents</u>	<u>Frequency</u>	<u>Period of Record</u>	<u>Data Storage</u>
CVRWQCB	STC 028	Cl, SO <sub>4</sub> , Total Alkalinity, EC, B, Cu, Cr, Pb, Hg, Mo, Ni, Zn, Se, and Suspended Sediments.	Monthly	4/86- Present	CVRWQCB Files
West Stanislaus Irrigation District	Del Mar Drain	EC, Suspended Sediments.	Monthly (May-Sept)	4/86- Present	WSID Files

**SAN JOAQUIN RIVER DISCHARGE SITE**

SITE ID# OLD W 3.3D

Site Name: Westley Wasteway

Old Channel River Mileage: 3.3

**Site description, location and access:** The wastewater discharges into the Old Grayson Channel from the west bank. The discharge point at the Old Grayson Channel is not accessible by road. The Westley Wasteway is located south of and runs parallel to Grayson Road. Cox Road, south out of Grayson, crosses the Wasteway 0.6 miles south of Grayson. This is probably the best access.

**Township/Range/Section:** SE 1/4, SW 1/4, NE 1/4, Section 26, T4S, R7E  
(DWR# 4S/7E-26G)

**Latitude/Longitude:** Lat. 37° 33' 37"/Long. 121° 09' 51"

County: Stanislaus

USGS Quad Map: Westley

WATER SOURCE

**Type and source of water being discharged (description):** The water source is operational spill water from the Delta Mendota Canal and tail water from the West Stanislaus Irrigation District. No known tile drainage enters this drain. The area of drainage to the wasteway is approximately 3,280 acres (see map 1a). This site is monitored as Site# STC029. The sources of irrigation water to this drainage area are the Delta Mendota Canal, the West Stanislaus Irrigation District Laterals 2, 3, 4, 5, and 6 South, and on-farm irrigation wells (see map 1b).

**Comments on factors affecting water quality and quantity at the site:** The water quality will depend on the amount of tail water being discharged. The operational spill water should not affect water quality.

MONITORING

Previous or on-going monitoring at the site:

<u>Agency</u>	<u>Site ID#</u>	<u>Constituents</u>	<u>Frequency</u>	<u>Period of Record</u>	<u>Data Storage</u>
CVRWQCB	STC 029	Cl, SO <sub>4</sub> , Total Alkalinity, EC, B, Cu, Cr, Pb, Hg, Mo, Ni, Zn, Se, & Suspended Sediments.	Monthly	6/86-Present	CVRWQCB Files
West Stanislaus RCD	#42	EC, temperature	Monthly (May-Sept)	6/79-Present	WSRCD Files
West Stanislaus Irrigation District	Westley Wasteway	EC, Suspended Sediment and Flow.	Monthly	4/86-Present	WSID Files

## SAN JOAQUIN RIVER DISCHARGE SITE

SITE ID# OLD W 3.2D

Site Name: Cox Tail Water Drain

Old Channel River Mileage: 3.2

**Site description, location and access:** This drain is an irrigation tail water drain. The discharge site is located approximately 50 yards north of the Westley Wasteway. Access is via dirt road along north bank of the Westley Wasteway east of Cox Road. The drain is at the end of the irrigated field on north side of the Wasteway.

**Township/Range/Section:** SW 1/4, SW 1/4, NE 1/4, Sec. 26, T4S, R7E  
(DWR# 4X/7E-26G)

**Latitude/Longitude:** Lat. 37° 33' 33"/Long. 121° 09' 57"

**County:** Stanislaus

**USGS Quad Map:** Westley, CA

### WATER SOURCE

**Type and source of water being discharged (description):** Irrigation tail water from approximately 160 acres. The water source is from West Stanislaus Irrigation District Lateral 2 south.

**Comments on factors affecting water quality and quantity at the site:** The drainage water is expected to have a high sediment load.

SAN JOAQUIN RIVER DISCHARGE SITE

SITE ID# OLD W 2.4D

Site Name: Grayson Road Drain

Old Channel River Mileage: 2.4

**Site description, location and access:** Sampling point is at the Grayson Road Bridge as it crosses the old river channel (0.15 miles west of the intersection of Grayson Road and Cox Road). Discharge is from a pipe in the west bank of the old channel approximately 20 feet south of the bridge. This closed pipeline collection system is owned and operated by the West Stanislaus Irrigation District.

**Township/Range/Section:** NW 1/4, SW 1/4, NW 1/4, Section 26, T4S, R7E  
(DWR# 4S/7E-26E)

**Latitude/Longitude:** Lat. 37° 33' 43"/Long. 121° 10' 27"

**County:** Stanislaus

**USGS Quad Map:** Westley

WATER SOURCE

**Type and source of water being discharged (description):** All the water entering this closed pipeline is tail water from the West Stanislaus Irrigation District. During periods of no flow, some seepage does enter the pipeline due to high ground water in the area, but the flow is small compared to the total discharge volume. This drain receives drainage water from approximately 2590 acres (see map 1a). This site is monitored as Site# STC030. The sources of irrigation water are the West Stanislaus Irrigation District laterals 2, 3, 4, 5, and 6 Sough and on-farm irrigation wells (see map 1b).

**Comments on factors affecting water quality and quantity at the site:** Water quality will be heavily influenced by the amount of tail water entering the system.

MONITORING

Previous or on-going monitoring at the site:

<u>Agency</u>	<u>Site ID#</u>	<u>Constituents</u>	<u>Frequency</u>	<u>Period of Record</u>	<u>Data Storage</u>
CVRWQCB	STC 030	Cl, SO <sub>4</sub> , Total Alkalinity, EC, B, Cu, Cr, Pb, Hg, Mo, Ni, Zn, Se, & Suspended Sediments.	Monthly	10/85-Present	CVRWQCB Files
West Stanislaus RCD	#43	EC, temperature	Monthly (May-Sept)	7/78-Present	WSRCD Files
West Stanislaus Irrigation District	STC 030	EC, Suspended Sediment and Flow.	Monthly (May-Sept)	4/86-Present	WSID Files



**SAN JOAQUIN RIVER DISCHARGE SITE**

SITE ID# OLD W 2.1D

Site Name: Minnie Road Drain

Old Channel River Mileage: 2.1

**Site description, location and access:** Tail water drain that discharges at the eastern end of Minnie Road just north of the town of Grayson. Minnie Road is located 0.45 miles north of Grayson Road. The discharge site is on the right side of Minnie Road approximately 100 feet beyond the last mobile home. Access to the site is through a locked gate at the end of Minnie Road (approximately 0.3 miles east of River Road).

**Township/Range/Section:** SE 1/4, SE 1/4, SE 1/4, Section 22, T4S, R7E  
(DWR# 4S/7E-22R)

**Latitude/Longitude:** Lat. 37° 33' 59"/Long. 121° 10' 35"

County: Stanislaus

USGS Quad Map: Westley

WATER SOURCE

**Type and source of water being discharged (description):** All the water entering this drain is from the West Stanislaus Irrigation District and consists of only tail water from approximately 1250 acres of irrigated fields (see map 1a). No tile drainage systems are known to exist in this drainage area. During periods of no flow, there does not appear to be high ground water seepage into this system. This site is monitored as Site# STC031. The sources of irrigation water to this drainage area are the West Stanislaus Irrigation District Laterals 2, 3, and 4 Sough and on-farm irrigation wells (see map 1b).

**Comments on factors affecting water quality and quantity at the site:** Water quality will be influenced by the quality of the tail water.

MONITORING

Previous or on-going monitoring at the site:

<u>Agency</u>	<u>Site ID#</u>	<u>Constituents</u>	<u>Frequency</u>	<u>Period of Record</u>	<u>Data Storage</u>
CVRWQCB	STC 031	Cl, SO <sub>4</sub> , Total Alkalinity, EC, B, Cu, Cr, Pb, Hg, Mo, Ni, Zn, Se, and Suspended Sediments.	Monthly	10/85- Present	CVRWQCB Files
West Stanislaus Irrigation District	STC 031	EC, Suspended Sediment and Flow.	Monthly (May-Sept)	4/86- Present	WSID Files

## SAN JOAQUIN RIVER DISCHARGE SITE

SITE ID# OLD E 1.4D

Site Name: Dykezeul Grayson Channel  
Drain No. 4

River Mileage: 1.4

**Site description, location and access:** The field drain is located on the east bank of the Old Grayson Channel approximately 1.4 miles upstream from its confluence with the present river channel through Laird Slough. The drain has a concrete lining where the corrugated pipe emerges from under the levee road. The site is accessed via the levee road on the east side of the old Grayson channel. The levee road is located on the north side of Grayson Road approximately 0.4 miles east of the Grayson Road Bridge over the former San Joaquin River channel near Grayson. The site is located approximately 0.7 miles north on the levee road.

**Township/Range/Section:** SE 1/4, NE 1/4, SW 1/4, Section 23, T4S, R7E  
(DWR# 4S/7E-23L)

**Latitude/Longitude:** Lat. 37° 34' 13"/Long. 121° 10' 06"

**County:** Stanislaus

**USGS QUAD MAP:** Westley

### WATER SOURCE

**Type and source of water being discharged (description):** Tail water drainage from the irrigation of silage corn and winter barley. Drains approximately 50 acres. The water source is from river pump (SJW 088.9P) or farm well. The drain is gravity.

**Comments on factors affecting water quality and quantity at the site:** Water quality will reflect supply water quality plus increased sediment content.

## SAN JOAQUIN RIVER DISCHARGE SITE

SITE ID# OLD E 1.3D

Site Name: Dykezeul Grayson Channel  
Drain No. 3

Old Channel River Mileage: 1.3

**Site description, location and access:** The field drain is located on the east bank of the Old Grayson channel approximately 1.3 miles upstream from its confluence with the present day San Joaquin River channel through Laird Slough. The field drain has a lift gate on the field side of the levee road and water is transported to the old channel through a corrugated pipe under the road. The site is accessed via the levee road on the east bank of the Old Grayson Channel. The levee road is located on the north side of Grayson Road 0.4 miles east of the Grayson Road Bridge over the old channel near Grayson. The site is located approximately 0.8 miles north on the levee road. Levee road is located 0.4 miles east of the Grayson Road Bridge over the old channel near Grayson.

**Township/Range/Section:** NE 1/4, SE 1/4, SW 1/4, Section 23, T4S, R7E  
(DWR# 4S/7E-23P)

**Latitude/Longitude:** Lat. 37° 37' 30"  
Long. 121° 10' 01"

**County:** Stanislaus

**USGS Quad Map:** Westley

### WATER SOURCE

**Type and source of water being discharged (description):** Tail water drainage from irrigation of corn (silage) corn and winter barley. Drains approximately 35 acres. The water source is from river pump (SJW 088.9P) or farm well. The drain is gravity.

**Comments on factors affecting water quality and quantity at the site:** Water quality will reflect the supply water quality plus increased sediment content.

## SAN JOAQUIN RIVER DISCHARGE SITE

SITE ID# OLD E 1.0D

Site Name: Dykezeul Grayson Channel  
Drain No. 2

Old Channel River Mileage: 1.0

**Site description, location and access:** The field drain is on the east side of the old Grayson channel approximately 1 mile upstream of the confluence with the present day San Joaquin River Channel north of Laird Slough. Access to the channel is along the levee road of the old river channel. The levee road is located 0.4 miles east of the Grayson Road Bridge over the old channel near Grayson.

**Township/Range/Section:** NE 1/4, NW 1/4, SE 1/4, Section 23, T4S, R7E  
(DWR# 4S/7E-23K)

**Latitude/Longitude:** Lat. 37° 34' 22"/Long. 121° 09' 52"

**County:** Stanislaus

**USGS Quad Map:** Westley

### WATER SOURCE

**Type and source of water being discharged (description):** Tail water drainage from irrigation of corn (silage) and winter barley. Drains approximately 9 acres. The water source is from a river pump (SJW 088.9P) or farm well. Drain is gravity.

**Comments on factors affecting water quality and quantity at the site:** Water quality will reflect the supply water quality plus increased sediment.

## SAN JOAQUIN RIVER DISCHARGE SITE

SITE ID# OLD E 0.2D

Site Name: Dykezeul Grayson Channel  
Drain No. 1

Old Channel River Mileage: 0.2

**Site description, location and access:** The field drain is on the east side of the old Grayson channel approximately 0.2 miles upstream of the confluence with the present day San Joaquin River Channel. The drain is a corrugated pipe with a flap gate. Access to the site is along the levee road of the Old Grayson Channel. The levee road is located 0.4 miles east of the Grayson Road Bridge over the old channel. Follow the levee road north as it follows then meanders of the old stream channel.

**Township/Range/Section:** SW 1/4, NW 1/4, NE 1/4, Section 23, T4S, R7E  
(DWR# 4S/7E-23B)

**Latitude/Longitude:** Lat. 37° 34' 41"/Long. 121° 09' 54"

**County:** Stanislaus

**USGS Quad Map:** Westley

### WATER SOURCE

**Type and source of water being discharged (description):** Tail water drainage from irrigation of corn (silage) and winter barley. The area drained is approximately 100 acres. The water source is from a river pump (SJW 088.9P) or farm well. Drain is gravity.

**Comments on factors affecting water quality and quantity at the site:** Water quality will be affected by supply water quality but with increased sediment.

San Joaquin River Section C

West Stanislaus Irrigation District Pumps to San Joaquin River

Special Channel Survey C: West Stanislaus Irrigation District  
Pumps to San Joaquin River

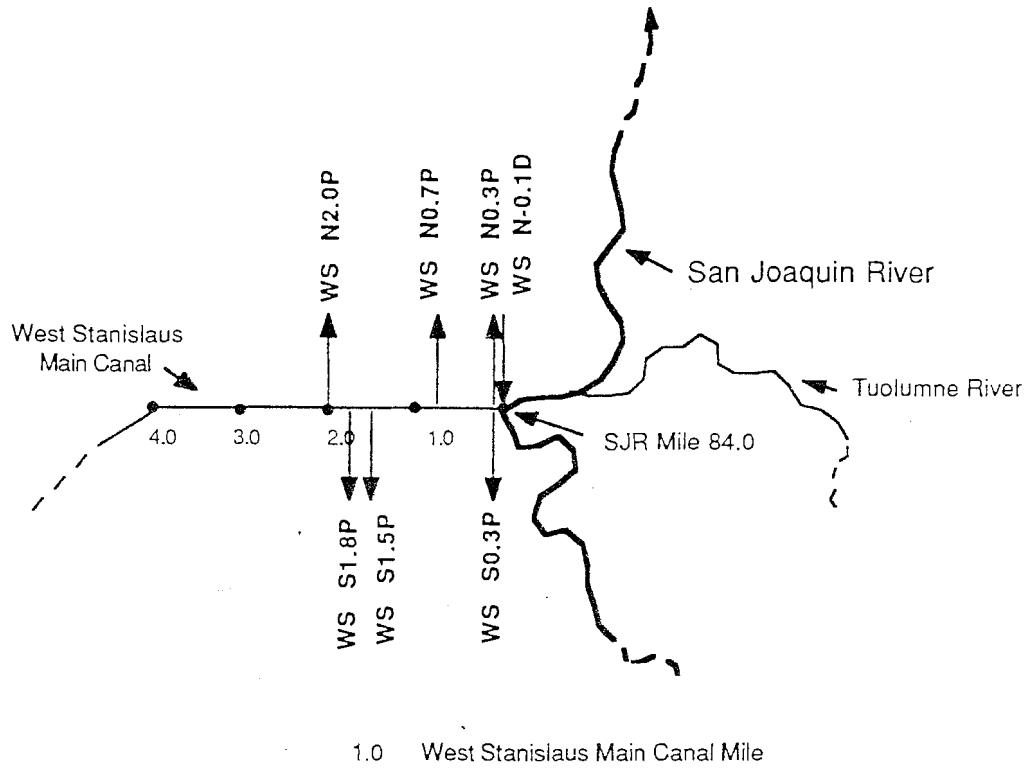

- |           |                           |           |                |
|-----------|---------------------------|-----------|----------------|
| WS N-0.1D | Tail Water Discharge Pump | WS S-0.3P | Diversion Pump |
| WS N-0.3P | Diversion Pump            | WS S-1.5P | Diversion Pump |
| WS N-0.7P | Diversion Pump            | WS S-1.8P | Diversion Pump |
| WS N-2.0P | Diversion Pump            |           |                |

Figure A-23. Schematic Diagram for Special Channel Survey C: West Stanislaus Irrigation District from Pumps to San Joaquin River.

Water Quality

1056

Duplicate

WATER DIVERSION AND DISCHARGE POINTS  
ALONG THE SAN JOAQUIN RIVER:  
MENDOTA POOL DAM TO MOSSDALE BRIDGE.

Volume 2-B: Appendix B

San Joaquin River Water Diversions Beneficial Use Survey  
(Lander Avenue Bridge to Airport Way)

California Regional Water Quality Control Board  
Central Valley Region  
3443 Routier Road  
Sacramento, CA 95827-3098

April 1989



APPENDIX B

TABLE OF CONTENTS

	<u>Page</u>
Introduction . . . . .	B-1
River Sections . . . . .	B-1
Section 9 - Lander Avenue Bridge to Salt Slough . . . . .	B-1
Section 10 - Salt Slough to Fremont Ford Bridge (Highway 140) . . . . .	B-1
Section 11 - Fremont Ford Bridge (Highway 140) to Mud Slough (north) . . . . .	B-1
Section 12 - Mud Slough (north) to Hills Ferry Road Bridge . . . . .	B-1
Section 13 - Hills Ferry Road Bridge to Crows Landing Road Bridge . . . . .	B-6
Section 14 - Crows Landing Road Bridge to Patterson Bridge . . . . .	B-6
Section 15 - Patterson Bridge to Grayson Road Bridge . . . . .	B-6
Section 16 - Grayson Road Bridge to Maze Road Bridge (Highway 132) . . . . .	B-6
Section 17 - Maze Road Bridge (Highway 132) to Airport Way (Vernalis) . . . . .	B-6

LIST OF TABLES

Table B-1 Irrigation Use of Diversion Water From the San Joaquin River from Lander Avenue Bridge to Airport Way (Vernalis) . . . . .	B-2
--	-----

LIST OF FIGURES

Figure B-1 Water Diversion Points Within River Section 9 . . . . .	B-4
Figure B-2 Water Diversion Points Within River Section 11 . . . . .	B-5
Figure B-3 Water Diversion Points Within River Section 13 . . . . .	B-7
Figure B-4 Water Diversion Points Within River Section 14 . . . . .	B-8
Figure B-5 Water Diversion Points Within River Section 15 . . . . .	B-9
Figure B-6 Water Diversion Points Within River Section 16 . . . . .	B-10
Figure B-7 Water Diversion Points Within River Section 17 . . . . .	B-11

## Introduction

The discharge of agricultural drainage water is having potential impacts on users of San Joaquin River water. One of the prime beneficial uses of the San Joaquin River is agriculture, especially in the river section from the Lander Avenue Bridge (River Mile 132.8) to Airport Way Bridge (Vernalis) (River Mile 72.3). Regulation of the discharge of agricultural drainage requires the review and updating of the basin plan including a review of beneficial uses and the water quality objectives needed to protect those uses. In order to review water quality needs for San Joaquin River users, a survey was conducted in the spring and summer of 1985-86 to identify all water diversion points on the San Joaquin River. At each site, the type of use was recorded along with the number of acres irrigated. Often the river water only supplies a portion of the water supply used on the irrigated land; however, during short periods (weeks) it may be the only supply.

There are 48 points of diversion within the river reach studied. These diversion points are used to supply all or a portion of the irrigation supply to over 60,000 acres of land. The greatest portion of this irrigated land (53,900 acres) lies to the west of the San Joaquin River. The diversion sites are listed in Table B-1 along with the approximate acreage served and the crops most frequently grown. The discussion that follows summarizes the diversion activity within each river section.

## River Sections

### River Section 9 - Lander Avenue Bridge to Upstream of Salt Slough

*No record*  
There is one diversion point on this section of the river (see Figure B-1): the Stevinson Water District Pike Pump (SJE130.5P). It is located on the east bank and supplies water to approximately 500 acres. Use of this land alternates between pasture, alfalfa, and field corn.

### River Section 10 - Salt Slough to Fremont Ford Bridge (Highway 140)

There are no diversions on this reach of the river.

### River Section 11 - Fremont Ford Bridge (Highway 140) to Upstream of Mud Slough (north)

*No record*  
There is one diversion point on this reach of the river (see Figure B-2): Stevinson Water District Fremont Pump (SJE125.OP). It is located on the east bank and it supplies water to 300 acres for irrigation of pasture, field corn, and oats.

### River Section 12 - Mud Slough to Hills Ferry Road Bridge

There are no diversion points on this reach of the river.

Table B-1 Irrigation Use of Diversion Water from the San Joaquin River from Lander Avenue Bridge to Airport Way (VernaTis)

<u>River Mileage<sup>v</sup></u>	<u>Acres Irrigated</u>	<u>Crops</u>
SJE130.5P	500	pasture, alfalfa, field corn
SJE125.0P	300	pasture, field corn, oats
SJW117.0P	180	field corn, alfalfa
SJE115.6P	450	alfalfa, field corn, oats
SJE110.5P	159	pasture
SJE110.1P	95	field corn, oats
SJW110.0P	200 (discontinued 1981)	alfalfa, pasture
SJW109.7P	210	bean, spinach, field crops
SJE109.2P	90	alfalfa, field beans
SJE108.5P	350	field corn, oats
SJE108.4P	80	field corn, oats
SJE108.1P	22	field corn, oats
SJE108.0P	8	pasture, field corn
SJE107.2P	210	field corn, oats
SJE106.2P	430	field corn, alfalfa, pasture
SJE105.2P	250	field corn, alfalfa
SJW104.8p	180	field beans, tomatoes, cantaloupe, alfalfa
SJW104.0P	6,200	field corn, field beans, sugar beets, alfalfa, and others
SJE103.4P	75 (pump removed 7/85)	field corn, alfalfa
SJE100.8P	520	field corn, oats, barley, pasture
SJW098.9P	7	pasture
SJW098.70	5	pasture
SJW098.5P	180	pasture
SJW098.5P	14,000	field beans, sugar beets, field corn, tomatoes, wheat, barley, oats, alfalfa, walnuts, almonds, apricots, spinach, peas, bell peppers, cherries, plums, apples, pistachios, pasture, vegetables
SJW095.5P	80	field crops
SJW092.3P	400	field beans, field corn
SJE091.5P	200	field crops, pasture
SJE090.5P	10	pasture, vegetables
SJW089.6P	300	sugar beets, tomatoes, field corn, field beans, wheat, barley, alfalfa
SJW088.9P	275	field corn, barley
SJE088.7P	200	field crops, pasture, alfalfa
SJE088.4P	120	field corn, pasture, alfalfa
SJE087.5P	460	field corn, field beans, barley, pasture
SJE086.2P	1,100	wheat, tomatoes, alfalfa, sugar beets, pasture, field corn
SJE085.1P	200	field crops, pasture, alfalfa, melons, onions, cauliflower, lima beans

Table B-1 (continued)

<u>River Mileage</u> <sup>1/</sup>	<u>Acres Irrigated</u>	<u>Crops</u>
SJW084.0P	24,800	field beans, sugar beets, field corn, tomatoes, wheat, barley, oats, alfalfa, walnuts, almonds, apricots, spinach, peas, bell peppers, cherries, plums, apples, pistachios, pasture, vegetables
SJE080.1P	600	pasture
SJW079.2P	185	field corn
SJW079.2P	134	field corn
SJW078.3P	179	field corn
SJW077.5P	3,700	wheat, tomatoes, alfalfa, sugar beets, field and lima beans, vegetables
SJW077.3P	1,100	wheat, tomatoes, alfalfa, sugar beets, field and lima beans, vegetables
SJW077.2P	450	field corn, sugar beets, grain
SJW075.9P	900	field corn, sugar beets, grain
SJE075.1P	70	pasture
SJE074.3P	165	pears, corn, beans, oats
SJE074.1P	205	grapes
SJW073.0P	<u>220</u>	alfalfa, sugar beets, barley, field beans, tomatoes
	60,750	

<sup>1/</sup> Estimated from Corps of Engineers' Records (1984)

SAN JOAQUIN RIVER

Section 9: Lander Avenue Bridge (Hwy. 165) to Upstream of Salt Slough

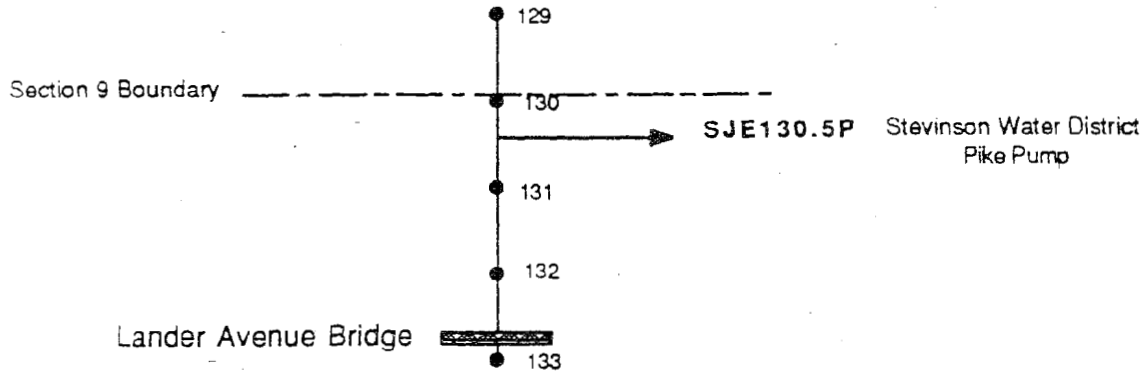

Figure B-1. Water Diversion Points Within River Section 9: Lander Avenue Bridge (Hwy.165) to Upstream of Salt Slough.

SAN JOAQUIN RIVER

Section 11: Fremont Ford Bridge (Hwy. 140) to Upstream of Mud Slough (North)

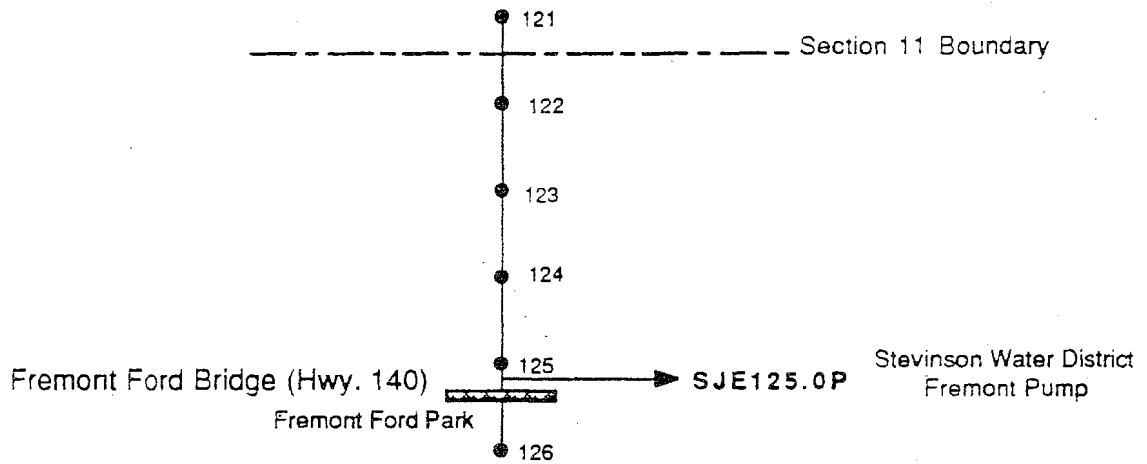

Figure B-2. Water Diversion Points Within River Section 11: Fremont Ford Bridge (Hwy.140) to Upstream of Mud Slough (North)

SAN JOAQUIN RIVER

Section 13: Hills Ferry Road Bridge to Crows Landing Road Bridge

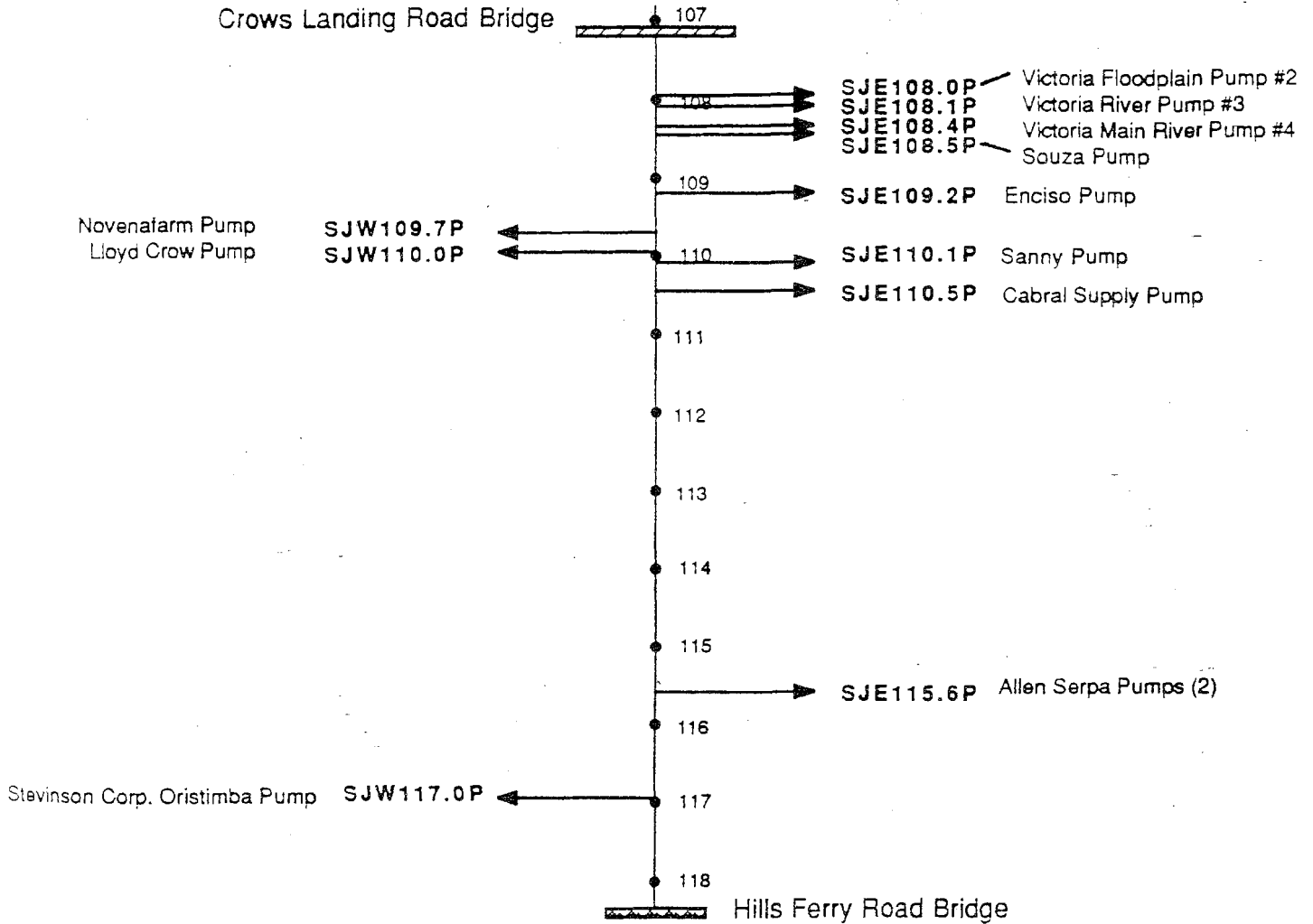

Figure B-3. Water Diversion Points Within River Section 13: Hills Ferry Road Bridge to Crows Landing Road Bridge.

River Section 13 - Hills Ferry Road Bridge to Crows Landing Road Bridge

There are eleven (11) diversion points on this reach of the river (see Figure B-3). Eight (8) are on the east bank and three (3) on the west bank. The eight east bank pumps supply irrigation water to approximately 1,250 acres used for pasture, alfalfa, and field crops (corn, oats, and beans). The three west bank pumps supply irrigation water to approximately 590 acres used for pasture, alfalfa, field corn, spinach, beans, and other field crops. One of the west side pumps has recently been discontinued (1981) due to poor river water quality.

River Section 14 - Crows Landing Road Bridge to Patterson Bridge

There are eight (8) diversion points on this reach of the river (see Figure B-4): five (5) on the east bank and three (3) on the west bank. The five east bank diversion points supply water for the irrigation of approximately 1,500 acres used for pasture, alfalfa, field corn, oats, and barley. The three west bank diversion points supply irrigation water to approximately 6,400 acres which are used for pasture, alfalfa, field corn, beans, sugar beets, tomatoes, cantaloupe, and other crops.

River Section 15 - Patterson Bridge to Grayson Road Bridge

There are eight (8) diversion points on this reach of the river (see Figure B-5): three (3) on the east bank and five (5) on the west bank. The three east bank diversion points supply irrigation water to approximately 400 acres, most of which is used as pasture. The five diversions points on the west bank supply all or a portion of the irrigation water to approximately 14,700 acres with the Patterson Water District making up 14,000 of these acres. This water is used for the irrigation of beans, sugar beets, tomatoes, field corn, wheat, barley, oats, alfalfa, walnuts, almonds, apricots, spinach, peas, sudan grass, bell peppers, cherries, plums, apples, pistachios, and pasture.

River Section 16 - Grayson Road Bridge to Maze Road Bridge (Highway 132)

There are thirteen (13) diversion points on this reach of the river (see Figure B-6): six (6) on the east bank and seven (7) on the west bank. The six east bank diversion points supply irrigation water to 2,000 to 4,000 acres depending upon the economy. Water is used to irrigate pasture, field corn, beans, barley, and other field crops. On the west bank the seven diversion points supply all or a portion of the irrigation water to over 30,000 acres; 24,800 acres within the West Stanislaus Irrigation District. Crops grown on the west bank include beans, field corn, apricots, walnuts, tomatoes, melons, almonds, onions, cauliflower, peppers, alfalfa, wheat, barley, cherries, sugar beets, and lima beans.

River Section 17 - Maze Road (Highway 132) to Airport Way (Vernalis)

There are six (6) diversion points on this reach of the river (see Figure B-7); three (3) on the east bank and three (3) on the west bank. The three east bank diversion points supply irrigation water to approximately 440 acres to be used for pasture, pears, field corn, beans, oats, and grapes. On the west bank three diversion points supply water to approximately 1,600 acres used for alfalfa, sugar beets, barley, field corn, beans, and tomatoes.



# SAN JOAQUIN RIVER

## Section 14: Crows Landing Road Bridge to Patterson Bridge

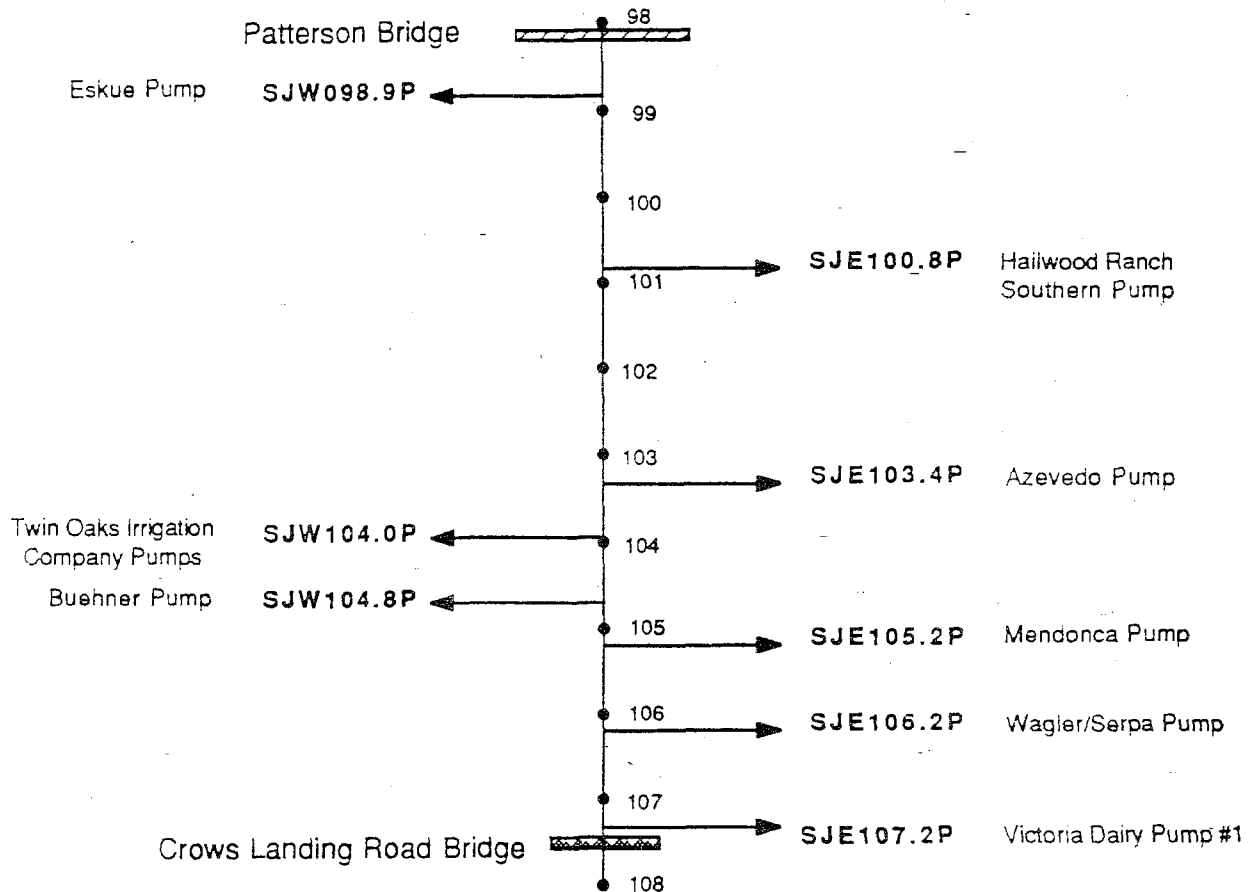

Figure B-4. Water Diversion Points Within River Section 14: Crows Landing Road Bridge to Patterson Bridge.

SAN JOAQUIN RIVER

Section 15: Patterson Bridge to Grayson Road Bridge

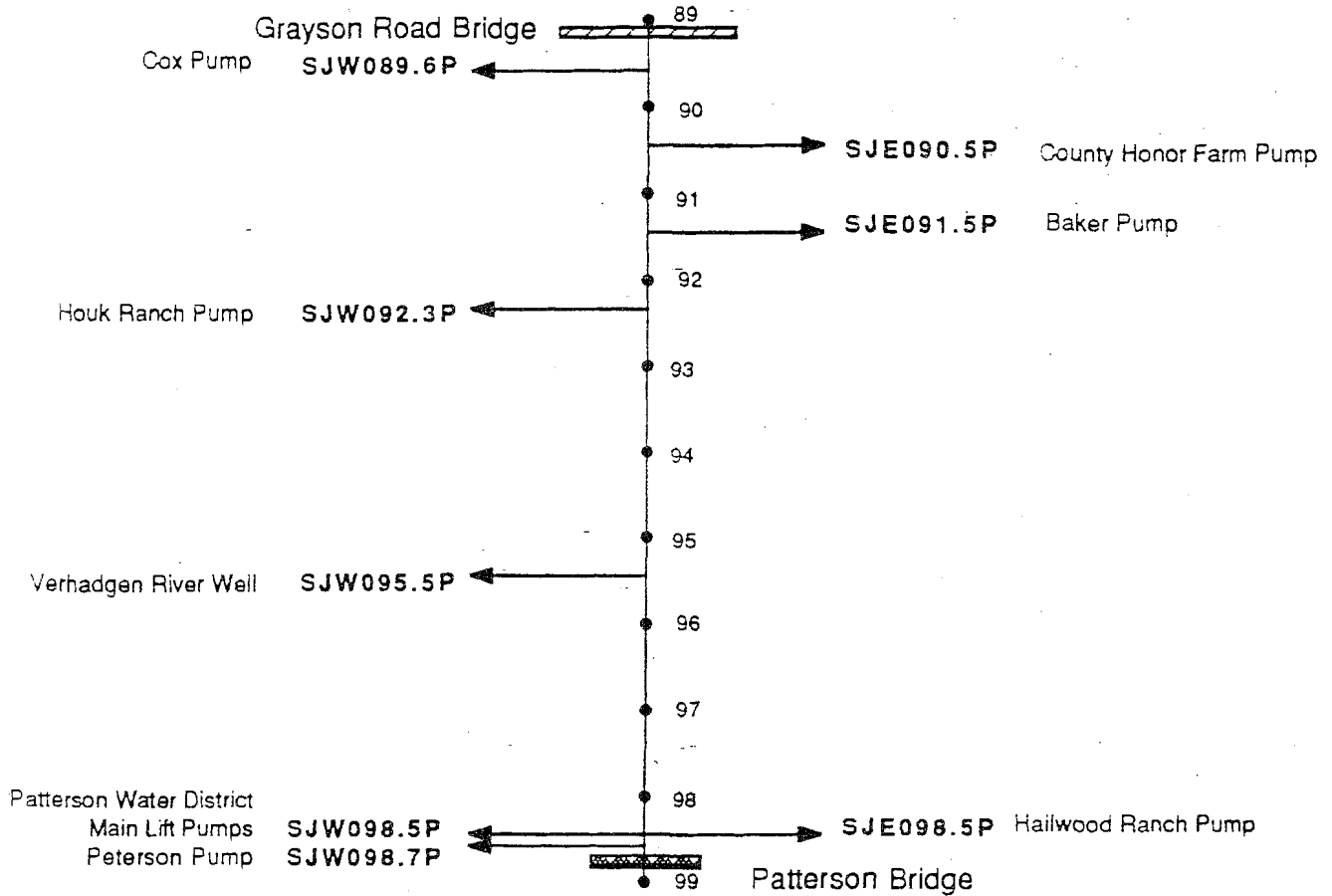

Figure B-5. Water Diversion Points Within River Section 15: Patterson Bridge to Grayson Road Bridge.

# SAN JOAQUIN RIVER

## Section 16: Grayson Road Bridge to Maze Road Bridge (Hwy.132)

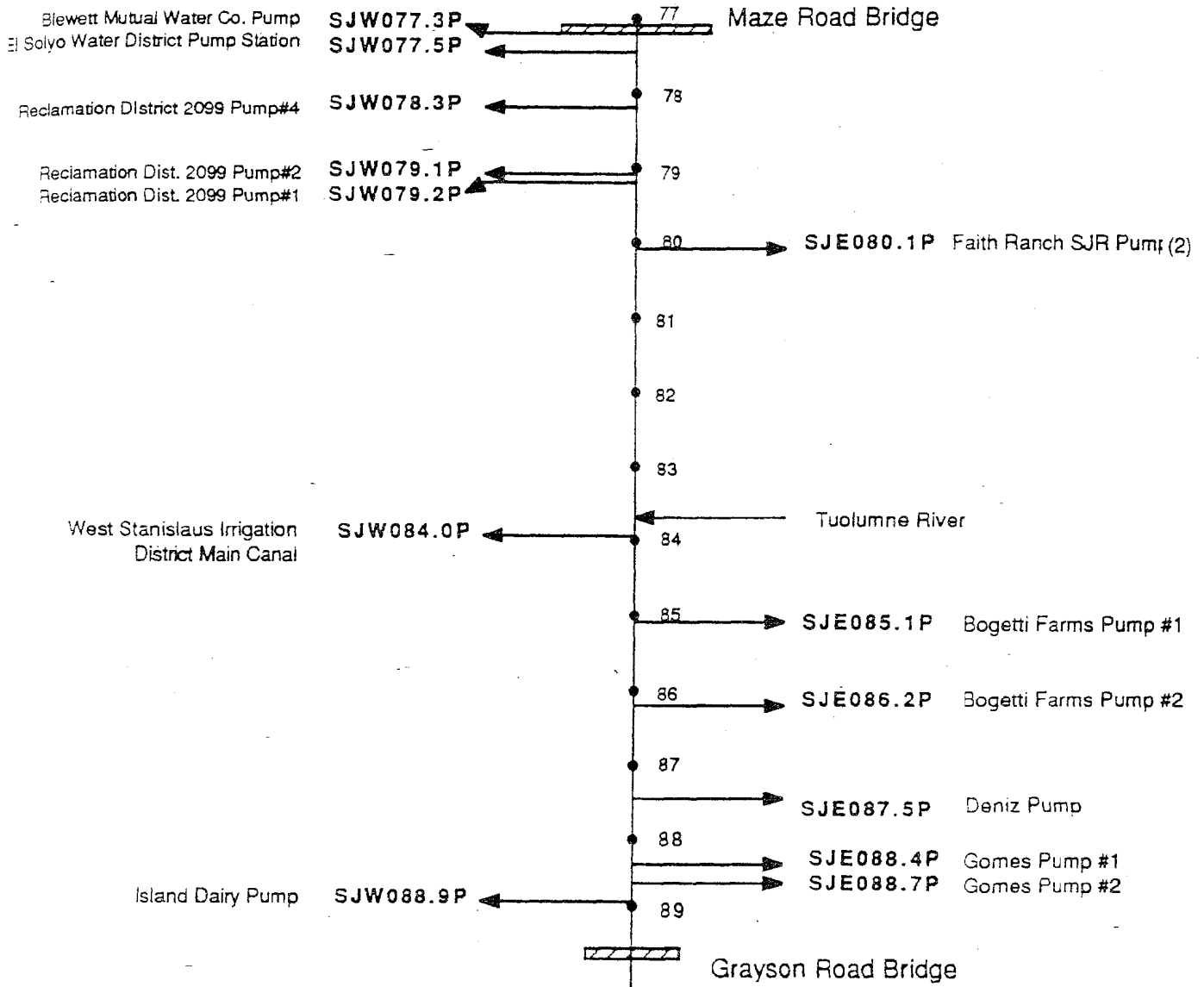

Figure B-6. Water Diversion Points Within River Section 16: Grayson Road Bridge to Maze Road Bridge (Hwy. 132).

SAN JOAQUIN RIVER

Section 17: Maze Road Bridge (Hwy.132) to Airport Way (Vernalis)

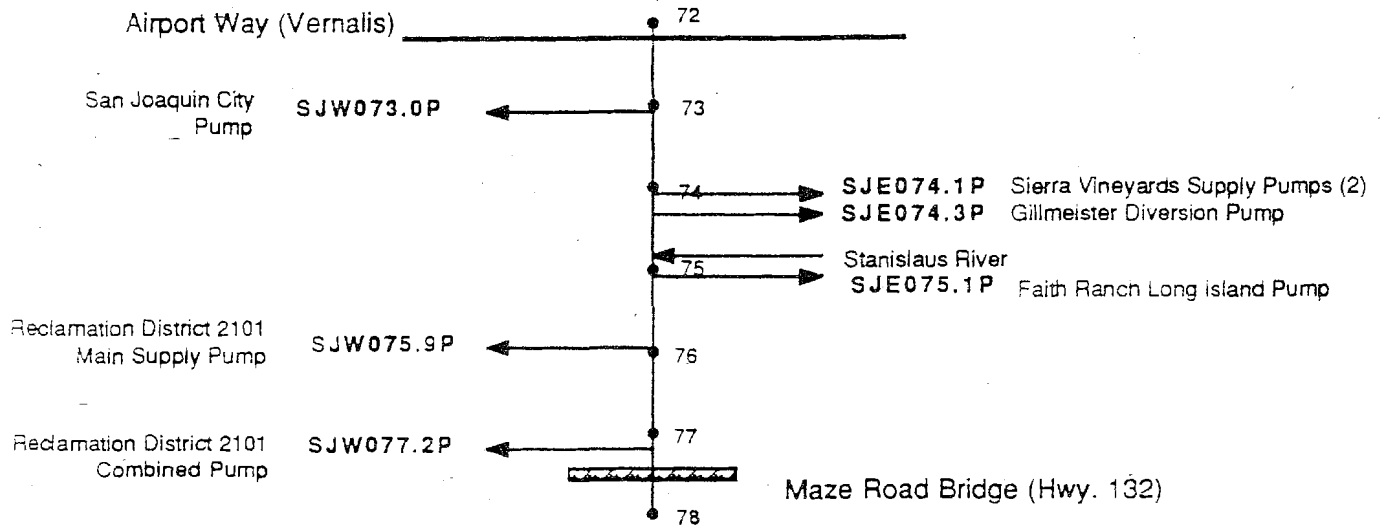

Figure B-7. Water Diversion Points Within River Section 17: Maze Road Bridge (Hwy. 132) to Airport Way (Vernalis).